

# SANMOTION

2-PHASE STEPPING SYSTEMS

# F2

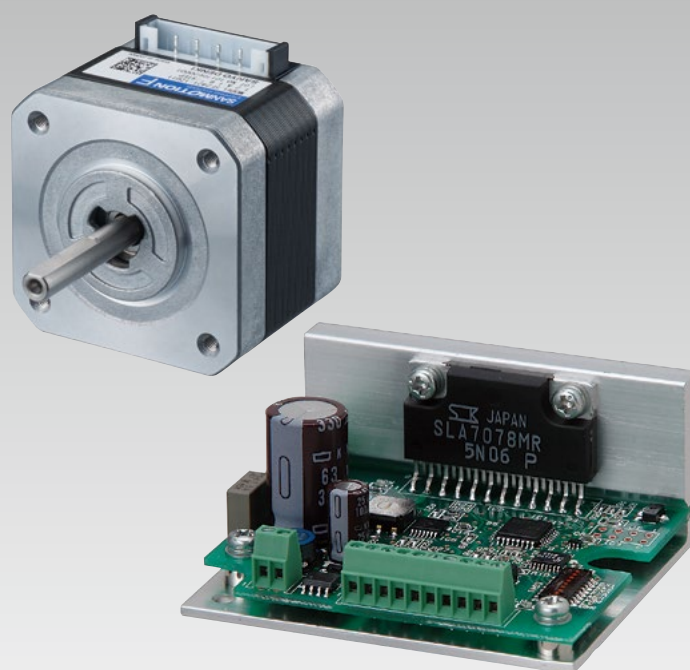

**SANYO DENKI**

**Ver.8**



# SANMOTION

2-PHASE STEPPING SYSTEMS

# F2



DC Input Set Models

---



DC Input Drivers

---



Stepping Motors

Stepping Motors, IP65 Splash and Dust Proof Stepping Motors,  
Stepping Motors for Vacuum Environments, Synchronous Motors

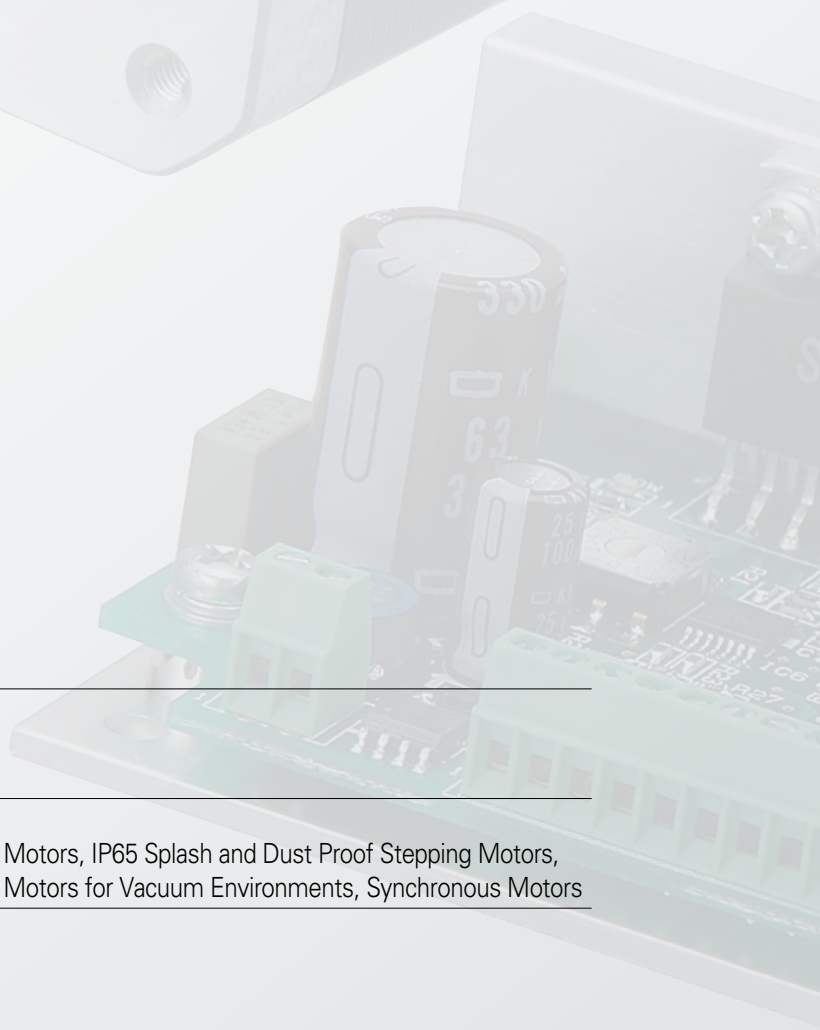

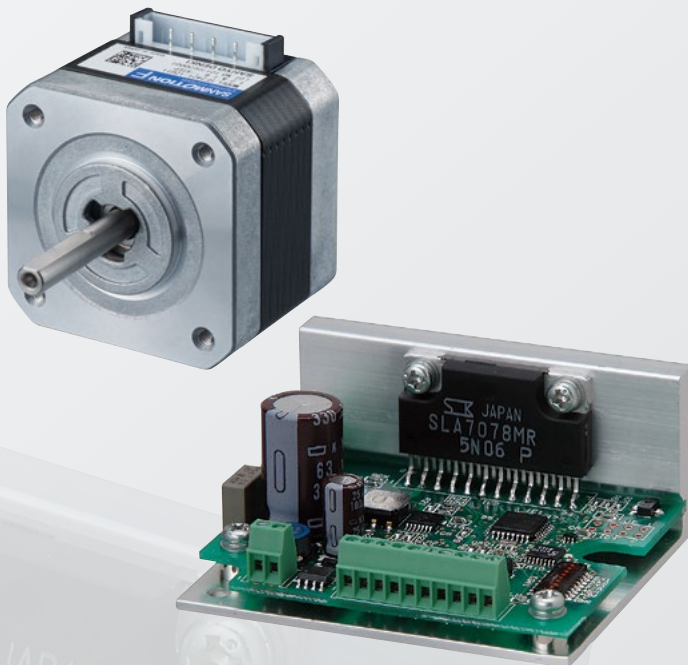

## Contents

Application Examples	p. 4
Lineup	p. 5
Lineup Details	p. 6

## Set Models

Features	p. 10
DC Input Set Models	p. 12
System Configuration Diagram	p. 12
Set Model Numbering Convention	p. 13
Set Model Configuration	p. 14
Unipolar Models Specifications	p. 15
Bipolar Models Specifications	p. 18
Stepping Motor: Dimensions	p. 23
Stepping Motor: General Specifications	p. 25
Driver Dimensions	p. 27
Driver Specifications	p. 28
Driver Controls and Connectors	p. 29
Connections and Signals	p. 30

## Stepping Motors

Lineup	p. 34
Stepping Motors	p. 38
IP65 Splash and Dust Proof Stepping Motors	p. 74
Stepping Motors for Vacuum Environments	p. 79
Synchronous Motors	p. 79
Safety Precautions	p. 80

The SANMOTION F2 is a 2-phase stepping system that provides precise positioning with easy control. The typical basic step angle is 1.8°, and accurate control is provided by pulse signals.

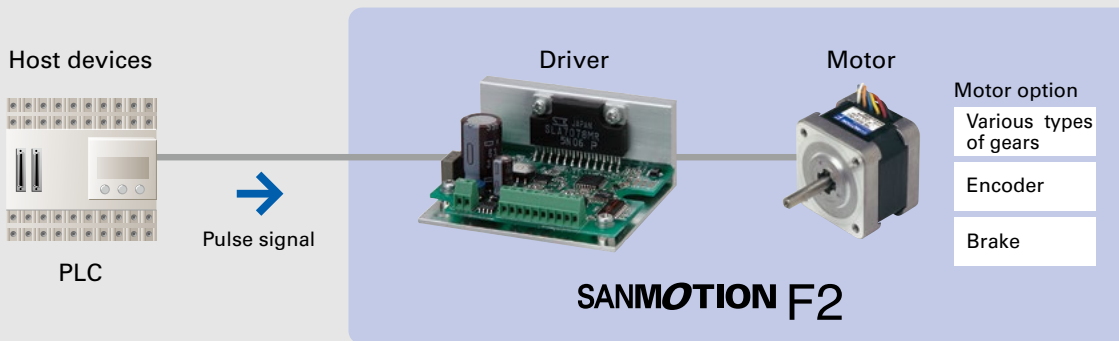

• **What is a stepping motor?**

A stepping motor is a motor that rotates at a fixed angle for each pulse. The rotation speed is proportional to the speed of the command pulse (frequency). Also, the rotation angle can be controlled according to the number of command pulses. Stepping motors are able to make stable stops without vibrating, as they have holding power when the motor is stopped.

• **Bipolar and unipolar drive**

The bipolar drive allows current to flow across both directions of the winding. The drive circuit is more complex, but it offers high torque. The unipolar drive allows current to flow across a single direction of the winding. The drive circuit is simpler than that of the bipolar drive.

## Application Examples

The SANMOTION F2 can be used in a wide variety of applications, including fixed-speed drive synchronized to a command pulse, accurate positioning, and stable stopping.

- Semiconductor devices, analytical and testing devices used in medical and environmental fields, ATMs, monitoring cameras and spotlights, packaging machines, embroidering machines, automatic ticket gates and more



ATMs



Blood analyzers



Wafer cleaners

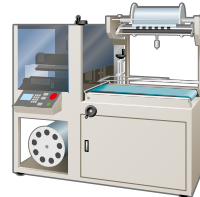

Food packaging machines

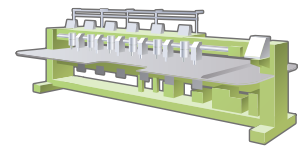

Embroidering machines

All model numbers in this catalog are compliant with the tolerances for specified toxic substances (cadmium, lead, mercury, hexavalent chromium, PBB, and PBDE) found in supplement II of the EU RoHS directive (2011/65/EU), as of the October 2012 production lot. SANMOTION F2 drivers also feature standard specifications that are compliant with CE (European Norm) and UL standards.



# Lineup

## Set Models ▶p. 9-

### DC input

#### Unipolar

These set models consist of a DC-powered driver and motor.  
The input voltage range is from 24 to 36 VDC, and the motor winding is unipolar.

**Motor size:**  
28 mm sq./42 mm sq./56 mm sq.



#### Bipolar

These set models consist of a DC-powered driver and motor.  
The input voltage range is from 24 to 36 VDC, and the motor winding is bipolar.

**Motor size:**  
28 mm sq./42 mm sq./50 mm sq./56 mm sq./60 mm sq.



## Stepping Motors ▶p. 33-

### Stepping Motors ▶p. 38-

High-torque stepping motors. Select from among a broad lineup of products from an ultra-compact 14 mm sq. motor size, to a thin 11.4 mm motor the shortest motor length.

Consult with us regarding customization. ▶p. 36  
A separate driver is required.

**Motor size:**  
14 mm sq./28 mm sq./35 mm sq./42 mm sq./  
50 mm sq./56 mm sq./60 mm sq./  
86 mm sq. (CE and UL models are available.)/  
ø106 mm



### IP65 Splash and Dust Proof Stepping Motors **Waterproof, dustproof** ▶p. 74-

These IP65 rated motors\* have superior water and dust resistance, and can be safely utilized in harsh or wet environments such as in food processing machines. The input voltage range of the motors is up to 250 VAC.

\*Except for the shaft and the cable end.  
A separate driver is required.

**Motor size:**  
56 mm sq./86 mm sq.



### Stepping Motors for Vacuum Environments **Customized Products** ▶p. 79

We can customize motors for use in low to ultra-high vacuum environments to suit your system requirements.

A separate driver is required.



### Synchronous Motors **Customized Products** ▶p. 79

Synchronous motors rotate at a constant speed in proportion to the AC power frequency. They operate on the commercial (AC) power supply.



# Lineup Details

**Set Models** ▶ p. 9-

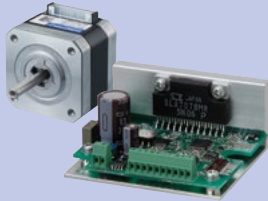
Series		DC input set models Unipolar	DC input set models Bipolar
			
Input source		24 to 36 VDC	24 to 36 VDC
Number of divisions		1, 2, 4, 8, 16	1, 2, 4, 8, 16
Step-angle	Motors with 1.8° basic step angle	1.8° to 0.1125°/pulse	1.8° to 0.1125°/pulse
	Motors with 0.9° basic step angle	0.9° to 0.05625°/pulse	0.9° to 0.05625°/pulse
Corresponding motor sizes		28 mm sq./42 mm sq./56 mm sq.	28 mm sq./42 mm sq./50 mm sq./56 mm sq./60 mm sq.
Set configuration items		Driver, Motor, Cable with connector (Supplied only with connector-type motors)	Driver, Motor, Cable with connector (Supplied only with connector-type motors)
Page	System Configuration Diagram	p. 12	p. 12
	Set Model Configuration	p. 14	p. 14
	Specifications/Characteristics Diagram	pp. 15 to 17	pp. 18 to 22
	Dimensions	pp. 23 to 24, 27	pp. 23 to 24, 27
	Motor Specifications	p. 25	p. 25
	Driver Specifications/Safety Standards	p. 28	p. 28

## Stepping Motors ▶p. 33–

### Stepping Motors ▶p. 38–

Basic step angle	Motor size	Holding torque (N·m)	Model no.	Page	
				Specifications/ Characteristics diagram	Dimensions
0.9°	42 mm sq.	0.2 to 0.48	SH142 □ - □□□ 1	pp. 42 to 43	pp. 42 to 43
0.9°	60 mm sq.	0.57 to 2.15	SH160 □ - □□□ 0	pp. 56 to 57	pp. 56 to 57
1.8°	14 mm sq. <b>Ultra-compact</b>	0.0065 to 0.01	SH214 □ -5 □□ 1	p. 38	p. 38
1.8°	28 mm sq.	0.055 to 0.145	SH228 □ -5 □□ 1	pp. 39 to 40	pp. 39 to 40
1.8°	35 mm sq.	0.12 to 0.23	SH35 □□ -12U □ 0	p. 41	p. 41
1.8°	42 mm sq. <b>Slim form</b>	0.083 to 0.186	SS242 □ -50 □ 1	p. 44	p. 44
1.8°	42 mm sq.	0.22 to 0.8	SF242 □ - □□□□ 1	pp. 45 to 46	pp. 45, 47
1.8°	50 mm sq.	0.28 to 0.53	103H670 □ - □□□ 0	pp. 48 to 50	pp. 49 to 50
1.8°	50 mm sq. <b>Slim form</b>	0.1 to 0.215	SS250 □ -80 □ 0	p. 51	p. 51
1.8°	56 mm sq.	0.39 to 2.0	103H712 □ - □□□ 0	pp. 52 to 55	pp. 53, 55
1.8°	60 mm sq.	0.78 to 2.7	103H782 □ - □□□ 0	pp. 58 to 61	pp. 59, 61
1.8°	86 mm sq. (CE and UL models are available.)	2.5 to 9	SH286 □ - □□□ 1 SM286 □ - □□□□	pp. 62, 64 to 65	pp. 63, 66
1.8°	∅106 mm	10.8 to 19	103H8922 □ - □□□ 1	p. 67	p. 67
1.8°	56 mm sq. (CE Model)	0.39 to 1.27	103H712 □ -6 □□ 0	p. 68	p. 68
1.8°	∅86 mm (CE Model)	2.74 to 7.44	103H822 □ -6 □□ 0	p. 69	p. 69
1.8°	∅106 mm (CE Model)	13.2 to 19	103H8922 □ -63 □ 1	p. 70	p. 70

• Contact us for available encoders, gears and motors with brakes.

### IP65 Splash and Dust Proof Stepping Motors **Waterproof, dustproof** ▶p. 74–

Basic step angle	Motor size	Holding torque (N·m)	Safety standards	Model no.	Page	
					Specifications/ Characteristics diagram	Dimensions
1.8°	56 mm sq.	1 to 1.7	CE/UL Model	SP256 □ -5 □□ 0	p. 75	p. 76
1.8°	86 mm sq.	3.3 to 9	CE/UL Model	SP286 □ -5 □□ 0	pp. 77 to 78	p. 78

### Stepping Motors for Vacuum Environments **Customized Products** ▶p. 79

We can customize motors for use in low to ultra-high vacuum environments to suit your system requirements. The motors can handle a wide range of vacuum conditions, including low vacuum, high vacuum, and ultra-high vacuum.

### Synchronous Motors **Customized Products** ▶p. 79

Synchronous motors rotate at a constant speed in proportion to the AC power frequency. The motor can be directly driven using the AC power supply, so a driver is unnecessary.





# Set Models

DC Input Set Models

▶ p. 12

---

## Features

### Low vibration

SANMOTION F2 stepping drivers can smoothly operate stepping motors even at low resolution settings such as 1-division (full step) and 2-division (half step) thanks to its low-vibration mode. Vibrations can be suppressed regardless of the host controller.

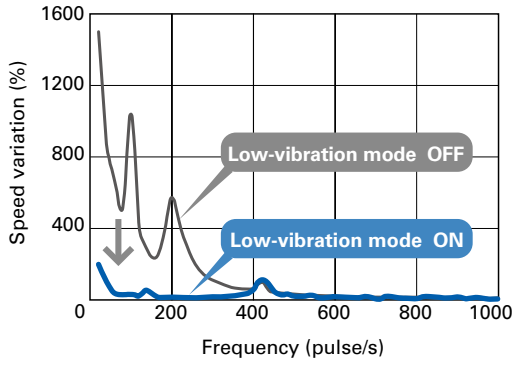

### Micro-step drive

A resolution setting up to 16 divisions of the basic step angle 1.8° can be used, enabling smooth equipment operation with low vibration.

# How to Read the Specifications

## 1 Unipolar DC input driver (Model no.: US1D200P10) + Motor

RoHS

		28 mm sq./Basic step angle 1.8°		42 mm sq./Basic step angle 1.8°		
2	Motor size					
	Motor length	32 mm	51.5 mm	33 mm	39 mm	
3	Single shaft	DU14S281S	DU14S285S	DU15S421S	DU15S422S	
	Configuration item: motor model no.	SH2281-5271	SH2285-5271	SF2421-12U41	SF2422-12U41	
3	Dual shaft	DU14S281D	DU14S285D	DU15S421D	DU15S422D	
	Configuration item: motor model no.	SH2281-5231	SH2285-5231	SF2421-12U11	SF2422-12U11	
4	Holding torque	N·m	0.055	0.115	0.22	0.33
5	Rotor inertia	×10 <sup>-4</sup> kg·m <sup>2</sup>	0.01	0.022	0.031	0.046
6	Rated current	A/phase	1	1	1.2	1.2
7	Motor mass *1	kg	0.11	0.2	0.23	0.3
8	Allowable thrust load	N	3	3	10	10
9	Allowable radial load *2	N	42	49	39	37

\*1 Driver mass ▶ p. 28 \*2 The load point is at the tip of the output shaft.

## 10 Characteristics diagram

With rubber coupling

DU14S281S  
DU14S281D

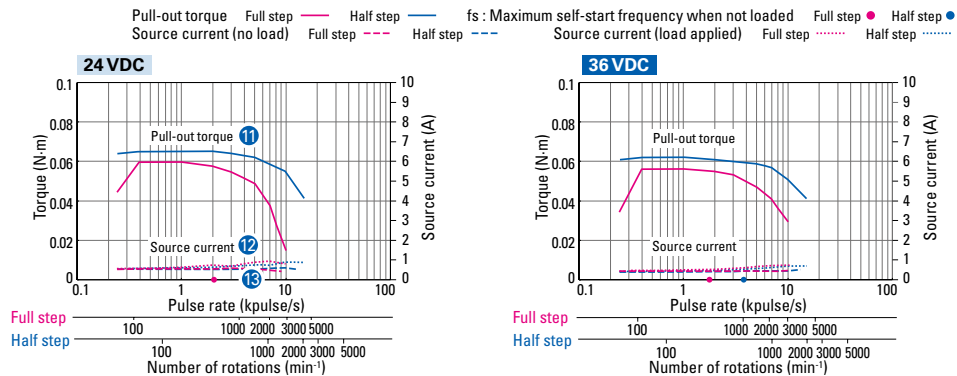

- Model number of the driver included in the set.
- Size and length of the stepping motor included in the set. When driving in full step mode, the basic step angle is the rotation angle with each pulse. When driving in half step mode, the motor rotates at half of the basic step angle.
- The set model number and the model number of the stepping motor included in the set. The model number for the stepping motor shaft varies for single shaft and dual shaft.
- This is the maximum torque that occurs when using 2-phase excitation at rated current, causing the shaft to rotate from the outside.
- This is the moment of inertia of the rotor.
- This is the rated current that flows to the motor winding.
- This is the mass of the stepping motor.
- This is the allowable load when applying a load to the shaft in the axial direction. Do not exceed this value when using this product.
- This is the allowable load when applying a load to the shaft perpendicular to the axial direction. Do not exceed this value when using this product.
- This graph shows the relationship between the pulse rate (frequency), speed, and torque. The driver source current is shown in addition to the torque. Full step is shown in red, and half step is shown in blue.
- The pull-out torque is the maximum torque in which synchronized operation is possible for a certain command pulse. If a torque that exceeds this value is applied to the stepping motor, it will be unable to synchronize with the command pulse. Thus, when

selecting a motor, you should allow for a torque margin of 1.4 to 2 times, in order to avoid step-out.

- This graph shows the current value for the power supply that supplies the driver.

The red and blue dashed lines show the source current value when there is no load (motor by itself).

The red and blue dotted lines show the source current value when the maximum torque is applied to the stepping motor (during load).

The required power supply capacity (W) is calculated from this graph.

- The red- and blue-colored dots in the lower part of the graph show the upper limit for the self-start frequency (maximum self-start frequency:  $f_s$ ) of the stepping motor by itself (no load). Full step is shown in red, and half step is shown in blue. The stepping motor will not operate normally if it is started using frequencies that exceed these values. For this reason, it is necessary to start the stepping motor using frequencies that are lower than these values. The maximum self-start frequency ( $f_L$ ) which includes the load can be determined using the relational expression below.

$$f_L = \frac{f_s}{\sqrt{1 + \frac{J_L}{J_M}}}$$

$J_M$ : Rotor inertia

$J_L$ : Load inertia

$f_s$ : Maximum self-start frequency when not loaded

# DC Input Set Models

## Unipolar, Bipolar

Set Model Configuration ▶ p. 14  
 Specifications/Characteristics Diagram ▶ pp. 15 to 22  
 Motor Dimensions ▶ pp. 23 to 24 Motor Specifications ▶ p. 25  
 Driver Dimensions ▶ p. 27 Driver Specifications ▶ p. 28

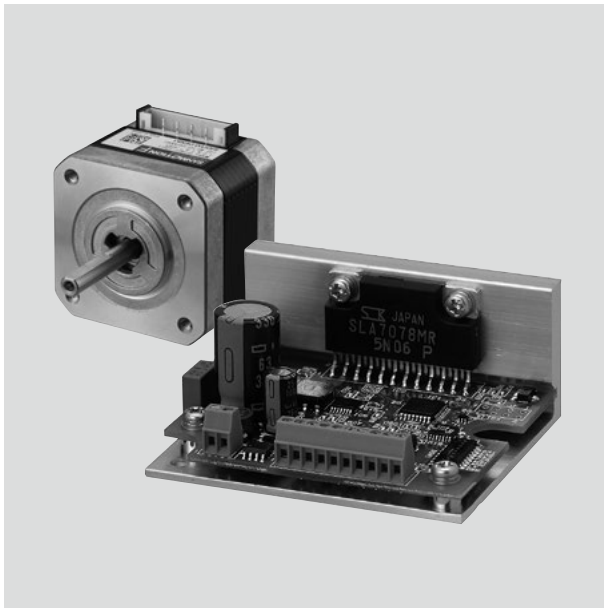

### Set configuration items RoHS

**Driver** Terminal block type CE c UL US RoHS

Unipolar Model no.: US1D200P10 Input source: 24/36 VDC

Bipolar Model no.: BS1D200P10 Input source: 24/36 VDC

- The operation manual can be downloaded from our website.
  - Drivers are available for separate purchase.
- Connector-type drivers are also available. Contact us for details.

### Motor

Unipolar Motor size: 28 mm sq., 42 mm sq., 56 mm sq.

Bipolar Motor size: 28 mm sq., 42 mm sq., 50 mm sq.,  
56 mm sq., 60 mm sq.

### Cable with connector

Supplied only with connector-type motors

## System Configuration Diagram

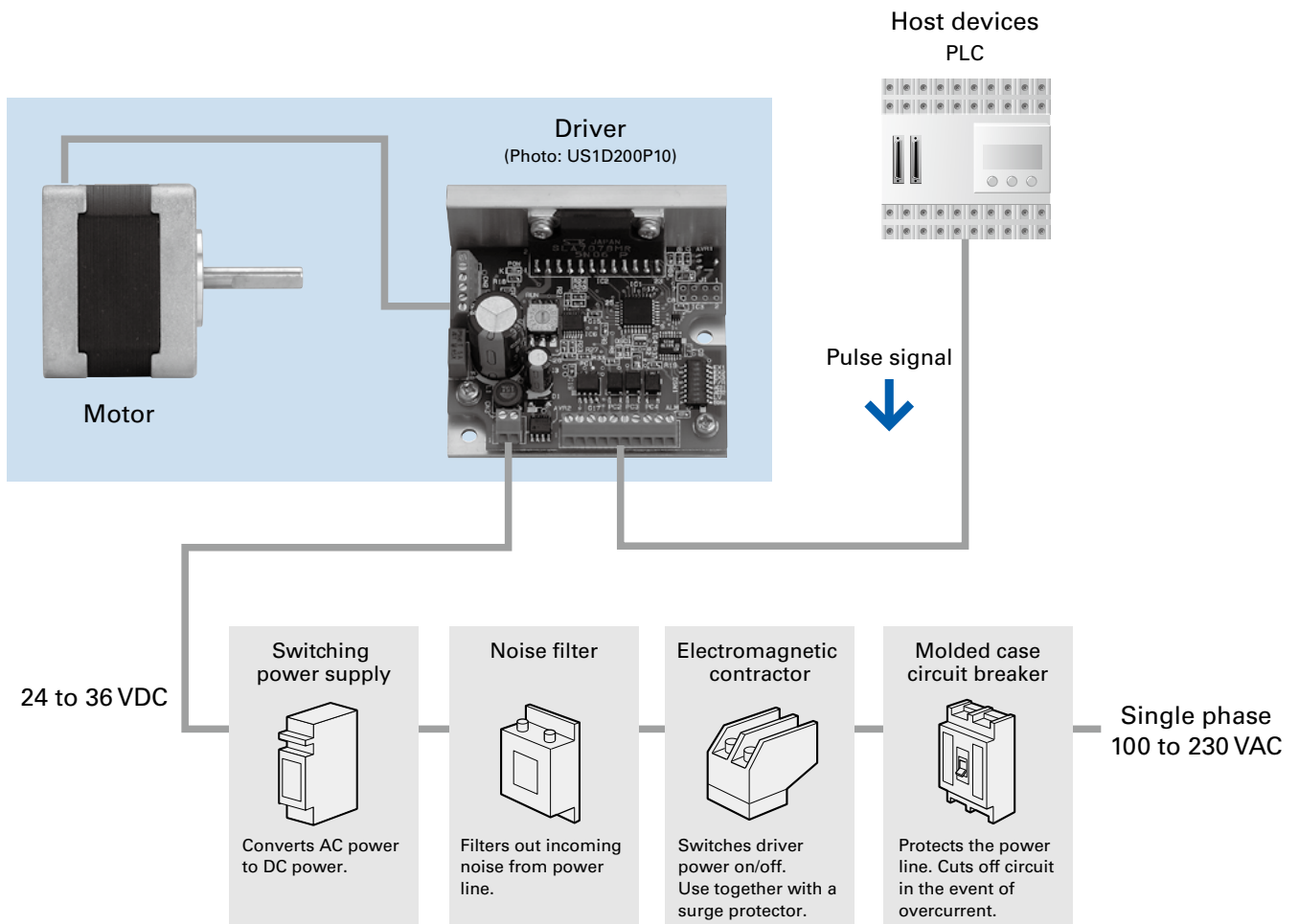

# Set Model Numbering Convention

Not every combination of the following codes or characters is available. Check the set model component details on the p. 14 for the model number combinations, or contact us.

Example: This is a set model number for the DC input driver (Model no. US1D200P10) and motor (Model no. 103H7121-0440).  
The motor specifications are motor size: 56 mm sq., motor length: 41.8 mm, single shaft.

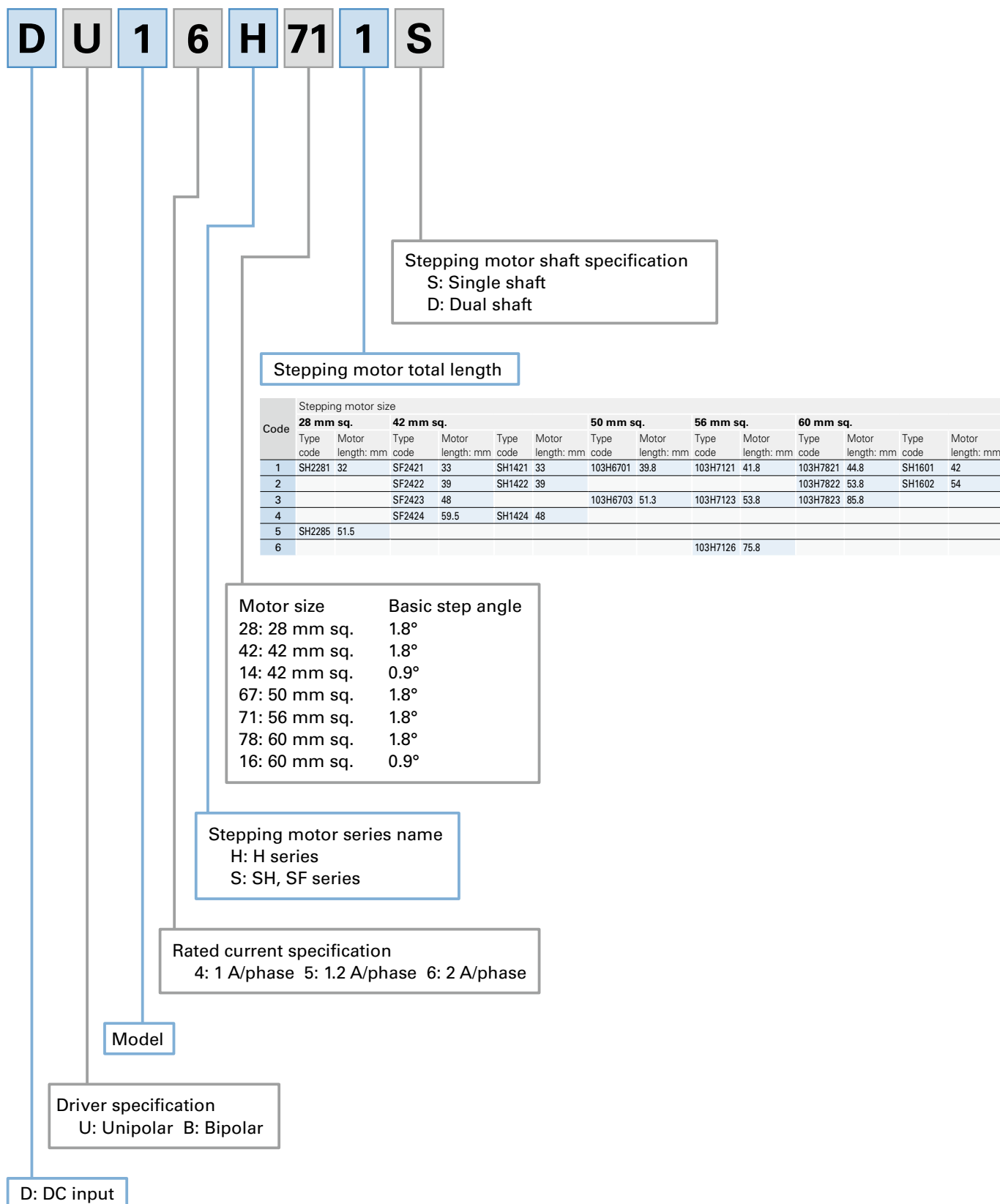

# Set Model Configuration This set includes the driver, motor and cable with motor connector.

## Unipolar Bundled driver model no.: US1D200P10

Motor size	Single shaft			Dual shaft			Basic step angle	Rated current (A/phase)	Page	
	Set model no.	Set configuration items		Set model no.	Set configuration items				Specifications	Dimensions
		Motor model no.	Cable with motor connector model no.		Motor model no.	Cable with motor connector model no.				
28 mm sq.	DU14S281S	SH2281-5271	L —	DU14S281D	SH2281-5231	L —	1.8°	1	p. 15	p. 23
	DU14S285S	SH2285-5271	L —	DU14S285D	SH2285-5231	L —	1.8°	1	p. 15	p. 23
42 mm sq.	DU15S421S	SF2421-12U41	C 4835774-1	DU15S421D	SF2421-12U11	C 4835774-1	1.8°	1.2	p. 15	p. 23
	DU15S422S	SF2422-12U41	C 4835774-1	DU15S422D	SF2422-12U11	C 4835774-1	1.8°	1.2	p. 15	p. 23
	DU15S423S	SF2423-12U41	C 4835774-1	DU15S423D	SF2423-12U11	C 4835774-1	1.8°	1.2	p. 16	p. 23
	DU15S424S	SF2424-12U41	C 4835774-1	DU15S424D	SF2424-12U11	C 4835774-1	1.8°	1.2	p. 16	p. 23
	DU15S141S	SH1421-0441	L —	DU15S141D	SH1421-0411	L —	0.9°	1.2	p. 16	p. 23
	DU15S142S	SH1422-0441	L —	DU15S142D	SH1422-0411	L —	0.9°	1.2	p. 16	p. 23
	DU15S144S	SH1424-0441	L —	DU15S144D	SH1424-0411	L —	0.9°	1.2	p. 17	p. 23
56 mm sq.	DU16H711S	103H7121-0440	L —	DU16H711D	103H7121-0410	L —	1.8°	2	p. 17	p. 24
	DU16H713S	103H7123-0440	L —	DU16H713D	103H7123-0410	L —	1.8°	2	p. 17	p. 24
	DU16H716S	103H7126-0440	L —	DU16H716D	103H7126-0410	L —	1.8°	2	p. 17	p. 24

Motors marked with an (L) are lead wire types. Either a 300 mm or a 305 mm or greater lead wire is attached to the motor.  
Motors marked with a (C) are connector types. Cables with connectors for motors as shown below are included.

● Cable with motor connector (Supplied only with connector-type motors)

**Bundled cable (Unipolar 42 mm sq. motors only, model no.: 4835774-1)**

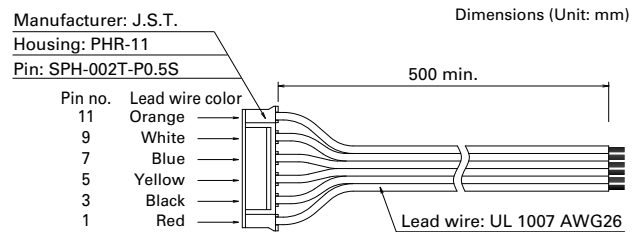

## Bipolar Bundled driver model no.: BS1D200P10

Motor size	Single shaft			Dual shaft			Basic step angle	Rated current (A/phase)	Page	
	Set model no.	Set configuration items		Set model no.	Set configuration items				Specifications	Dimensions
		Motor model no.	Cable with motor connector model no.		Motor model no.	Cable with motor connector model no.				
28 mm sq.	DB14S281S	SH2281-5771	L —	DB14S281D	SH2281-5731	L —	1.8°	1	p. 18	p. 23
	DB14S285S	SH2285-5771	L —	DB14S285D	SH2285-5731	L —	1.8°	1	p. 18	p. 23
42 mm sq.	DB14S421S	SF2421-10B41	C 4835775-1	DB14S421D	SF2421-10B11	C 4835775-1	1.8°	1	p. 18	p. 23
	DB14S422S	SF2422-10B41	C 4835775-1	DB14S422D	SF2422-10B11	C 4835775-1	1.8°	1	p. 18	p. 23
	DB14S423S	SF2423-10B41	C 4835775-1	DB14S423D	SF2423-10B11	C 4835775-1	1.8°	1	p. 19	p. 23
	DB14S424S	SF2424-10B41	C 4835775-1	DB14S424D	SF2424-10B11	C 4835775-1	1.8°	1	p. 19	p. 23
	DB16S141S	SH1421-5241	L —	DB16S141D	SH1421-5211	L —	0.9°	2	p. 19	p. 23
	DB16S142S	SH1422-5241	L —	DB16S142D	SH1422-5211	L —	0.9°	2	p. 19	p. 23
	DB16S144S	SH1424-5241	L —	DB16S144D	SH1424-5211	L —	0.9°	2	p. 20	p. 23
50 mm sq.	DB16H671S	103H6701-5040	L —	DB16H671D	103H6701-5010	L —	1.8°	2	p. 20	p. 24
	DB16H673S	103H6703-5040	L —	DB16H673D	103H6703-5010	L —	1.8°	2	p. 20	p. 24
56 mm sq.	DB16H711S	103H7121-5740	L —	DB16H711D	103H7121-5710	L —	1.8°	2	p. 20	p. 24
	DB16H713S	103H7123-5740	L —	DB16H713D	103H7123-5710	L —	1.8°	2	p. 21	p. 24
	DB16H716S	103H7126-5740	L —	DB16H716D	103H7126-5710	L —	1.8°	2	p. 21	p. 24
60 mm sq.	DB16H781S	103H7821-5740	C 4837961-1	DB16H781D	103H7821-5710	C 4837961-1	1.8°	2	p. 21	p. 24
	DB16H782S	103H7822-5740	C 4837961-1	DB16H782D	103H7822-5710	C 4837961-1	1.8°	2	p. 21	p. 24
	DB16H783S	103H7823-5740	C 4837961-1	DB16H783D	103H7823-5710	C 4837961-1	1.8°	2	p. 22	p. 24
	DB16S161S	SH1601-5240	L —	DB16S161D	SH1601-5210	L —	0.9°	2	p. 22	p. 24
	DB16S162S	SH1602-5240	L —	DB16S162D	SH1602-5210	L —	0.9°	2	p. 22	p. 24

Motors marked with an (L) are lead wire types. Either a 300 mm or a 305 mm or greater lead wire is attached to the motor.  
Motors marked with a (C) are connector types. Cables with connectors for motors as shown below are included.

● Cable with motor connector (Supplied only with connector-type motors)

**Bundled cable (Bipolar 42 mm sq. motors only, model no.: 4835775-1)**

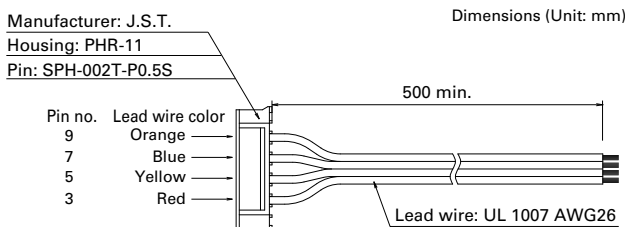

**Bundled cable (Bipolar 60 mm sq. motors only, model no.: 4837961-1)**

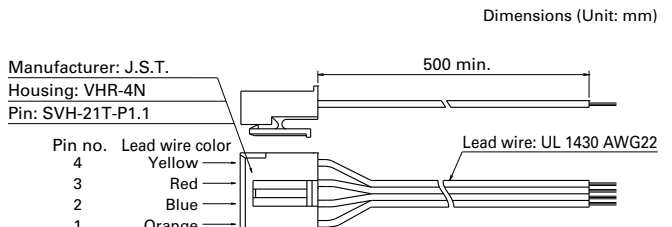

Size	Motor size Motor length	28 mm sq./Basic step angle 1.8°		42 mm sq./Basic step angle 1.8°		
		32 mm	51.5 mm	33 mm	39 mm	
Single shaft	Set model no.	DU14S281S	DU14S285S	DU15S421S	DU15S422S	
	Configuration item: motor model no.	SH2281-5271	SH2285-5271	SF2421-12U41	SF2422-12U41	
Dual shaft	Set model no.	DU14S281D	DU14S285D	DU15S421D	DU15S422D	
	Configuration item: motor model no.	SH2281-5231	SH2285-5231	SF2421-12U11	SF2422-12U11	
Holding torque		N·m	0.055	0.115	0.22	0.33
Rotor inertia		$\times 10^{-4} \text{kg}\cdot\text{m}^2$	0.01	0.022	0.031	0.046
Rated current		A/phase	1	1	1.2	1.2
Motor mass *1		kg	0.11	0.2	0.23	0.3
Allowable thrust load		N	3	3	10	10
Allowable radial load *2		N	42	49	39	37

\*1 Driver mass ▶ p. 28 \*2 The load point is at the tip of the output shaft.

### Characteristics diagram

With rubber coupling

Pull-out torque Full step — Half step — fs : Maximum self-start frequency when not loaded Full step ● Half step ●  
 Source current (no load) Full step - - - Half step - - - Source current (load applied) Full step ····· Half step ·····

#### DU14S281S DU14S281D

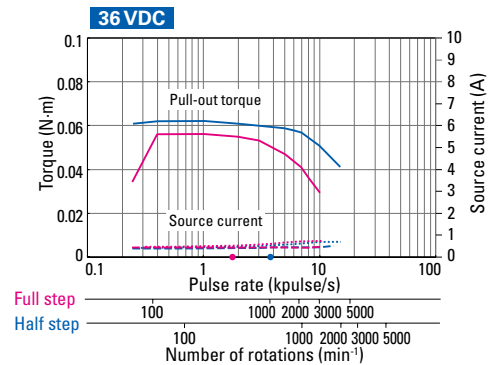
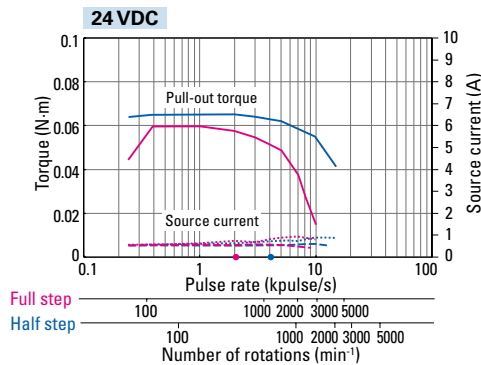

#### DU14S285S DU14S285D

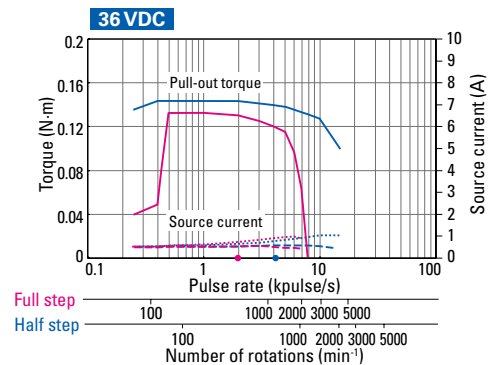
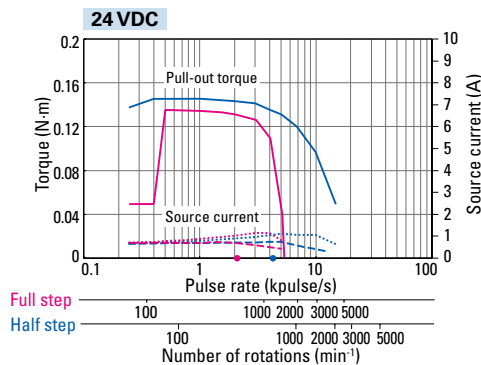

#### DU15S421S DU15S421D

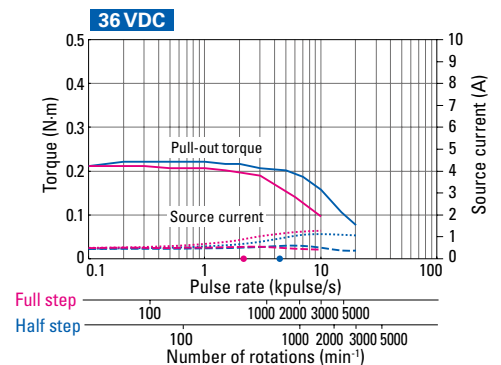
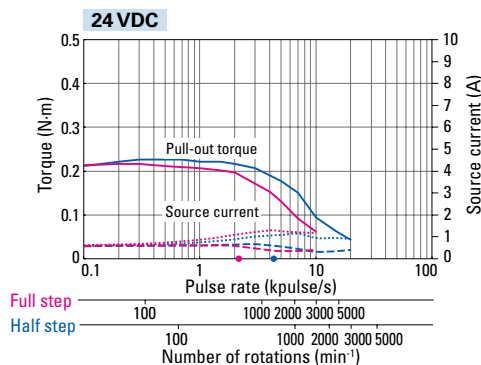

#### DU15S422S DU15S422D

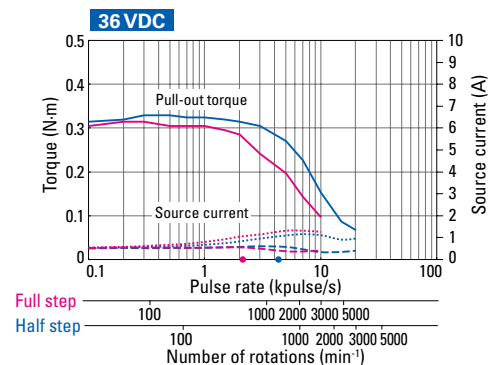
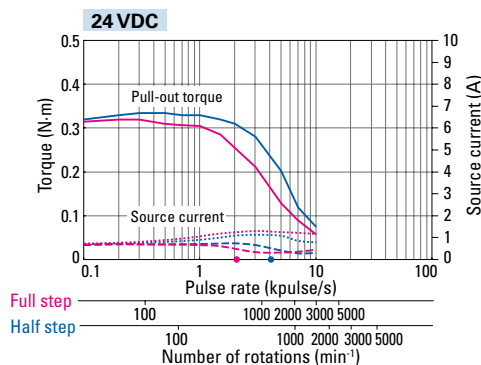

Size	Motor size	42 mm sq./Basic step angle 1.8°		42 mm sq./Basic step angle 0.9°	
	Motor length	48 mm	59.5 mm	33 mm	39 mm
Single shaft	Set model no.	DU15S423S	DU15S424S	DU15S141S	DU15S142S
	Configuration item: motor model no.	SF2423-12U41	SF2424-12U41	SH1421-0441	SH1422-0441
Dual shaft	Set model no.	DU15S423D	DU15S424D	DU15S141D	DU15S142D
	Configuration item: motor model no.	SF2423-12U11	SF2424-12U11	SH1421-0411	SH1422-0411
Holding torque	N·m	0.4	0.58	0.2	0.29
Rotor inertia	$\times 10^{-4}$ kg·m <sup>2</sup>	0.063	0.094	0.044	0.066
Rated current	A/phase	1.2	1.2	1.2	1.2
Motor mass *1	kg	0.38	0.51	0.24	0.29
Allowable thrust load	N	10	10	10	10
Allowable radial load *2	N	35	29	25	24

\*1 Driver mass ▶ p. 28 \*2 The load point is at the tip of the output shaft.

### Characteristics diagram

With rubber coupling

Pull-out torque Source current (no load) Full step Half step fs : Maximum self-start frequency when not loaded Full step Half step Source current (load applied) Full step Half step

#### DU15S423S DU15S423D

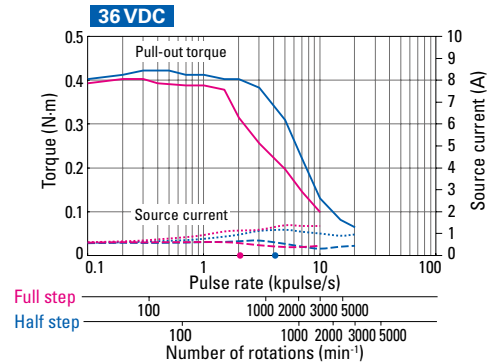
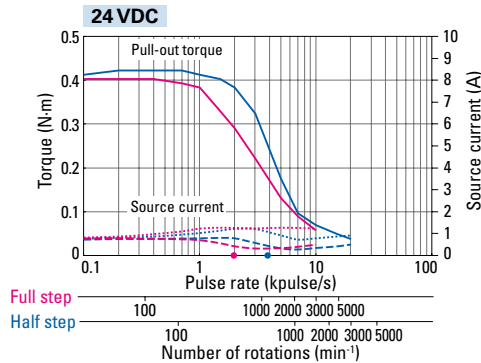

#### DU15S424S DU15S424D

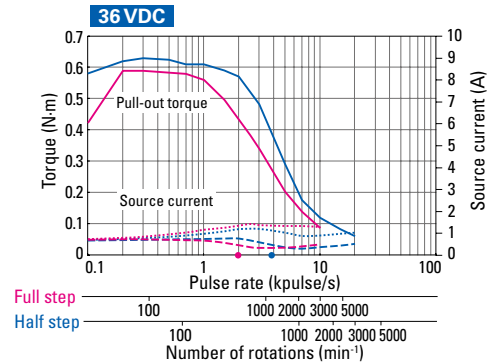
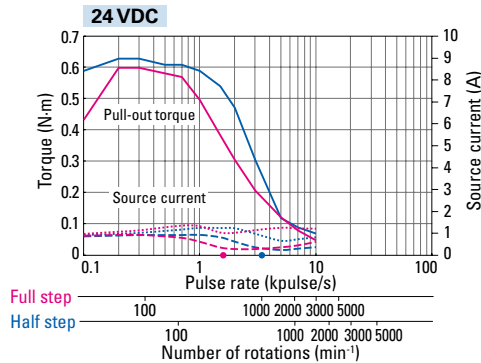

#### DU15S141S DU15S141D

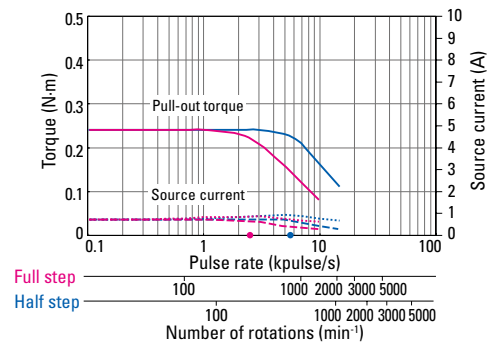
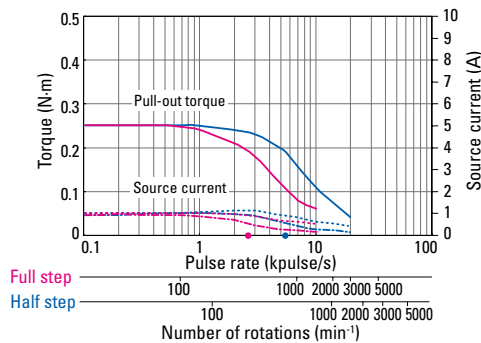

#### DU15S142S DU15S142D

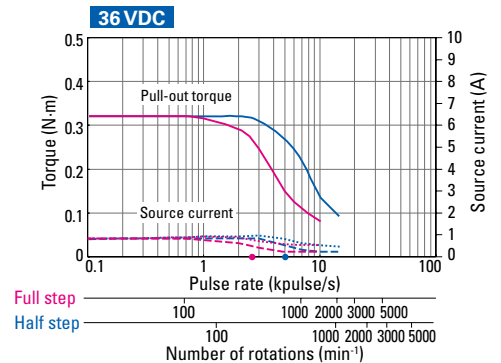
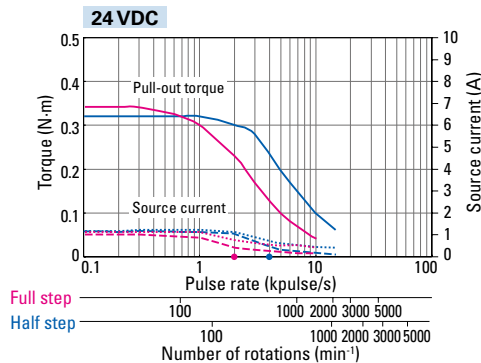



Size	Motor size	42 mm sq./Basic step angle 0.9°		56 mm sq./Basic step angle 1.8°		
	Motor length	48 mm	41.8 mm	53.8 mm	75.8 mm	
Single shaft	Set model no.	DU15S144S	DU16H711S	DU16H713S	DU16H716S	
	Configuration item: motor model no.	SH1424-0441	103H7121-0440	103H7123-0440	103H7126-0440	
Dual shaft	Set model no.	DU15S144D	DU16H711D	DU16H713D	DU16H716D	
	Configuration item: motor model no.	SH1424-0411	103H7121-0410	103H7123-0410	103H7126-0410	
Holding torque	N·m	0.39	0.39	0.83	1.27	
Rotor inertia	$\times 10^{-4}$ kg·m <sup>2</sup>	0.089	0.1	0.21	0.36	
Rated current	A/phase	1.2	2	2	2	
Motor mass *1	kg	0.38	0.47	0.65	0.98	
Allowable thrust load	N	10	15	15	15	
Allowable radial load *2	N	20	78	71	62	

\*1 Driver mass ▶ p. 28 \*2 The load point is at the tip of the output shaft.

Characteristics diagram

With rubber coupling

Pull-out torque Source current (no load) Full step Half step fs: Maximum self-start frequency when not loaded Full step Half step Source current (load applied) Full step Half step

DU15S144S  
DU15S144D

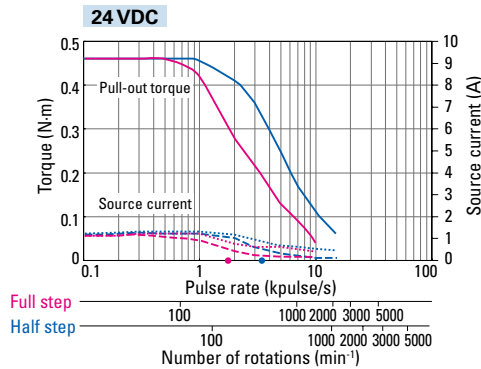

36 VDC

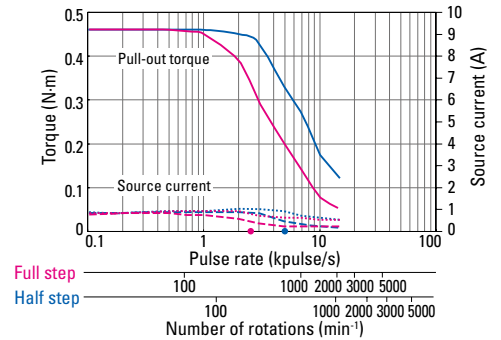

DU16H711S  
DU16H711D

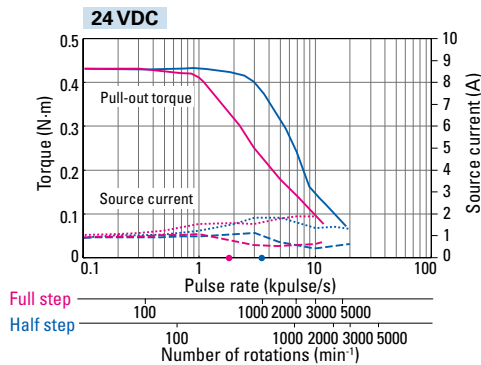

36 VDC

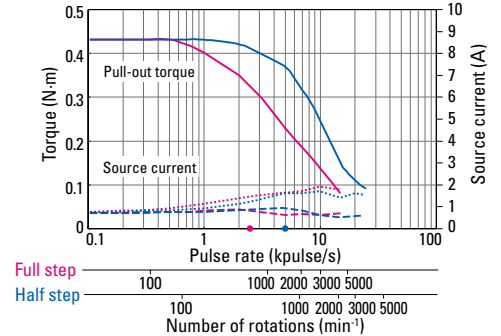

DU16H713S  
DU16H713D

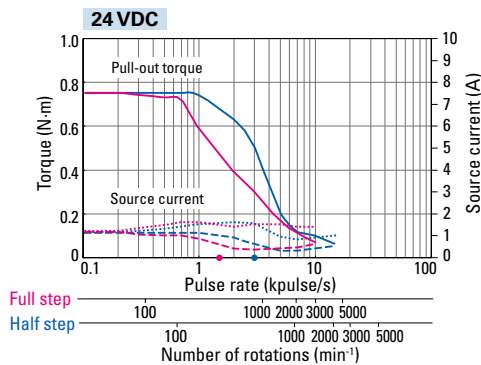

36 VDC

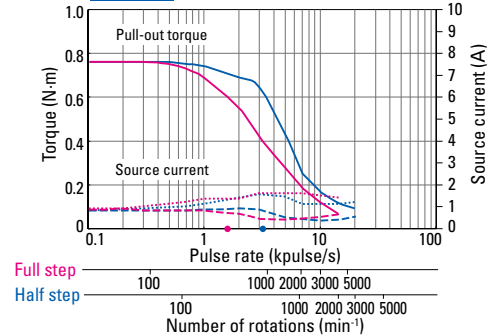

DU16H716S  
DU16H716D

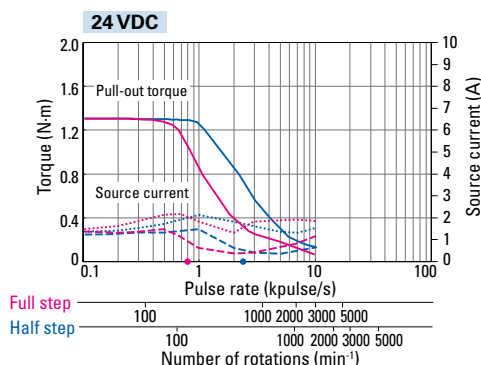

36 VDC

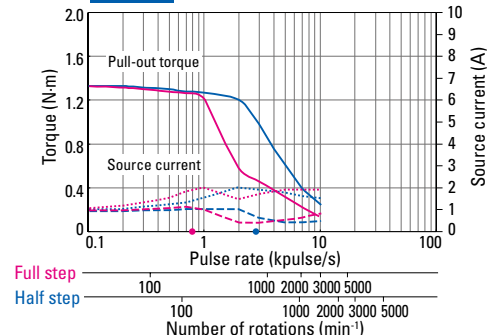

Size	Motor size	28 mm sq./Basic step angle 1.8°		42 mm sq./Basic step angle 1.8°		
	Motor length	32 mm	51.5 mm	33 mm	39 mm	
Single shaft	Set model no.	DB14S281S	DB14S285S	DB14S421S	DB14S422S	
	Configuration item: motor model no.	SH2281-5771	SH2285-5771	SF2421-10B41	SF2422-10B41	
Dual shaft	Set model no.	DB14S281D	DB14S285D	DB14S421D	DB14S422D	
	Configuration item: motor model no.	SH2281-5731	SH2285-5731	SF2421-10B11	SF2422-10B11	
Holding torque		N·m	0.07	0.145	0.29	0.43
Rotor inertia		$\times 10^{-4}$ kg·m <sup>2</sup>	0.01	0.022	0.031	0.046
Rated current		A/phase	1	1	1	1
Motor mass *1		kg	0.11	0.2	0.23	0.3
Allowable thrust load		N	3	3	10	10
Allowable radial load *2		N	42	49	38	34

\*1 Driver mass ▶ p. 28 \*2 The load point is at the tip of the output shaft.

### Characteristics diagram

With rubber coupling

— Pull-out torque    — Full step Source current (no load)    — Half step    ● fs : Maximum self-start frequency when not loaded    ● Full step    ● Half step  
- - - Full step Source current (load applied)    - - - Half step    - - - Full step    - - - Half step

#### DB14S281S DB14S281D

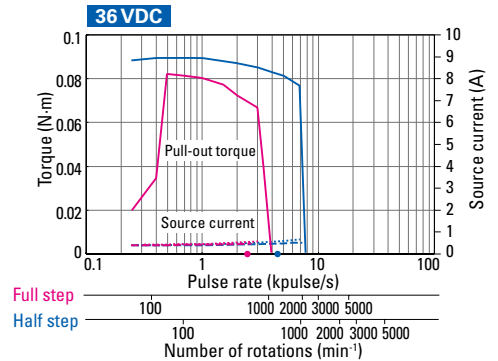
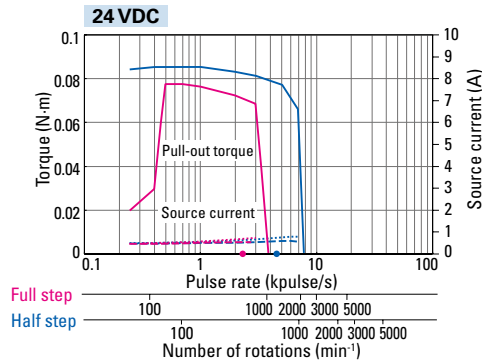

#### DB14S285S DB14S285D

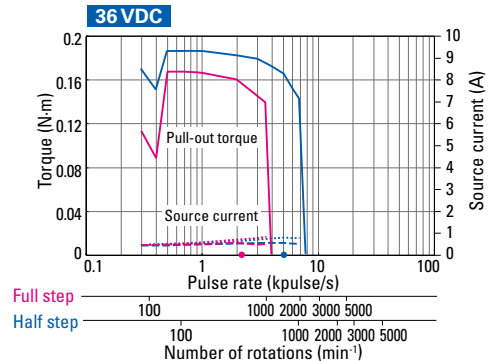
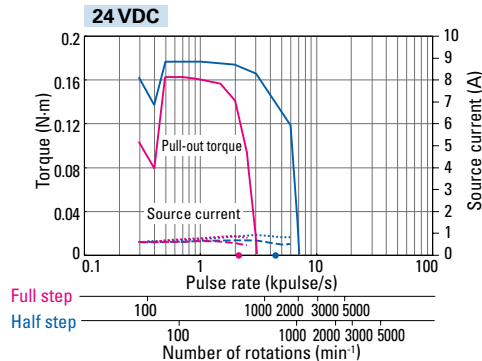

#### DB14S421S DB14S421D

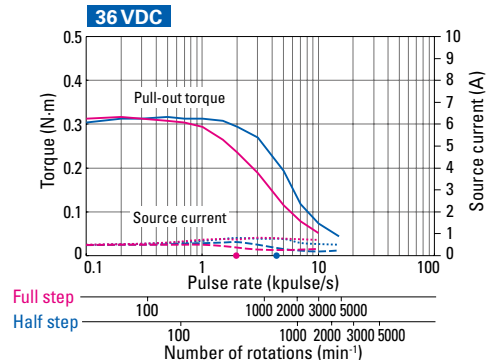
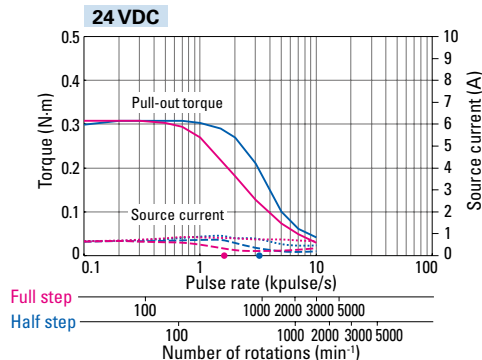

#### DB14S422S DB14S422D

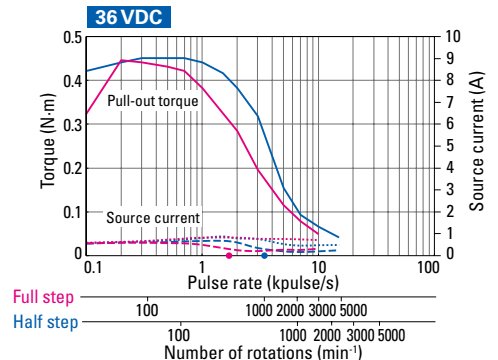
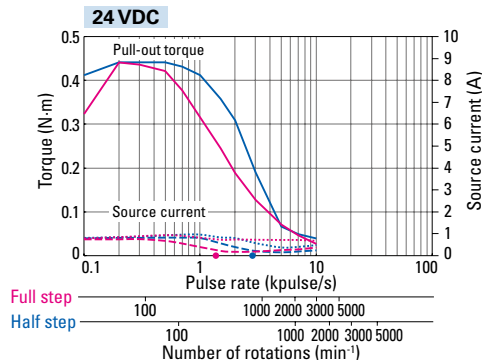

Size	Motor size	42 mm sq./Basic step angle 1.8°		42 mm sq./Basic step angle 0.9°	
		48 mm	59.5 mm	33 mm	39 mm
Single shaft	Set model no.	DB14S423S	DB14S424S	DB16S141S	DB16S142S
	Configuration item: motor model no.	SF2423-10B41	SF2424-10B41	SH1421-5241	SH1422-5241
Dual shaft	Set model no.	DB14S423D	DB14S424D	DB16S141D	DB16S142D
	Configuration item: motor model no.	SF2423-10B11	SF2424-10B11	SH1421-5211	SH1422-5211
Holding torque	N·m	0.56	0.8	0.23	0.34
Rotor inertia	$\times 10^{-4}$ kg·m <sup>2</sup>	0.063	0.094	0.044	0.066
Rated current	A/phase	1	1	2	2
Motor mass *1	kg	0.38	0.51	0.24	0.29
Allowable thrust load	N	10	10	10	10
Allowable radial load *2	N	30	20	25	24

\*1 Driver mass ▶ p. 28 \*2 The load point is at the tip of the output shaft.

**Characteristics diagram**

With rubber coupling

Pull-out torque — Full step — Half step — fs : Maximum self-start frequency when not loaded — Full step ● Half step ●  
 Source current (no load) — Full step - - - Half step - - - Source current (load applied) — Full step ····· Half step ·····

**DB14S423S**  
**DB14S423D**

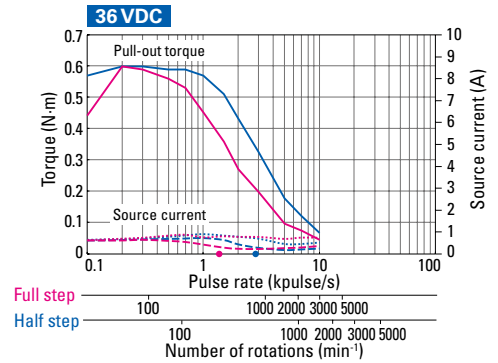
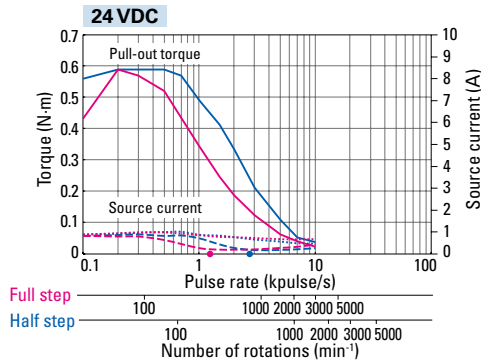

**DB14S424S**  
**DB14S424D**

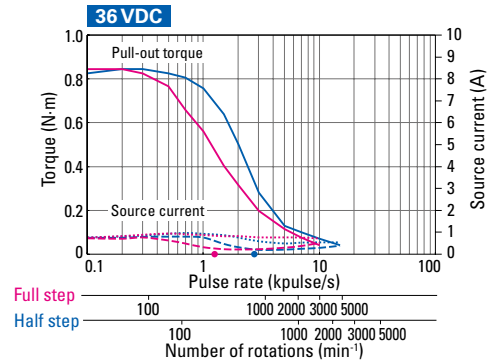
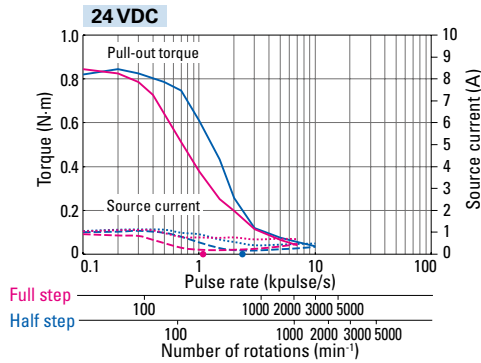

**DB16S141S**  
**DB16S141D**

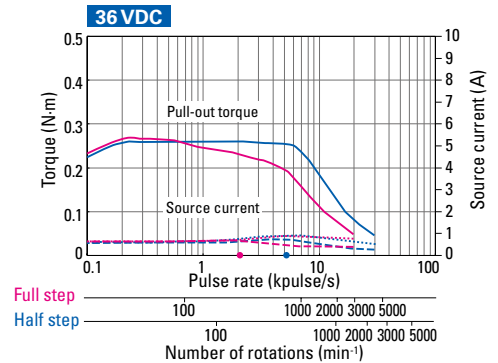
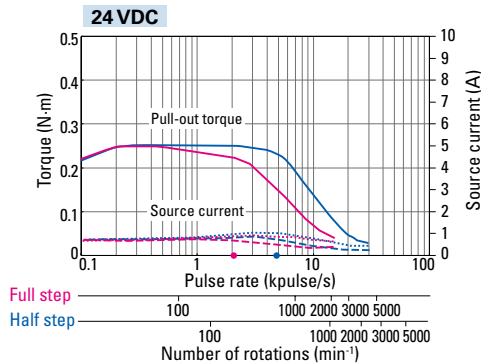

**DB16S142S**  
**DB16S142D**

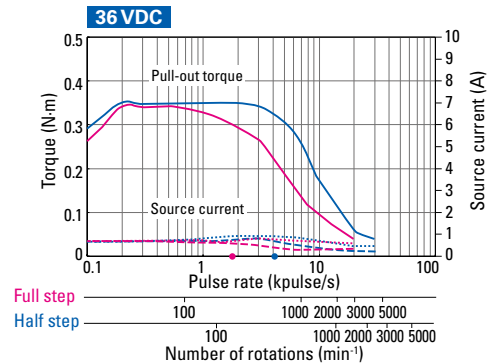
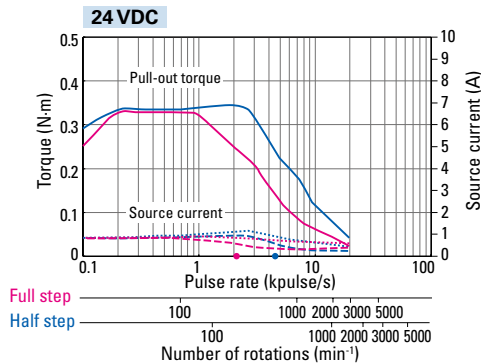

Size	Motor size	42 mm sq./Basic step angle 0.9°	50 mm sq./Basic step angle 1.8°		56 mm sq./Basic step angle 1.8°	
	Motor length	48 mm	39.8 mm	51.3 mm	41.8 mm	
Single shaft	Set model no.	DB16S144S	DB16H671S	DB16H673S	DB16H711S	
	Configuration item: motor model no.	SH1424-5241	103H6701-5040	103H6703-5040	103H7121-5740	
Dual shaft	Set model no.	DB16S144D	DB16H671D	DB16H673D	DB16H711D	
	Configuration item: motor model no.	SH1424-5211	103H6701-5010	103H6703-5010	103H7121-5710	
Holding torque		N·m	0.48	0.28	0.49	0.55
Rotor inertia		$\times 10^{-4} \text{kg}\cdot\text{m}^2$	0.089	0.057	0.118	0.1
Rated current		A/phase	2	2	2	2
Motor mass *1		kg	0.38	0.35	0.5	0.47
Allowable thrust load		N	10	15	15	15
Allowable radial load *2		N	20	79	75	70

\*1 Driver mass ▶ p. 28 \*2 The load point is at the tip of the output shaft.

### Characteristics diagram

With rubber coupling

Pull-out torque Full step — Half step — fs : Maximum self-start frequency when not loaded Full step ● Half step ●  
 Source current (no load) Full step - - - Half step - - - Source current (load applied) Full step ····· Half step ·····

#### DB16S144S DB16S144D

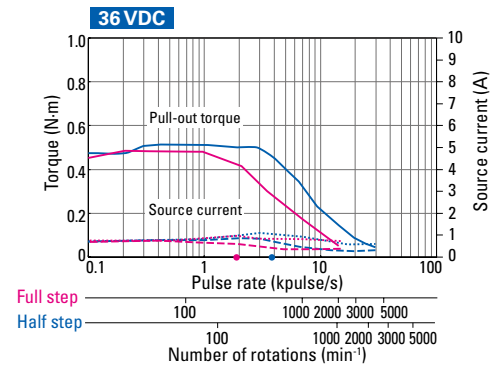
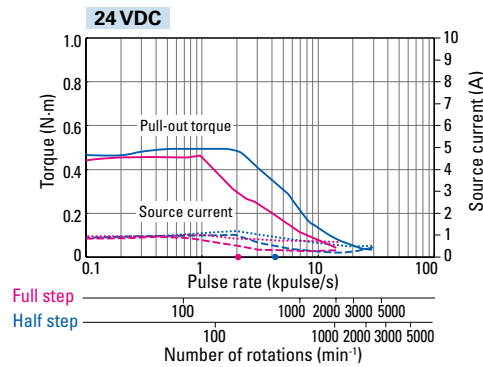

#### DB16H671S DB16H671D

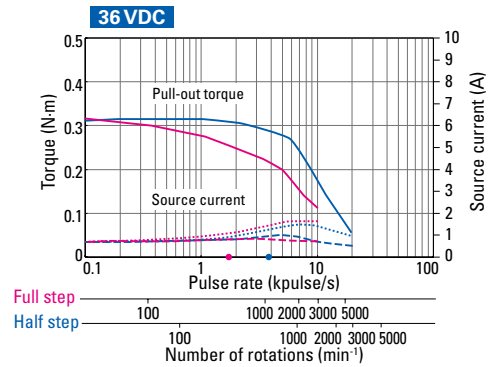
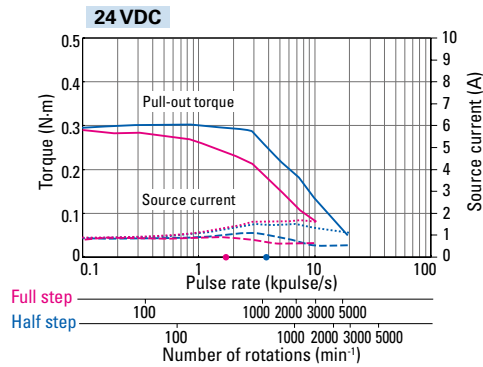

#### DB16H673S DB16H673D

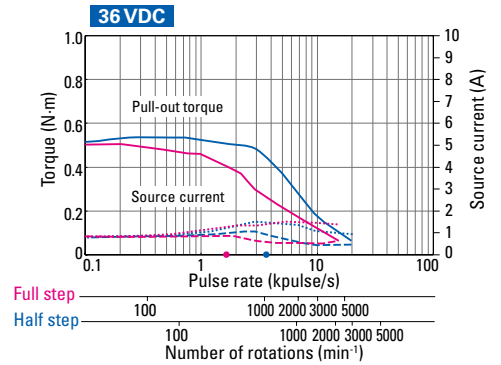
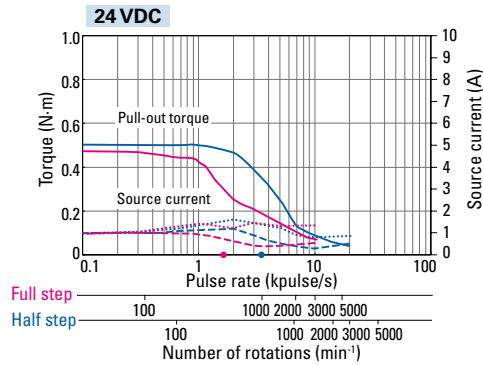

#### DB16H711S DB16H711D

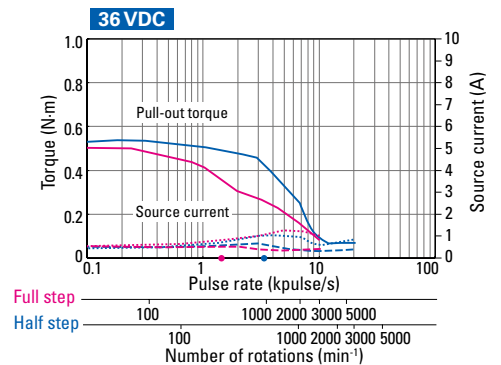
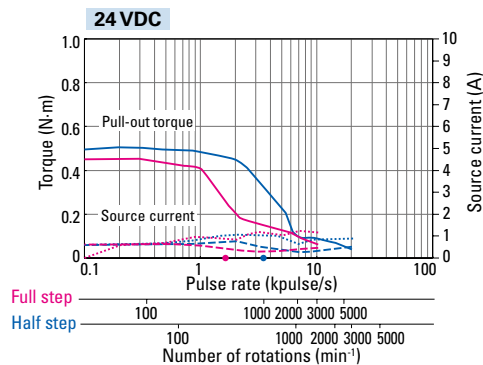

Size	Motor size	56 mm sq./Basic step angle 1.8°		60 mm sq./Basic step angle 1.8°	
		53.8 mm	75.8 mm	44.8 mm	53.8 mm
Single shaft	Set model no.	<b>DB16H713S</b>	<b>DB16H716S</b>	<b>DB16H781S</b>	<b>DB16H782S</b>
	Configuration item: motor model no.	103H7123-5740	103H7126-5740	103H7821-5740	103H7822-5740
Dual shaft	Set model no.	<b>DB16H713D</b>	<b>DB16H716D</b>	<b>DB16H781D</b>	<b>DB16H782D</b>
	Configuration item: motor model no.	103H7123-5710	103H7126-5710	103H7821-5710	103H7822-5710
Holding torque	N·m	1.0	1.6	0.88	1.37
Rotor inertia	$\times 10^{-4}$ kg·m <sup>2</sup>	0.21	0.36	0.275	0.4
Rated current	A/phase	2	2	2	2
Motor mass *1	kg	0.65	0.98	0.6	0.77
Allowable thrust load	N	15	15	20	20
Allowable radial load *2	N	56	33	109	101

\*1 Driver mass ▶ p. 28 \*2 The load point is at the tip of the output shaft.

**Characteristics diagram**

With rubber coupling

Pull-out torque — Full step — Half step — fs : Maximum self-start frequency when not loaded Full step ● Half step ●  
 Source current (no load) — Full step - - - Half step - - - Source current (load applied) Full step ..... Half step .....

**DB16H713S**  
**DB16H713D**

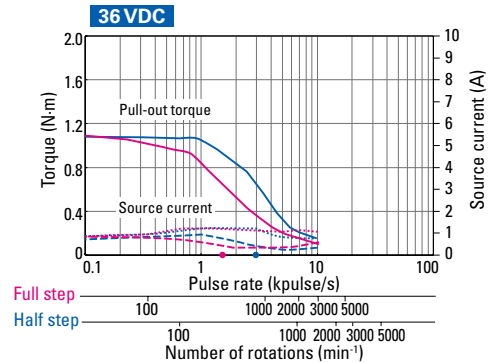
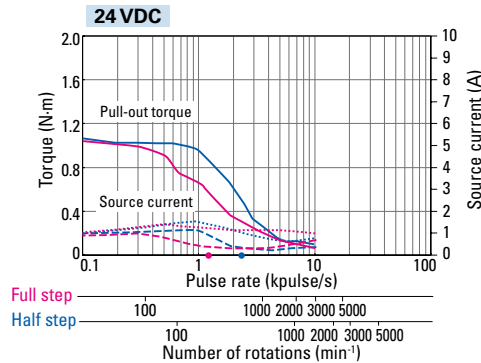

**DB16H716S**  
**DB16H716D**

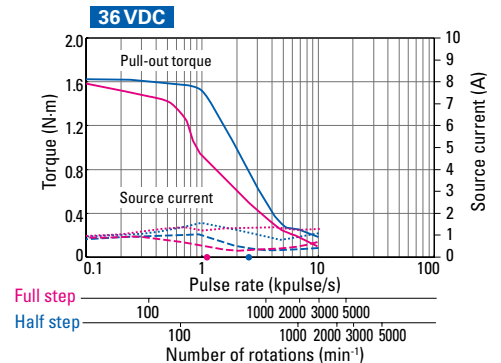
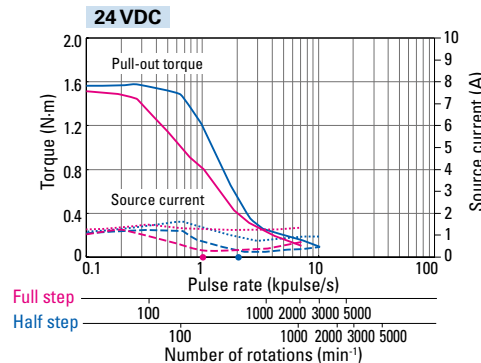

**DB16H781S**  
**DB16H781D**

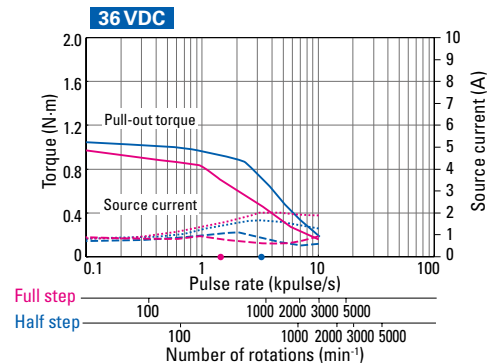
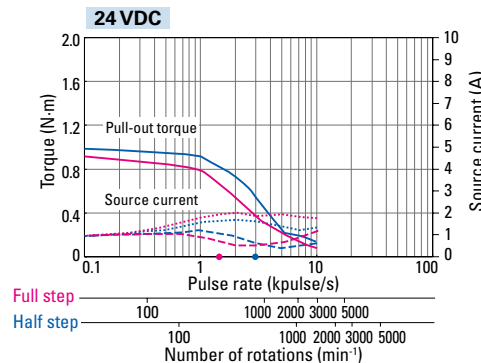

**DB16H782S**  
**DB16H782D**

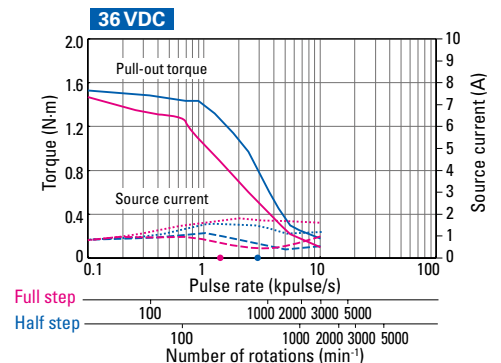
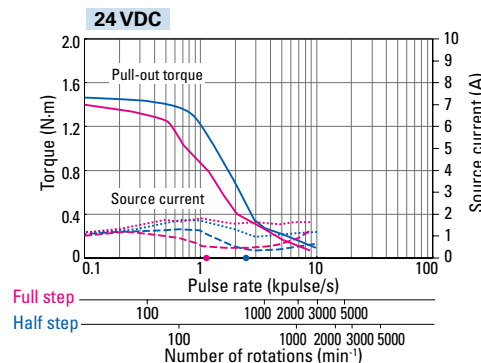

Size	Motor size	60 mm sq./Basic step angle 1.8°		60 mm sq./Basic step angle 0.9°	
	Motor length	85.8 mm	42 mm	54 mm	
Single shaft	Set model no.	DB16H783S	DB16S161S	DB16S162S	
	Configuration item: motor model no.	103H7823-5740	SH1601-5240	SH1602-5240	
Dual shaft	Set model no.	DB16H783D	DB16S161D	DB16S162D	
	Configuration item: motor model no.	103H7823-5710	SH1601-5210	SH1602-5210	
Holding torque	N·m	2.7	0.69	1.28	
Rotor inertia	$\times 10^{-4}$ kg·m <sup>2</sup>	0.84	0.24	0.4	
Rated current	A/phase	2	2	2	
Motor mass *1	kg	1.34	0.55	0.8	
Allowable thrust load	N	20	15	15	
Allowable radial load *2	N	71	78	65	

\*1 Driver mass ▶ p. 28 \*2 The load point is at the tip of the output shaft.

### Characteristics diagram

With rubber coupling

Pull-out torque Full step — Half step — fs: Maximum self-start frequency when not loaded Full step ● Half step ●  
 Source current (no load) Full step - - - Half step - - - Source current (load applied) Full step ····· Half step ·····

#### DB16H783S DB16H783D

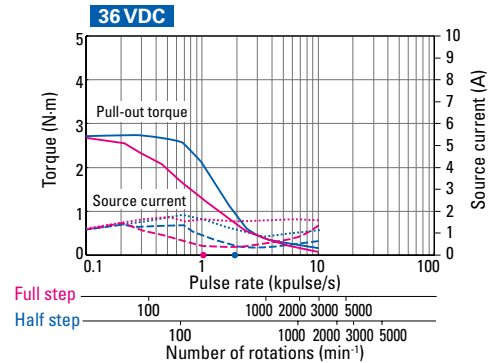
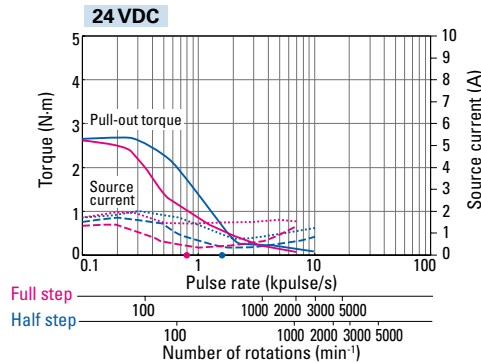

#### DB16S161S DB16S161D

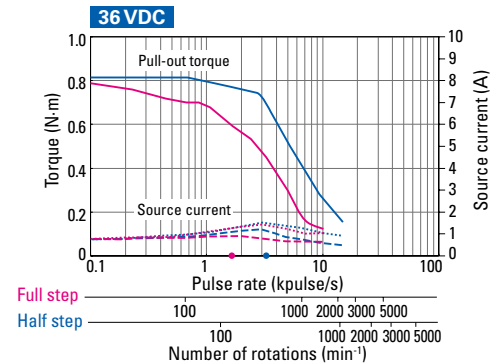
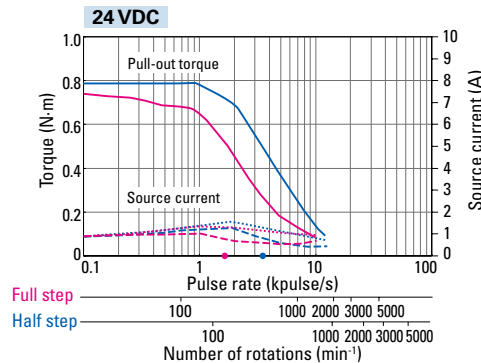

#### DB16S162S DB16S162D

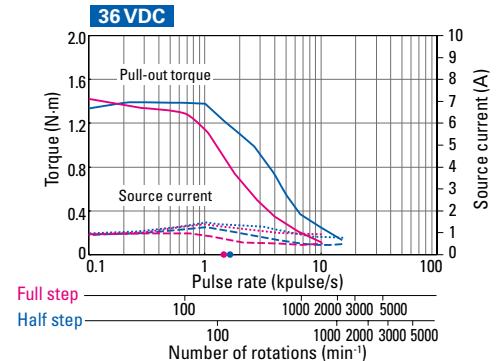
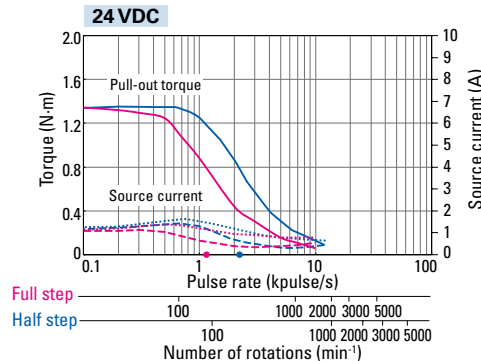

# Stepping Motor: Dimensions

(Unit: mm)

## 28 mm sq.

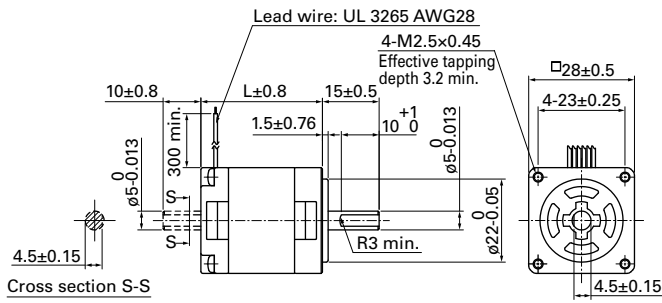

Note: A unipolar motor is illustrated; bipolar motors have four lead wires.

### Unipolar

Set model no.		Motor model no.		Motor length (L)
Single shaft	Dual shaft	Single shaft	Dual shaft	
DU14S281S	DU14S281D	SH2281-5271	SH2281-5231	32
DU14S285S	DU14S285D	SH2285-5271	SH2285-5231	51.5

### Bipolar

Set model no.		Motor model no.		Motor length (L)
Single shaft	Dual shaft	Single shaft	Dual shaft	
DB14S281S	DB14S281D	SH2281-5771	SH2281-5731	32
DB14S285S	DB14S285D	SH2285-5771	SH2285-5731	51.5

## 42 mm sq.

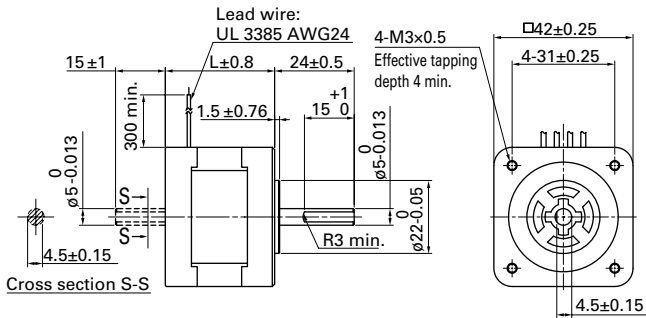

Note: A bipolar motor is illustrated; unipolar motors have six lead wires.

### Unipolar

Set model no.		Motor model no.		Motor length (L)
Single shaft	Dual shaft	Single shaft	Dual shaft	
DU15S141S	DU15S141D	SH1421-0441	SH1421-0411	33
DU15S142S	DU15S142D	SH1422-0441	SH1422-0411	39
DU15S144S	DU15S144D	SH1424-0441	SH1424-0411	48

### Bipolar

Set model no.		Motor model no.		Motor length (L)
Single shaft	Dual shaft	Single shaft	Dual shaft	
DB16S141S	DB16S141D	SH1421-5241	SH1421-5211	33
DB16S142S	DB16S142D	SH1422-5241	SH1422-5211	39
DB16S144S	DB16S144D	SH1424-5241	SH1424-5211	48

## 42 mm sq.

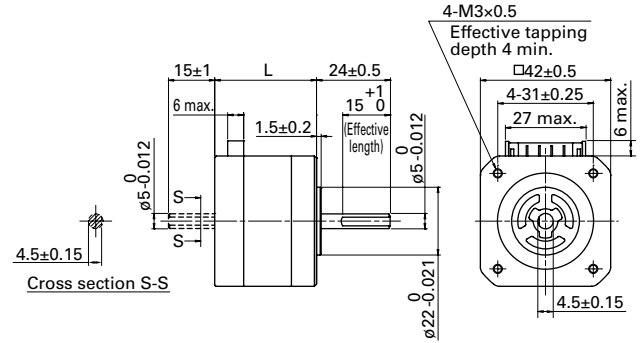

### Unipolar

Set model no.		Motor model no.		Motor length (L)
Single shaft	Dual shaft	Single shaft	Dual shaft	
DU15S421S	DU15S421D	SF2421-12U41	SF2421-12U11	33±0.5
DU15S422S	DU15S422D	SF2422-12U41	SF2422-12U11	39±0.5
DU15S423S	DU15S423D	SF2423-12U41	SF2423-12U11	48±0.5
DU15S424S	DU15S424D	SF2424-12U41	SF2424-12U11	59.5±1

### Bipolar

Set model no.		Motor model no.		Motor length (L)
Single shaft	Dual shaft	Single shaft	Dual shaft	
DB14S421S	DB14S421D	SF2421-10B41	SF2421-10B11	33±0.5
DB14S422S	DB14S422D	SF2422-10B41	SF2422-10B11	39±0.5
DB14S423S	DB14S423D	SF2423-10B41	SF2423-10B11	48±0.5
DB14S424S	DB14S424D	SF2424-10B41	SF2424-10B11	59.5±1

### Motor cable Unipolar model no.: 4835774-1

Manufacturer: J.S.T.  
Housing: PHR-11  
Pin: SPH-002T-P0.5S

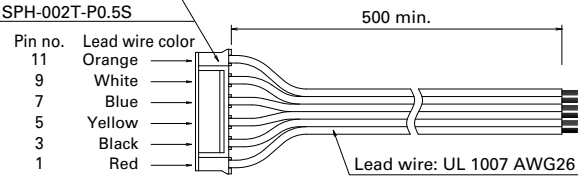

This driver-motor cable is for motor model no. SF242□-12U□1.

### Motor cable Bipolar model no.: 4835775-1

Manufacturer: J.S.T.  
Housing: PHR-11  
Pin: SPH-002T-P0.5S

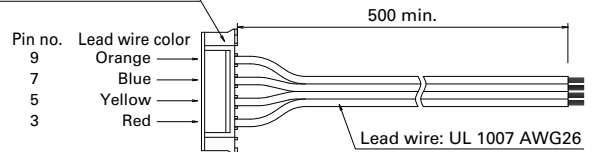

This driver-motor cable is for motor model no. SF242□-10B□1.

# Stepping Motor: Dimensions

(Unit: mm)

## 50 mm sq.

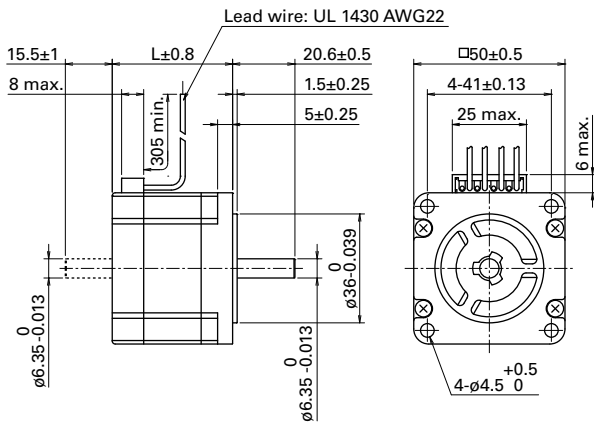

### Bipolar

Set model no.		Motor model no.		Motor length (L)
Single shaft	Dual shaft	Single shaft	Dual shaft	
DB16H671S	DB16H671D	103H6701-5040	103H6701-5010	39.8
DB16H673S	DB16H673D	103H6703-5040	103H6703-5010	51.3

## 60 mm sq.

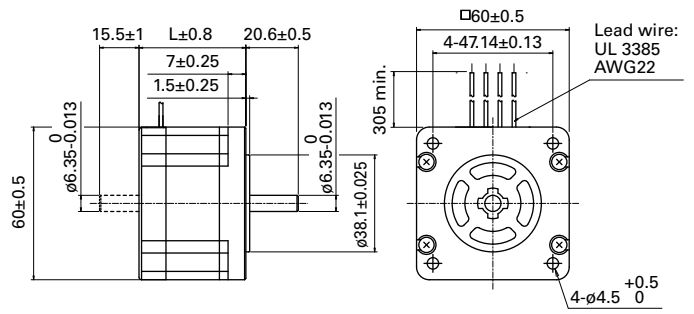

### Bipolar

Set model no.		Motor model no.		Motor length (L)
Single shaft	Dual shaft	Single shaft	Dual shaft	
DB16S161S	DB16S161D	SH1601-5240	SH1601-5210	42
DB16S162S	DB16S162D	SH1602-5240	SH1602-5210	54

## 56 mm sq.

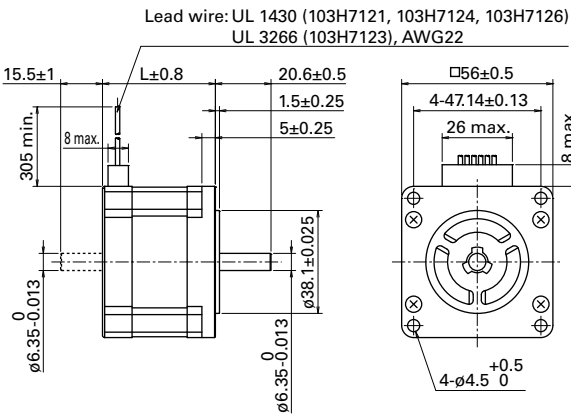

### Unipolar

Set model no.		Motor model no.		Motor length (L)
Single shaft	Dual shaft	Single shaft	Dual shaft	
DU16H711S	DU16H711D	103H7121-0440	103H7121-0410	41.8
DU16H713S	DU16H713D	103H7123-0440	103H7123-0410	53.8
DU16H716S	DU16H716D	103H7126-0440	103H7126-0410	75.8

## 56 mm sq.

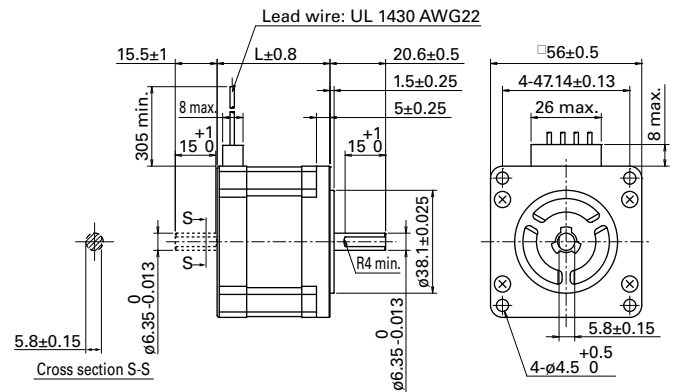

### Bipolar

Set model no.		Motor model no.		Motor length (L)
Single shaft	Dual shaft	Single shaft	Dual shaft	
DB16H711S	DB16H711D	103H7121-5740	103H7121-5710	41.8
DB16H713S	DB16H713D	103H7123-5740	103H7123-5710	53.8
DB16H716S	DB16H716D	103H7126-5740	103H7126-5710	75.8

## 60 mm sq.

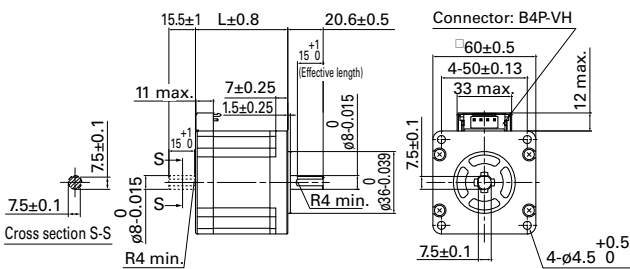

### Bipolar

Set model no.		Motor model no.		Motor length (L)
Single shaft	Dual shaft	Single shaft	Dual shaft	
DB16H781S	DB16H781D	103H7821-5740	103H7821-5710	44.8
DB16H782S	DB16H782D	103H7822-5740	103H7822-5710	53.8
DB16H783S	DB16H783D	103H7823-5740	103H7823-5710	85.8

### Motor cable Bipolar model no.: 4837961-1

Manufacturer: J.S.T.  
Housing: VHR-4N  
Pin: SVH-21T-P1.1

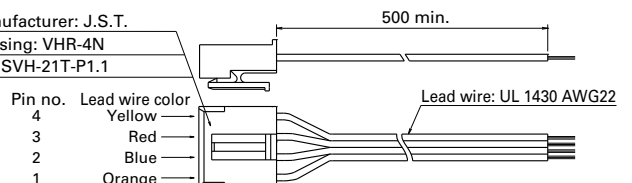



# Stepping Motor: General Specifications

Motor model no.	SH228 □	SH142 □	SF242 □	103H670 □	103H712 □	SH160 □	103H782 □
Type	-						
Operating ambient temperature	-10 to +50°C						
Storage temperature	-20 to +65°C						
Operating ambient humidity	20 to 90% RH (no condensation)						
Storage humidity	5 to 95% RH (no condensation)						
Operation altitude	1000 m max. above sea level						
Vibration resistance	Vibration frequency 10 to 500 Hz, total amplitude 1.52 mm (10 to 70 Hz), vibration acceleration 150 m/s <sup>2</sup> (70 to 500 Hz), sweep time 15 min/cycle, 12 sweeps in each X, Y and Z direction.						
Impact resistance	500 m/s <sup>2</sup> of acceleration for 11 ms with half-sine wave applying three times for X, Y, and Z axes each, 18 times in total.						
Thermal class	Class B (+130°C)						
Withstandable voltage	At normal temperature and humidity, no failure with 500 VAC @50/60 Hz applied for one minute between motor winding and frame.			At normal temperature and humidity, no failure with 1000 VAC @50/60 Hz applied for one minute between motor winding and frame.			
Insulation resistance	At normal temperature and humidity, not less than 100 MΩ between winding and frame by 500 VDC megger.						
Protection grade	-						
Winding temperature rise	80 K max. (Based on SANYO DENKI standard)						
Static angle error	±0.09°	±0.054°	±0.09°		±0.054°	±0.054°	±0.09°
Thrust play *1	0.075 mm max. (load: 1.5 N)	0.075 mm max. (load: 5 N)	0.075 mm (load: 5 N)	0.075 mm (load: 10 N)	0.075 mm (load: 10 N)	0.075 mm (load: 10 N)	0.075 mm (load: 10 N)
Radial play *2	0.025 mm max. (load: 5 N)						
Shaft runout	0.025 mm						
Concentricity of mounting pilot relative to shaft	ø0.05 mm	ø0.05 mm	ø0.05 mm	ø0.075 mm	ø0.075 mm	ø0.075 mm	ø0.075 mm
Squareness of mounting surface relative to shaft	0.1 mm	0.1 mm	0.1 mm	0.075 mm	0.075 mm	0.1 mm	0.075 mm
Direction of motor mounting	Can be freely mounted vertically or horizontally						

\*1 Thrust play: Shaft displacement under axial load.

\*2 Radial play: Shaft displacement under radial load applied one-third of the length from the end of the shaft.

# Internal Wiring and Rotation Direction

## Unipolar winding

Connector type

### Internal wire connection

(Supplied cable lead wire color)

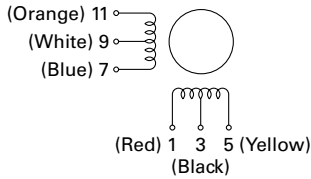

### Direction of motor rotation

When excited by a direct current in the order shown below, the direction of rotation is clockwise as viewed from the output shaft side.

		Connector pin no.				
		3, 9	1	7	5	11
Exciting order	1	+	-	-	-	-
	2	+	-	-	-	-
	3	+	-	-	-	-
	4	+	-	-	-	-

Lead wire type

### Internal wire connection

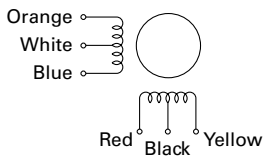

### Direction of motor rotation

When excited by a direct current in the order shown below, the direction of rotation is clockwise as viewed from the output shaft side.

		Lead wire color				
		White, black	Red	Blue	Yellow	Orange
Exciting order	1	+	-	-	-	-
	2	+	-	-	-	-
	3	+	-	-	-	-
	4	+	-	-	-	-

## Bipolar winding

Connector type model no.: SF242

### Internal wire connection

(Supplied cable lead wire color)

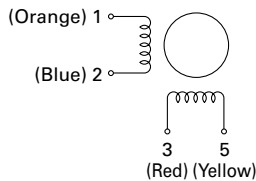

### Direction of motor rotation

When excited by a direct current in the order shown below, the direction of rotation is clockwise as viewed from the output shaft side.

		Connector pin no.			
		3	7	5	9
Exciting order	1	-	-	+	+
	2	+	-	-	+
	3	+	+	-	-
	4	-	+	+	-

Connector type model no.: 103H782

### Internal wire connection

(Supplied cable lead wire color)

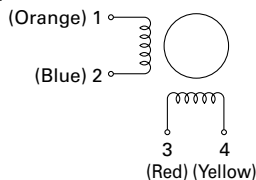

### Direction of motor rotation

When excited by a direct current in the order shown below, the direction of rotation is clockwise as viewed from the output shaft side.

		Connector pin no.			
		3	2	4	1
Exciting order	1	-	-	+	+
	2	+	-	-	+
	3	+	+	-	-
	4	-	+	+	-

Lead wire type

### Internal wire connection

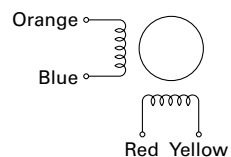

### Direction of motor rotation

When excited by a direct current in the order shown below, the direction of rotation is clockwise as viewed from the output shaft side.

		Lead wire color			
		Red	Blue	Yellow	Orange
Exciting order	1	-	-	+	+
	2	+	-	-	+
	3	+	+	-	-
	4	-	+	+	-

# Driver Dimensions (Unit: mm)

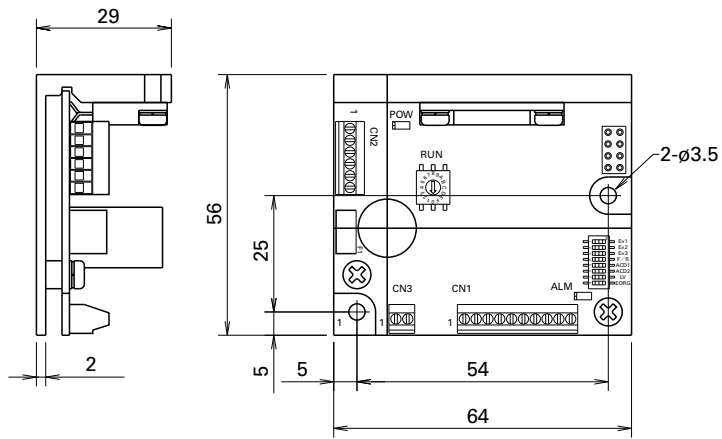

# Driver Specifications

## General specifications

		Unipolar	Bipolar	
Basic specifications	Model no.	<b>US1D200P10</b>	<b>BS1D200P10</b>	
	Input source	24/36 VDC ±10%		
	Source current	3 A		
	Environment	Protection class	Class III	
		Operation environment	Installation category (over-voltage category): I, pollution degree: 2	
		Ambient operation temperature	0 to +50°C	
		Storage temperature	-20 to +70°C	
		Operating ambient humidity	35 to 85% RH (no condensation)	
		Storage humidity	10 to 90% RH (no condensation)	
		Operation altitude	1000 m (3281 feet) or less above sea level	
		Vibration resistance	Tested under the following conditions: 5 m/s <sup>2</sup> frequency range 10 to 55 Hz, direction along X, Y and Z axes, for 2 hours each	
		Impact resistance	Not influenced at NDS-C-0110 standard section 3.2.2 division "C".	
		Withstandable voltage	Not influenced when 0.5 kVAC is applied between power input terminal and cabinet for one minute.	
	Insulation resistance	10 MΩ min. when measured with 500 VDC megohmmeter between input terminal and cabinet.		
	Mass	0.09 kg		
Functions	Selection functions	Step angle, pulse input mode, low vibration mode, step current, operating current, original excitation phase		
	Protection functions	Open phase protection, Main circuit power source voltage decrease		
	LED indication	Power monitor, alarm display		
I/O signals	Command pulse input signal	Photocoupler input system, input resistance: 220 Ω input-signal "H" level: 4.0 to 5.5 V, input-signal "L" level: 0 to 0.5 V Maximum input frequency: 150 kpulse/s		
	Power down input signal	Photocoupler input system, input resistance: 220 Ω input-signal "H" level: 4.0 to 5.5V, input-signal "L" level: 0 to 0.5 V		
	Phase origin monitor output signal	From the photocoupler by the open collector output Output specification: V <sub>ceo</sub> = 40 V max., I <sub>c</sub> = 10 mA max.		
	Alarm output signal	From the photocoupler by the open collector output Output specification: V <sub>ceo</sub> = 40 V max., I <sub>c</sub> = 10 mA max.		

## Safety standards

	Directives	Category	Standard	Name
CE (TÜV)	Low-voltage directives	–	EN 61010-1	–
	EMC directives	Emission	EN 55011-A	Terminal disturbance voltage
			EN 55011-A	Electromagnetic radiation disturbance
			EN 61000-4-2	ESD (Electrostatic discharge)
		Immunity	EN 61000-4-3	RS (Radio-frequency amplitude modulated electromagnetic field)
			EN 61000-4-4	Fast transients/burst
			EN 61000-4-6	Conducted disturbances
UL	Acquired standards		Applicable standard	File no.
	UL		UL 508C	E179775
	UL for Canada			

- EMC characteristics may vary depending on the configuration of the users' control panel, which contains the driver or stepping motor, or the arrangement and wiring of other electrical devices.  
Parts for EMC noise suppression like noise filters and toroidal type ferrite cores may be required depending on circumstances.
- Validation test of driver has been performed for low-voltage EMC directives at TÜV (TÜV product service) for self-declaration of CE marking.
- Drivers are available for separate purchase. Connector-type drivers are also available. Contact us for details.

# Driver Controls and Connectors

## Unipolar

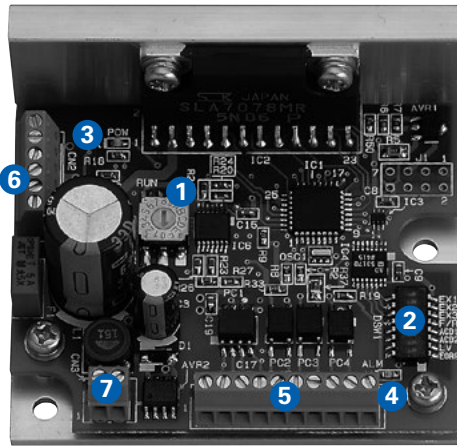

## Bipolar

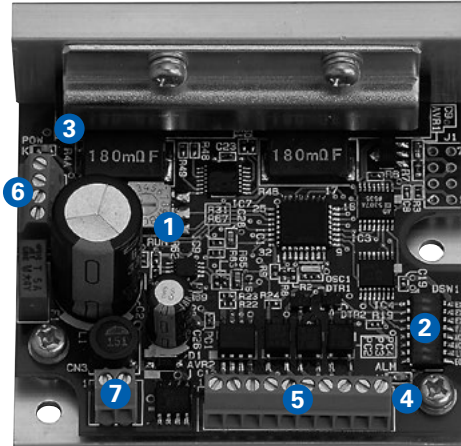

### 1. Operating current selection switch (RUN)

The value of the motor current can be set when operating.

Dial	0	1	2	3	4	5	6	7
Stepping motor current (A)	2.0	1.9	1.8	1.7	1.6	1.5	1.4	1.3
Dial	8	9	A	B	C	D	E	F
Stepping motor current (A)	1.2	1.1	1.0	0.9	0.8	0.7	0.6	0.5

- The factory setting is F (0.5 A).  
Select the current after checking the rated current of the combination motor.

### 2. Function selection DIP switchpack

Select the function depending on your specification.

Factory settings

	OFF	ON	
EX1	<input type="checkbox"/>	<input type="checkbox"/>	Partition number: 8
EX2	<input type="checkbox"/>	<input type="checkbox"/>	
EX3	<input type="checkbox"/>	<input type="checkbox"/>	
F/R	<input type="checkbox"/>	<input type="checkbox"/>	Input method 2 (CW/CCW pulse input)
ACD1	<input type="checkbox"/>	<input type="checkbox"/>	Stopping current: 40% of driving current
ACD2	<input type="checkbox"/>	<input type="checkbox"/>	
LV	<input type="checkbox"/>	<input type="checkbox"/>	Micro step operation
EORG	<input type="checkbox"/>	<input type="checkbox"/>	Phase origin

#### 1. Step angle select (EX1, EX2, EX3)

Select the partition number of the basic step angle.

EX1	EX2	EX3	Partition no.
ON	ON	ON	1-division
OFF	ON	OFF	2-division
ON	OFF	OFF	4-division
OFF	OFF	OFF	8-division
OFF	OFF	ON	16-division

#### 2. Input method select (F/R)

Select input pulse type.

F/R	Input pulse type
ON	1 input (CK, U/D)
OFF	2 input (CW, CCW)

#### 3. Current selection when stopping (ACD1, ACD2)

Select the current value of the motor when stopping.

ACD2	ACD1	Current value of the motor
ON	ON	100% of driving current
ON	OFF	60% of driving current
OFF	ON	50% of driving current
OFF	OFF	40% of driving current

- Initial configuration of factory shipment is set to 40% of rated value.  
Driver and motor should be operated at around 50% of rated value to reduce heat.

### 4. Low-vibration mode select (LV)

Provides low-vibration, smooth operation even if resolution is coarse (1-division, 2-division, etc).

LV	Operation
ON	Auto-micro function
OFF	Micro-step

### 5. Excitation select (EORG)

The excitation phase when the power supply is engaged is selected.

EORG	Original excitation phase
ON	Excitation phase at power shut off
OFF	Phase origin

- By turning on the EORG, the excitation phase during power OFF will be saved. Therefore, there will be no shaft displacement when turning the power ON.

### 3. LED for power supply monitor (POW)

Lit up when the main circuit power supply is connected.

### 4. LED for alarm display (ALM)

Lights in the following conditions:

- Motor cable is broken.
- Switching element in driver is faulty.
- The main circuit voltage is out of specifications range (19 VDC max.).

When "ALM" is displayed, the winding current of the stepping motor is cut off and it is in a "non-excitation" state. At the same time, an output signal (photocoupler ON) is transmitted from the alarm output terminal (AL) to an external source. When the alarm circuit is operating, this state is maintained until it is reset by switching on the power supply again. When an alarm condition has occurred, please take corrective actions to rectify the cause of the alarm before switching on the power supply again.

### 5. I/O signal terminal block (CN1)

Connect the I/O signal.

### 6. Motor terminal block (CN2)

Connect the motor's power line.

### 7. Power supply terminal block (CN3)

Connect the main circuit power supply.

## Connections and Signals

### External wiring diagram

#### Unipolar

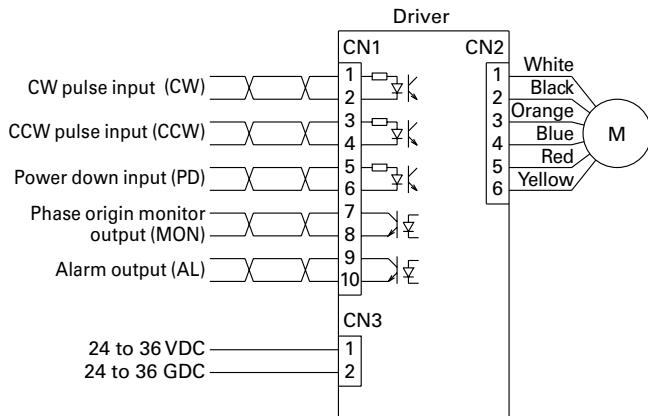

#### Bipolar

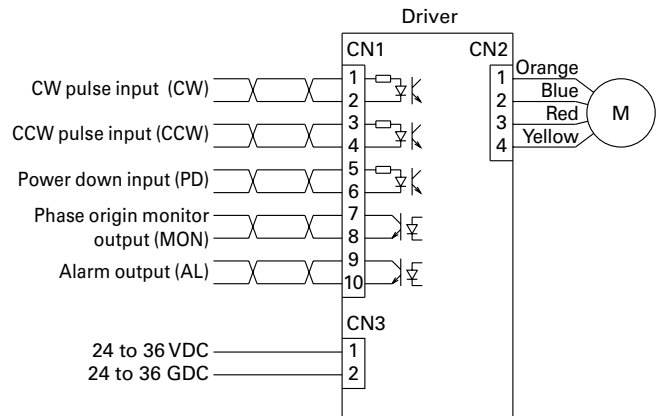

### Applicable wire sizes

Part	Wire sizes	Allowable wire length
For power supply	AWG22 (0.3 mm <sup>2</sup> )	2 m max.
For input/output signal	AWG24 (0.2 mm <sup>2</sup> ) to AWG22 (0.3 mm <sup>2</sup> )	2 m max.
For motor	AWG22 (0.3 mm <sup>2</sup> )	Under 3 m

### Specification summary of input/output signals

Signal	CN1 Pin no.	Function summary
CW pulse input (CW) (Standard)	1 2	When in "2 input type", input the drive pulse that rotates in a CW direction.
Pulse train input (CK)	1 2	When in "1 input type", input the drive pulse train for motor rotation.
CCW pulse input (CCW) (Standard)	3 4	When in "2 input type", input the drive pulse train that rotates in a CCW direction.
Rotational direction input (U/D)	3 4	When in "1 input type", input the motor rotational direction signal. Internal photocoupler ON ... CW direction Internal photocoupler OFF ... CCW direction
Power down input (PD)	5 6	Inputting PD signal will cut off (power off) the current flowing to the motor (With DIP switch select, change to the Power low function is possible). PD input signal on (internal photocoupler on) ... PD function is valid. PD input signal off (internal photocoupler off) ... PD function is invalid.
Phase origin monitor output (MON)	7 8	When the excitation phase is at the origin (during power on) this function turns on. When FULL step, ON once for 4 pulses; when HALF step, ON once for 8 pulses.
Alarm output (AL)	9 10	When alarm circuits are actuated inside the driver, outputs signals to outside, after which the stepping motor changes to unexcited status.

· As for the motor rotational direction, CW direction is regarded as the clockwise rotation, and CCW direction is regarded as the counterclockwise rotation by viewing the motor from output shaft side.

# Circuit Configuration of Pulse Input CW (CK), CCW (U/D)

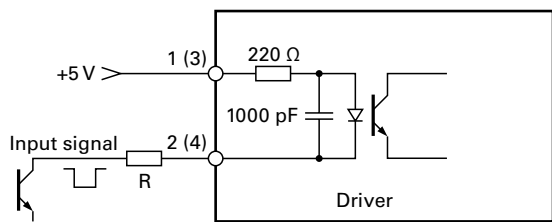

- Pulse duty 50% max.
- Maximum input frequency: 150 kpulse/s
- If the peak voltage of the input signal exceeds 5.5 V, please add an external current-limiting resistor R to limit the input current to around 15 mA. (Take the photocopler forward voltage of 1.5 V into consideration.)

## Input signal specifications

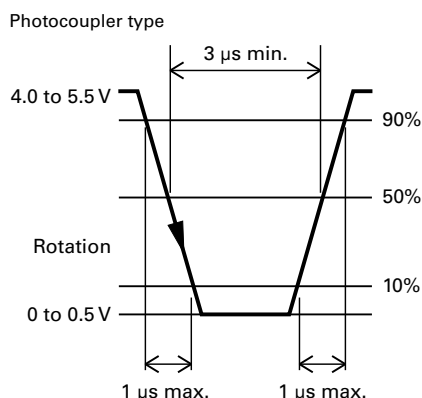

## Timing of the command pulse

### 2 input mode (CW, CCW)

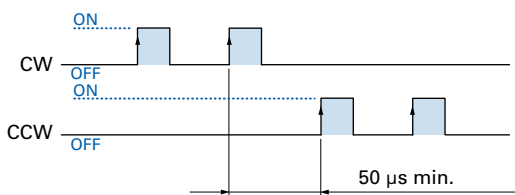

- Shaded area indicates internal photocoupler ON. Internal circuit (motor) starts operating at leading edge of the photocoupler ON.
- To apply pulse to CW, set CCW side internal photocoupler to OFF.
- To apply pulse to CCW, set CW side internal photocoupler to OFF.

### 1 input mode (CK, U/D)

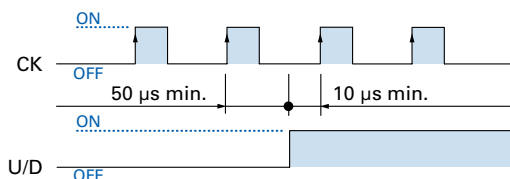

- Shaded area indicates internal photocoupler ON. Internal circuit (motor) starts operating at leading edge of CK side photocoupler ON.
- Switching of U/D input signal must be done while CK side internal photocoupler is OFF.

# Input Circuit Configuration of Power Down Input (PD)

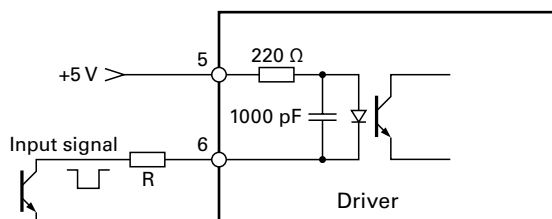

- If the peak voltage of the input signal exceeds 5.5 V, please add an external current-limiting resistor R to limit the input current to around 15 mA. (Take the photocopler forward voltage of 1.5 V into consideration.)

# Output Signal Configuration of Phase Origin Monitor Output (MON) and Alarm Output (AL)

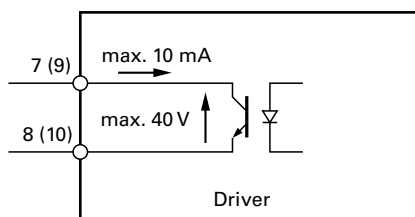

## MON output

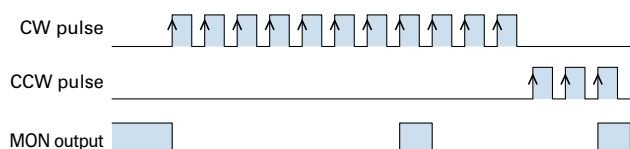

- Photocopler is set to ON at phase origin of motor excitation (setting when number of divisions is 2).
- MON output is taken at every 7.2 degrees of motor output shaft from phase origin.





# Stepping Motors

Stepping Motors

▶ p. 38–

IP65 Splash and Dust Proof Stepping Motors

Waterproof, dustproof

▶ p. 74–

Stepping Motors for Vacuum Environments

Customized Products

▶ p. 79

Synchronous Motors











Customized Products

▶ p. 79

# Lineup

## Stepping Motors RoHS

These motors can be purchased as separate units.

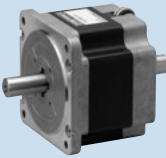
Basic step angle	Motor size	Holding torque (N·m) Model no.	Customizing*	Page
1.8°	14 mm sq. <b>Ultra-compact</b>	 0.0065 to 0.01 SH214□-5□□1	<a href="#">Hollow</a> <a href="#">Shaft modification</a>	p. 38
	28 mm sq.	 0.055 to 0.145 SH228□-5□□1	<a href="#">Hollow</a> <a href="#">Shaft modification</a> <a href="#">Decelerator</a> <a href="#">Encoder</a>	pp. 39 to 40
	35 mm sq.	 0.12 to 0.23 SH35□□-12U□0	<a href="#">Hollow</a> <a href="#">Shaft modification</a>	p. 41
0.9°	42 mm sq.	 0.2 to 0.48 SH142□-□□□1	<a href="#">Hollow</a> <a href="#">Shaft modification</a> <a href="#">Decelerator</a> <a href="#">Encoder</a>	pp. 42 to 43
1.8°	42 mm sq. <b>Slim form</b>	 0.083 to 0.186 SS242□-50□1	<a href="#">Hollow</a> <a href="#">Shaft modification</a>	p. 44
	42 mm sq.	 0.22 to 0.8 SF242□-□□□□1	<a href="#">Shaft length</a> <a href="#">Shaft shape</a>	pp. 45 to 47
	50 mm sq.	 0.28 to 0.53 103H670□-□□□0	<a href="#">Hollow</a> <a href="#">Shaft modification</a>	pp. 48 to 50
	50 mm sq. <b>Slim form</b>	 0.1 to 0.215 SS250□-80□0	<a href="#">Hollow</a> <a href="#">Shaft modification</a>	p. 51
	56 mm sq.	 0.39 to 2.0 103H712□-□□□0	<a href="#">Hollow</a> <a href="#">Shaft modification</a> <a href="#">Decelerator</a> <a href="#">Encoder</a>	pp. 52 to 55
0.9°	60 mm sq.	 0.57 to 2.15 SH160□-□□□0	<a href="#">Hollow</a> <a href="#">Shaft modification</a> <a href="#">Decelerator</a> <a href="#">Encoder</a>	pp. 56 to 57
1.8°	60 mm sq.	 0.78 to 2.7 103H782□-□□□0	<a href="#">Hollow</a> <a href="#">Shaft modification</a> <a href="#">Decelerator</a> <a href="#">Encoder</a> <a href="#">Brake</a>	pp. 58 to 61
	86 mm sq. (CE and UL models are available.)	 2.5 to 9 S□286□-□□□□	<a href="#">Hollow</a> <a href="#">Shaft modification</a> <a href="#">Encoder</a>	pp. 62 to 66

\*Specifications can be customized, depending on the model number and quantity. Contact us for details.

Basic step angle	Motor size	Holding torque (N·m) Model no.	Customizing*	Page
1.8°	Ø106 mm 	10.8 to 19 103H8922□-□□□1	Hollow Brake Shaft modification	p. 67
	56 mm sq. CE Model 	0.39 to 1.27 103H712□-6□□0	Hollow Shaft modification	p. 68
	Ø86 mm CE Model 	2.74 to 7.44 103H822□-6□□0	Hollow Shaft modification	p. 69
	Ø106 mm CE Model 	13.2 to 19 103H8922□-63□1	Hollow Shaft modification	p. 70

\*Specifications can be customized, depending on the model number and quantity. Contact us for details.

## IP65 Splash and Dust Proof Stepping Motors

Waterproof, dustproof

RoHS

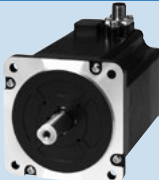
Basic step angle	Motor size	Holding torque (N·m) Model no.	Page
1.8°	56 mm sq. CE/UL Model 	1 to 1.7 N·m SP256□-5□□0	p. 75
	86 mm sq. CE/UL Model 	3.3 to 9 N·m SP286□-5□□0	p. 77

## Stepping Motors for Vacuum Environments

Customized Products

Motor size	Page
42 mm sq. to Ø106 mm 	p. 79

## Synchronous Motors

Customized Products

Motor size	Page
56 mm sq. to Ø106 mm 	p. 79

## Customization

Different types of customization are possible, depending on the request and quantity. Contact us for details.

### Manufacturing example

#### Harness modification

Connectors, cable ties, and plastic tubing can be added.

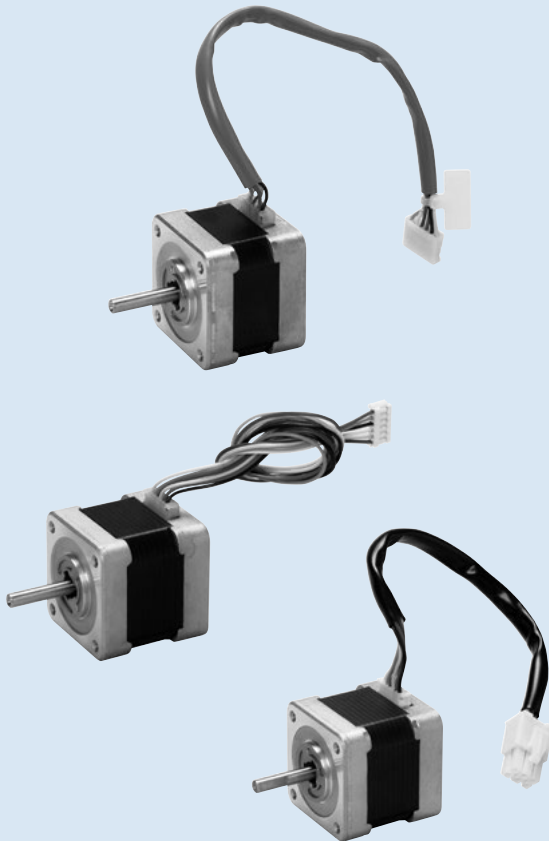

#### Shaft modification

D-cuts, key grooves, and through holes can be added; and gears and pulleys can be mounted. The shaft can also be hollowed to allow airflow or to pass lead wires through.

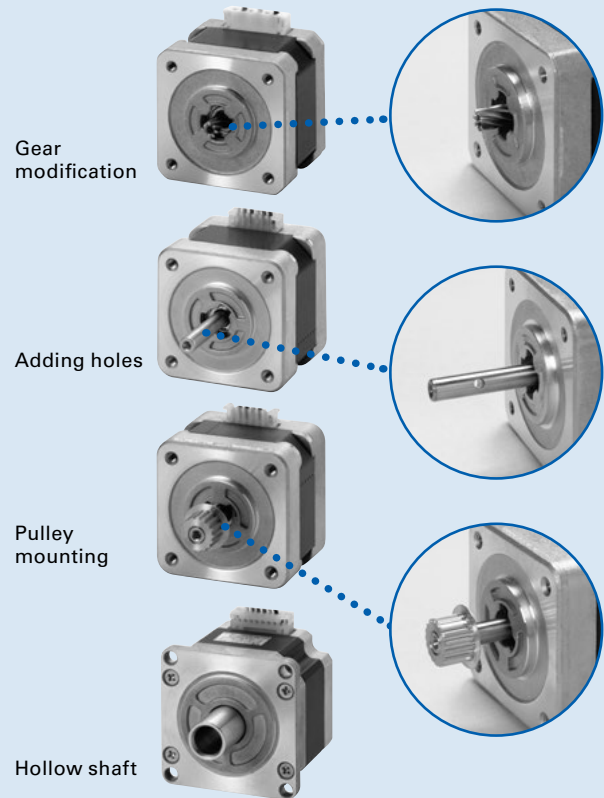

#### Rotating damper, mounting-side damper

A damper can be added to reduce vibrations when rotating.



Rotating damper



Mounting-side damper

#### Decelerator, encoder, brake

- A decelerator can be added when a large high-load torque is required at low speeds.
- An encoder can be added in order to detect position and speed.
- A brake can be added to hold the position when the motor is stopped.

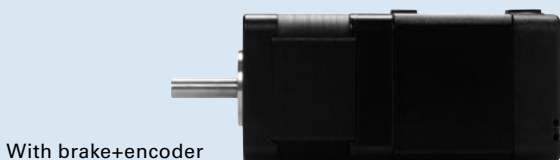

With brake+encoder

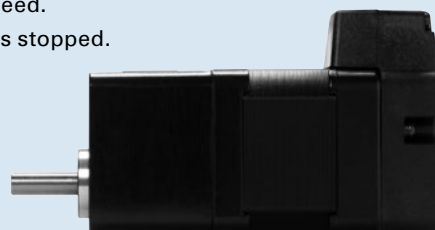

With decelerator+encoder

# How to Read the Specifications

## Bipolar winding, Lead wire type

1 Model no.	2 Holding torque at 2-phase energization		3 Rated current	4 Wiring resistance	5 Winding inductance	6 Rotor inertia	7 Mass	8 Motor length (L)
	Single shaft	Dual shaft	N·m min.	A/phase	$\Omega$ /phase	mH/phase	$\times 10^{-4}$ kg·m <sup>2</sup>	kg
<b>SH2141-5541</b>	<b>SH2141-5511</b>	0.0065	0.3	21	4.2	0.00058	0.03	30
<b>SH2145-5641</b>	<b>SH2145-5611</b>	0.01	0.4	19	4	0.0011	0.042	43.8

## Characteristics diagram

### SH2141-5541 SH2141-5511

Constant current circuit  
Source voltage: 24 VDC  
Operating current:  
0.3 A/phase, 2-phase  
energization (full-step)  
Pull-out torque:  
 $J_s=0.01 \times 10^{-4}$ kg·m<sup>2</sup> (pulley  
balancer method)  
fs: Maximum self-start  
frequency when not  
loaded

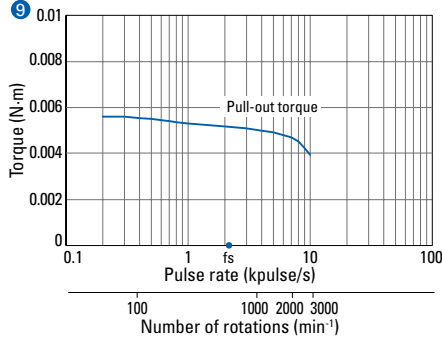

### SH2145-5641 SH2145-5611

Constant current circuit  
Source voltage: 24 VDC  
Operating current:  
0.4 A/phase, 2-phase  
energization (full-step)  
Pull-out torque:  
 $J_s=0.01 \times 10^{-4}$ kg·m<sup>2</sup> (pulley  
balancer method)  
fs: Maximum self-start  
frequency when not  
loaded

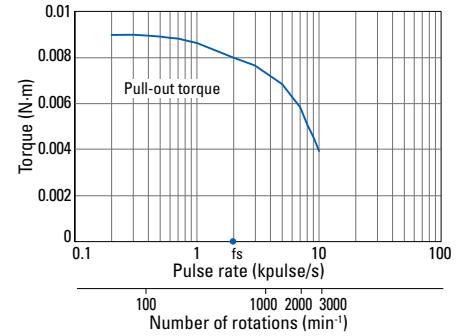

- This is the stepping motor model number.
- This is the maximum torque that occurs with 2-phase excitation of the stepping motor at rated current, causing the shaft to rotate from the outside.
- This is the rated current that flows to the motor winding. Allowing this amount of current to flow to the motor will create torque equal to the holding torque value.
- This is the resistance for one phase of the stepping motor winding.
- This is the inductance for one phase of the stepping motor winding.
- This is the moment of inertia of the rotor, which shows how much torque is required to cause the rotor to accelerate or decelerate.
- This is the mass of the stepping motor.
- This is the length of the stepping motor.
- This graph shows the relationship between the full step pulse rate (frequency), speed, and pull-out torque.

# Stepping Motors

Allowable Load ▶ p. 71 Internal Wiring, Rotation Direction ▶ p. 72  
General Specifications ▶ p. 73



## 14 mm sq.

1.8°/step **Ultra-compact** **RoHS**

Bipolar winding, Lead wire type

### Customizing

**Hollow** **Shaft modification**

Varies depending on the model number and quantity. Contact us for details.

### Bipolar winding, Lead wire type

Model no.		Holding torque at 2-phase energization	Rated current	Wiring resistance	Winding inductance	Rotor inertia	Mass	Motor length (L)
Single shaft	Dual shaft	N·m min.	A/phase	Ω/phase	mH/phase	$\times 10^{-4}$ kg·m <sup>2</sup>	kg	mm
<b>SH2141-5541</b>	<b>SH2141-5511</b>	0.0065	0.3	21	4.2	0.00058	0.03	30
<b>SH2145-5641</b>	<b>SH2145-5611</b>	0.01	0.4	19	4	0.0011	0.042	43.8

## Characteristics diagram

### SH2141-5541 SH2141-5511

Constant current circuit  
Source voltage: 24 VDC  
Operating current:  
0.3 A/phase, 2-phase  
energization (full-step)  
Pull-out torque:  
 $J_L=0.01 \times 10^{-4}$ kg·m<sup>2</sup> (pulley  
balancer method)  
fs: Maximum self-start  
frequency when not  
loaded

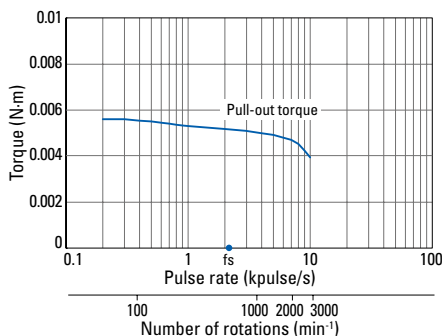

### SH2145-5641 SH2145-5611

Constant current circuit  
Source voltage: 24 VDC  
Operating current:  
0.4 A/phase, 2-phase  
energization (full-step)  
Pull-out torque:  
 $J_L=0.01 \times 10^{-4}$ kg·m<sup>2</sup> (pulley  
balancer method)  
fs: Maximum self-start  
frequency when not  
loaded

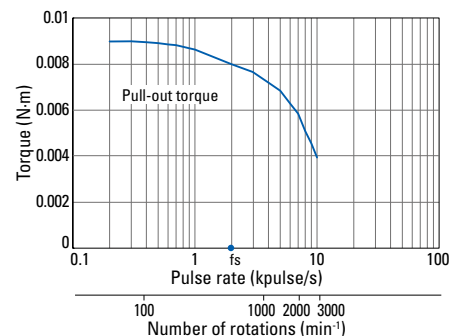

## Dimensions (Unit: mm)

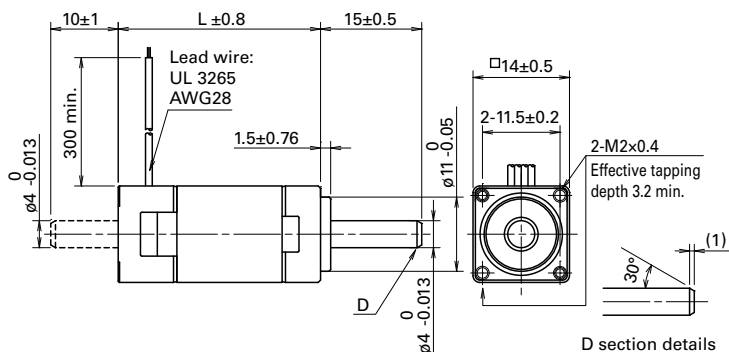

## Internal wiring

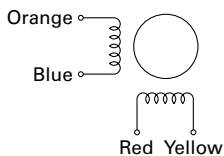

## Compatible drivers

Driver is not included.

If you require assistance finding a driver, contact us for details.

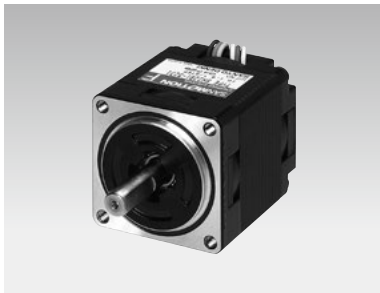

# 28 mm sq.

1.8°/step RoHS

Unipolar winding, Lead wire type  
Bipolar winding, Lead wire type ▶ p. 40

### Customizing

Hollow Shaft modification  
Decelerator Encoder

Varies depending on the model number and quantity. Contact us for details.

### Unipolar winding, Lead wire type

Model no.		Holding torque at 2-phase energization	Rated current	Wiring resistance	Winding inductance	Rotor inertia	Mass	Motor length (L)
Single shaft	Dual shaft	N·m min.	A/phase	Ω/phase	mH/phase	×10 <sup>-4</sup> kg·m <sup>2</sup>	kg	mm
SH2281-5171	SH2281-5131	0.055	0.5	10.5	3.7	0.01	0.11	32
SH2281-5271	SH2281-5231	0.055	1	2.85	1	0.01	0.11	32
SH2285-5171	SH2285-5131	0.115	0.5	17	7	0.022	0.2	51.5
SH2285-5271	SH2285-5231	0.115	1	4.1	1.9	0.022	0.2	51.5

## Characteristics diagram

### SH2281-5171 SH2281-5131

Constant current circuit  
Source voltage: 24 VDC  
Operating current:  
0.5 A/phase, 2-phase  
energization (full-step)  
Pull-out torque:  
 $J_L=0.01 \times 10^{-4} \text{kg} \cdot \text{m}^2$  (pulley  
balancer method)  
fs: Maximum self-start  
frequency when not  
loaded

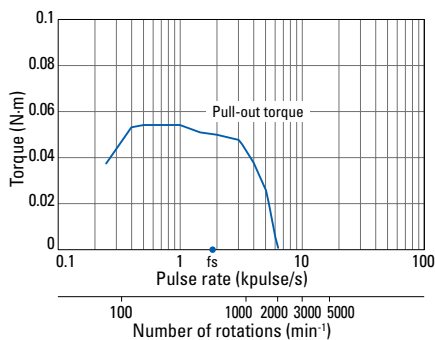

### SH2281-5271 SH2281-5231

Constant current circuit  
Source voltage: 24 VDC  
Operating current:  
1 A/phase, 2-phase  
energization (full-step)  
Pull-out torque:  
 $J_L=0.01 \times 10^{-4} \text{kg} \cdot \text{m}^2$  (pulley  
balancer method)  
fs: Maximum self-start  
frequency when not  
loaded

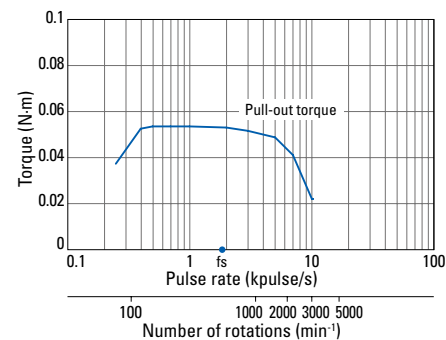

### SH2285-5171 SH2285-5131

Constant current circuit  
Source voltage: 24 VDC  
Operating current:  
0.5 A/phase, 2-phase  
energization (full-step)  
Pull-out torque:  
 $J_L=0.01 \times 10^{-4} \text{kg} \cdot \text{m}^2$  (pulley  
balancer method)  
fs: Maximum self-start  
frequency when not  
loaded

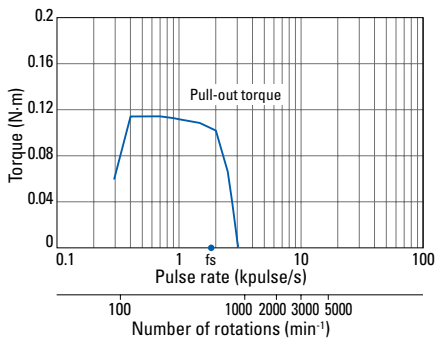

### SH2285-5271 SH2285-5231

Constant current circuit  
Source voltage: 24 VDC  
Operating current:  
1 A/phase, 2-phase  
energization (full-step)  
Pull-out torque:  
 $J_L=0.01 \times 10^{-4} \text{kg} \cdot \text{m}^2$  (pulley  
balancer method)  
fs: Maximum self-start  
frequency when not  
loaded

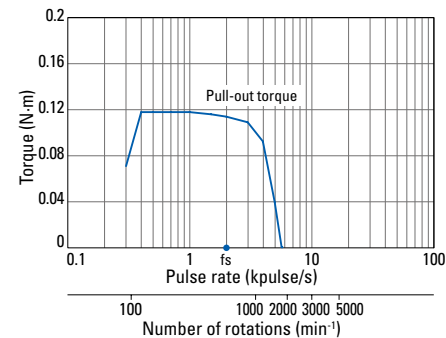

## Dimensions (Unit: mm)

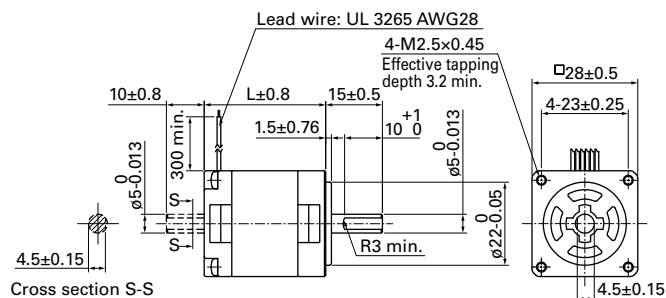

## Internal wiring

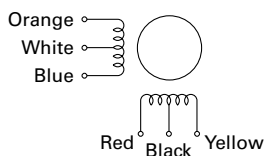

## Compatible drivers

- For motor model no. SH228 □ -51 □ 1 (0.5 A/phase)  
Driver is not included.  
If you require assistance finding a driver, contact us for details.
- For model no. SH228 □ -52 □ 1 (1 A/phase)  
Model no.: BS1D200P10 (DC input)  
Operating current select switch setting: A  
*The characteristics diagram shown above is from our experimental circuit.*

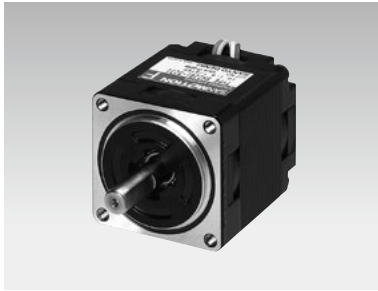

# 28 mm sq.

1.8°/step RoHS

Bipolar winding, Lead wire type  
Unipolar winding, Lead wire type ▶ p. 39

### Customizing

Hollow Shaft modification  
Decelerator Encoder

Varies depending on the model number and quantity. Contact us for details.

### Bipolar winding, Lead wire type

Model no.		Holding torque at 2-phase energization	Rated current	Wiring resistance	Winding inductance	Rotor inertia	Mass	Motor length (L)
Single shaft	Dual shaft	N·m min.	A/phase	Ω/phase	mH/phase	$\times 10^{-4}$ kg·m <sup>2</sup>	kg	mm
SH2281-5671	SH2281-5631	0.07	0.5	10.5	7.2	0.01	0.11	32
SH2281-5771	SH2281-5731	0.07	1	2.6	1.85	0.01	0.11	32
SH2285-5671	SH2285-5631	0.145	0.5	15	13.5	0.022	0.2	51.5
SH2285-5771	SH2285-5731	0.145	1	3.75	3.4	0.022	0.2	51.5

## Characteristics diagram

### SH2281-5671 SH2281-5631

Constant current circuit  
Source voltage: 24 VDC  
Operating current:  
0.5 A/phase, 2-phase  
energization (full-step)  
Pull-out torque:  
 $J_L=0.01 \times 10^{-4}$ kg·m<sup>2</sup> (pulley  
balancer method)  
fs: Maximum self-start  
frequency when not  
loaded

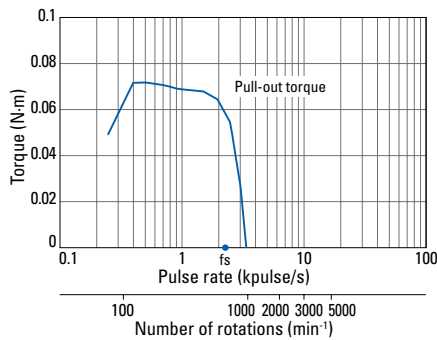

### SH2281-5771 SH2281-5731

Constant current circuit  
Source voltage: 24 VDC  
Operating current:  
1 A/phase, 2-phase  
energization (full-step)  
Pull-out torque:  
 $J_L=0.01 \times 10^{-4}$ kg·m<sup>2</sup> (pulley  
balancer method)  
fs: Maximum self-start  
frequency when not  
loaded

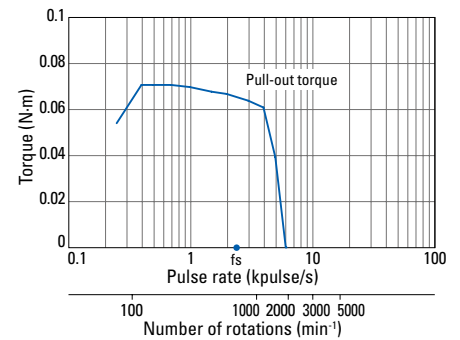

### SH2285-5671 SH2285-5631

Constant current circuit  
Source voltage: 24 VDC  
Operating current:  
0.5 A/phase, 2-phase  
energization (full-step)  
Pull-out torque:  
 $J_L=0.01 \times 10^{-4}$ kg·m<sup>2</sup> (pulley  
balancer method)  
fs: Maximum self-start  
frequency when not  
loaded

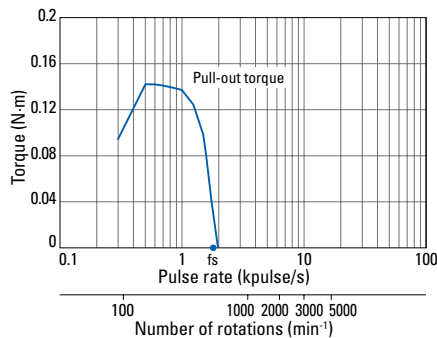

### SH2285-5771 SH2285-5731

Constant current circuit  
Source voltage: 24 VDC  
Operating current:  
1 A/phase, 2-phase  
energization (full-step)  
Pull-out torque:  
 $J_L=0.01 \times 10^{-4}$ kg·m<sup>2</sup> (pulley  
balancer method)  
fs: Maximum self-start  
frequency when not  
loaded

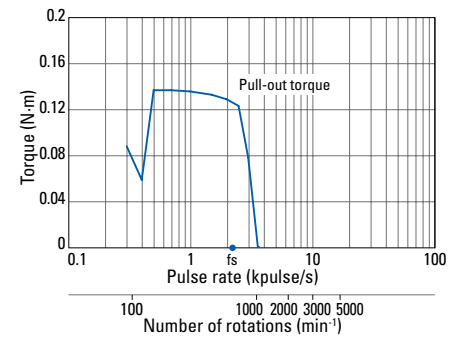

## Dimensions (Unit: mm)

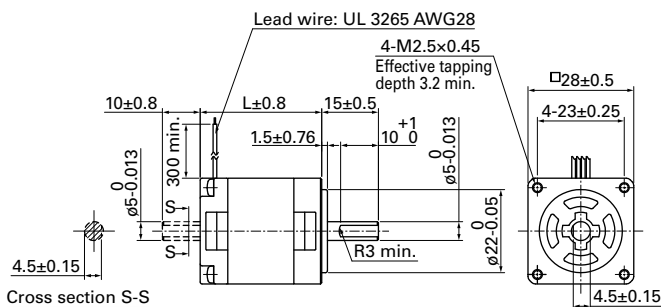

## Internal wiring

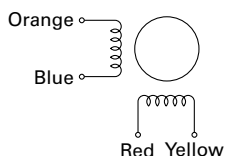

## Compatible drivers

- For motor model no. SH228 □ -56 □ 1 (0.5 A/phase)  
Driver is not included.  
If you require assistance finding a driver, contact us for details.
- For model no. SH228 □ -57 □ 1 (1 A/phase)  
Model no.: BS1D200P10 (DC input)  
Operating current select switch setting: A  
*The characteristics diagram shown above is from our experimental circuit.*



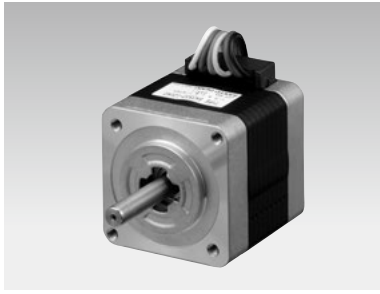

# 35 mm sq.

1.8°/step RoHS

Unipolar winding, Lead wire type

### Customizing

Hollow Shaft modification

Varies depending on the model number and quantity. Contact us for details.

### Unipolar winding, Lead wire type

Model no.		Holding torque at 2-phase energization	Rated current	Wiring resistance	Winding inductance	Rotor inertia	Mass	Motor length (L)
Single shaft	Dual shaft	N·m min.	A/phase	Ω/phase	mH/phase	$\times 10^{-4}$ kg·m <sup>2</sup>	kg	mm
<b>SH3533-12U40</b>	<b>SH3533-12U10</b>	0.12	1.2	2.4	1.3	0.02	0.17	33
<b>SH3537-12U40</b>	<b>SH3537-12U10</b>	0.15	1.2	2.7	2	0.025	0.2	37
<b>SH3552-12U40</b>	<b>SH3552-12U10</b>	0.23	1.2	3.4	2.8	0.043	0.3	52

### Characteristics diagram

#### SH3533-12U40 SH3533-12U10

Constant current circuit  
Source voltage: 24 VDC  
Operating current:  
1.2 A/phase, 2-phase  
energization (full-step)  
Pull-out torque:  
 $J_L=0.33 \times 10^{-4}$ kg·m<sup>2</sup> (use the  
rubber coupling)  
fs: Maximum self-start  
frequency when not  
loaded

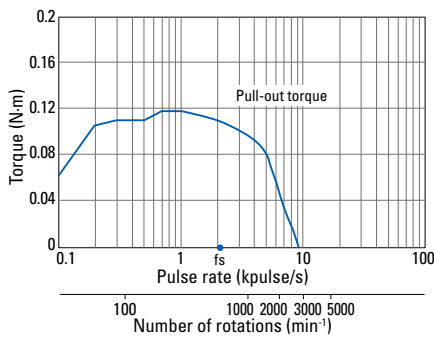

#### SH3537-12U40 SH3537-12U10

Constant current circuit  
Source voltage: 24 VDC  
Operating current:  
1.2 A/phase, 2-phase  
energization (full-step)  
Pull-out torque:  
 $J_L=0.33 \times 10^{-4}$ kg·m<sup>2</sup> (use the  
rubber coupling)  
fs: Maximum self-start  
frequency when not  
loaded

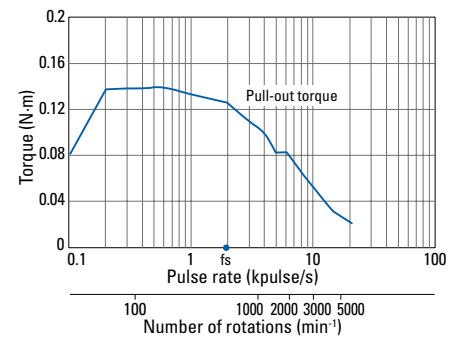

#### SH3552-12U40 SH3552-12U10

Constant current circuit  
Source voltage: 24 VDC  
Operating current:  
1.2 A/phase, 2-phase  
energization (full-step)  
Pull-out torque:  
 $J_L=0.94 \times 10^{-4}$ kg·m<sup>2</sup> (use the  
rubber coupling)  
fs: Maximum self-start  
frequency when not  
loaded

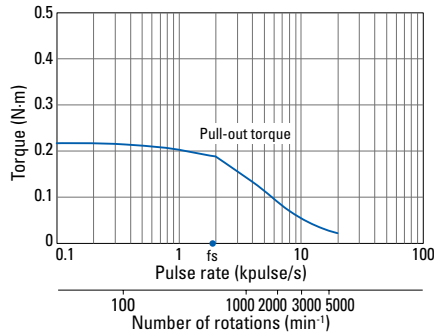

### Dimensions (Unit: mm)

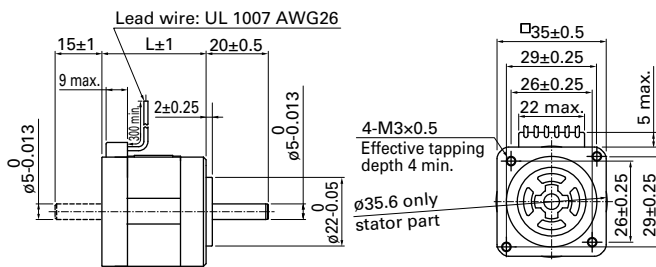

### Internal wiring

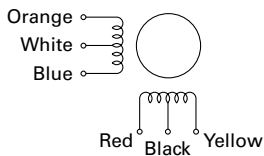

### Compatible drivers

Model no.: US1D200P10 (DC input)

Operating current select switch setting: 8

*The characteristics diagram shown above is from our experimental circuit.*



# 42 mm sq.

0.9°/step RoHS

Unipolar winding, Lead wire type  
Bipolar winding, Lead wire type

### Customizing

- Hollow Shaft modification
- Decelerator Encoder

Varies depending on the model number and quantity. Contact us for details.

### Unipolar winding, Lead wire type

Model no.		Holding torque at 2-phase energization	Rated current	Wiring resistance	Winding inductance	Rotor inertia	Mass	Motor length (L)
Single shaft	Dual shaft	N·m min.	A/phase	Ω/phase	mH/phase	$\times 10^{-4}$ kg·m <sup>2</sup>	kg	mm
SH1421-0441	SH1421-0411	0.2	1.2	2.7	3.2	0.044	0.24	33
SH1422-0441	SH1422-0411	0.29	1.2	3.1	5.3	0.066	0.29	39
SH1424-0441	SH1424-0411	0.39	1.2	3.5	5.3	0.089	0.38	48

## Characteristics diagram

### SH1421-0441 SH1421-0411

Constant current circuit  
Source voltage: 24 VDC  
Operating current:  
1.2 A/phase, 2-phase  
energization (full-step)  
Pull-out torque:  
 $J_L=0.94 \times 10^{-4}$ kg·m<sup>2</sup> (use the  
rubber coupling)  
fs: Maximum self-start  
frequency when not  
loaded

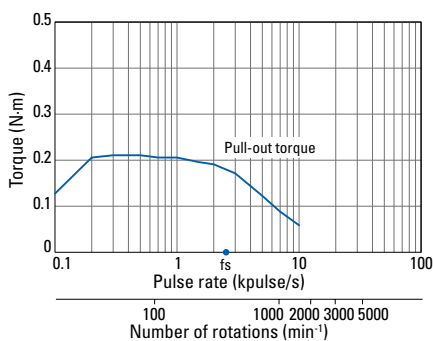

### SH1422-0441 SH1422-0411

Constant current circuit  
Source voltage: 24 VDC  
Operating current:  
1.2 A/phase, 2-phase  
energization (full-step)  
Pull-out torque:  
 $J_L=0.94 \times 10^{-4}$ kg·m<sup>2</sup> (use the  
rubber coupling)  
fs: Maximum self-start  
frequency when not  
loaded

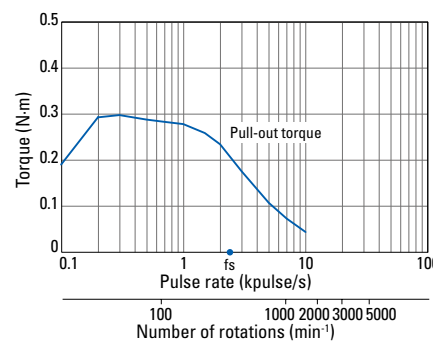

### SH1424-0441 SH1424-0411

Constant current circuit  
Source voltage: 24 VDC  
Operating current:  
1.2 A/phase, 2-phase  
energization (full-step)  
Pull-out torque:  
 $J_L=0.94 \times 10^{-4}$ kg·m<sup>2</sup> (use the  
rubber coupling)  
fs: Maximum self-start  
frequency when not  
loaded

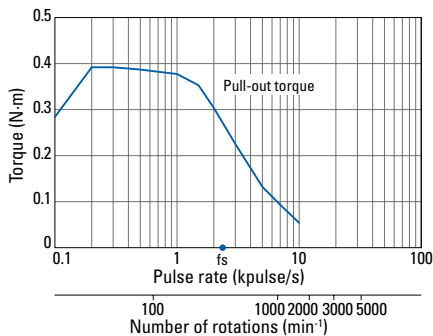

## Dimensions (Unit: mm)

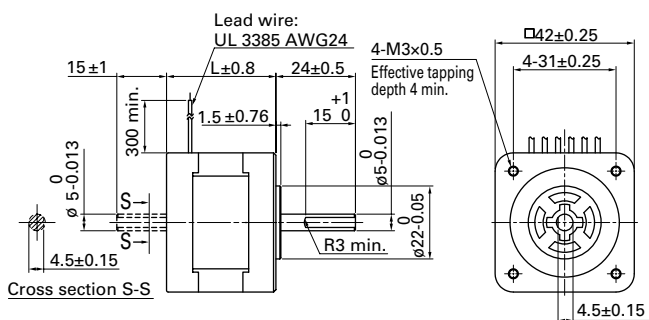

## Internal wiring

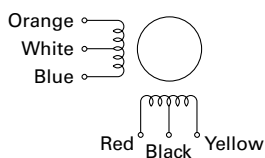

## Compatible drivers

Model no.: US1D200P10 (DC input)

Operating current select switch setting: 8

*The characteristics diagram shown above is from our experimental circuit.*

**Bipolar winding, Lead wire type**

Model no.		Holding torque at 2-phase energization	Rated current	Wiring resistance	Winding inductance	Rotor inertia	Mass	Motor length (L)
Single shaft	Dual shaft	N·m min.	A/phase	Ω/phase	mH/phase	$\times 10^{-4}$ kg·m <sup>2</sup>	kg	mm
SH1421-5041	SH1421-5011	0.23	1	3.3	8.0	0.044	0.24	33
SH1421-5241	SH1421-5211	0.23	2	0.85	2.1	0.044	0.24	33
SH1422-5041	SH1422-5011	0.34	1	4.0	14.0	0.066	0.29	39
SH1422-5241	SH1422-5211	0.34	2	1.05	3.6	0.066	0.29	39
SH1424-5041	SH1424-5011	0.48	1	4.7	15.0	0.089	0.38	48
SH1424-5241	SH1424-5211	0.48	2	1.25	3.75	0.089	0.38	48

**Characteristics diagram**

**SH1421-5041  
SH1421-5011**

Constant current circuit  
Source voltage: 24 VDC  
Operating current:  
1 A/phase, 2-phase  
energization (full-step)  
Pull-out torque:  
 $J_L=0.94 \times 10^{-4}$ kg·m<sup>2</sup> (use the  
rubber coupling)  
fs: Maximum self-start  
frequency when not  
loaded

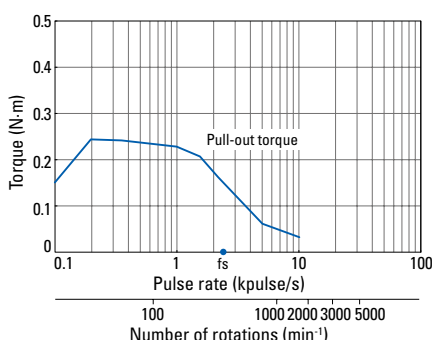

**SH1421-5241  
SH1421-5211**

Constant current circuit  
Source voltage: 24 VDC  
Operating current:  
2 A/phase, 2-phase  
energization (full-step)  
Pull-out torque:  
 $J_L=0.94 \times 10^{-4}$ kg·m<sup>2</sup> (use the  
rubber coupling)  
fs: Maximum self-start  
frequency when not  
loaded

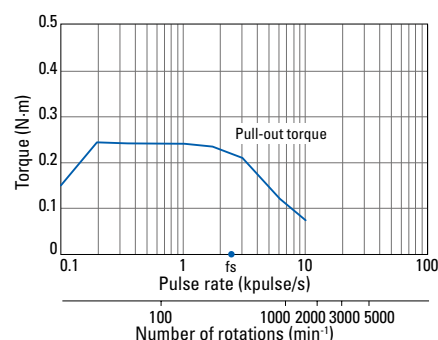

**SH1422-5041  
SH1422-5011**

Constant current circuit  
Source voltage: 24 VDC  
Operating current:  
1 A/phase, 2-phase  
energization (full-step)  
Pull-out torque:  
 $J_L=0.94 \times 10^{-4}$ kg·m<sup>2</sup> (use the  
rubber coupling)  
fs: Maximum self-start  
frequency when not  
loaded

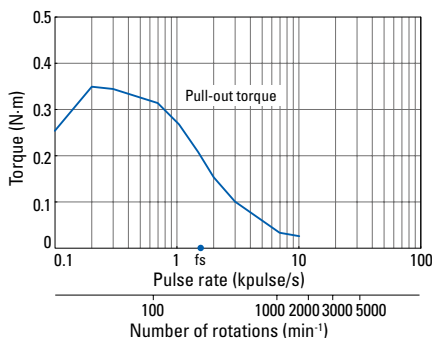

**SH1422-5241  
SH1422-5211**

Constant current circuit  
Source voltage: 24 VDC  
Operating current:  
2 A/phase, 2-phase  
energization (full-step)  
Pull-out torque:  
 $J_L=0.94 \times 10^{-4}$ kg·m<sup>2</sup> (use the  
rubber coupling)  
fs: Maximum self-start  
frequency when not  
loaded

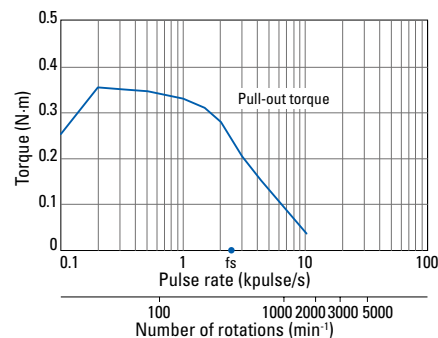

**SH1424-5041  
SH1424-5011**

Constant current circuit  
Source voltage: 24 VDC  
Operating current:  
1 A/phase, 2-phase  
energization (full-step)  
Pull-out torque:  
 $J_L=0.94 \times 10^{-4}$ kg·m<sup>2</sup> (use the  
rubber coupling)  
fs: Maximum self-start  
frequency when not  
loaded

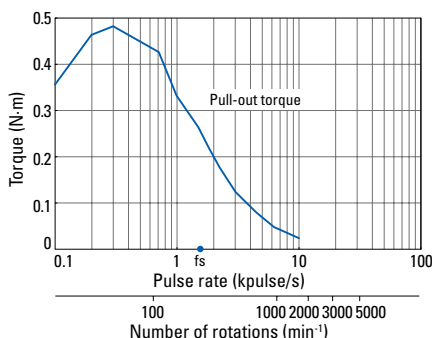

**SH1424-5241  
SH1424-5211**

Constant current circuit  
Source voltage: 24 VDC  
Operating current:  
2 A/phase, 2-phase  
energization (full-step)  
Pull-out torque:  
 $J_L=0.94 \times 10^{-4}$ kg·m<sup>2</sup> (use the  
rubber coupling)  
fs: Maximum self-start  
frequency when not  
loaded

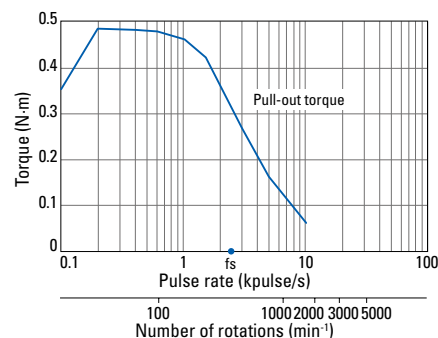

**Dimensions (Unit: mm)**

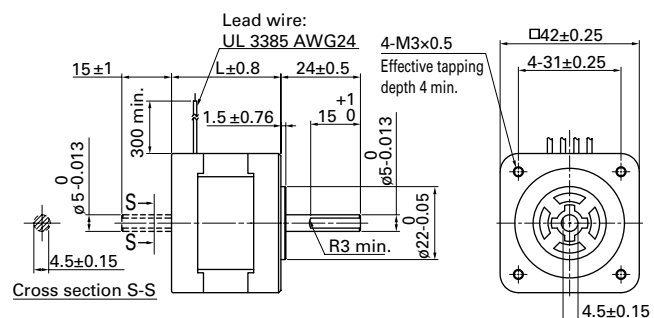

**Internal wiring**

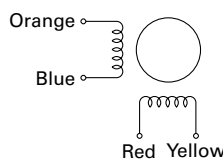

**Compatible drivers**

- For motor model no. SH142 □ -50 □ 1 (1 A/phase)  
Driver is not included.  
If you require assistance finding a driver, contact us for details.
- For model no. SH142 □ -52 □ 1 (2 A/phase)  
Model no.: BS1D200P10 (DC input)  
Operating current select switch setting: 0

The characteristics diagram shown above is from our experimental circuit.

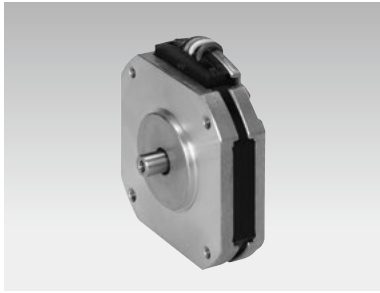

## 42 mm sq.

1.8°/step **Slim form** **RoHS**  
Bipolar winding, Lead wire type

### Customizing

**Hollow** **Shaft modification**

Varies depending on the model number and quantity. Contact us for details.

### Bipolar winding, Lead wire type

Model no.		Holding torque at 2-phase energization	Rated current	Wiring resistance	Winding inductance	Rotor inertia	Mass	Motor length (L)
Single shaft	Dual shaft	N·m min.	A/phase	Ω/phase	mH/phase	$\times 10^{-4}$ kg·m <sup>2</sup>	kg	mm
<b>SS2421-5041</b>	<b>SS2421-5011</b>	0.083	1	3.5	1.2	0.015	0.07	11.6
<b>SS2422-5041</b>	<b>SS2422-5011</b>	0.186	1	5.4	2.9	0.028	0.14	18.6

## Characteristics diagram

### SS2421-5041 SS2421-5011

Constant current circuit  
Source voltage: 24 VDC  
Operating current:  
1 A/phase, 2-phase  
energization (full-step)  
Pull-out torque:  
 $J_L=0.33 \times 10^{-4}$  kg·m<sup>2</sup> (use the  
rubber coupling)  
fs: Maximum self-start  
frequency when not  
loaded

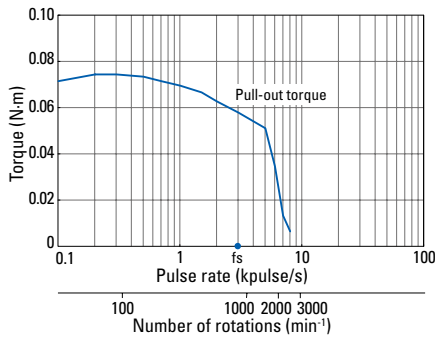

### SS2422-5041 SS2422-5011

Constant current circuit  
Source voltage: 24 VDC  
Operating current:  
1 A/phase, 2-phase  
energization (full-step)  
Pull-out torque:  
 $J_L=0.33 \times 10^{-4}$  kg·m<sup>2</sup> (use the  
rubber coupling)  
fs: Maximum self-start  
frequency when not  
loaded

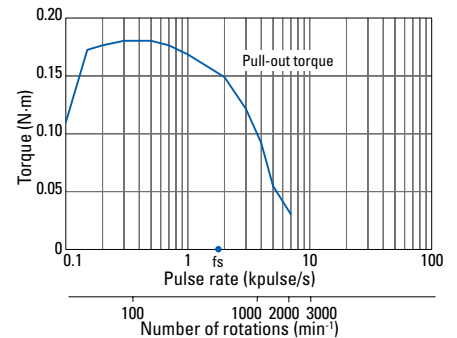

## Dimensions (Unit: mm)

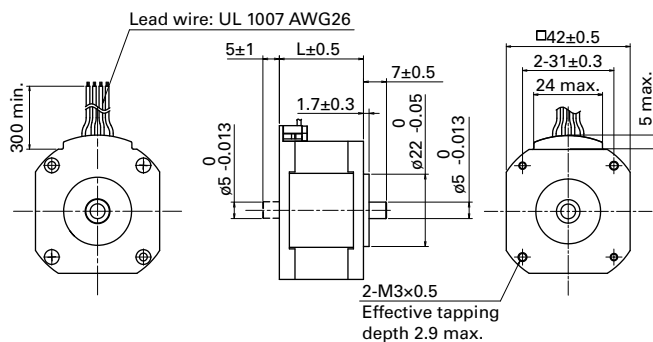

## Internal wiring

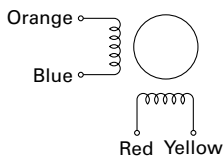

## Compatible drivers

Driver is not included.

If you require assistance finding a driver, contact us for details.

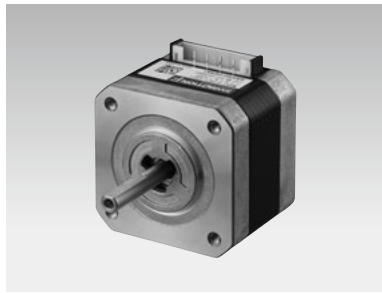

# 42 mm sq.

1.8°/step **RoHS**

Unipolar winding, Connector type  
Bipolar winding, Connector type ▶ p. 46

### Customizing

Shaft length Shaft shape

Varies depending on the model number and quantity. Contact us for details.

### Unipolar winding, Connector type

Model no.		Holding torque at 2-phase energization	Rated current	Wiring resistance	Winding inductance	Rotor inertia	Mass	Motor length (L)
Single shaft	Dual shaft	N·m min.	A/phase	Ω/phase	mH/phase	×10 <sup>-4</sup> kg·m <sup>2</sup>	kg	mm
SF2421-12U41	SF2421-12U11	0.22	1.2	2.4	2.4	0.031	0.23	33±0.5
SF2422-12U41	SF2422-12U11	0.33	1.2	3	3.3	0.046	0.3	39±0.5
SF2423-12U41	SF2423-12U11	0.4	1.2	3.4	3.9	0.063	0.38	48±0.5
SF2424-12U41	SF2424-12U11	0.58	1.2	4.4	5.4	0.094	0.51	59.5±1

Motor cable: model no. 4835710-1

## Characteristics diagram

### SF2421-12U41 SF2421-12U11

Constant current circuit  
Source voltage: 24 VDC  
Operating current:  
1.2 A/phase, 2-phase  
energization (full-step)  
Pull-out torque:  
 $J_s=0.94 \times 10^{-4}$  kg·m<sup>2</sup> (use the  
rubber coupling)  
fs: Maximum self-start  
frequency when not  
loaded

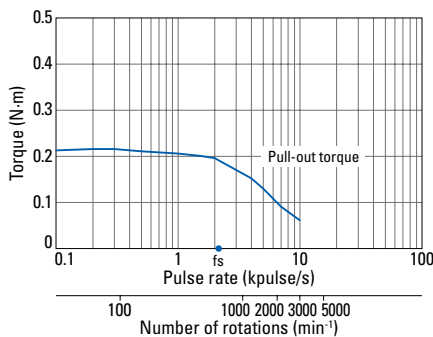

### SF2422-12U41 SF2422-12U11

Constant current circuit  
Source voltage: 24 VDC  
Operating current:  
1.2 A/phase, 2-phase  
energization (full-step)  
Pull-out torque:  
 $J_s=0.94 \times 10^{-4}$  kg·m<sup>2</sup> (use the  
rubber coupling)  
fs: Maximum self-start  
frequency when not  
loaded

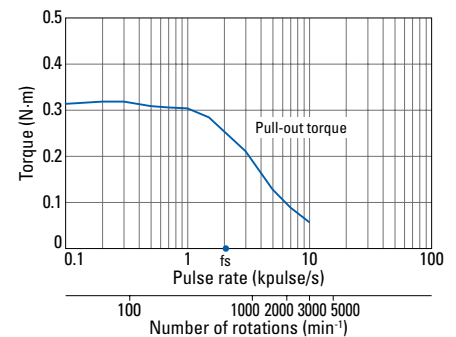

### SF2423-12U41 SF2423-12U11

Constant current circuit  
Source voltage: 24 VDC  
Operating current:  
1.2 A/phase, 2-phase  
energization (full-step)  
Pull-out torque:  
 $J_s=0.94 \times 10^{-4}$  kg·m<sup>2</sup> (use the  
rubber coupling)  
fs: Maximum self-start  
frequency when not  
loaded

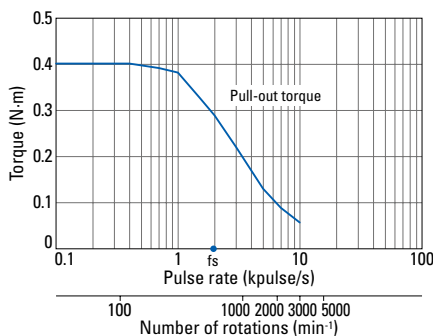

### SF2424-12U41 SF2424-12U11

Constant current circuit  
Source voltage: 24 VDC  
Operating current:  
1.2 A/phase, 2-phase  
energization (full-step)  
Pull-out torque:  
 $J_s=0.94 \times 10^{-4}$  kg·m<sup>2</sup> (use the  
rubber coupling)  
fs: Maximum self-start  
frequency when not  
loaded

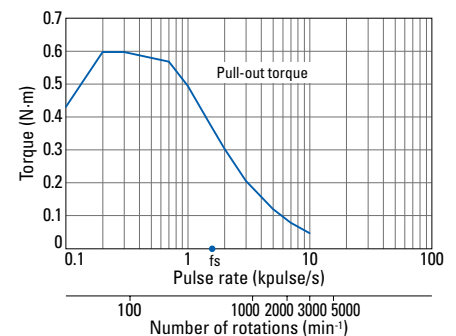

## Dimensions (Unit: mm)

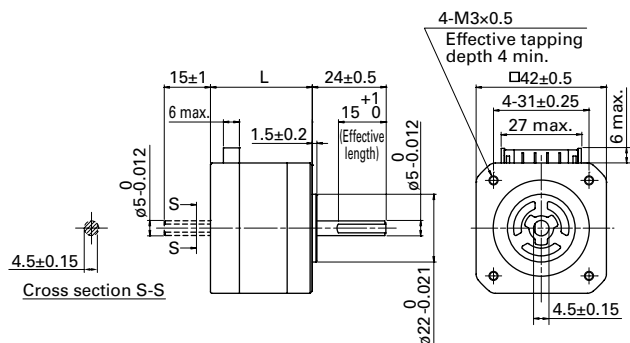

Option (sold separately): Motor cable model no. 4835774-1

Manufacturer: J.S.T.  
Housing: PHR-11  
Pin: SPH-002T-P0.5S

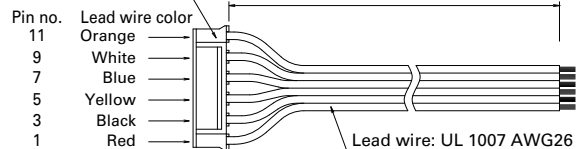

This motor cable is for model no. SF242□-12U□1.

## Internal wiring ( ) connector pin number

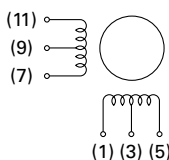

## Compatible drivers

Model no.: US1D200P10

Operating current select switch setting: 8

The characteristics diagram shown above is from our experimental circuit.

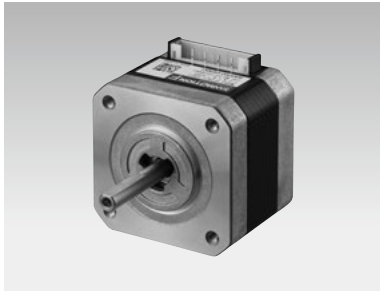

# 42 mm sq.

1.8°/step **RoHS**

Bipolar winding, Connector type  
Unipolar winding, Connector type ▶ p. 45

### Customizing

[Shaft length](#) [Shaft shape](#)

Varies depending on the model number and quantity. Contact us for details.

### Bipolar winding, Connector type

Model no.		Holding torque at 2-phase energization	Rated current	Wiring resistance	Winding inductance	Rotor inertia	Mass	Motor length (L)
Single shaft	Dual shaft	N·m min.	A/phase	Ω/phase	mH/phase	$\times 10^{-4}$ kg·m <sup>2</sup>	kg	mm
<b>SF2421-10B41</b>	<b>SF2421-10B11</b>	0.29	1	3.6	7	0.031	0.23	33±0.5
<b>SF2422-10B41</b>	<b>SF2422-10B11</b>	0.43	1	4.6	9.6	0.046	0.3	39±0.5
<b>SF2423-10B41</b>	<b>SF2423-10B11</b>	0.56	1	5.3	12.5	0.063	0.38	48±0.5
<b>SF2424-10B41</b>	<b>SF2424-10B11</b>	0.8	1	6.5	16	0.094	0.51	59.5±1

## Characteristics diagram

### SF2421-10B41 SF2421-10B11

Constant current circuit  
Source voltage: 24 VDC  
Operating current:  
1 A/phase, 2-phase  
energization (full-step)  
Pull-out torque:  
 $J_L=0.94 \times 10^{-4}$ kg·m<sup>2</sup> (use the  
rubber coupling)  
fs: Maximum self-start  
frequency when not  
loaded

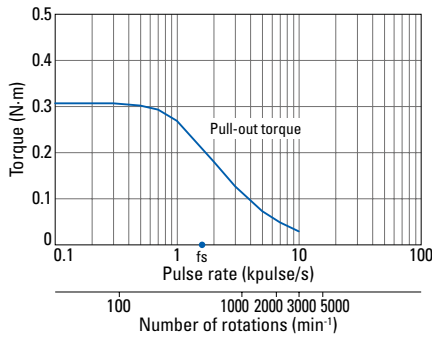

### SF2422-10B41 SF2422-10B11

Constant current circuit  
Source voltage: 24 VDC  
Operating current:  
1 A/phase, 2-phase  
energization (full-step)  
Pull-out torque:  
 $J_L=0.94 \times 10^{-4}$ kg·m<sup>2</sup> (use the  
rubber coupling)  
fs: Maximum self-start  
frequency when not  
loaded

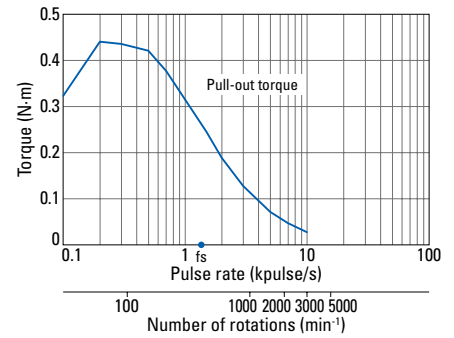

### SF2423-10B41 SF2423-10B11

Constant current circuit  
Source voltage: 24 VDC  
Operating current:  
1 A/phase, 2-phase  
energization (full-step)  
Pull-out torque:  
 $J_L=0.94 \times 10^{-4}$ kg·m<sup>2</sup> (use the  
rubber coupling)  
fs: Maximum self-start  
frequency when not  
loaded

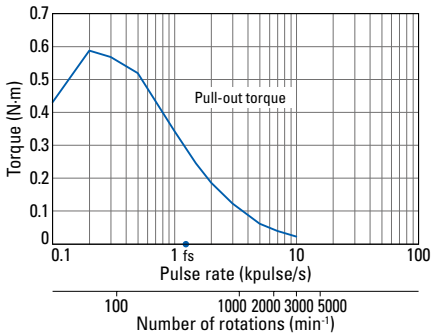

### SF2424-10B41 SF2424-10B11

Constant current circuit  
Source voltage: 24 VDC  
Operating current:  
1 A/phase, 2-phase  
energization (full-step)  
Pull-out torque:  
 $J_L=2.6 \times 10^{-4}$ kg·m<sup>2</sup> (use the  
rubber coupling)  
fs: Maximum self-start  
frequency when not  
loaded

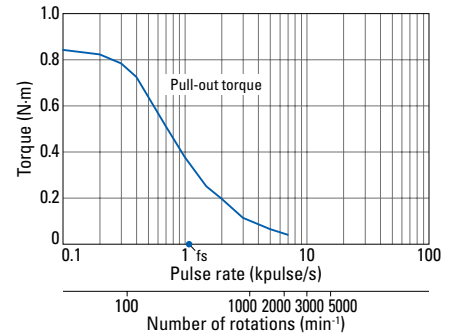

## Dimensions (Unit: mm)

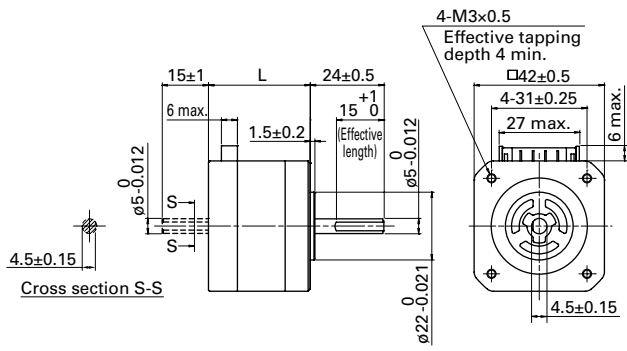

Option (sold separately): Motor cable model no. 4835775-1

Manufacturer: J.S.T.  
Housing: PHR-11  
Pin: SPH-002T-P0.5S

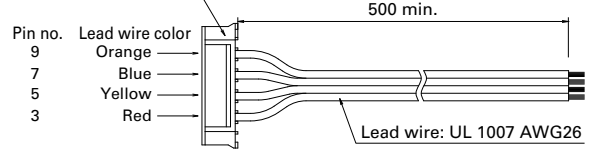

This motor cable is for model no. SF242□-10B□1.

## Internal wiring ( ) connector pin number

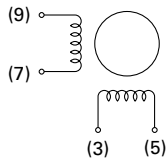

## Compatible drivers

Model no.: BS1D200P10

Operating current select switch setting: A

*The characteristics diagram shown above is from our experimental circuit.*

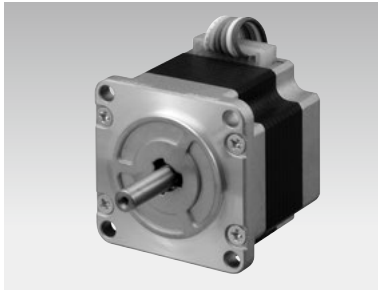

## 50 mm sq.

1.8°/step RoHS

Unipolar winding, Lead wire type

Bipolar winding, Lead wire type ▶ p. 50

### Customizing

Hollow Shaft modification

Varies depending on the model number and quantity. Contact us for details.

### Unipolar winding, Lead wire type

Model no.		Holding torque at 2-phase energization	Rated current	Wiring resistance	Winding inductance	Rotor inertia	Mass	Motor length (L)
Single shaft	Dual shaft	N·m min.	A/phase	Ω/phase	mH/phase	$\times 10^{-4}$ kg·m <sup>2</sup>	kg	mm
<b>103H6701-0140</b>	<b>103H6701-0110</b>	0.28	1	4.3	6.8	0.057	0.35	39.8
<b>103H6701-0440</b>	<b>103H6701-0410</b>	0.28	2	1.1	1.6	0.057	0.35	39.8
<b>103H6701-0740</b>	<b>103H6701-0710</b>	0.28	3	0.6	0.7	0.057	0.35	39.8
<b>103H6703-0140</b>	<b>103H6703-0110</b>	0.49	1	6	13	0.118	0.5	51.3
<b>103H6703-0440</b>	<b>103H6703-0410</b>	0.49	2	1.6	3.2	0.118	0.5	51.3
<b>103H6703-0740</b>	<b>103H6703-0710</b>	0.49	3	0.83	1.4	0.118	0.5	51.3
<b>103H6704-0140</b>	<b>103H6704-0110</b>	0.52	1	6.5	16.5	0.14	0.55	55.8
<b>103H6704-0440</b>	<b>103H6704-0410</b>	0.52	2	1.7	3.8	0.14	0.55	55.8
<b>103H6704-0740</b>	<b>103H6704-0710</b>	0.53	3	0.9	1.7	0.14	0.55	55.8

## Characteristics diagram

### 103H6701-0140 103H6701-0110

Constant current circuit  
Source voltage: 24 VDC  
Operating current:  
1 A/phase, 2-phase  
energization (full-step)  
Pull-out torque:  
 $J_L=0.94 \times 10^{-4}$ kg·m<sup>2</sup> (use the  
rubber coupling)  
 $f_s$ : Maximum self-start  
frequency when not  
loaded

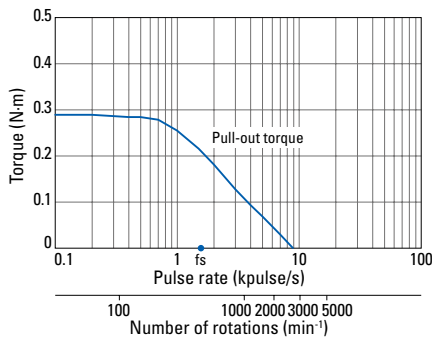

### 103H6701-0440 103H6701-0410

Constant current circuit  
Source voltage: 24 VDC  
Operating current:  
2 A/phase, 2-phase  
energization (full-step)  
Pull-out torque:  
 $J_L=0.94 \times 10^{-4}$ kg·m<sup>2</sup> (use the  
rubber coupling)  
 $f_s$ : Maximum self-start  
frequency when not  
loaded

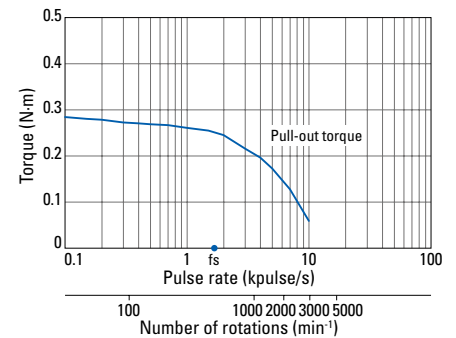

### 103H6701-0740 103H6701-0710

Constant current circuit  
Source voltage: 24 VDC  
Operating current:  
3 A/phase, 2-phase  
energization (full-step)  
Pull-out torque:  
 $J_L=0.94 \times 10^{-4}$ kg·m<sup>2</sup> (use the  
rubber coupling)  
 $f_s$ : Maximum self-start  
frequency when not  
loaded

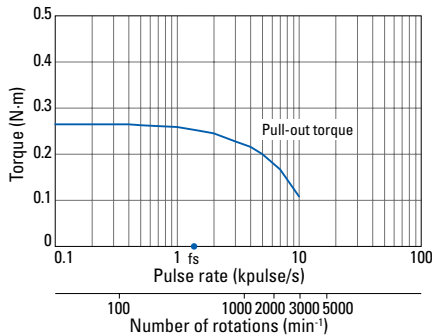

### 103H6703-0140 103H6703-0110

Constant current circuit  
Source voltage: 24 VDC  
Operating current:  
1 A/phase, 2-phase  
energization (full-step)  
Pull-out torque:  
 $J_L=0.94 \times 10^{-4}$ kg·m<sup>2</sup> (use the  
rubber coupling)  
 $f_s$ : Maximum self-start  
frequency when not  
loaded

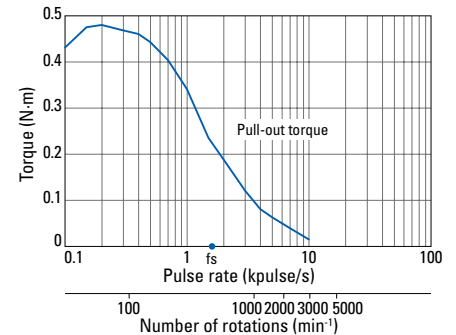

### 103H6703-0440 103H6703-0410

Constant current circuit  
Source voltage: 24 VDC  
Operating current:  
2 A/phase, 2-phase  
energization (full-step)  
Pull-out torque:  
 $J_L=0.94 \times 10^{-4}$ kg·m<sup>2</sup> (use the  
rubber coupling)  
 $f_s$ : Maximum self-start  
frequency when not  
loaded

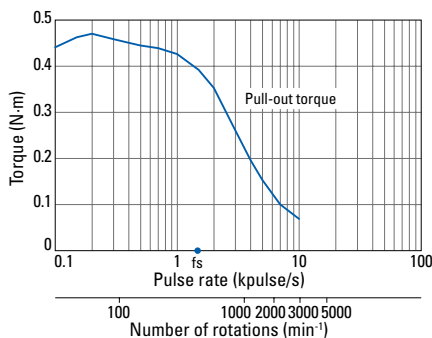

### 103H6703-0740 103H6703-0710

Constant current circuit  
Source voltage: 24 VDC  
Operating current:  
3 A/phase, 2-phase  
energization (full-step)  
Pull-out torque:  
 $J_L=0.94 \times 10^{-4}$ kg·m<sup>2</sup> (use the  
rubber coupling)  
 $f_s$ : Maximum self-start  
frequency when not  
loaded

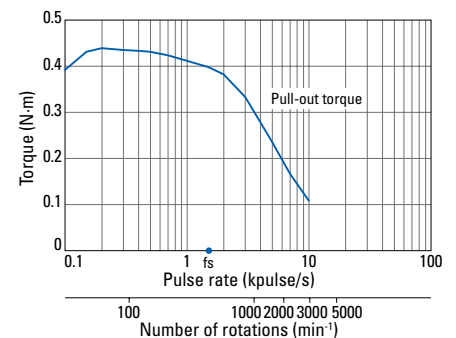



## Characteristics diagram

**103H6704-0140**  
**103H6704-0110**

Constant current circuit  
Source voltage: 24 VDC  
Operating current:  
1 A/phase, 2-phase  
energization (full-step)  
Pull-out torque:  
 $J_L=0.94 \times 10^{-4} \text{ kg} \cdot \text{m}^2$  (use the  
rubber coupling)  
fs: Maximum self-start  
frequency when not  
loaded

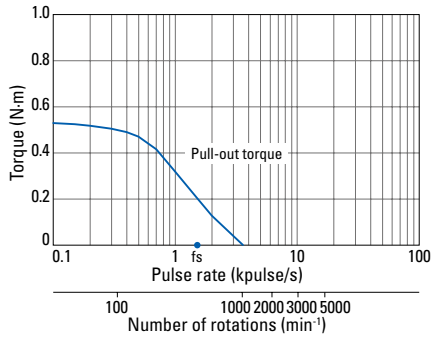

**103H6704-0440**  
**103H6704-0410**

Constant current circuit  
Source voltage: 24 VDC  
Operating current:  
2 A/phase, 2-phase  
energization (full-step)  
Pull-out torque:  
 $J_L=0.94 \times 10^{-4} \text{ kg} \cdot \text{m}^2$  (use the  
rubber coupling)  
fs: Maximum self-start  
frequency when not  
loaded

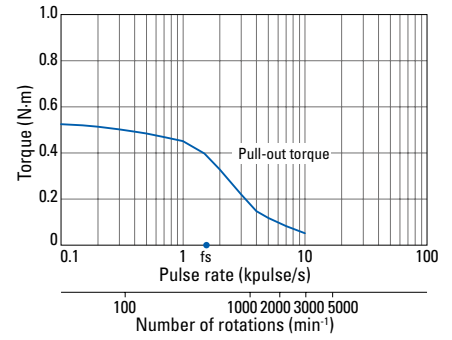

**103H6704-0740**  
**103H6704-0710**

Constant current circuit  
Source voltage: 24 VDC  
Operating current:  
3 A/phase, 2-phase  
energization (full-step)  
Pull-out torque:  
 $J_L=0.94 \times 10^{-4} \text{ kg} \cdot \text{m}^2$  (use the  
rubber coupling)  
fs: Maximum self-start  
frequency when not  
loaded

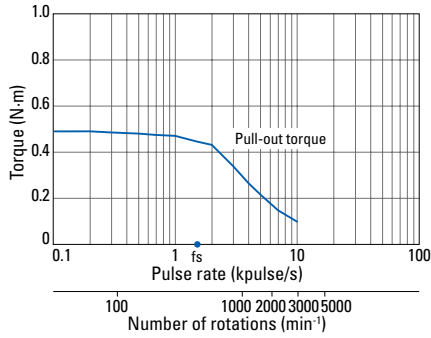

## Dimensions (Unit: mm)

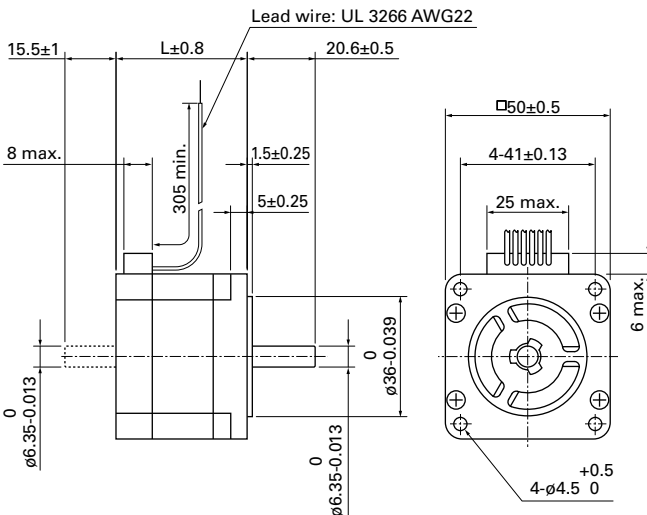

## Internal wiring

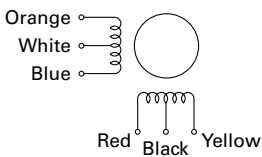

## Compatible drivers

- For motor model no. 103H670 □ -01 □ 0 (1 A/phase),  
103H670 □ -07 □ 0 (3 A/phase)

Driver is not included.

If you require assistance finding a driver, contact us for  
details.

- For model no. 103H670 □ -04 □ 0 (2 A/phase)  
Model no.: US1D200P10 (DC input)

Operating current select switch setting: 0

*The characteristics diagram shown above is from our  
experimental circuit.*

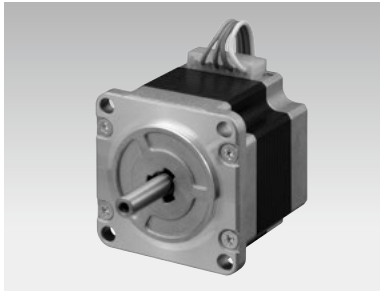

## 50 mm sq.

1.8°/step RoHS

Bipolar winding, Lead wire type  
Unipolar winding, Lead wire type ▶ p. 48

### Customizing

Hollow Shaft modification

Varies depending on the model number and quantity. Contact us for details.

### Bipolar winding, Lead wire type

Model no.		Holding torque at 2-phase energization	Rated current	Wiring resistance	Winding inductance	Rotor inertia	Mass	Motor length (L)
Single shaft	Dual shaft	N·m min.	A/phase	Ω/phase	mH/phase	$\times 10^{-4}$ kg·m <sup>2</sup>	kg	mm
<b>103H6701-5040</b>	<b>103H6701-5010</b>	0.28	2	0.6	1.6	0.057	0.35	39.8
<b>103H6703-5040</b>	<b>103H6703-5010</b>	0.49	2	0.8	3.2	0.118	0.5	51.3
<b>103H6704-5040</b>	<b>103H6704-5010</b>	0.52	2	0.9	3.8	0.14	0.55	55.8

## Characteristics diagram

### 103H6701-5040 103H6701-5010

Constant current circuit  
Source voltage: 24 VDC  
Operating current:  
2 A/phase, 2-phase  
energization (full-step)  
Pull-out torque:  
 $J_L=0.94 \times 10^{-4}$ kg·m<sup>2</sup> (use the  
rubber coupling)  
fs: Maximum self-start  
frequency when not  
loaded

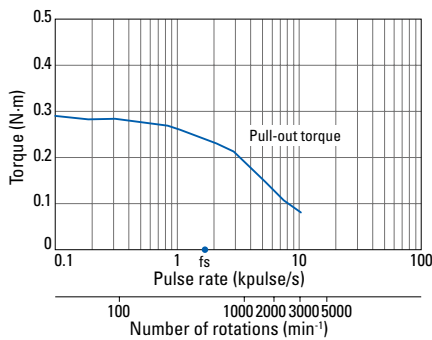

### 103H6703-5040 103H6703-5010

Constant current circuit  
Source voltage: 24 VDC  
Operating current:  
2 A/phase, 2-phase  
energization (full-step)  
Pull-out torque:  
 $J_L=0.94 \times 10^{-4}$ kg·m<sup>2</sup> (use the  
rubber coupling)  
fs: Maximum self-start  
frequency when not  
loaded

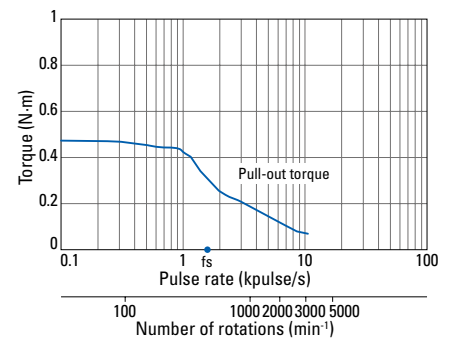

### 103H6704-5040 103H6704-5010

Constant current circuit  
Source voltage: 24 VDC  
Operating current:  
2 A/phase, 2-phase  
energization (full-step)  
Pull-out torque:  
 $J_L=0.94 \times 10^{-4}$ kg·m<sup>2</sup> (use the  
rubber coupling)  
fs: Maximum self-start  
frequency when not  
loaded

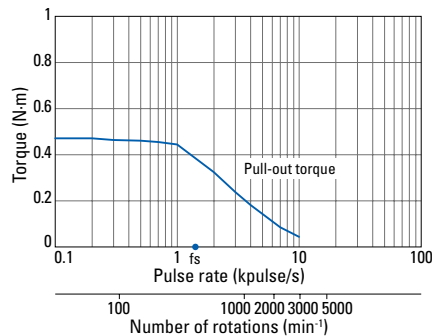

## Dimensions (Unit: mm)

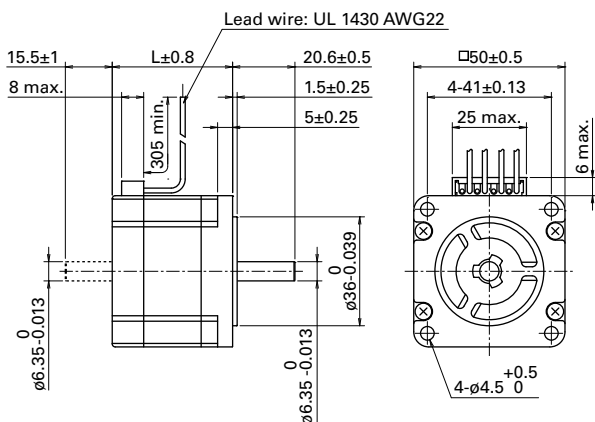

## Internal wiring

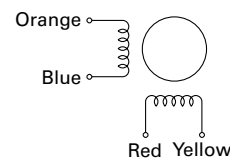

## Compatible drivers

Model no.: BS1D200P10 (DC input)  
Operating current select switch setting: 0  
*The characteristics diagram shown above is from our experimental circuit.*



# 50 mm sq.

1.8°/step **Slim form** **RoHS**

Bipolar winding, Lead wire type

## Customizing

**Hollow** **Shaft modification**

Varies depending on the model number and quantity. Contact us for details.

## Bipolar winding, Lead wire type

Model no.		Holding torque at 2-phase energization	Rated current	Wiring resistance	Winding inductance	Rotor inertia	Mass	Motor length (L)
Single shaft	Dual shaft	N·m min.	A/phase	Ω/phase	mH/phase	$\times 10^{-4}$ kg·m <sup>2</sup>	kg	mm
<b>SS2501-8040</b>	<b>SS2501-8010</b>	0.1	1	4.5	2	0.026	0.09	11.4
<b>SS2502-8040</b>	<b>SS2502-8010</b>	0.215	1	5.9	3.2	0.049	0.15	16.4

## Characteristics diagram

### SS2501-8040 SS2501-8010

Constant current circuit  
Source voltage: 24 VDC  
Operating current:  
1 A/phase, 2-phase  
energization (full-step)  
Pull-out torque:  
 $J_L=0.01 \times 10^{-4}$ kg·m<sup>2</sup> (pulley  
balancer method)  
fs: Maximum self-start  
frequency when not  
loaded

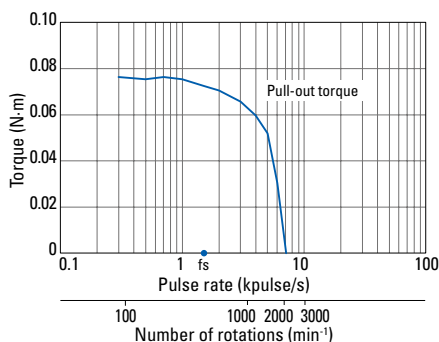

### SS2502-8040 SS2502-8010

Constant current circuit  
Source voltage: 24 VDC  
Operating current:  
1 A/phase, 2-phase  
energization (full-step)  
Pull-out torque:  
 $J_L=0.01 \times 10^{-4}$ kg·m<sup>2</sup> (pulley  
balancer method)  
fs: Maximum self-start  
frequency when not  
loaded

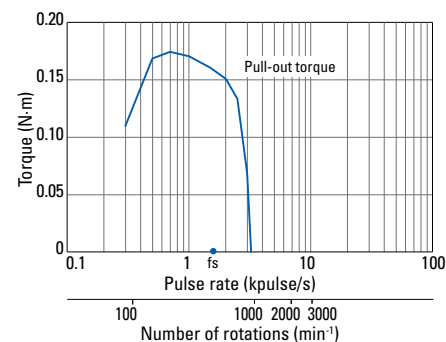

## Dimensions (Unit: mm)

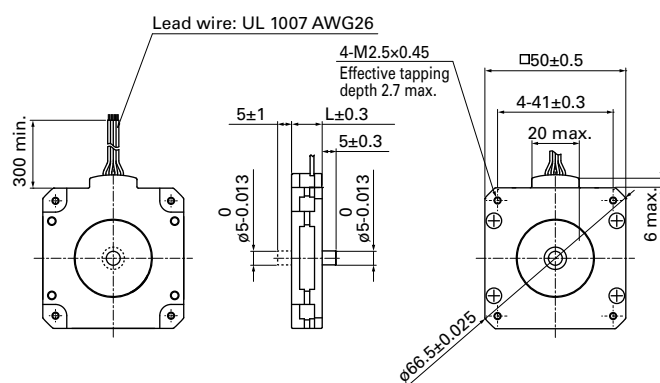

## Internal wiring

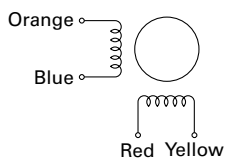

## Compatible drivers

Driver is not included.

If you require assistance finding a driver, contact us for details.

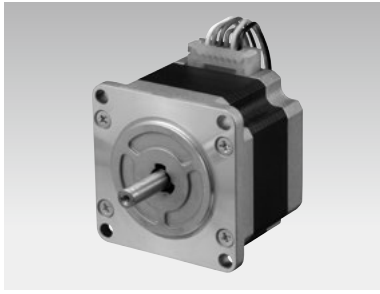

## 56 mm sq.

1.8°/step RoHS

Unipolar winding, Lead wire type  
Bipolar winding, Lead wire type ▶ p. 54

### Customizing

Hollow Shaft modification  
Decelerator Encoder

Varies depending on the model number and quantity. Contact us for details.

### Unipolar winding, Lead wire type

Model no.		Holding torque at 2-phase energization N·m min.	Rated current A/phase	Wiring resistance Ω/phase	Winding inductance mH/phase	Rotor inertia ×10 <sup>-4</sup> kg·m <sup>2</sup>	Mass kg	Motor length (L) mm
Single shaft	Dual shaft							
103H7121-0140	103H7121-0110	0.39	1	4.8	8	0.1	0.47	41.8
103H7121-0440	103H7121-0410	0.39	2	1.25	1.9	0.1	0.47	41.8
103H7121-0740	103H7121-0710	0.39	3	0.6	0.8	0.1	0.47	41.8
103H7123-0140	103H7123-0110	0.83	1	6.7	15	0.21	0.65	53.8
103H7123-0440	103H7123-0410	0.83	2	1.6	3.8	0.21	0.65	53.8
103H7123-0740	103H7123-0710	0.78	3	0.77	1.58	0.21	0.65	53.8
103H7124-0140	103H7124-0110	0.98	1	7	14.5	0.245	0.8	63.8
103H7124-0440	103H7124-0410	0.98	2	1.7	3.1	0.245	0.8	63.8
103H7124-0740	103H7124-0710	0.98	3	0.74	1.4	0.245	0.8	63.8
103H7126-0140	103H7126-0110	1.27	1	8.6	19	0.36	0.98	75.8
103H7126-0440	103H7126-0410	1.27	2	2	4.5	0.36	0.98	75.8
103H7126-0740	103H7126-0710	1.27	3	0.9	2.2	0.36	0.98	75.8

## Characteristics diagram

### 103H7121-0140 103H7121-0110

Constant current circuit  
Source voltage: 24 VDC  
Operating current:  
1 A/phase, 2-phase  
energization (full-step)  
Pull-out torque:  
 $J_L=0.94 \times 10^{-4}$  kg·m<sup>2</sup> (use the  
rubber coupling)  
fs: Maximum self-start  
frequency when not  
loaded

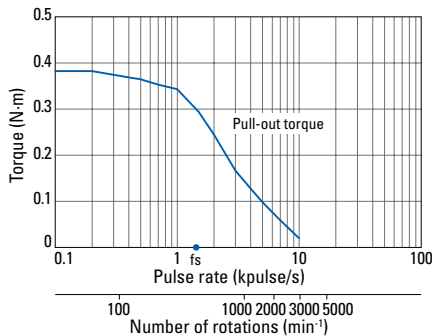

### 103H7121-0440 103H7121-0410

Constant current circuit  
Source voltage: 24 VDC  
Operating current:  
2 A/phase, 2-phase  
energization (full-step)  
Pull-out torque:  
 $J_L=0.94 \times 10^{-4}$  kg·m<sup>2</sup> (use the  
rubber coupling)  
fs: Maximum self-start  
frequency when not  
loaded

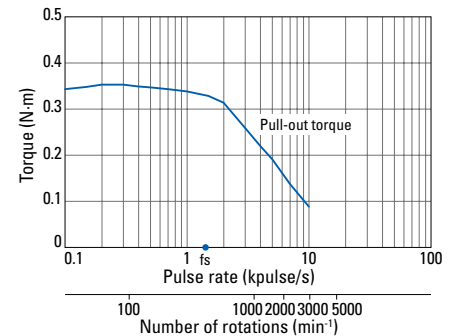

### 103H7121-0740 103H7121-0710

Constant current circuit  
Source voltage: 24 VDC  
Operating current:  
3 A/phase, 2-phase  
energization (full-step)  
Pull-out torque:  
 $J_L=0.94 \times 10^{-4}$  kg·m<sup>2</sup> (use the  
rubber coupling)  
fs: Maximum self-start  
frequency when not  
loaded

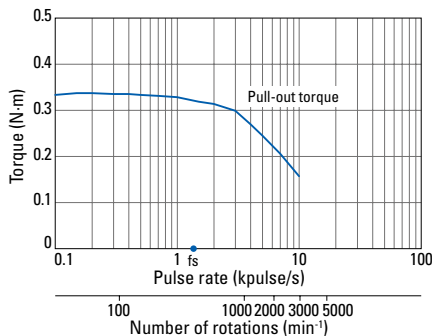

### 103H7123-0140 103H7123-0110

Constant current circuit  
Source voltage: 24 VDC  
Operating current:  
1 A/phase, 2-phase  
energization (full-step)  
Pull-out torque:  
 $J_L=0.94 \times 10^{-4}$  kg·m<sup>2</sup> (use the  
rubber coupling)  
fs: Maximum self-start  
frequency when not  
loaded

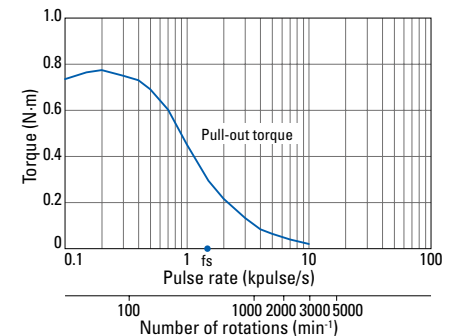

### 103H7123-0440 103H7123-0410

Constant current circuit  
Source voltage: 24 VDC  
Operating current:  
2 A/phase, 2-phase  
energization (full-step)  
Pull-out torque:  
 $J_L=0.94 \times 10^{-4}$  kg·m<sup>2</sup> (use the  
rubber coupling)  
fs: Maximum self-start  
frequency when not  
loaded

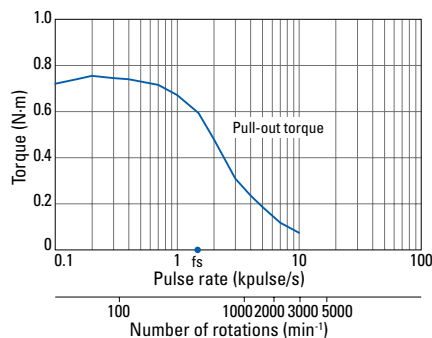

### 103H7123-0740 103H7123-0710

Constant current circuit  
Source voltage: 24 VDC  
Operating current:  
3 A/phase, 2-phase  
energization (full-step)  
Pull-out torque:  
 $J_L=0.94 \times 10^{-4}$  kg·m<sup>2</sup> (use the  
rubber coupling)  
fs: Maximum self-start  
frequency when not  
loaded

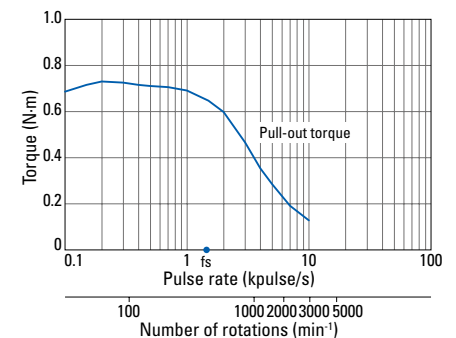

## Characteristics diagram

### 103H7124-0140 103H7124-0110

Constant current circuit  
Source voltage: 24 VDC  
Operating current:  
1 A/phase, 2-phase  
energization (full-step)  
Pull-out torque:  
 $J_L=2.6 \times 10^{-4} \text{kg} \cdot \text{m}^2$  (use the  
rubber coupling)  
fs: Maximum self-start  
frequency when not  
loaded

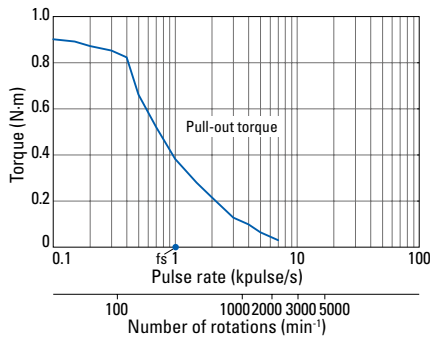

### 103H7124-0440 103H7124-0410

Constant current circuit  
Source voltage: 24 VDC  
Operating current:  
2 A/phase, 2-phase  
energization (full-step)  
Pull-out torque:  
 $J_L=2.6 \times 10^{-4} \text{kg} \cdot \text{m}^2$  (use the  
rubber coupling)  
fs: Maximum self-start  
frequency when not  
loaded

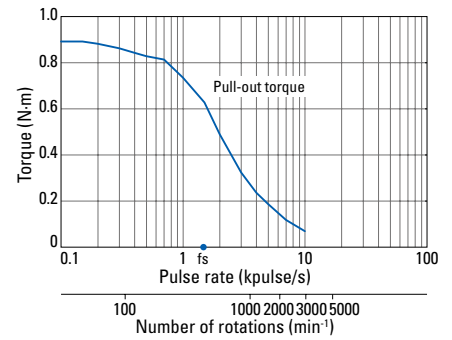

### 103H7124-0740 103H7124-0710

Constant current circuit  
Source voltage: 24 VDC  
Operating current:  
3 A/phase, 2-phase  
energization (full-step)  
Pull-out torque:  
 $J_L=2.6 \times 10^{-4} \text{kg} \cdot \text{m}^2$  (use the  
rubber coupling)  
fs: Maximum self-start  
frequency when not  
loaded

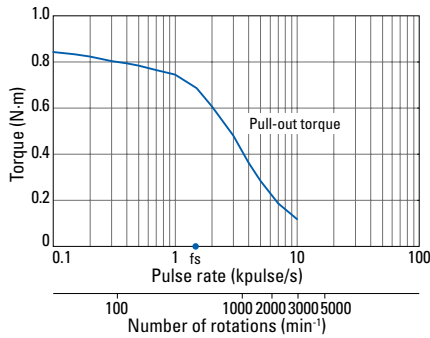

### 103H7126-0140 103H7126-0110

Constant current circuit  
Source voltage: 24 VDC  
Operating current:  
1 A/phase, 2-phase  
energization (full-step)  
Pull-out torque:  
 $J_L=2.6 \times 10^{-4} \text{kg} \cdot \text{m}^2$  (use the  
rubber coupling)  
fs: Maximum self-start  
frequency when not  
loaded

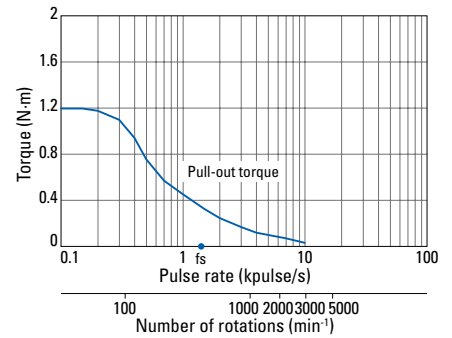

### 103H7126-0440 103H7126-0410

Constant current circuit  
Source voltage: 24 VDC  
Operating current:  
2 A/phase, 2-phase  
energization (full-step)  
Pull-out torque:  
 $J_L=2.6 \times 10^{-4} \text{kg} \cdot \text{m}^2$  (use the  
rubber coupling)  
fs: Maximum self-start  
frequency when not  
loaded

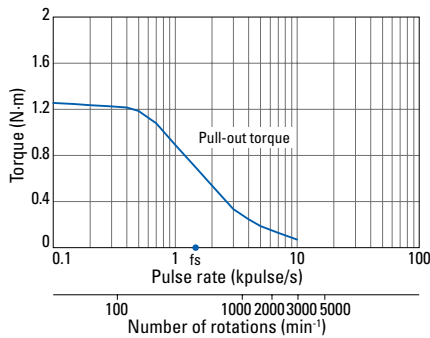

### 103H7126-0740 103H7126-0710

Constant current circuit  
Source voltage: 24 VDC  
Operating current:  
3 A/phase, 2-phase  
energization (full-step)  
Pull-out torque:  
 $J_L=2.6 \times 10^{-4} \text{kg} \cdot \text{m}^2$  (use the  
rubber coupling)  
fs: Maximum self-start  
frequency when not  
loaded

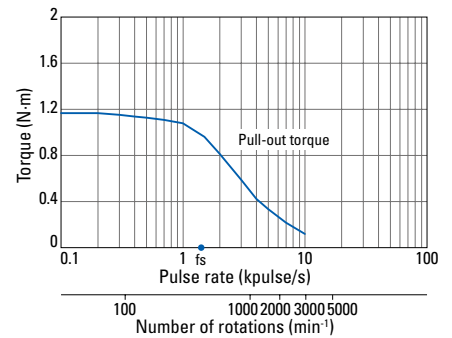

## Dimensions (Unit: mm)

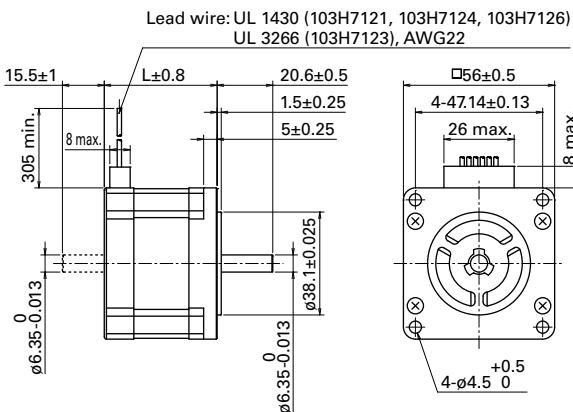

## Internal wiring

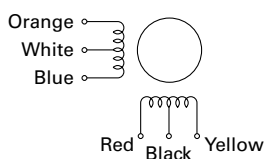

## Compatible drivers

- For motor model no. 103H712 □ -01 □ 0 (1 A/phase),  
103H712 □ -07 □ 0 (3 A/phase)

Driver is not included.

If you require assistance finding a driver, contact us for details.

- For model no. 103H712 □ -04 □ 0 (2 A/phase)

Model no.: US1D200P10 (DC input)

Operating current select switch setting: 0

The characteristics diagram shown above is from our experimental circuit.

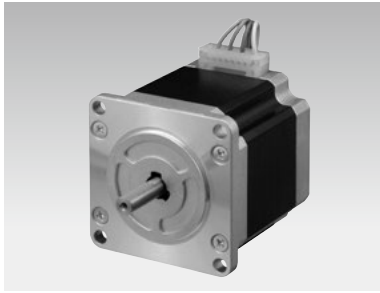

# 56 mm sq.

1.8°/step **RoHS**

Bipolar winding, Lead wire type  
Unipolar winding, Lead wire type ▶ p. 52

### Customizing

[Hollow](#) [Shaft modification](#)  
[Decelerator](#) [Encoder](#)

Varies depending on the model number and quantity. Contact us for details.

### Bipolar winding, Lead wire type

Model no.		Holding torque at 2-phase energization N·m min.	Rated current A/phase	Wiring resistance Ω/phase	Winding inductance mH/phase	Rotor inertia ×10 <sup>-4</sup> kg·m <sup>2</sup>	Mass kg	Motor length (L) mm	Shaft diameter (D) mm	Dcut thickness (T) mm
Single shaft	Dual shaft									
103H7121-5640	103H7121-5610	0.55	1	4.3	14.5	0.1	0.47	41.8	ø6.35-0.013	5.8
103H7121-5740	103H7121-5710	0.55	2	1.1	3.7	0.1	0.47	41.8	ø6.35-0.013	5.8
103H7121-5840	103H7121-5810	0.55	3	0.54	1.74	0.1	0.47	41.8	ø6.35-0.013	5.8
103H7123-5640	103H7123-5610	1.0	1	5.7	29.4	0.21	0.65	53.8	ø6.35-0.013	5.8
103H7123-5740	103H7123-5710	1.0	2	1.5	7.5	0.21	0.65	53.8	ø6.35-0.013	5.8
103H7123-5840	103H7123-5810	1.0	3	0.7	3.5	0.21	0.65	53.8	ø6.35-0.013	5.8
103H7126-5640	103H7126-5610	1.6	1	7.7	34.6	0.36	0.98	75.8	ø6.35-0.013	5.8
103H7126-5740	103H7126-5710	1.6	2	2	9.1	0.36	0.98	75.8	ø6.35-0.013	5.8
103H7126-5840	103H7126-5810	1.6	3	0.94	4	0.36	0.98	75.8	ø6.35-0.013	5.8
103H7128-5640	103H7128-5610	2.0	1	8.9	40.1	0.49	1.3	94.8	ø8-0.015	7.5
103H7128-5740	103H7128-5710	2.0	2	2.3	10.4	0.49	1.3	94.8	ø8-0.015	7.5
103H7128-5840	103H7128-5810	2.0	3	1.03	4.3	0.49	1.3	94.8	ø8-0.015	7.5

### Characteristics diagram

#### 103H7121-5640 103H7121-5610

Constant current circuit  
Source voltage: 24 VDC  
Operating current:  
1 A/phase, 2-phase  
energization (full-step)  
Pull-out torque:  
 $J_s=0.94 \times 10^{-4} \text{kg} \cdot \text{m}^2$  (use the  
rubber coupling)  
fs: Maximum self-start  
frequency when not  
loaded

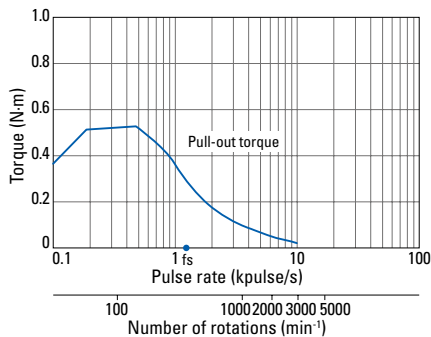

#### 103H7121-5740 103H7121-5710

Constant current circuit  
Source voltage: 24 VDC  
Operating current:  
2 A/phase, 2-phase  
energization (full-step)  
Pull-out torque:  
 $J_s=0.94 \times 10^{-4} \text{kg} \cdot \text{m}^2$  (use the  
rubber coupling)  
fs: Maximum self-start  
frequency when not  
loaded

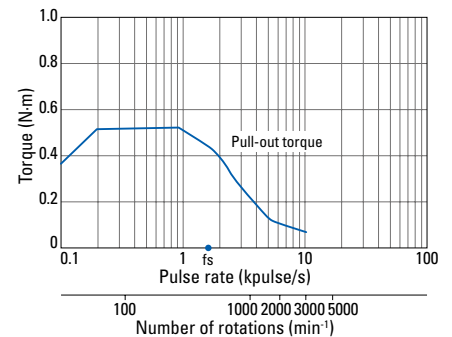

#### 103H7121-5840 103H7121-5810

Constant current circuit  
Source voltage: 24 VDC  
Operating current:  
3 A/phase, 2-phase  
energization (full-step)  
Pull-out torque:  
 $J_s=0.94 \times 10^{-4} \text{kg} \cdot \text{m}^2$  (use the  
rubber coupling)  
fs: Maximum self-start  
frequency when not  
loaded

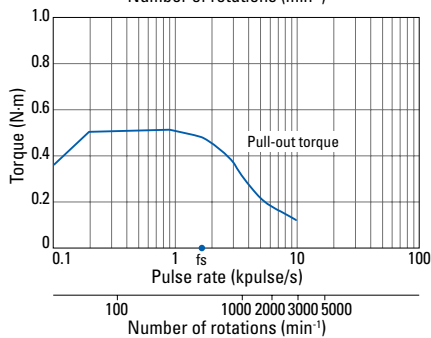

#### 103H7123-5640 103H7123-5610

Constant current circuit  
Source voltage: 24 VDC  
Operating current:  
1 A/phase, 2-phase  
energization (full-step)  
Pull-out torque:  
 $J_s=2.6 \times 10^{-4} \text{kg} \cdot \text{m}^2$  (use the  
rubber coupling)  
fs: Maximum self-start  
frequency when not  
loaded

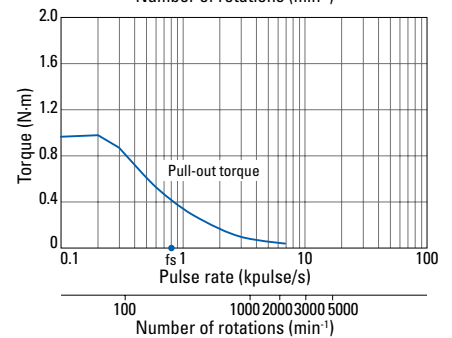

#### 103H7123-5740 103H7123-5710

Constant current circuit  
Source voltage: 24 VDC  
Operating current:  
2 A/phase, 2-phase  
energization (full-step)  
Pull-out torque:  
 $J_s=2.6 \times 10^{-4} \text{kg} \cdot \text{m}^2$  (use the  
rubber coupling)  
fs: Maximum self-start  
frequency when not  
loaded

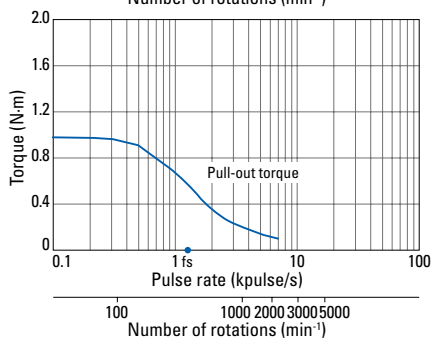

#### 103H7123-5840 103H7123-5810

Constant current circuit  
Source voltage: 24 VDC  
Operating current:  
3 A/phase, 2-phase  
energization (full-step)  
Pull-out torque:  
 $J_s=2.6 \times 10^{-4} \text{kg} \cdot \text{m}^2$  (use the  
rubber coupling)  
fs: Maximum self-start  
frequency when not  
loaded

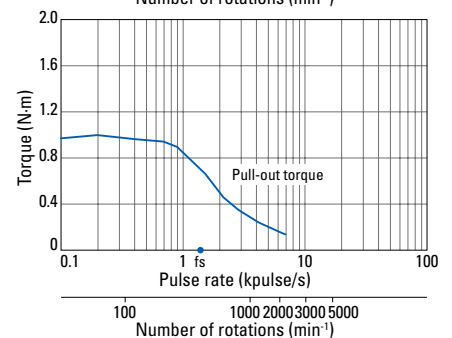

## Characteristics diagram

### 103H7126-5640 103H7126-5610

Constant current circuit  
Source voltage: 24 VDC  
Operating current:  
1 A/phase, 2-phase  
energization (full-step)  
Pull-out torque:  
 $J_L=2.6 \times 10^{-4} \text{kg}\cdot\text{m}^2$  (use the  
rubber coupling)  
 $f_s$ : Maximum self-start  
frequency when not  
loaded

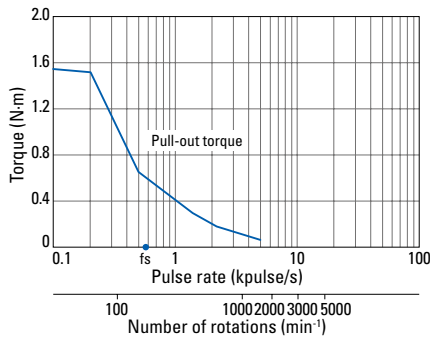

### 103H7126-5740 103H7126-5710

Constant current circuit  
Source voltage: 24 VDC  
Operating current:  
2 A/phase, 2-phase  
energization (full-step)  
Pull-out torque:  
 $J_L=2.6 \times 10^{-4} \text{kg}\cdot\text{m}^2$  (use the  
rubber coupling)  
 $f_s$ : Maximum self-start  
frequency when not  
loaded

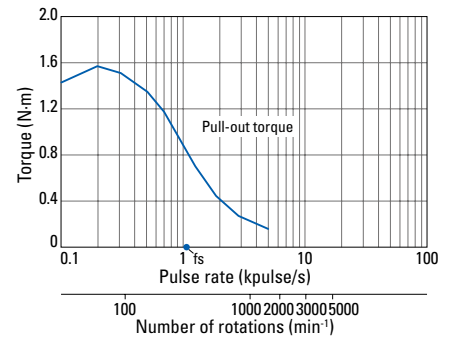

### 103H7126-5840 103H7126-5810

Constant current circuit  
Source voltage: 24 VDC  
Operating current:  
3 A/phase, 2-phase  
energization (full-step)  
Pull-out torque:  
 $J_L=2.6 \times 10^{-4} \text{kg}\cdot\text{m}^2$  (use the  
rubber coupling)  
 $f_s$ : Maximum self-start  
frequency when not  
loaded

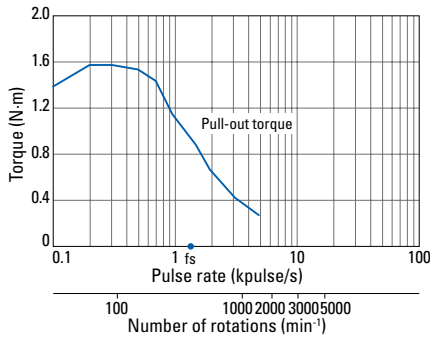

### 103H7128-5640 103H7128-5610

Constant current circuit  
Source voltage: 24 VDC  
Operating current:  
1 A/phase, 2-phase  
energization (full-step)  
Pull-out torque:  
 $J_L=7.4 \times 10^{-4} \text{kg}\cdot\text{m}^2$  (use the  
rubber coupling)  
 $f_s$ : Maximum self-start  
frequency when not  
loaded

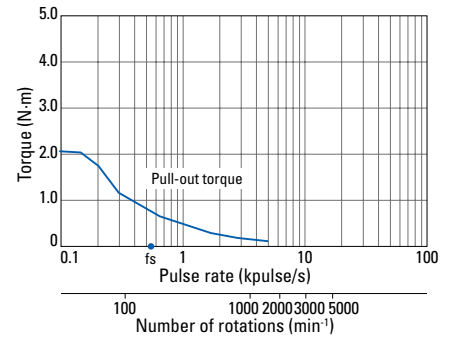

### 103H7128-5740 103H7128-5710

Constant current circuit  
Source voltage: 24 VDC  
Operating current:  
2 A/phase, 2-phase  
energization (full-step)  
Pull-out torque:  
 $J_L=7.4 \times 10^{-4} \text{kg}\cdot\text{m}^2$  (use the  
rubber coupling)  
 $f_s$ : Maximum self-start  
frequency when not  
loaded

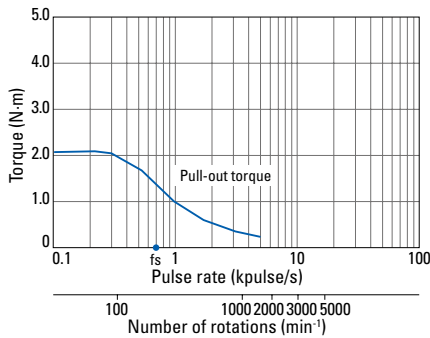

### 103H7128-5840 103H7128-5810

Constant current circuit  
Source voltage: 24 VDC  
Operating current:  
3 A/phase, 2-phase  
energization (full-step)  
Pull-out torque:  
 $J_L=7.4 \times 10^{-4} \text{kg}\cdot\text{m}^2$  (use the  
rubber coupling)  
 $f_s$ : Maximum self-start  
frequency when not  
loaded

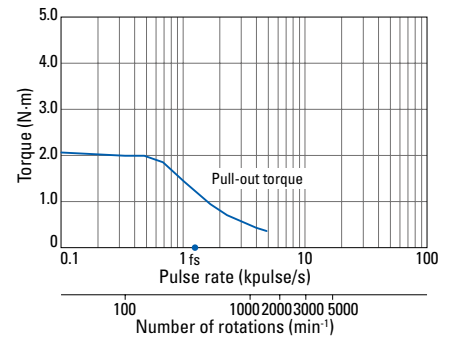

## Dimensions (Unit: mm)

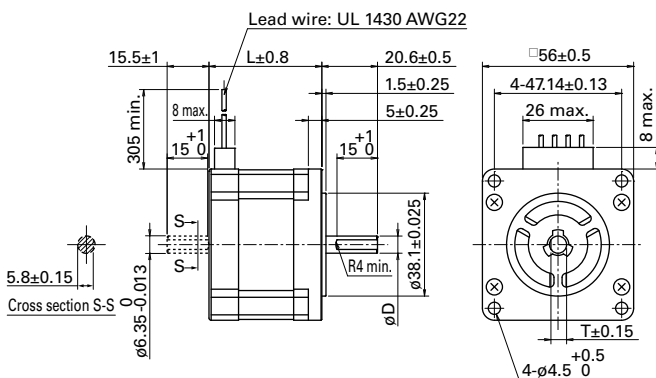

## Internal wiring

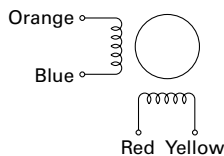

## Compatible drivers

- For Motor model no. 103H7121-57 □ 0 (2 A/phase), 103H7123-57 □ 0 (2 A/phase), 103H7126-57 □ 0 (2 A/phase)  
Model no.: BS1D200P10 (DC input)  
Operating current select switch setting: 0
- Driver is not included for other motor model nos.  
If you require assistance finding a driver, contact us for details.

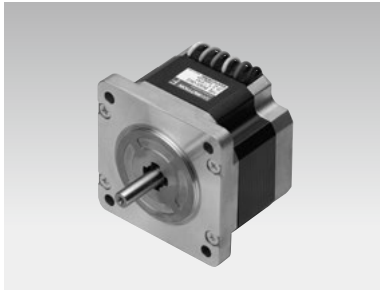

## 60 mm sq.

0.9°/step RoHS

Unipolar winding, Lead wire type  
Bipolar winding, Lead wire type

### Customizing

Hollow Shaft modification  
Decelerator Encoder

Varies depending on the model number and quantity. Contact us for details.

### Unipolar winding, Lead wire type

Model no.		Holding torque at 2-phase energization N·m min.	Rated current A/phase	Wiring resistance Ω/phase	Winding inductance mH/phase	Rotor inertia ×10 <sup>-4</sup> kg·m <sup>2</sup>	Mass kg	Motor length (L) mm	Shaft diameter (D) mm
Single shaft	Dual shaft								
<b>SH1601-0440</b>	<b>SH1601-0410</b>	0.57	2	1.35	2	0.24	0.55	42	<sup>0</sup> ø6.35 -0.013
<b>SH1602-0440</b>	<b>SH1602-0410</b>	1.1	2	1.8	3.5	0.4	0.8	54	<sup>0</sup> ø6.35 -0.013
<b>SH1603-0440</b>	<b>SH1603-0410</b>	1.7	2	2.3	4.5	0.75	1.2	76	<sup>0</sup> ø8 -0.015

## Characteristics diagram

### SH1601-0440 SH1601-0410

Constant current circuit  
Source voltage: 24 VDC  
Operating current:  
2 A/phase, 2-phase  
energization (full-step)  
Pull-out torque:  
 $J_s=0.94 \times 10^{-4} \text{kg}\cdot\text{m}^2$  (use the  
rubber coupling)  
 $f_s$ : Maximum self-start  
frequency when not  
loaded

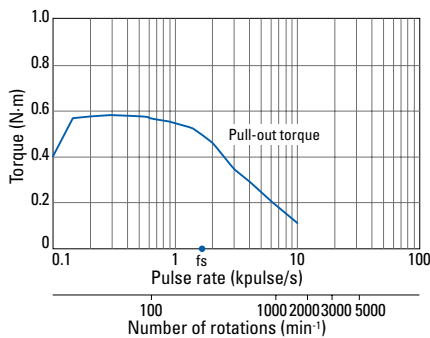

### SH1602-0440 SH1602-0410

Constant current circuit  
Source voltage: 24 VDC  
Operating current:  
2 A/phase, 2-phase  
energization (full-step)  
Pull-out torque:  
 $J_s=2.6 \times 10^{-4} \text{kg}\cdot\text{m}^2$  (use the  
rubber coupling)  
 $f_s$ : Maximum self-start  
frequency when not  
loaded

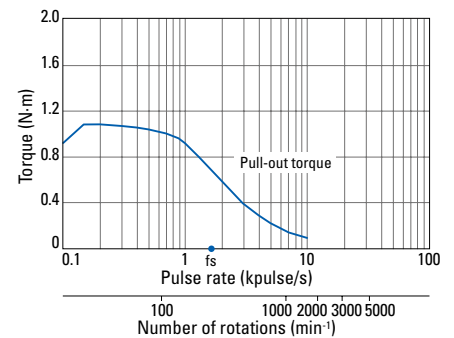

### SH1603-0440 SH1603-0410

Constant current circuit  
Source voltage: 24 VDC  
Operating current:  
2 A/phase, 2-phase  
energization (full-step)  
Pull-out torque:  
 $J_s=7.4 \times 10^{-4} \text{kg}\cdot\text{m}^2$  (use the  
rubber coupling)  
 $f_s$ : Maximum self-start  
frequency when not  
loaded

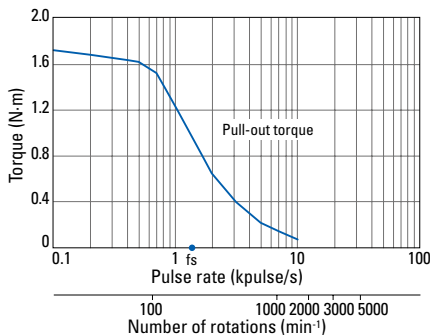

## Dimensions (Unit: mm)

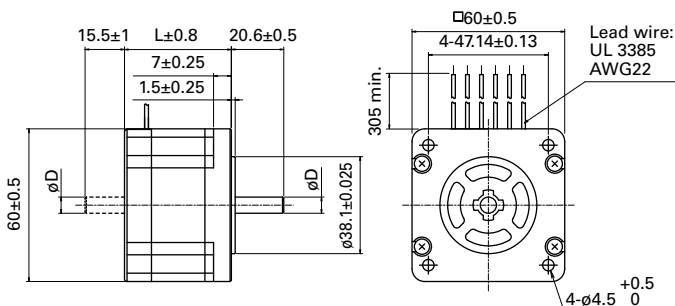

## Internal wiring

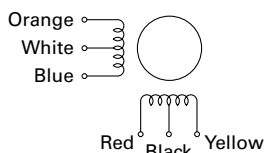

## Compatible drivers

Driver is not included.

If you require assistance finding a driver, contact us for details.



**Bipolar winding, Lead wire type**

Model no.		Holding torque at 2-phase energization N·m min.	Rated current A/phase	Wiring resistance Ω/phase	Winding inductance mH/phase	Rotor inertia ×10 <sup>-4</sup> kg·m <sup>2</sup>	Mass kg	Motor length (L) mm	Shaft diameter (D) mm
Single shaft	Dual shaft								
SH1601-5240	SH1601-5210	0.69	2	1.2	3.5	0.24	0.55	42	<sup>0</sup> ø6.35 -0.013
SH1602-5240	SH1602-5210	1.28	2	1.65	6.1	0.4	0.8	54	<sup>0</sup> ø6.35 -0.013
SH1603-5240	SH1603-5210	2.15	2	2.3	8.8	0.75	1.2	76	<sup>0</sup> ø8 -0.015

**Characteristics diagram**

**SH1601-5240  
SH1601-5210**  
Constant current circuit  
Source voltage: 24 VDC  
Operating current:  
2 A/phase, 2-phase  
energization (full-step)  
Pull-out torque:  
J<sub>r</sub>=0.94×10<sup>-4</sup>kg·m<sup>2</sup> (use the  
rubber coupling)  
fs: Maximum self-start  
frequency when not  
loaded

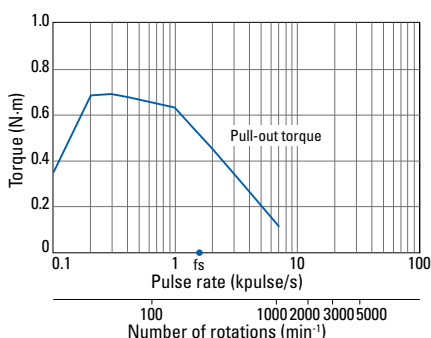

**SH1602-5240  
SH1602-5210**  
Constant current circuit  
Source voltage: 24 VDC  
Operating current:  
2 A/phase, 2-phase  
energization (full-step)  
Pull-out torque:  
J<sub>r</sub>=2.6×10<sup>-4</sup>kg·m<sup>2</sup> (use the  
rubber coupling)  
fs: Maximum self-start  
frequency when not  
loaded

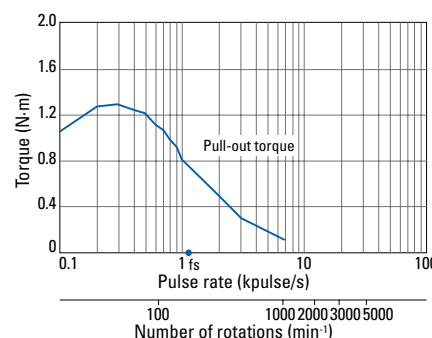

**SH1603-5240  
SH1603-5210**  
Constant current circuit  
Source voltage: 24 VDC  
Operating current:  
2 A/phase, 2-phase  
energization (full-step)  
Pull-out torque:  
J<sub>r</sub>=7.4×10<sup>-4</sup>kg·m<sup>2</sup> (use the  
rubber coupling)  
fs: Maximum self-start  
frequency when not  
loaded

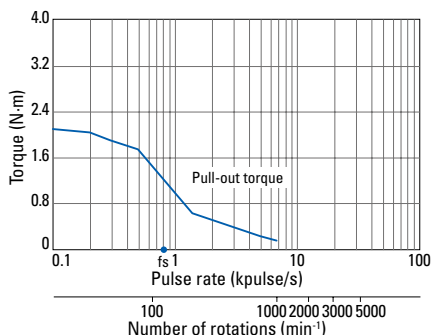

**Dimensions (Unit: mm)**

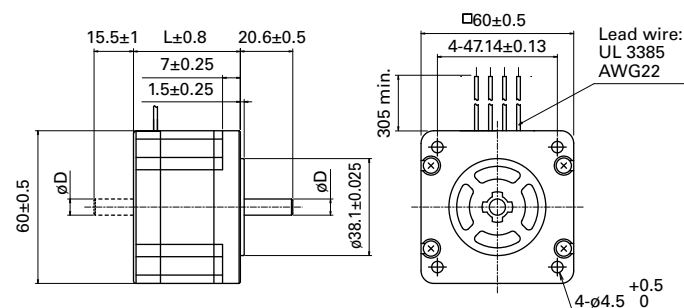

**Internal wiring**

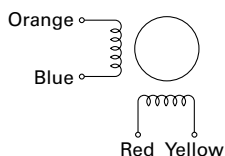

**Compatible drivers**

Model no.: BS1D200P10 (DC input)  
Operating current select switch setting: 0  
*The characteristics diagram shown above is from our experimental circuit.*

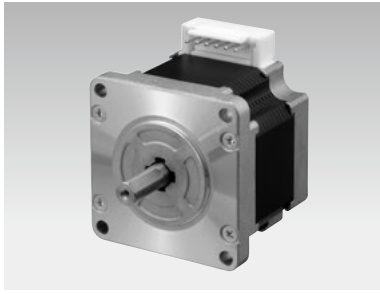

## 60 mm sq.

1.8°/step RoHS

Unipolar winding, Connector type

Unipolar winding, Lead wire type

Dimensions for attaching NEMA23 are interchangeable (47.14 mm-pitch)

Bipolar winding, Connector type ▶ p. 60

Bipolar winding, Lead wire type

Dimensions for attaching NEMA23 are interchangeable (47.14 mm-pitch) ▶ p. 60

### Customizing

Hollow Shaft modification

Decelerator Encoder

Brake

Varies depending on the model number and quantity. Contact us for details.

### Unipolar winding, Connector type

Model no.		Holding torque at 2-phase energization N·m min.	Rated current A/phase	Wiring resistance Ω/phase	Winding inductance mH/phase	Rotor inertia ×10 <sup>-4</sup> kg·m <sup>2</sup>	Mass kg	Motor length (L) mm
Single shaft	Dual shaft							
103H7821-0140	103H7821-0110	0.78	1	5.7	8.3	0.275	0.6	44.8
103H7821-0440	103H7821-0410	0.78	2	1.5	2	0.275	0.6	44.8
103H7821-0740	103H7821-0710	0.78	3	0.68	0.8	0.275	0.6	44.8
103H7822-0140	103H7822-0110	1.17	1	6.9	14	0.4	0.77	53.8
103H7822-0440	103H7822-0410	1.17	2	1.8	3.6	0.4	0.77	53.8
103H7822-0740	103H7822-0710	1.17	3	0.8	1.38	0.4	0.77	53.8
103H7823-0140	103H7823-0110	2.1	1	10	21.7	0.84	1.34	85.8
103H7823-0440	103H7823-0410	2.1	2	2.7	5.6	0.84	1.34	85.8
103H7823-0740	103H7823-0710	2.1	3	1.25	2.4	0.84	1.34	85.8

Motor cable: model no. 4837798-1

### Unipolar winding, Lead wire type Dimensions for attaching NEMA23 are interchangeable (47.14 mm-pitch)

Model no.		Holding torque at 2-phase energization N·m min.	Rated current A/phase	Wiring resistance Ω/phase	Winding inductance mH/phase	Rotor inertia ×10 <sup>-4</sup> kg·m <sup>2</sup>	Mass kg	Motor length (L) mm
Single shaft	Dual shaft							
103H7821-0160	103H7821-0130	0.78	1	5.7	8.3	0.275	0.6	43.5
103H7821-0460	103H7821-0430	0.78	2	1.5	2	0.275	0.6	43.5
103H7821-0760	103H7821-0730	0.78	3	0.68	0.8	0.275	0.6	43.5
103H7822-0160	103H7822-0130	1.17	1	6.9	14	0.4	0.77	52.5
103H7822-0460	103H7822-0430	1.17	2	1.8	3.6	0.4	0.77	52.5
103H7822-0760	103H7822-0730	1.17	3	0.8	1.38	0.4	0.77	52.5
103H7823-0160	103H7823-0130	2.1	1	10	21.7	0.84	1.34	84.5
103H7823-0460	103H7823-0430	2.1	2	2.7	5.6	0.84	1.34	84.5
103H7823-0760	103H7823-0730	2.1	3	1.25	2.4	0.84	1.34	84.5

## Characteristics diagram

**103H7821-0140**  
**103H7821-0110**

**103H7821-0160**  
**103H7821-0130**

Constant current circuit  
Source voltage: 24 VDC  
Operating current:  
1 A/phase, 2-phase  
energization (full-step)  
Pull-out torque:  
 $J_L=0.94 \times 10^{-4} \text{kg} \cdot \text{m}^2$  (use the  
rubber coupling)  
fs: Maximum self-start  
frequency when not  
loaded

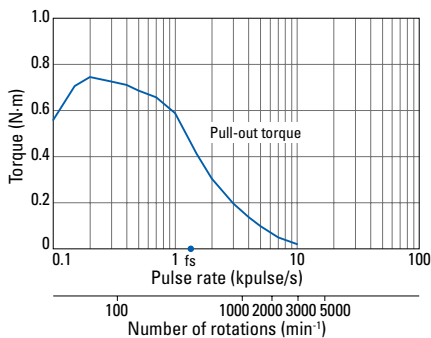

**103H7821-0440**  
**103H7821-0410**

**103H7821-0460**  
**103H7821-0430**

Constant current circuit  
Source voltage: 24 VDC  
Operating current:  
2 A/phase, 2-phase  
energization (full-step)  
Pull-out torque:  
 $J_L=0.94 \times 10^{-4} \text{kg} \cdot \text{m}^2$  (use the  
rubber coupling)  
fs: Maximum self-start  
frequency when not  
loaded

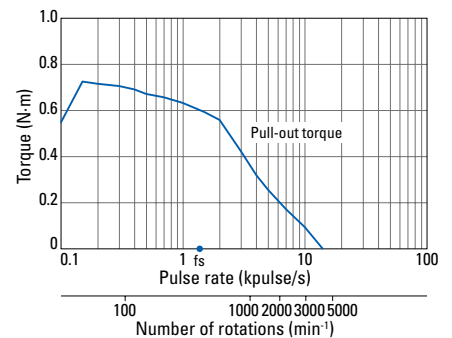

**103H7821-0740**  
**103H7821-0710**

**103H7821-0760**  
**103H7821-0730**

Constant current circuit  
Source voltage: 24 VDC  
Operating current:  
3 A/phase, 2-phase  
energization (full-step)  
Pull-out torque:  
 $J_L=0.94 \times 10^{-4} \text{kg} \cdot \text{m}^2$  (use the  
rubber coupling)  
fs: Maximum self-start  
frequency when not  
loaded

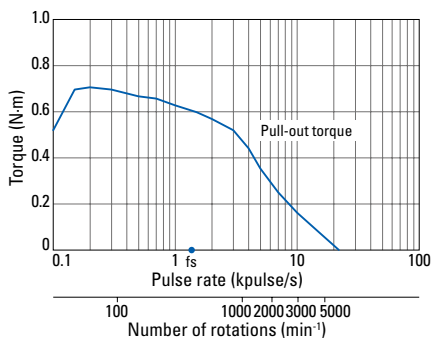

**103H7822-0140**  
**103H7822-0110**

**103H7822-0160**  
**103H7822-0130**

Constant current circuit  
Source voltage: 24 VDC  
Operating current:  
1 A/phase, 2-phase  
energization (full-step)  
Pull-out torque:  
 $J_L=2.6 \times 10^{-4} \text{kg} \cdot \text{m}^2$  (use the  
rubber coupling)  
fs: Maximum self-start  
frequency when not  
loaded

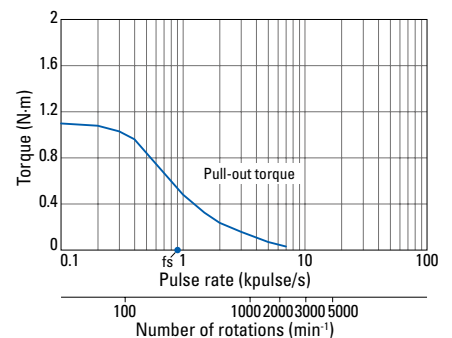

## Characteristics diagram

**103H7822-0440**  
**103H7822-0410**

**103H7822-0460**  
**103H7822-0430**

Constant current circuit  
Source voltage: 24 VDC  
Operating current:  
2 A/phase, 2-phase  
energization (full-step)  
Pull-out torque:  
 $J_L=2.6 \times 10^{-4} \text{kg}\cdot\text{m}^2$  (use the  
rubber coupling)  
 $f_s$ : Maximum self-start  
frequency when not  
loaded

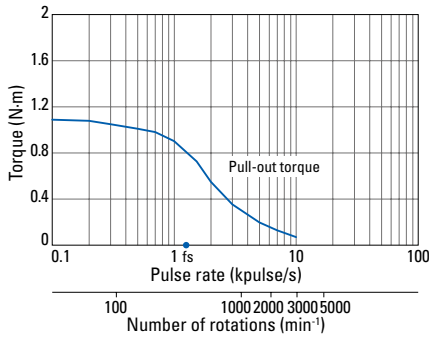

**103H7823-0140**  
**103H7823-0110**

**103H7823-0160**  
**103H7823-0130**

Constant current circuit  
Source voltage: 24 VDC  
Operating current:  
1 A/phase, 2-phase  
energization (full-step)  
Pull-out torque:  
 $J_L=7.4 \times 10^{-4} \text{kg}\cdot\text{m}^2$  (use the  
rubber coupling)  
 $f_s$ : Maximum self-start  
frequency when not  
loaded

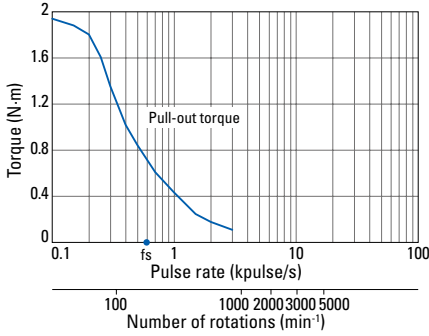

**103H7823-0740**  
**103H7823-0710**

**103H7823-0760**  
**103H7823-0730**

Constant current circuit  
Source voltage: 24 VDC  
Operating current:  
3 A/phase, 2-phase  
energization (full-step)  
Pull-out torque:  
 $J_L=7.4 \times 10^{-4} \text{kg}\cdot\text{m}^2$  (use the  
rubber coupling)  
 $f_s$ : Maximum self-start  
frequency when not  
loaded

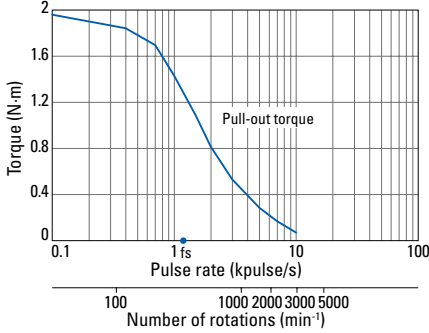

**103H7822-0740**  
**103H7822-0710**

**103H7822-0760**  
**103H7822-0730**

Constant current circuit  
Source voltage: 24 VDC  
Operating current:  
3 A/phase, 2-phase  
energization (full-step)  
Pull-out torque:  
 $J_L=2.6 \times 10^{-4} \text{kg}\cdot\text{m}^2$  (use the  
rubber coupling)  
 $f_s$ : Maximum self-start  
frequency when not  
loaded

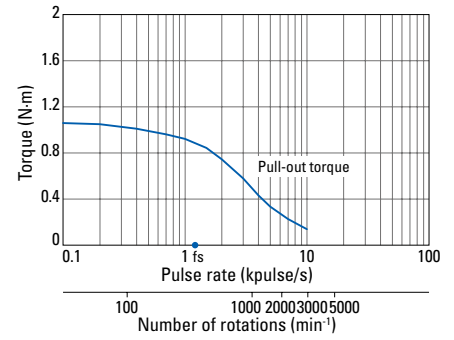

**103H7823-0440**  
**103H7823-0410**

**103H7823-0460**  
**103H7823-0430**

Constant current circuit  
Source voltage: 24 VDC  
Operating current:  
2 A/phase, 2-phase  
energization (full-step)  
Pull-out torque:  
 $J_L=7.4 \times 10^{-4} \text{kg}\cdot\text{m}^2$  (use the  
rubber coupling)  
 $f_s$ : Maximum self-start  
frequency when not  
loaded

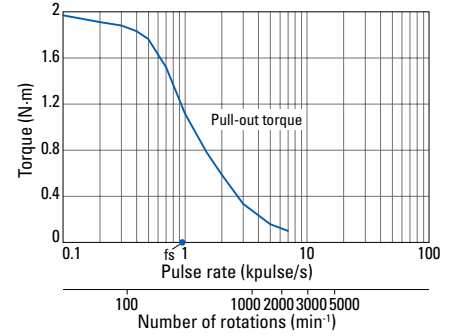

## Internal wiring

### Connector type

( ) connector pin number

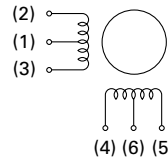

### Lead wire type

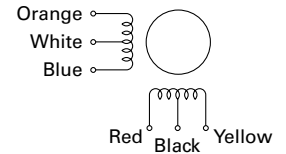

## Dimensions (Unit: mm)

### Connector type

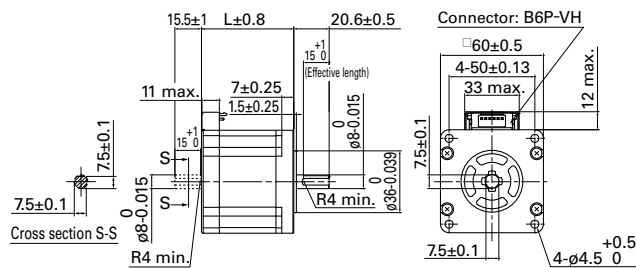

### Lead wire type

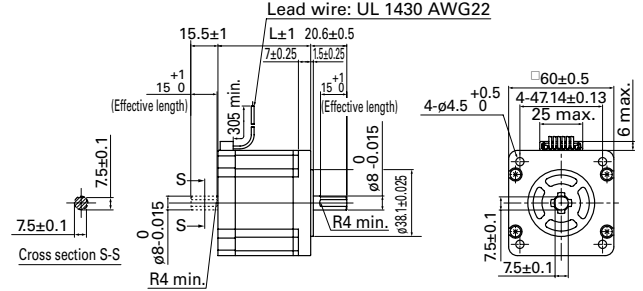

Motor cable Unipolar Model no.: 4837798-1

Manufacturer: J.S.T.  
Housing: VHR-6N  
Pin: SVH-21T-P1.1

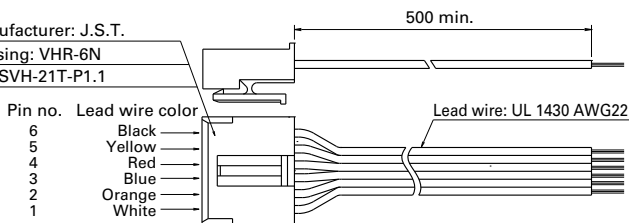

## Compatible drivers

- For motor model no. 103H782 □ -01 □ 0 (1 A/phase), 103H782 □ -07 □ 0 (3 A/phase)

Driver is not included.

If you require assistance finding a driver, contact us for details.

- For motor no. 103H782 □ -04 □ 0 (2 A/phase)

Model no.: US1D200P10 (DC input)

Operating current select switch setting: 0

The characteristics diagram shown above is from our experimental circuit.

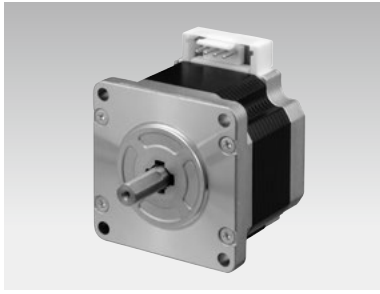

## 60 mm sq.

1.8°/step RoHS

Bipolar winding, Connector type

Bipolar winding, Lead wire type

Dimensions for attaching NEMA23 are interchangeable (47.14 mm-pitch)

Unipolar winding, Connector type ▶ p. 58

Unipolar winding, Lead wire type

Dimensions for attaching NEMA23 are interchangeable (47.14 mm-pitch) ▶ p. 58

### Customizing

Hollow Shaft modification

Decelerator Encoder

Brake

Varies depending on the model number and quantity. Contact us for details.

### Bipolar winding, Connector type

Model no.		Holding torque at 2-phase energization N·m min.	Rated current A/phase	Wiring resistance Ω/phase	Winding inductance mH/phase	Rotor inertia ×10 <sup>-4</sup> kg·m <sup>2</sup>	Mass kg	Motor length (L) mm
Single shaft	Dual shaft							
103H7821-5740	103H7821-5710	0.88	2	1.27	3.3	0.275	0.6	44.8
103H7821-1740	103H7821-1710	0.88	4	0.35	0.8	0.275	0.6	44.8
103H7822-5740	103H7822-5710	1.37	2	1.55	5.5	0.4	0.77	53.8
103H7822-1740	103H7822-1710	1.37	4	0.43	1.38	0.4	0.77	53.8
103H7823-5740	103H7823-5710	2.7	2	2.4	9.5	0.84	1.34	85.8
103H7823-1740	103H7823-1710	2.7	4	0.65	2.4	0.84	1.34	85.8

Motor cable: model no. 4837961-1

### Bipolar winding, Lead wire type Dimensions for attaching NEMA23 are interchangeable (47.14 mm-pitch)

Model no.		Holding torque at 2-phase energization N·m min.	Rated current A/phase	Wiring resistance Ω/phase	Winding inductance mH/phase	Rotor inertia ×10 <sup>-4</sup> kg·m <sup>2</sup>	Mass kg	Motor length (L) mm
Single shaft	Dual shaft							
103H7821-5760	103H7821-5730	0.88	2	1.27	3.3	0.275	0.6	43.5
103H7821-1760	103H7821-1730	0.88	4	0.35	0.8	0.275	0.6	43.5
103H7822-5760	103H7822-5730	1.37	2	1.55	5.5	0.4	0.77	52.5
103H7822-1760	103H7822-1730	1.37	4	0.43	1.38	0.4	0.77	52.5
103H7823-5760	103H7823-5730	2.7	2	2.4	9.5	0.84	1.34	84.5
103H7823-1760	103H7823-1730	2.7	4	0.65	2.4	0.84	1.34	84.5

## Characteristics diagram

**103H7821-5740**  
**103H7821-5710**

**103H7821-5760**  
**103H7821-5730**

Constant current circuit  
Source voltage: 24 VDC  
Operating current:  
2 A/phase, 2-phase  
energization (full-step)  
Pull-out torque:  
 $J_L=2.6 \times 10^{-4} \text{kg} \cdot \text{m}^2$  (use the  
rubber coupling)  
fs: Maximum self-start  
frequency when not  
loaded

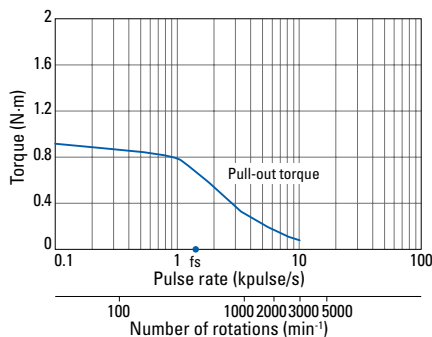

**103H7821-1740**  
**103H7821-1710**

**103H7821-1760**  
**103H7821-1730**

Constant current circuit  
Source voltage: 24 VDC  
Operating current:  
4 A/phase, 2-phase  
energization (full-step)  
Pull-out torque:  
 $J_L=2.6 \times 10^{-4} \text{kg} \cdot \text{m}^2$  (use the  
rubber coupling)  
fs: Maximum self-start  
frequency when not  
loaded

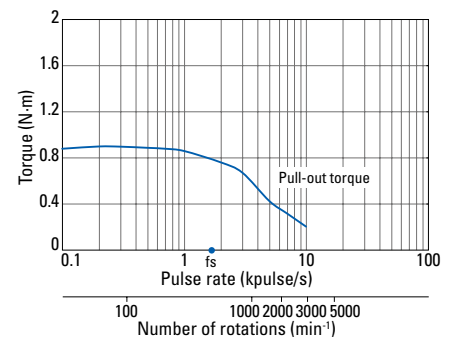

**103H7822-5740**  
**103H7822-5710**

**103H7822-5760**  
**103H7822-5730**

Constant current circuit  
Source voltage: 24 VDC  
Operating current:  
2 A/phase, 2-phase  
energization (full-step)  
Pull-out torque:  
 $J_L=2.6 \times 10^{-4} \text{kg} \cdot \text{m}^2$  (use the  
rubber coupling)  
fs: Maximum self-start  
frequency when not  
loaded

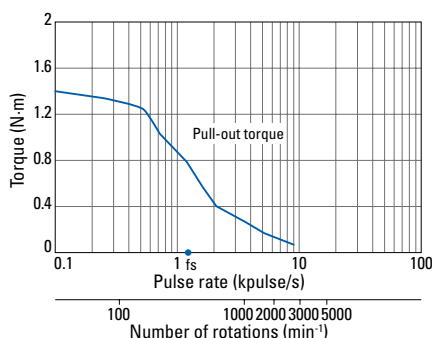

**103H7822-1740**  
**103H7822-1710**

**103H7822-1760**  
**103H7822-1730**

Constant current circuit  
Source voltage: 24 VDC  
Operating current:  
4 A/phase, 2-phase  
energization (full-step)  
Pull-out torque:  
 $J_L=2.6 \times 10^{-4} \text{kg} \cdot \text{m}^2$  (use the  
rubber coupling)  
fs: Maximum self-start  
frequency when not  
loaded

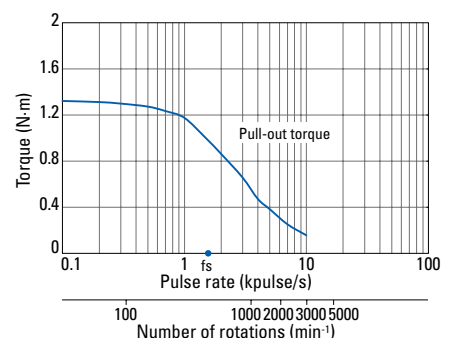

## Characteristics diagram

**103H7823-5740**  
**103H7823-5710**

**103H7823-5760**  
**103H7823-5730**

Constant current circuit  
Source voltage: 24 VDC  
Operating current:  
2 A/phase, 2-phase  
energization (full-step)  
Pull-out torque:  
 $J_s=7.4 \times 10^{-4} \text{ kg} \cdot \text{m}^2$  (use the  
rubber coupling)  
fs: Maximum self-start  
frequency when not  
loaded

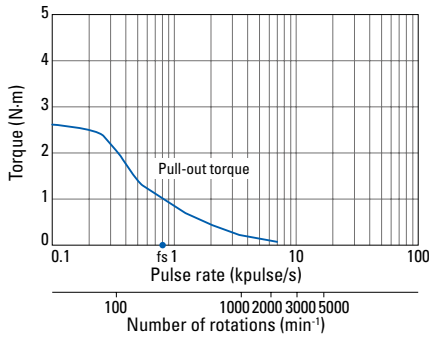

**103H7823-1740**  
**103H7823-1710**

**103H7823-1760**  
**103H7823-1730**

Constant current circuit  
Source voltage: 24 VDC  
Operating current:  
4 A/phase, 2-phase  
energization (full-step)  
Pull-out torque:  
 $J_s=7.4 \times 10^{-4} \text{ kg} \cdot \text{m}^2$  (use the  
rubber coupling)  
fs: Maximum self-start  
frequency when not  
loaded

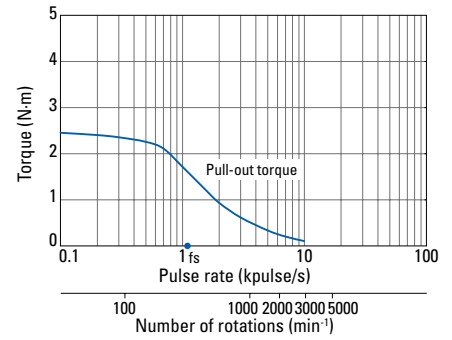

## Dimensions (Unit: mm)

### Connector type

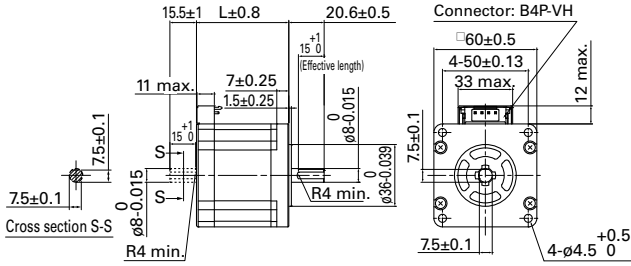

### Lead wire type

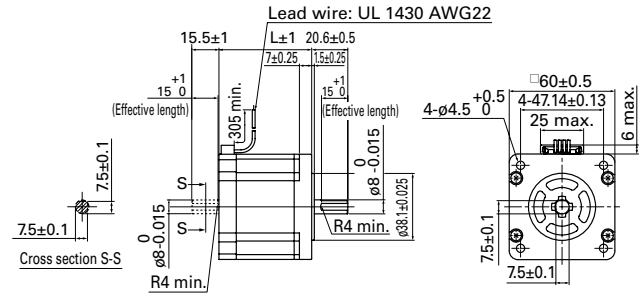

Motor cable Bipolar model no.: 4837961-1

Manufacturer: J.S.T.  
Housing: VHR-4N  
Pin: SVH-21T-P1.1

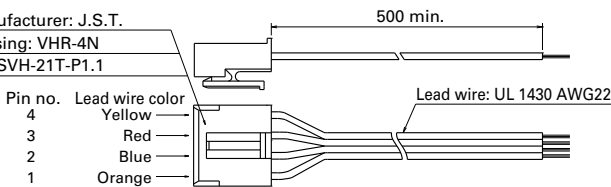

## Internal wiring

### Connector type

( ) connector pin number,  
terminal block number

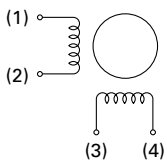

### Lead wire type

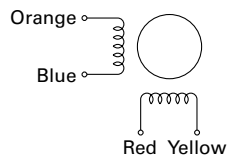

## Compatible drivers

- For motor model no. 103H782 □ -17 □ 0 (4 A/phase)  
Driver is not included.

If you require assistance finding a driver, contact us for  
details.

- For motors not listed above (2 A/phase)  
Model no.: BS1D200P10 (DC input)  
Operating current select switch setting: 0

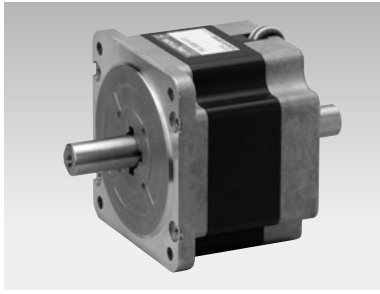

# 86 mm sq.

1.8°/step **RoHS**

Unipolar winding, Lead wire type  
 Unipolar winding, Lead wire type CE/UL model  
 Bipolar winding, Lead wire type ▶ p. 64  
 Bipolar winding, Lead wire type CE/UL model ▶ p. 64  
 Bipolar winding, Terminal block type CE/UL model ▶ p. 64

### Customizing

**Hollow** **Shaft modification**  
**Encoder**

Varies depending on the model number and quantity. Contact us for details.

#### Unipolar winding, Lead wire type

Model no.		Holding torque at 2-phase energization N·m min.	Rated current A/phase	Wiring resistance Ω/phase	Winding inductance mH/phase	Rotor inertia ×10 <sup>-4</sup> kg·m <sup>2</sup>	Mass kg	Motor length (L) mm
Single shaft	Dual shaft							
<b>SH2861-0441</b>	<b>SH2861-0411</b>	2.5	2	2.3	8.0	1.48	1.75	66
<b>SH2861-0941</b>	<b>SH2861-0911</b>	2.5	4	0.6	2.0	1.48	1.75	66
<b>SH2862-0441</b>	<b>SH2862-0411</b>	4.7	2	3.2	13.0	3.0	2.9	96.5
<b>SH2862-0941</b>	<b>SH2862-0911</b>	4.7	4	0.85	3.4	3.0	2.9	96.5
<b>SH2863-0441</b>	<b>SH2863-0411</b>	6.7	2	4.0	17.0	4.5	4.0	127
<b>SH2863-0941</b>	<b>SH2863-0911</b>	6.7	4	0.9	4.2	4.5	4.0	127

#### Unipolar winding, Lead wire type CE/UL model

Model no.		Holding torque at 2-phase energization N·m min.	Rated current A/phase	Wiring resistance Ω/phase	Winding inductance mH/phase	Rotor inertia ×10 <sup>-4</sup> kg·m <sup>2</sup>	Mass kg	Motor length (L) mm
Single shaft	Dual shaft							
<b>SM2861-0451</b>	<b>SM2861-0421</b>	2.5	2	2.3	8.0	1.48	1.75	66
<b>SM2861-0951</b>	<b>SM2861-0921</b>	2.5	4	0.6	2.0	1.48	1.75	66
<b>SM2862-0451</b>	<b>SM2862-0421</b>	4.7	2	3.2	13.0	3.0	2.9	96.5
<b>SM2862-0951</b>	<b>SM2862-0921</b>	4.7	4	0.85	3.4	3.0	2.9	96.5
<b>SM2863-0451</b>	<b>SM2863-0421</b>	6.7	2	4.0	17.0	4.5	4.0	127
<b>SM2863-0951</b>	<b>SM2863-0921</b>	6.7	4	0.9	4.2	4.5	4.0	127

## Characteristics diagram

**SH2861-0441**  
**SH2861-0411**

**SM2861-0451**  
**SM2861-0421**

Constant current circuit  
 Source voltage: 100 VAC  
 Operating current:  
 2 A/phase, 2-phase  
 energization (full-step)  
 Pull-out torque:  
 $J_L=7.4 \times 10^{-4} \text{kg} \cdot \text{m}^2$  (use the  
 rubber coupling)  
 fs: Maximum self-start  
 frequency when not  
 loaded

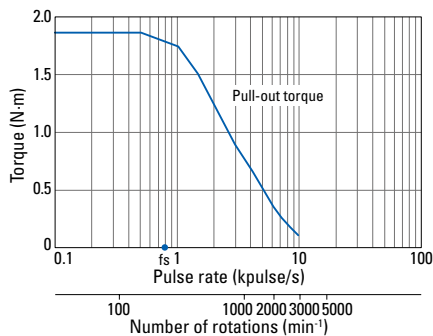

**SH2861-0941**  
**SH2861-0911**

**SM2861-0951**  
**SM2861-0921**

Constant current circuit  
 Source voltage: 100 VAC  
 Operating current:  
 4 A/phase, 2-phase  
 energization (full-step)  
 Pull-out torque:  
 $J_L=7.4 \times 10^{-4} \text{kg} \cdot \text{m}^2$  (use the  
 rubber coupling)  
 fs: Maximum self-start  
 frequency when not  
 loaded

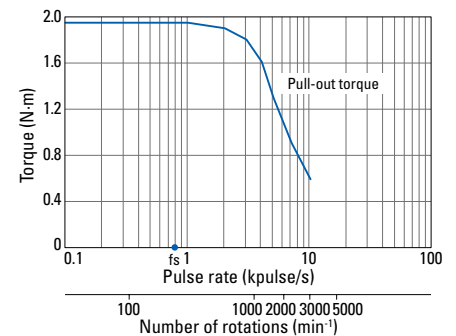

**SH2862-0441**  
**SH2862-0411**

**SM2862-0451**  
**SM2862-0421**

Constant current circuit  
 Source voltage: 100 VAC  
 Operating current:  
 2 A/phase, 2-phase  
 energization (full-step)  
 Pull-out torque:  
 $J_L=15.3 \times 10^{-4} \text{kg} \cdot \text{m}^2$  (use the  
 rubber coupling)  
 fs: Maximum self-start  
 frequency when not  
 loaded

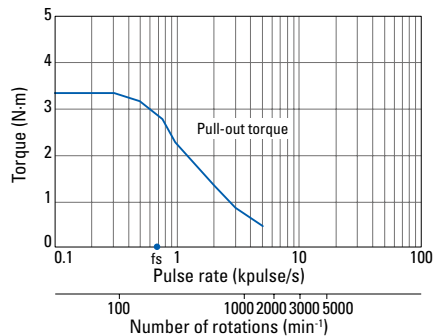

**SH2862-0941**  
**SH2862-0911**

**SM2862-0951**  
**SM2862-0921**

Constant current circuit  
 Source voltage: 100 VAC  
 Operating current:  
 4 A/phase, 2-phase  
 energization (full-step)  
 Pull-out torque:  
 $J_L=15.3 \times 10^{-4} \text{kg} \cdot \text{m}^2$  (use the  
 rubber coupling)  
 fs: Maximum self-start  
 frequency when not  
 loaded

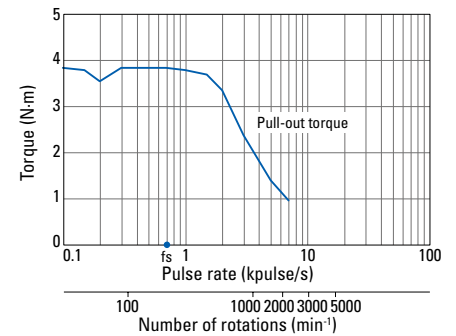

**SH2863-0441**  
**SH2863-0411**

**SM2863-0451**  
**SM2863-0421**

Constant current circuit  
 Source voltage: 100 VAC  
 Operating current:  
 2 A/phase, 2-phase  
 energization (full-step)  
 Pull-out torque:  
 $J_L=15.3 \times 10^{-4} \text{kg} \cdot \text{m}^2$  (use the  
 rubber coupling)  
 fs: Maximum self-start  
 frequency when not  
 loaded

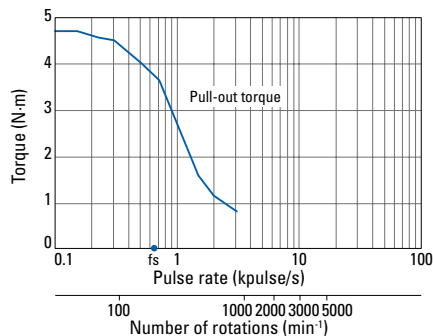

**SH2863-0941**  
**SH2863-0911**

**SM2863-0951**  
**SM2863-0921**

Constant current circuit  
 Source voltage: 100 VAC  
 Operating current:  
 4 A/phase, 2-phase  
 energization (full-step)  
 Pull-out torque:  
 $J_L=15.3 \times 10^{-4} \text{kg} \cdot \text{m}^2$  (use the  
 rubber coupling)  
 fs: Maximum self-start  
 frequency when not  
 loaded

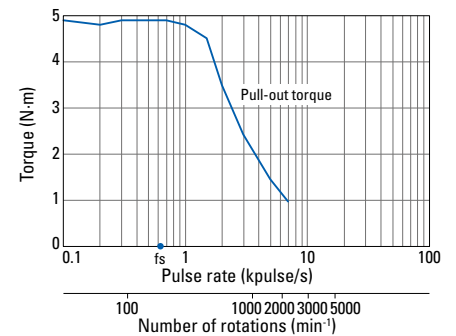

## Dimensions (Unit: mm)

### Lead wire type

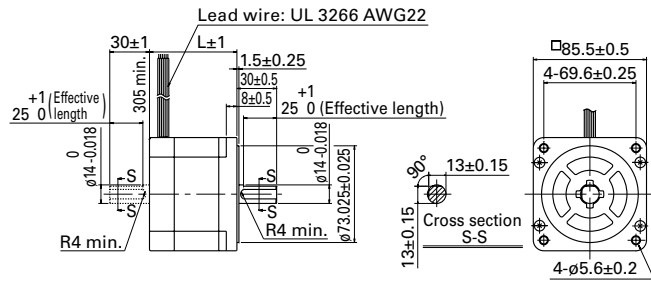

### Lead wire type CE/UL model

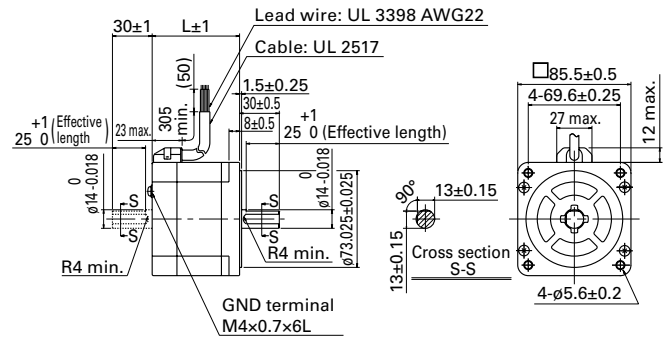

## Internal wiring

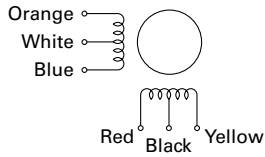

## Compatible drivers

Driver is not included.

If you require assistance finding a driver, contact us for details.

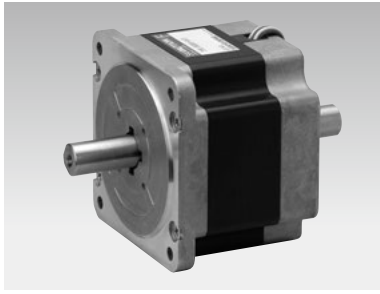

## 86 mm sq.

1.8°/step RoHS

Bipolar winding, Lead wire type  
 Bipolar winding, Lead wire type CE/UL model  
 Bipolar winding, Terminal block type CE/UL model  
 Unipolar winding, Lead wire type ▶ p. 62  
 Unipolar winding, Lead wire type CE/UL model ▶ p. 62

### Customizing

Hollow Shaft modification  
Encoder

Varies depending on the model number and quantity. Contact us for details.

#### Bipolar winding, Lead wire type

Model no.		Holding torque at 2-phase energization N·m min.	Rated current A/phase	Wiring resistance Ω/phase	Winding inductance mH/phase	Rotor inertia ×10 <sup>-4</sup> kg·m <sup>2</sup>	Mass kg	Motor length (L) mm
Single shaft	Dual shaft							
SH2861-5041	SH2861-5011	3.3	2	2.2	15	1.48	1.75	66
SH2861-5141	SH2861-5111	3.3	4	0.56	3.7	1.48	1.75	66
SH2861-5241	SH2861-5211	3.3	6	0.29	1.7	1.48	1.75	66
SH2862-5041	SH2862-5011	6.4	2	3.2	25	3.0	2.9	96.5
SH2862-5141	SH2862-5111	6.4	4	0.83	6.4	3.0	2.9	96.5
SH2862-5241	SH2862-5211	6.4	6	0.36	2.8	3.0	2.9	96.5
SH2863-5041	SH2863-5011	9	2	4.0	32	4.5	4.0	127
SH2863-5141	SH2863-5111	9	4	1.0	7.9	4.5	4.0	127
SH2863-5241	SH2863-5211	9	6	0.46	3.8	4.5	4.0	127

#### Bipolar winding, Lead wire type CE/UL model

Model no.		Holding torque at 2-phase energization N·m min.	Rated current A/phase	Wiring resistance Ω/phase	Winding inductance mH/phase	Rotor inertia ×10 <sup>-4</sup> kg·m <sup>2</sup>	Mass kg	Motor length (L) mm
Single shaft	Dual shaft							
SM2861-5051	SM2861-5021	3.3	2	2.2	15	1.48	1.75	66
SM2861-5151	SM2861-5121	3.3	4	0.56	3.7	1.48	1.75	66
SM2861-5251	SM2861-5221	3.3	6	0.29	1.7	1.48	1.75	66
SM2862-5051	SM2862-5021	6.4	2	3.2	25	3.0	2.9	96.5
SM2862-5151	SM2862-5121	6.4	4	0.83	6.4	3.0	2.9	96.5
SM2862-5251	SM2862-5221	6.4	6	0.36	2.8	3.0	2.9	96.5
SM2863-5051	SM2863-5021	9	2	4.0	32	4.5	4.0	127
SM2863-5151	SM2863-5121	9	4	1.0	7.9	4.5	4.0	127
SM2863-5251	SM2863-5221	9	6	0.46	3.8	4.5	4.0	127

#### Bipolar winding, Terminal block type CE/UL model

Model no.		Holding torque at 2-phase energization N·m min.	Rated current A/phase	Wiring resistance Ω/phase	Winding inductance mH/phase	Rotor inertia ×10 <sup>-4</sup> kg·m <sup>2</sup>	Mass kg	Motor length (L) mm
Single shaft	Dual shaft							
SM2861-5066		3.3	2	2.03	15	1.48	1.9	97.9
SM2861-5166		3.3	4	0.52	3.7	1.48	1.9	97.9
SM2861-5266		3.3	6	0.27	1.7	1.48	1.9	97.9
SM2862-5066		6.4	2	3.08	25	3.0	3.05	128.4
SM2862-5166		6.4	4	0.79	6.4	3.0	3.05	128.4
SM2862-5266		6.4	6	0.33	2.8	3.0	3.05	128.4
SM2863-5066		9	2	3.83	32	4.5	4.15	158.8
SM2863-5166		9	4	0.96	7.9	4.5	4.15	158.8
SM2863-5266		9	6	0.48	3.8	4.5	4.15	158.8

### Characteristics diagram

SH2861-5041  
SH2861-5011

SM2861-5051  
SM2861-5021

SM2861-5066

Constant current circuit  
 Source voltage: 100 VAC  
 Operating current:  
 2 A/phase, 2-phase  
 energization (full-step)  
 Pull-out torque:  
 $J_L=15.3 \times 10^{-4} \text{kg} \cdot \text{m}^2$  (use the  
 rubber coupling)  
 fs: Maximum self-start  
 frequency when not  
 loaded

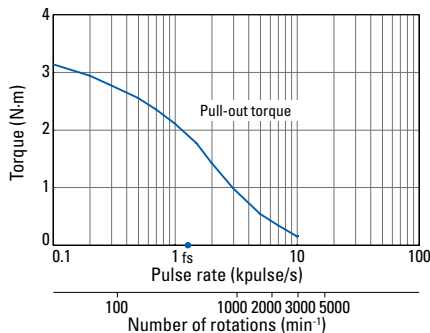

SH2861-5141  
SH2861-5111

SM2861-5151  
SM2861-5121

SM2861-5166

Constant current circuit  
 Source voltage: 100 VAC  
 Operating current:  
 4 A/phase, 2-phase  
 energization (full-step)  
 Pull-out torque:  
 $J_L=15.3 \times 10^{-4} \text{kg} \cdot \text{m}^2$  (use the  
 rubber coupling)  
 fs: Maximum self-start  
 frequency when not  
 loaded

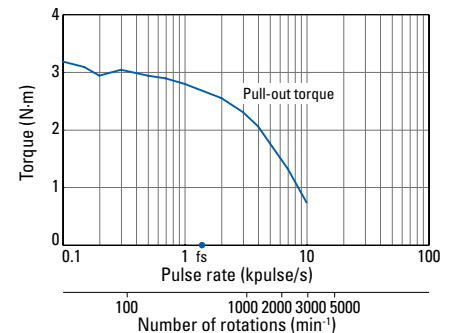



## Characteristics diagram

**SH2861-5241**  
**SH2861-5211**

**SM2861-5251**  
**SM2861-5221**

**SM2861-5266**

Constant current circuit  
Source voltage: 100 VAC  
Operating current:  
6 A/phase, 2-phase  
energization (full-step)  
Pull-out torque:  
 $J_L=15.3 \times 10^{-4} \text{kg} \cdot \text{m}^2$  (use the  
rubber coupling)  
 $f_s$ : Maximum self-start  
frequency when not  
loaded

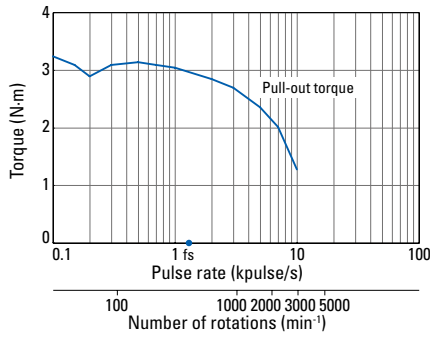

**SH2862-5041**  
**SH2862-5011**

**SM2862-5051**  
**SM2862-5021**

**SM2862-5066**

Constant current circuit  
Source voltage: 100 VAC  
Operating current:  
2 A/phase, 2-phase  
energization (full-step)  
Pull-out torque:  
 $J_L=15.3 \times 10^{-4} \text{kg} \cdot \text{m}^2$  (use the  
rubber coupling)  
 $f_s$ : Maximum self-start  
frequency when not  
loaded

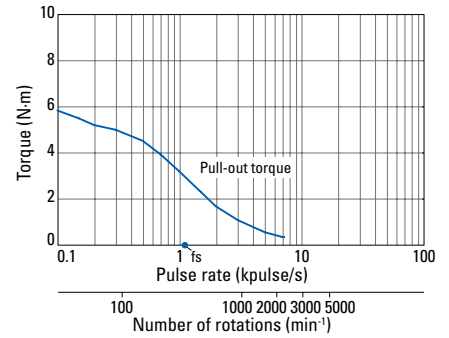

**SH2862-5141**  
**SH2862-5111**

**SM2862-5151**  
**SM2862-5121**

**SM2862-5166**

Constant current circuit  
Source voltage: 100 VAC  
Operating current:  
4 A/phase, 2-phase  
energization (full-step)  
Pull-out torque:  
 $J_L=15.3 \times 10^{-4} \text{kg} \cdot \text{m}^2$  (use the  
rubber coupling)  
 $f_s$ : Maximum self-start  
frequency when not  
loaded

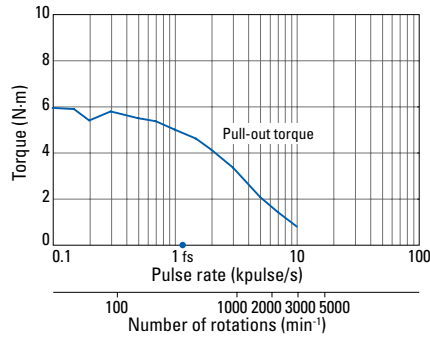

**SH2862-5241**  
**SH2862-5211**

**SM2862-5251**  
**SM2862-5221**

**SM2862-5266**

Constant current circuit  
Source voltage: 100 VAC  
Operating current:  
6 A/phase, 2-phase  
energization (full-step)  
Pull-out torque:  
 $J_L=15.3 \times 10^{-4} \text{kg} \cdot \text{m}^2$  (use the  
rubber coupling)  
 $f_s$ : Maximum self-start  
frequency when not  
loaded

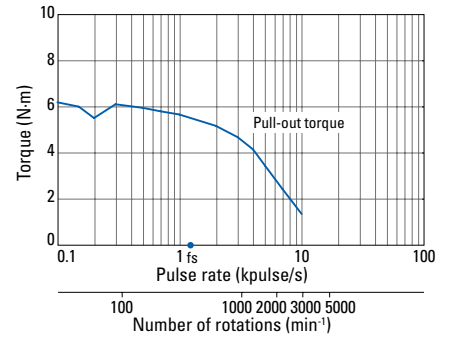

**SH2863-5041**  
**SH2863-5011**

**SM2863-5051**  
**SM2863-5021**

**SM2863-5066**

Constant current circuit  
Source voltage: 100 VAC  
Operating current:  
2 A/phase, 2-phase  
energization (full-step)  
Pull-out torque:  
 $J_L=44 \times 10^{-4} \text{kg} \cdot \text{m}^2$  (use the  
rubber coupling)  
 $f_s$ : Maximum self-start  
frequency when not  
loaded

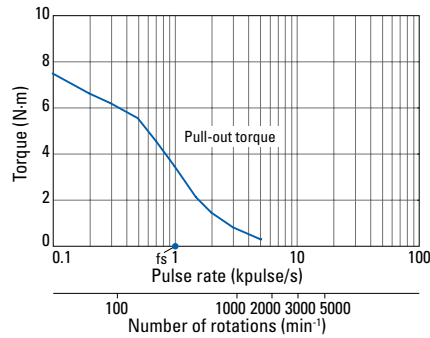

**SH2863-5141**  
**SH2863-5111**

**SM2863-5151**  
**SM2863-5121**

**SM2863-5166**

Constant current circuit  
Source voltage: 100 VAC  
Operating current:  
4 A/phase, 2-phase  
energization (full-step)  
Pull-out torque:  
 $J_L=44 \times 10^{-4} \text{kg} \cdot \text{m}^2$  (use the  
rubber coupling)  
 $f_s$ : Maximum self-start  
frequency when not  
loaded

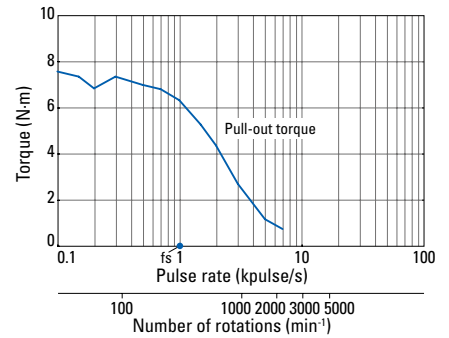

**SH2863-5241**  
**SH2863-5211**

**SM2863-5251**  
**SM2863-5221**

**SM2863-5266**

Constant current circuit  
Source voltage: 100 VAC  
Operating current:  
6 A/phase, 2-phase  
energization (full-step)  
Pull-out torque:  
 $J_L=44 \times 10^{-4} \text{kg} \cdot \text{m}^2$  (use the  
rubber coupling)  
 $f_s$ : Maximum self-start  
frequency when not  
loaded

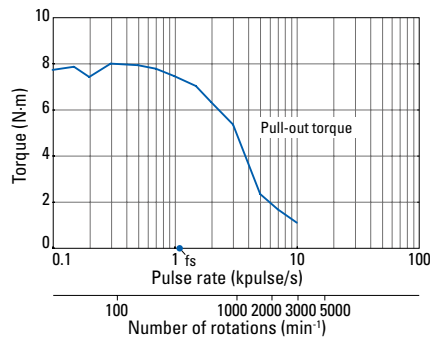

## Dimensions (Unit: mm)

### Lead wire type

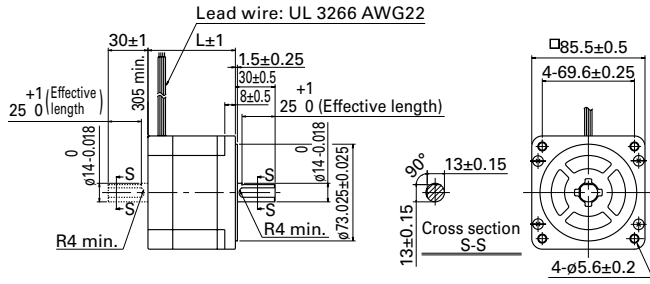

### Terminal block type CE/UL model

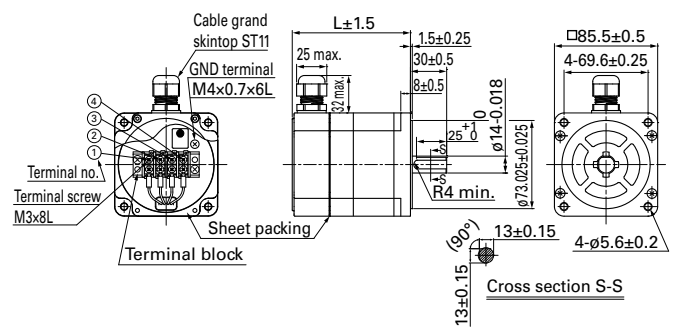

### Lead wire type CE/UL model

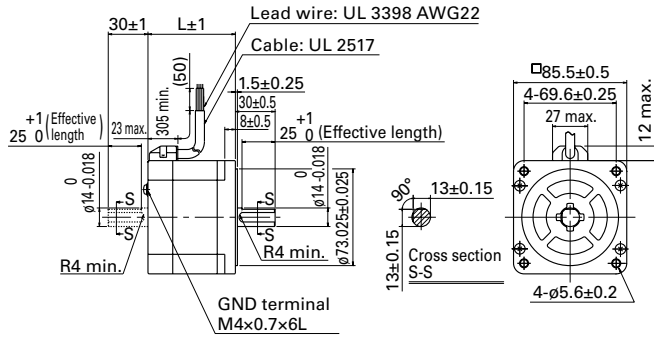

## Internal wiring

### Lead wire type

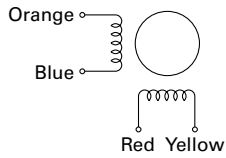

### Terminal block type

( ) terminal block number

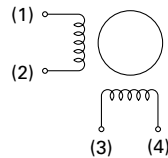

## Compatible drivers

Driver is not included.

If you require assistance finding a driver, contact us for details.



# ∅106 mm

1.8°/step **RoHS**

Unipolar winding, Lead wire type  
Bipolar winding, Lead wire type

### Customizing

Hollow Shaft modification  
Brake

Varies depending on the model number and quantity. Contact us for details.

#### Unipolar winding, Lead wire type

Model no.		Holding torque at 2-phase energization	Rated current	Wiring resistance	Winding inductance	Rotor inertia	Mass	Motor length (L)
Single shaft	Dual shaft	N·m min.	A/phase	Ω/phase	mH/phase	$\times 10^{-4}$ kg·m <sup>2</sup>	kg	mm
103H89222-0941	103H89222-0911	10.8	4	0.98	6.3	14.6	7.5	163.3
103H89223-0941	103H89223-0911	15.5	4	1.4	9.7	22	10.5	221.3

#### Bipolar winding, Lead wire type

Model no.		Holding torque at 2-phase energization	Rated current	Wiring resistance	Winding inductance	Rotor inertia	Mass	Motor length (L)
Single shaft	Dual shaft	N·m min.	A/phase	Ω/phase	mH/phase	$\times 10^{-4}$ kg·m <sup>2</sup>	kg	mm
103H89222-5241	103H89222-5211	13.2	6	0.45	5.4	14.6	7.5	163.3
103H89223-5241	103H89223-5211	19	6	0.63	8	22	10.5	221.3

## Characteristics diagram

### 103H89222-0941 103H89222-0911

Constant current circuit  
Source voltage: 100 VAC  
Operating current:  
4 A/phase, 2-phase  
energization (full-step)  
Pull-out torque:  
 $J_L=44 \times 10^{-4}$ kg·m<sup>2</sup> (use the  
rubber coupling)  
fs: Maximum self-start  
frequency when not  
loaded

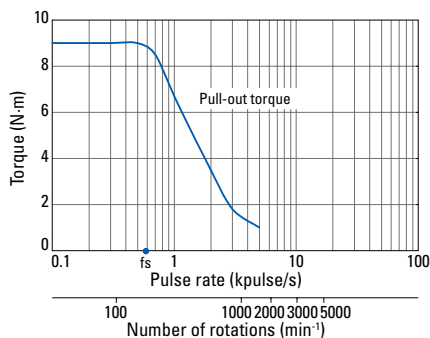

### 103H89223-0941 103H89223-0911

Constant current circuit  
Source voltage: 100 VAC  
Operating current:  
4 A/phase, 2-phase  
energization (full-step)  
Pull-out torque:  
 $J_L=44 \times 10^{-4}$ kg·m<sup>2</sup> (use the  
rubber coupling)  
fs: Maximum self-start  
frequency when not  
loaded

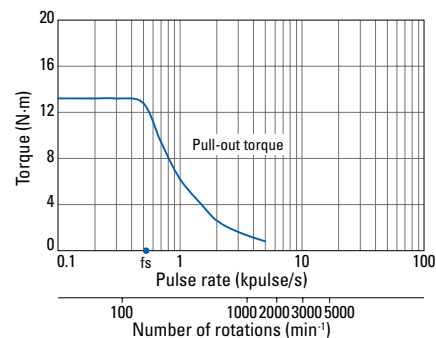

### 103H89222-5241 103H89222-5211

Constant current circuit  
Source voltage: 100 VAC  
Operating current:  
6 A/phase, 2-phase  
energization (full-step)  
Pull-out torque:  
 $J_L=44 \times 10^{-4}$ kg·m<sup>2</sup> (use the  
rubber coupling)  
fs: Maximum self-start  
frequency when not  
loaded

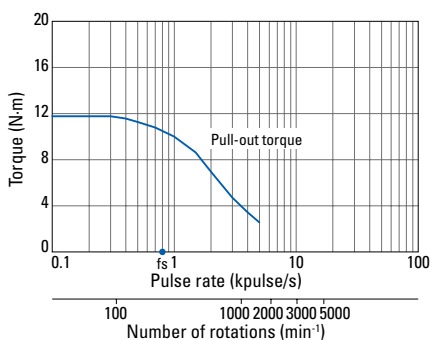

### 103H89223-5241 103H89223-5211

Constant current circuit  
Source voltage: 100 VAC  
Operating current:  
6 A/phase, 2-phase  
energization (full-step)  
Pull-out torque:  
 $J_L=44 \times 10^{-4}$ kg·m<sup>2</sup> (use the  
rubber coupling)  
fs: Maximum self-start  
frequency when not  
loaded

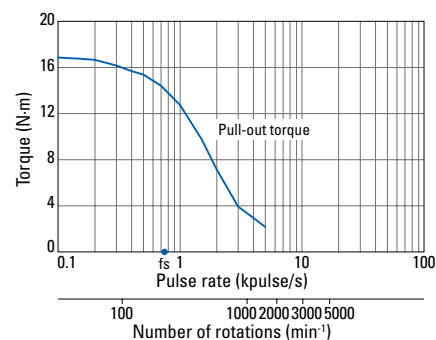

## Dimensions (Unit: mm)

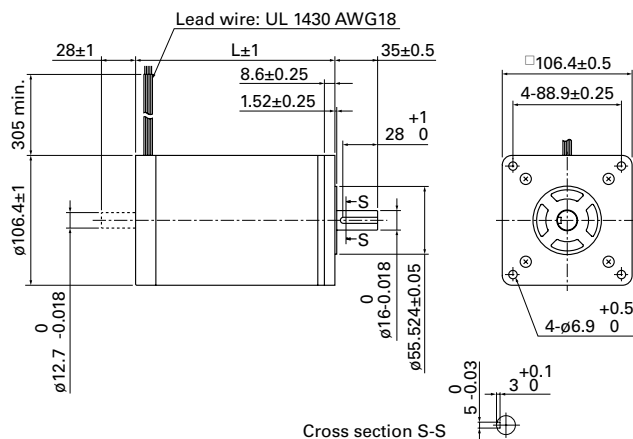

## Internal wiring

### Unipolar

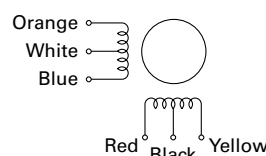

### Bipolar

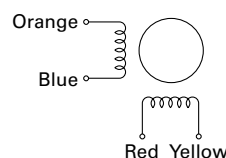

## Compatible drivers

Driver is not included.

If you require assistance finding a driver, contact us for details.

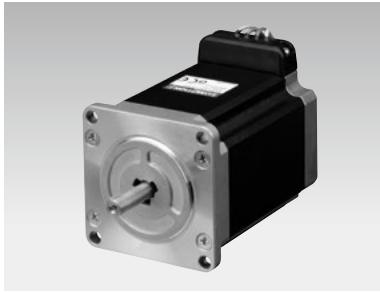

# 56 mm sq.

1.8°/step **RoHS**

Unipolar winding, Lead wire type CE model



### Customizing

**Hollow** **Shaft modification**

Varies depending on the model number and quantity. Contact us for details.

### Unipolar winding, Lead wire type CE model

Model no.		Holding torque at 2-phase energization	Rated current	Wiring resistance	Winding inductance	Rotor inertia	Mass	Motor length (L)
Single shaft	Dual shaft	N·m min.	A/phase	Ω/phase	mH/phase	×10 <sup>-4</sup> kg·m <sup>2</sup>	kg	mm
<b>103H7121-6140</b>	<b>103H7121-6110</b>	0.39	1	4.8	8	0.1	0.47	41.8
<b>103H7121-6740</b>	<b>103H7121-6710</b>	0.39	3	0.6	0.8	0.1	0.47	41.8
<b>103H7123-6140</b>	<b>103H7123-6110</b>	0.83	1	6.7	15	0.21	0.65	53.8
<b>103H7123-6740</b>	<b>103H7123-6710</b>	0.78	3	0.77	1.58	0.21	0.65	53.8
<b>103H7126-6140</b>	<b>103H7126-6110</b>	1.27	1	8.6	19	0.36	0.98	75.8
<b>103H7126-6740</b>	<b>103H7126-6710</b>	1.27	3	0.9	2.2	0.36	0.98	75.8

## Characteristics diagram

### 103H7121-6140 103H7121-6110

Constant current circuit  
Source voltage: 24 VDC  
Operating current:  
1 A/phase, 2-phase  
energization (full-step)  
Pull-out torque:  
 $J_L=0.94 \times 10^{-4} \text{kg}\cdot\text{m}^2$  (use the  
rubber coupling)  
fs: Maximum self-start  
frequency when not  
loaded

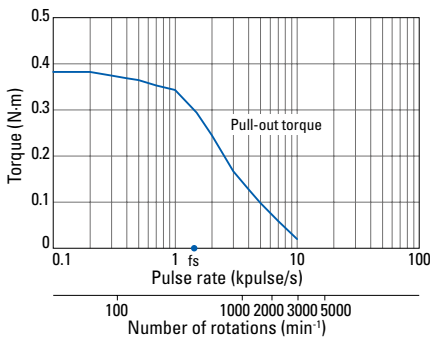

### 103H7121-6740 103H7121-6710

Constant current circuit  
Source voltage: 24 VDC  
Operating current:  
3 A/phase, 2-phase  
energization (full-step)  
Pull-out torque:  
 $J_L=0.94 \times 10^{-4} \text{kg}\cdot\text{m}^2$  (use the  
rubber coupling)  
fs: Maximum self-start  
frequency when not  
loaded

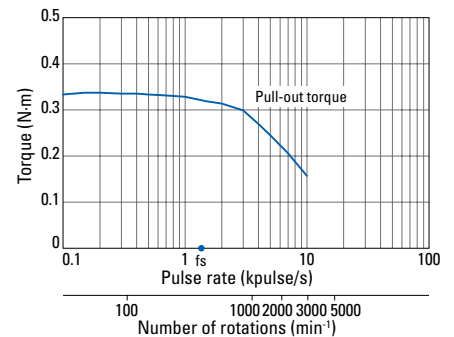

### 103H7123-6140 103H7123-6110

Constant current circuit  
Source voltage: 24 VDC  
Operating current:  
1 A/phase, 2-phase  
energization (full-step)  
Pull-out torque:  
 $J_L=0.94 \times 10^{-4} \text{kg}\cdot\text{m}^2$  (use the  
rubber coupling)  
fs: Maximum self-start  
frequency when not  
loaded

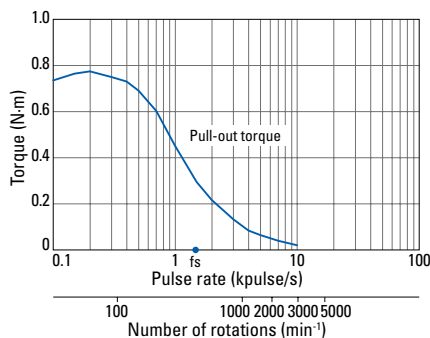

### 103H7123-6740 103H7123-6710

Constant current circuit  
Source voltage: 24 VDC  
Operating current:  
3 A/phase, 2-phase  
energization (full-step)  
Pull-out torque:  
 $J_L=0.94 \times 10^{-4} \text{kg}\cdot\text{m}^2$  (use the  
rubber coupling)  
fs: Maximum self-start  
frequency when not  
loaded

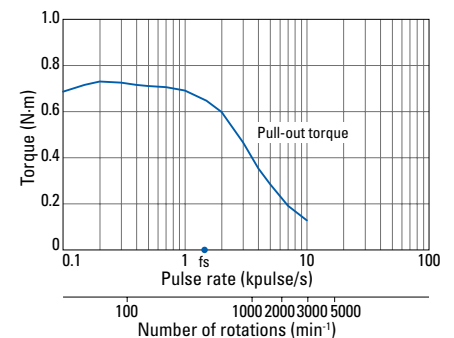

### 103H7126-6140 103H7126-6110

Constant current circuit  
Source voltage: 24 VDC  
Operating current:  
1 A/phase, 2-phase  
energization (full-step)  
Pull-out torque:  
 $J_L=2.6 \times 10^{-4} \text{kg}\cdot\text{m}^2$  (use the  
rubber coupling)  
fs: Maximum self-start  
frequency when not  
loaded

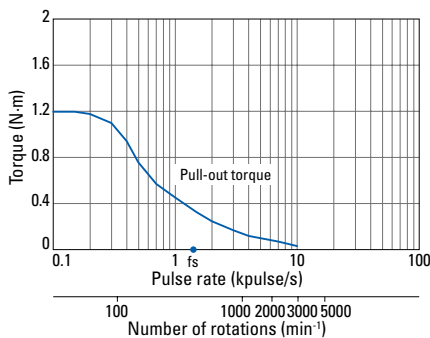

### 103H7126-6740 103H7126-6710

Constant current circuit  
Source voltage: 24 VDC  
Operating current:  
3 A/phase, 2-phase  
energization (full-step)  
Pull-out torque:  
 $J_L=2.6 \times 10^{-4} \text{kg}\cdot\text{m}^2$  (use the  
rubber coupling)  
fs: Maximum self-start  
frequency when not  
loaded

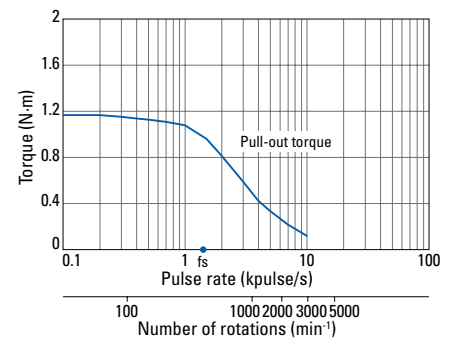

## Dimensions (Unit: mm)

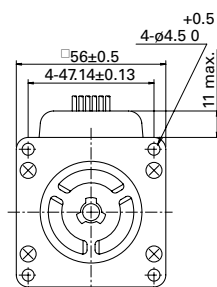
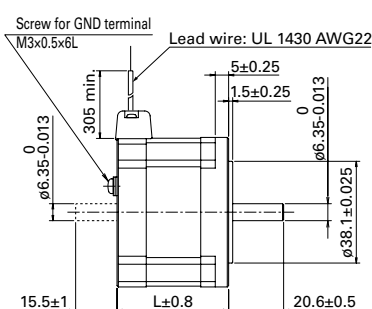

## Internal wiring

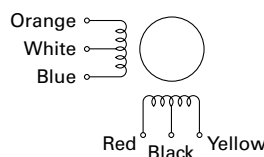

## Compatible drivers

- For motor model no. 103H712 □ -67 □ 0 (3 A/phase)  
Driver is not included.  
If you require assistance finding a driver, contact us for details.
- For motors not listed above (1 A/phase)  
Model no.: US1D200P10 (DC input)  
Operating current select switch setting: A



# ø86 mm

 1.8°/step RoHS

Bipolar winding, Lead wire type CE model



### Customizing

Hollow Shaft modification

Varies depending on the model number and quantity. Contact us for details.

#### Bipolar winding, Lead wire type CE model

Model no.		Holding torque at 2-phase energization	Rated current	Wiring resistance	Winding inductance	Rotor inertia	Mass	Motor length (L)
Single shaft	Dual shaft	N·m min.	A/phase	Ω/phase	mH/phase	×10 <sup>-4</sup> kg·m <sup>2</sup>	kg	mm
<b>103H8221-6240</b>	<b>103H8221-6210</b>	2.74	6	0.3	1.65	1.45	1.5	62
<b>103H8222-6340</b>	<b>103H8222-6310</b>	5.09	6	0.35	2.7	2.9	2.5	92.2
<b>103H8223-6340</b>	<b>103H8223-6310</b>	7.44	6	0.45	3.4	4.4	3.5	125.9

## Characteristics diagram

### 103H8221-6240 103H8221-6210

Constant current circuit  
Source voltage: 100 VAC  
Operating current:  
6 A/phase, 2-phase  
energization (full-step)  
Pull-out torque:  
 $J_L=7.4 \times 10^{-4} \text{kg}\cdot\text{m}^2$  (use the  
rubber coupling)  
fs: Maximum self-start  
frequency when not  
loaded

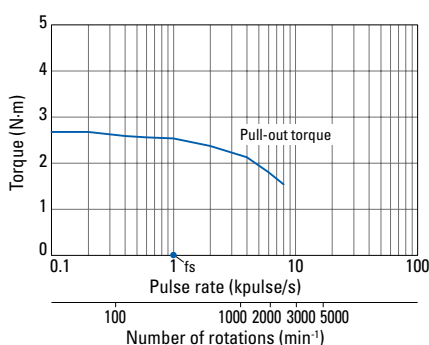

### 103H8222-6340 103H8222-6310

Constant current circuit  
Source voltage: 100 VAC  
Operating current:  
6 A/phase, 2-phase  
energization (full-step)  
Pull-out torque:  
 $J_L=15.3 \times 10^{-4} \text{kg}\cdot\text{m}^2$  (use the  
rubber coupling)  
fs: Maximum self-start  
frequency when not  
loaded

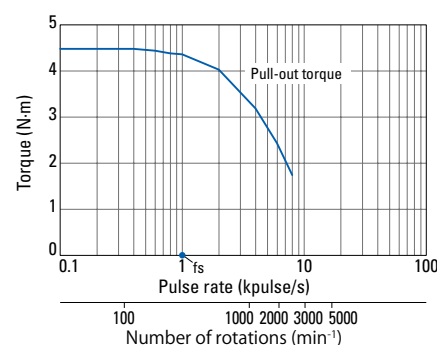

### 103H8223-6340 103H8223-6310

Constant current circuit  
Source voltage: 100 VAC  
Operating current:  
6 A/phase, 2-phase  
energization (full-step)  
Pull-out torque:  
 $J_L=44 \times 10^{-4} \text{kg}\cdot\text{m}^2$  (use the  
rubber coupling)  
fs: Maximum self-start  
frequency when not  
loaded

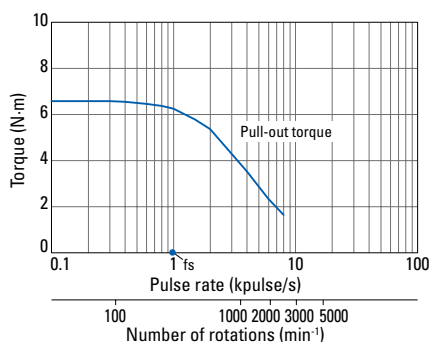

## Dimensions (Unit: mm)

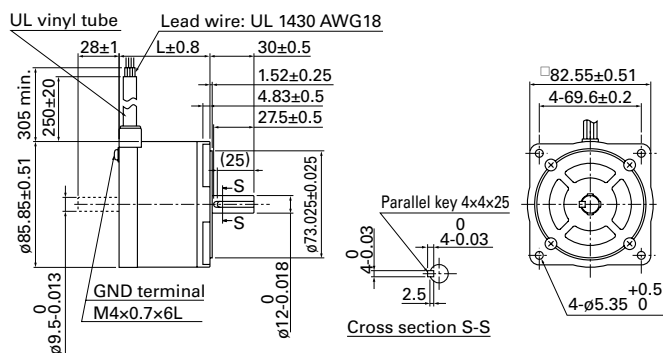

## Internal wiring

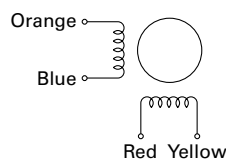

## Compatible drivers

Driver is not included.  
If you require assistance  
finding a driver, contact us for  
details.



# ∅106 mm

1.8°/step RoHS

Bipolar winding, Lead wire type CE model



### Customizing

Hollow Shaft modification

Varies depending on the model number and quantity. Contact us for details.

### Bipolar winding, Lead wire type CE model

Model no.		Holding torque at 2-phase energization	Rated current	Wiring resistance	Winding inductance	Rotor inertia	Mass	Motor length (L)
Single shaft	Dual shaft	N·m min.	A/phase	Ω/phase	mH/phase	×10 <sup>-4</sup> kg·m <sup>2</sup>	kg	mm
103H89222-6341	103H89222-6311	13.2	6	0.45	5.4	14.6	7.5	163.3
103H89223-6341	103H89223-6311	19	6	0.63	8	22	10.5	221.3

## Characteristics diagram

**103H89222-6341**  
**103H89222-6311**

Constant current circuit  
Source voltage: 100 VAC  
Operating current:  
6 A/phase, 2-phase  
energization (full-step)  
Pull-out torque:  
 $J_L=44 \times 10^{-4} \text{kg} \cdot \text{m}^2$  (use the  
rubber coupling)  
fs: Maximum self-start  
frequency when not  
loaded

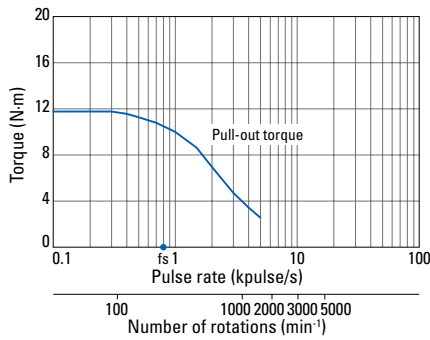

**103H89223-6341**  
**103H89223-6311**

Constant current circuit  
Source voltage: 100 VAC  
Operating current:  
6 A/phase, 2-phase  
energization (full-step)  
Pull-out torque:  
 $J_L=44 \times 10^{-4} \text{kg} \cdot \text{m}^2$  (use the  
rubber coupling)  
fs: Maximum self-start  
frequency when not  
loaded

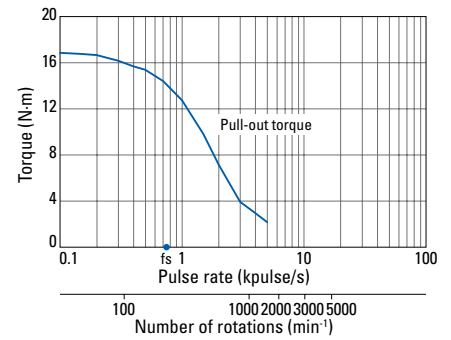

## Dimensions (Unit: mm)

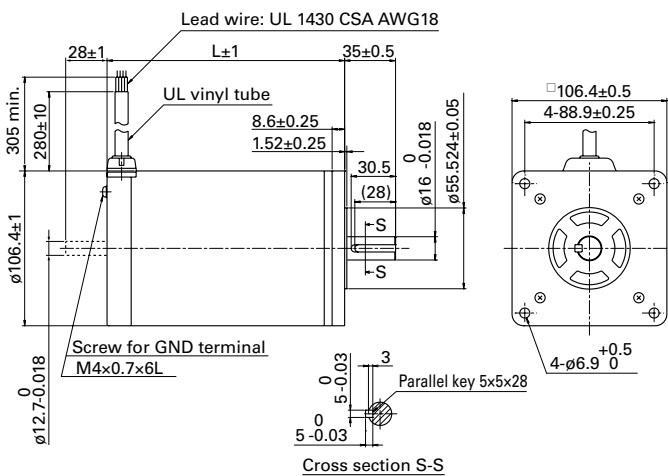

## Internal wiring

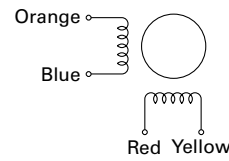

## Compatible drivers

Driver is not included.

If you require assistance finding a driver, contact us for details.

# Allowable Radial/Thrust Load

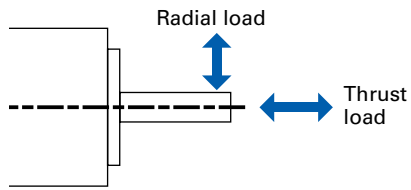

Motor size	Model no.	Distance from end of shaft: mm				Thrust load N
		0	5	10	15	
<b>14 mm sq.</b>	SH214 □	10	11	13	—	0.7
<b>28 mm sq.</b>	SH228 □	42	48	56	66	3
<b>35 mm sq.</b>	SH353 □	40	50	67	98	10
<b>42 mm sq.</b>	SF242 □	20	29	49	68	10
	SH142 □	22	26	33	46	
	SS242 □	10	—	—	—	4.9
<b>50 mm sq.</b>	103H670 □	71	87	115	167	15
	SS250 □	8.5	—	—	—	4.9
<b>56 mm sq.</b>	103H712 □	52	65	85	123	15
	103H7128	85	105	138	200	15
<b>60 mm sq.</b>	103H782 □	70	87	114	165	20
	SH160 □					15
<b>86 mm sq.</b>	SM286 □	167	193	229	280	60
	SH286 □					
<b>ø86 mm</b>	103H822 □	191	234	301	421	60
<b>ø106 mm</b>	103H8922 □	321	356	401	457	100

## Internal Wiring and Rotation Direction

### Unipolar winding

Connector type model no.: SF242

#### Internal wire connection

( ) connector pin number

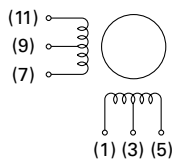

#### Direction of motor rotation

When excited by a direct current in the order shown below, the direction of rotation is clockwise as viewed from the output shaft side.

		Connector pin no.				
		(3, 9)	(1)	(7)	(5)	(11)
Exciting order	1	+	-	-	-	-
	2	+	-	-	-	-
	3	+	-	-	-	-
	4	+	-	-	-	-

Connector type model no.: 103H782

#### Internal wire connection

( ) connector pin number

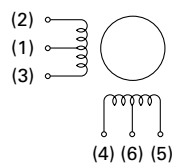

#### Direction of motor rotation

When excited by a direct current in the order shown below, the direction of rotation is clockwise as viewed from the output shaft side.

		Connector pin no.				
		(1, 6)	(4)	(3)	(5)	(2)
Exciting order	1	+	-	-	-	-
	2	+	-	-	-	-
	3	+	-	-	-	-
	4	+	-	-	-	-

Lead wire type

#### Internal wire connection

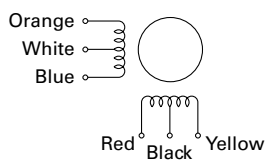

#### Direction of motor rotation

When excited by a direct current in the order shown below, the direction of rotation is clockwise as viewed from the output shaft side.

		Lead wire color				
		White, black	Red	Blue	Yellow	Orange
Exciting order	1	+	-	-	-	-
	2	+	-	-	-	-
	3	+	-	-	-	-
	4	+	-	-	-	-

### Bipolar winding

Connector type model no.: SF242

#### Internal wire connection

( ) connector pin number

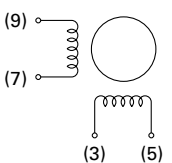

#### Direction of motor rotation

When excited by a direct current in the order shown below, the direction of rotation is clockwise as viewed from the output shaft side.

		Connector pin no.			
		(3)	(7)	(5)	(9)
Exciting order	1	-	-	+	+
	2	+	-	-	+
	3	+	+	-	-
	4	-	+	+	-

Connector type model no.: 103H782

#### Internal wire connection

( ) connector pin number

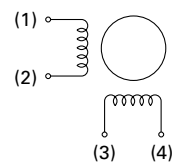

#### Direction of motor rotation

When excited by a direct current in the order shown below, the direction of rotation is clockwise as viewed from the output shaft side.

		Connector pin no.			
		(3)	(2)	(4)	(1)
Exciting order	1	-	-	+	+
	2	+	-	-	+
	3	+	+	-	-
	4	-	+	+	-

Lead wire type

#### Internal wire connection

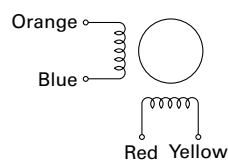

#### Direction of motor rotation

When excited by a direct current in the order shown below, the direction of rotation is clockwise as viewed from the output shaft side.

		Lead wire color			
		Red	Blue	Yellow	Orange
Exciting order	1	-	-	+	+
	2	+	-	-	+
	3	+	+	-	-
	4	-	+	+	-



# General Specifications

Motor model no.	SH214 <input type="checkbox"/>	SH228 <input type="checkbox"/>	SH353 <input type="checkbox"/>	SS242 <input type="checkbox"/>	SH142 <input type="checkbox"/>	SF242 <input type="checkbox"/>	SS250 <input type="checkbox"/>	103H670 <input type="checkbox"/>	103H712 <input type="checkbox"/>
Type	-								
Operating ambient temperature	-10 to +50°C								
Storage temperature	-20 to +65°C								
Operating ambient humidity	20 to 90% RH (no condensation)								
Storage humidity	5 to 95% RH (no condensation)								
Operation altitude	1000 m max. above sea level								
Vibration resistance	Vibration frequency 10 to 500 Hz, total amplitude 1.52 mm (10 to 70 Hz), vibration acceleration 150 m/s <sup>2</sup> (70 to 500 Hz), sweep time 15 min/cycle, 12 sweeps in each X, Y and Z direction.								
Impact resistance	500 m/s <sup>2</sup> of acceleration for 11 ms with half-sine wave applying three times for X, Y, and Z axes each, 18 times in total.								
Thermal class	Class B (+130°C)								
Withstandable voltage	At normal temperature and humidity, no failure with 500 VAC @50/60 Hz applied for one minute between motor winding and frame.							At normal temperature and humidity, no failure with 1000 VAC @50/60 Hz applied for one minute between motor winding and frame.	
Insulation resistance	At normal temperature and humidity, not less than 100 MΩ between winding and frame by 500 VDC megger.								
Protection grade	-								
Winding temperature rise	80 K max. (Based on SANYO DENKI standard)								
Static angle error	±0.09°				±0.054°		±0.09°		±0.054°
Thrust play *1	0.075 mm max. (load: 0.35 N)	0.075 mm max. (load: 1.5 N)	0.075 mm max. (load: 5 N)	0.075 mm max. (load: 4 N)	0.075 mm max. (load: 5 N)	0.075 mm (load: 5 N)	0.075 mm max. (load: 4 N)	0.075 mm (load: 10 N)	0.075 mm (load: 10 N)
Radial play *2	0.025 mm max. (load: 5 N)								
Shaft runout	0.025 mm								
Concentricity of mounting pilot relative to shaft	ø0.05 mm	ø0.05 mm	ø0.075 mm	ø0.075 mm	ø0.05 mm	ø0.05 mm	ø0.075 mm	ø0.075 mm	ø0.075 mm
Squareness of mounting surface relative to shaft	0.1 mm	0.1 mm	0.1 mm	0.1 mm	0.1 mm	0.1 mm	0.1 mm	0.075 mm	0.075 mm
Direction of motor mounting	Can be freely mounted vertically or horizontally								

Motor model no.	SH160 <input type="checkbox"/>	103H782 <input type="checkbox"/>	SH286 <input type="checkbox"/>	103H8922 <input type="checkbox"/>	SM286 <input type="checkbox"/>	103H712 <input type="checkbox"/> -6 <input type="checkbox"/> 0 <input type="checkbox"/> 0	103H822 <input type="checkbox"/> -6 <input type="checkbox"/> 0 <input type="checkbox"/> 0	103H8922 <input type="checkbox"/> -63 <input type="checkbox"/> 1	
Type	-				S1 (continuous operation)				
Operating ambient temperature	-10 to +50°C				-10 to +40°C				
Storage temperature	-20 to +65°C				-20 to +60°C				
Operating ambient humidity	20 to 90% RH (no condensation)				95% RH max. at 40°C or less (no condensation)				
Storage humidity	5 to 95% RH (no condensation)				95% RH max. at 40°C or less, 57% RH max. at 50°C or less, 35% RH max. at 60°C or less (no condensation)				
Operation altitude	1000 m max. above sea level								
Vibration resistance	Vibration frequency 10 to 500 Hz, total amplitude 1.52 mm (10 to 70 Hz), vibration acceleration 150 m/s <sup>2</sup> (70 to 500 Hz), sweep time 15 min/cycle, 12 sweeps in each X, Y and Z direction.								
Impact resistance	500 m/s <sup>2</sup> of acceleration for 11 ms with half-sine wave applying three times for X, Y and Z axes each, 18 times in total.								
Thermal class	Class B (+130°C)				Class F (+155°C)	Class B (+130°C)			
Withstandable voltage	At normal temperature and humidity, no failure with 1000 VAC @50/60 Hz applied for one minute between motor winding and frame.				At normal temperature and humidity, no failure with 1500 VAC @50/60 Hz applied for one minute between motor winding and frame.				
Insulation resistance	At normal temperature and humidity, not less than 100 MΩ between winding and frame by 500 VDC megger.								
Protection grade	-				IP43				
Winding temperature rise	80 K max. (Based on SANYO DENKI standard)								
Static angle error	±0.054°		±0.09°		±0.054°		±0.09°		
Thrust play *1	0.075 mm max. (load: 10 N)								
Radial play *2	0.025 mm (load: 5 N)	0.025 mm (load: 5 N)	0.025 mm (load: 5 N)	0.025 mm (load: 10 N)	0.025 mm (load: 5 N)	0.025 mm (load: 5 N)	0.025 mm (load: 5 N)	0.025 mm (load: 10 N)	0.025 mm (load: 10 N)
Shaft runout	0.025 mm								
Concentricity of mounting pilot relative to shaft	ø0.075 mm								
Squareness of mounting surface relative to shaft	0.1 mm	0.075 mm	0.15 mm	0.1 mm	0.15 mm	0.075 mm	0.1 mm	0.1 mm	0.1 mm
Direction of motor mounting	Can be freely mounted vertically or horizontally								

\*1 Thrust play: Shaft displacement under axial load.

\*2 Radial play: Shaft displacement under radial load applied 1/3rd of the length from the end of the shaft.

## Safety standards

Model no.: SM286  CE/UL marked models

CE (TÜV)	Standard category		Applicable standard
	Low-voltage directives		EN 60034-1, EN 60034-5
UL	Acquired standards	Applicable standard	File no.
	UL	UL 1004-1, UL 1004-6	E179832
	UL for Canada	CSA C22.2 No.100	

Model no.: 103H712  -6  0  0, 103H822  -6  0  0, 103H8922  -63  1 CE marked model

CE (TÜV)	Standard category		Applicable standard
	Low-voltage directives		EN 60034-1, EN 60034-5

# IP65 Splash and Dust Proof Stepping Motors Waterproof, dustproof

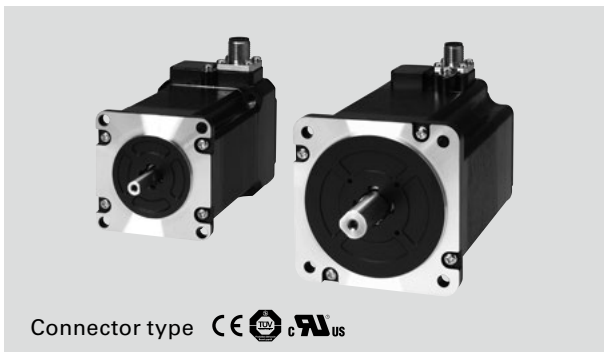
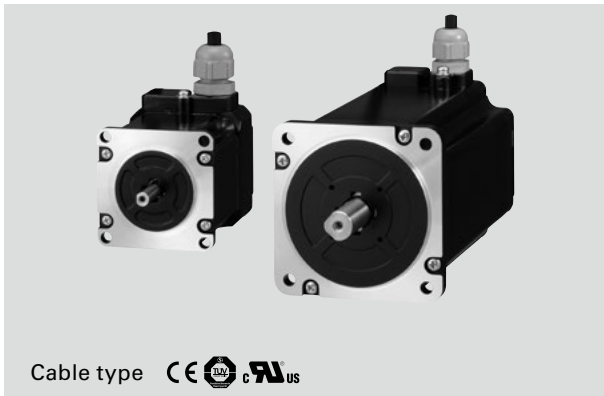

## Features

- These IP65 rated motors\* have superior water and dust resistance, and can be safely utilized in harsh or wet environments such as in food processing machines.

\*Except for the shaft and the cable end.

- The input voltage range of the motors is up to 250 VAC.
- Brake, encoder, and oil seal can be combined.

## Safety standards

CE/UL-certified.

## Specifications

	56 mm sq.	86 mm sq.
Motor model no.	SP256 □ -5 □ □ 0	SP286 □ -5 □ □ 0
Type	S1 (continuous operation)	
Operating ambient temperature	-10 to +40°C	
Storage temperature	-20 to +60°C	
Operating ambient humidity	95% RH max. at 40°C or less (no condensation)	
Storage humidity	95% RH max. at 40°C or less, 57% RH max. at 50°C or less, 35% RH max. at 60°C or less (no condensation)	
Operation altitude	1000 m max. above sea level	
Vibration resistance	Vibration frequency 10 to 500 Hz, total amplitude 1.52 mm (10 to 70 Hz), vibration acceleration 150 m/s <sup>2</sup> (70 to 500 Hz), sweep time 15 min/cycle, 12 sweeps in each X, Y and Z direction.	
Impact resistance	500 m/s <sup>2</sup> of acceleration for 11 ms with half-sine wave applying three times for X, Y and Z axes each, 18 times in total.	
Thermal class	Class F (+155°C)	
Withstandable voltage	At normal temperature and humidity, no failure with 1500 VAC @50/60 Hz applied for one minute between motor winding and frame.	
Insulation resistance	At normal temperature and humidity, not less than 100 MΩ between winding and frame by 500 VDC megger.	
Protection grade	IP65 (Except for the shaft and the cable end)	
Winding temperature rise	100 K max. (Based on SANYO DENKI standard)	
Static angle error	±0.054°	±0.09°
Thrust play	0.075 mm max. (load: 10 N)	
Radial play	0.025 mm max. (load: 5 N)	
Shaft runout	0.025 mm	
Concentricity of mounting pilot relative to shaft	ø0.075 mm	
Squareness of mounting surface relative to shaft	0.1 mm	0.15 mm
Direction of motor mounting	Can be freely mounted vertically or horizontally	

## Safety standards

CE	Standard category	Applicable standard	
	Low-voltage directives	EN 60034-1, EN 60034-5	
UL	Acquired standards	Applicable standard	File no.
	UL	UL 1004-1, UL 1004-6	E179832
	UL for Canada (c-UL)	CSA C22.2 No.100	

Model no. differs when the motor is equipped with a brake or oil seal.

74 Model no. and vibration resistance levels differ when the motor is equipped with a brake or oil seal.

## Internal wiring and rotation direction

Bipolar winding

Internal wire connection

( ) connector pin number

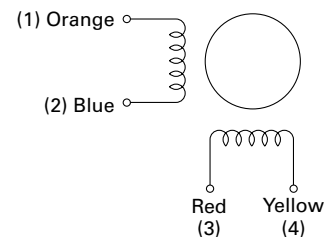

## Compatible drivers

Driver is not included.

If you require assistance finding a driver, contact us for details.

## Direction of motor rotation

The output shaft rotates clockwise as seen from the shaft side, when excited by DC in the following order.

Lead wire color	Red	Blue	Yellow	Orange
Connector pin no.	3	2	4	1
Exciting order	1	-	-	+
	2	+	-	-
	3	+	+	-
	4	-	+	+

# 56 mm sq.

1.8°/step RoHS

Bipolar winding

Model no.		Holding torque at 2-phase energization	Rated current	Winding resistance	Winding inductance	Rotor inertia	Mass	Allowable thrust load	Allowable radial load
Cable type	Connector type	N·m min.	A/phase	Ω/phase	mH/phase	$\times 10^{-4} \text{kg}\cdot\text{m}^2$	kg	N	N
SP2563-5060	SP2563-5000	1	1	5.8	29	0.21	0.9	15	52
SP2563-5160	SP2563-5100	1	2	1.5	7.3	0.21	0.9	15	52
SP2563-5260	SP2563-5200	1	3	0.75	3.4	0.21	0.9	15	52
SP2566-5060	SP2566-5000	1.7	1	7.8	35.4	0.36	1.2	15	23
SP2566-5160	SP2566-5100	1.7	2	2	9.2	0.36	1.2	15	23
SP2566-5260	SP2566-5200	1.7	3	1	4.4	0.36	1.2	15	23

· The model no., rotor inertia and mass differ when the motor is equipped with brake, encoder or oil seal.

## Characteristics diagram

**SP2563-5000**  
**SP2563-5060**

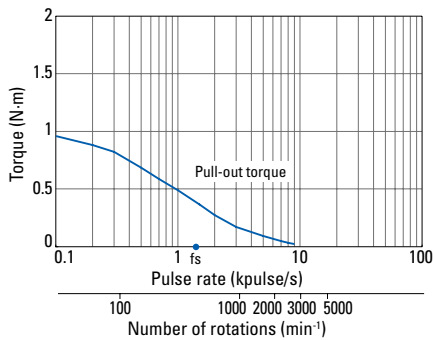

Constant current circuit  
Source voltage: 100 VAC  
Operating current: 1 A/phase, 2-phase energization (full-step)  
Pull-out torque:  $J_L=2.6 \times 10^{-4} \text{kg}\cdot\text{m}^2$  (use the rubber coupling)  
fs: Maximum self-start frequency when not loaded

**SP2563-5100**  
**SP2563-5160**

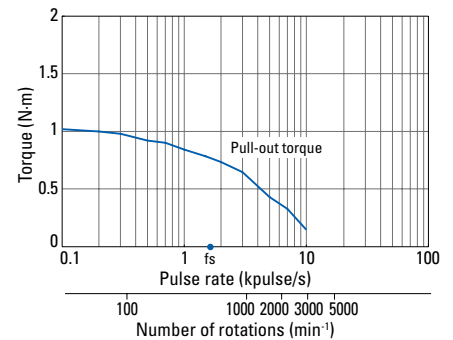

Constant current circuit  
Source voltage: 100 VAC  
Operating current: 2 A/phase, 2-phase energization (full-step)  
Pull-out torque:  $J_L=2.6 \times 10^{-4} \text{kg}\cdot\text{m}^2$  (use the rubber coupling)  
fs: Maximum self-start frequency when not loaded

**SP2563-5200**  
**SP2563-5260**

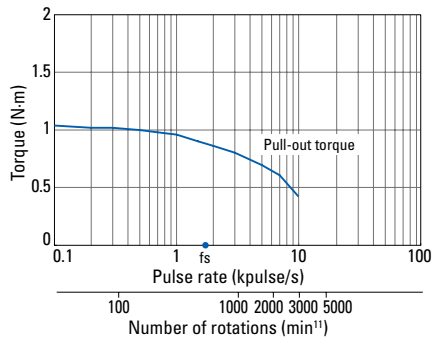

Constant current circuit  
Source voltage: 100 VAC  
Operating current: 3 A/phase, 2-phase energization (full-step)  
Pull-out torque:  $J_L=2.6 \times 10^{-4} \text{kg}\cdot\text{m}^2$  (use the rubber coupling)  
fs: Maximum self-start frequency when not loaded

**SP2566-5000**  
**SP2566-5060**

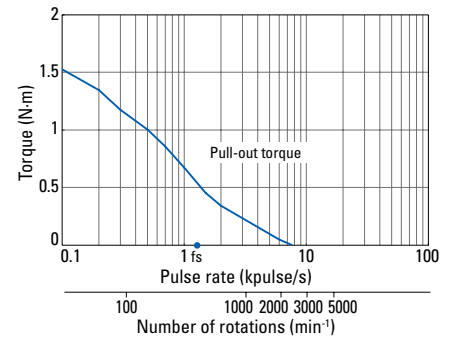

Constant current circuit  
Source voltage: 100 VAC  
Operating current: 1 A/phase, 2-phase energization (full-step)  
Pull-out torque:  $J_L=7.4 \times 10^{-4} \text{kg}\cdot\text{m}^2$  (use the rubber coupling)  
fs: Maximum self-start frequency when not loaded

**SP2566-5100**  
**SP2566-5160**

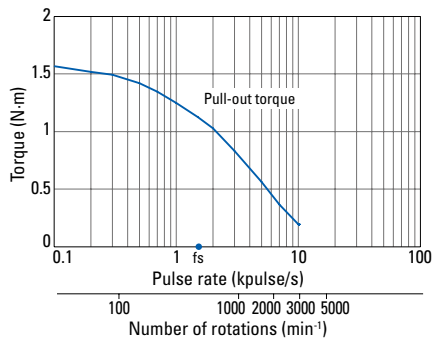

Constant current circuit  
Source voltage: 100 VAC  
Operating current: 2 A/phase, 2-phase energization (full-step)  
Pull-out torque:  $J_L=7.4 \times 10^{-4} \text{kg}\cdot\text{m}^2$  (use the rubber coupling)  
fs: Maximum self-start frequency when not loaded

**SP2566-5200**  
**SP2566-5260**

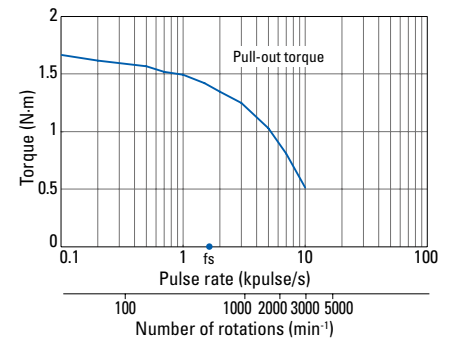

Constant current circuit  
Source voltage: 100 VAC  
Operating current: 3 A/phase, 2-phase energization (full-step)  
Pull-out torque:  $J_L=7.4 \times 10^{-4} \text{kg}\cdot\text{m}^2$  (use the rubber coupling)  
fs: Maximum self-start frequency when not loaded

# Dimensions (Unit: mm)

## 56 mm sq.

Cable type

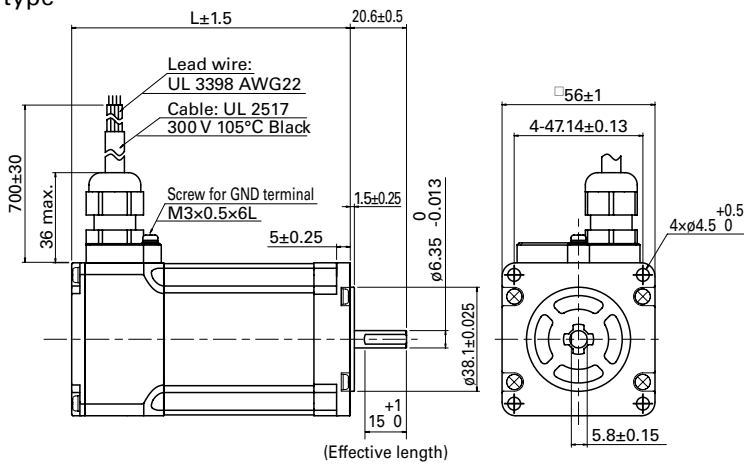

Connector type

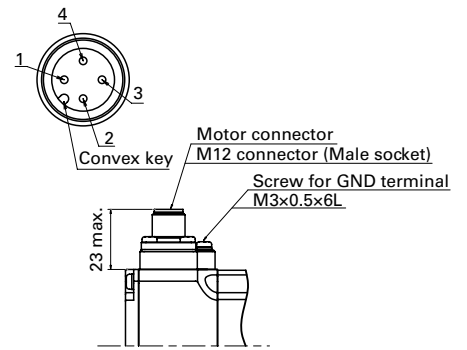

Model no.	Motor length (L)
SP2563-5 □ 60	80
SP2566-5 □ 60	102

# 86 mm sq.

1.8°/step RoHS

Bipolar winding

Model no.		Holding torque at 2-phase energization N·m min.	Rated current A/phase	Winding resistance		Winding inductance mH/phase	Rotor inertia $\times 10^{-4}$ kg·m <sup>2</sup>	Mass kg	Allowable thrust load N	Allowable radial load N
Cable type	Connector type			Cable type	Connector type					
SP2861-5060	SP2861-5000	3.3	2	2.1	2.05	15	1.48	1.95	60	200
SP2861-5160	SP2861-5100	3.3	4	0.61	0.56	3.7	1.48	1.95	60	200
SP2861-5260	—	3.3	6	0.36	—	1.7	1.48	1.95	60	200
SP2862-5060	SP2862-5000	6.4	2	3.2	3.2	25	3	3.1	60	200
SP2862-5160	SP2862-5100	6.4	4	0.85	0.83	6.4	3	3.1	60	200
SP2862-5260	—	6.4	6	0.41	—	2.8	3	3.1	60	200
SP2863-5060	SP2863-5000	9	2	4	4	32	4.5	4.2	60	200
SP2863-5160	SP2863-5100	9	4	1.05	1	7.9	4.5	4.2	60	200
SP2863-5260	—	9	6	0.53	—	3.8	4.5	4.2	60	200

- The model no., rotor inertia and mass differ when the motor is equipped with brake, encoder or oil seal.
- The rated current of the motor with the connector is 4 A or less.

## Characteristics diagram

**SP2861-5000**  
**SP2861-5060**

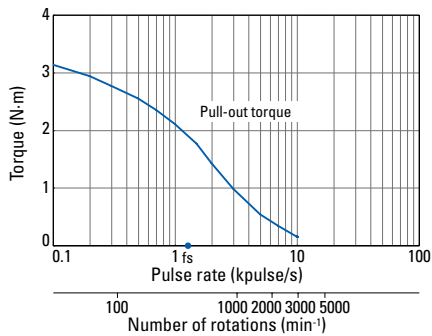

Constant current circuit  
Source voltage: 100 VAC  
Operating current: 2 A/phase, 2-phase energization (full-step)  
Pull-out torque:  $J_L=15.3 \times 10^{-4}$ kg·m<sup>2</sup> (use the rubber coupling)  
fs: Maximum self-start frequency when not loaded

**SP2861-5100**  
**SP2861-5160**

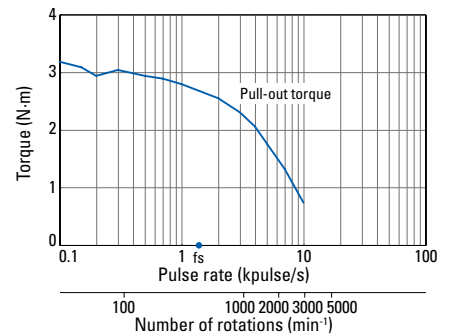

Constant current circuit  
Source voltage: 100 VAC  
Operating current: 4 A/phase, 2-phase energization (full-step)  
Pull-out torque:  $J_L=15.3 \times 10^{-4}$ kg·m<sup>2</sup> (use the rubber coupling)  
fs: Maximum self-start frequency when not loaded

**SP2861-5260**

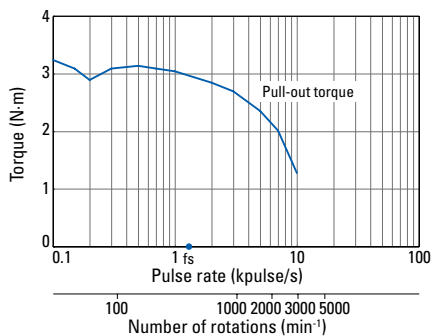

Constant current circuit  
Source voltage: 100 VAC  
Operating current: 6 A/phase, 2-phase energization (full-step)  
Pull-out torque:  $J_L=15.3 \times 10^{-4}$ kg·m<sup>2</sup> (use the rubber coupling)  
fs: Maximum self-start frequency when not loaded

**SP2862-5000**  
**SP2862-5060**

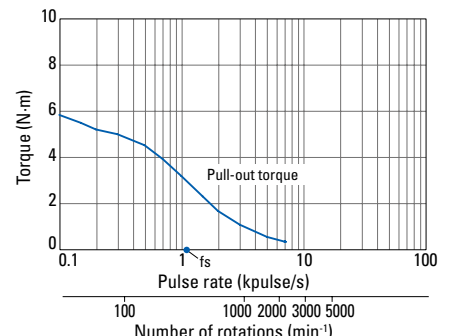

Constant current circuit  
Source voltage: 100 VAC  
Operating current: 2 A/phase, 2-phase energization (full-step)  
Pull-out torque:  $J_L=15.3 \times 10^{-4}$ kg·m<sup>2</sup> (use the rubber coupling)  
fs: Maximum self-start frequency when not loaded

**SP2862-5100**  
**SP2862-5160**

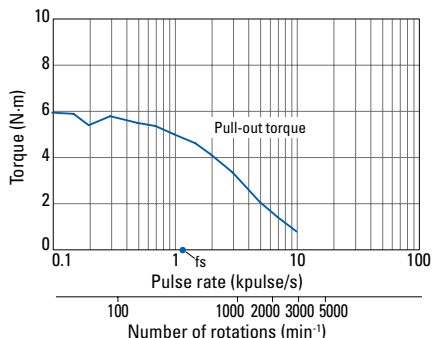

Constant current circuit  
Source voltage: 100 VAC  
Operating current: 4 A/phase, 2-phase energization (full-step)  
Pull-out torque:  $J_L=15.3 \times 10^{-4}$ kg·m<sup>2</sup> (use the rubber coupling)  
fs: Maximum self-start frequency when not loaded

**SP2862-5260**

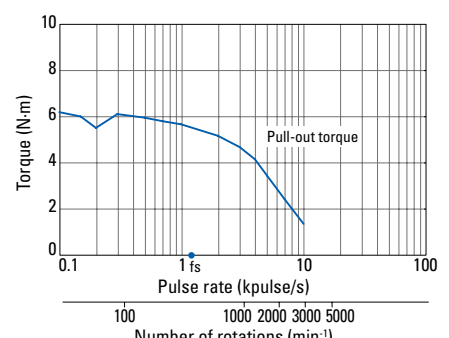

Constant current circuit  
Source voltage: 100 VAC  
Operating current: 6 A/phase, 2-phase energization (full-step)  
Pull-out torque:  $J_L=15.3 \times 10^{-4}$ kg·m<sup>2</sup> (use the rubber coupling)  
fs: Maximum self-start frequency when not loaded

## Characteristics diagram

**SP2863-5000**  
**SP2863-5060**

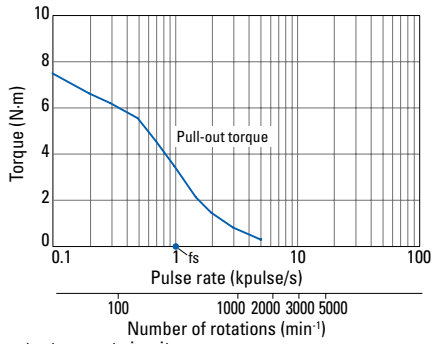

Constant current circuit  
Source voltage: 100 VAC  
Operating current: 2 A/phase, 2-phase energization (full-step)  
Pull-out torque:  $J_L=44 \times 10^{-4} \text{kg}\cdot\text{m}^2$  (use the rubber coupling)  
fs: Maximum self-start frequency when not loaded

**SP2863-5100**  
**SP2863-5160**

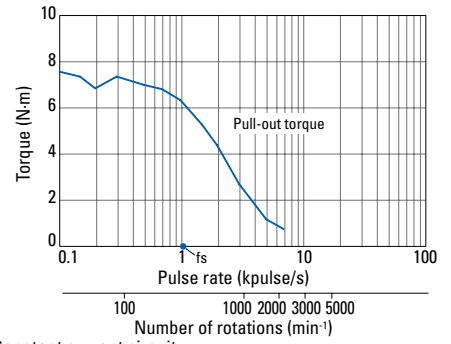

Constant current circuit  
Source voltage: 100 VAC  
Operating current: 4 A/phase, 2-phase energization (full-step)  
Pull-out torque:  $J_L=44 \times 10^{-4} \text{kg}\cdot\text{m}^2$  (use the rubber coupling)  
fs: Maximum self-start frequency when not loaded

**SP2863-5260**

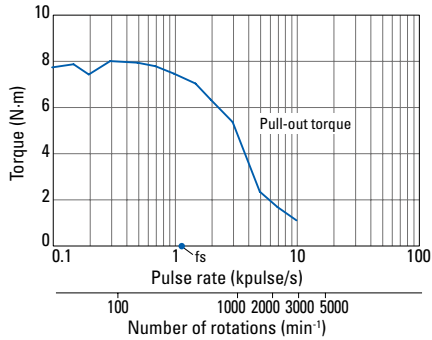

Constant current circuit  
Source voltage: 100 VAC  
Operating current: 6 A/phase, 2-phase energization (full-step)  
Pull-out torque:  $J_L=44 \times 10^{-4} \text{kg}\cdot\text{m}^2$  (use the rubber coupling)  
fs: Maximum self-start frequency when not loaded

## Dimensions (Unit: mm)

### 86 mm sq.

#### Cable type

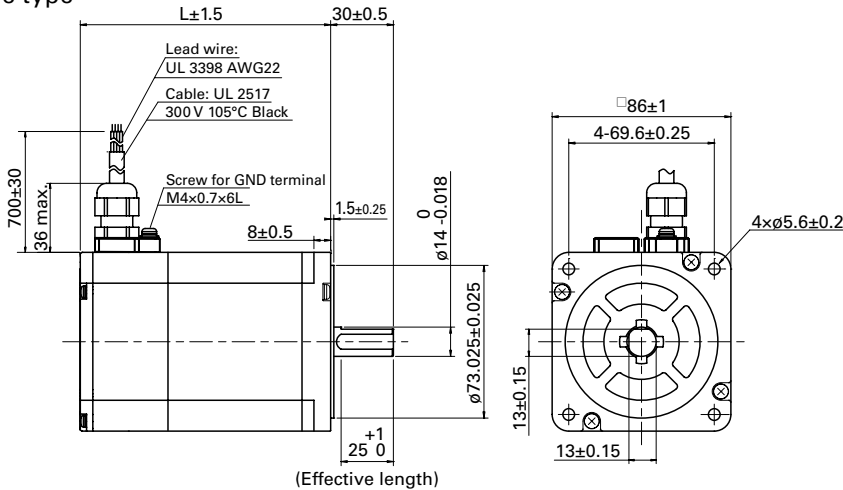

#### Connector type

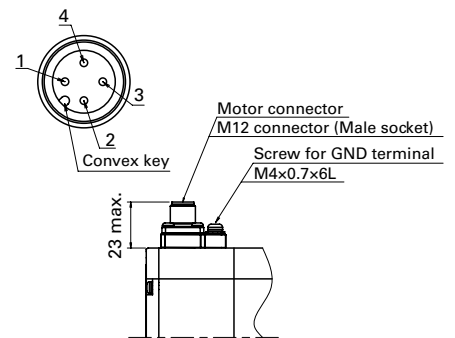

Model no.	Connector type	Motor length (L)
SP2861-5 □ 60	SP2861-5 □ 00	89.5
SP2862-5 □ 60	SP2862-5 □ 00	120
SP2863-5 □ 60	SP2863-5 □ 00	150

# Stepping Motors for Vacuum Environments Customized Products

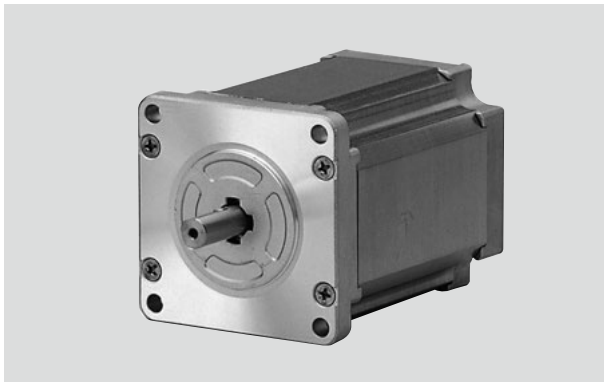

## Features

- These stepping motors can be driven in a vacuum environment without requiring a vacuum feedthrough. Use as vacuum-compatible actuators while retaining the stepping motor benefits of easy high-precision open-loop control.
- We can customize for a wide range of environment pressures, from low to ultra-high vacuums.
- Available baked at 200°C.
- Size is similar to that of typical stepping motors.

## Intended operating pressure

Low vacuum			Medium vacuum			High vacuum			Ultra-High vacuum				
$10^5$	$10^4$	$10^3$	$10^2$	$10^1$	1	$10^{-1}$	$10^{-2}$	$10^{-3}$	$10^{-4}$	$10^{-5}$	$10^{-6}$	$10^{-7}$	$10^{-8}$ [Pa]

## Applications

Ideal for the following applications. Contact us to discuss your particular application environment needs.

- Semiconductor manufacturing equipment
- Satellite robotics
- Electron microscopes
- Large-scale research facilities such as accelerators, synchrotron radiation analysis equipment, etc.

## Motor size

42 mm sq. to  $\phi 106$  mm

# Synchronous Motors Customized Products



## Features

- These motors always maintain a constant speed under variable load and voltage conditions, rotating in step with the frequency of the power supply. This eliminates motor slip.
- Provides high torque at ultraslow speeds with gearless construction.
- Allows for simplification by connecting directly to the commercial (AC) power supply, eliminating the need for a driver circuit.

## Applications

Ideal for the following applications. Contact us to discuss your particular application environment needs.

- Conveyor drives
- Printers
- Cryopumps
- Cryocoolers
- Switchgears

## Motor size

56 mm sq. to  $\phi 106$  mm

# Safety Precautions

The products in this catalog are designed to be used with general industrial devices. When using them, pay sufficient attention to the following points.

- Read the Operation Manual thoroughly prior to placement, assembly and/or operation in order to use the product properly.
- Refrain from modifying or processing the product in any way.
- Contact us or your point of sale for placement or maintenance services of the product.
- Regarding the following uses of the product, contact us or your point of sale for the special care required for operation, maintenance and management such as multiplexing the system, installing an emergency electric generator set, and so forth.

- ① Use in medical equipment that may have an effect on human life or the human body
- ② Use in transportation systems or transport-related equipment such as trains or elevators, that may have an effect on human life or the human body
- ③ Use in computer systems that may have an impact on society or on the public
- ④ Use in other devices that have a major impact on human safety or on maintaining public operations

- In addition to the above, contact us or your point of sale for use in an environment where vibrations occur, such as in automobiles or transport.
- For use in space, aviation, or nuclear power-related applications, contact us or your point of sale.
- The products shown in this catalog are subject to Japanese Export Control Law. Diversion contrary to the law of exporting country is prohibited.

## Indication by (Warning Label) on the Product

Either or all of the following indications are expressed by the Warning Labels depending on the type of driver or stepping motor.



This label is affixed near high voltage parts such as the electrically charged or cover-protected section, warning of the places where it is likely to cause an electric shock.



This label is affixed near the GND terminals of the driver for which grounding is required, recommending that the terminals should be well grounded.



This label is affixed for the driver to which the power source is applied in the voltage exceeding the safety standard, drawing attention to the risk of the electric shock.



Indicates that the stepping motor may get hot, resulting in burns.



Indicates that the stepping motor should be grounded.

## Safety Ranks of the Cautions

Following four ranks are provided.



**DANGER** Improper operations or use is most likely to result in serious injury or death.



**CAUTION** Improper operations or use is likely to result in average or minor injury, or in property damage.

In spite of the cautions with the  CAUTION label, it may cause serious results. Either the contents or the labels is describing important cautions to be followed inevitably.



**PROHIBITED** Indicates what must not be done.



**COMPULSORY** Indicates what must be done.





### General matters

1. Do not use the product in an explosive, flammable or corrosive atmosphere, watery place or near a combustible material. Doing so may cause injury or fire.
2. Have a person with expert knowledge on hand for performing the transportation, placement, wiring, operation, maintenance or inspection of the product. Without such knowledge, it may cause an electric shock, injury or fire.
3. Do not work on wiring, maintenance servicing or inspection with the electric power on. Perform either of those five minutes after turning the power off. Failure to do so may cause an electric shock.
4. When the protective functions of the product is activated, turn the power off immediately and eliminate the cause. If continuing the operation without eliminating the cause, the product may operate improperly and cause injury or a breakdown of the system devices.
5. Stepping motor may run out of order when operating and stopping depending on the magnitude of the load. Put the product into use after confirming with the adequate trial test operation in the maximum load conditions that the product operates reliably. Doing otherwise may cause a breakdown of the system. (Should the product run out of order in the use to drive upward/downward, it may cause a fall of the load.)
6. Do not touch the internal parts of the driver. Doing so may cause an electric shock.

### Wiring

7. Do not connect the stepping motor directly to a commercial power outlet. Doing so may cause an electric shock, injury or fire. Power should be supplied to the stepping motor through the driving circuit (except for synchronous motors).
8. Use an electric power source within the rated input voltage. Using otherwise may cause fire or an electric shock.
9. Connect the driver and stepping motor to the ground. Using without grounding may cause an electric shock.
10. Do not harm, forcibly put a stress, or load a heavy article on the cable or get it caught between the articles. Doing so may cause an electric shock.
11. Perform wiring with the power cable as instructed by the wiring diagram or the Operation Manual. Doing otherwise may cause an electric shock or fire.
12. Do not move the stepping motor cable, as it is not a movable cable. Doing so may result in electric shock, injury, or fire.

### Operation

13. Be sure not to touch the rotating part of the stepping motor during its operation. Touching it may cause injury.
14. Do not reach or touch the electric terminals while electric power is on. Doing so may cause an electric shock.
15. Never disconnect any of the connectors while electric power is on. Doing so may cause an electric shock and corruption.
16. Do not operate this product with live parts exposed. Doing so may result in electric shock.
17. If smoke, fire, unusual smells, or unusual sounds are produced from the driver or stepping motor, turn off the power and stop using this product immediately. Not doing so may result in electric shock, injury, or fire.



### General matters

1. Prior to placement, operation, maintenance servicing or inspection, be sure to read the Operation Manual and follow the instructions to perform. Failure to follow the instructions may cause an electric shock, injury or fire.
2. Do not use the driver or the stepping motor in conditions that exceed the specification values. Doing so may cause an electric shock, injury or fire.
3. Do not insert a finger or an object into the opening of the product. Doing so may cause an electric shock, injury or fire.

4. Do not use a damaged driver or stepping motor. Doing so may cause injury, fire or the like.
5. Use the driver and stepping motor in the designated combination. Using otherwise may cause fire or a trouble.
6. Be careful when the temperature rises in the operating driver, stepping motor or peripheral devices. Failure to be careful may cause a burn.
7. Never disassemble, repair, modify, or remanufacture this product. Doing so may result in electric shock, injury, or fire.
8. Do not remove the rating plate. Using this product with an incorrect rating may result in fire.
9. Be careful that this product does not fall or tip over when handling, as this can be dangerous.

### Unpacking

10. Confirm that the bottom and top of the box are facing correctly while unpacking. Failure to do so may cause injury.
11. Confirm that the product is the one that you have ordered. Installing an incorrect product may cause a breakdown.

### Wiring

12. Do not measure the insulation resistance or dielectric voltage of the product. Doing so may cause a breakdown. Contact us or your point of sale instead, if such a measurement is required.
13. Perform wiring conforming to the technical standards of electric facility or the internal rule. Doing otherwise may cause burning or fire.
14. Ensure that wiring has been correctly done. Incorrect wiring may cause the stepping motor to run out of control, resulting in injury.
15. Insulate the attached condenser and external resistance connection terminals. Failure to do so may cause an electric shock.

### Placement

16. Do not climb or attach a heavy article on the product. Doing so may cause injury.
17. Make sure that the intake and exhaust ports are not blocked or stuffed by foreign particles. Doing so may cause fire.
18. Make sure to use the specified driver mounting direction. Failure to do so will result in product failure.
19. Keep a distance as instructed by the Operation Manual for the driver from the inner surface of the control console or other devices. Failure to do so may cause trouble.
20. Place the product with great care so as to prevent from danger such as a tumble or a turnover.
21. Mount the product on an incombustible material such as metal. Failure to do so may cause fire, injury, or device breakdown.
22. Do not place combustible material around this product. Failure to do so may result in fire or burns.
23. Be sure to provide an adequate ventilation path when installing this product, and do not block the intake and exhaust ports. Failure to do so may result in electric shock, fire, or device breakdown.
24. Confirm the rotating direction before connecting with the mechanical device. Failure to do so may cause injury or a breakdown.
25. Do not touch the motor output spindle (including the key slot and gears) with your bare hand. Doing so may cause injury.
26. Make sure not to apply force to the lead wire or cables.

### Operation

27. The stepping motor is not equipped with any protective device. Take protective measures using an over-current protective relay, a ground fault interrupter, a protective device from excess temperature, and an emergency stopping device. Failure to do so may cause injury or fire.
28. Do not touch the product for a period after the power is on or has been turned off, since the driver and stepping motor remain at a high temperature. Doing so may cause burns. In particular, the temperature rises considerably of the stepping motor depending on the operating conditions.  
Do not allow the motor surface to exceed the following temperatures:
  - Thermal class F (+155°C) stepping motors: 125°C
  - Thermal class B (+130°C) stepping motors: 100°C
  - Regardless of thermal class, encoder equipped stepping motors: 85°C, stepping motors with built in drivers: 70°C, stepping

motors for vacuum environments: 150°C

29. Stop operations immediately when an emergency occurs. Failure to do so may cause an electric shock, injury or fire.
30. Do not change adjustment to an extreme, for such a change results in unstable operation. Doing so may cause injury.
31. During trial operations, firmly stabilize the stepping motor, and confirm operations by disconnecting from the mechanical system before connecting with it. Failure to do so may cause injury.
32. When the alarm has been activated, eliminate the cause and ensure safety before resuming operations. Failure to do so may cause injury.
33. When the electric power recovers after a momentary interruption, do not approach the devices because the system may restart operation by itself. (Set the system so as to secure the safety even when it restarts on such occasions.) Failure to do so may cause injury.
34. Confirm that the electric power supply properly conforms to the product specifications. Failure to do so may cause a breakdown.
35. The brake mechanism of the motor with the electro-magnetic brake is used to hold the movable section and the motor position. Do not use it as a safety measure. Doing so may cause the breakdown of the system.
36. Firmly stabilize the key when operating the motor with the key individually. Failure to do so may cause injury.

#### **Maintenance**

37. Be careful when performing maintenance services or inspection regarding the temperature which rises highly in the driver and stepping motor frame. Failure to do so may cause burns.
38. It is recommended to replace the electrolytic condenser of the driver with a new one for securing the preventive measure after using for 5 years (the expected life in an average operating environment of 40°C). The expected life of the fuse is 10 years in an average operating environment of 40°C. Thus, periodical replacement is recommended.
39. Contact us or your point of sale for repair. If the product is disassembled by the user, it may become inoperable.

#### **Transportation**

40. Handle the product with care during transportation so as to prevent from dangers such as tumbling or overturning.
41. Do not hold with the cable or the motor spindle. Doing so may cause trouble or injury.

#### **Retirement**

42. When scrapping the driver or stepping motor, handle it as general industrial waste.

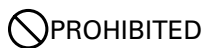

---

#### **Storage**

1. Avoid storing this product in places exposed to rain or water drops, or in an environment with hazardous gas or liquid. Failure to do so may cause trouble.

#### **Maintenance**

2. Do not disassemble or repair the product. Doing so may cause fire or an electric shock.

#### **General matters**

3. Do not remove the rating plate. Using this product with the incorrect rating may result in fire.



---

#### **Storage**

1. Store the product in a location that is not exposed to sunlight, at a temperature and humidity within the product specifications.
2. If the driver has been stored for a long period (3 years or longer as a general guide), contact us. The capacitance may have decreased with the electrolytic condenser due to the long period storage, which may cause trouble.

#### **Operation**

3. Install an external emergency stop circuit to turn the power off in the event that operation must be instantly halted.
4. Operate this product within the specified ambient temperature and humidity.

#### **Transportation**

5. Excess loading of the product on the carrier may cause the load to fall in pieces. Follow the instructions given outside the package.

## ■ Selection materials for each mechanism

The diagrams below depict representative mechanisms and the points used in their selection. Notify us of the information shown here when requesting us to make a selection.

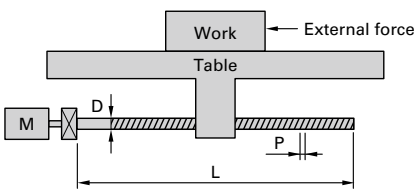
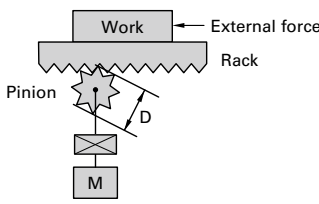
Ball screw			Rack and pinion		
					
External force	F	N	External force	F	N
Weight of work+table	W	kg	Work+rack weight	W	kg
Ball screw diameter	D	m	Pinion diameter	D	m
Ball screw length	L	m	Pinion thickness	L	m
Ball screw lead	P	m	Pinion material specific gravity	$\rho$	kg/m <sup>3</sup>
Ball screw material specific gravity	$\rho$	kg/m <sup>3</sup>	Friction coefficient	$\mu$	
Friction coefficient	$\mu$		Gear ratio*	G	
Gear ratio*	G		Mechanical efficiency	$\eta$	
Mechanical efficiency	$\eta$				

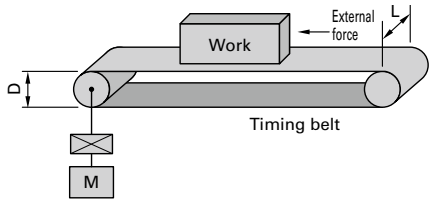
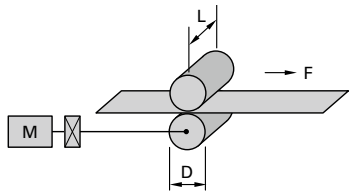
Belt drive			Roll feed		
					
External force	F	N	Sheet tension	F	N
Work+belt weight	W	kg	Roll diameter	D	m
Pulley diameter	D	m	Roll width	L	m
Pulley width	L	m	Roll material specific gravity	$\rho$	kg/m <sup>3</sup>
Pulley material specific gravity	$\rho$	kg/m <sup>3</sup>	Roll moment of inertia	J	kg-m <sup>2</sup>
Pulley moment of inertia	J	kg-m <sup>2</sup>	Gear ratio*	G	
Gear ratio*	G		Mechanical efficiency	$\eta$	
Mechanical efficiency	$\eta$				

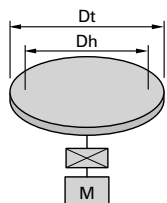
Rotary table		
		
Table weight	W	kg
Table diameter	Dt	m
Table support diameter	Dh	m
Table moment of inertia	J	kg-m <sup>2</sup>
Support area friction coefficient	$\mu$	
Gear ratio*	G	
Mechanical efficiency	$\eta$	

\*How to find the gear ratio (G)

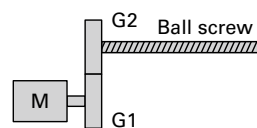

$$G = \frac{\text{Number of ball screw gears (G2)}}{\text{Number of motor gears (G1)}}$$

## Notes before Purchase

The products in this catalog are designed to be used with general industrial devices.

Always follow the following precautions.

- Read the accompanying Instruction Manual carefully prior to using the product.
- If applying to medical devices and other equipment affecting people's lives, please contact us beforehand and take appropriate safety measures.
- If applying to equipment that can have significant effects on society and the general public, please contact us beforehand.

· Do not use this product in an environment where vibration is present, such as in a moving vehicle or shipping vessel.

· Do not perform any retrofitting, re-engineering, or modification to this equipment.

· The products presented in this catalog are meant to be used for general industrial applications. If using for special applications related to aviation and space, nuclear power, electric power, submarine repeaters, and the like, please contact us beforehand.

<https://www.sanyodenki.com>

### **SANYO DENKI CO., LTD.**

3-33-1 Minami-Otsuka, Toshima-ku, Tokyo 170-8451, Japan

TEL: +81 3 5927 1020

### **SANYO DENKI EUROPE SA.**

P.A. Paris Nord II, 48 Allée des Erables-VILLEPINTE, BP.57286, F-95958 ROISSY CDG Cedex, France

TEL: +33 1 48 63 26 61

### **SANYO DENKI AMERICA, INC.**

468 Amapola Avenue Torrance, CA 90501, U.S.A.

TEL: +1 310 783 5400

### **SANYO DENKI SHANGHAI CO., LTD.**

Room 2106-2110, Bldg A, Far East International Plaza, No.319, Xianxia Road, Shanghai, 200051, China

TEL: +86 21 6235 1107

#### **Beijing Branch**

Room1222, Tower B, Beijing COFCO Plaza, No.8 Jianguomennei Dajie, Dong Cheng District, Beijing 100005 China

TEL: +86 10 6522 2160

### **SANYO DENKI (H.K.) CO., LIMITED**

Room 2305, 23/F, South Tower, Concordia Plaza, 1 Science Museum Road, TST East, Kowloon, Hong Kong

TEL: +852 2312 6250

### **SANYO DENKI TAIWAN CO., LTD.**

N-711, 7F, Chia Hsin 2nd Bldg., No.96, Sec.2, Zhongshan N. Rd., Taipei 10449, Taiwan

TEL: +886 2 2511 3938

### **SANYO DENKI SINGAPORE PTE. LTD.**

988 Toa Payoh North, #04-08, Singapore 319002

TEL: +65 6223 1071

#### **Indonesia Representative Office**

Summitmas II 4th Floor, Jl. Jend. Sudirman Kav.61-62, Jakarta 12190, Indonesia

TEL: + 62 21 252 3202

### **SANYO DENKI GERMANY GmbH**

Frankfurter Strasse 80-82, 65760 Eschborn, Germany

TEL: +49 6196 76113 0

### **SANYO DENKI KOREA CO., LTD.**

15F, KDB Building, 372, Hangang-daero, Yongsan-gu, Seoul, 04323, Korea

TEL: +82 2 773 5623

#### **Busan Branch**

8F, CJ Korea Express Bldg., 119, Daegyo-ro, Jung-gu, Busan, 48943, Korea

TEL: +82 51 796 5151

### **SANYO DENKI (Shenzhen) CO., LTD.**

2F 02-11, Shenzhen International Chamber of Commerce Tower, No.168 Fuhua 3 Road, Futian District, Shenzhen, 518048 China

TEL: +86 755 3337 3868

#### **Tianjin Branch**

Room AB 16th Floor TEDA Building, No. 256 Jie Fang Nan Road, Hexi District, Tianjin 300042 China

TEL: +86 22 2320 1186

#### **Chengdu Branch**

Room2105B, Block A, Times Plaza, 2 Zongfu Road, Jinjiang District, Chengdu, 610016 China

TEL: +86 28 8661 6901

### **SANYO DENKI (THAILAND) CO., LTD.**

388 Exchange Tower, 25th Floor, Unit 2501-1, Sukhumvit Road, Klongtoey, Klongtoey, Bangkok 10110 Thailand

TEL: +66 2261 8670

### **SANYO DENKI INDIA PRIVATE LIMITED**

#14 (Old No.6/3), Avenue Road, Nungambakkam, Chennai - 600034, Tamil Nadu, India

TEL: +91 44 420 384 72

## X-ON Electronics

Largest Supplier of Electrical and Electronic Components

*Click to view similar products for [Motor Drives](#) category:*

*Click to view products by [Sanyo Denki](#) manufacturer:*

Other Similar products are found below :

[GMA02](#) [1300920283](#) [ST10-Plus](#) [GMA11](#) [GMA20](#) [R88DUA03LAAC100V30W](#) [R88DUA12HA](#) [R88DUP03LAAC100V30W](#)  
[VFD002EL11A](#) [SR24](#) [R88D-GT04H](#) [R88D-GN04H-ML2](#) [R88D-KT01H](#) [R7D-BP01H](#) [R88D-KN04L-ECT](#) [26231941](#) [26231720](#) [70354063](#)  
[79294435](#) [27358015](#) [26231703](#) [15275008](#) [ST5-Q-EN](#) [STAC6-QE](#) [LE1M35Q705](#) [1SFA896103R1100](#) [1SFA896112R1100](#) [R88D-GP08H](#)  
[GNCF8-11](#) [ST10-IP-EE](#) [ST10-Q-RN](#) [26231801](#) [26231909](#) [1302263161](#) [TMCM-1636-48V-TMCL](#) [VX5A1300](#) [ATVRU75N4](#) [ATVRD15N4](#)  
[UDS1UR6M50CANCZ183](#) [103H5208-5240](#) [103H5210-5240](#) [103H7126-0740](#) [103H8221-6240](#) [103H5205-5240](#) [103H7126-1740](#) [103H7126-](#)  
[5740](#) [103H7822-5740](#) [103H7823-5740](#) [103H8222-6340](#) [111.3761.20.00E](#)