

### General

- Fast acting
- 1.6mm× 0.8mm physical size
- Thick film manufacturing method, ceramic substrate, silver fusing element
- -55°C~125°C operating temperature
- Excellent environmental integrity
- RoHS compliant
- Halogen-free
- Lead free

### Agency / Certificate Information

Agency	File Number	Ampere Range
	E319512	0.5A~6A

### Application

- Battery pack
- PC related equipment and peripherals (Hard driver, Printer, etc.)
- Digital camera (Digital still camera)
- Game equipment
- LCD monitor, LCD modules
- Wireless base station
- Power supply
- Medical device

### Electrical Specifications

Part Number	Marking	Current Rating (A)	Voltage Rating (V)	Interrupting Rating (V)	Typical Cold DCR* (mΩ)	Typical I <sup>2</sup> T** (A <sup>2</sup> s)
S0603-F-0.5A	F	0.5	32	50A 32V DC	870	0.0068
S0603-F-0.75A	G	0.75	32		389	0.0177
S0603-F-1.0A	H	1.0	32		210	0.0230
S0603-F-1.5A	K	1.5	32		85	0.0473
S0603-F-2.0A	N	2.0	32		47	0.0824
S0603-F-2.5A	O	2.5	32		30	0.1313
S0603-F-3.0A	P	3.0	32		25	0.1890
S0603-F-3.5A	R	3.5	32		21.5	0.2511
S0603-F-4.0A	S	4.0	32	35A 32V DC	16.0	0.3559
S0603-F-5.0A	T	5.0	32		10.7	0.7030
S0603-F-6.0A	6	6.0	32		9.5	1.5120

\* Measured at ≤10% rated current and 25°C

\*\* Melting I<sup>2</sup>T at 10 times of rated current

## Part Number Information

S 0603-F-1.0A

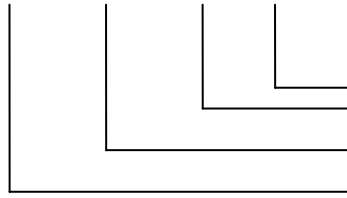

- "1.0A" Ampere Rating: 1A
- "F" Electrical Characteristic: F = Fast acting
- "0603" Size Number
- "S" Symbol of SART

## Dimensions

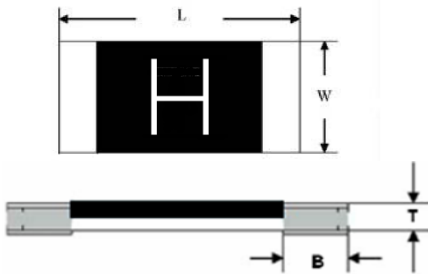

Type	L (mm)	W (mm)	T (mm)	B (mm)
S0603-F	1.60±0.15	0.80±0.15	0.40±0.10	0.30±0.20

## Recommended Land Patterns

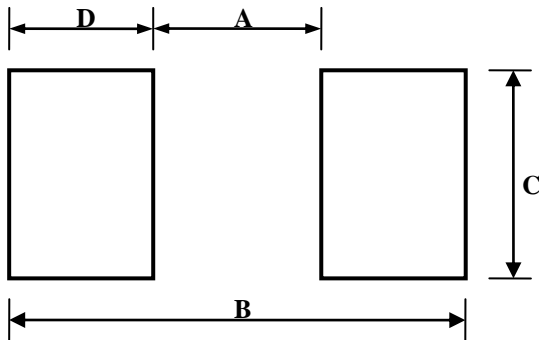

Dimensions	A(mm)	B(mm)	C(mm)	D(mm)
Spec	1.00±0.20	3.00±0.50	1.40±0.20	1.00±0.30

## Materials

Components	Material
Body	Ceramic
Terminations	Silver over plated with tin (100%)
Element	Silver or Silver/Palladium

## Dimensions of Standard Test Board

Type	Ampere Rating	Board Thickness (mm)	Copper Layer Thickness (mm)	Copper Trace Width (mm)
S0603-F	0.5A~6.0A	1.6	0.035	5.0

### Time Current Curve

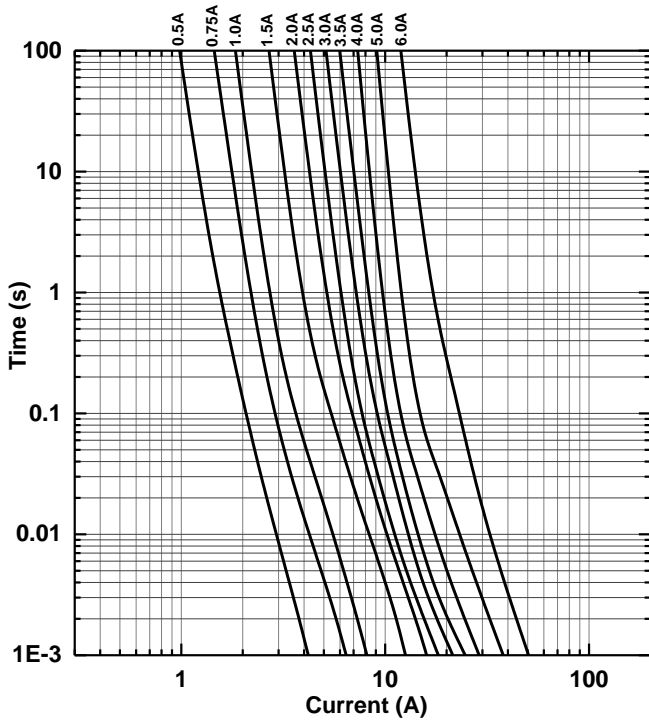

### I<sup>2</sup>T VS Time Curve

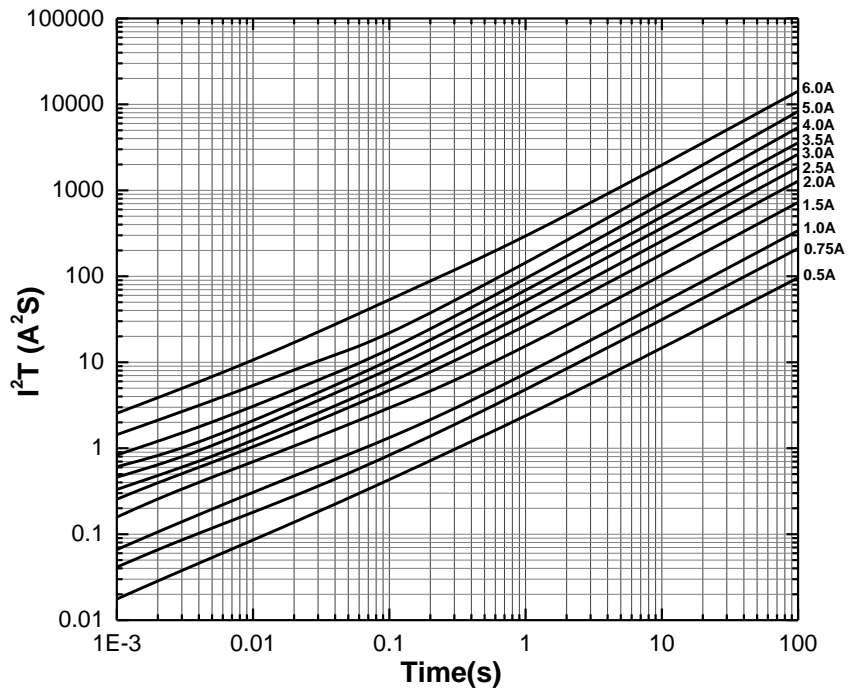

### Electrical Characteristics

Type	Ampere Rating	% of Current Rating	Opening Time
S0603-F	0.5A~6.0A	100	>4hours
	0.5A~0.75A	250	≤20sec
	1.0A~6.0A	250	≤5sec
	0.5A~6.0A	1000	>0.1ms

### Temperature Derating Curve

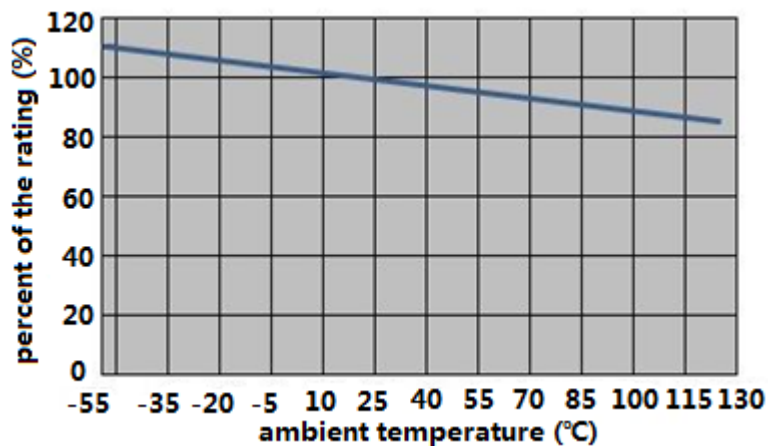

## Product Characteristics

Item	Test condition/ Methods	Performance	Standard
Time/Current	100% of current rating	No Fusing, 4hours Min.	UL248-14
	250% of current rating	0.5A~0.75A: ≤20sec 1.0A~6.0A: ≤5sec	SART SPEC.
	1000% of current rating	>0.1ms	
Voltage Drop	100% of current rating	Deviation between the mean value: <15%	IEC60127-4
Temperature Rise	100% of current rating	$\Delta T < 75^{\circ}\text{C}$	UL248-14
Endurance Test	100 cycles of 1In for 1h "ON", for 15min "OFF", then following by 1h at 125%In	$ \Delta R  < 10\%$	IEC60127-4
Interrupting Ability	0.5A~3.5A: 50A 32V DC 4.0A~6.0A: 35A 32V DC	without permanent arcing, ignition and bursting of fuse link	UL248-14 IEC60127-4
Solderability	$240^{\circ}\text{C} \pm 5^{\circ}\text{C}$ , 3sec $\pm 0.5$ sec	95% coverage Min.	IEC60127-4 MIL-STD-202 Method 208
Resistance to Soldering	$260^{\circ}\text{C} \pm 5^{\circ}\text{C}$ , 10sec $\pm 0.5$ sec	$ \Delta R  < 10\%$ Legible appearance	MIL-STD-202 Method 210
Bending Test	Distance between holding points: 90mm Bending: 1mm, time: 10s	$ \Delta R  < 10\%$ No mechanical damages	IEC60127-4
High Temperature Operating Life	$T = 70^{\circ}\text{C} \pm 2^{\circ}\text{C}$ , 60%In, 96hours	$ \Delta R  < 10\%$ ; No fusing	MIL-STD-202 Method 108
Humidity (Steady State)	$T = 40^{\circ}\text{C} \pm 2^{\circ}\text{C}$ , 90%~95%RH, 1000hours	$ \Delta R  < 10\%$	MIL-STD-202 Method 103
Low Temperature Storage	$T = -55^{\circ}\text{C} \pm 3^{\circ}\text{C}$ , 96hours	$ \Delta R  < 10\%$	IEC60068-2-1
High Temperature Storage	$T = 125^{\circ}\text{C} \pm 2^{\circ}\text{C}$ , 96hours	$ \Delta R  < 10\%$	IEC60068-2-2
Salt Spray	5% salt solution, 48hours	$ \Delta R  < 10\%$ Legible appearance	MIL-STD-202 Method 101
Thermal Shock	100 cycles between $-65^{\circ}\text{C}/+125^{\circ}\text{C}$ 60 minutes, each extreme	$ \Delta R  < 10\%$ No mechanical damages	MIL-STD-202 Method 107

## Recommended Solder Curve

### 1. Infrared Reflow:

- Temperature: 260°C
- Time: 5sec Max.
- Recommend Reflow profile

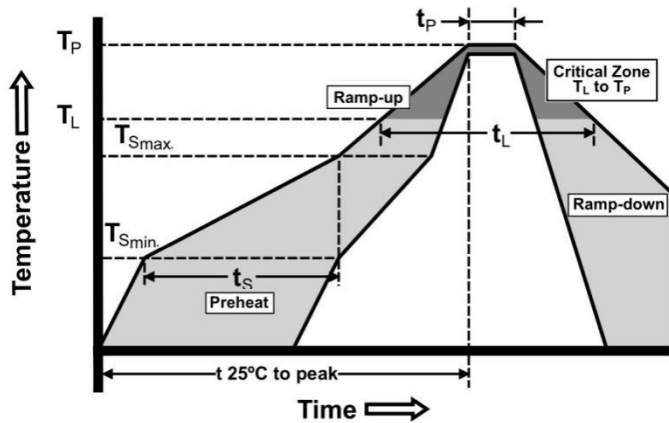

Profile Feature	Pb-Free Assembly
Average Ramp-up Rate( $T_{smax}$ to $T_p$ )	3°C/sec Max.
Preheat Temperature Min. ( $T_{smin}$ )	150°C
Temperature Max. ( $T_{smax}$ )	200°C
Time ( $T_{smin}$ to $T_{smax}$ )	60sec~120sec
Peak Temperature ( $T_p$ )	260°C
Time within 5°C of actual Peak Temperature ( $T_p$ )	5sec
Melting tin time ( $T_L$ )	20sec~30sec
Ramp-down Rate	6°C/sec Max.
Time 25°C to peak Temperature	8minutes Max.

### 2. Wave soldering

- Reservoir Temperature: 260°C
- Time in Reservoir: 10secMax.

### 3. Hand Soldering

- Temperature: 350°C
- Time: 5secMax.

## Packaging

- 5000 pieces of fuses in emboss taper and reeled on a 178mm(7 inch) reel.

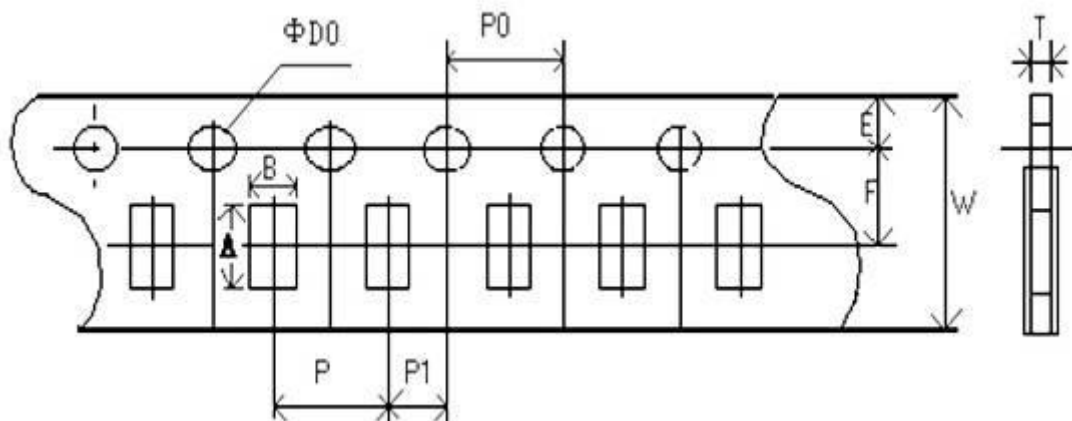

Type	A(mm)	B(mm)	W(mm)	E(mm)	F(mm)
Spec	1.85±0.10	1.10±0.10	8.00±0.20	1.75±0.10	3.50±0.05
Type	P(mm)	P0(mm)	P1(mm)	D0(mm)	T(mm)
Spec	4.00±0.10	4.00±0.10	2.00±0.05	1.50±0.10	0.60±0.10



Type	M(mm)	W(mm)	T(mm)	A(mm)	B(mm)	C(mm)	D(mm)
Spec	178.00±2.00	9.50±1.00	12.50±1.50	2.00±0.50	13.00±0.50	21.00±0.50	58.00±2.00

### Storage

- The ambient temperature recommended for storage shall be between 5°C~30°C
- The relative humidity recommended for storage shall be between 25%RH~60%RH
- Sealed plastic bags with desiccant shall be used to reduce the oxidation of the termination and shall only be opened prior to use
- The products shall not be stored in areas where harmful gases containing sulfur or chlorine are present

## X-ON Electronics

Largest Supplier of Electrical and Electronic Components

*Click to view similar products for [Surface Mount Fuses](#) category:*

*Click to view products by [SART manufacturer](#):*

Other Similar products are found below :

[FHC20402ADTP](#) [NFVC6125S0R50TRF](#) [TF16SN2.00TTD](#) [FCC16501ABTP](#) [FCC16102ABTP](#) [FHC16322ADTP](#) [0308001.UR](#)  
[FCC16202ABTP](#) [F0603G0R03FNTR](#) [7010.9962.63](#) [SEF 12A 65V \(G\)](#) [MST 250mA 250V](#) [TB60](#) [06 100.4](#) [TBF50](#) [TBF40](#)  
[2010T315mA250V](#) [06 110.7](#) [12 100.1.5](#) [06 110.5](#) [1206FA-R250](#) [R06.100.6](#) [R12.100.15](#) [R06.000.0.375](#) [R06.000.6](#) [R06.100.0.25](#) [R12.000.8](#)  
[R06.000.0.5](#) [R06.000.0.75](#) [R06.000.8](#) [R06.100.0.75](#) [R06.100.8](#) [R06.100.0.375](#) [R06.100.0.5](#) [R06.000.7](#) [R06.100.7](#) [S0603-S-2.0A](#) [F06F3.5](#)  
[F12F20](#) [TA3VT2](#) [F12F1](#) [F06F7](#) [F06T3.5](#) [F06F0.375](#) [F06T8](#) [F12F30](#) [4T2A250V](#) [R12.100.7](#) [R12.100.30](#) [R06.000.0.25](#)