

General

- Fast acting
- 3.10mmx 1.55mm physical size
- Thick film manufacturing method, ceramic substrate, silver fusing element
- -55°C~125°C operating temperature
- Excellent environmental integrity
- RoHS compliant
- Halogen-free
- Lead free

Agency / Certificate Information

Agency	File Number	Ampere Range
	E319512	0.5A~7A

Application

- Battery pack
- PC related equipment and peripherals (Hard driver, Printer, etc.)
- Digital camera (Digital still camera)
- Game equipment
- LCD monitor, LCD modules
- Wireless base station
- Power supply
- Medical device

Electrical Specifications

Part Number	Marking	Current Rating (A)	Voltage Rating (V)	Interrupting Rating (V)	Typical Cold DCR* (mΩ)	Typical I ² T** (A ² s)
S1206-F-0.5A	F	0.5	32	50A 32V DC	1200	0.0075
S1206-F-0.75A	G	0.75	32		540	0.0169
S1206-F-1.0A	H	1.0	32		240	0.0279
S1206-F-1.5A	K	1.5	32		115	0.0491
S1206-F-2.0A	N	2.0	32		64	0.1251
S1206-F-2.5A	O	2.5	32		33	0.1255
S1206-F-3.0A	P	3.0	32		27	0.2880
S1206-F-3.15A	Z	3.15	32		26	0.2977
S1206-F-3.5A	R	3.5	32		20.5	0.5366
S1206-F-4.0A	S	4.0	32		35A 32V DC	15.5
S1206-F-5.0A	T	5.0	32	12.5		0.9325
S1206-F-6.0A	6	6.0	32	11.0		1.5192
S1206-F-7.0A	U	7.0	32	7.2		2.2050

* Measured at ≤10% rated current and 25°C

** Melting I²T at 10 times of rated current

Part Number Information

S 1206-F-1.0A

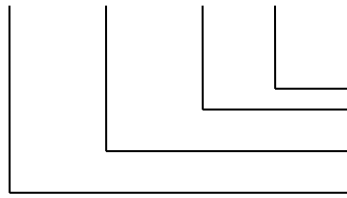

- "1.0A" Ampere Rating: 1A
- "F" Electrical Characteristic: F = Fast acting
- "1206" Size Number
- "S" Symbol of SART

Dimensions

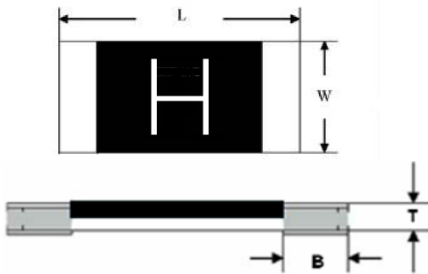

Type	L (mm)	W (mm)	T (mm)	B (mm)
S1206-F	3.10±0.20	1.55±0.20	0.55±0.20	0.50±0.20

Recommended Land Patterns

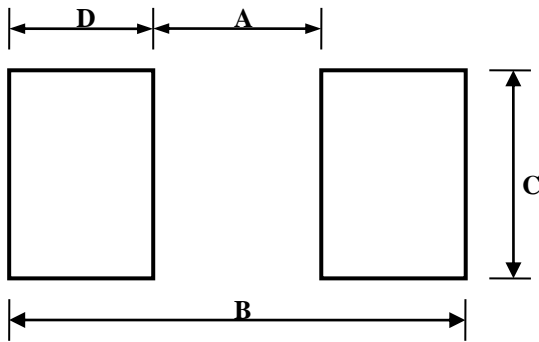

Dimensions	A(mm)	B(mm)	C(mm)	D(mm)
Spec	2.00±0.30	4.40±0.50	2.40±0.30	1.20±0.30

Materials

Components	Material
Body	Ceramic
Terminations	Silver over plated with tin (100%)
Element	Silver or Silver/Palladium

Dimensions of Standard Test Board

Type	Ampere Rating	Board Thickness (mm)	Copper Layer Thickness (mm)	Copper Trace Width (mm)
S1206-F	0.5A~6.0A	1.6	0.035	5.0
	7.0A	1.6	0.070	7.5

Time Current Curve

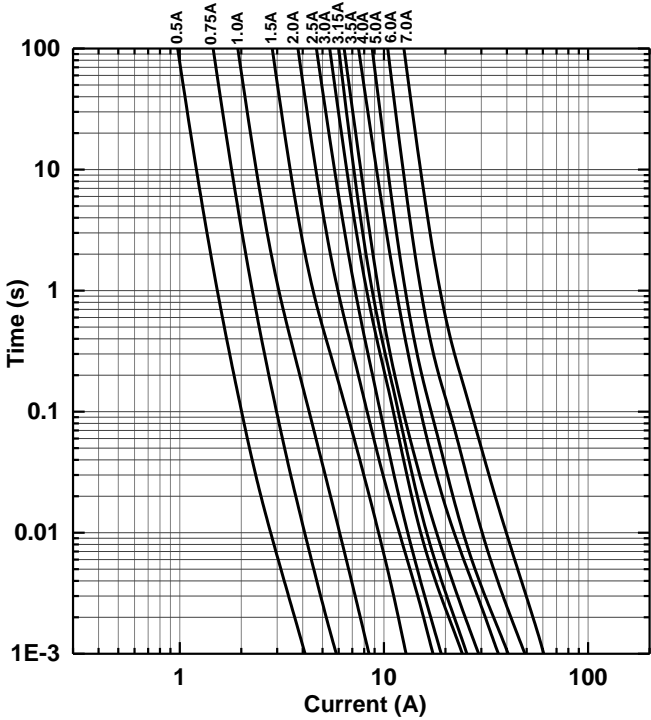

I²T VS Time Curve

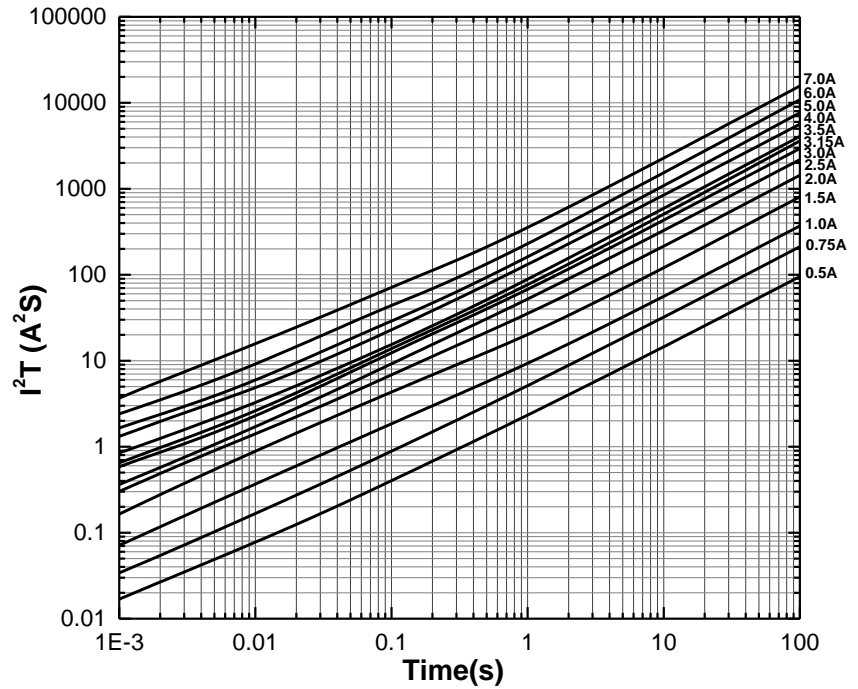

Electrical Characteristics

Type	Ampere Rating	% of Current Rating	Opening Time
S1206-F	0.5A~7.0A	100	>4hours
	0.5A~0.75A	250	≤20sec
	1.0A~7.0A	250	≤5sec
	0.5A~7.0A	1000	>0.1ms

Temperature Derating Curve

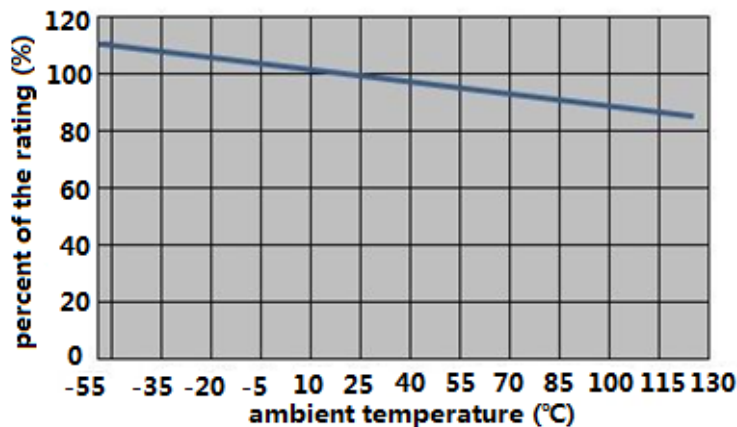

Product Characteristics

Item	Test condition/ Methods	Performance	Standard
Time/Current	100% of current rating	No Fusing, 4hours Min.	UL248-14
	250% of current rating	0.5A~0.75A: ≤20sec 1.0A~7.0A: ≤5sec	SART SPEC.
	1000% of current rating	>0.1ms	IEC60127-4
Voltage Drop	100% of current rating	Deviation between the mean value: <15%	IEC60127-4
Temperature Rise	100% of current rating	$\Delta T < 75^{\circ}\text{C}$	IEC60127-4
Endurance Test	100 cycles of 1In for 1h "ON", for 15min "OFF", then following by 1h at 125%In	$ \Delta R < 10\%$	IEC60127-4
Interrupting Ability	0.5A~3.5A: 50A 32V DC 4.0A~7.0A: 35A 32V DC	without permanent arcing, ignition and bursting of fuse link	UL248-14 IEC60127-4
Solderability	$240^{\circ}\text{C} \pm 5^{\circ}\text{C}$, 3sec ± 0.5 sec	95% coverage Min.	IEC60127-4 MIL-STD-202 Method 208
Resistance to Soldering	$260^{\circ}\text{C} \pm 5^{\circ}\text{C}$, 10sec ± 0.5 sec	$ \Delta R < 10\%$ Legible appearance	MIL-STD-202 Method 210
Bending Test	Distance between holding points: 90mm Bending: 1mm, time: 10sec	$ \Delta R < 10\%$ No mechanical damages	IEC60127-4
High Temperature Operating Life	$T = 70^{\circ}\text{C} \pm 2^{\circ}\text{C}$, 60%In, 96hours	$ \Delta R < 10\%$; No fusing	MIL-STD-202 Method 108
Humidity (Steady State)	$T = 40^{\circ}\text{C} \pm 2^{\circ}\text{C}$, 90%~95%RH, 1000hours	$ \Delta R < 10\%$	MIL-STD-202 Method 103
Low Temperature Storage	$T = -55^{\circ}\text{C} \pm 3^{\circ}\text{C}$, 96hours	$ \Delta R < 10\%$	IEC60068-2-1
High Temperature Storage	$T = 125^{\circ}\text{C} \pm 2^{\circ}\text{C}$, 96hours	$ \Delta R < 10\%$	IEC60068-2-2
Salt Spray	5% salt solution, 48hours	$ \Delta R < 10\%$ Legible appearance	MIL-STD-202 Method 101
Thermal Shock	100 cycles between $-65^{\circ}\text{C}/+125^{\circ}\text{C}$ 60 minutes, each extreme	$ \Delta R < 10\%R$ No mechanical damages	MIL-STD-202 Method 107

Recommended Solder Curve

1. Infrared Reflow:
- Temperature: 260°C
 - Time: 5sec Max.
 - Recommend Reflow profile

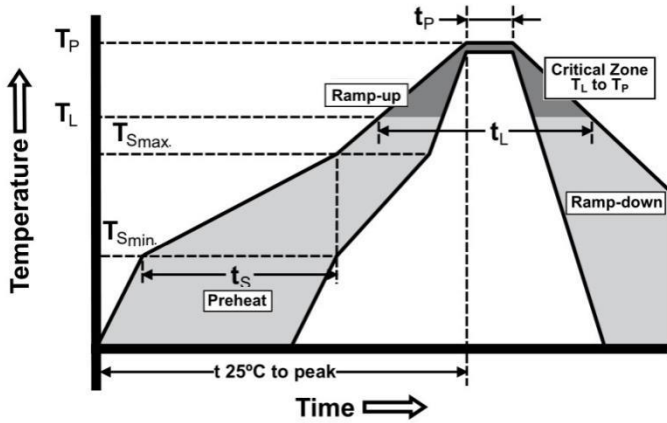

Profile Feature	Pb-Free Assembly
Average Ramp-up Rate(T_{Smax} to T_P)	3°C/sec Max.
Preheat Temperature Min.(T_{Smin})	150°C
Preheat Temperature Max.(T_{Smax})	200°C
Preheat Time(T_{Smin} to T_{Smax})	60sec~120sec
Peak Temperature(T_P)	260°C
Time within 5°C of actual Peak Temperature(T_P)	5sec
Melting tin time(T_L)	20sec~30sec
Ramp-down Rate	6°C/sec Max.
Time 25°C to peak Temperature	8minutes Max.

2. Wave soldering
- Reservoir Temperature: 260°C
 - Time in Reservoir: 10secMax.

3. Hand Soldering
- Temperature: 350°C
 - Time: 5secMax.

Packaging

- 5000 pieces of fuses in emboss taper and reeled on a 178mm(7 inch) reel.

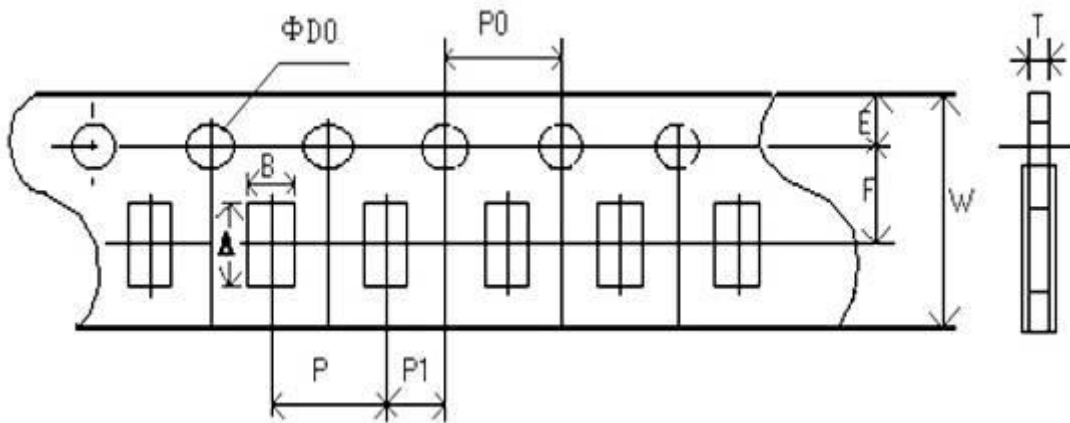

Type	A(mm)	B(mm)	W(mm)	E(mm)	F(mm)
Spec	3.50±0.20	1.90±0.20	8.00±0.20	1.75±0.10	3.50±0.05
Type	P(mm)	P0(mm)	P1(mm)	D0(mm)	T(mm)
Spec	4.00±0.10	4.00±0.10	2.00±0.10	1.50±0.10	0.75±0.10



Type	M(mm)	W(mm)	T(mm)	A(mm)	B(mm)	C(mm)	D(mm)
Spec	178.00±2.00	9.50±1.00	12.50±1.50	2.00±0.50	13.00±0.50	21.00±0.50	58.00±2.00

Storage

- The ambient temperature recommended for storage shall be between 5°C~30°C
- The relative humidity recommended for storage shall be between 25%RH~60%RH
- Sealed plastic bags with desiccant shall be used to reduce the oxidation of the termination and shall only be opened prior to use
- The products shall not be stored in areas where harmful gases containing sulfur or chlorine are present

X-ON Electronics

Largest Supplier of Electrical and Electronic Components

Click to view similar products for [Surface Mount Fuses](#) category:

Click to view products by [SART](#) manufacturer:

Other Similar products are found below :

[FHC20402ADTP](#) [FT600-0500-2](#) [NFVC6125S0R50TRF](#) [SFT-125MA](#) [TF16SN2.00TTD](#) [41921000000](#) [TR/3216LR-500MA](#) [CCP2B20TTE](#)
[TR-3216FF4-R](#) [SST 1-1K](#) [SST 5 -1K](#) [SST 2-1K](#) [TR2-TCP500-R](#) [F60C500V12AS](#) [FCC16501ABTP](#) [FCC16102ABTP](#) [FHC16322ADTP](#)
[0308.250UR](#) [0308.375UR](#) [0308.500UR](#) [0308.750UR](#) [0308001.UR](#) [030801.5UR](#) [FCC16202ABTP](#) [3-122-714](#) [3-122-720](#) [3-122-718](#) [3-122-](#)
[712](#) [3-122-716](#) [03081.25UR](#) [CQ06LF 5A 32V](#) [CQ06LT 5A 32V](#) [SET 2A 125V \(G\)](#) [SET 1A 125V \(G\)](#) [SEF 10A 125V \(G\)](#) [SEF 3A 125V \(G\)](#)
[SEF 4A 125V \(G\)](#) [SEF 6A 125V \(G\)](#) [SEF 7A 125V \(G\)](#) [SET 4A 125V \(G\)](#) [SET 3A 125V \(G\)](#) [SET 5A 125V \(G\)](#) [SET 7A 125V \(G\)](#)
[F0603G0R03FNTR](#) [SKY87604-12](#) [SKY87604-11](#) [SKY87604-13](#) [0154002.DRL](#) [0154008.DRL](#) [0154.125DRL](#)