



General

- AEC-Q200 Automotive Grade Certified
- 3.1mm× 1.6mm physical size
- Thick film manufacturing method, ceramic
- substrate, silver fusing element
- -55°C~125°C operating temperature
- Excellent environmental integrity
- RoHS compliant
- Halogen-free
- Lead free

Agency / Certificate Information

Agency	File Number	Ampere Range
	E319512	1.0A~5.0A

Application

- Battery pack
- PC related equipment and peripherals (Hard driver, Printer, etc.)
- Digital camera (Digital still camera)
- Game equipment
- LCD monitor, LCD modules
- Wireless base station
- Power supply
- Medical device

Electrical Specifications

Part Number	Marking	Current Rating (A)	Voltage Rating (V)	Interrupting Rating (V)	Typical Cold DCR* (mΩ)	Typical I ² T** (A ² s)
S1206-FC-1.0A	H	1.0	100	50A 100V DC	320	0.022
S1206-FC-1.5A	K	1.5	100		153	0.065
S1206-FC-2.0A	N	2.0	100		100	0.100
S1206-FC-2.5A	O	2.5	100		64.5	0.125
S1206-FC-3.0A	P	3.0	100		45.5	0.263
S1206-FC-3.5A	R	3.5	100		41	0.368
S1206-FC-4.0A	S	4.0	100		31	0.480
S1206-FC-5.0A	T	5.0	100		16	0.558

* Measured at $\leq 10\%$ rated current and 25°C

** Melting I²T at 10 times of rated current

*:Resistance test on the coating surface

Part Number Information

S 1206-FC-3.0A

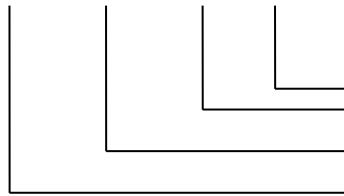

“3.0A” Ampere Rating: 3A
 “FC” Electrical Characteristic: FC = Fast action for AEC-Q200
 “1206” Size Number
 “S” Symbol of SART

Dimensions

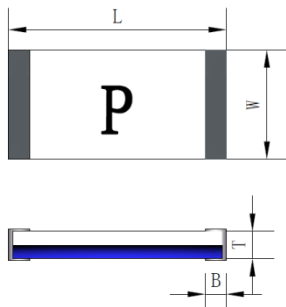

Type	L (mm)	W (mm)	T (mm)	B (mm)
S1206-FC	3.10±0.20	1.60±0.20	0.80±0.20	0.45±0.20

Recommended Land Patterns

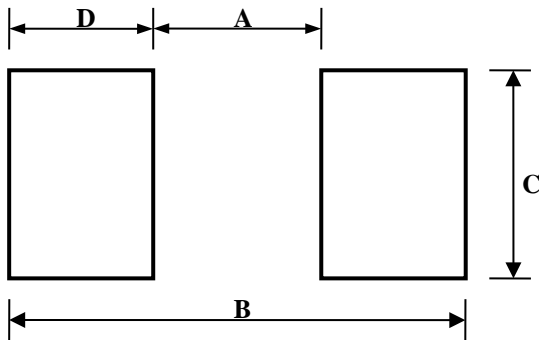

Type	A(mm)	B(mm)	C(mm)	D(mm)
S1206-FC	2.00±0.20	4.40±0.50	2.40±0.20	1.20±0.30

Materials

Components	Material
Body	Ceramic
Terminations	Silver
Element	Silver or Silver/Palladium

Dimensions of Standard Test Board

Type	Ampere Rating	Board Thickness (mm)	Copper Layer Thickness (mm)	Copper Trace Width (mm)
S1206-FC	1.0A~5.0A	1.6	0.035	5.0

Time Current Curve

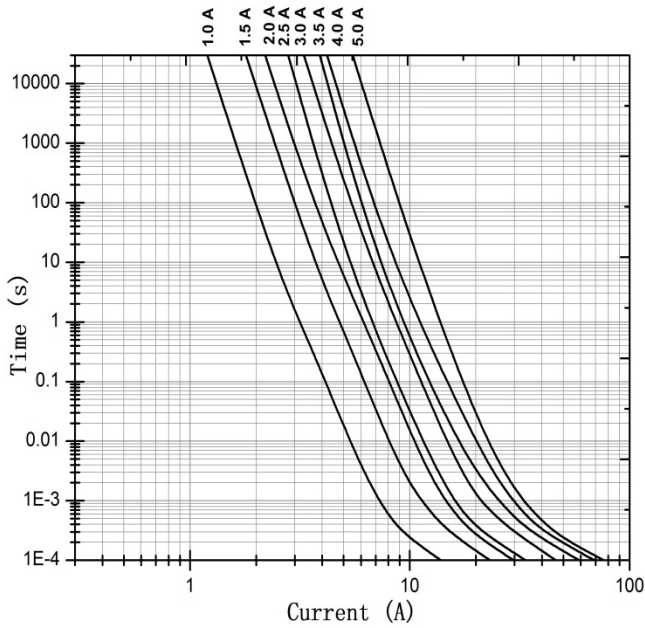

I²T VS Time Curve

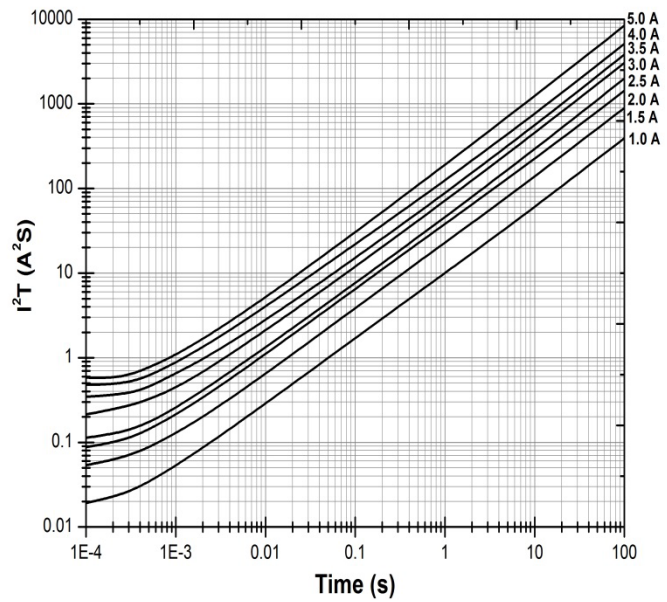

Electrical Characteristics

Type	Ampere Rating	% of Current Rating	Opening Time
S1206-FC	1.0A~5.0A	100	>4hours
	1.0A~5.0A	350	≤5sec
	1.0A~5.0A	1000	>0.1ms

Temperature Derating Curve

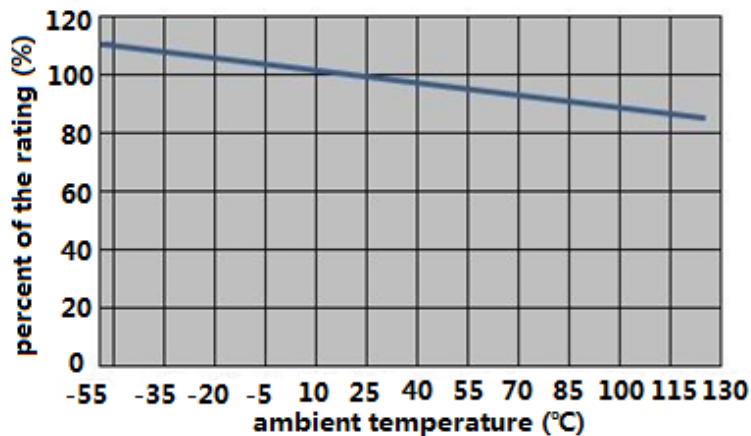

Product Characteristics

Item	Test condition/ Methods	Performance	Standard
Time/Current	100% of current rating	No Fusing, 4hours Min.	UL248-14
	350% of current rating	≤5sec	SART SPEC. IEC60127-4
	1000% of current rating	>0.1ms	IEC60127-4
Voltage Drop	100% of current rating	Deviation between the mean value: <15% 1.0A~1.5A<500mV 2.0A~5.0A<300mV	IEC-60127-4
Endurance Test	Repeating 100 cycles of 1In for 1hour "ON", for 15min "OFF", then following by 1hour of 1.25In and testing Temperature rise	ΔR :<10% ΔT<75℃	IEC-60127-4
Interrupting Ability	50A 100V DC	without permanent arcing, ignition and bursting of fuse link	UL248-14 IEC60127-1
Solderability	235℃±5℃, 5sec±0.5sec	95% coverage Min.	J-STD-002
Resistance to Soldering	260℃±5℃, 10sec±0.5sec	ΔR :<10% Legible appearance	MIL-STD-202 Method 210
Bending Test	Distance between holding points: 90mm Bending: 2mm, time: 60sec	ΔR :<10% No mechanical damages	ACE-Q200-005
High Temperature Operating Life	T=125℃±2℃, 60%In, 1000hours	ΔR : <10%; No fusing	MIL-STD-202 Method 108
Humidity (Steady State)	T=85℃±2℃, 85%RH, 1000hours	ΔR : <10%	MIL-STD-202 Method 103
Low Temperature Storage	T=-55℃±3℃, 96hours	ΔR : <10%	IEC60068-2-1
High Temperature Storage	T=125℃±2℃, 1000hours	ΔR : <10%	MIL-STD-202
Salt Spray	5% salt solution, 96hours	ΔR : <10% Legible appearance	MIL-STD-202 Method 101

Thermal Shock	100 cycles between -65°C/+125°C 60 minutes, each extreme	$ \Delta R $: < 10%R No mechanical damages	JESD22 Method JA-104
Moisture Resistance	10 cycles between the specified humidity 24 hours, each cycles	$ \Delta R $: < 10%R	MIL-STD-202
Terminal Strength	Side thrust: 17.7N, time: 60sec	$ \Delta R $: < 10%R	AEC-Q200-006
Mechanical shock	Pulse acceleration: 1000m/s ² time: 6 millisecond stock number: 18 times	$ \Delta R $: < 10%R	MIL-STD-202 Method 213
Vibration High Frequency	Frequency: 10Hz~2000Hz, Displacement amplitude: 0.75mm, Acceleration: 150m/s ² , time: 12 hours	$ \Delta R $: < 10%R	MIL-STD-202 Method 204

Recommended Solder Curve

1. Infrared Reflow:

- Temperature: 260°C
- Time: 5sec Max.
- Recommend Reflow profile

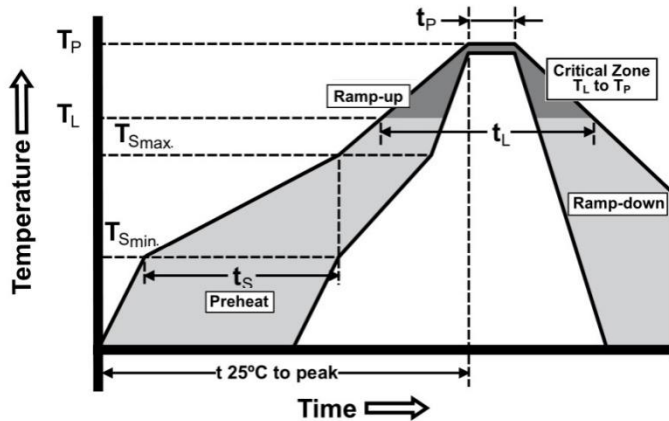

Profile Feature	Pb-Free Assembly
Average Ramp-up Rate (T _{Smax} to T _P)	3°C/sec Max.
Preheat Temperature Min. (T _{Smin}) Temperature Max. (T _{Smax}) Time (t _{Smin} to t _{Smax})	150°C 200°C 60sec~120sec
Peak Temperature (T _P)	260°C
Time within 5°C of actual Peak Temperature (t _P)	20sec
Melting tin time (t _L)	60sec~150sec
Ramp-down Rate	6°C/sec Max.
Time 25°C to peak Temperature	8minutes Max.

2. Wave soldering

- Reservoir Temperature: 260°C
- Time in Reservoir: 10secMax.

3. Hand Soldering

- Temperature: 350°C
- Time: 5secMax.

Packaging

- 5000 pieces of fuses in emboss taper and reeled on a 178mm(7 inch) reel.

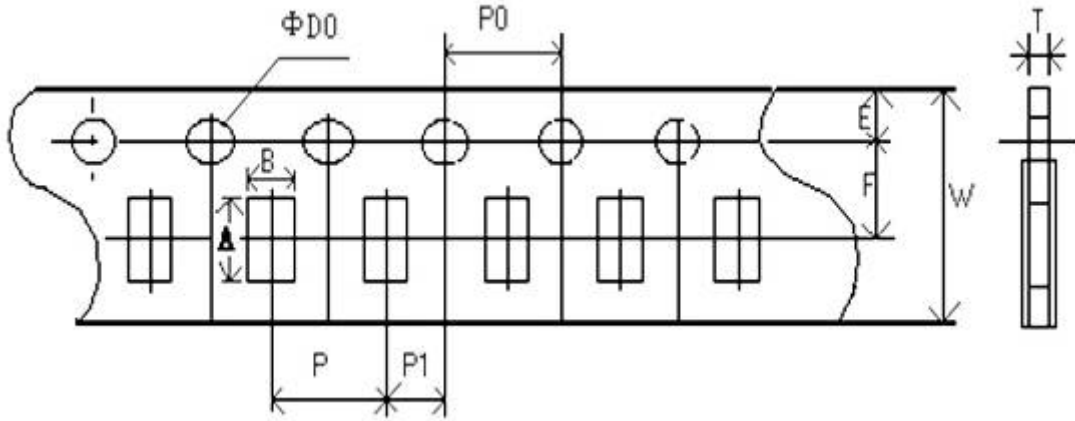

Type	A(mm)	B(mm)	W(mm)	E(mm)	F(mm)
S1206-FC	3.50±0.20	1.90±0.20	8.00±0.20	1.75±0.10	3.50±0.05
Type	P(mm)	P0(mm)	P1(mm)	D0(mm)	T(mm)
S1206-FC	4.00±0.10	4.00±0.10	2.00±0.10	1.50±0.10	0.91±0.10

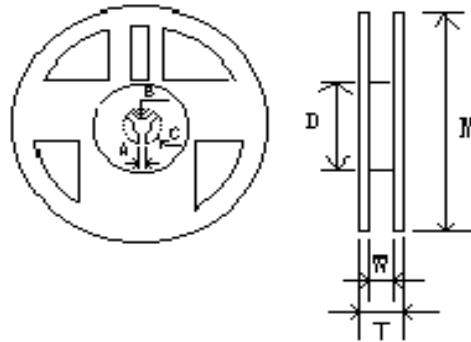

Type	M(mm)	W(mm)	T(mm)	A(mm)	B(mm)	C(mm)	D(mm)
S1206-FC	178.00±2.00	9.50±1.00	12.50±1.50	2.00±0.50	13.00±0.50	21.00±0.50	58.00±2.00

Storage:

- The ambient temperature recommended for storage shall be between 5°C~30°C
- The relative humidity recommended for storage shall be between 25%RH~60%RH
- Sealed plastic bags with desiccant shall be used to reduce the oxidation of the termination and shall only be opened prior to use
- The products shall not be stored in areas where harmful gases containing sulfur or chlorine are present

X-ON Electronics

Largest Supplier of Electrical and Electronic Components

Click to view similar products for [Surface Mount Fuses](#) category:

Click to view products by [SART](#) manufacturer:

Other Similar products are found below :

[FHC20402ADTP](#) [NFVC6125S0R50TRF](#) [SFT-125MA](#) [TF16SN2.00TTD](#) [7010.9810.57](#) [FCC16501ABTP](#) [FCC16102ABTP](#) [FHC16322ADTP](#)
[0308.250UR](#) [0308.375UR](#) [0308.500UR](#) [0308.750UR](#) [0308001.UR](#) [030801.5UR](#) [FCC16202ABTP](#) [F0603G0R03FNTR](#) [SKY87604-12](#)
[SKY87604-11](#) [SKY87604-13](#) [3404.0110.22](#) [7010.9962.63](#) [R451003.L](#) [R451.500L](#) [R451001.L](#) [3-103-119](#) [3-103-123](#) [TA3VT4](#) [TAF5](#)
[1206TD-20AS](#) [SCT1A](#) [F12T2.5](#) [TA2VT3](#) [F12T1.5](#) [SGB091](#) [9321100278](#) [522-5A/250V](#) [0154002.DRL](#) [0154008.DRL](#) [0154.125DRL](#)
[0154.250DRL](#) [0154.500DRL](#) [189140.1,25](#) [189140.0,8](#) [189140.0,4](#) [189140.0,63](#) [189140.0,25](#) [0402SFF150F/24-2](#) [0435.250KRHFS](#)
[0468003.WR](#) [0470001.DRSNP](#)