

General

- Slow Blow
- 3.10mm× 1.55mm physical size
- Thick film manufacturing method, ceramic substrate, silver fusing element
- -55°C~125°C operating temperature
- Excellent environmental integrity
- RoHS compliant
- Halogen-free
- Lead free

Agency / Certificate Information

Agency	File Number	Ampere Range
	E319512	0.5A~7A

Application

- Battery pack
- PC related equipment and peripherals (Hard driver, Printer, etc.)
- Digital camera (Digital still camera)
- Game equipment
- LCD monitor, LCD modules
- Wireless base station
- Power supply
- Medical device

Electrical Specifications

Part Number	Marking	Current Rating (A)	Voltage Rating (V)	Interrupting Rating (V)	Typical Cold DCR* (mΩ)	Typical I ² T** (A ² s)	
S1206-SD-0.5A	F	0.5	63	50A 63V DC	1200	0.0075	
S1206-SD-0.75A	G	0.75	63		540	0.0169	
S1206-SD-1.0A	H	1.0	63		320	0.245	
S1206-SD-1.5A	K	1.5	63		140	0.294	
S1206-SD-2.0A	N	2.0	63		92	0.788	
S1206-SD-2.5A	O	2.5	63		65	1.149	
S1206-SD-3.0A	P	3.0	63		50A 63V AC	36	2.300
S1206-SD-3.5A	R	3.5	63			30	2.563
S1206-SD-4.0A	S	4.0	63			23	3.667
S1206-SD-5.0A	T	5.0	63			16	4.260
S1206-SD-6.0A	6	6.0	63			12.5	9.848
S1206-SD-7.0A	U	7.0	63			7.0	11.176

* Measured at ≤10% rated current and 25°C

** Melting I²T at 10 times of rated current

Part Number Information

S 1206-SD-3.0A

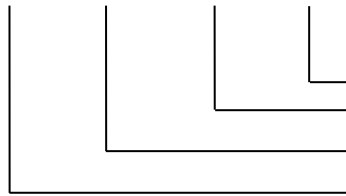

“3.0A” Ampere Rating: 3A
 “SD” Electrical Characteristic: S = Slow Blow, D = 63V
 “1206” Size Number
 “S” Symbol of SART

Dimensions

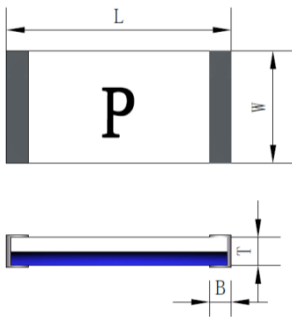

Type	L (mm)	W (mm)	T (mm)	B (mm)
S1206-SD	3.10±0.20	1.55±0.20	0.55±0.20	0.50±0.20

Recommended Land Patterns

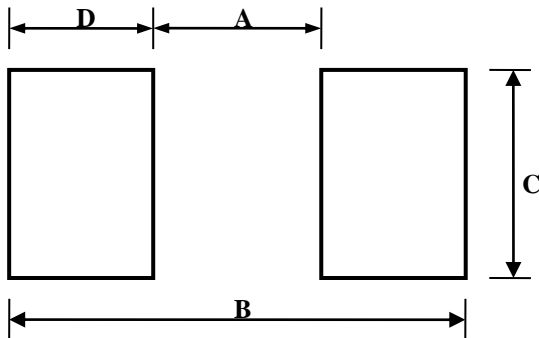

Dimensions	A(mm)	B(mm)	C(mm)	D(mm)
Spec	2.00±0.30	4.40±0.50	2.40±0.30	1.20±0.30

Materials

Components	Material
Body	Ceramic
Terminations	Silver over plated with tin (100%)
Element	Silver or Silver/Palladium

Dimensions of Standard Test Board

Type	Ampere Rating	Board Thickness (mm)	Copper Layer Thickness (mm)	Copper Trace Width (mm)
S1206-SD	0.5A~6.0A	1.6	0.035	5.0
	7.0A	1.6	0.070	7.5

Time Current Curve

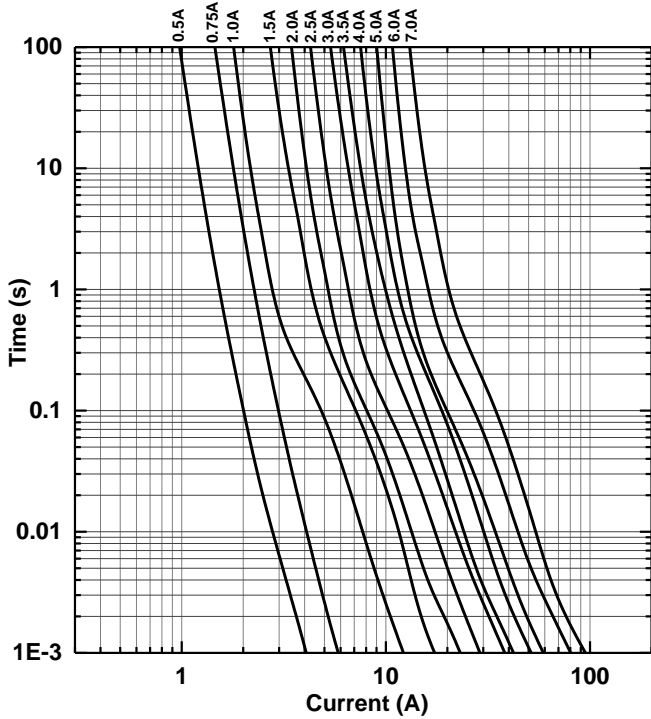

I²T VS Time Curve

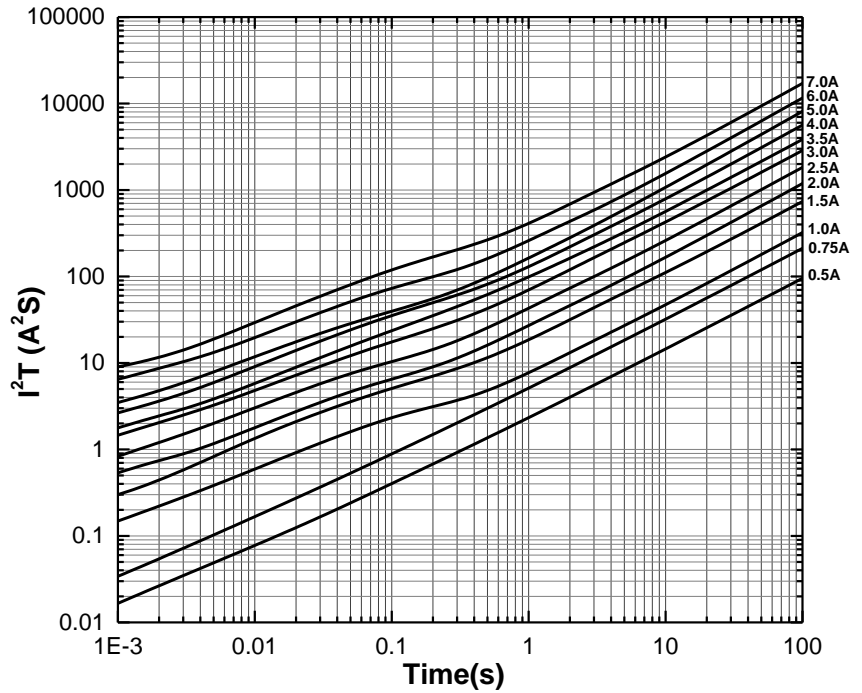

Electrical Characteristics

Type	Ampere Rating	% of Current Rating	Opening Time
S1206-SD	0.5A~7.0A	100	>4hours
	1.0A~7.0A	200	≤60sec
	0.5A~0.75A	250	≤20sec
	0.5A~0.75A	1000	>0.1ms
	1.0A~7.0A	1000	>1.0ms

Temperature Derating Curve

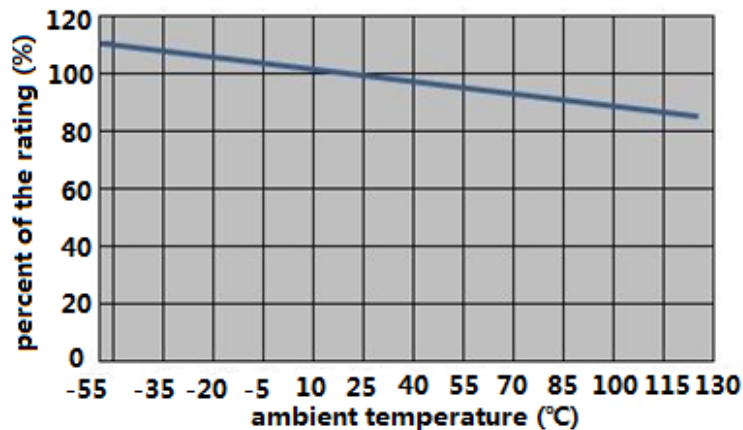

Product Characteristics

Item	Test condition/ Methods	Performance	Standard
Time/Current	100% of current rating	No Fusing, 4hours Min.	UL248-14
	200% of current rating	1.0A~7.0A:≤60sec	SART SPEC.
	250% of current rating	0.5A~0.75A:≤20sec	
	1000% of current rating	0.5A~0.75A:>0.1ms 1.0A~7.0A:>1.0ms	IEC60127-4
Voltage Drop	100% of current rating	Deviation between the mean value: <15%	IEC60127-4
Temperature Rise	100% of current rating	ΔT<75℃	IEC60127-4
Endurance Test	100 cycles of 1In for 1h "ON", for 15min "OFF", then following by 1h of 125%In	ΔR :<10%	IEC60127-4
Interrupting Ability	50A 63V DC 50A 63V AC	without permanent arcing, ignition and bursting of fuse link	UL248-14 IEC60127-4
Solderability	240℃±5℃, 3sec±0.5sec	95% coverage Min.	IEC60127-4 MIL-STD-202 Method 208
Resistance to Soldering	260℃±5℃, 10sec±0.5sec	ΔR :<10% Legible appearance	MIL-STD-202 Method 210
Bending Test	Distance between holding points: 90mm Bending: 1mm, time: 10sec	ΔR :<10% No mechanical damages	IEC60127-4
High Temperature Operating Life	T=70℃±2℃, 60%In, 96hours	ΔR : <10%; No fusing	MIL-STD-202 Method 108
Humidity (Steady State)	T=40℃±2℃, 90%~95%RH, 1000hours	ΔR : <10%	MIL-STD-202 Method 103
Low Temperature Storage	T=-55℃±3℃, 96hours	ΔR : <10%	IEC60068-2-1
High Temperature Storage	T=125℃±2℃, 96hours	ΔR : <10%	IEC60068-2-2
Salt Spray	5% salt solution, 48hours	ΔR : <10% Legible appearance	MIL-STD-202 Method 101
Thermal Shock	100 cycles between -65℃/+125℃ 60 minutes, each extreme	ΔR : <10%R No mechanical damages	MIL-STD-202 Method 107

Recommended Solder Curve

1. Infrared Reflow:

- Temperature: 260°C
- Time: 5sec Max.
- Recommend Reflow profile

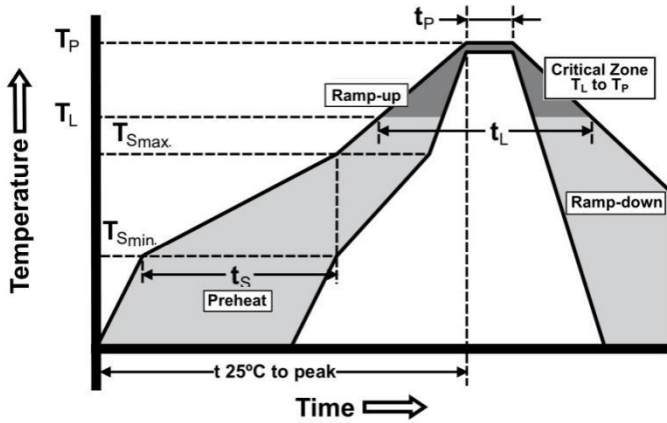

Profile Feature	Pb-Free Assembly
Average Ramp-up Rate(T_{Smax} to T_P)	3°C/sec Max.
Preheat Temperature Min.(T_{Smin})	150°C
Preheat Temperature Max.(T_{Smax})	200°C
Preheat Time(T_{Smin} to T_{Smax})	60sec~120sec
Peak Temperature(T_P)	260°C
Time within 5°C of actual Peak Temperature(T_P)	5sec
Melting tin time(T_L)	20sec~30sec
Ramp-down Rate	6°C/sec Max.
Time 25°C to peak Temperature	8minutes Max.

2. Wave soldering

- Reservoir Temperature: 260°C
- Time in Reservoir: 10secMax.

3. Hand Soldering

- Temperature: 350°C
- Time: 5secMax.

Packaging

- 5000 pieces of fuses in emboss taper and reeled on a 178mm(7 inch) reel.

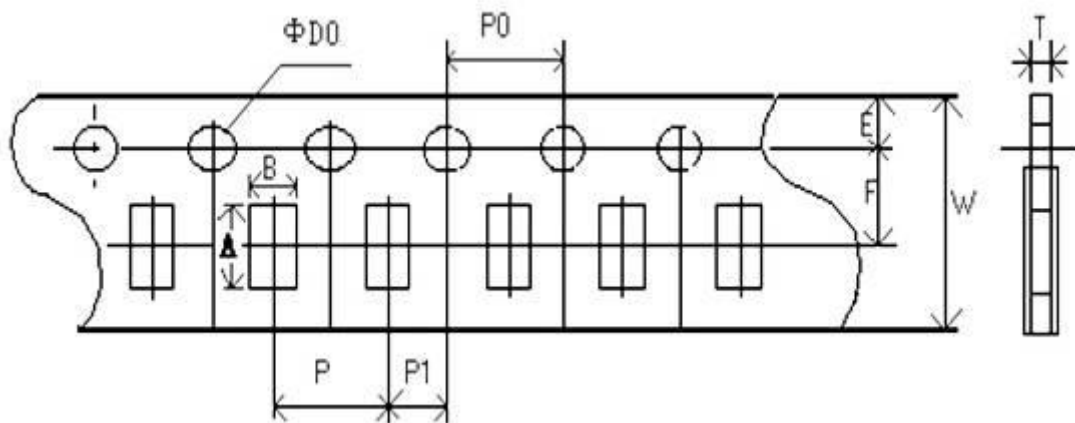

Type	A(mm)	B(mm)	W(mm)	E(mm)	F(mm)
Spec	3.50±0.20	1.90±0.20	8.00±0.20	1.75±0.10	3.50±0.05
Type	P(mm)	P0(mm)	P1(mm)	D0(mm)	T(mm)
Spec	4.00±0.10	4.00±0.10	2.00±0.10	1.50±0.10	0.75±0.10



Type	M(mm)	W(mm)	T(mm)	A(mm)	B(mm)	C(mm)	D(mm)
Spec	178.00±2.00	9.50±1.00	12.50±1.50	2.00±0.50	13.00±0.50	21.00±0.50	58.00±2.00

Storage

- The ambient temperature recommended for storage shall be between 5°C~30°C
- The relative humidity recommended for storage shall be between 25%RH~60%RH
- Sealed plastic bags with desiccant shall be used to reduce the oxidation of the termination and shall only be opened prior to use
- The products shall not be stored in areas where harmful gases containing sulfur or chlorine are present

X-ON Electronics

Largest Supplier of Electrical and Electronic Components

Click to view similar products for [Surface Mount Fuses](#) category:

Click to view products by [SART](#) manufacturer:

Other Similar products are found below :

[FHC20402ADTP](#) [FT600-0500-2](#) [NFVC6125S0R50TRF](#) [SFT-125MA](#) [TF16SN2.00TTD](#) [41921000000](#) [TR/3216LR-500MA](#) [CCP2B20TTE](#)
[TR-3216FF4-R](#) [SST 1-1K](#) [SST 5 -1K](#) [SST 2-1K](#) [TR2-TCP500-R](#) [F60C500V12AS](#) [FCC16501ABTP](#) [FCC16102ABTP](#) [FHC16322ADTP](#)
[0308.250UR](#) [0308.375UR](#) [0308.500UR](#) [0308.750UR](#) [0308001.UR](#) [030801.5UR](#) [FCC16202ABTP](#) [3-122-714](#) [3-122-720](#) [3-122-718](#) [3-122-](#)
[712](#) [3-122-716](#) [03081.25UR](#) [CQ06LF 5A 32V](#) [CQ06LT 5A 32V](#) [SET 2A 125V \(G\)](#) [SET 1A 125V \(G\)](#) [SEF 10A 125V \(G\)](#) [SEF 3A 125V \(G\)](#)
[SEF 4A 125V \(G\)](#) [SEF 6A 125V \(G\)](#) [SEF 7A 125V \(G\)](#) [SET 4A 125V \(G\)](#) [SET 3A 125V \(G\)](#) [SET 5A 125V \(G\)](#) [SET 7A 125V \(G\)](#)
[F0603G0R03FNTR](#) [SKY87604-12](#) [SKY87604-11](#) [SKY87604-13](#) [0154002.DRL](#) [0154008.DRL](#) [0154.125DRL](#)