

General

- Chip size 2512
- Resistance value from 1mΩ to 10mΩ
- High power rating
- Low inductance 0.5nH to 5nH
- Low TCR
- Compatible with RoHS & Halogen free

Application

- Switching model power supply
- Battery pack
- Notebook, personal computer
- Test Instrument
- Power Amplifier

Electrical Specifications

Type	Power Rating at 70°C(W)	Resistance Range (mΩ)	TCR (ppm/°C)	Resistance Tolerance	Operation Temp. Range
2512	2.0	1	±100	±1%(F)	-55°C~+170°C
		2~10	±50		

Part Number Information

SMA 25 A 2 F R001 T
【1】 **【2】** **【3】** **【4】** **【5】** **【6】** **【7】**

- 【1】** Series Name: SART Metal Strip Type
【2】 Chip size: 25: 2512
【3】 Material Code: A:Alloy
【4】 Power Code: 2: 2W
【5】 Resistance Tolerance: F: ±1%
【6】 Resistance Code: R001 = 1 mΩ
【7】 Packaging Code: T:Tape& Reel B: Bulk Pack

Dimensions

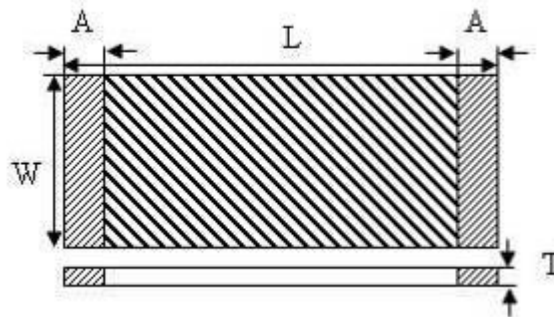

Type	L (mm)	W (mm)	T (mm)	A (mm)
2512	6.40±0.30	3.20±0.30	1.10±0.20	0.80±0.25

Recommended Land Patterns

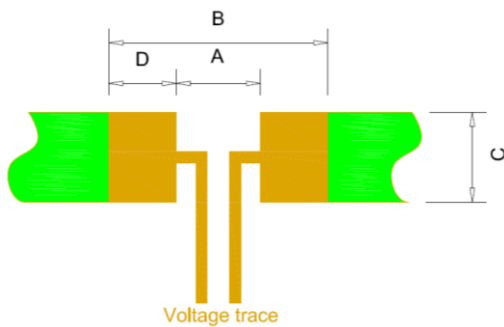

Type	A (mm)	B (mm)	C (mm)	D (mm)
2512	3.18	7.40	3.57	2.11

Materials

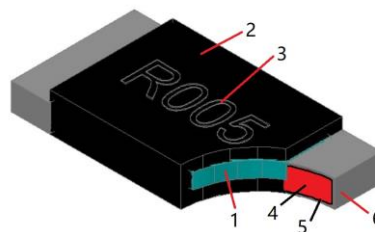

No.	Materials	No.	Materials
1	Alloy	4	Copper
2	Epoxy molding compounds	5	Nickel
3	Marking	6	Tin

Power Derating Curve

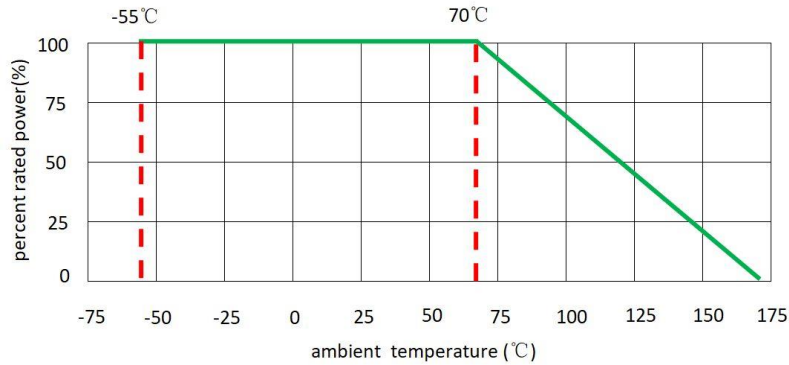

Recommended Solder Curve

1. Infrared Reflow

- Temperature: 260°C
- Time: 5sec Max.
- Recommend Reflow profile:

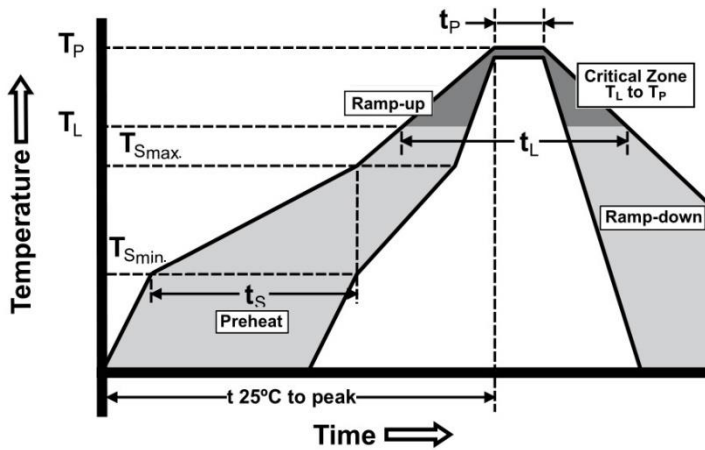

Profile Feature	Pb-Free Assembly
Average Ramp-up Rate (Tsmax to Tp)	3°C/sec Max.
Preheat Temperature Min.(Tsmin)	150°C
Preheat Temperature Max.(Tsmax)	200°C
Preheat Time(Tsmin to Tsmax)	60sec~120sec
Peak Temperature(Tp)	260°C
Time within 5°C of actual Peak Temperature(Tp)	5sec
Melting tin time(TL)	20sec~30sec
Ramp-down Rate	6°C/sec Max.
Time 25°C to peak Temperature	8 min Max.

2. Wave soldering

- Reservoir Temperature: 260°C
- Time in Reservoir: 10sec Max.

3. Hand Soldering

- Temperature: 350°C
- Time: 5sec Max.

Product Characteristics

Item	Test condition / Methods	Performance	Standard
Short Time Overload	$P = 5P_r$; $T = 25^{\circ}\text{C} \pm 2^{\circ}\text{C}$, $t = 5\text{sec}$	$ \Delta R \leq \pm(1\% + 0.5\text{ m}\Omega)$	IEC 60115-1 4.13
Temperature Coefficient of Resistance (TCR)	$\text{TCR} = \frac{(R - R_0)}{R_0} \frac{(T_2 - T_1)}{T_1} \times 10^6$ Test temperature: $+25^{\circ}\text{C} \sim +125^{\circ}\text{C}$	Refer to SART Spec	IEC 60115-1 4.8
Thermal Shock	-55°C (30min)/ $+150^{\circ}\text{C}$ (30 min), 100 cycles	$ \Delta R \leq \pm(1\% + 0.5\text{ m}\Omega)$	IEC 60115-1 4.19
Resistance to Solder Heat	$265^{\circ}\text{C} \pm 5^{\circ}\text{C}$, 20sec \pm 1sec	$ \Delta R \leq \pm(1\% + 0.5\text{ m}\Omega)$	IEC 60115-1 4.18
Solderability	$245^{\circ}\text{C} \pm 5^{\circ}\text{C}$, 3sec \pm 0.5sec	95% coverage Min.	IEC 60115-1 4.17
Load Life	1000 hours at rated power, $70^{\circ}\text{C} \pm 2^{\circ}\text{C}$, 1.5hours "ON", 0.5hours "OFF"	$ \Delta R \leq \pm(2\% + 0.5\text{ m}\Omega)$	IEC 60115-1 4.25.1
Moisture Load Life (60°C 、95%RH)	$T = 60^{\circ}\text{C} \pm 2^{\circ}\text{C}$; RH=95% ; $V_{\text{test}} = V_{\text{max}}$; $t = 1.5\text{hours}$ "ON", 0.5hours "OFF" , 1000hours	$ \Delta R \leq \pm(2\% + 0.5\text{ m}\Omega)$	IEC 60115-1 4.24
Bending test	Bending width 2mm, Epoxy thickness 1.6mm, Fulcrums distance 90mm	$ \Delta R \leq \pm(1\% + 0.5\text{ m}\Omega)$	IEC 60115-1 4.33
High Temp. Exposure	$T = +170^{\circ}\text{C} \pm 2^{\circ}\text{C}$; $t = 1000\text{hours}$	$ \Delta R \leq \pm(1\% + 0.5\text{ m}\Omega)$	IEC60115-1 4.25
Low Temp. Storage	$T = -55^{\circ}\text{C} \pm 2^{\circ}\text{C}$; $t = 1000\text{hours}$	$ \Delta R \leq \pm(1\% + 0.5\text{ m}\Omega)$	IEC60115-1 4.25
Mechanical Shock	$a = 100\text{G}$, $t = 11\text{ms}$, 5 times shock	$ \Delta R \leq \pm(1\% + 0.5\text{ m}\Omega)$	IEC60115-1 4.21

Packaging

1. Tape Packaging Dimensions

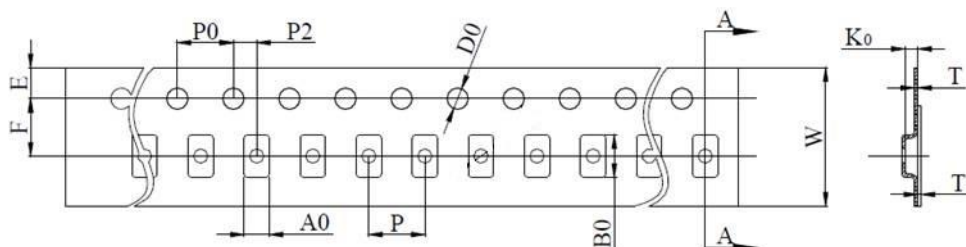

Type	A0 (mm)	B0 (mm)	W (mm)	F (mm)	E (mm)	T (mm)
2512	3.40±0.20	6.75±0.20	12.00±0.30	5.50±0.10	1.75±0.10	0.20±0.10
Type	P (mm)	P0 (mm)	P2 (mm)	D0 (mm)	T1 (mm)	K0 (mm)
2512	4.00±0.10	4.00±0.10	2.00±0.10	1.55±0.10	Max. 0.10	1.3 ^{+0.20} _{-0.10}

2. Reel Dimensions

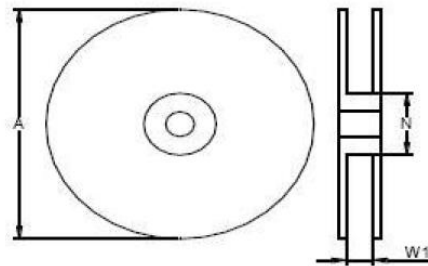

Type	A (mm)	N (mm)	W1 (mm)
2512	178.00±5.00	60.00±2.00	13.00±1.00

3. Quantity of Package

Type	2512
Quantity(PCS)	3000

4. Peeling Test

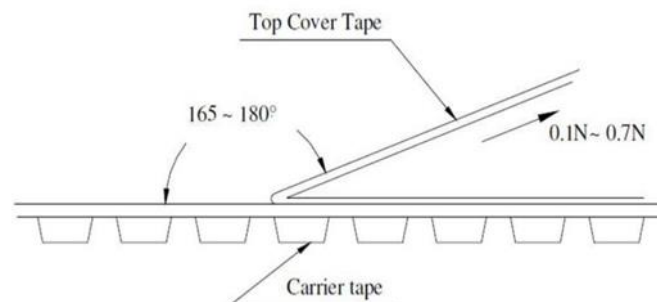

Storage

- The ambient temperature shall be between 5°C~30°C.
- The relative humidity recommended for storage is between 25%RH~60%RH.
- Sealed plastic bags with desiccant shall be used to reduce the oxidation of the termination and shall only be opened prior to use.
- The products shall not be stored in areas where harmful gases containing sulfur or chlorine are present.

X-ON Electronics

Largest Supplier of Electrical and Electronic Components

Click to view similar products for [Thick Film Resistors - SMD category](#):

Click to view products by [SART manufacturer](#):

Other Similar products are found below :

[CR-05FL7--150R](#) [CR-05FL7--19K6](#) [CR-05FL7--243R](#) [CR-05FL7--40K2](#) [CR-05FL7--698K](#) [CR-12FP4--324R](#) [CR-12JP4--680R](#)

[M55342K06B6E19RWL](#) [M55342K06B6E81RS3](#) [M55342M05B200DRWB](#) [M55342M06B4K70MS3](#) [MC0603-511-JTW](#) [742C083750JTR](#)

[MCR01MZPF1202](#) [MCR01MZPF1601](#) [MCR01MZPF1800](#) [MCR01MZPF6201](#) [MCR01MZPF9102](#) [MCR01MZPJ113](#) [MCR01MZPJ121](#)

[MCR01MZPJ125](#) [MCR01MZPJ751](#) [MCR03EZHZJ103](#) [MCR03EZPF2004](#) [MCR03EZPJ270](#) [MCR03EZPJ821](#) [MCR10EZPF1102](#)

[MCR18EZPJ330](#) [RC0603F1473CS](#) [RC0603F150CS](#) [RC1005F1152CS](#) [RC1005F1182CS](#) [RC1005F1372CS](#) [RC1005F183CS](#)

[RC1005F1911CS](#) [RC1005F1912CS](#) [RC1005F203CS](#) [RC1005F2052CS](#) [RC1005F241CS](#) [RC1005F2431CS](#) [RC1005F3011CS](#)

[RC1005F303CS](#) [RC1005F4321CS](#) [RC1005F4642CS](#) [RC1005F471CS](#) [RC1005F4751CS](#) [RC1005F5621CS](#) [RC1005F6041CS](#)

[RC1005J106CS](#) [RC1005J121CS](#)