

General

- Chip size 2512
- Resistance value from 1mΩ to 10mΩ
- High power rating
- Low inductance 0.5nH to 5nH
- Low TCR
- Compatible with RoHS & Halogen free

Application

- Switching model power supply
- Battery pack
- Notebook, personal computer
- Test Instrument
- Power Amplifier

Electrical Specifications

Type	Power Rating at 70°C(W)	Resistance Range (mΩ)	TCR (ppm/°C)	Resistance Tolerance	Operation Temp. Range
2512	3.0	1	±100	±1%(F)	-55°C~+170°C
		2~10	±50		

Part Number Information

SMA 25 A 3 F R001 T
【1】 **【2】** **【3】** **【4】** **【5】** **【6】** **【7】**

- 【1】** Series Name: SART Metal Strip Type
【2】 Chip size: 25: 2512
【3】 Material Code: A:Alloy
【4】 Power Code: 3: 3W
【5】 Resistance Tolerance: F: ±1%
【6】 Resistance Code: R001 = 1 mΩ
【7】 Packaging Code: T:Tape& Reel B: Bulk Pack

Dimensions

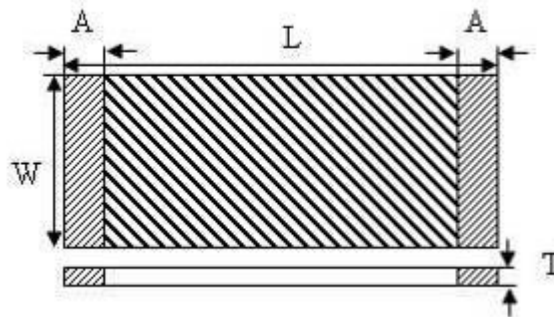

Type	L (mm)	W (mm)	T (mm)	A (mm)
2512	6.40±0.30	3.20±0.30	1.10±0.20	0.80±0.25

Recommended Land Patterns

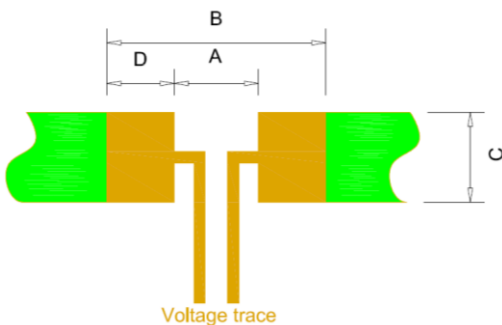

Type	A (mm)	B (mm)	C (mm)	D (mm)
2512	3.18	7.40	3.57	2.11

Materials

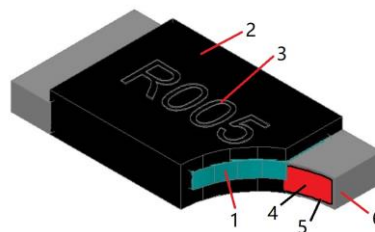

No.	Materials	No.	Materials
1	Alloy	4	Copper
2	Epoxy molding compounds	5	Nickel
3	Marking	6	Tin

Power Derating Curve

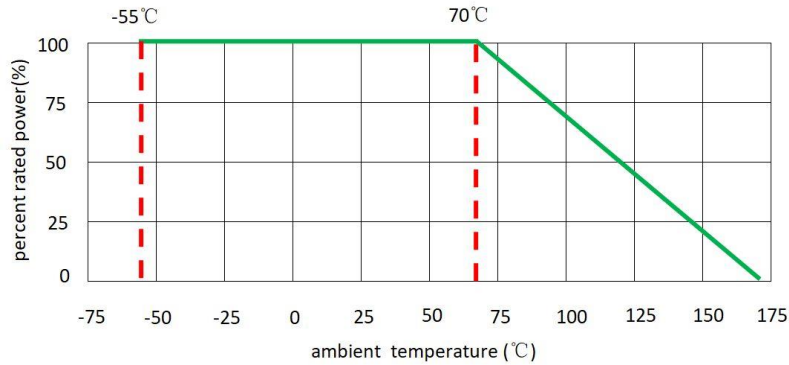

Recommended Solder Curve

1. Infrared Reflow

- Temperature: 260°C
- Time: 5sec Max.
- Recommend Reflow profile:

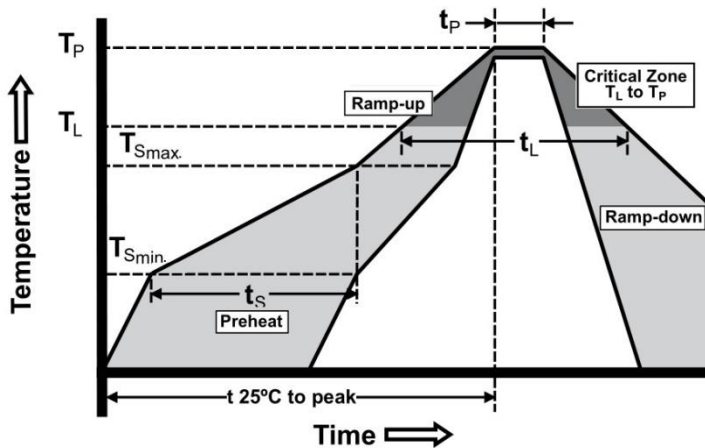

Profile Feature	Pb-Free Assembly
Average Ramp-up Rate (Tsmax to Tp)	3°C/sec Max.
Preheat Temperature Min.(Tsmin)	150°C
Preheat Temperature Max.(Tsmax)	200°C
Preheat Time(Tsmin to Tsmax)	60sec~120sec
Peak Temperature(Tp)	260°C
Time within 5°C of actual Peak Temperature(Tp)	5sec
Melting tin time(TL)	20sec~30sec
Ramp-down Rate	6°C/sec Max.
Time 25°C to peak Temperature	8 min Max.

2. Wave soldering

- Reservoir Temperature: 260°C
- Time in Reservoir: 10sec Max.

3. Hand Soldering

- Temperature: 350°C
- Time: 5sec Max.

Product Characteristics

Item	Test condition / Methods	Performance	Standard
Short Time Overload	$P = 4P_r$; $T = 25^{\circ}\text{C} \pm 2^{\circ}\text{C}$, $t = 5\text{sec}$	$ \Delta R \leq \pm(1\% + 0.5 \text{ m}\Omega)$	IEC 60115-1 4.13
Temperature Coefficient of Resistance (TCR)	$\text{TCR} = \frac{(R - R_0)}{R_0} \frac{(T_2 - T_1)}{T_1} \times 10^6$ Test temperature: $+25^{\circ}\text{C} \sim +125^{\circ}\text{C}$	Refer to SART Spec	IEC 60115-1 4.8
Thermal Shock	-55°C (30min)/ $+150^{\circ}\text{C}$ (30 min), 100 cycles	$ \Delta R \leq \pm(1\% + 0.5 \text{ m}\Omega)$	IEC 60115-1 4.19
Resistance to Solder Heat	$265^{\circ}\text{C} \pm 5^{\circ}\text{C}$, 20sec \pm 1sec	$ \Delta R \leq \pm(1\% + 0.5\text{m}\Omega)$	IEC 60115-1 4.18
Solderability	$245^{\circ}\text{C} \pm 5^{\circ}\text{C}$, 3sec \pm 0.5sec	95% coverage Min.	IEC 60115-1 4.17
Load Life	1000 hours at rated power, $70^{\circ}\text{C} \pm 2^{\circ}\text{C}$, 1.5hours "ON", 0.5hours "OFF"	$ \Delta R \leq \pm(2\% + 0.5 \text{ m}\Omega)$	IEC 60115-1 4.25.1
Moisture Load Life (60°C 、95%RH)	$T = 60^{\circ}\text{C} \pm 2^{\circ}\text{C}$; RH=95% ; $V_{\text{test}} = V_{\text{max}}$; $t = 1.5\text{hours}$ "ON", 0.5hours "OFF" , 1000hours	$ \Delta R \leq \pm(2\% + 0.5 \text{ m}\Omega)$	IEC 60115-1 4.24
Bending test	Bending width 2mm, Epoxy thickness 1.6mm, Fulcrums distance 90mm	$ \Delta R \leq \pm(1\% + 0.5 \text{ m}\Omega)$	IEC 60115-1 4.33
High Temp. Exposure	$T = +170^{\circ}\text{C} \pm 2^{\circ}\text{C}$; $t = 1000\text{hours}$	$ \Delta R \leq \pm(1\% + 0.5 \text{ m}\Omega)$	IEC60115-1 4.25
Low Temp. Storage	$T = -55^{\circ}\text{C} \pm 2^{\circ}\text{C}$; $t = 1000\text{hours}$	$ \Delta R \leq \pm(1\% + 0.5 \text{ m}\Omega)$	IEC60115-1 4.25
Mechanical Shock	$a = 100\text{G}$, $t = 11\text{ms}$, 5 times shock	$ \Delta R \leq \pm(1\% + 0.5 \text{ m}\Omega)$	IEC60115-1 4.21

Packaging

1. Tape Packaging Dimensions

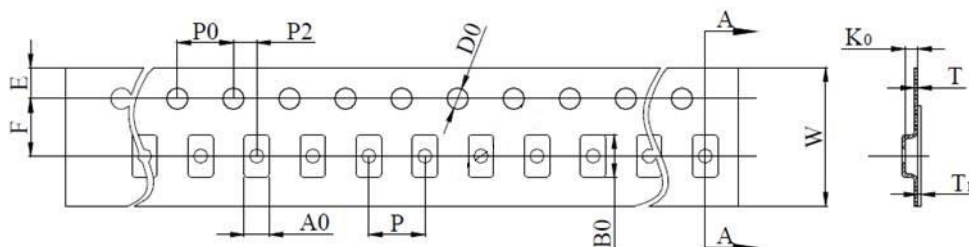

Type	A0 (mm)	B0 (mm)	W (mm)	F (mm)	E (mm)	T (mm)
2512	3.40±0.20	6.75±0.20	12.00±0.30	5.50±0.10	1.75±0.10	0.20±0.10
Type	P (mm)	P0 (mm)	P2 (mm)	D0 (mm)	T1 (mm)	K0 (mm)
2512	4.00±0.10	4.00±0.10	2.00±0.10	1.55±0.10	Max. 0.10	1.3 ^{+0.20} _{-0.10}

2. Reel Dimensions

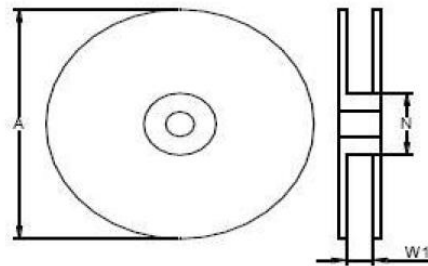

Type	A (mm)	N (mm)	W1 (mm)
2512	178.00±5.00	60.00±2.00	13.00±1.00

3. Quantity of Package

Type	2512
Quantity(PCS)	3000

4. Peeling Test

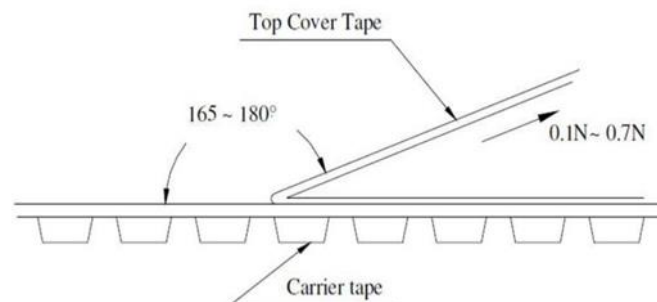

Storage

- The ambient temperature shall be between 5°C~30°C.
- The relative humidity recommended for storage is between 25%RH~60%RH.
- Sealed plastic bags with desiccant shall be used to reduce the oxidation of the termination and shall only be opened prior to use.
- The products shall not be stored in areas where harmful gases containing sulfur or chlorine are present.

X-ON Electronics

Largest Supplier of Electrical and Electronic Components

Click to view similar products for [Current Sense Resistors - SMD category](#):

Click to view products by [SART manufacturer](#):

Other Similar products are found below :

[CRL0603-FW-R700ELF](#) [PFS35-200RF1](#) [NPS 2-T126 5.000 OHM 1%](#) [PFS35-0R01J1](#) [PFS35-0R05J1](#) [PFS35-5RF1](#) [CD2015FC-0.10-1%](#)
[PR2512FKF7W0R004L](#) [RC1005F124CS](#) [RL73K3AR56JTDF](#) [RL7520WT-R001-F](#) [RL7520WT-R009-G](#) [RL7520WT-R020-F](#) [LRC-](#)
[LR2512LF-01-R820J](#) [WR06X104JGLJ](#) [TL2BR01F](#) [65709-330](#) [SP1R12J](#) [RL7520WT-R039-G](#) [RL7520WT-R002-F](#) [LRF2010-R003JW](#)
[KRL1632E-C-R200-F-T5](#) [KRL1632E-C-R200-F-T1](#) [Y14880R02000B9R](#) [RLP73M1ER051FTDF](#) [RLP73M2AR075FTDF](#)
[SR731ERTTP5R10F](#) [SR731ERTTP100J](#) [SR731ERTTP6R80F](#) [SR731ERTTP4R70F](#) [SR731ERTTP2R20F](#) [SR731ERTTP3R90F](#)
[SR731ERTTP1R00F](#) [SR731ERTTP10R0F](#) [SR731ERTTP2R00F](#) [SR731ERTTP8R20F](#) [SR731ERTTP3R9J](#) [SR731ERTTP8R2J](#)
[SR731ERTTP2R0J](#) [SR731ERTTP4R7J](#) [SR731ERTTP9R1J](#) [SR731ERTTP1R0J](#) [SR731ERTTP2R2J](#) [SR731ERTTP5R1J](#) [SR731ERTTP6R8J](#)
[SR731ERTTP9R10F](#) [RCWE2512R180FKEA](#) [FCSL64R007JER](#) [LRF1206-R018FW](#) [TLR2B10DR022FTDG](#)