

General

- Chip size from 0805 to 2512
- Resistance value from 1mΩ to 50mΩ
- Low thermal EMF
- Low TCR
- Lead free, RoHS compliant for global
- Applications and halogen free

Application

- Switching model power supply.
- Battery pack.
- Notebook, personal computer.
- Test Instrument.
- Power Amplifier.

Electrical Specifications

Type	Power Rating at 70°C(W)	Resistance Range (mΩ)	TCR (ppm/°C)	Resistance tolerance	Operation Temp. Range
0805	1	2≤R≤9	±100	±1%(F)	-55°C~+170°C
		10≤R≤50	±50	±0.5%(D) ±1%(F)	
1206	1.5	1≤R≤9	±100	±1%(F)	
		10≤R≤50	±50	±0.5%(D) ±1%(F)	
2512	3	1≤R≤9	±100	±1%(F)	
		10≤R≤50	±50	±0.5%(D) ±1%(F)	

Part Number information

SME 25 A 3 E R002 I

【1】 【2】 【3】 【4】 【5】 【6】 【7】

【1】 Series Name: SART Metal Foil Long Electrode Type

【2】 Chip size: 08:0805 12:1206 25:2512

【3】 Material Code:A:Alloy

【4】 Power Code:3:3W 1:1W B:1.5W

【5】 Resistance Tolerance: D:±0.5% F:±1%

【6】 Resistance Code: R002=2mΩ

【7】 Packaging Code: T:Tape& Reel B:Bulk Pack

Dimensions

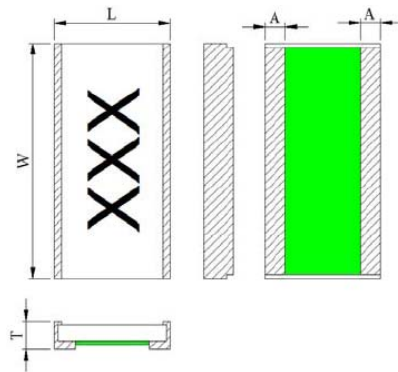

Type	Resistance (mΩ)	W (mm)	L (mm)	T (mm)	A (mm)
0805	2	2.10±0.20	1.35±0.20	0.65±0.20	0.45±0.20
	3~50	2.10±0.20	1.35±0.20	0.65±0.20	0.45±0.20
1206	1	3.30±0.20	1.70±0.20	0.65±0.20	0.55±0.30
	2~50	3.30±0.20	1.70±0.20	0.65±0.20	0.40±0.20
2512	1	6.40±0.30	3.20±0.30	0.65±0.20	0.60±0.20
	2~50	6.40±0.30	3.20±0.30	0.65±0.20	0.60±0.20

Recommended Land Patterns

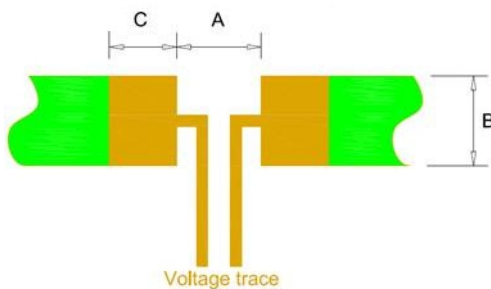

Type	Resistance (mΩ)	A (mm)	B (mm)	C (mm)
0805	2	0.60	2.30	1.10
	3~50	0.60	2.30	1.10
1206	1	0.50	3.68	1.35
	2~50	0.60	3.68	1.30
2512	1	1.40	7.25	2.35
	2~50	1.40	7.25	2.35

Materials

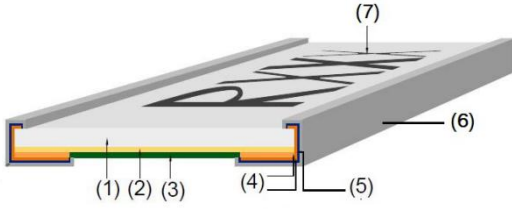

No.	Material	No.	Material
1	Ceramic substrate	5	Nickel
2	Alloy	6	Tin
3	Protective coating	7	Marking
4	Copper	/	/

Power Derating Curve

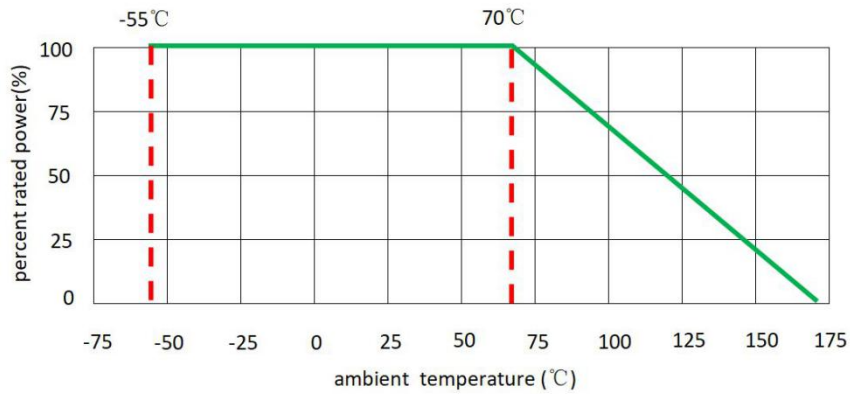

Recommended Solder Curve

1. Infrared Reflow

- Temperature: 260°C
- Time: 5sec Max.
- Recommend Reflow profile:

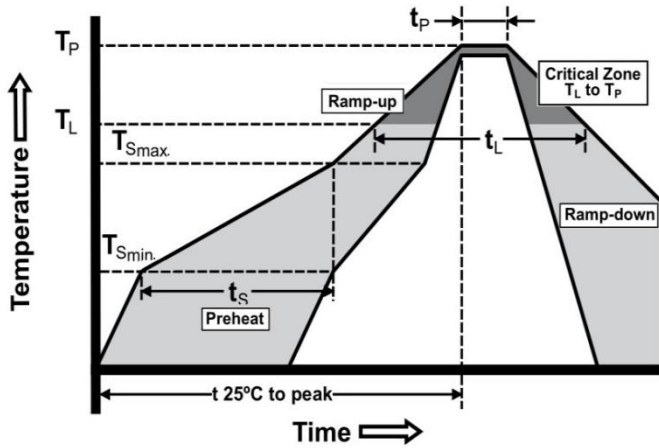

Profile Feature	Pb-Free Assembly
Average Ramp-up Rate (T_{Smax} to T_p)	3°C/sec Max.
Preheat Temperature Min. (T_{Smin}) Temperature Max. (T_{Smax}) Time (T_{Smin} to T_{Smax})	150°C 200°C 60sec~120sec
Peak Temperature (T_p)	260°C
Time within 5°C of actual Peak Temperature (T_p)	5sec
Melting tin time (T_L)	20sec~30sec
Ramp-down Rate	6°C/sec Max.
Time 25°C to peak Temperature	8 min Max.

2. Wave soldering

- Reservoir Temperature: 260°C
- Time in Reservoir: 10sec Max.

3. Hand Soldering

- Temperature: 350°C
- Time: 5sec Max.

Product Characteristics

Item	Test condition / Methods	Performance	Standard
Short Time Overload	$P = 2.5P_r$; $T = 25^{\circ}\text{C} \pm 2^{\circ}\text{C}$, $t = 5\text{sec}$	$ \Delta R \leq \pm(1\% + 0.5\text{ m}\Omega)$	IEC 60115-1 4.13
Temperature Coefficient of Resistance (TCR)	$\text{TCR} = (R - R_0) / R_0 (T_2 - T_1) \times 10^6$ T_1 T_2 Test temperature: $+25^{\circ}\text{C} \sim +125^{\circ}\text{C}$	Refer to SART Spec	IEC 60115-1 4.8
Thermal Shock	-55°C (30min)/ $+150^{\circ}\text{C}$ (30min), 100 cycles	$ \Delta R \leq \pm(1\% + 0.5\text{ m}\Omega)$	IEC 60115-1 4.19
Resistance to Solder Heat	$265^{\circ}\text{C} \pm 5^{\circ}\text{C}$, 20sec \pm 1sec	$ \Delta R \leq \pm(1\% + 0.5\text{ m}\Omega)$	IEC 60115-1 4.18
Solderability	$245^{\circ}\text{C} \pm 5^{\circ}\text{C}$, 3sec \pm 0.5sec	95% coverage Min.	IEC 60115-1 4.17
Load Life	1000 hours at rated power, $70^{\circ}\text{C} \pm 2^{\circ}\text{C}$, 1.5hours "ON", 0.5hours "OFF"	$ \Delta R \leq \pm(2\% + 0.5\text{ m}\Omega)$	IEC 60115-1 4.25
Moisture Load Life (60°C 、95%RH)	$T = 60 \pm 2^{\circ}\text{C}$; RH=95% ; $V_{\text{test}} = V_{\text{max}}$; $t = 1.5\text{hours}$ "ON", 0.5hours "OFF" , 1000hours	$ \Delta R \leq \pm(2\% + 0.5\text{ m}\Omega)$	IEC 60115-1 4.24
Bending test	Bending width 2mm, Epoxy thickness 1.6mm, Fulcrums distance 90mm	$ \Delta R \leq \pm(1\% + 0.5\text{ m}\Omega)$	IEC 60115-1 4.33
High Temp. Exposure	$T = +170^{\circ}\text{C} \pm 2^{\circ}\text{C}$; $t = 1000\text{hours}$	$ \Delta R \leq \pm(1\% + 0.5\text{ m}\Omega)$	IEC60115-1 4.23
Low Temp. Storage	$T = -55^{\circ}\text{C} \pm 2^{\circ}\text{C}$; $t = 1000\text{hours}$	$ \Delta R \leq \pm(1\% + 0.5\text{ m}\Omega)$	IEC60115-1 4.23
Mechanical Shock	$a = 100\text{g's}$, $t = 11\text{ms}$, 5 times shock	$ \Delta R \leq \pm(1\% + 0.5\text{ m}\Omega)$	IEC60115-1 4.21

Packaging

1. Embossed Tape Dimensions

For 0805

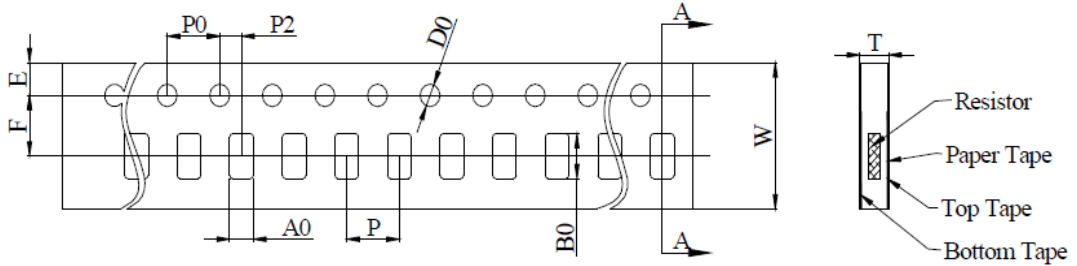

Type	A0 (mm)	B0 (mm)	W (mm)	F (mm)	E (mm)
0805	1.68±0.20	2.38±0.20	8.00±0.30	3.50±0.10	1.75±0.10
Type	P (mm)	P2 (mm)	P0 (mm)	D0 (mm)	T (mm)
0805	4.00±0.10	2.00±0.10	4.00±0.10	1.50±0.10	0.87±0.20

For 1206&2512

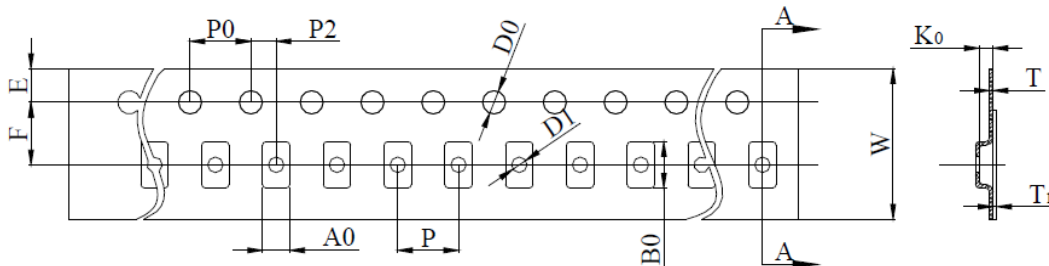

Type	A0 (mm)	B0 (mm)	W (mm)	F (mm)	E (mm)	P (mm)
1206	2.05±0.20	3.65±0.20	8.00±0.30	3.50±0.10	1.75±0.10	4.00±0.10
2512	3.40±0.20	6.75±0.20	12.00±0.30	5.50±0.10	1.75±0.10	4.00±0.10
Type	P2 (mm)	P0 (mm)	D0 (mm)	T (mm)	T1 (mm)	K0 (mm)
1206	2.00±0.10	4.00±0.10	1.50±0.10	0.20±0.10	0.1 Max.	0.85±0.20
2512	2.00±0.10	4.00±0.10	1.50±0.10	0.25±0.10	0.1 Max.	1.00±0.20

2. Reel Dimensions

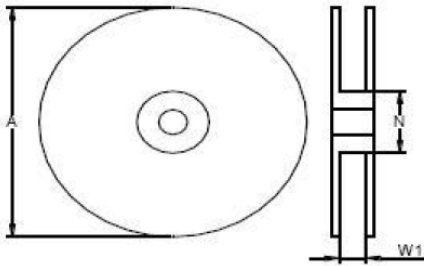

Type	A (mm)	N (mm)	W1 (mm)
0805	178.00±5.00	60.00±2.00	9.00±1.00
1206	178.00±5.00	60.00±2.00	9.00±1.00
2512	178.00±5.00	60.00±2.00	13.00±1.00

3. Quantity of Package

Type	0805	1206	2512
Quantity(pcs)	5000	5000	4000

4. Peeling Test

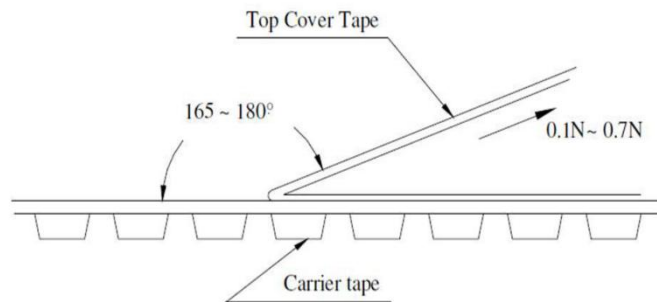

Storage

- The ambient temperature shall between 5°C~30°C.
- The relative humidity recommended for storage is between 25%RH~60%RH.
- Sealed plastic bags with desiccant shall be used to reduce the oxidation of the termination and shall only be opened prior to use.
- The products shall not be stored in areas where harmful gases containing sulfur or chlorine are present.

X-ON Electronics

Largest Supplier of Electrical and Electronic Components

Click to view similar products for [Current Sense Resistors - SMD category](#):

Click to view products by [SART manufacturer](#):

Other Similar products are found below :

[CRL0603-FW-R700ELF](#) [PFS35-200RF1](#) [CD2015FC-0.10-1%](#) [PR2512FKF7W0R004L](#) [RC1005F124CS](#) [CSNL2512FT5L00](#)

[RL73K3AR56JTDF](#) [RL7520WT-R001-F](#) [RL7520WT-R020-F](#) [LRC-LR2512LF-01-R820J](#) [65709-330](#) [SP1R12J](#) [RL7520WT-R039-G](#)

[RL7520WT-R002-F](#) [RL7520WT-R005-F](#) [KRL1632E-C-R200-F-T5](#) [KRL1632E-C-R200-F-T1](#) [Y14880R02000B9R](#) [RLP73M2AR075FTDF](#)

[SR731ERTTP5R10F](#) [SR731ERTTP100J](#) [SR731ERTTP6R80F](#) [SR731ERTTP3R9J](#) [SR731ERTTP8R2J](#) [SR731ERTTP2R0J](#)

[SR731ERTTP4R7J](#) [SR731ERTTP9R1J](#) [SR731ERTTP1R0J](#) [SR731ERTTP2R2J](#) [SR731ERTTP5R1J](#) [SR731ERTTP6R8J](#) [SR731ERTTP9R10F](#)

[FCSL64R007JER](#) [73L4R10G](#) [73L4R75G](#) [73L4R33G](#) [73M1R051F](#) [73WL4R020J](#) [73L2R68J](#) [73L2R22J](#) [73L2R33J](#) [CC1512FC-0.015-5%](#)

[ULRG2-2512-R0075-F-LF-SLT](#) [KDV08DR220ET](#) [KDV12DR240ET](#) [SLN3TTED80L6F](#) [JW104X15X4](#) [JW105X19X5](#) [HVR06FTEV2403](#)

[JW104X5X4](#)