

### General

- Chip size from 0805 to 2512
- Resistance value from 1mΩ to 50mΩ
- Low thermal EMF
- Low TCR
- Lead free, RoHS compliant for global
- Applications and halogen free

### Application

- Switching model power supply.
- Battery pack.
- Notebook, personal computer.
- Test Instrument.
- Power Amplifier.

### Electrical Specifications

Type	Power Rating at 70°C(W)	Resistance Range (mΩ)	TCR (ppm/°C)	Resistance tolerance	Operation Temp. Range
0805	1	2≤R≤9	±100	±1%(F)	-55°C~+170°C
		10≤R≤50	±50	±0.5%(D) ±1%(F)	
1206	1.5	1≤R≤9	±100	±1%(F)	
		10≤R≤50	±50	±0.5%(D) ±1%(F)	
2512	3	1≤R≤9	±100	±1%(F)	
		10≤R≤50	±50	±0.5%(D) ±1%(F)	

### Part Number information

**SME 25 A 3 E R002 I**

**【1】 【2】 【3】 【4】 【5】 【6】 【7】**

**【1】** Series Name: SART Metal Foil Long Electrode Type

**【2】** Chip size: 08:0805 12:1206 25:2512

**【3】** Material Code:A:Alloy

**【4】** Power Code:3:3W 1:1W B:1.5W

**【5】** Resistance Tolerance: D:±0.5% F:±1%

**【6】** Resistance Code: R002=2mΩ

**【7】** Packaging Code: T:Tape& Reel B:Bulk Pack

### Dimensions

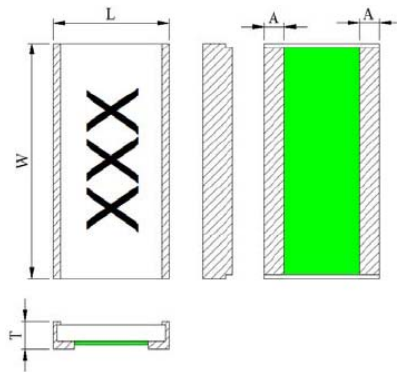

Type	Resistance (mΩ)	W (mm)	L (mm)	T (mm)	A (mm)
0805	2	2.10±0.20	1.35±0.20	0.65±0.20	0.45±0.20
	3~50	2.10±0.20	1.35±0.20	0.65±0.20	0.45±0.20
1206	1	3.30±0.20	1.70±0.20	0.65±0.20	0.55±0.30
	2~50	3.30±0.20	1.70±0.20	0.65±0.20	0.40±0.20
2512	1	6.40±0.30	3.20±0.30	0.65±0.20	0.60±0.20
	2~50	6.40±0.30	3.20±0.30	0.65±0.20	0.60±0.20

### Recommended Land Patterns

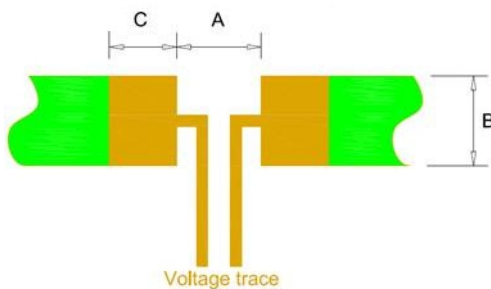

Type	Resistance (mΩ)	A (mm)	B (mm)	C (mm)
0805	2	0.60	2.30	1.10
	3~50	0.60	2.30	1.10
1206	1	0.50	3.68	1.35
	2~50	0.60	3.68	1.30
2512	1	1.40	7.25	2.35
	2~50	1.40	7.25	2.35

## Materials

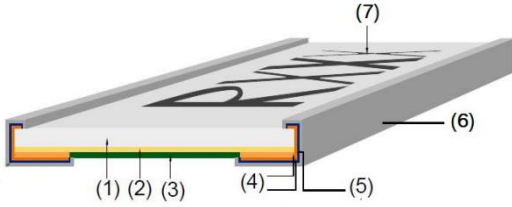

No.	Material	No.	Material
1	Ceramic substrate	5	Nickel
2	Alloy	6	Tin
3	Protective coating	7	Marking
4	Copper	/	/

## Power Derating Curve

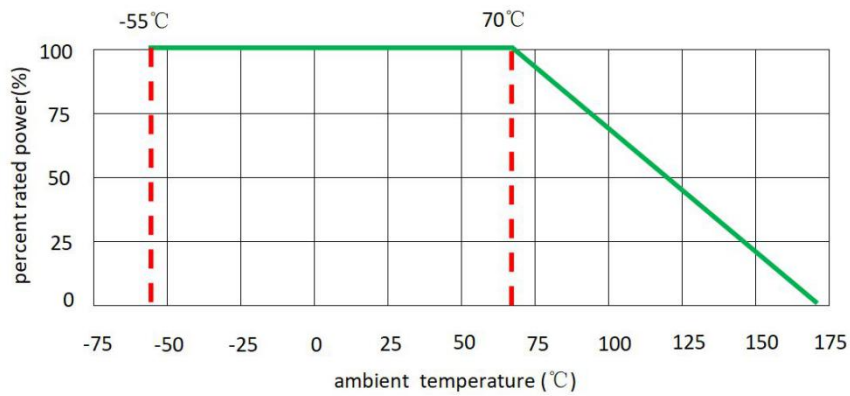

## Recommended Solder Curve

### 1. Infrared Reflow

- Temperature: 260°C
- Time: 5sec Max.
- Recommend Reflow profile:

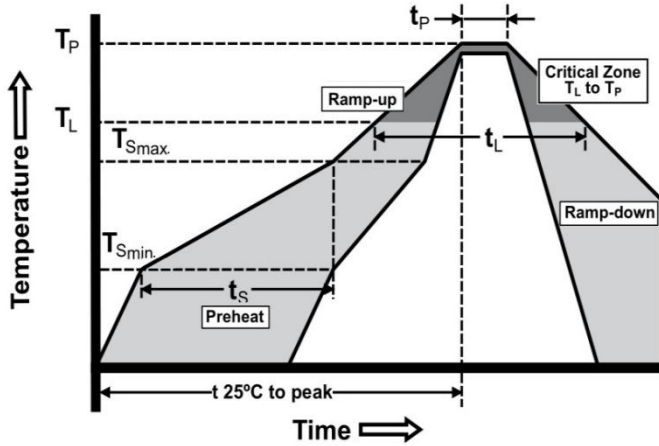

Profile Feature	Pb-Free Assembly
Average Ramp-up Rate (T <sub>Smax</sub> to T <sub>p</sub> )	3°C/sec Max.
Preheat Temperature Min.(T <sub>Smin</sub> ) Temperature Max.(T <sub>Smax</sub> ) Time(T <sub>Smin</sub> to T <sub>Smax</sub> )	150°C 200°C 60sec~120sec
Peak Temperature(T <sub>p</sub> )	260°C
Time within 5°C of actual Peak Temperature(T <sub>p</sub> )	5sec
Melting tin time(T <sub>L</sub> )	20sec~30sec
Ramp-down Rate	6°C/sec Max.
Time 25°C to peak Temperature	8 min Max.

### 2. Wave soldering

- Reservoir Temperature: 260°C
- Time in Reservoir: 10sec Max.

### 3. Hand Soldering

- Temperature: 350°C
- Time: 5sec Max.

## Product Characteristics

Item	Test condition / Methods	Performance	Standard
Short Time Overload	P= 2.5Pr; T=25°C±2°C , t = 5sec	$ \Delta R  \leq \pm(1\%+0.5 \text{ m}\Omega)$	IEC 60115-1 4.13
Temperature Coefficient of Resistance (TCR)	$\text{TCR} = \frac{R - R_0}{R_0} \frac{T_2 - T_1}{T_2 - T_1} \times 10^6$ Test temperature: +25°C~+125°C	Refer to SART Spec	IEC 60115-1 4.8
Thermal Shock	-55°C(30min)/+150°C(30min), 100 cycles	$ \Delta R  \leq \pm(1\%+0.5 \text{ m}\Omega)$	IEC 60115-1 4.19
Resistance to Solder Heat	265°C±5°C, 20sec±1sec	$ \Delta R  \leq \pm(1\%+0.5\text{m}\Omega)$	IEC 60115-1 4.18
Solderability	245°C±5°C, 3sec±0.5sec	95% coverage Min.	IEC 60115-1 4.17
Load Life	1000 hours at rated power, 70°C±2°C, 1.5hours "ON", 0.5hours "OFF"	$ \Delta R  \leq \pm(2\% +0.5 \text{ m}\Omega)$	IEC 60115-1 4.25
Moisture Load Life (60°C、95%RH)	T=60±2°C ; RH=95% ; V <sub>test</sub> = V <sub>max</sub> ; t=1.5hours "ON",0.5hours "OFF" , 1000hours	$ \Delta R  \leq \pm(2\%+0.5 \text{ m}\Omega)$	IEC 60115-1 4.24
Bending test	Bending width 2mm, Epoxy thickness 1.6mm, Fulcrums distance 90mm	$ \Delta R  \leq \pm(1\%+0.5 \text{ m}\Omega)$	IEC 60115-1 4.33
High Temp. Exposure	T = +170°C±2°C ; t = 1000hours	$ \Delta R  \leq \pm(1\%+0.5 \text{ m}\Omega)$	IEC60115-1 4.23
Low Temp. Storage	T = -55°C±2°C ; t = 1000hours	$ \Delta R  \leq \pm(1\%+0.5 \text{ m}\Omega)$	IEC60115-1 4.23
Mechanical Shock	a =100g`s , t =11ms, 5 times shock	$ \Delta R  \leq \pm(1\%+0.5 \text{ m}\Omega)$	IEC60115-1 4.21

## Packaging

### 1. Embossed Tape Dimensions

For 0805

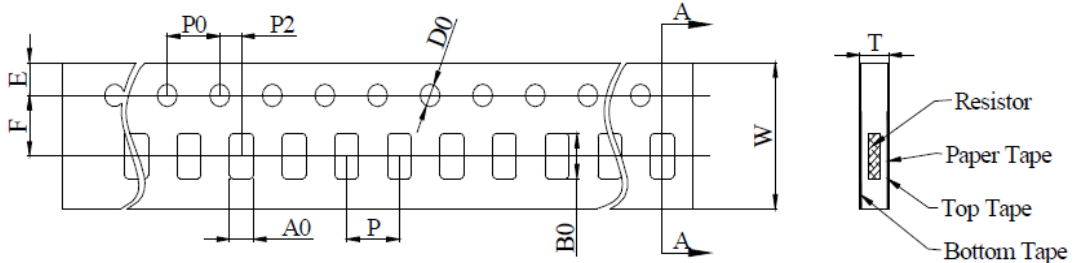

Type	A0 (mm)	B0 (mm)	W (mm)	F (mm)	E (mm)
0805	1.68±0.20	2.38±0.20	8.00±0.30	3.50±0.10	1.75±0.10
Type	P (mm)	P2 (mm)	P0 (mm)	D0 (mm)	T (mm)
0805	4.00±0.10	2.00±0.10	4.00±0.10	1.50±0.10	0.87±0.20

For 1206&2512

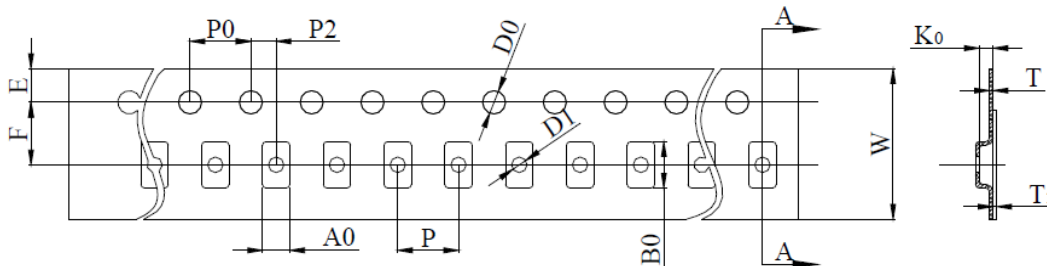

Type	A0 (mm)	B0 (mm)	W (mm)	F (mm)	E (mm)	P (mm)
1206	2.05±0.20	3.65±0.20	8.00±0.30	3.50±0.10	1.75±0.10	4.00±0.10
2512	3.40±0.20	6.75±0.20	12.00±0.30	5.50±0.10	1.75±0.10	4.00±0.10
Type	P2 (mm)	P0 (mm)	D0 (mm)	T (mm)	T1 (mm)	K0 (mm)
1206	2.00±0.10	4.00±0.10	1.50±0.10	0.20±0.10	0.1 Max.	0.85±0.20
2512	2.00±0.10	4.00±0.10	1.50±0.10	0.25±0.10	0.1 Max.	1.00±0.20

2. Reel Dimensions

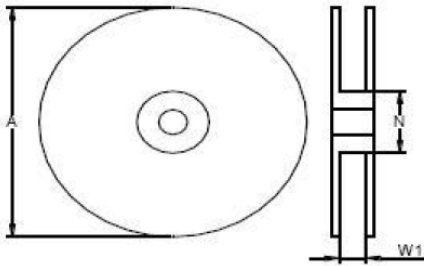

Type	A (mm)	N (mm)	W1 (mm)
0805	178.00±5.00	60.00±2.00	9.00±1.00
1206	178.00±5.00	60.00±2.00	9.00±1.00
2512	178.00±5.00	60.00±2.00	13.00±1.00

3. Quantity of Package

Type	0805	1206	2512
Quantity(pcs)	5000	5000	4000

4. Peeling Test

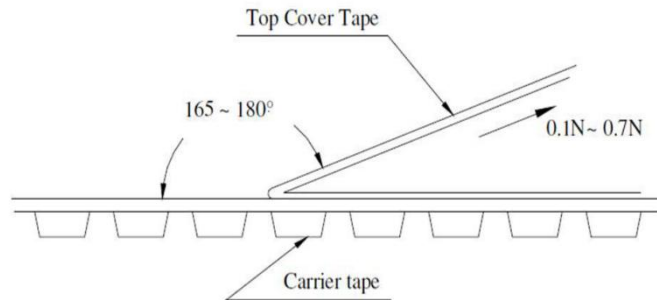

**Storage**

- The ambient temperature shall between 5°C~30°C.
- The relative humidity recommended for storage is between 25%RH~60%RH.
- Sealed plastic bags with desiccant shall be used to reduce the oxidation of the termination and shall only be opened prior to use.
- The products shall not be stored in areas where harmful gases containing sulfur or chlorine are present.

## X-ON Electronics

Largest Supplier of Electrical and Electronic Components

*Click to view similar products for [Current Sense Resistors - SMD category](#):*

*Click to view products by [SART manufacturer](#):*

Other Similar products are found below :

[CRL0603-FW-R700ELF](#) [PFS35-200RF1](#) [NPS 2-T126 5.000 OHM 1%](#) [PFS35-0R01J1](#) [PFS35-0R05J1](#) [PFS35-5RF1](#) [CD2015FC-0.10-1%](#)  
[PR2512FKF7W0R004L](#) [RC1005F124CS](#) [RL73K3AR56JTDF](#) [RL7520WT-R001-F](#) [RL7520WT-R009-G](#) [RL7520WT-R020-F](#) [LRC-](#)  
[LR2512LF-01-R820J](#) [WR06X104JGLJ](#) [TL2BR01F](#) [65709-330](#) [SP1R12J](#) [RL7520WT-R039-G](#) [RL7520WT-R002-F](#) [LRF2010-R003JW](#)  
[KRL1632E-C-R200-F-T5](#) [KRL1632E-C-R200-F-T1](#) [RLP73M1ER051FTDF](#) [RLP73M2AR075FTDF](#) [RLP73M1JR051FTDF](#)  
[SR731ERTTP5R10F](#) [SR731ERTTP100J](#) [SR731ERTTP6R80F](#) [SR731ERTTP4R70F](#) [SR731ERTTP2R20F](#) [SR731ERTTP3R90F](#)  
[SR731ERTTP1R00F](#) [SR731ERTTP10R0F](#) [SR731ERTTP2R00F](#) [SR731ERTTP8R20F](#) [SR731ERTTP3R9J](#) [SR731ERTTP8R2J](#)  
[SR731ERTTP2R0J](#) [SR731ERTTP4R7J](#) [SR731ERTTP9R1J](#) [SR731ERTTP1R0J](#) [SR731ERTTP2R2J](#) [SR731ERTTP5R1J](#) [SR731ERTTP6R8J](#)  
[SR731ERTTP9R10F](#) [RCWE2512R180FKEA](#) [FCSL64R007JER](#) [LRF1206-R018FW](#) [TLR2B10DR022FTDG](#)