



General

- Chip size from 0603 to 2512
- Resistance value from 2mΩ to 200mΩ
- Low thermal EMF
- Low TCR
- Lead free, RoHS compliant for global
- Applications and halogen free

Application

- Switching model power supply
- Battery pack
- Notebook, personal computer
- Test Instrument
- Power Amplifier

Electrical Specifications

| Type | Power Rating at 70°C (W) | Resistance Range(mΩ) | TCR (ppm/°C) | Resistance tolerance | Operation Temp. Range |
|------|--------------------------|----------------------|--------------|--|-----------------------|
| 0603 | 0.5 | 3≤R≤9 | ±200 | ±0.5%(D) ±1%(F) ±2%(G) ±5%(J) | -55°C~+170°C |
| | | 10≤R≤30 | ±100 | | |
| 0805 | 0.5 0.75 | 3≤R≤9 | ±100 | | |
| | | 10≤R≤47 | ±50 | | |
| 1206 | 0.5 1.0 | 3≤R≤9 | ±100 | | |
| | | 10≤R≤68 | ±50 | | |
| 2010 | 1.0 | 3≤R≤9 | ±100 | | |
| | | 10≤R≤100 | ±50 | | |
| 2512 | 1.0 2.0* | 2 | ±200 | | |
| | | 2.5 | ±200 | | |
| | | 3≤R≤9 | ±100 | | |
| | | 10≤R≤200 | ±50 | | |

*: 2512 2W applicable resistance range 2~100mΩ

Remark:

- 0.5 W with total solder pad trace size of 100 mm².
- 0.75 W with total solder pad trace size of 200 mm².
- 1.0 W with total solder pad trace size of 200 mm²
- 2.0 W with total solder pad trace size of 300 mm².

Part Number Information

SMF 25 M 2 E R010 I

【1】 【2】 【3】 【4】 【5】 【6】 【7】

- 【1】 Series Name: SART Metal Foil Type
- 【2】 Chip size:06:0603 08:0805 12:1206 20:2010 25:2512
- 【3】 Material Code: M:Mn-Cu
- 【4】 Power Code: A :0.5W C:0.75W 1:1W 2:2W
- 【5】 Resistance Tolerance: D:±0.5% F:±1% G:±2% J:±5%
- 【6】 Resistance Code:R010=10mΩ 2M50=2.5mΩ
- 【7】 Packaging Code: T: Tape& Reel B: Bulk Pack

Dimensions

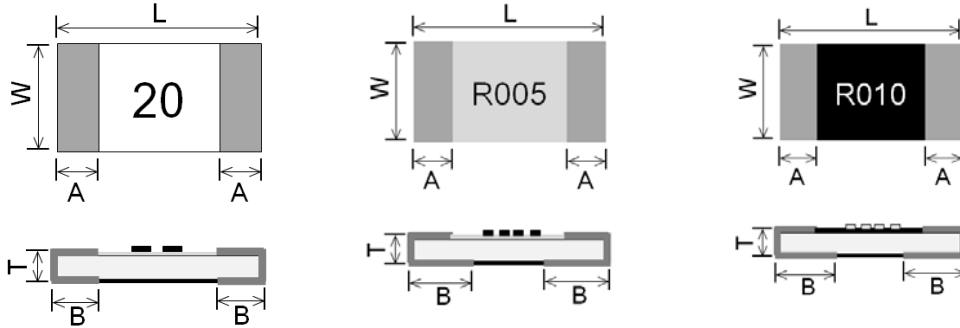

| Type | Resistance Range(mΩ) | L (mm) | W (mm) | T (mm) | A (mm) | B (mm) |
|--------|----------------------|-----------|-----------|-----------|-----------|-----------|
| 0603* | 3~4 | 1.60±0.20 | 0.80±0.20 | 0.70±0.15 | 0.35±0.25 | 0.60±0.20 |
| | ≥5 | | | | | 0.35±0.20 |
| 0805** | 3~4 | 2.00±0.20 | 1.25±0.15 | 0.70±0.15 | 0.40±0.25 | 0.70±0.30 |
| | ≥5 | | | | | 0.40±0.20 |
| 1206 | 3~4 | 3.20±0.20 | 1.60±0.15 | 0.75±0.15 | 0.50±0.30 | 0.90±0.30 |
| | ≥5 | | | | | 0.50±0.20 |
| 2010 | 3 | 5.00±0.20 | 2.50±0.20 | 0.75±0.20 | 0.60±0.30 | 1.60±0.30 |
| | 4~5 | | | | | 1.30±0.30 |
| | ≥6 | | | | | 0.80±0.30 |
| 2512 | 2 | 6.40±0.20 | 3.20±0.20 | 0.75±0.20 | 0.90±0.30 | 2.30±0.30 |
| | 2.5 | | | | | 2.30±0.30 |
| | 3 | | | | | 1.90±0.30 |
| | 4 | | | | | 1.70±0.30 |
| | 5~6 | | | | | 1.20±0.30 |
| | 7 | | | | | 1.10±0.30 |
| | ≥8 | | | | | 0.90±0.30 |

Remark*: 0603 two-digit mark; **: 0805 $3m\Omega \leq R \leq 9m\Omega$ & 2010 no upper black coating

Recommended Land Patterns

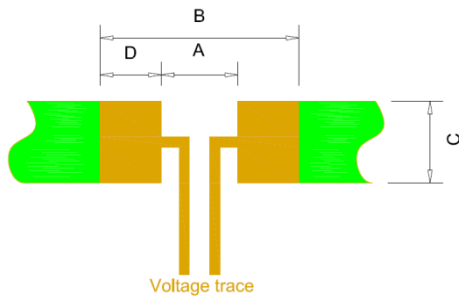

| Type | Resistance Range (mΩ) | A (mm) | B (mm) | C (mm) | D (mm) |
|------|-----------------------|--------|--------|--------|--------|
| 0603 | 3~4 | 0.40 | 2.80 | 1.00 | 1.20 |
| | ≥5 | 0.60 | | | 1.10 |
| 0805 | 3~4 | 0.50 | 3.20 | 1.40 | 1.35 |
| | ≥5 | 0.80 | | | 1.20 |
| 1206 | 3~4 | 0.80 | 4.40 | 1.80 | 1.80 |
| | ≥5 | 1.80 | | | 1.30 |
| 2010 | 3~9 | 1.60 | 6.30 | 2.90 | 2.35 |
| | 10~100 | 2.70 | | | 1.80 |
| 2512 | 2 | 1.40 | 8.00 | 3.40 | 3.30 |
| | 2.5 | 1.40 | | | 3.30 |
| | 3 | 2.20 | | | 2.90 |
| | 4 | 2.60 | | | 2.70 |
| | 5~6 | 3.60 | | | 2.00 |
| | 7 | 3.80 | | | 2.20 |
| | ≥8 | 4.20 | | | 1.90 |

Materials

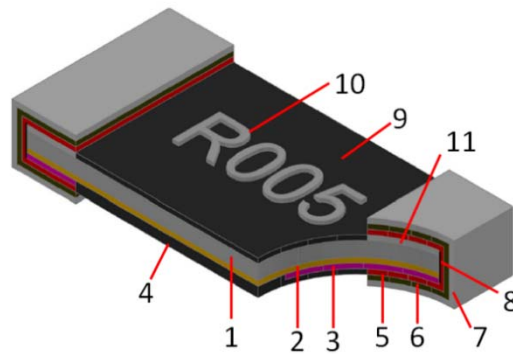

| No. | Materials | No. | Materials |
|-----|--------------------|-----|--------------------|
| 1 | Ceramic | 7 | Tin |
| 2 | Adhesive film | 8 | Nicr |
| 3 | Alloy | 9 | Protective coating |
| 4 | Protective coating | 10 | Marking |
| 5 | Copper | 11 | Silver paste |
| 6 | Nickel | / | / |

Power Derating Curve



Recommended Solder Curve

1. Infrared Reflow

Temperature: 260°C

Time: 5sec Max.

Recommend Reflow profile:



| Profile Feature | Pb-Free Assembly |
|---|------------------|
| Average Ramp-Up Rate (T _{smax} to T _p) | 3°C/sec Max. |
| Preheat | 150°C |
| Temperature Min(T _{smin}) | 200°C |
| Temperature Max(T _{smax}) | 60sec~120sec |
| Time(T _{smin} to T _{smax}) | 260°C |
| Peak Temperature(T _p) | 5sec |
| Time within 5°C of actual Peak Temperature(T _p) | 20sec~30sec |
| Melting tin time(T _L) | 6°C/sec Max. |
| Ramp-Down Rate | 8min Max. |
| Time 25°C to Peak Temperature | |

2. Wave soldering

Reservoir Temperature : 260°C

Time in Reservoir : 10sec Max.

3. Hand Soldering

Temperature : 350°C

Time : 5sec Max.

Product Characteristics

| Item | Test condition/ Methods | Performance | Standard |
|--|---|---------------------------|-----------------|
| Short Time Overload | 0.5W:5X rated power for 5 sec 0.75W:5X rated power for 5 sec 1.0W:5X rated power for 5 sec 2.0W:4X rated power for 5 sec | $ \Delta R \leq \pm 1\%$ | IEC60115-1 4.13 |
| Temperature Coefficient of Resistance (T.C.R.) | $TCR = (R - R_0) / R_0 (T_2 - T_1) \times 10^6$ T1 T2 Test temperature: 25°C~125°C | Refer to SART Spec | IEC60115-1 4.8 |
| Load Life | 1000 hours at rated power, 70°C±2°C, 1.5hours "ON", 0.5hours "OFF" | $ \Delta R \leq \pm 1\%$ | IEC60115-1 4.25 |
| Bias Humidity | 40°C±2°C, 93% ±3% RH, 1000 hours at rated power, 1.5 hours "ON", 0.5 hours "OFF" | $ \Delta R \leq \pm 1\%$ | IEC60115-1 4.24 |
| Thermal Shock | -55°C(30min)/+125°C (30min), 100 cycles | $ \Delta R \leq \pm 1\%$ | IEC60115-1 4.19 |
| Solder ability | 245°C±5°C, 3sec ± 0.3sec | 95%coverage Min. | IEC60115-1 4.17 |
| Resistance to Soldering Heat | 270°C±5°C, 10sec ±1.0sec | $ \Delta R \leq \pm 1\%$ | IEC60115-1 4.18 |
| High temperature Exposure | 170°C±2°C for 1000 hours | $ \Delta R \leq \pm 1\%$ | IEC60115-1 4.23 |
| Bending test | Epoxy thickness1.6mm, Fulcrums distance 90mm,Bending width 5mm (0603、0805) , Bending width 4mm (1206) .Bending width 2mm (2010、2512) | $ \Delta R \leq \pm 1\%$ | IEC60115-1 4.33 |

Packaging

1. Paper Tape Dimensions

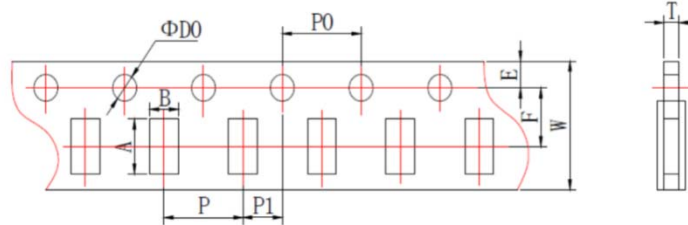

| Type | A (mm) | B (mm) | W (mm) | F (mm) | E (mm) |
|------|-----------|-----------|-----------|-----------|-----------|
| 0603 | 1.85±0.10 | 1.10±0.10 | 8.00±0.20 | 3.50±0.05 | 1.75±0.10 |
| 0805 | 2.40±0.10 | 1.60±0.10 | 8.00±0.20 | 3.50±0.05 | 1.75±0.10 |
| 1206 | 3.60±0.20 | 2.00±0.20 | 8.00±0.20 | 3.50±0.05 | 1.75±0.10 |
| Type | P (mm) | P0 (mm) | P1 (mm) | D0 (mm) | T (mm) |
| 0603 | 4.00±0.10 | 4.00±0.10 | 2.00±0.05 | 1.50±0.10 | 0.75±0.10 |
| 0805 | 4.00±0.10 | 4.00±0.10 | 2.00±0.05 | 1.50±0.10 | 0.95±0.10 |
| 1206 | 4.00±0.10 | 4.00±0.10 | 2.00±0.05 | 1.50±0.10 | 0.95±0.10 |

2. Embossed Tape Dimensions

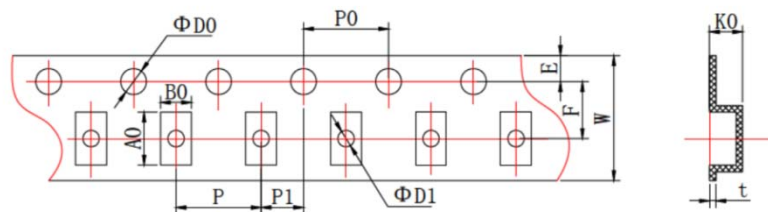

| Type | A0 (mm) | B0 (mm) | W (mm) | F (mm) | E (mm) | T (mm) |
|------|-----------|-----------|------------|------------------------------------|-----------|-----------|
| 2010 | 5.50±0.15 | 2.80±0.15 | 12.00±0.10 | 5.50±0.10 | 1.75±0.10 | 0.24±0.05 |
| 2512 | 6.75±0.15 | 3.45±0.15 | 12.00±0.10 | 5.50±0.10 | 1.75±0.10 | 0.25±0.05 |
| Type | P (mm) | P0 (mm) | P1 (mm) | D0 (mm) | D1 (mm) | K0 (mm) |
| 2010 | 4.00±0.10 | 4.00±0.10 | 2.00±0.05 | 1.50 ^{+0.10} ₀ | 1.50±0.10 | 0.85±0.05 |
| 2512 | 4.00±0.10 | 4.00±0.10 | 2.00±0.05 | 1.50 ^{+0.10} ₀ | 1.50±0.10 | 1.00±0.10 |

3.Reel Dimensions

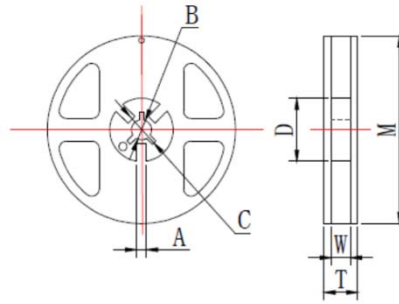

| Type | M (mm) | W (mm) | T (mm) | A (mm) | B (mm) | C (mm) | D (mm) |
|----------------------|-------------|------------|------------|-----------|------------|------------|------------|
| 0603 0805 1206 | 178.00±2.00 | 9.5±1.00 | 12.50±1.50 | 2.00±0.50 | 13.00±0.50 | 21.00±0.50 | 58.00±0.20 |
| 2010 2512 | 178.00±2.00 | 13.00±0.50 | 15.50±1.50 | 2.00±0.50 | 13.00±0.50 | 21.00±0.50 | 57.00±2.00 |

4. Quantity of Package

| Type | 0603 | 0805 | 1206 | 2010 | 2512 |
|---------------|------|------|------|------|------|
| Quantity(PCS) | 5000 | | | 4000 | |

5. Peeling Test

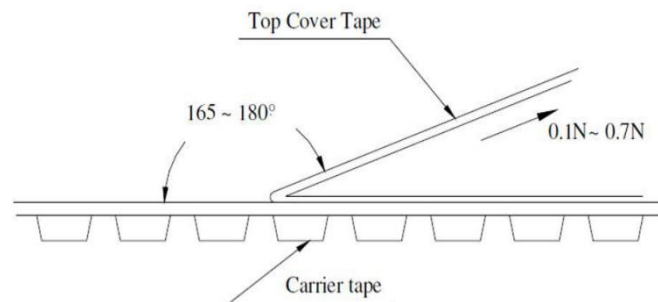

Storage

- The ambient temperature shall be between 5°C~30°C.
- The relative humidity recommended for storage is between 25%RH~60%RH.
- Sealed plastic bags with desiccant shall be used to reduce the oxidation of the termination and shall only be opened prior to use.
- The products shall not be stored in areas where harmful gases containing sulfur or chlorine are present.

X-ON Electronics

Largest Supplier of Electrical and Electronic Components

Click to view similar products for [Current Sense Resistors - SMD category](#):

Click to view products by [SART manufacturer](#):

Other Similar products are found below :

[CRL0603-FW-R700ELF](#) [CD2015FC-0.10-1%](#) [PR2512FKF7W0R004L](#) [RC1005F124CS](#) [RL73K3AR56JTDF](#) [RL7520WT-R001-F](#)
[RL7520WT-R009-G](#) [RL7520WT-R020-F](#) [LRC-LR2010LF-01-R033J](#) [LRC-LR2512LF-01-R820J](#) [65709-330](#) [SP1R12J](#) [RL7520WT-R039-G](#)
[RL7520WT-R002-F](#) [RL7520WT-R005-F](#) [KRL1632E-C-R200-F-T5](#) [KRL1632E-C-R200-F-T1](#) [Y14880R02000B9R](#) [RLP73M2AR075FTDF](#)
[SR731ERTTP5R10F](#) [SR731ERTTP100J](#) [SR731ERTTP6R80F](#) [SR731ERTTP3R9J](#) [SR731ERTTP8R2J](#) [SR731ERTTP2R0J](#)
[SR731ERTTP4R7J](#) [SR731ERTTP9R1J](#) [SR731ERTTP1R0J](#) [SR731ERTTP2R2J](#) [SR731ERTTP5R1J](#) [SR731ERTTP6R8J](#) [SR731ERTTP9R10F](#)
[FCSL64R007JER](#) [73L4R10G](#) [73L4R75G](#) [73L4R33G](#) [73M1R051F](#) [73WL4R020J](#) [73L2R68J](#) [73L2R22J](#) [73L2R33J](#) [CC1512FC-0.015-5%](#)
[ULRG2-2512-R0075-F-LF-SLT](#) [ULR3N-R00075FT2](#) [ULR3N-R0009FT2](#) [KDV08DR220ET](#) [KDV12DR240ET](#) [SLN3TTED80L6F](#)
[JW104X15X4](#) [JW105X19X5](#)