

### General

- Chip size from 0603 to 2512
- Resistance value from 2mΩ to 200mΩ
- Low thermal EMF
- Low TCR
- Lead free, RoHS compliant for global
- Applications and halogen free

### Application

- Switching model power supply
- Battery pack
- Notebook, personal computer
- Test Instrument
- Power Amplifier

### Electrical Specifications

Type	Power Rating at 70°C (W)	Resistance Range(mΩ)	TCR (ppm/°C)	Resistance tolerance	Operation Temp. Range
0603	0.5	3≤R≤9	±200	±0.5%(D) ±1%(F) ±2%(G) ±5%(J)	-55°C~+170°C
		10≤R≤30	±100		
0805	0.5	3≤R≤9	±100		
	0.75	10≤R≤47	±50		
1206	0.5	3≤R≤9	±100		
	1.0	10≤R≤68	±50		
2010	1.0	3≤R≤9	±100		
		10≤R≤100	±50		
2512	1.0 2.0*	2	±200		
		2.5	±200		
		3≤R≤9	±100		
		10≤R≤200	±50		

\*: 2512 2W applicable resistance range 2~100mΩ

Remark:

- 0.5 W with total solder pad trace size of 100 mm<sup>2</sup>.
- 0.75 W with total solder pad trace size of 200 mm<sup>2</sup>.
- 1.0 W with total solder pad trace size of 200 mm<sup>2</sup>
- 2.0 W with total solder pad trace size of 300 mm<sup>2</sup>.

### Part Number Information

SMF 25 M 2 E R010 I

【1】 【2】 【3】 【4】 【5】 【6】 【7】

- 【1】 Series Name: SART Metal Foil Type
- 【2】 Chip size:06:0603 08:0805 12:1206 20:2010 25:2512
- 【3】 Material Code: M:Mn-Cu
- 【4】 Power Code: A :0.5W C:0.75W 1:1W 2:2W
- 【5】 Resistance Tolerance: D:±0.5% F:±1% G:±2% J:±5%
- 【6】 Resistance Code:R010=10mΩ 2M50=2.5mΩ
- 【7】 Packaging Code: T: Tape& Reel B:Bulk Pack

### Dimensions

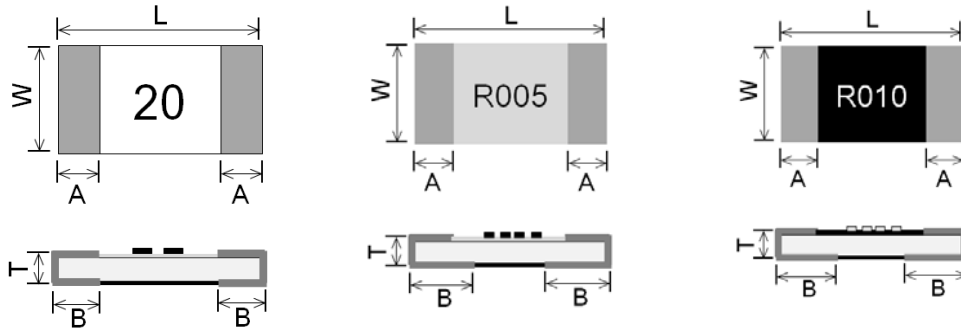

Type	Resistance Range(mΩ)	L (mm)	W (mm)	T (mm)	A (mm)	B (mm)
0603*	3~4	1.60±0.20	0.80±0.20	0.70±0.15	0.35±0.25	0.60±0.20
	≥5					0.35±0.20
0805**	3~4	2.00±0.20	1.25±0.15	0.70±0.15	0.40±0.25	0.70±0.30
	≥5					0.40±0.20
1206	3~4	3.20±0.20	1.60±0.15	0.75±0.15	0.50±0.30	0.90±0.30
	≥5					0.50±0.20
2010	3	5.00±0.20	2.50±0.20	0.75±0.20	0.60±0.30	1.60±0.30
	4~5					1.30±0.30
	≥6					0.80±0.30
2512	2	6.40±0.20	3.20±0.20	0.75±0.20	0.90±0.30	2.30±0.30
	2.5					2.30±0.30
	3					1.90±0.30
	4					1.70±0.30
	5~6					1.20±0.30
	7					1.10±0.30
	≥8					0.90±0.30

Remark\*: 0603 two-digit mark; \*\*: 0805  $3m\Omega \leq R \leq 9m\Omega$  & 2010 no upper black coating

### Recommended Land Patterns

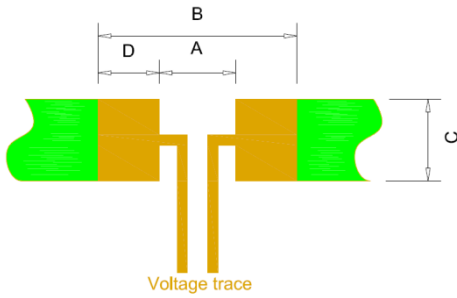

Type	Resistance Range (mΩ)	A (mm)	B (mm)	C (mm)	D (mm)
0603	3~4	0.40	2.80	1.00	1.20
	≥5	0.60			1.10
0805	3~4	0.50	3.20	1.40	1.35
	≥5	0.80			1.20
1206	3~4	0.80	4.40	1.80	1.80
	≥5	1.80			1.30
2010	3~9	1.60	6.30	2.90	2.35
	10~100	2.70			1.80
2512	2	1.40	8.00	3.40	3.30
	2.5	1.40			3.30
	3	2.20			2.90
	4	2.60			2.70
	5~6	3.60			2.00
	7	3.80			2.20
	≥8	4.20			1.90

### Materials

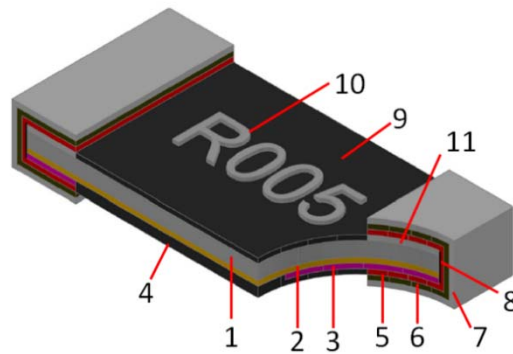

No.	Materials	No.	Materials
1	Ceramic	7	Tin
2	Adhesive film	8	Nicr
3	Alloy	9	Protective coating
4	Protective coating	10	Marking
5	Copper	11	Silver paste
6	Nickel	/	/

## Power Derating Curve

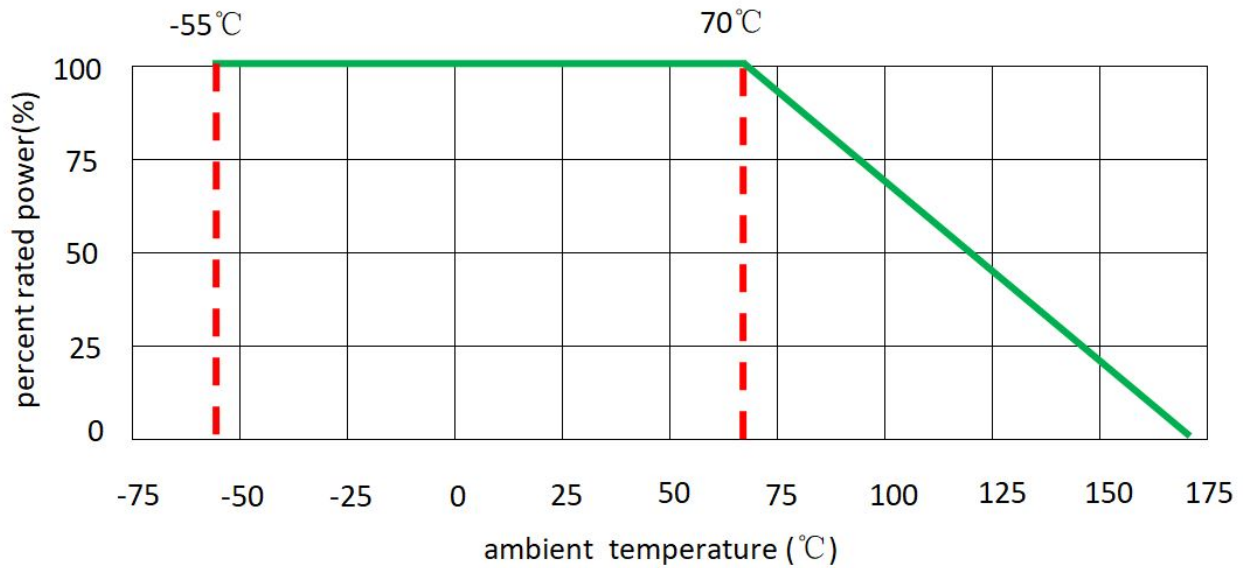

## Recommended Solder Curve

### 1. Infrared Reflow

Temperature: 260°C

Time: 5sec Max.

Recommend Reflow profile:

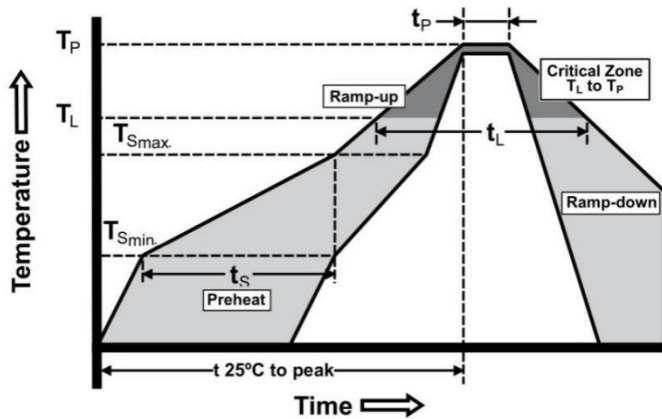

Profile Feature	Pb-Free Assembly
Average Ramp-Up Rate (Ts <sub>max</sub> to Tp)	3°C/sec Max.
Preheat	150°C
Temperature Min(Ts <sub>min</sub> )	200°C
Temperature Max(Ts <sub>max</sub> )	60sec~120sec
Time(Ts <sub>min</sub> to Ts <sub>max</sub> )	260°C
Peak Temperature(Tp)	5sec
Time within 5°C of actual Peak Temperature(Tp)	20sec~30sec
Melting tin time(T <sub>L</sub> )	6°C/sec Max.
Ramp-Down Rate	8min Max.
Time 25°C to Peak Temperature	

### 2. Wave soldering

Reservoir Temperature : 260°C

Time in Reservoir : 10sec Max.

### 3. Hand Soldering

Temperature : 350°C

Time : 5sec Max.

### Product Characteristics

Item	Test condition/ Methods	Performance	Standard
Short Time Overload	0.5W:5X rated power for 5 sec 0.75W:5X rated power for 5 sec 1.0W:5X rated power for 5 sec 2.0W:4X rated power for 5 sec	$ \Delta R  \leq \pm 1\%$	IEC60115-1 4.13
Temperature Coefficient of Resistance (T.C.R.)	$TCR = (R - R_0) / R_0 (T_2 - T_1) \times 10^6$ T1 T2 Test temperature: 25°C~125°C	Refer to SART Spec	IEC60115-1 4.8
Load Life	1000 hours at rated power, 70°C±2°C, 1.5hours "ON", 0.5hours "OFF"	$ \Delta R  \leq \pm 1\%$	IEC60115-1 4.25
Bias Humidity	40°C±2°C, 93% ±3% RH, 1000 hours at rated power, 1.5 hours "ON", 0.5 hours "OFF"	$ \Delta R  \leq \pm 1\%$	IEC60115-1 4.24
Thermal Shock	-55°C(30min)/+125°C (30min), 100 cycles	$ \Delta R  \leq \pm 1\%$	IEC60115-1 4.19
Solder ability	245°C±5°C, 3sec ± 0.3sec	95%coverage Min.	IEC60115-1 4.17
Resistance to Soldering Heat	270°C±5°C, 10sec ±1.0sec	$ \Delta R  \leq \pm 1\%$	IEC60115-1 4.18
High temperature Exposure	170°C±2°C for 1000 hours	$ \Delta R  \leq \pm 1\%$	IEC60115-1 4.23
Bending test	Epoxy thickness1.6mm, Fulcrums distance 90mm,Bending width 5mm (0603、0805) , Bending width 4mm (1206) .Bending width 2mm (2010、2512)	$ \Delta R  \leq \pm 1\%$	IEC60115-1 4.33

### Packaging

#### 1. Paper Tape Dimensions

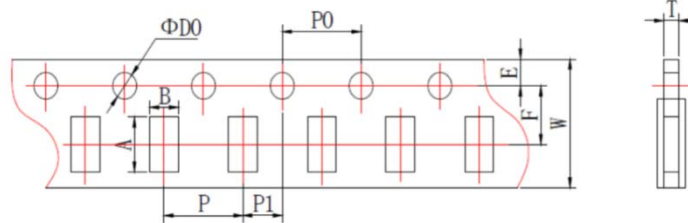

Type	A (mm)	B (mm)	W (mm)	F (mm)	E (mm)
0603	1.85±0.10	1.10±0.10	8.00±0.20	3.50±0.05	1.75±0.10
0805	2.40±0.10	1.60±0.10	8.00±0.20	3.50±0.05	1.75±0.10
1206	3.60±0.20	2.00±0.20	8.00±0.20	3.50±0.05	1.75±0.10
Type	P (mm)	P0 (mm)	P1 (mm)	D0 (mm)	T (mm)
0603	4.00±0.10	4.00±0.10	2.00±0.05	1.50±0.10	0.75±0.10
0805	4.00±0.10	4.00±0.10	2.00±0.05	1.50±0.10	0.95±0.10
1206	4.00±0.10	4.00±0.10	2.00±0.05	1.50±0.10	0.95±0.10

#### 2. Embossed Tape Dimensions

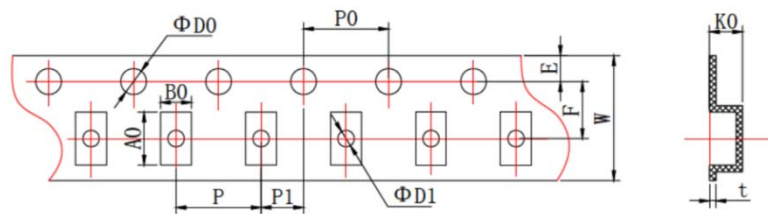

Type	A0 (mm)	B0 (mm)	W (mm)	F (mm)	E (mm)	T (mm)
2010	5.50±0.15	2.80±0.15	12.00±0.10	5.50±0.10	1.75±0.10	0.24±0.05
2512	6.75±0.15	3.45±0.15	12.00±0.10	5.50±0.10	1.75±0.10	0.25±0.05
Type	P (mm)	P0 (mm)	P1 (mm)	D0 (mm)	D1 (mm)	K0 (mm)
2010	4.00±0.10	4.00±0.10	2.00±0.05	1.50 <sup>+0.10</sup> <sub>0</sub>	1.50±0.10	0.85±0.05
2512	4.00±0.10	4.00±0.10	2.00±0.05	1.50 <sup>+0.10</sup> <sub>0</sub>	1.50±0.10	1.00±0.10

### 3.Reel Dimensions

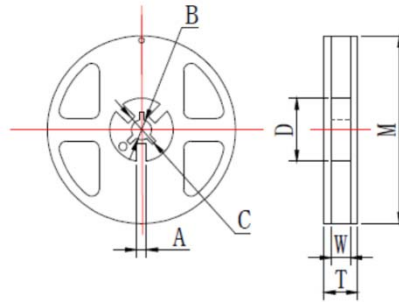

Type	M (mm)	W (mm)	T (mm)	A (mm)	B (mm)	C (mm)	D (mm)
0603 0805 1206	178.00±2.00	9.5±1.00	12.50±1.50	2.00±0.50	13.00±0.50	21.00±0.50	58.00±0.20
2010 2512	178.00±2.00	13.00±0.50	15.50±1.50	2.00±0.50	13.00±0.50	21.00±0.50	57.00±2.00

### 4. Quantity of Package

Type	0603	0805	1206	2010	2512
Quantity(PCS)	5000			4000	

### 5. Peeling Test

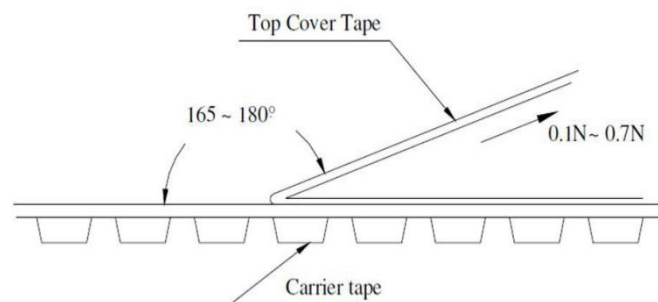

## Storage

- The ambient temperature shall between 5°C~30°C.
- The relative humidity recommended for storage is between 25%RH~60%RH.
- Sealed plastic bags with desiccant shall be used to reduce the oxidation of the termination and shall only be opened prior to use.
- The products shall not be stored in areas where harmful gases containing sulfur or chlorine are present.

## X-ON Electronics

Largest Supplier of Electrical and Electronic Components

*Click to view similar products for [Current Sense Resistors - SMD category](#):*

*Click to view products by [SART manufacturer](#):*

Other Similar products are found below :

[CRL0603-FW-R700ELF](#) [PFS35-200RF1](#) [NPS 2-T126 5.000 OHM 1%](#) [PFS35-0R01J1](#) [PFS35-0R05J1](#) [PFS35-5RF1](#) [CD2015FC-0.10-1%](#)  
[PR2512FKF7W0R004L](#) [RC1005F124CS](#) [RL73K3AR56JTDF](#) [RL7520WT-R001-F](#) [RL7520WT-R009-G](#) [RL7520WT-R020-F](#) [LRC-](#)  
[LR2512LF-01-R820J](#) [WR06X104JGLJ](#) [TL2BR01F](#) [65709-330](#) [SP1R12J](#) [RL7520WT-R039-G](#) [RL7520WT-R002-F](#) [LRF2010-R003JW](#)  
[KRL1632E-C-R200-F-T5](#) [KRL1632E-C-R200-F-T1](#) [Y14880R02000B9R](#) [RLP73M1ER051FTDF](#) [RLP73M2AR075FTDF](#)  
[SR731ERTTP5R10F](#) [SR731ERTTP100J](#) [SR731ERTTP6R80F](#) [SR731ERTTP4R70F](#) [SR731ERTTP2R20F](#) [SR731ERTTP3R90F](#)  
[SR731ERTTP1R00F](#) [SR731ERTTP10R0F](#) [SR731ERTTP2R00F](#) [SR731ERTTP8R20F](#) [SR731ERTTP3R9J](#) [SR731ERTTP8R2J](#)  
[SR731ERTTP2R0J](#) [SR731ERTTP4R7J](#) [SR731ERTTP9R1J](#) [SR731ERTTP1R0J](#) [SR731ERTTP2R2J](#) [SR731ERTTP5R1J](#) [SR731ERTTP6R8J](#)  
[SR731ERTTP9R10F](#) [RCWE2512R180FKEA](#) [FCSL64R007JER](#) [LRF1206-R018FW](#) [TLR2B10DR022FTDG](#)