

General

- Chip size from 1206 to 2512
- Resistance value from 1mΩ to 500mΩ
- Low thermal EMF
- Low inductance 0.5nH to 5nH
- Low TCR
- Lead free, RoHS compliant for global
- Applications and halogen free

Application

- Switching model power supply
- Battery pack
- Notebook, personal computer
- Test Instrument
- Power Amplifier

Electrical Specifications

Type	Power Rating at 70°C(W)	Resistance Range (mΩ)	TCR (ppm/°C)	Resistance tolerance	Operation Temp. Range
2512	2	1~500	±50	±0.5%(D) ±1%(F) ±5%(J)	-55°C~+170°C
	3	1~10			
1206	1	2~30		±0.5%(D) ±1%(F)	

Part Number information

SMR 25 M 2 F R010 I

【1】 【2】 【3】 【4】 【5】 【6】 【7】

【1】 Series Name: SART Metal Current Sensing Chip Resistors

【2】 Chip size: 12:1206 25:2512

【3】 Material Code: M:MnCu N:NiCu S:CuMnSn

【4】 Power Code: 1:1W 2:2W 3:3W

【5】 Resistance Tolerance: F:±1% D:±0.5% J:±5%

【6】 Resistance Code: R002=2mΩ、R010=10mΩ、2L50=2.5mΩ

【7】 Packaging Code: T: Tape & Reel、B: Bulk Pack

Dimensions

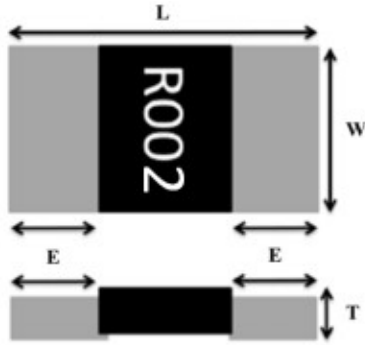

2512 (1~2mΩ)

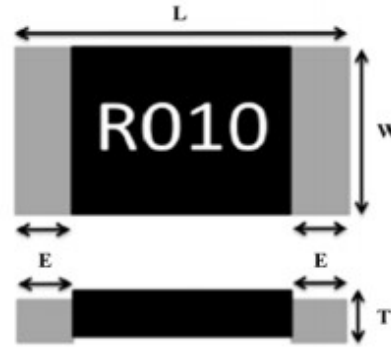

2512 (3~500mΩ)

Type	Resistance Range (mΩ)	L (mm)	W (mm)	T (mm)	E (mm)
2512	1~2	6.40±0.20	3.20±0.20	0.80±0.20	2.00±0.20
	3~500				0.90±0.20

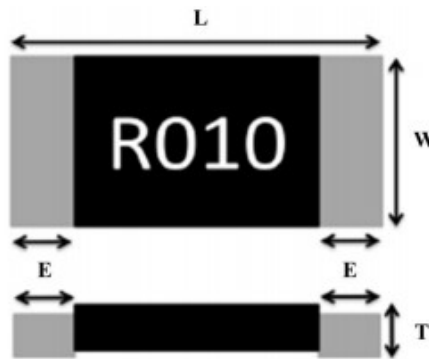

Type	Resistance Range (mΩ)	L (mm)	W (mm)	T (mm)	E (mm)
1206	2~30	3.20±0.20	1.60±0.20	0.70±0.20	0.5±0.30

Recommended Land Patterns

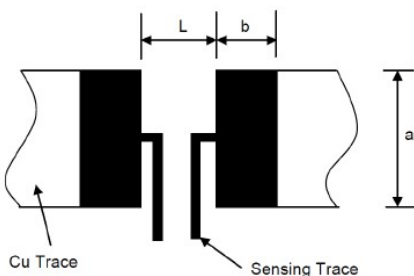

Type	Resistance Range (mΩ)	a (mm)	b (mm)	L (mm)
2512	1~2	4.00	3.10	1.80
	3~500	4.00	2.10	4.10
1206	2~30	1.80	1.70	1.60

Materials

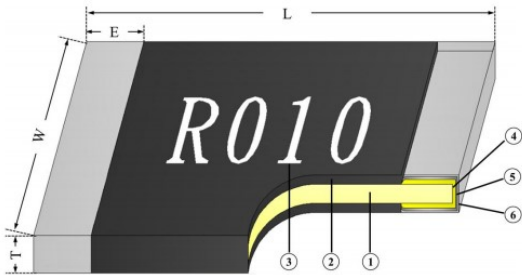

No.	Materials
1	Metal Alloy
2	Epoxy
3	Epoxy
4	Cu
5	Ni
6	Sn

Power Derating Curve

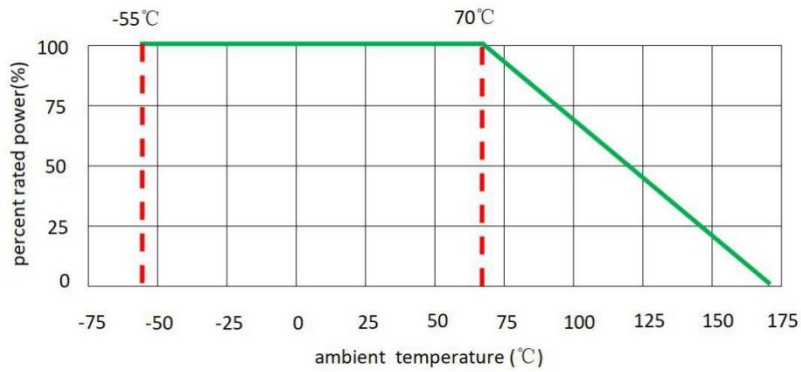

Recommended Solder Curve

1. Infrared Reflow

- Temperature: 260°C.
- Time: 10 sec Max.
- Recommend Reflow profile:

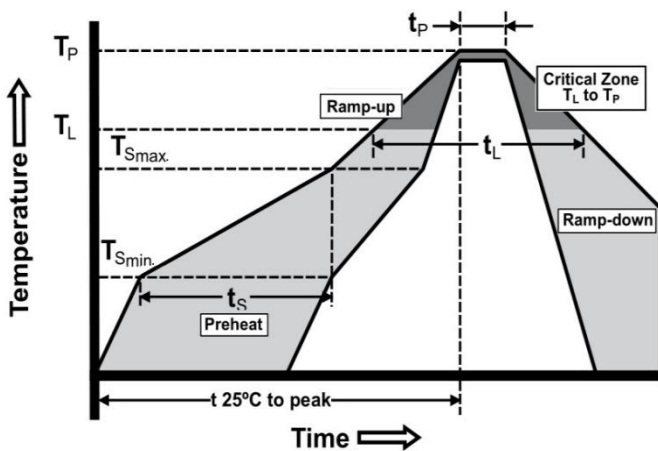

Profile Feature	Pb-Free Assembly
Average Ramp-up Rate (T _{Smax} to T _p)	3°C/sec Max.
Preheat Temperature Min.(T _{Smin}) Temperature Max.(T _{Smax}) Time(ts)(T _{Smin} to T _{Smax})	150°C 200°C 60sec~120sec
Peak Temperature(T _p)	260°C
Time (t _p) within 5°C of actual Peak Temperature(T _p)	10sec Max
Liquidous temperature (T _L)	217°C
Time at liquidous (T _L)	60sec~150sec
Ramp-down Rate	6°C/sec Max.
Time 25°C to peak Temperature	8 min Max.

2. Wave soldering

- Reservoir Temperature: 260°C
- Time in Reservoir: 10sec Max.

3. Hand Soldering

- Temperature: 350°C
- Time: 3sec Max.

Product Characteristics

Item	Test condition/ Methods	Performance	Standard
Resistance	Measuring resistance value at room temperature 25°C ±5°C	Refer to SART Spec	IEC60115-1 4.5
Temperature coefficient of resistance	$TCR = (R-R_0)/R_0(T_2-T_1) \times 10^{-6}$ T1 T2 Test temperature: +25°C~+125°C	Refer to SART Spec	MIL-STD-202 Method 304
Short time Overload	5 times the rated power for 5 sec	$ \Delta R \leq 1.0\%R$	IEC 60115-1 4.13
Resistance to Soldering Heat	260°C± 5°C, time: 10 sec±1 sec	$ \Delta R \leq 1.0\%R$	MIL-STD-202 Method 210
Thermal shock	-55°C(15min)/+125°C(15min), 300 cycles	$ \Delta R \leq 1.0\%R$	MIL-STD-202 Method107G
Low temperature storage	-55°C for 45 min, No power	$ \Delta R \leq 1.0\%R$	IEC60115-1 4.23.4
High Temperature storage	125°C for 1000 hours, No power	$ \Delta R \leq 1.0\%R$	MIL-STD-202 Method 108
Temperature Humidity Bias Test	+85°C, 85% RH, 10%bias, 1000hours	$ \Delta R \leq 1.0\%R$	MIL-STD-202 Method103
Mechanical shock	100 g's ,6 ms, 5pulses	$ \Delta R \leq 1.0\%R$	MIL-STD-202 Method 213
Vibration	The frequency varies from 10Hz to 2000Hz, 1 min, 3 directions, and 12 hours	$ \Delta R \leq 1.0\%R$	MIL-STD-202 Method 204
Load life	70°C± 2°C, 1000 hours, at rated power 1.5 hours "ON", 0.5 hours "OFF"	2512 3W: $ \Delta R \leq 2\%R$	MIL-STD-202 Method 108
		Other: $ \Delta R \leq 1.0\%R$	
Solderability	Dip the terminal in a flux and then dip into a soldering bath at 245°C±5°C for 2sec~3sec	Min 95% coverage	J-STD-002B Test B
Board Flex	Min 2 mm deflection,60sec	$ \Delta R \leq 1.0\%R$	AEC-Q200-005
ESD test	Other: 2KV, 2 times /1sec	$ \Delta R \leq 1.0\%R$	AEC-Q200-002

Packaging

1. Embossed Tape Dimensions

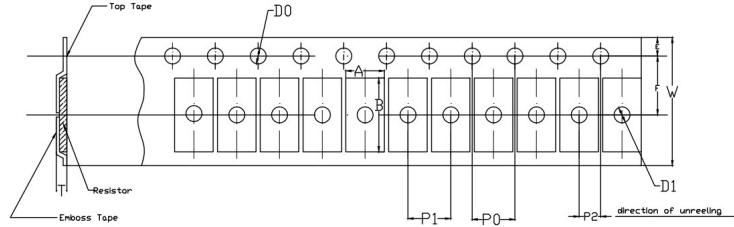

Type	A (mm)	B (mm)	W (mm)	F (mm)	E (mm)
2512	$3.60 \pm_{0.18}^{0.20}$	6.90 ± 0.20	12.00 ± 0.20	5.50 ± 0.05	1.75 ± 0.10
Type	P1 (mm)	P2 (mm)	P0 (mm)	D0/D1 (mm)	T (mm)
2512	4.00 ± 0.10	2.00 ± 0.05	4.00 ± 0.05	$1.50 \pm_0^{0.10}$	1.00 ± 0.15

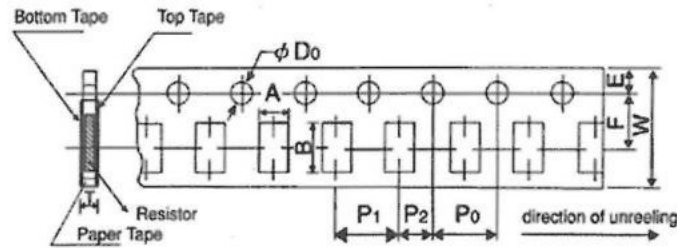

Type	A (mm)	B (mm)	W (mm)	F (mm)	E (mm)
1206	2.00 ± 0.15	3.60 ± 0.20	8.00 ± 0.20	3.50 ± 0.05	1.75 ± 0.10
Type	P1 (mm)	P2 (mm)	P0 (mm)	D0 (mm)	T (mm)
1206	4.00 ± 0.10	2.00 ± 0.05	4.00 ± 0.10	$1.50 \pm_0^{0.10}$	0.84 ± 0.10

2. Reel Dimensions

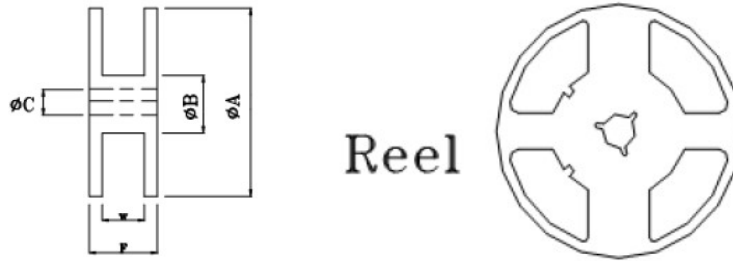

Type	ϕA (mm)	ϕB (mm)	ϕC (mm)	F (mm)	W (mm)
2512	178.00±2.00	60.00±1.00	13.50±0.50	15.40±1.00	13.00±0.30
1206	178.00±2.00	60.00±1.00	13.50±0.50	11.40±0.10	9.00±0.30

3. Quantity of Package

Type	Quantity(pcs)
2512	4000
1206	5000

4. Peeling Test

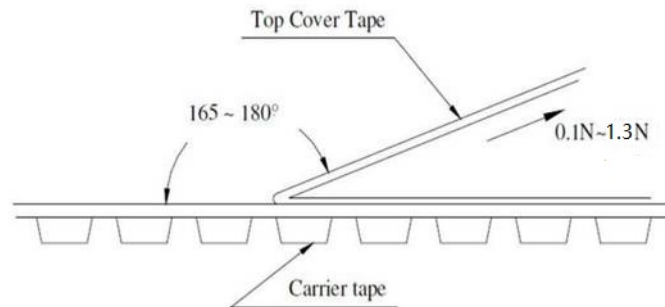

Storage

- The ambient temperature shall be between 5°C~35°C.
- The relative humidity recommended for storage is between 25%RH~75%RH.
- Sealed plastic bags with desiccant shall be used to reduce the oxidation of the termination and shall only be opened prior to use.
- The products shall not be stored in areas where harmful gases containing sulfur or chlorine are present.

X-ON Electronics

Largest Supplier of Electrical and Electronic Components

Click to view similar products for [Thick Film Resistors - SMD category](#):

Click to view products by [SART manufacturer](#):

Other Similar products are found below :

[CR-05FL7--150R](#) [CR-05FL7--698K](#) [CR-12JP4--680R](#) [CRCW04021K20FKEE](#) [CRCW04028R20JNEE](#) [CRCW06032K10FKEC](#)
[CRCW06036K80FKEE](#) [M55342K03B499DRS6](#) [M55342K06B6E19RWL](#) [M55342K09B5D62RS6](#) [M55342M06B26E7RS3](#) [742C083750JTR](#)
[MCR01MZPF1202](#) [MCR01MZPF1601](#) [MCR01MZPF1800](#) [MCR01MZPF6201](#) [MCR01MZPF9102](#) [MCR01MZPJ121](#) [MCR01MZPJ125](#)
[MCR01MZPJ751](#) [MCR03EZHJ103](#) [MCR03EZPF2004](#) [MCR03EZPJ270](#) [MCR03EZPJ821](#) [MCR10EZPF1102](#) [MCR10EZPF2700](#)
[MCR18EZPJ330](#) [RC1005F1152CS](#) [RC1005F1372CS](#) [RC1005F1912CS](#) [RC1005F2052CS](#) [RC1005F3011CS](#) [RC1005F471CS](#)
[RC1005F4751CS](#) [RC1005F5621CS](#) [RC1005F6041CS](#) [RC1005J121CS](#) [RC1005J122CS](#) [RC1005J154CS](#) [RC1005J180CS](#) [RC1005J181CS](#)
[RC1005J202CS](#) [RC1005J391CS](#) [RC1005J560CS](#) [RC1005J683CS](#) [RC1005J823CS](#) [RC1608F1022CS](#) [RC1608F333CS](#) [RC1608F3651CS](#)
[RC1608F5110CS](#)