

The image features a collection of SCAME electrical components against a red background. At the top, there are three red plastic components, likely covers or housings, with the SCAME logo visible. Below them, a white plastic component is shown with its lid open, revealing a multi-pin connector. In the bottom left, a white multi-pin connector is shown in detail. On the right, a larger white plastic component is shown with its lid closed. This component has technical specifications printed on it: "3P+T-IP67-63A-6N/380-415V~", "504.6385", "CE", and "MADE IN ITALY".

# SYSTEM GENERAL CATALOGUE

 **SCAME**  
electrical solutions

2016-2018







**GENERAL  
CATALOGUE  
2016-2018**  
[www.scame.com](http://www.scame.com)

INDEX

---

CONSULTATION CRITERIA

---

THE COMPANY

---

**PRODUCTS CATALOGUE**

---

TECHNICAL SHEETS

---

INDEX BY PRODUCT NUMBER

---

DEFINITION OF SYMBOLS

---

THE SCAME PRODUCT RANGE







---

<b>INDUSTRY</b>	<b>1</b>	PAG. 18	<b>1.1</b> Plugs and inlets for industrial applications	PAG. 20
			<b>1.2</b> Connectors and sockets for industrial applications	PAG. 44
			<b>1.3</b> Switched interlocked sockets outlets	PAG. 96
			<b>1.4</b> Plugs and sockets for special applications	PAG. 148
			<b>1.5</b> Switchgears	PAG. 218
			<b>1.6</b> Empty enclosures	PAG. 274
			<b>1.7</b> Light-fittings	PAG. 362
<b>ASSEMBLIES</b>	<b>2</b>	PAG. 372	<b>2.1</b> Distribution assemblies	PAG. 374
			<b>2.2</b> Industrial adaptors	PAG. 424
			<b>2.3</b> Industrial cable reels	PAG. 440
<b>ACCESSORIES</b>	<b>3</b>	PAG. 460	<b>3.1</b> Installation accessories	PAG. 462
			<b>3.2</b> Connecting accessories	PAG. 484
			<b>3.3</b> Conduit	PAG. 498
			<b>3.4</b> Trunking systems	PAG. 508
<b>DOMESTIC</b>	<b>4</b>	PAG. 536	<b>4.1</b> Plugs and sockets	PAG. 538
			<b>4.2</b> Adaptors	PAG. 544
			<b>4.3</b> Multi sockets	PAG. 554
			<b>4.4</b> Cable reels	PAG. 572
			<b>4.5</b> Lampholders and switches	PAG. 578
			<b>4.6</b> TV/SAT - TEL - DATA	PAG. 590
			<b>4.7</b> Wiring accessories	PAG. 604











# Industry



## Plugs and inlets for industrial applications





	<b>Plugs - IP44/IP54</b>	PAG. 22
	<b>Plugs - IP66/IP67/IP69</b>	PAG. 28
	<b>Flush mounting appliance inlets - IP44/IP54</b>	PAG. 34
	<b>Flush mounting appliance inlets - IP66/IP67/IP69</b>	PAG. 37
	<b>Surface mounting appliance inlets - IP44/IP54</b>	PAG. 41
	<b>Surface mounting appliance inlets - IP66/IP67/IP69</b>	PAG. 42
	<b>Accessories for plugs</b>	PAG. 43

## Connectors and sockets for industrial applications

	<b>Connectors - IP44/IP54</b>	PAG. 46
	<b>Connectors - IP66/IP67/IP69</b>	PAG. 52
	<b>Flush mounting socket outlets - IP44/IP54</b>	PAG. 59
	<b>Flush mounting socket outlets - IP66/IP67/IP69</b>	PAG. 65
	<b>Surface mounting socket outlets - IP44/IP54</b>	PAG. 72
	<b>Surface mounting socket outlets - IP66/IP67/IP69</b>	PAG. 80
	<b>Surface mounting switched socket outlets without interlock - IP44/IP54</b>	PAG. 86
	<b>Surface mounting switched socket outlets without interlock - IP66/IP67/IP69</b>	PAG. 89
	<b>Domestic standard socket for industrial applications - IP54</b>	PAG. 90
	<b>BS socket for industrial applications - IP66</b>	PAG. 93
	<b>Accessories for sockets</b>	PAG. 94

## Switched interlocked sockets outlets



	<b>OMNIA Series</b> Interlocked-switch socket outlets for industrial applications	PAG. 98
	<b>OMNIPLUS Series</b> Domestic interlocked socket	PAG. 108
	<b>OMNIA System</b> Flush and surface mounting modular system	PAG. 110

	<b>ADVANCE2 Series</b> Interlocked-switch socket outlets for industrial applications	PAG. 118
	<b>ADVANCE2 System</b> Modular system for combination units - IP66	PAG. 128
	<b>ADVANCE-GRP Series</b> Interlocked-switch socket outlets for industrial applications	PAG. 133
	<b>ADVANCE-GRP System</b> Modular system - IP66	PAG. 143









## Plugs and sockets for special applications

	<b>AMR System - Automated Meter Reading</b>	PAG. 150
	<b>Plugs and sockets for industrial applications &lt;50V~</b>	PAG. 156
	<b>Events and exhibitions products</b>	PAG. 162
	<b>Industrial plugs and sockets for military use</b>	PAG. 178
	<b>Plugs and sockets UL/CSA</b>	PAG. 184
	<b>Seven poles plugs and sockets</b>	PAG. 200
	<b>OPTIMA-METAL Series - Industrial connectors</b>	PAG. 202

## Switchgears

	<b>COMMAND Series</b> Low-voltage rotary switchgear and controlgear	PAG. 220
	<b>ISOLATORS Series</b> Switch-disconnectors IP65	PAG. 237
	<b>TOP22 Series</b> Control and signalling accessories	PAG. 265

## Empty enclosures

	<b>DOMINO IP66 Series</b> Consumer units and enclosures	PAG. 276
	<b>DOMINO IP40 Series</b> Consumer units	PAG. 289
	<b>DOMINO System</b> Distribution assemblies - IP66	PAG. 292
	<b>FLAT Series</b> Enclosures	PAG. 306
	<b>BLOCK Series</b> Distribution assemblies - IP66	PAG. 308
	<b>ENERBOX Series</b> Distribution assemblies - IP55	PAG. 315
	<b>ADAPTO Series</b> Adaptors for industrial applications	PAG. 317
	<b>MBOX Series</b> Distribution assemblies for construction site	PAG. 320
	<b>EASYBOX Series</b> Weather-proof enclosures - IP65	PAG. 329



**KIOSK Series**  
Distribution pedestals terminals for campsites, public areas and marinas

PAG. 337



**GOMMA Series**  
Rubber distribution assemblies

PAG. 341



**EMERGENCY Series**  
Emergency switchboards

PAG. 345



**SCABOX Series**  
Surface mounting junction boxes - Metal screws

PAG. 347



**CUBIK Series**  
Surface mounting junction boxes - ¼ turn plastic screw cover

PAG. 351



**CUBOX Series**  
Surface mounting junction boxes - ¼ turn plastic screw cover

PAG. 354



**BEEBOX Series**  
Enclosures

PAG. 355



**WBOX Series**  
Flush mounting boxes

PAG. 356



**ALUBOX Series**  
Aluminium junction boxes

PAG. 360

## Light-fittings



**MIZAR Series**  
Light-fittings for fixed installations - 60W

PAG. 364



**HYDRA Series**  
Light-fittings for fixed installations - 100W

PAG. 368



**HALE Series**  
Portable lighting - 60W

PAG. 370

## Assemblies

### Distribution assemblies



**MBOX Series**  
Distribution assemblies for construction site

PAG. 376



**MEGA Series**  
Distribution assemblies for construction site

PAG. 382



**DOMINO Series**  
Distribution assemblies

PAG. 384



**BLOCK Series**  
Distribution assemblies

PAG. 388



**KIOSK Series**  
Distribution pedestals terminals for campsites, public areas and marinas

PAG. 403



**GOMMA Series**  
Rubber distribution assemblies

PAG. 408



**LV-LUX Series**  
Distribution assemblies

PAG. 410



**TRANSFORMER Series**  
ACS IP55 portable unit with safety and isolating transformer

PAG. 411



**MOBIL Series**  
ACS IP55 distribution boxes with foldable stand

PAG. 414



**SALVAMOTORE Series**  
Stop-start units and motor cut-out - IP55

PAG. 415



**Accessories and spare parts**

PAG. 417

## Industrial adaptors



**ADAPTO Series**  
Adaptors for industrial applications

PAG. 426

## Industrial cable reels



**AUTOROLLER Series**  
Cable reels with automatic rewind

PAG. 442



**ROLLER 330 Series**  
Cable reels for industrial, commercial and domestic applications

PAG. 446



**ROLLER-BLOCK 330 Series**  
Cable reels

PAG. 450



**ROLLER 450 Series**  
Cable reels for industrial applications

PAG. 452



**ROLLER-BLOCK 450 Series**  
Cable reels for industrial applications

PAG. 454



**ROLLER Series**  
Spare parts

PAG. 456

## Accessories

### Installation accessories



**UNION Series**  
Installation accessories

PAG. 464



**TIES Series**  
Cable ties

PAG. 470



**FIXO Series**  
Fastening accessories

PAG. 475



**CABLO Series**  
INSTALLATION Accessories

PAG. 477



**FASTY Series**  
Cable clips and insulated pins

PAG. 479



**RAILDIN Series**  
Metallic DIN rails

PAG. 481

### Connecting accessories



**CONNECTO Series**  
Insulated wire connectors - T85

PAG. 486



**CONNECTO Series**  
Terminal strips

PAG. 493



**CONNECTO Series**  
DOMINO terminal blocks - T85

PAG. 495

### Conduit



**FIXER Series**  
Conduit FIXING accessories

PAG. 500



**TUBE Series**  
COUPLING Accessories





PAG. 503



**SMART Series**  
IP66/67





PAG. 507

## Trunking systems

	<b>WADO Series - Mini-trunking</b>	PAG. 510
	<b>WADO Series - Skirting trunking</b>	PAG. 517
	<b>WADO Series - Cable and set housing trunking</b>	PAG. 525
	<b>WADO Series - Slotted cable trunking</b>	PAG. 530
	<b>WADO Series - Trunking for air conditioning systems</b>	PAG. 531

## Domestic





### Plugs and sockets

	<b>AZZURRA Series</b> Plugs and trailing sockets	PAG. 540
	<b>BLUELINE Series</b> Plugs and trailing sockets	PAG. 541
	<b>QUICK Series</b> Plugs and trailing sockets	PAG. 542
	<b>UNEL Series</b> Plugs and sockets with side earth contact	PAG. 543



### Adaptors

	<b>AZZURRA Series</b> Adaptors	PAG. 546
	<b>BLUELINE Series</b> Adaptors	PAG. 548

### Multi sockets

	<b>TREND Series</b> Multi sockets	PAG. 556
	<b>BLUELINE Series</b> Multi sockets	PAG. 560
	<b>SICURA Series</b> Multi sockets	PAG. 567
	<b>Serie SPYROS</b> Extension cords for domestic applications	PAG. 571

### Cable reels

	<b>TRIS (ENERGY) Series</b> Cable reels - Low voltage versions with thermal switch	PAG. 574
	<b>TRIS Series (TV)</b> Cable reels - TV versions	PAG. 576
	<b>TRIS (TEL) Series</b> Cable reels - Telephone versions	PAG. 577

### Lampholders and switches

	<b>LUX [Lampholders] Series</b> Lampholders	PAG. 580
---	--	----------

	<b>LUX [switches] Series</b> Single pole switches	PAG. 587
---	--	----------

	<b>LUX [ceiling] Series</b> Ceiling accessories	PAG. 589
---	--	----------

### TV/SAT - TEL - DATA

	<b>DATATEL-TEL Series</b> Components for telephone installations	PAG. 592
---	---	----------

	<b>DATATEL-DATA Series</b> Component for structured cabling	PAG. 596
---	--	----------

	<b>DATATEL-TV/SAT Series</b> Plugs, sockets and accessories for tv installations	PAG. 599
---	---	----------

### Wiring accessories

	<b>PROTECTA Series</b> IP66 weatherproof switches & sockets	PAG. 606
---	--	----------

	<b>UNIBOX Series [+EVOLUTION]</b> Enclosures for wiring accessories	PAG. 618
---	--	----------

	<b>EVOLUTION Series</b> Plates and devices	PAG. 626
--	---	----------

# Consultation criteria

**1** Next to the item code, the quantity of pieces in each product package/packing unit is shown.

**2** The assembled panels illustrated in this paper catalogue are only part of a wider range of available products; other combinations can be found on the Company website ([www.scame.com](http://www.scame.com)) by means of the the dedicated app “CombiFINDER”. In case of specific needs, you can contact our Technical Information Centre (CIT) directly.

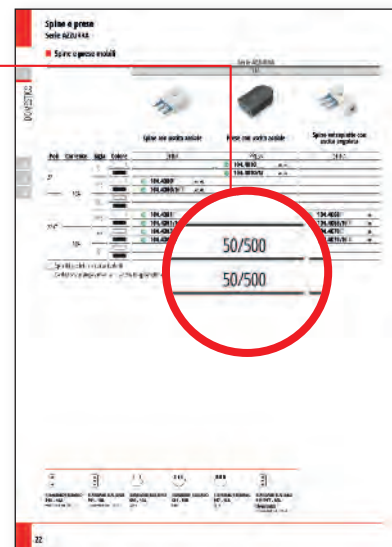

**3** The second part of the catalogue contains, in alphabetical order by “Series” name, the TECHNICAL DATA SHEETS of the products illustrated in the catalogue.

**4** This “SYSTEMS” catalogue should be completed with the “ECOMOBILITY”, “WIRING ACCESSORIES” and “ATEX” catalogues.





# Scame: a tradition of innovation

IN FIFTY YEARS WE HAVE  
WRITTEN A STORY OF  
INNOVATION THAT HAS  
ALWAYS PRESERVED THE  
SPIRIT OF ITS ORIGINS.

Scame was founded amidst the enthusiasm of the Italian economic boom of the 60's and has always pursued its strive for excellence by continuous innovation. Today it is an international industrial group of about 800 people employed in 20 subsidiary and associated companies operating under the parent company headquartered in Parre (Bergamo) in Alta Valle Seriana. Scame has a capillary presence throughout Italy with its own sales agencies and operates worldwide with branches and loyal distributors.





**Italy**  
Parre (Bergamo)

 **SCAME**<sub>ARGENTINA</sub>  
Argentina

 **SCAME**<sub>BULGARIA</sub>  
Bulgaria

 **SCAME**<sub>BRASIL</sub>  
Brazil

 **SCAME**<sub>CHILE</sub>  
Chile

 **SCAME-TOP**  
China

 **SCAME-HR**  
Croatia

 **SCAME-CZ**  
Czech Republic

**SOBEM**  **SCAME**  
France

 **SCAME**<sub>INDIA</sub>  
India



 **SCAME**<sub>POLSKA</sub>  
Poland

 **SCAME**<sub>PORTUGAL</sub>  
Portugal

 **SCAME-RO**  
Romania

 **SCAME-SK**  
Slovakia

 **SCAME**<sub>IBERICA</sub>  
Spain

 **SCAME**<sub>MIDDLE EAST</sub>  
U.A.E.

 **SCAME-UK**  
United Kingdom

 **SCAME-UY**  
Uruguay

 **SCAME-UA**  
Ukraine

## The catalogue and the internet site

AN INDUSTRIAL SYSTEMS CATALOGUE DIVIDED INTO 4 SECTIONS WITH OVER 10,000 ITEMS. MONOTHEMATIC CATALOGUES DEDICATED TO EX PRODUCTS, ELECTRIC VEHICLES RECHARGING SOLUTIONS AND WIRING ACCESSORIES. AN INTERNET SITE WITH VALUABLE INFORMATION AND UPDATES ON PRODUCT DEVELOPMENTS.

Red and white are our company colours and also the colours chosen for this catalogue: the simple elegance of white combined with vivid red, symbol of a dynamic and successful life. [www.scame.com](http://www.scame.com): a portal with the primary information, names and addresses of the entire distribution network, the products and their characteristics. Its internal search engines allow simple and flexible consultation of the information, providing real-time solutions to the many questions that arise during the distribution and use of electricity.



THE CONCEPT OF QUALITY  
IS AN INTEGRAL PART OF  
OUR CULTURE IN ALL ASPECTS  
AND EVERY ACTIVITY OF  
OUR WORK.



In 1993 Scame was among the first Italian companies to obtain the certification of its quality management system according to UNI EN ISO 9001 standards, renewed in 2002 according to Vision 2000. In 2003 Scame also obtained certification of its environmental management system according to UNI EN ISO 14001 standards which, by activating measures for improvement, continuous controls and appropriate corrective actions, fuels a virtuous circle of constant eco-friendly improvement.

In recognition of the health and safety of its work environment, in 2013 SCAME has been prized with BS OHSAS 18001 certification.



## Technical and sales service

SEND AN E-MAIL TO  
[infotech@scame.com](mailto:infotech@scame.com) AND  
YOU'LL RECEIVE THE  
ANSWERS TO ALL  
YOUR QUESTIONS ABOUT  
TECHNICAL ASPECTS,  
INSTALLATION PROCEDURES  
AND CONFORMITY WITH  
THE STANDARDS .

---

Scame technical information centre is able to promptly provide clear and complete answers to all your questions regarding the Scame products. The leading distributors of electrical material, with the support of our sales agencies and technical promoters, represent an additional capillary reference network. Information and updates can be found in the Info-point section of the internet site and in the newsletter sent periodically to the registered users.



[infotech@scame.com](mailto:infotech@scame.com)

1

# INDUSTRY

Systems and components for  
electrical installations

1.1	Plugs and inlets for industrial applications	PAG. 20
1.2	Connectors and sockets for industrial applications	PAG. 44
1.3	Switched interlocked sockets outlets	PAG. 96
1.4	Plugs and sockets for special applications	PAG. 148
1.5	Switchgears	PAG. 218
1.6	Empty enclosures	PAG. 274
1.7	Light-fittings	PAG. 362

1.1

## Plugs and inlets for industrial applications

- Plugs - IP44/IP54
- Plugs - IP66/IP67/IP69
- Flush mounting appliance inlets - IP44/IP54
- Flush mounting appliance inlets - IP66/IP67/IP69
- Surface mounting appliance inlets - IP44/IP54
- Surface mounting appliance inlets - IP66/IP67/IP69
- Accessories for plugs







# Plugs and inlets for industrial applications

## Plugs - IP44/IP54

### OPTIMA Series >> Plugs

OPTIMA Series

213.



 Screw terminals

PLUG

IP44/IP54

CABLE GLAND

Poles	Hz	Volt	Colour	h	16A		32A			
					Part No.	10/50	Part No.	10/40		
2P+E	50Hz 60Hz	100-130V	Yellow	4h	<b>213.1630</b>	10/50	<b>213.3230</b>	10/40		
		200-250V	Blue	6h	<b>213.1633</b>	10/50	<b>213.3233</b>	10/40		
		380-415V	Red	9h	<b>213.1638</b>	10/50	<b>213.3238</b>	10/40		
		480-500V	Black	7h	<b>213.16336</b>	10/50	<b>213.32336</b>	10/40		
		TST>50V	Grey	12h	<b>213.16333</b>	10/50	<b>213.32333</b>	10/40		
	>300-500Hz	>50V	Green	2h	<b>213.16332</b>	10/50	<b>213.32332</b>	10/40		
		DC	>50-250V	Grey	3h	<b>213.16334</b>	10/50	<b>213.32334</b>	10/40	
			>250V	Grey	8h	<b>213.16338</b>	10/50	<b>213.32338</b>	10/40	
		3P+E	50Hz 60Hz	100-130V	Yellow	4h	<b>213.1631</b>	10/50	<b>213.3231</b>	10/40
				200-250V	Blue	9h	<b>213.1634</b>	10/50	<b>213.3234</b>	10/40
380-415V	Red			6h	<b>213.1636</b>	10/50	<b>213.3236</b>	10/40		
380V 50Hz / 440V 60Hz	Black			3h	<b>213.16364</b>	10/50	<b>213.32364</b>	10/40		
480-500V	Black			7h	<b>213.16366</b>	10/50	<b>213.32366</b>	10/40		
>300-500Hz	600-690V		Black	5h	<b>213.16367</b>	10/50	<b>213.32367</b>	10/40		
	60Hz		440-460V	Red	11h	<b>213.16365</b>	10/50	<b>213.32365</b>	10/40	
	100-300Hz		>50V	Green	10h	<b>213.16361</b>	10/50	<b>213.32361</b>	10/40	
	>300-500Hz		>50V	Green	2h	<b>213.16362</b>	10/50	<b>213.32362</b>	10/40	
	3P+N+E		50Hz 60Hz	100-130V	Yellow	4h	<b>213.1632</b>	10/50	<b>213.3232</b>	10/40
208-250V		Blue		9h	<b>213.1635</b>	10/50	<b>213.3235</b>	10/40		
346-415V		Red		6h	<b>213.1637</b>	10/50	<b>213.3237</b>	10/40		
380V 50Hz / 440V 60Hz		Black		3h	<b>213.16374</b>	10/50	<b>213.32374</b>	10/40		
480-500V		Black		7h	<b>213.16376</b>	10/50	<b>213.32376</b>	10/40		
>300-500Hz		600-690V	Black	5h	<b>213.16377</b>	10/50	<b>213.32377</b>	10/40		
		60Hz	440-460V	Red	11h	<b>213.16375</b>	10/50	<b>213.32375</b>	10/40	
		>300-500Hz	>50V	Green	2h	<b>213.16372</b>	10/50	<b>213.32372</b>	10/40	



**Terminals**  
Screw terminals



**Terminals**  
Spring terminals (FAST WIRING)



**Terminals**  
Perforating terminals (FAST WIRING)

# Plugs and inlets for industrial applications

## Plugs - IP44/IP54



### ■ OPTIMA Series >> Plugs

#### OPTIMA Series

213.



Perforating terminals

PLUG

IP44/IP54

CABLE GLAND

16A

Poles	Hz	Volt	Colour	h		
2P+E	50Hz 60Hz	100-130V		4h	<b>213.1630P</b>	10/50
		200-250V		6h	<b>213.1633P</b>	10/50
		380-415V		9h	<b>213.1638P</b>	10/50
3P+E		200-250V			<b>213.1634P</b>	10/50
		380-415V			<b>213.1636P</b>	10/50
3P+N+E		346-415V			<b>213.1637P</b>	10/50

#### OPTIMA Series

213.



Spring terminals

PLUG

IP44/IP54

CABLE GLAND

32A

Poles	Hz	Volt	Colour	h		
2P+E	50Hz 60Hz	100-130V		4h	<b>213.3230F</b>	10/40
		200-250V		6h	<b>213.3233F</b>	10/40
		380-415V		9h	<b>213.3238F</b>	10/40
3P+E		200-250V			<b>213.3234F</b>	10/40
		380-415V			<b>213.3236F</b>	10/40
3P+N+E		346-415V			<b>213.3237F</b>	10/40

1.1



# Plugs and inlets for industrial applications

## Plugs - IP44/IP54

### ■ OPTIMA Series >> Plugs

#### OPTIMA Series

213.



























#### Mantle terminals

PLUG

IP44/IP54

CABLE GLAND

63A

Poles	Hz	Volt	Colour	h			
2P+E	50Hz 60Hz	100-130V		4h	<b>213.6330</b>	6/24	
		200-250V		6h	<b>213.6333</b>	6/24	
		380-415V		9h	<b>213.6338</b>	6/24	
		480-500V		7h	<b>213.63336</b>	6/24	
		TST>50V		12h	<b>213.63333</b>	6/24	
	>300-500Hz	>50V		2h	<b>213.63332</b>	6/24	
	DC	>50-250V		3h	<b>213.63334</b>	6/24	
		>250V		8h	<b>213.63338</b>	6/24	
	3P+E	50Hz 60Hz	100-130V		4h	<b>213.6331</b>	6/24
			200-250V		9h	<b>213.6334</b>	6/24
380-415V				6h	<b>213.6336</b>	6/24	
380V 50Hz / 440V 60Hz				3h	<b>213.63364</b>	6/24	
480-500V				7h	<b>213.63366</b>	6/24	
600-690V			5h	<b>213.63367</b>	6/24		
60Hz		440-460V		11h	<b>213.63365</b>	6/24	
100-300Hz		>50V		10h	<b>213.63361</b>	6/24	
>300-500Hz		>50V		2h	<b>213.63362</b>	6/24	
3P+N+E		50Hz 60Hz	100-130V		4h	<b>213.6332</b>	6/24
	208-250V			9h	<b>213.6335</b>	6/24	
	346-415V			6h	<b>213.6337</b>	6/24	
	380V 50Hz / 440V 60Hz			3h	<b>213.63374</b>	6/24	
	480-500V			7h	<b>213.63376</b>	6/24	
	600-690V		5h	<b>213.63377</b>	6/24		
	60Hz	440-460V		11h	<b>213.63375</b>	6/24	
	>300-500Hz	>50V		2h	<b>213.63372</b>	6/24	



**Terminals**  
Mantle terminals (EASY-PLUG)



**Terminals**  
Perforating terminals (FAST WIRING)



**Terminals**  
Screw terminals

# Plugs and inlets for industrial applications

## Plugs - IP44/IP54



### ■ OPTIMA Series >> Plugs [Transparent version]

OPTIMA Series

213.



Screw terminals



Perforating terminals

					PLUG			
					IP44/IP54			
					CABLE GLAND			
					16A			
Poles	Hz	Volt	Colour	h	Screw terminals		Perforating terminals	
2P+E	50Hz 60Hz	100-130V	Yellow	4h	<b>213.1630.TR</b>	10/50	<b>213.1630P.TR</b>	10/50
		200-250V	Blue	4h	<b>213.1633.TR</b>	10/50	<b>213.1633P.TR</b>	10/50
3P+E	50Hz 60Hz	380-415V	Red	6h			<b>213.1636P.TR</b>	10/50
3P+N+E		346-415V					<b>213.1637P.TR</b>	10/50

- Transparent grip



**CONVENTIONAL WIRING**  
Screw terminals



**FAST WIRING**  
Insulation perforating terminals

1.1



# Plugs and inlets for industrial applications

## Plugs - IP44/IP54

### ■ OPTIMA-REVERSE Series >> Plugs with phase inverter

OPTIMA-REVERSE Series

213.



 Screw terminals

PLUG

IP44/IP54

CABLE GLAND

Poles	Hz	Volt	Colour	h	16A		32A	
					Part No.	Code	Part No.	Code
3P+E	50Hz 60Hz	380-415V	■	6h	<b>213.1636RV</b>	10/50	<b>213.3236RV</b>	10/40
3P+N+E		346-415V			<b>213.1637RV</b>	10/50	<b>213.3237RV</b>	10/40

- Phase inverter



#### OPTIMA-REVERSE Series

Operating principle of the phase inverter



**Terminals**  
Screw terminals

# Plugs and inlets for industrial applications

## Plugs - IP44/IP54



### EUREKA Series >> Plugs

#### EUREKA Series

221.



Screw terminals  
[Angled outlet]

PLUG

IP44

CABLE SLEEVE

Poles	Hz	Volt	Colour	h	16A		32A	
					Part No.	Length	Part No.	Length
2P+E	50Hz 60Hz	100-130V		4h	<b>221.1630</b>	10/100	<b>221.3230</b>	10/60
		200-250V			<b>221.1633</b>	10/100	<b>221.3233</b>	10/60
3P+E		380-415V		6h	<b>221.1636</b>	10/100	<b>221.3236</b>	10/60
3P+N+E		346-415V			<b>221.1637</b>	10/100	<b>221.3237</b>	10/50

### XENIA Series >> Plugs

#### XENIA Series

214.



Screw terminals

PLUG

IP44

CABLE GLAND

Poles	Hz	Volt	Colour	h	16A		32A	
					Part No.	Length	Part No.	Length
2P+E	50Hz 60Hz	100-130V		4h	<b>214.1630</b>	50	<b>214.3230</b>	25
		200-250V			<b>214.1633</b>	50	<b>214.3233</b>	25
3P+E		380-415V		6h	<b>214.1636</b>	40	<b>214.3236</b>	25
3P+N+E		346-415V			<b>214.1637</b>	30	<b>214.3237</b>	20

1.1



# Plugs and inlets for industrial applications

## Plugs - IP66/IP67/IP69

### OPTIMA Series >> Plugs

OPTIMA Series

218.

















 Screw terminals

PLUG

IP66/IP67/IP69

CABLE GLAND

Poles	Hz	Volt	Colour	h	16A		32A		
					Part No.	10/40	Part No.	10/40	
2P+E	50Hz 60Hz	100-130V		4h	<b>218.1630</b>	10/40	<b>218.3230</b>	10/40	
		200-250V		6h	<b>218.1633</b>	10/40	<b>218.3233</b>	10/40	
		380-415V		9h	<b>218.1638</b>	10/40	<b>218.3238</b>	10/40	
		480-500V		7h	<b>218.16336</b>	10/40	<b>218.32336</b>	10/40	
		TST>50V		12h	<b>218.16333</b>	10/40	<b>218.32333</b>	10/40	
	>300-500Hz	>50V		2h	<b>218.16332</b>	10/40	<b>218.32332</b>	10/40	
		>50-250V		3h	<b>218.16334</b>	10/40	<b>218.32334</b>	10/40	
	DC	>250V		8h	<b>218.16338</b>	10/40	<b>218.32338</b>	10/40	
		100-130V		4h	<b>218.1631</b>	10/40	<b>218.3231</b>	10/40	
	3P+E	50Hz 60Hz	200-250V		9h	<b>218.1634</b>	10/40	<b>218.3234</b>	10/40
380-415V				6h	<b>218.1636</b>	10/40	<b>218.3236</b>	10/40	
380V 50Hz / 440V 60Hz				3h	<b>218.16364</b>	10/40	<b>218.32364</b>	10/40	
480-500V				7h	<b>218.16366</b>	10/40	<b>218.32366</b>	10/40	
600-690V				5h	<b>218.16367</b>	10/40	<b>218.32367</b>	10/40	
60Hz		440-460V		11h	<b>218.16365</b>	10/40	<b>218.32365</b>	10/40	
100-300Hz		>50V		10h	<b>218.16361</b>	10/40	<b>218.32361</b>	10/40	
>300-500Hz		>50V		2h	<b>218.16362</b>	10/40	<b>218.32362</b>	10/40	
3P+N+E		50Hz 60Hz	100-130V		4h	<b>218.1632</b>	10/40	<b>218.3232</b>	10/40
			208-250V		9h	<b>218.1635</b>	10/40	<b>218.3235</b>	10/40
	346-415V			6h	<b>218.1637</b>	10/40	<b>218.3237</b>	10/40	
	380V 50Hz / 440V 60Hz			3h	<b>218.16374</b>	10/40	<b>218.32374</b>	10/40	
	60Hz	480-500V		7h	<b>218.16376</b>	10/40	<b>218.32376</b>	10/40	
		600-690V		5h	<b>218.16377</b>	10/40	<b>218.32377</b>	10/40	
	>300-500Hz	440-460V		11h	<b>218.16375</b>	10/40	<b>218.32375</b>	10/40	
		>50V		2h	<b>218.16372</b>	10/40	<b>218.32372</b>	10/40	



**Terminals**  
Screw terminals



**Terminals**  
Spring terminals (FAST WIRING)



**Terminals**  
Perforating terminals (FAST WIRING)



# Plugs and inlets for industrial applications

## Plugs - IP66/IP67/IP69



### ■ OPTIMA Series >> Plugs

#### OPTIMA Series

218.



Perforating terminals

Poles	Hz	Volt	Colour	h	PLUG	CABLE GLAND
2P+E	50Hz 60Hz	100-130V		4h	<b>218.1630P</b>	10/40
		200-250V		6h	<b>218.1633P</b>	10/40
		380-415V		9h	<b>218.1638P</b>	10/40
3P+E	50Hz 60Hz	200-250V		6h	<b>218.1634P</b>	10/40
		380-415V		9h	<b>218.1636P</b>	10/40
3P+N+E		346-415V		6h	<b>218.1637P</b>	10/40

#### OPTIMA Series

218.



Spring terminals

Poles	Hz	Volt	Colour	h	PLUG	CABLE GLAND
2P+E	50Hz 60Hz	100-130V		4h	<b>218.3230F</b>	10/40
		200-250V		6h	<b>218.3233F</b>	10/40
		380-415V		9h	<b>218.3238F</b>	10/40
3P+E	50Hz 60Hz	200-250V		6h	<b>218.3234F</b>	10/40
		380-415V		9h	<b>218.3236F</b>	10/40
3P+N+E		380V 50Hz / 440V 60Hz		3h	<b>218.32364F</b>	10/40
		346-415V		6h	<b>218.3237F</b>	10/40

1.1



# Plugs and inlets for industrial applications

## Plugs - IP66/IP67/IP69

### OPTIMA Series >> Plugs

#### OPTIMA Series

218.



#### Mantle terminals

#### PLUG

IP66/IP67/IP69

CABLE GLAND

Poles	Hz	Volt	Colour	h	63A		125A	
					Part No.	6/24	Part No.	1/8
2P+E	50Hz 60Hz	100-130V	Yellow	4h	<b>218.6330</b>	6/24	<b>218.12530</b>	1/8
		200-250V	Blue	6h	<b>218.6333</b>	6/24	<b>218.12533</b>	1/8
		380-415V	Red	9h	<b>218.6338</b>	6/24	<b>218.12538</b>	1/8
		480-500V	Black	7h	<b>218.63336</b>	6/24	<b>218.125336</b>	1/8
		TST>50V	Grey	12h	<b>218.63333</b>	6/24	<b>218.125333</b>	1/8
	DC	>50-250V	Grey	3h	<b>218.63334</b>	6/24	<b>218.125334</b>	1/8
		>250V	Grey	8h	<b>218.63338</b>	6/24	<b>218.125338</b>	1/8
		>300-500Hz	>50V	Green	2h	<b>218.63332</b>	6/24	<b>218.125332</b>
3P+E	50Hz 60Hz	100-130V	Yellow	4h	<b>218.6331</b>	6/24	<b>218.12531</b>	1/8
		200-250V	Blue	9h	<b>218.6334</b>	6/24	<b>218.12534</b>	1/8
		380-415V	Red	6h	<b>218.6336</b>	6/24	<b>218.12536</b>	1/8
		380V 50Hz / 440V 60Hz	Red	3h	<b>218.63364</b>	6/24	<b>218.125364</b>	1/8
		480-500V	Black	7h	<b>218.63366</b>	6/24	<b>218.125366</b>	1/8
	60Hz	600-690V	Black	5h	<b>218.63367</b>	6/24	<b>218.125367</b>	1/8
		440-460V	Red	11h	<b>218.63365</b>	6/24	<b>218.125365</b>	1/8
		100-300Hz	>50V	Green	10h	<b>218.63361</b>	6/24	<b>218.125361</b>
>300-500Hz	>50V	Green	2h	<b>218.63362</b>	6/24	<b>218.125362</b>	1/8	
3P+N+E	50Hz 60Hz	100-130V	Yellow	4h	<b>218.6332</b>	6/24	<b>218.12532</b>	1/8
		208-250V	Blue	9h	<b>218.6335</b>	6/24	<b>218.12535</b>	1/8
		346-415V	Red	6h	<b>218.6337</b>	6/24	<b>218.12537</b>	1/8
		380V 50Hz / 440V 60Hz	Red	3h	<b>218.63374</b>	6/24	<b>218.125374</b>	1/8
		480-500V	Black	7h	<b>218.63376</b>	6/24	<b>218.125376</b>	1/8
	60Hz	600-690V	Black	5h	<b>218.63377</b>	6/24	<b>218.125377</b>	1/8
		440-460V	Red	11h	<b>218.63375</b>	6/24	<b>218.125375</b>	1/8
		>300-500Hz	>50V	Green	2h	<b>218.63372</b>	6/24	<b>218.125372</b>



**Terminals**  
Mantle terminals (EASY-PLUG)



**Terminals**  
Perforating terminals (FAST WIRING)



**Terminals**  
Screw terminals

# Plugs and inlets for industrial applications

## Plugs - IP66/IP67/IP69



### ■ OPTIMA Series >> Plugs [Transparent version]

#### OPTIMA Series

218.



Perforating terminals



Screw terminals

					PLUG			
					IP66/IP67/IP69			
					CABLE GLAND			
					16A			
Poles	Hz	Volt	Colour	h	16A		32A	
2P+E	50Hz 60Hz	100-130V	Yellow	4h	<b>218.1630P.TR</b>	10/40	<b>218.1630.TR</b>	10/40
		200-250V	Blue	6h	<b>218.1633P.TR</b>	10/40	<b>218.1633.TR</b>	10/40

- Transparent grip

### ■ OPTIMA-REVERSE Series >> Plugs with phase inverter

#### OPTIMA-REVERSE Series

218.



Screw terminals

					PLUG			
					IP66/IP67/IP69			
					CABLE GLAND			
					16A		32A	
Poles	Hz	Volt	Colour	h	16A		32A	
3P+E	50Hz 60Hz	380-415V	Red	6h	<b>218.1636RV</b>	10/40	<b>218.3236RV</b>	10/40
3P+N+E		346-415V			<b>218.1637RV</b>	10/40	<b>218.3237RV</b>	10/40

- Phase inverter

1.1



# Plugs and inlets for industrial applications

## Plugs - IP66/IP67/IP69

### ■ OPTIMA-HD Series >> Plugs

#### OPTIMA-HD Series

218.





















 Screw terminals

PLUG

IP66/IP67/IP69

CABLE GLAND

Current	Poles	Hz	Volt	Colour	h	Product Code	Lead Time
16A	2P+E	50Hz 60Hz	200-250V		6h	<b>218.1633.KX</b>	10/40
	3P+E		380-415V		6h	<b>218.1636.KX</b>	10/40
	3P+N+E		208-250V		9h	<b>218.1635.KX</b>	10/40
			346-415V		9h	<b>218.1637.KX</b>	10/40
32A	2P+E	50Hz 60Hz	200-250V		6h	<b>218.3233.KX</b>	10/40
	3P+E		380-415V		6h	<b>218.3236.KX</b>	10/40
			380V 50Hz / 440V 60Hz		3h	<b>218.32364.KX</b>	1/12
	3P+N+E		208-250V		9h	<b>218.3235.KX</b>	10/40
			346-415V		9h	<b>218.3237.KX</b>	10/40
63A	2P+E	60Hz	200-250V		6h	<b>218.6333.KX</b>	6/24
	3P+E		380-415V		11h	<b>218.6336.KX</b>	6/24
			440-460V		11h	<b>218.63365.KX</b>	6/24
	3P+N+E		208-250V		9h	<b>218.6335.KX</b>	6/24
346-415V			9h	<b>218.6337.KX</b>	6/24		
125A	2P+E	50Hz 60Hz	200-250V		6h	<b>218.12533.KX</b>	1/8
	3P+E		380-415V		6h	<b>218.12536.KX</b>	1/8
			208-250V		9h	<b>218.12535.KX</b>	1/8
	3P+N+E		346-415V		6h	<b>218.12537.KX</b>	1/8

 High impact resistance

- High heat and fire resistance



**Terminals**  
Screw terminals

# Plugs and inlets for industrial applications

## Plugs - IP66/IP67/IP69



### EUREKA Series >> Plugs

#### EUREKA Series

226.



Screw terminals  
[Angled outlet]

PLUG

IP66/IP67

CABLE GLAND

Poles	Hz	Volt	Colour	h	16A		32A	
					Part No.	10/100	Part No.	10/40
2P+E	50Hz 60Hz	100-130V	Yellow	4h	<b>226.1630</b>	10/100	<b>226.3230</b>	10/40
		200-250V	Blue	6h	<b>226.1633</b>	10/100	<b>226.3233</b>	10/40
380-415V		Red	3h	<b>226.1636</b>	10/100	<b>226.3236</b>	10/40	
380V 50Hz / 440V 60Hz		Black	5h	<b>226.16367</b>	10/100	<b>226.32364</b>	10/40	
3P+N+E		346-415V	Red	6h	<b>226.1637</b>	10/50	<b>226.3237</b>	10/40

1.1



# Plugs and inlets for industrial applications

## Flush mounting appliance inlets - IP44/IP54

### ■ OPTIMA Series >> Flush mounting appliance inlets

#### OPTIMA Series

243.



#### APPLIANCE INLET

IP44/IP54

75x75mm

100x110mm

Poles	Hz	Volt	Colour	h	75x75mm			100x110mm		
					16A	32A	63A	16A	32A	63A
2P+E	50Hz 60Hz	100-130V	Yellow	4h	<b>243.1690</b>	10/50	<b>243.3290</b>	10/50	<b>243.6390</b>	
		200-250V	Blue	6h	<b>243.1693</b>	10/50	<b>243.3293</b>	10/50	<b>243.6393</b>	10
		380-415V	Red	9h	<b>243.1698</b>	10/50	<b>243.3298</b>	10/50	<b>243.6398</b>	
		480-500V	Black	7h					<b>243.63936</b>	
	DC	TST>50V	Grey	12h					<b>243.63933</b>	
		>300-500Hz	>50V	Green	2h				<b>243.63932</b>	
		>50-250V	Grey	3h					<b>243.63934</b>	
		>250V	Grey	8h					<b>243.63938</b>	
3P+E	50Hz 60Hz	100-130V	Yellow	4h	<b>243.1691</b>	10/50	<b>243.3291</b>	10/50	<b>243.6391</b>	
		200-250V	Blue	9h	<b>243.1694</b>	10/50	<b>243.3294</b>	10/50	<b>243.6394</b>	
		380-415V	Red	6h	<b>243.1696</b>	10/50	<b>243.3296</b>	10/50	<b>243.6396</b>	10
		380V 50Hz / 440V 60Hz	Red	3h	<b>243.16964</b>	10/50	<b>243.32964</b>	10/50	<b>243.63964</b>	
	60Hz	480-500V	Black	7h					<b>243.63966</b>	
		600-690V	Black	5h					<b>243.63967</b>	
		440-460V	Red	11h	<b>243.16965</b>	10/50	<b>243.32965</b>	10/50	<b>243.63965</b>	
		>300-500Hz	>50V	Green	2h				<b>243.63962</b>	
3P+N+E	50Hz 60Hz	100-130V	Yellow	4h	<b>243.1692</b>	10/50	<b>243.3292</b>	10/40	<b>243.6392</b>	
		208-250V	Blue	9h	<b>243.1695</b>	10/50	<b>243.3295</b>	10/40	<b>243.6395</b>	
		346-415V	Red	6h	<b>243.1697</b>	10/50	<b>243.3297</b>	10/40	<b>243.6397</b>	10
		380V 50Hz / 440V 60Hz	Red	3h	<b>243.16974</b>	10/50	<b>243.32974</b>	10/40	<b>243.63974</b>	
	60Hz	480-500V	Black	7h					<b>243.63976</b>	
		600-690V	Black	5h					<b>243.63977</b>	
		440-460V	Red	11h	<b>243.16975</b>	10/50	<b>243.32975</b>	10/40	<b>243.63975</b>	
		>300-500Hz	>50V	Green	2h				<b>243.63972</b>	



**Terminals**  
Mantle terminals (EASY-PLUG)



**Terminals**  
Screw terminals

# Plugs and inlets for industrial applications

## Flush mounting appliance inlets - IP44/IP54



### ■ OPTIMA-REVERSE Series >> Flush mounting appliance inlets with phase inverter

OPTIMA-REVERSE Series

243.



Screw terminals  
[Straight outlet]

APPLIANCE INLET

IP44/IP54

75x75mm

Poles	Hz	Volt	Colour	h	16A		32A	
3P+E	50Hz 60Hz	380-415V		6h	<b>243.1696RV</b>	10/50	<b>243.3296RV</b>	10/50
3P+N+E		346-415V			<b>243.1697RV</b>	10/50	<b>243.3297RV</b>	10/40

- Phase inverter



**OPTIMA-REVERSE Series**  
Operating principle of the phase inverter

1.1



# Plugs and inlets for industrial applications

## Flush mounting appliance inlets - IP44/IP54

### EUREKA Series >> Appliance inlets

#### EUREKA Series

242.





 **Screw terminals**  
[90° angled]

#### APPLIANCE INLET

IP44

70x87mm

PG 16

Poles	Hz	Volt	Colour	h	16A		32A		
					Part No.	10/100	Part No.	10/60	
2P+E	50Hz 60Hz	100-130V		4h	<b>242.1690</b>	10/100	<b>242.3290</b>	10/60	
		200-250V		6h	<b>242.1693</b>	10/100	<b>242.3293</b>	10/60	
		380-415V		9h	<b>242.1698</b>	10/100	<b>242.3298</b>	10/60	
		480-500V		7h	<b>242.16936</b>		<b>242.32936</b>	10/60	
		TST>50V		12h	<b>242.16933</b>		<b>242.32933</b>		
	>300-500Hz	>50V		2h	<b>242.16932</b>	10/100	<b>242.32932</b>		
	DC	>50-250V		3h	<b>242.16934</b>	10/100	<b>242.32934</b>	10/60	
		>250V		8h	<b>242.16938</b>	10/100	<b>242.32938</b>	10/60	
	3P+E	50Hz 60Hz	100-130V		4h	<b>242.1691</b>	10/100	<b>242.3291</b>	10/60
			200-250V		9h	<b>242.1694</b>	10/100	<b>242.3294</b>	10/60
380-415V				6h	<b>242.1696</b>	10/100	<b>242.3296</b>	10/60	
380V 50Hz / 440V 60Hz				3h	<b>242.16964</b>		<b>242.32964</b>	10/60	
440-460V				11h	<b>242.16965</b>	10/100	<b>242.32965</b>	10/60	
480-500V				7h	<b>242.16966</b>	10/100	<b>242.32966</b>	10/60	
600-690V			5h	<b>242.16967</b>	10/100	<b>242.32967</b>	10/60		
100-300Hz		>50V		10h	<b>242.16961</b>	10/100	<b>242.32961</b>		
>300-500Hz		>50V		2h	<b>242.16962</b>	10/100	<b>242.32962</b>	10/60	
3P+N+E		50Hz 60Hz	100-130V		4h	<b>242.1692</b>	10/60	<b>242.3292</b>	10/40
	208-250V			9h	<b>242.1695</b>	10/60	<b>242.3295</b>	10/40	
	346-415V			6h	<b>242.1697</b>	10/60	<b>242.3297</b>	10/40	
	380V 50Hz / 440V 60Hz			3h	<b>242.16974</b>	10/60	<b>242.32974</b>	10	
	480-500V			7h	<b>242.16976</b>	10/60	<b>242.32976</b>	10	
	600-690V		5h	<b>242.16977</b>		<b>242.32977</b>	10		
	60Hz	440-460V		11h	<b>242.16975</b>		<b>242.32975</b>	10	
	>300-500Hz	>50V		2h	<b>242.16972</b>	10/60	<b>242.32972</b>	10/40	



**Terminals**  
Screw terminals



# Plugs and inlets for industrial applications

## Flush mounting appliance inlets - IP66/IP67/IP69



### ■ OPTIMA Series >> Flush mounting appliance inlets

OPTIMA Series

248.



Screw terminals  
[Straight outlet]

APPLIANCE INLET

IP66/IP67/IP69

75x75mm

Poles	Hz	Volt	Colour	h	16A		32A		
					Part No.	10/50	Part No.	10/50	
2P+E	50Hz 60Hz	100-130V	Yellow	4h	<b>248.1690</b>	10/50	<b>248.3290</b>	10/50	
		200-250V	Blue	6h	<b>248.1693</b>	10/50	<b>248.3293</b>	10/50	
		380-415V	Red	9h	<b>248.1698</b>	10/50	<b>248.3298</b>	10/50	
		480-500V	Black	7h	<b>248.16936</b>	10/50	<b>248.32936</b>	10/50	
		TST>50V	Grey	12h	<b>248.16933</b>	10/50	<b>248.32933</b>	10/50	
	>300-500Hz	>50V	Green	2h	<b>248.16932</b>	10/50	<b>248.32932</b>	10/50	
	DC	>50-250V	Grey	3h	<b>248.16934</b>	10/50	<b>248.32934</b>	10/50	
		>250V	Grey	8h	<b>248.16938</b>	10/50	<b>248.32938</b>	10/50	
	3P+E	50Hz 60Hz	100-130V	Yellow	4h	<b>248.1691</b>	10/50	<b>248.3291</b>	10/50
			200-250V	Blue	9h	<b>248.1694</b>	10/50	<b>248.3294</b>	10/50
380-415V			Red	6h	<b>248.1696</b>	10/50	<b>248.3296</b>	10/50	
380V 50Hz / 440V 60Hz			Red	3h	<b>248.16964</b>	10/50	<b>248.32964</b>	10/50	
480-500V			Black	7h	<b>248.16966</b>	10/50	<b>248.32966</b>	10/50	
60-690V		Black	5h	<b>248.16967</b>	10/50	<b>248.32967</b>	10/50		
60Hz		440-460V	Red	11h	<b>248.16965</b>	10/50	<b>248.32965</b>	10/50	
100-300Hz		>50V	Green	10h	<b>248.16961</b>	10/50	<b>248.32961</b>	10/50	
>300-500Hz		>50V	Green	2h	<b>248.16962</b>	10/50	<b>248.32962</b>	10/50	
3P+N+E		50Hz 60Hz	100-130V	Yellow	4h	<b>248.1692</b>	10/50	<b>248.3292</b>	10/40
	208-250V		Blue	9h	<b>248.1695</b>	10/50	<b>248.3295</b>	10/40	
	346-415V		Red	6h	<b>248.1697</b>	10/50	<b>248.3297</b>	10/40	
	380V 50Hz / 440V 60Hz		Red	3h	<b>248.16974</b>	10/50	<b>248.32974</b>	10/40	
	480-500V		Black	7h	<b>248.16976</b>	10/50	<b>248.32976</b>	10/40	
	600-690V	Black	5h	<b>248.16977</b>	10/50	<b>248.32977</b>	10/40		
	60Hz	440-460V	Red	11h	<b>248.16975</b>	10/50	<b>248.32975</b>	10/40	
	>300-500Hz	>50V	Green	2h	<b>248.16972</b>	10/50	<b>248.32972</b>	10/40	

1.1



# Plugs and inlets for industrial applications

## Flush mounting appliance inlets - IP66/IP67/IP69

### ■ OPTIMA Series >> Flush mounting appliance inlets

#### OPTIMA Series

























248.



 **Mantle terminals**  
[Straight outlet]

#### APPLIANCE INLET

IP66/IP67/IP69

Poles	Hz	Volt	Colour	h	APPLIANCE INLET			
					100x110mm		114x114mm	
					63A		125A	
2P+E	50Hz 60Hz	100-130V		4h	<b>248.6390</b>	10	<b>248.12590</b>	10
		200-250V		6h	<b>248.6393</b>	10	<b>248.12593</b>	10
		380-415V		9h	<b>248.6398</b>	10	<b>248.12598</b>	10
		480-500V		7h	<b>248.63936</b>	10	<b>248.125936</b>	10
		TST>50V		12h	<b>248.63933</b>	10	<b>248.125933</b>	10
	>300-500Hz	>50V		2h	<b>248.63932</b>	10	<b>248.125932</b>	10
	DC	>50-250V		3h	<b>248.63934</b>	10	<b>248.125934</b>	10
		>250V		8h	<b>248.63938</b>	10	<b>248.125938</b>	10
3P+E	50Hz 60Hz	100-130V		4h	<b>248.6391</b>	10	<b>248.12591</b>	10
		200-250V		9h	<b>248.6394</b>	10	<b>248.12594</b>	10
		380-415V		6h	<b>248.6396</b>	10	<b>248.12596</b>	10
		380V 50Hz / 440V 60Hz		3h	<b>248.63964</b>	10	<b>248.125964</b>	10
		480-500V		7h	<b>248.63966</b>	10	<b>248.125966</b>	10
	600-690V		5h	<b>248.63967</b>	10	<b>248.125967</b>	10	
	60Hz	440-460V		11h	<b>248.63965</b>	10	<b>248.125965</b>	10
	100-300Hz	>50V		10h	<b>248.63961</b>	10	<b>248.125961</b>	10
>300-500Hz	>50V		2h	<b>248.63962</b>	10	<b>248.125962</b>	10	
3P+N+E	50Hz 60Hz	100-130V		4h	<b>248.6392</b>	10	<b>248.12592</b>	10
		208-250V		9h	<b>248.6395</b>	10	<b>248.12595</b>	10
		346-415V		6h	<b>248.6397</b>	10	<b>248.12597</b>	10
		380V 50Hz / 440V 60Hz		3h	<b>248.63974</b>	10	<b>248.125974</b>	10
		480-500V		7h	<b>248.63976</b>	10	<b>248.125976</b>	10
	600-690V		5h	<b>248.63977</b>	10	<b>248.125977</b>	10	
	60Hz	440-460V		11h	<b>248.63975</b>	10	<b>248.125975</b>	10
	>300-500Hz	>50V		2h	<b>248.63972</b>	10	<b>248.125972</b>	10



**Terminals**  
Mantle terminals (EASY-PLUG)



**Terminals**  
Screw terminals

# Plugs and inlets for industrial applications

## Flush mounting appliance inlets - IP66/IP67/IP69



### ■ OPTIMA-REVERSE Series >> Flush mounting appliance inlets with phase inverter

OPTIMA-REVERSE Series

248.



**Screw terminals**  
[Straight outlet]

APPLIANCE INLET

IP66/IP67/IP69

75x75mm

Poles	Hz	Volt	Colour	h	16A		32A	
					Part No.	10/50	Part No.	10/50
3P+E	50Hz 60Hz	380-415V		6h	<b>248.1696RV</b>	10/50	<b>248.3296RV</b>	10/50
3P+N+E		346-415V			<b>248.1697RV</b>	10/50	<b>248.3297RV</b>	10/40

- Phase inverter



**OPTIMA-REVERSE Series**  
Operating principle of the phase inverter

1.1



# Plugs and inlets for industrial applications

## Flush mounting appliance inlets - IP66/IP67

### EUREKA Series >> Appliance inlets - 90° angled

#### EUREKA Series

247.



**Screw terminals**  
[90° angled]

#### APPLIANCE INLET

IP66/IP67

70x87mm

PG 16

Poles	Hz	Volt	Colour	h	16A		32A		
					Part No.	Rating	Part No.	Rating	
2P+E	50Hz 60Hz	100-130V	Yellow	4h	<b>247.1690</b>	10/100	<b>247.3290</b>	10/40	
		200-250V	Blue	6h	<b>247.1693</b>	10/100	<b>247.3293</b>	10/40	
		380-415V	Red	9h	<b>247.1698</b>	10/100	<b>247.3298</b>	10/40	
		480-500V	Black	7h	<b>247.16936</b>	10/100	<b>247.32936</b>	10/40	
		TST>50V	Grey	12h	<b>247.16933</b>		<b>247.32933</b>		
	>300-500Hz	>50V	Green	2h	<b>247.16932</b>	10/100	<b>247.32932</b>		
	DC	>50-250V	Grey	3h	<b>247.16934</b>	10/100	<b>247.32934</b>	10/40	
		>250V	Grey	8h	<b>247.16938</b>		<b>247.32938</b>		
	3P+E	50Hz 60Hz	100-130V	Yellow	4h	<b>247.1691</b>	10/60	<b>247.3291</b>	10/40
			200-250V	Blue	9h	<b>247.1694</b>	10/60	<b>247.3294</b>	10/40
380-415V			Red	6h	<b>247.1696</b>	10/60	<b>247.3296</b>	10/40	
380V 50Hz / 440V 60Hz			Black	3h	<b>247.16964</b>	10/60	<b>247.32964</b>	10/40	
480-500V			Black	7h	<b>247.16966</b>	10/60	<b>247.32966</b>	10/40	
60Hz		440-460V	Red	11h	<b>247.16965</b>	10/60	<b>247.32965</b>	10/40	
100-300Hz		>50V	Green	10h	<b>247.16961</b>		<b>247.32961</b>	10/40	
>300-500Hz		>50V	Green	2h	<b>247.16962</b>		<b>247.32962</b>		
3P+N+E		50Hz 60Hz	100-130V	Yellow	4h	<b>247.1692</b>	10/50	<b>247.3292</b>	10/40
			208-250V	Blue	9h	<b>247.1695</b>	10/50	<b>247.3295</b>	10/40
	346-415V		Red	6h	<b>247.1697</b>	10/50	<b>247.3297</b>	10/40	
	380V 50Hz / 440V 60Hz		Black	3h	<b>247.16974</b>	10/50	<b>247.32974</b>	10/40	
	480-500V		Black	7h	<b>247.16976</b>	10/50	<b>247.32976</b>	10	
	60Hz	440-460V	Red	11h	<b>247.16975</b>		<b>247.32975</b>	10/40	
	>300-500Hz	>50V	Green	2h	<b>247.16972</b>	10/50	<b>247.32972</b>	10/40	



**Terminals**  
Screw terminals



**Terminals**  
Mantle terminals (EASY-PLUG)

# Plugs and inlets for industrial applications

## Surface mounting appliance inlets - IP44/IP54



### ■ OPTIMA-TOP Series >> Surface mounting appliance inlets

#### OPTIMA-TOP Series

240.



Mantle terminals

APPLIANCE INLET

IP44/IP54

M40X1,5

63A

Poles	Hz	Volt	Colour	h	Product Code	Quantity	
2P+E	50Hz 60Hz	100-130V	Yellow	4h	240.6390T	4	
		200-250V	Blue	6h	240.6393T	4	
		380-415V	Red	9h	240.6398T	4	
		480-500V	Black	7h	240.63936T		
		TST>50V	Grey	12h	240.63933T		
	>300-500Hz	>50V	Green	2h	240.63932T		
	DC	>50-250V	Grey	3h	240.63934T		
		>250V	Grey	8h	240.63938T		
	3P+E	50Hz 60Hz	100-130V	Yellow	4h	240.6391T	4
			200-250V	Blue	9h	240.6394T	4
380-415V			Red	6h	240.6396T	4	
380V 50Hz / 440V 60Hz			Red	3h	240.63964T		
440-460V			Black	11h	240.63965T		
480-500V			Black	7h	240.63966T		
600-690V		Black	5h	240.63967T			
100-300Hz		>50V	Green	10h	240.63961T		
>300-500Hz		>50V	Green	2h	240.63962T		
3P+N+E		50Hz 60Hz	100-130V	Yellow	4h	240.6392T	4
	208-250V		Blue	9h	240.6395T	4	
	346-415V		Red	6h	240.6397T	4	
	380V 50Hz / 440V 60Hz		Red	3h	240.63974T		
	480-500V	Black	7h	240.63976T			
	600-690V	Black	5h	240.63977T			
	60Hz	440-460V	Red	11h	240.63975T		
	>300-500Hz	>50V	Green	2h	240.63972T		

- Cable gland included

1.1



# Plugs and inlets for industrial applications

## Surface mounting appliance inlets - IP66/IP67/IP69

### OPTIMA-TOP Series >> Surface mounting appliance inlets

#### OPTIMA-TOP Series

245.



#### Mantle terminals

#### APPLIANCE INLET

IP66/IP67

Poles	Hz	Volt	Colour	h	M40X1,5		M63X1,5		
					63A		125A		
2P+E	50Hz 60Hz	100-130V	Yellow	4h	<b>245.6390T</b>	4	<b>245.12590T</b>	1/4	
		200-250V	Blue	6h	<b>245.6393T</b>	4	<b>245.12593T</b>	1/4	
		380-415V	Red	9h	<b>245.6398T</b>	4	<b>245.12598T</b>	1/4	
		480-500V	Black	7h	<b>245.63936T</b>		<b>245.125936T</b>		
		TST>50V	Grey	12h	<b>245.63933T</b>		<b>245.125933T</b>		
	DC	>300-500Hz	>50V	Green	2h	<b>245.63932T</b>		<b>245.125932T</b>	
		>50-250V	Grey	3h	<b>245.63934T</b>		<b>245.125934T</b>		
		>250V	Grey	8h	<b>245.63938T</b>		<b>245.125938T</b>		
3P+E	50Hz 60Hz	100-130V	Yellow	4h	<b>245.6391T</b>	4	<b>245.12591T</b>	1/4	
		200-250V	Blue	9h	<b>245.6394T</b>	4	<b>245.12594T</b>	1/4	
		380-415V	Red	6h	<b>245.6396T</b>	4	<b>245.12596T</b>	1/4	
		380V 50Hz / 440V 60Hz	Black	3h	<b>245.63964T</b>		<b>245.125964T</b>		
		480-500V	Black	7h	<b>245.63966T</b>		<b>245.125966T</b>		
	60Hz	600-690V	Black	5h	<b>245.63967T</b>		<b>245.125967T</b>		
		440-460V	Red	11h	<b>245.63965T</b>		<b>245.125965T</b>		
		>100-300Hz	Green	10h	<b>245.63961T</b>		<b>245.125961T</b>		
>300-500Hz	>50V	Green	2h	<b>245.63962T</b>		<b>245.125962T</b>			
3P+N+E	50Hz 60Hz	100-130V	Yellow	4h	<b>245.6392T</b>	4	<b>245.12592T</b>	1/4	
		208-250V	Blue	9h	<b>245.6395T</b>	4	<b>245.12595T</b>	1/4	
		346-415V	Red	6h	<b>245.6397T</b>	4	<b>245.12597T</b>	1/4	
		380V 50Hz / 440V 60Hz	Black	3h	<b>245.63974T</b>		<b>245.125974T</b>		
		480-500V	Black	7h	<b>245.63976T</b>	4	<b>245.125976T</b>		
	60Hz	600-690V	Black	5h	<b>245.63977T</b>		<b>245.125977T</b>		
		440-460V	Red	11h	<b>245.63975T</b>		<b>245.125975T</b>		
		>300-500Hz	>50V	Green	2h	<b>245.63972T</b>		<b>245.125972T</b>	

- Cable gland included



**Terminals**  
Mantle terminals (EASY-PLUG)

# Plugs and inlets for industrial applications

## Accessories for plugs



### ACCESSORIES

570.



Description	Current	Poles	Cover for IP66/IP67/IP69 plugs	
PLUG CAP	16A 20A	2P+E	<b>570.90163</b>	10/100
		3P+E	<b>570.90164</b>	10/100
	30A 32A	3P+N+E	<b>570.90165</b>	10/100
		2/3P+E	<b>570.90324</b>	10/100
	60A 63A	ALL	<b>570.9063</b>	10
	100A 125A		<b>570.9125</b>	10

1.1



## 1.2

# Connectors and sockets for industrial applications

- Connectors - IP44/IP54
- Connectors - IP66/IP67/IP69
- Flush mounting socket outlets - IP44/IP54
- Flush mounting socket outlets - IP66/IP67/IP69
- Surface mounting socket outlets - IP44/IP54
- Surface mounting socket outlets - IP66/IP67/IP69
- Surface mounting switched socket outlets without interlock - IP44/IP54
- Surface mounting switched socket outlets without interlock - IP66/IP67/IP69
- Domestic standard socket for industrial applications - IP54
- BS socket for industrial applications - IP66
- Accessories for sockets

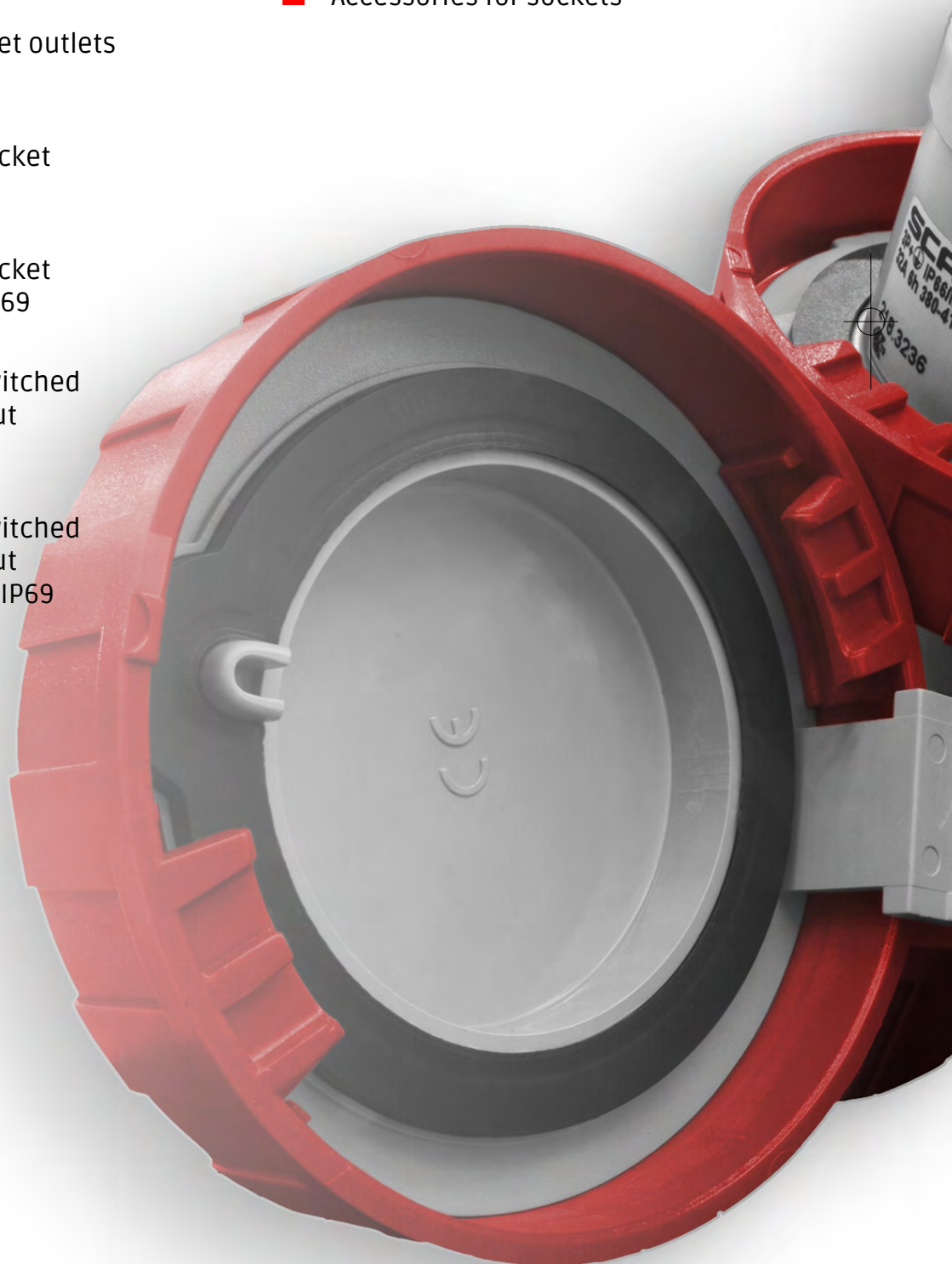



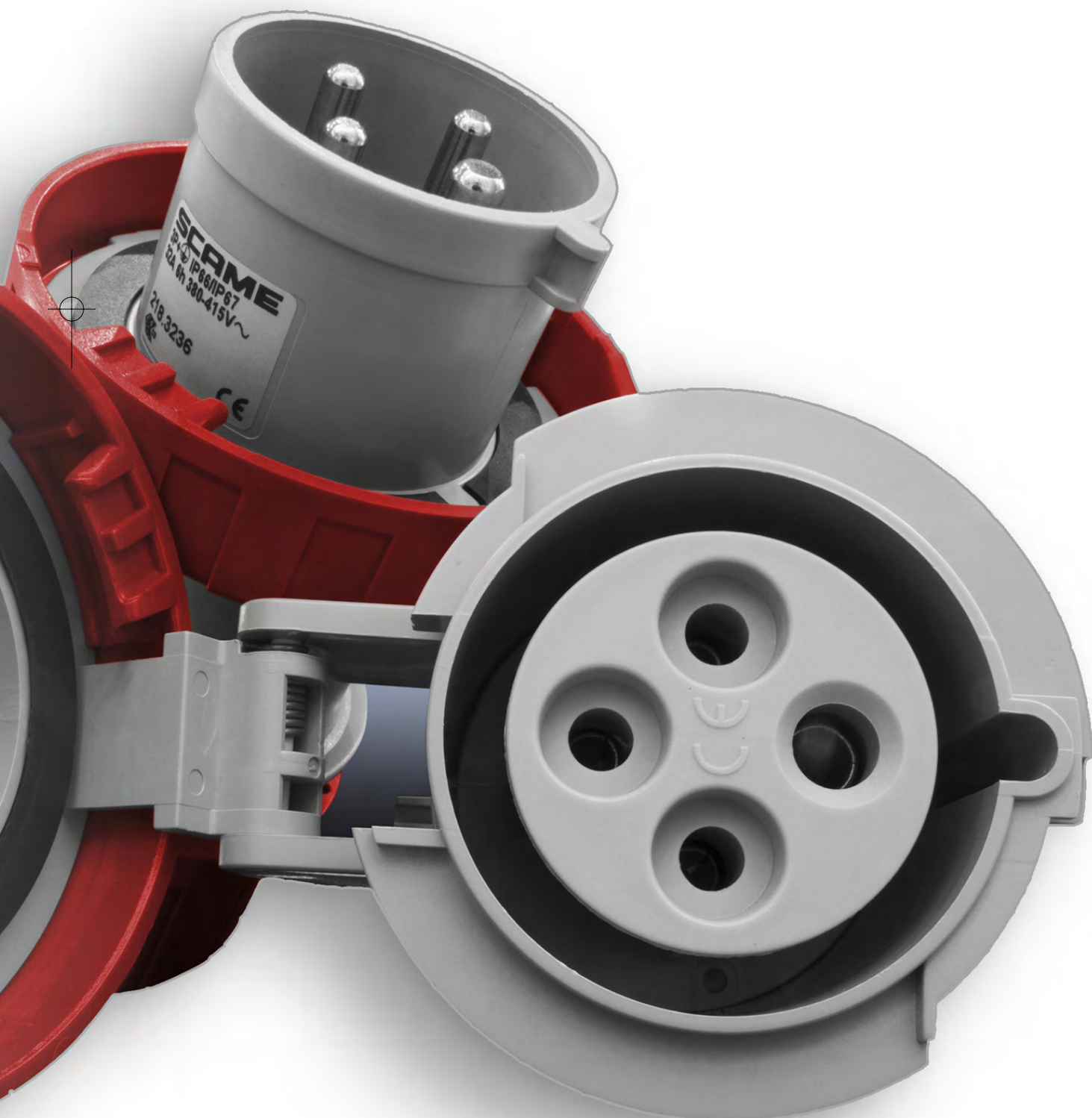

# Connectors and sockets for industrial applications

## Connectors - IP44/IP54

### OPTIMA Series >> Connectors

#### OPTIMA Series

313.



 Screw terminals

CONNECTOR

IP44/IP54

CABLE GLAND

Poles	Hz	Volt	Colour	h	16A		32A			
					Part No.	10/50	Part No.	10/40		
2P+E	50Hz 60Hz	100-130V	Yellow	4h	<b>313.1640</b>	10/50	<b>313.3240</b>	10/40		
		200-250V	Blue	6h	<b>313.1643</b>	10/50	<b>313.3243</b>	10/40		
		380-415V	Red	9h	<b>313.1648</b>	10/50	<b>313.3248</b>	10/40		
		480-500V	Black	7h	<b>313.16436</b>	10/50	<b>313.32436</b>	10/40		
		TST>50V	Grey	12h	<b>313.16433</b>	10/50	<b>313.32433</b>	10/40		
	>300-500Hz	>50V	Green	2h	<b>313.16432</b>	10/50	<b>313.32432</b>	10/40		
		DC	>50-250V	Grey	3h	<b>313.16434</b>	10/50	<b>313.32434</b>	10/40	
			>250V	Grey	8h	<b>313.16438</b>	10/50	<b>313.32438</b>	10/40	
		3P+E	50Hz 60Hz	100-130V	Yellow	4h	<b>313.1641</b>	10/50	<b>313.3241</b>	10/40
				200-250V	Blue	9h	<b>313.1644</b>	10/50	<b>313.3244</b>	10/40
380-415V	Red			6h	<b>313.1646</b>	10/50	<b>313.3246</b>	10/40		
380V 50Hz / 440V 60Hz	Red			3h	<b>313.16464</b>	10/50	<b>313.32464</b>	10/40		
480-500V	Black			7h	<b>313.16466</b>	10/50	<b>313.32466</b>	10/40		
>300-500Hz	600-690V		Black	5h	<b>313.16467</b>	10/50	<b>313.32467</b>	10/40		
	60Hz		440-460V	Red	11h	<b>313.16465</b>	10/50	<b>313.32465</b>	10/40	
	100-300Hz		>50V	Green	10h	<b>313.16461</b>	10/50	<b>313.32461</b>	10/40	
	>300-500Hz		>50V	Green	2h	<b>313.16462</b>	10/50	<b>313.32462</b>	10/40	
	3P+N+E		50Hz 60Hz	100-130V	Yellow	4h	<b>313.1642</b>	10/50	<b>313.3242</b>	10/40
208-250V		Blue		9h	<b>313.1645</b>	10/50	<b>313.3245</b>	10/40		
346-415V		Red		6h	<b>313.1647</b>	10/50	<b>313.3247</b>	10/40		
380V 50Hz / 440V 60Hz		Red		3h	<b>313.16474</b>	10/50	<b>313.32474</b>	10/40		
480-500V		Black		7h	<b>313.16476</b>	10/50	<b>313.32476</b>	10/40		
>300-500Hz		600-690V	Black	5h	<b>313.16477</b>	10/50	<b>313.32477</b>	10/40		
		60Hz	440-460V	Red	11h	<b>313.16475</b>	10/50	<b>313.32475</b>	10/40	
		>300-500Hz	>50V	Green	2h	<b>313.16472</b>	10/50	<b>313.32472</b>	10/40	



**Terminals**  
Screw terminals



**Terminals**  
Spring terminals (FAST WIRING)



**Terminals**  
Perforating terminals (FAST WIRING)

# Connectors and sockets for industrial applications

## Connectors - IP44/IP54



### ■ OPTIMA Series >> Connectors

#### OPTIMA Series

313.



**Perforating terminals**

CONNECTOR

IP44/IP54

CABLE GLAND

16A

Poles	Hz	Volt	Colour	h		
2P+E	50Hz 60Hz	100-130V		4h	<b>313.1640P</b>	10/50
		200-250V		6h	<b>313.1643P</b>	10/50
		380-415V		9h	<b>313.1648P</b>	10/50
3P+E	50Hz 60Hz	200-250V		6h	<b>313.1644P</b>	10/50
		380-415V		6h	<b>313.1646P</b>	10/50
3P+N+E		346-415V		6h	<b>313.1647P</b>	10/50

#### OPTIMA Series

313.



**Spring terminals**

CONNECTOR

IP44/IP54

CABLE GLAND

32A

Poles	Hz	Volt	Colour	h		
2P+E	50Hz 60Hz	100-130V		4h	<b>313.3240F</b>	10/40
		200-250V		6h	<b>313.3243F</b>	10/40
		380-415V		9h	<b>313.3248F</b>	10/40
3P+E	50Hz 60Hz	200-250V		6h	<b>313.3244F</b>	10/40
		380-415V		6h	<b>313.3246F</b>	10/40
3P+N+E		346-415V		6h	<b>313.3247F</b>	10/40

1.2



# Connectors and sockets for industrial applications

## Connectors - IP44/IP54

### OPTIMA Series >> Connectors

#### OPTIMA Series

313.



#### Mantle terminals

##### CONNECTOR

IP44/IP54

##### CABLE GLAND

63A

Poles	Hz	Volt	Colour	h	Product Code	6/24	
2P+E	50Hz 60Hz	100-130V	Yellow	4h	<b>313.6340</b>	6/24	
		200-250V	Blue	6h	<b>313.6343</b>	6/24	
		380-415V	Red	9h	<b>313.6348</b>	6/24	
		480-500V	Black	7h	<b>313.63436</b>	6/24	
		TST>50V	Grey	12h	<b>313.63433</b>	6/24	
	>300-500Hz	>50V	Green	2h	<b>313.63432</b>	6/24	
	DC	>50-250V	Grey	3h	<b>313.63434</b>	6/24	
		>250V	Grey	8h	<b>313.63438</b>	6/24	
	3P+E	50Hz 60Hz	100-130V	Yellow	4h	<b>313.6341</b>	6/24
			200-250V	Blue	9h	<b>313.6344</b>	6/24
380-415V			Red	6h	<b>313.6346</b>	6/24	
380V 50Hz / 440V 60Hz			Red	3h	<b>313.63464</b>	6/24	
480-500V			Black	7h	<b>313.63466</b>	6/24	
600-690V		Black	5h	<b>313.63467</b>	6/24		
60Hz		440-460V	Red	11h	<b>313.63465</b>	6/24	
100-300Hz		>50V	Green	10h	<b>313.63461</b>	6/24	
>300-500Hz		>50V	Green	2h	<b>313.63462</b>	6/24	
3P+N+E		50Hz 60Hz	100-130V	Yellow	4h	<b>313.6342</b>	6/24
	208-250V		Blue	9h	<b>313.6345</b>	6/24	
	346-415V		Red	6h	<b>313.6347</b>	6/24	
	380V 50Hz / 440V 60Hz		Red	3h	<b>313.63474</b>	6/24	
	480-500V		Black	7h	<b>313.63476</b>	6/24	
	600-690V	Black	5h	<b>313.63477</b>	6/24		
	60Hz	440-460V	Red	11h	<b>313.63475</b>	6/24	
	>300-500Hz	>50V	Green	2h	<b>313.63472</b>	6/24	



**Terminals**  
Mantle terminals (EASY-PLUG)



**Terminals**  
Perforating terminals (FAST WIRING)



**Terminals**  
Screw terminals

# Connectors and sockets for industrial applications

## Connectors - IP44/IP54



### ■ OPTIMA Series >> Connectors [Transparent version]

OPTIMA Series

313.



Screw terminals

Perforating terminals

CONNECTOR

IP44/IP54

CABLE GLAND

16A

Poles	Hz	Volt	Colour	h	CONNECTOR		CABLE GLAND	
2P+E	50Hz 60Hz	100-130V		4h	<b>313.1640.TR</b>	10/50	<b>313.1640P.TR</b>	10/50
		200-250V		6h	<b>313.1643.TR</b>	10/50	<b>313.1643P.TR</b>	10/50

- Transparent grip

1.2



# Connectors and sockets for industrial applications

## Connectors - IP44/IP54

### ■ OPTIMA Series >> Connectors [SAFE-IN]

#### OPTIMA Series

313.



Screw terminals

CONNECTOR

IP44/IP54

CABLE GLAND

16A

Poles	Hz	Volt	Colour	h		
2P+E	50Hz 60Hz	100-130V		4h	<b>313.1640H</b>	10/50
		200-250V		6h	<b>313.1643H</b>	10/50
		380-415V		9h	<b>313.1648H</b>	10/50
3P+E	50Hz 60Hz	200-250V		9h	<b>313.1644H</b>	10/50
		380-415V		6h	<b>313.1646H</b>	10/50
3P+N+E		346-415V		6h	<b>313.1647H</b>	10/50

Sockets with "SAFE-IN" safety device



#### THE "SAFE-IN" SAFETY DEVICE

The "SAFE-IN" safety device assembled on the 16A industrial sockets works like the protection installed on household sockets, i.e., by means of an appropriate shutter, it closes the input of the socket contact tubes and prevents accidental and voluntary contact of live parts of the socket with slim objects, such as screwdrivers or wires. This protection offers an additional safety guarantee, in addition to that already provided by the spring-loaded cover assembled on the mobile sockets.



Terminals  
Screw terminals

# Connectors and sockets for industrial applications

## Connectors - IP44/IP54



### EUREKA Series >> Connectors

#### EUREKA Series

321.



**Screw terminals  
[Angled outlet]**

CONNECTOR

IP44

CABLE SLEEVE

Poles	Hz	Volt	Colour	h	16A		32A	
					Part No.	Length	Part No.	Length
2P+E	50Hz 60Hz	100-130V		4h	<b>321.1640</b>	10/100	<b>321.3240</b>	10/50
		200-250V			<b>321.1643</b>	10/100	<b>321.3243</b>	10/50
3P+E		380-415V		6h	<b>321.1646</b>	10/100	<b>321.3246</b>	10/50
3P+N+E		346-415V			<b>321.1647</b>	10/100	<b>321.3247</b>	10/50

### XENIA Series >> Connectors

#### XENIA Series

314.



**Screw terminals**

CONNECTOR

IP44

CABLE GLAND

Poles	Hz	Volt	Colour	h	16A		32A	
					Part No.	Length	Part No.	Length
2P+E	50Hz 60Hz	100-130V		4h	<b>314.1640</b>	40	<b>314.3240</b>	20
		200-250V			<b>314.1643</b>	40	<b>314.3243</b>	20
3P+E		380-415V		6h	<b>314.1646</b>	30	<b>314.3246</b>	20
3P+N+E		346-415V			<b>314.1647</b>	25	<b>314.3247</b>	15

1.2



# Connectors and sockets for industrial applications

## Connectors - IP66/IP67/IP69

### OPTIMA Series >> Connectors

#### OPTIMA Series

318.



















 Screw terminals

CONNECTOR

IP66/IP67/IP69

CABLE GLAND

Poles	Hz	Volt	Colour	h	16A		32A		
					Part No.	10/40	Part No.	10/40	
2P+E	50Hz 60Hz	100-130V		4h	<b>318.1640</b>	10/40	<b>318.3240</b>	10/40	
		200-250V		6h	<b>318.1643</b>	10/40	<b>318.3243</b>	10/40	
		380-415V		9h	<b>318.1648</b>	10/40	<b>318.3248</b>	10/40	
		480-500V		7h	<b>318.16436</b>	10/40	<b>318.32436</b>	10/40	
		TST>50V		12h	<b>318.16433</b>	10/40	<b>318.32433</b>	10/40	
	DC	>50-250V		3h	<b>318.16434</b>	10/40	<b>318.32434</b>	10/40	
		>250V		8h	<b>318.16438</b>	10/40	<b>318.32438</b>	10/40	
3P+E	50Hz 60Hz	100-130V		4h	<b>318.1641</b>	10/40	<b>318.3241</b>	10/40	
		200-250V		9h	<b>318.1644</b>	10/40	<b>318.3244</b>	10/40	
		380-415V		6h	<b>318.1646</b>	10/40	<b>318.3246</b>	10/40	
		380V 50Hz / 440V 60Hz		3h	<b>318.16464</b>	10/40	<b>318.32464</b>	10/40	
		480-500V		7h	<b>318.16466</b>	10/40	<b>318.32466</b>	10/40	
	60Hz	600-690V		5h	<b>318.16467</b>	10/40	<b>318.32467</b>	10/40	
		440-460V		11h	<b>318.16465</b>	10/40	<b>318.32465</b>	10/40	
		100-300Hz	>50V		10h	<b>318.16461</b>	10/40	<b>318.32461</b>	10/40
		>300-500Hz	>50V		2h	<b>318.16462</b>	10/40	<b>318.32462</b>	10/40
3P+N+E	50Hz 60Hz	100-130V		4h	<b>318.1642</b>	10/40	<b>318.3242</b>	10/40	
		208-250V		9h	<b>318.1645</b>	10/40	<b>318.3245</b>	10/40	
		346-415V		6h	<b>318.1647</b>	10/40	<b>318.3247</b>	10/40	
		380V 50Hz / 440V 60Hz		3h	<b>318.16474</b>	10/40	<b>318.32474</b>	10/40	
		480-500V		7h	<b>318.16476</b>	10/40	<b>318.32476</b>	10/40	
	60Hz	600-690V		5h	<b>318.16477</b>	10/40	<b>318.32477</b>	10/40	
		440-460V		11h	<b>318.16475</b>	10/40	<b>318.32475</b>	10/40	
		>300-500Hz	>50V		2h	<b>318.16472</b>	10/40	<b>318.32472</b>	10/40



**Terminals**  
Screw terminals



**Terminals**  
Spring terminals (FAST WIRING)



**Terminals**  
Perforating terminals (FAST WIRING)



# Connectors and sockets for industrial applications

## Connectors - IP66/IP67/IP69



### ■ OPTIMA Series >> Connectors

#### OPTIMA Series

318.



Perforating terminals

CONNECTOR

IP66/IP67/IP69

CABLE GLAND

16A

Poles	Hz	Volt	Colour	h		
2P+E	50Hz 60Hz	100-130V		4h	<b>318.1640P</b>	10/40
		200-250V		6h	<b>318.1643P</b>	10/40
		380-415V		9h	<b>318.1648P</b>	10/40
3P+E	50Hz 60Hz	200-250V		6h	<b>318.1644P</b>	10/40
		380-415V		6h	<b>318.1646P</b>	10/40
3P+N+E		346-415V		6h	<b>318.1647P</b>	10/40

#### OPTIMA Series

318.



Spring terminals

CONNECTOR

IP66/IP67/IP69

CABLE GLAND

32A

Poles	Hz	Volt	Colour	h		
2P+E	50Hz 60Hz	100-130V		4h	<b>318.3240F</b>	10/40
		200-250V		6h	<b>318.3243F</b>	10/40
		380-415V		9h	<b>318.3248F</b>	10/40
3P+E	50Hz 60Hz	200-250V		6h	<b>318.3244F</b>	10/40
		380-415V		6h	<b>318.3246F</b>	10/40
		380V 50Hz / 440V 60Hz		3h	<b>318.32464F</b>	10/40
3P+N+E		346-415V		6h	<b>318.3247F</b>	10/40

1.2



# Connectors and sockets for industrial applications

## Connectors - IP66/IP67/IP69

### OPTIMA Series >> Connectors

#### OPTIMA Series

318.



Mantle terminals

#### CONNECTOR

IP66/IP67/IP69

#### CABLE GLAND

Poles	Hz	Volt	Colour	h	63A		125A		
					Part No.	6/24	Part No.	1/8	
2P+E	50Hz 60Hz	100-130V	Yellow	4h	<b>318.6340</b>	6/24	<b>318.12540</b>	1/8	
		200-250V	Blue	6h	<b>318.6343</b>	6/24	<b>318.12543</b>	1/8	
		380-415V	Red	9h	<b>318.6348</b>	6/24	<b>318.12548</b>	1/8	
		480-500V	Black	7h	<b>318.63436</b>	6/24	<b>318.125436</b>	1/8	
		TST>50V	Grey	12h	<b>318.63433</b>	6/24	<b>318.125433</b>	1/8	
	DC	>300-500Hz	>50V	Green	2h	<b>318.63432</b>	6/24	<b>318.125432</b>	1/8
		>50-250V	Grey	3h	<b>318.63434</b>	6/24	<b>318.125434</b>	1/8	
		>250V	Grey	8h	<b>318.63438</b>	6/24	<b>318.125438</b>	1/8	
3P+E	50Hz 60Hz	100-130V	Yellow	4h	<b>318.6341</b>	6/24	<b>318.12541</b>	1/8	
		200-250V	Blue	9h	<b>318.6344</b>	6/24	<b>318.12544</b>	1/8	
		380-415V	Red	6h	<b>318.6346</b>	6/24	<b>318.12546</b>	1/8	
		380V 50Hz / 440V 60Hz	Red	3h	<b>318.63464</b>	6/24	<b>318.125464</b>	1/8	
		480-500V	Black	7h	<b>318.63466</b>	6/24	<b>318.125466</b>	1/8	
	60Hz	600-690V	Black	5h	<b>318.63467</b>	6/24	<b>318.125467</b>	1/8	
		440-460V	Red	11h	<b>318.63465</b>	6/24	<b>318.125465</b>	1/8	
		100-300Hz	Green	10h	<b>318.63461</b>	6/24	<b>318.125461</b>	1/8	
		>300-500Hz	>50V	Green	2h	<b>318.63462</b>	6/24	<b>318.125462</b>	1/8
		100-130V	Yellow	4h	<b>318.6342</b>	6/24	<b>318.12542</b>	1/8	
3P+N+E	50Hz 60Hz	208-250V	Blue	9h			<b>318.12545</b>	1/8	
		346-415V	Red	6h	<b>318.6347</b>	6/24	<b>318.12547</b>	1/8	
		380V 50Hz / 440V 60Hz	Red	3h	<b>318.63474</b>	6/24	<b>318.125474</b>	1/8	
		480-500V	Black	7h	<b>318.63476</b>	6/24	<b>318.125476</b>	1/8	
	60Hz	600-690V	Black	5h	<b>318.63477</b>	6/24	<b>318.125477</b>	1/8	
		440-460V	Red	11h	<b>318.63475</b>	6/24	<b>318.125475</b>	1/8	
		>300-500Hz	>50V	Green	2h	<b>318.63472</b>	6/24	<b>318.125472</b>	1/8



**Terminals**  
Mantle terminals (EASY-PLUG)



**Terminals**  
Perforating terminals (FAST WIRING)



**Terminals**  
Screw terminals

# Connectors and sockets for industrial applications

## Connectors - IP66/IP67/IP69



### ■ OPTIMA Series >> Connectors (transparent version)

OPTIMA Series

318.



Perforating terminals

Screw terminals

CONNECTOR

IP66/IP67/IP69

CABLE GLAND

16A

Poles	Hz	Volt	Colour	h	CONNECTOR		CABLE GLAND	
2P+E	50Hz 60Hz	100-130V		4h	<b>318.1640P.TR</b>	10/40	<b>318.1640.TR</b>	10/40
		200-250V		6h	<b>318.1643P.TR</b>	10/40	<b>318.1643.TR</b>	10/40

- Transparent grip

1.2



# Connectors and sockets for industrial applications

## Connectors - IP66/IP67/IP69

### ■ OPTIMA Series >> Connectors [SAFE-IN]

#### OPTIMA Series

318.









#### Screw terminals

#### CONNECTOR

IP66/IP67/IP69

#### CABLE GLAND

16A

Poles	Hz	Volt	Colour	h		
2P+E	50Hz 60Hz	100-130V		4h	<b>318.1640H</b>	10/40
		200-250V		6h	<b>318.1643H</b>	10/40
		380-415V		9h	<b>318.1648H</b>	10/40
3P+E	50Hz 60Hz	200-250V		9h	<b>318.1644H</b>	10/40
		380-415V		6h	<b>318.1646H</b>	10/40
3P+N+E		346-415V		6h	<b>318.1647H</b>	10/40

 Sockets with "SAFE-IN" safety device

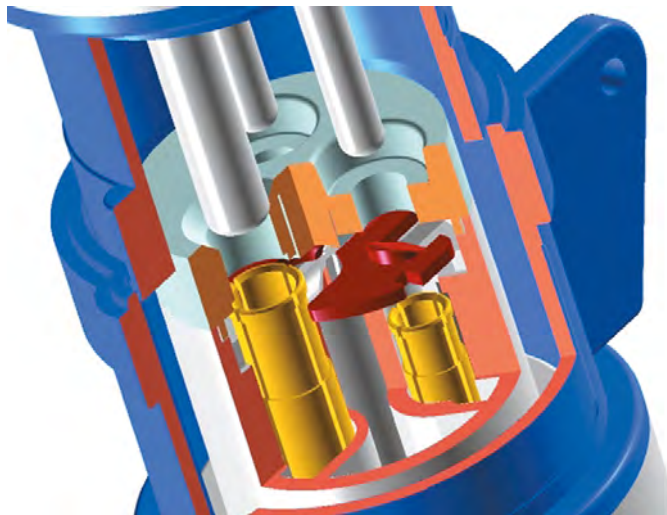

#### SAFE-IN

Connector tube protective shutter for increased safety against direct contacts. (The SAFE-IN safety device).



**Terminals**  
Screw terminals



**Terminals**  
Mantle terminals (EASY-PLUG)

# Connectors and sockets for industrial applications

## Connectors - IP66/IP67/IP69



### ■ OPTIMA-HD Series >> Connectors [HEAVY DUTY]

#### OPTIMA-HD Series

318.



Screw terminals

Current	Poles	Hz	Volt	Colour	h	CONNECTOR	CABLE GLAND
16A	2P+E	50Hz 60Hz	200-250V		6h	<b>318.1643.KX</b>	10/40
	3P+E		380-415V			<b>318.1646.KX</b>	10/40
	3P+N+E		346-415V			<b>318.1647.KX</b>	10/40
32A	2P+E		200-250V		3h	<b>318.3243.KX</b>	10/40
	3P+E		380-415V			<b>318.3246.KX</b>	10/40
	3P+N+E		380V 50Hz / 440V 60Hz			<b>318.32464.KX</b>	1/12
63A	3P+N+E	346-415V		6h	<b>318.3247.KX</b>	10/40	
	2P+E	200-250V			<b>318.6343.KX</b>	6/24	
	3P+E	380-415V			<b>318.6346.KX</b>	6/24	
125A	3P+N+E	346-415V		6h	<b>318.6347.KX</b>	6/24	
	2P+E	200-250V			<b>318.12543.KX</b>	1/8	
	3P+E	380-415V			<b>318.12546.KX</b>	1/8	
	3P+N+E	346-415V				<b>318.12547.KX</b>	1/8

- High impact resistance
- High heat and fire resistance



**CONVENTIONAL WIRING**  
Cage clamp connectors

1.2



# Connectors and sockets for industrial applications

## Connectors - IP66/IP67/IP69

### EUREKA Series >> Connectors

#### EUREKA Series

326.





 **Screw terminals**  
[Angled outlet]

CONNECTOR

IP66/IP67

CABLE GLAND

Poles	Hz	Volt	Colour	h	16A		32A	
					Part No.	10/100	Part No.	10/40
2P+E	50Hz 60Hz	100-130V		4h	<b>326.1640</b>	10/100	<b>326.3240</b>	10/40
		200-250V		6h	<b>326.1643</b>	10/100	<b>326.3243</b>	10/40
3P+E	50Hz 60Hz	380-415V		3h	<b>326.1646</b>	10/100	<b>326.3246</b>	10/40
		380V 50Hz / 440V 60Hz		3h	<b>326.1647</b>	10/50	<b>326.32464</b>	10/40
3P+N+E		346-415V		6h	<b>326.1647</b>	10/50	<b>326.3247</b>	10/40

1

INDUSTRY

2

3

4



**Terminals**  
Screw terminals



**Terminals**  
Mantle terminals (EASY-PLUG)

# Connectors and sockets for industrial applications

## Flush mounting socket outlets - IP44/IP54



### ■ OPTIMA Series >> Flush mounting socket outlets

#### OPTIMA Series

413.



**Screw terminals**  
[Angled outlet]



**Mantle terminals**  
[Angled outlet]

#### FLUSH-MOUNTING SOCKET

IP44/IP54

Poles	Hz	Volt	Colour	h	70x87mm			84x106mm			100x110mm		
					16A			32A			63A		
2P+E	50Hz 60Hz	100-130V	Yellow	4h	<b>413.1660</b>	10/100	<b>413.3260</b>	10/50	<b>413.6360</b>				
		200-250V	Blue	6h	<b>413.1663</b>	10/100	<b>413.3263</b>	10/50	<b>413.6363</b>	6/30			
		380-415V	Red	9h	<b>413.1668</b>	10/100	<b>413.3268</b>	10/50	<b>413.6368</b>				
		480-500V	Black	7h	<b>413.16636</b>	10/100	<b>413.32636</b>	10/50	<b>413.63636</b>				
		TST>50V	Grey	12h	<b>413.16633</b>	10/100	<b>413.32633</b>	10/50	<b>413.63633</b>				
	>300-500Hz	>50V	Green	2h	<b>413.16632</b>	10/100	<b>413.32632</b>	10/50	<b>413.63632</b>				
		DC	>50-250V	Grey	3h	<b>413.16634</b>	10/100	<b>413.32634</b>	10/50	<b>413.63634</b>			
			>250V	Grey	8h	<b>413.16638</b>	10/100	<b>413.32638</b>	10/50	<b>413.63638</b>			
	3P+E	50Hz 60Hz	100-130V	Yellow	4h	<b>413.1661</b>	10/100	<b>413.3261</b>	10/50	<b>413.6361</b>			
			200-250V	Blue	9h	<b>413.1664</b>	10/100	<b>413.3264</b>	10/50	<b>413.6364</b>	6/30		
380-415V			Red	6h	<b>413.1666</b>	10/100	<b>413.3266</b>	10/50	<b>413.6366</b>	6/30			
380V 50Hz / 440V 60Hz			Red	3h	<b>413.16664</b>	10/100	<b>413.32664</b>	10/50	<b>413.63664</b>				
480-500V			Black	7h	<b>413.16666</b>	10/100	<b>413.32666</b>	10/50	<b>413.63666</b>				
60Hz		600-690V	Black	5h	<b>413.16667</b>	10/100	<b>413.32667</b>	10/50	<b>413.63667</b>				
		440-460V	Red	11h	<b>413.16665</b>	10/100	<b>413.32665</b>	10/50	<b>413.63665</b>				
100-300Hz		>50V	Green	10h	<b>413.16661</b>	10/100	<b>413.32661</b>	10/50	<b>413.63661</b>				
>300-500Hz		>50V	Green	2h	<b>413.16662</b>	10/100	<b>413.32662</b>	10/50	<b>413.63662</b>				
3P+N+E		50Hz 60Hz	100-130V	Yellow	4h	<b>413.1662</b>	10/100	<b>413.3262</b>	10/50	<b>413.6362</b>	6/30		
	208-250V		Blue	9h	<b>413.1665</b>	10/100	<b>413.3265</b>	10/50	<b>413.6365</b>				
	346-415V		Red	6h	<b>413.1667</b>	10/100	<b>413.3267</b>	10/50	<b>413.6367</b>	6/30			
	380V 50Hz / 440V 60Hz		Red	3h	<b>413.16674</b>	10/100	<b>413.32674</b>	10/50	<b>413.63674</b>				
	480-500V		Black	7h	<b>413.16676</b>	10/100	<b>413.32676</b>	10/50	<b>413.63676</b>				
	60Hz	600-690V	Black	5h	<b>413.16677</b>	10/100	<b>413.32677</b>	10/50	<b>413.63677</b>				
		440-460V	Red	11h	<b>413.16675</b>	10/100	<b>413.32675</b>	10/50	<b>413.63675</b>				
	>300-500Hz	>50V	Green	2h	<b>413.16672</b>	10/100	<b>413.32672</b>	10/50	<b>413.63672</b>				

1.2



# Connectors and sockets for industrial applications

## Flush mounting socket outlets - IP44/IP54

### ■ OPTIMA Series >> Flush mounting socket outlets

OPTIMA Series

423.



























 **Mantle terminals**  
[Straight outlet]

FLUSH-MOUNTING SOCKET

IP44/IP54

100x110mm

Current	Poles	Hz	Volt	Colour	h		
63A	2P+E	50Hz 60Hz	100-130V		4h	<b>423.6360</b>	
			200-250V		6h	<b>423.6363</b> 6/30	
			380-415V		9h	<b>423.6368</b>	
			480-500V		7h	<b>423.63636</b>	
			TST>50V		12h	<b>423.63633</b>	
			>300-500Hz	>50V		2h	<b>423.63632</b>
	3P+E	50Hz 60Hz	>50-250V		3h	<b>423.63634</b>	
			>250V		8h	<b>423.63638</b>	
			100-130V		4h	<b>423.6361</b>	
			200-250V		9h	<b>423.6364</b>	
			380-415V		6h	<b>423.6366</b> 6/30	
			380V 50Hz / 440V 60Hz		3h	<b>423.63664</b>	
	3P+N+E	50Hz 60Hz	480-500V		7h	<b>423.63666</b>	
			600-690V		5h	<b>423.63667</b>	
			60Hz	440-460V		11h	<b>423.63665</b>
			100-300Hz	>50V		10h	<b>423.63661</b>
			>300-500Hz	>50V		2h	<b>423.63662</b>
			3P+N+E	50Hz 60Hz	100-130V		4h
208-250V		9h			<b>423.6365</b>		
346-415V		6h			<b>423.6367</b> 6/30		
380V 50Hz / 440V 60Hz		3h			<b>423.63674</b>		
480-500V		7h			<b>423.63676</b>		
600-690V		5h			<b>423.63677</b>		
60Hz	440-460V				11h	<b>423.63675</b>	
>300-500Hz	>50V				2h	<b>423.63672</b>	



**Terminals**  
Mantle terminals (EASY-PLUG)



**Terminals**  
Spring terminals (FAST WIRING)



# Connectors and sockets for industrial applications

## Flush mounting socket outlets - IP44/IP54



### ■ OPTIMA Series >> Flush mounting socket outlets

OPTIMA Series







413.



 **Spring terminals**  
[Angled outlet]

FLUSH-MOUNTING SOCKET

IP44/IP54

Poles	Hz	Volt	Colour	h	70x87mm		84x106mm	
					16A	32A	16A	32A
2P+E	50Hz 60Hz	100-130V		4h	<b>413.1660F</b>	10/100	<b>413.3260F</b>	10/50
		200-250V		6h	<b>413.1663F</b>	10/100	<b>413.3263F</b>	10/50
		380-415V		9h	<b>413.1668F</b>	10/100	<b>413.3268F</b>	10/50
3P+E	50Hz 60Hz	200-250V		9h	<b>413.1664F</b>	10/100	<b>413.3264F</b>	10/50
		380-415V		6h	<b>413.1666F</b>	10/100	<b>413.3266F</b>	10/50
3P+N+E		346-415V		6h	<b>413.1667F</b>	10/100	<b>413.3267F</b>	10/50



**FAST WIRING**  
Spring terminals

1.2



# Connectors and sockets for industrial applications

## Flush mounting socket outlets - IP44/IP54

### ■ OPTIMA Series >> Flush mounting sockets outlets [SAFE-IN]

OPTIMA Series

413.









 **Screw terminals**  
[Angled outlet]

FLUSH-MOUNTING SOCKET

IP44/IP54

70x87mm

16A

Poles	Hz	Volt	Colour	h		
2P+E	50Hz 60Hz	100-130V		4h	<b>413.1660H</b>	10/100
		200-250V		6h	<b>413.1663H</b>	10/100
		380-415V		9h	<b>413.1668H</b>	10/100
3P+E	50Hz 60Hz	200-250V		9h	<b>413.1664H</b>	10/100
		380-415V		6h	<b>413.1666H</b>	10/100
3P+N+E		346-415V		6h	<b>413.1667H</b>	10/100

 Sockets with "SAFE-IN" safety device



#### THE "SAFE-IN" SAFETY DEVICE

The "SAFE-IN" safety device assembled on the 16A industrial sockets works like the protection installed on household sockets, i.e., by means of an appropriate shutter, it closes the input of the socket contact tubes and prevents accidental and voluntary contact of live parts of the socket with slim objects, such as screwdrivers or wires. This protection offers an additional safety guarantee, in addition to that already provided by the spring-loaded cover assembled on the mobile sockets.



**Terminals**  
Screw terminals

# Connectors and sockets for industrial applications

## Flush mounting socket outlets - IP44/IP54



### EUREKA Series >> Flush / surface mounting socket outlets

#### EUREKA Series

452.



Screw terminals  
[90° angled outlet]

#### SOCKET OUTLET

IP44

70x87mm

PG 16

Poles	Hz	Volt	Colour	h	16A		32A	
					Part No.	10/100	Part No.	10/40
2P+E	50Hz 60Hz	100-130V	Yellow	4h	<b>452.1660</b>	10/100	<b>452.3260</b>	10/40
		200-250V	Blue	6h	<b>452.1663</b>	10/100	<b>452.3263</b>	10/40
		380-415V	Red	9h	<b>452.1668</b>	10/100	<b>452.3268</b>	10/40
		480-500V	Black	7h	<b>452.16636</b>		<b>452.32636</b>	
		TST>50V	Grey	12h	<b>452.16633</b>		<b>452.32633</b>	
	>300-500Hz	>50V	Green	2h	<b>452.16632</b>		<b>452.32632</b>	
	DC	>50-250V	Grey	3h	<b>452.16634</b>		<b>452.32634</b>	10/40
		>250V	Grey	8h	<b>452.16638</b>		<b>452.32638</b>	
3P+E	50Hz 60Hz	100-130V	Yellow	4h	<b>452.1661</b>	10/60	<b>452.3261</b>	10/40
		200-250V	Blue	9h	<b>452.1664</b>	10/60	<b>452.3264</b>	10/40
		380-415V	Red	6h	<b>452.1666</b>	10/60	<b>452.3266</b>	10/40
		380V 50Hz / 440V 60Hz	Red	3h	<b>452.16664</b>		<b>452.32664</b>	10/40
		480-500V	Black	7h	<b>452.16666</b>		<b>452.32666</b>	
	60Hz	440-460V	Red	11h	<b>452.16665</b>		<b>452.32665</b>	10/40
	100-300Hz	>50V	Green	10h	<b>452.16661</b>	10/60	<b>452.32661</b>	
	>300-500Hz	>50V	Green	2h	<b>452.16662</b>		<b>452.32662</b>	
3P+N+E	50Hz 60Hz	100-130V	Yellow	4h	<b>452.1662</b>	10/60	<b>452.3262</b>	10/40
		208-250V	Blue	9h	<b>452.1665</b>	10/60	<b>452.3265</b>	10/40
		346-415V	Red	6h	<b>452.1667</b>	10/60	<b>452.3267</b>	10/40
		380V 50Hz / 440V 60Hz	Red	3h	<b>452.16674</b>		<b>452.32674</b>	10
		480-500V	Black	7h	<b>452.16676</b>		<b>452.32676</b>	10
	60Hz	440-460V	Red	11h	<b>452.16675</b>		<b>452.32675</b>	10
	>300-500Hz	>50V	Green	2h	<b>452.16672</b>	10/60	<b>452.32672</b>	10

1.2



# Connectors and sockets for industrial applications

## Flush mounting socket outlets - IP44/IP54

### EUREKA Series >> Flush mounting socket outlets

#### EUREKA Series

422.



Screw terminals  
[Straight outlet]

Screw terminals  
[Straight outlet]

#### FLUSH-MOUNTING SOCKET

IP44

62x62mm

75x75mm

Poles	Hz	Volt	Colour	h	16A		32A			
					62x62mm	75x75mm	62x62mm	75x75mm		
2P+E	50Hz 60Hz	100-130V	Yellow	4h	<b>422.1660/R</b>	10/100	<b>422.1660</b>	10/100	<b>422.3260</b>	10/50
		200-250V	Blue	6h	<b>422.1663/R</b>	10/100	<b>422.1663</b>	10/100	<b>422.3263</b>	10/50
		380-415V	Red	9h	<b>422.1668/R</b>	10/100	<b>422.1668</b>	10/100	<b>422.3268</b>	10/50
		480-500V	Black	7h			<b>422.16636</b>	10/100	<b>422.32636</b>	10/50
		TST>50V	Grey	12h			<b>422.16633</b>	10/100	<b>422.32633</b>	10/50
	>300-500Hz	>50V	Green	2h			<b>422.16632</b>	10/100	<b>422.32632</b>	10/50
	DC	>50-250V	Grey	3h			<b>422.16634</b>	10/100	<b>422.32634</b>	10/50
		>250V	Grey	8h			<b>422.16638</b>	10/100	<b>422.32638</b>	10/50
3P+E	50Hz 60Hz	100-130V	Yellow	4h			<b>422.1661</b>	10/100	<b>422.3261</b>	10/50
		200-250V	Blue	9h			<b>422.1664</b>	10/100	<b>422.3264</b>	10/50
		380-415V	Red	6h			<b>422.1666</b>	10/100	<b>422.3266</b>	10/50
		380V 50Hz / 440V 60Hz	Red	3h			<b>422.16664</b>	10/100	<b>422.32664</b>	10/50
		480-500V	Black	7h			<b>422.16666</b>	10/100	<b>422.32666</b>	10/50
	600-690V	Black	5h			<b>422.16667</b>	10/100	<b>422.32667</b>	10/50	
	60Hz	440-460V	Red	11h			<b>422.16665</b>	10/100	<b>422.32665</b>	10/50
	100-300Hz	>50V	Green	10h			<b>422.16661</b>	10/100	<b>422.32661</b>	10/50
	>300-500Hz	>50V	Green	2h			<b>422.16662</b>	10/100	<b>422.32662</b>	10/50
3P+N+E	50Hz 60Hz	100-130V	Yellow	4h			<b>422.1662</b>	10/100	<b>422.3262</b>	10/50
		208-250V	Blue	9h			<b>422.1665</b>	10/100	<b>422.3265</b>	10/50
		346-415V	Red	6h			<b>422.1667</b>	10/100	<b>422.3267</b>	10/50
		380V 50Hz / 440V 60Hz	Red	3h			<b>422.16674</b>	10/100	<b>422.32674</b>	10/50
		480-500V	Black	7h			<b>422.16676</b>	10/100	<b>422.32676</b>	10/50
	600-690V	Black	5h			<b>422.16677</b>	10/100	<b>422.32677</b>	10/50	
	60Hz	440-460V	Red	11h			<b>422.16675</b>	10/100	<b>422.32675</b>	10/50
	>300-500Hz	>50V	Green	2h			<b>422.16672</b>	10/100	<b>422.32672</b>	10/50



**Terminals**  
Screw terminals

# Connectors and sockets for industrial applications

## Flush mounting socket outlets - IP66/IP67/IP69



### ■ OPTIMA Series >> Flush mounting socket outlets

#### OPTIMA Series

418.



Screw terminals  
[Angled outlet]

#### FLUSH-MOUNTING SOCKET

IP66/IP67/IP69

Poles	Hz	Volt	Colour	h	70x87mm		84x106mm		
					16A		32A		
2P+E	50Hz 60Hz	100-130V		4h	<b>418.1660</b>	10/100	<b>418.3260</b>	10/50	
		200-250V		6h	<b>418.1663</b>	10/100	<b>418.3263</b>	10/50	
		380-415V		9h	<b>418.1668</b>	10/100	<b>418.3268</b>	10/50	
		480-500V		7h	<b>418.16636</b>	10/100	<b>418.32636</b>	10/50	
		TST>50V		12h	<b>418.16633</b>	10/100	<b>418.32633</b>	10/50	
	>300-500Hz	>50V		2h	<b>418.16632</b>	10/100	<b>418.32632</b>	10/50	
	DC	>50-250V		3h	<b>418.16634</b>	10/100	<b>418.32634</b>	10/50	
		>250V		8h	<b>418.16638</b>	10/100	<b>418.32638</b>	10/50	
	3P+E	50Hz 60Hz	100-130V		4h	<b>418.1661</b>	10/100	<b>418.3261</b>	10/50
			200-250V		9h	<b>418.1664</b>	10/100	<b>418.3264</b>	10/50
380-415V				6h	<b>418.1666</b>	10/100	<b>418.3266</b>	10/50	
380V 50Hz / 440V 60Hz				3h	<b>418.16664</b>	10/100	<b>418.32664</b>	10/50	
480-500V				7h	<b>418.16666</b>	10/100	<b>418.32666</b>	10/50	
60-690V			5h	<b>418.16667</b>	10/100	<b>418.32667</b>	10/50		
60Hz		440-460V		11h	<b>418.16665</b>	10/100	<b>418.32665</b>	10/50	
100-300Hz		>50V		10h	<b>418.16661</b>	10/100	<b>418.32661</b>	10/50	
>300-500Hz		>50V		2h	<b>418.16662</b>	10/100	<b>418.32662</b>	10/50	
3P+N+E		50Hz 60Hz	100-130V		4h	<b>418.1662</b>	10/100		
	208-250V			9h	<b>418.1665</b>	10/100	<b>418.3265</b>	10/50	
	346-415V			6h	<b>418.1667</b>	10/100	<b>418.3267</b>	10/50	
	380V 50Hz / 440V 60Hz			3h	<b>418.16674</b>	10/100	<b>418.32674</b>	10/50	
	480-500V			7h	<b>418.16676</b>	10/100	<b>418.32676</b>	10/50	
	600-690V		5h	<b>418.16677</b>	10/100	<b>418.32677</b>	10/50		
	60Hz	440-460V		11h	<b>418.16675</b>	10/100	<b>418.32675</b>	10/50	
	>300-500Hz	>50V		2h	<b>418.16672</b>	10/100	<b>418.32672</b>	10/50	

1.2



# Connectors and sockets for industrial applications

## Flush mounting socket outlets - IP66/IP67/IP69

### OPTIMA Series >> Flush mounting socket outlets

























OPTIMA Series

418.



 **Mantle terminals**  
[Angled outlet]

FLUSH-MOUNTING SOCKET  
IP66/IP67/IP69

Poles	Hz	Volt	Colour	h	FLUSH-MOUNTING SOCKET				
					100x110mm		114x114mm		
					63A		125A		
2P+E	50Hz 60Hz	100-130V		4h	<b>418.6360</b>	6/30	<b>418.12560</b>	1/10	
		200-250V		6h	<b>418.6363</b>	6/30	<b>418.12563</b>	1/10	
		380-415V		9h	<b>418.6368</b>	6/30	<b>418.12568</b>	1/10	
		480-500V		7h	<b>418.63636</b>	6/30	<b>418.125636</b>	1/10	
		TST>50V		12h	<b>418.63633</b>	6/30	<b>418.125633</b>	1/10	
	DC	>300-500Hz	>50V		2h	<b>418.63632</b>	6/30	<b>418.125632</b>	1/10
		>50-250V		3h	<b>418.63634</b>	6/30	<b>418.125634</b>	1/10	
		>250V		8h	<b>418.63638</b>	6/30	<b>418.125638</b>	1/10	
3P+E	50Hz 60Hz	100-130V		4h	<b>418.6361</b>	6/30	<b>418.12561</b>	1/10	
		200-250V		9h	<b>418.6364</b>	6/30	<b>418.12564</b>	1/10	
		380-415V		6h	<b>418.6366</b>	6/30	<b>418.12566</b>	1/10	
		380V 50Hz / 440V 60Hz		3h	<b>418.63664</b>	6/30	<b>418.125664</b>	1/10	
		480-500V		7h	<b>418.63666</b>	6/30	<b>418.125666</b>	1/10	
	60Hz	600-690V		5h	<b>418.63667</b>	6/30	<b>418.125667</b>	1/10	
		440-460V		11h	<b>418.63665</b>	6/30	<b>418.125665</b>	1/10	
		100-300Hz	>50V		10h	<b>418.63661</b>	6/30	<b>418.125661</b>	1/10
>300-500Hz	>50V		2h	<b>418.63662</b>	6/30	<b>418.125662</b>	1/10		
3P+N+E	50Hz 60Hz	100-130V		4h	<b>418.6362</b>	6/30	<b>418.12562</b>	1/10	
		208-250V		9h	<b>418.6365</b>	6/30	<b>418.12565</b>	1/10	
		346-415V		6h	<b>418.6367</b>	6/30	<b>418.12567</b>	1/10	
		380V 50Hz / 440V 60Hz		3h	<b>418.63674</b>	6/30	<b>418.125674</b>	1/10	
		480-500V		7h	<b>418.63676</b>	6/30	<b>418.125676</b>	1/10	
	60Hz	600-690V		5h	<b>418.63677</b>	6/30	<b>418.125677</b>	1/10	
		440-460V		11h	<b>418.63675</b>	6/30	<b>418.125675</b>	1/10	
		>300-500Hz	>50V		2h	<b>418.63672</b>	6/30	<b>418.125672</b>	1/10



**Terminals**  
Mantle terminals (EASY-PLUG)

# Connectors and sockets for industrial applications

## Flush mounting socket outlets - IP66/IP67/IP69



### ■ OPTIMA Series >> Flush mounting socket outlets

OPTIMA Series

428.



Mantle terminals  
[Straight outlet]

FLUSH-MOUNTING SOCKET

IP66/IP67/IP69

Poles	Hz	Volt	Colour	h	100x110mm		114x114mm		
					63A		125A		
2P+E	50Hz 60Hz	100-130V		4h	<b>428.6360</b>	6/30	<b>428.12560</b>	1/10	
		200-250V		6h	<b>428.6363</b>	6/30	<b>428.12563</b>	1/10	
		380-415V		9h	<b>428.6368</b>	6/30	<b>428.12568</b>	1/10	
		480-500V		7h	<b>428.63636</b>	6/30	<b>428.125636</b>	1/10	
		TST>50V		12h	<b>428.63633</b>	6/30	<b>428.125633</b>	1/10	
	>300-500Hz	>50V		2h	<b>428.63632</b>	6/30	<b>428.125632</b>	1/10	
		DC	>50-250V		3h	<b>428.63634</b>	6/30	<b>428.125634</b>	1/10
	>250V			8h	<b>428.63638</b>	6/30	<b>428.125638</b>	1/10	
	3P+E	50Hz 60Hz	100-130V		4h	<b>428.6361</b>	6/30	<b>428.12561</b>	1/10
			200-250V		9h	<b>428.6364</b>	6/30	<b>428.12564</b>	1/10
380-415V				6h	<b>428.6366</b>	6/30	<b>428.12566</b>	1/10	
380V 50Hz / 440V 60Hz				3h	<b>428.63664</b>	6/30	<b>428.125664</b>	1/10	
480-500V				7h	<b>428.63666</b>	6/30	<b>428.125666</b>	1/10	
60Hz		600-690V		5h	<b>428.63667</b>	6/30	<b>428.125667</b>	1/10	
		440-460V		11h	<b>428.63665</b>	6/30	<b>428.125665</b>	1/10	
100-300Hz		>50V		10h	<b>428.63661</b>	6/30	<b>428.125661</b>	1/10	
>300-500Hz		>50V		2h	<b>428.63662</b>	6/30	<b>428.125662</b>	1/10	
3P+N+E		50Hz 60Hz	100-130V		4h	<b>428.6362</b>	6/30	<b>428.12562</b>	1/10
	208-250V			9h	<b>428.6365</b>	6/30	<b>428.12565</b>	1/10	
	346-415V			6h	<b>428.6367</b>	6/30	<b>428.12567</b>	1/10	
	380V 50Hz / 440V 60Hz			3h	<b>428.63674</b>	6/30	<b>428.125674</b>	1/10	
	480-500V			7h	<b>428.63676</b>	6/30	<b>428.125676</b>	1/10	
	60Hz	600-690V		5h	<b>428.63677</b>	6/30	<b>428.125677</b>	1/10	
		440-460V		11h	<b>428.63675</b>	6/30	<b>428.125675</b>	1/10	
	>300-500Hz	>50V		2h	<b>428.63672</b>	6/30	<b>428.125672</b>	1/10	

1.2



# Connectors and sockets for industrial applications

## Flush mounting socket outlets - IP66/IP67/IP69

### ■ OPTIMA Series >> Flush mounting socket outlets

OPTIMA Series







418.



 **Spring terminals**  
[Angled outlet]

FLUSH-MOUNTING SOCKET

IP66/IP67/IP69

Poles	Hz	Volt	Colour	h	70x87mm		84x106mm	
					16A		32A	
					Part No.	10/100	Part No.	10/50
2P+E	50Hz 60Hz	100-130V		4h	<b>418.1660F</b>	10/100	<b>418.3260F</b>	10/50
		200-250V		6h	<b>418.1663F</b>	10/100	<b>418.3263F</b>	10/50
		380-415V		9h	<b>418.1668F</b>	10/100	<b>418.3268F</b>	10/50
3P+E	50Hz 60Hz	200-250V		9h	<b>418.1664F</b>	10/100	<b>418.3264F</b>	10/50
		380-415V		6h	<b>418.1666F</b>	10/100	<b>418.3266F</b>	10/50
3P+N+E		346-415V		6h	<b>418.1667F</b>	10/100	<b>418.3267F</b>	10/50



**Terminals**  
Spring terminals (FAST WIRING)



**Terminals**  
Screw terminals



# Connectors and sockets for industrial applications

## Flush mounting socket outlets - IP66/IP67/IP69



### ■ OPTIMA Series >> Flush mounting sockets outlets [SAFE-IN]

OPTIMA Series

418.



**Screw terminals**  
[Angled outlet]

FLUSH-MOUNTING SOCKET

IP66/IP67/IP69

70x87mm

16A

Poles	Hz	Volt	Colour	h		
2P+E	50Hz 60Hz	100-130V		4h	<b>418.1660H</b>	10/100
		200-250V		6h	<b>418.1663H</b>	10/100
		380-415V		9h	<b>418.1668H</b>	10/100
3P+E	50Hz 60Hz	200-250V		6h	<b>418.1664H</b>	10/100
		380-415V		6h	<b>418.1666H</b>	10/100
3P+N+E		346-415V		6h	<b>418.1667H</b>	10/100

☉ Sockets with "SAFE-IN" safety device

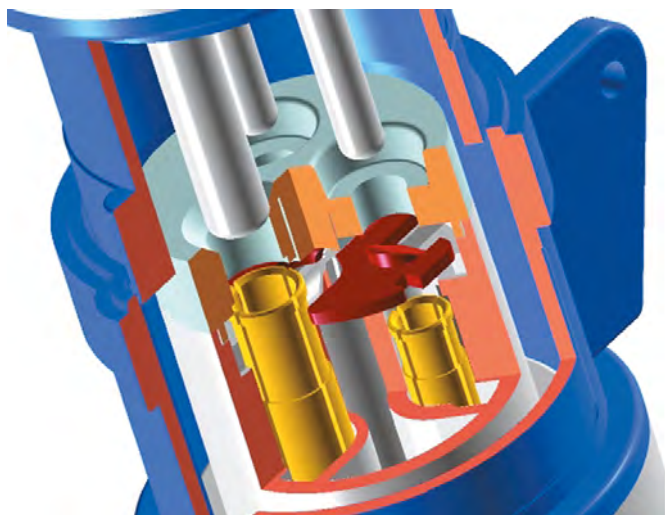

#### SAFE-IN

Connector tube protective shutter for increased safety against direct contacts. (The SAFE-IN safety device).

1.2



# Connectors and sockets for industrial applications

## Flush mounting socket outlets - IP66/IP67/IP69

### EUREKA Series >> Flush / surface mounting socket outlets

EUREKA Series

457.









 **Screw terminals**  
[90° angled outlet]

SOCKET OUTLET

IP66/IP67

70x87mm

PG 16

Poles	Hz	Volt	Colour	h	16A		32A	
					Part No.	10/60	Part No.	10/40
2P+E	50Hz 60Hz	100-130V		4h	<b>457.1660</b>	10/60	<b>457.3260</b>	10/40
		200-250V		6h	<b>457.1663</b>	10/60	<b>457.3263</b>	10/40
		380-415V		9h	<b>457.1668</b>	10/60	<b>457.3268</b>	10/40
		480-500V		7h	<b>457.16636</b>		<b>457.32636</b>	10/40
		TST>50V		12h	<b>457.16633</b>		<b>457.32633</b>	
	>300-500Hz	>50V		2h	<b>457.16632</b>		<b>457.32632</b>	
	DC	>50-250V		3h	<b>457.16634</b>		<b>457.32634</b>	10/40
		>250V		8h	<b>457.16638</b>		<b>457.32638</b>	
3P+E	50Hz 60Hz	100-130V		4h	<b>457.1661</b>	10/50	<b>457.3261</b>	10/40
		200-250V		9h	<b>457.1664</b>	10/50	<b>457.3264</b>	10/40
		380-415V		6h	<b>457.1666</b>	10/50	<b>457.3266</b>	10/40
		380V 50Hz / 440V 60Hz		3h	<b>457.16664</b>		<b>457.32664</b>	10/40
		480-500V		7h	<b>457.16666</b>	10/50	<b>457.32666</b>	10/40
		600-690V		5h	<b>457.16667</b>		<b>457.32667</b>	
	60Hz	440-460V		11h	<b>457.16665</b>		<b>457.32665</b>	
	100-300Hz	>50V		10h	<b>457.16661</b>	10/50	<b>457.32661</b>	
	>300-500Hz	>50V		2h	<b>457.16662</b>		<b>457.32662</b>	
	3P+N+E	50Hz 60Hz	100-130V		4h	<b>457.1662</b>	10/50	<b>457.3262</b>
208-250V				9h	<b>457.1665</b>	10/50	<b>457.3265</b>	10/40
346-415V				6h	<b>457.1667</b>	10/50	<b>457.3267</b>	10/40
380V 50Hz / 440V 60Hz				3h	<b>457.16674</b>	10/50	<b>457.32674</b>	10/40
480-500V				7h	<b>457.16676</b>		<b>457.32676</b>	10
600-690V				5h	<b>457.16677</b>		<b>457.32677</b>	10/40
60Hz		440-460V		11h	<b>457.16675</b>		<b>457.32675</b>	10/40
>300-500Hz		>50V		2h	<b>457.16672</b>		<b>457.32672</b>	10



**Terminals**  
Screw terminals

# Connectors and sockets for industrial applications

## Flush mounting socket outlets - IP66/IP67/IP69



### EUREKA Series >> Flush mounting socket outlets

EUREKA Series

427.



Screw terminals  
[Straight outlet]

FLUSH-MOUNTING SOCKET

IP66/IP67

75x75mm

Poles	Hz	Volt	Colour	h	16A		32A		
					Part No.	10/100	Part No.	10/50	
2P+E	50Hz 60Hz	100-130V	Yellow	4h	<b>427.1660</b>	10/100	<b>427.3260</b>	10/50	
		200-250V	Blue	6h	<b>427.1663</b>	10/100	<b>427.3263</b>	10/50	
		380-415V	Red	9h	<b>427.1668</b>	10/100	<b>427.3268</b>	10/50	
		480-500V	Black	7h	<b>427.16636</b>	10/100	<b>427.32636</b>	10/50	
		TST>50V	Grey	12h	<b>427.16633</b>	10/100	<b>427.32633</b>	10/50	
	>300-500Hz	>50V	Green	2h	<b>427.16632</b>	10/100	<b>427.32632</b>	10/50	
	DC	>50-250V	Grey	3h	<b>427.16634</b>	10/100	<b>427.32634</b>	10/50	
		>250V	Grey	8h	<b>427.16638</b>	10/100	<b>427.32638</b>	10/50	
	3P+E	50Hz 60Hz	100-130V	Yellow	4h	<b>427.1661</b>	10/100	<b>427.3261</b>	10/50
			200-250V	Blue	9h	<b>427.1664</b>	10/100	<b>427.3264</b>	10/50
380-415V			Red	6h	<b>427.1666</b>	10/100	<b>427.3266</b>	10/50	
380V 50Hz / 440V 60Hz			Red	3h	<b>427.16664</b>	10/100	<b>427.32664</b>	10/50	
480-500V			Black	7h	<b>427.16666</b>	10/100	<b>427.32666</b>	10/50	
60-690V		Black	5h	<b>427.16667</b>	10/100	<b>427.32667</b>	10/50		
60Hz		440-460V	Red	11h	<b>427.16665</b>	10/100	<b>427.32665</b>	10/50	
100-300Hz		>50V	Green	10h	<b>427.16661</b>	10/100	<b>427.32661</b>	10/50	
>300-500Hz		>50V	Green	2h	<b>427.16662</b>	10/100	<b>427.32662</b>	10/50	
3P+N+E		50Hz 60Hz	100-130V	Yellow	4h	<b>427.1662</b>	10/100	<b>427.3262</b>	10/50
	208-250V		Blue	9h	<b>427.1665</b>	10/100	<b>427.3265</b>	10/50	
	346-415V		Red	6h	<b>427.1667</b>	10/100	<b>427.3267</b>	10/50	
	380V 50Hz / 440V 60Hz		Red	3h	<b>427.16674</b>	10/100	<b>427.32674</b>	10/50	
	480-500V		Black	7h	<b>427.16676</b>	10/100	<b>427.32676</b>	10/50	
	600-690V	Black	5h	<b>427.16677</b>	10/100	<b>427.32677</b>	10/50		
	60Hz	440-460V	Red	11h	<b>427.16675</b>	10/100	<b>427.32675</b>	10/50	
	>300-500Hz	>50V	Green	2h	<b>427.16672</b>	10/100	<b>427.32672</b>	10/50	

1.2



# Connectors and sockets for industrial applications

## Surface mounting socket outlets - IP44/IP54

### ■ OPTIMA Series >> Surface mounting socket outlets

#### OPTIMA-BASE Series

513.



 **BASE - Screw terminals**

#### SURFACE MOUNTING SOCKET

IP44/IP54



M20X1,5

M25X1,5

M32X1,5

16A

32A

Poles	Hz	Volt	Colour	h	M20X1,5	M25X1,5	M32X1,5		
2P+E	50Hz 60Hz	100-130V		4h	<b>513.1650</b>	10/40	<b>513.3250</b>	10	
		200-250V			<b>513.1653</b>	10/40	<b>513.3253</b>	10	
3P+E	50Hz 60Hz	380-415V		6h		<b>513.1656</b>	10/40	<b>513.3256</b>	10
3P+N+E		346-415V			<b>513.1657</b>	10/40	<b>513.3257</b>	10	

- Open threaded cable entry
- Threaded cap/cable sleeve included

1

INDUSTRY

2

3

4



**Terminals**  
Screw terminals

# Connectors and sockets for industrial applications

## Surface mounting socket outlets - IP44/IP54



### ■ OPTIMA Series >> Surface mounting socket outlets

#### OPTIMA-TOP Series

513.



TOP - Screw terminals

#### SURFACE MOUNTING SOCKET

IP44

Poles	Hz	Volt	Colour	h	SURFACE MOUNTING SOCKET					
					M20X1,5		M32X1,5			
					16A		32A			
2P+E	50Hz 60Hz	100-130V		4h	<b>513.1650T</b>	10/40	<b>513.3250T</b>	10		
		200-250V		6h	<b>513.1653T</b>	10/40	<b>513.3253T</b>	10		
		380-415V		9h	<b>513.1658T</b>	10/40	<b>513.3258T</b>	10		
		480-500V		7h	<b>513.16536T</b>	10/40	<b>513.32536T</b>	10		
		TST>50V		12h	<b>513.16533T</b>	10/40	<b>513.32533T</b>	10		
	DC	>300-500Hz	>50V		2h	<b>513.16532T</b>	10/40	<b>513.32532T</b>	10	
		>50-250V		3h	<b>513.16534T</b>	10/40	<b>513.32534T</b>	10		
			>250V		8h	<b>513.16538T</b>	10/40	<b>513.32538T</b>	10	
	3P+E	50Hz 60Hz	100-130V		4h		<b>513.1651T</b>	10/40	<b>513.3251T</b>	10
			200-250V		9h		<b>513.1654T</b>	10/40	<b>513.3254T</b>	10
380-415V				6h		<b>513.1656T</b>	10/40	<b>513.3256T</b>	10	
380V 50Hz / 440V 60Hz				3h		<b>513.16564T</b>	10/40	<b>513.32564T</b>	10	
480-500V				7h		<b>513.16566T</b>	10/40	<b>513.32566T</b>	10	
60Hz		600-690V		5h		<b>513.16567T</b>	10/40	<b>513.32567T</b>	10	
		440-460V		11h		<b>513.16565T</b>	10/40	<b>513.32565T</b>	10	
		100-300Hz	>50V		10h		<b>513.16561T</b>	10/40	<b>513.32561T</b>	10
		>300-500Hz	>50V		2h		<b>513.16562T</b>	10/40	<b>513.32562T</b>	10
		100-130V		4h		<b>513.1652T</b>	10/40	<b>513.3252T</b>	10	
3P+N+E	50Hz 60Hz	208-250V		9h		<b>513.1655T</b>	10/40	<b>513.3255T</b>	10	
		346-415V		6h		<b>513.1657T</b>	10/40	<b>513.3257T</b>	10	
		380V 50Hz / 440V 60Hz		3h		<b>513.16574T</b>	10/40	<b>513.32574T</b>	10	
		480-500V		7h		<b>513.16576T</b>	10/40	<b>513.32576T</b>	10	
	60Hz	600-690V		5h		<b>513.16577T</b>	10/40	<b>513.32577T</b>	10	
		440-460V		11h		<b>513.16575T</b>	10/40	<b>513.32575T</b>	10	
		>300-500Hz	>50V		2h		<b>513.16572T</b>	10/40	<b>513.32572T</b>	10

- Threaded break-through knock out
- Rubber threaded cable sleeve included

1.2



# Connectors and sockets for industrial applications

## Surface mounting socket outlets - IP44/IP54

### ■ OPTIMA Series >> Surface mounting socket outlets

OPTIMA-TOP Series

513.



 **TOP - Spring terminals**

SURFACE MOUNTING SOCKET

IP44/IP54

M20X1,5

M25X1,5

M32X1,5

16A

32A

Poles	Hz	Volt	Colour	h	M20X1,5		M25X1,5		M32X1,5	
2P+E	50Hz 60Hz	100-130V	Yellow	4h	<b>513.1650TF</b>	10/40			<b>513.3250TF</b>	10
		200-250V	Blue	6h	<b>513.1653TF</b>	10/40			<b>513.3253TF</b>	10
		380-415V	Red	9h	<b>513.1658TF</b>	10/40			<b>513.3258TF</b>	10
3P+E	50Hz 60Hz	200-250V	Blue				<b>513.1654TF</b>	10/40	<b>513.3254TF</b>	10
		380-415V	Red	6h			<b>513.1656TF</b>	10/40	<b>513.3256TF</b>	10
3P+N+E		346-415V	Red				<b>513.1657TF</b>	10/40	<b>513.3257TF</b>	10

- Threaded break-through knock out
- Rubber threaded cable sleeve included

1  
INDUSTRY

2

3

4



**Terminals**  
Spring terminals (FAST WIRING)



**Terminals**  
Mantle terminals (EASY-PLUG)

# Connectors and sockets for industrial applications

## Surface mounting socket outlets - IP44/IP54



### ■ OPTIMA Series >> Surface mounting socket outlets

#### OPTIMA-TOP Series

513.



TOP - Mantle terminals

SURFACE MOUNTING SOCKET

IP44

M40X1,5

63A

Poles	Hz	Volt	Colour	h	Product Code	Quantity	
2P+E	50Hz 60Hz	100-130V	Yellow	4h	513.6350T	4	
		200-250V	Blue	6h	513.6353T	4	
		380-415V	Red	9h	513.6358T	4	
		480-500V	Black	7h	513.63536T		
		TST>50V	Grey	12h	513.63533T		
	>300-500Hz	>50V	Green	2h	513.63532T		
	DC	>50-250V	Grey	3h	513.63534T		
		>250V	Grey	8h	513.63538T		
	3P+E	50Hz 60Hz	100-130V	Yellow	4h	513.6351T	4
			200-250V	Blue	9h	513.6354T	4
380-415V			Red	6h	513.6356T	4	
380V 50Hz / 440V 60Hz			Black	3h	513.63564T		
480-500V			Black	7h	513.63566T		
600-690V		Red	5h	513.63567T			
60Hz		440-460V	Red	11h	513.63565T		
100-300Hz		>50V	Green	10h	513.63561T		
>300-500Hz		>50V	Green	2h	513.63562T		
3P+N+E		50Hz 60Hz	100-130V	Yellow	4h	513.6352T	4
	208-250V		Blue	9h	513.6355T	4	
	346-415V		Red	6h	513.6357T	4	
	380V 50Hz / 440V 60Hz		Black	3h	513.63574T		
	480-500V		Black	7h	513.63576T		
	600-690V	Red	5h	513.63577T			
	60Hz	440-460V	Red	11h	513.63575T		
	>300-500Hz	>50V	Green	2h	513.63572T		

- Open threaded cable entry
- Cable gland included

1.2



# Connectors and sockets for industrial applications

## Surface mounting socket outlets - IP44/IP54

### ■ OPTIMA Series >> Surface mounting socket outlets

#### OPTIMA-TOP Series

513.









 **TOP - Screw terminals [SAFE-IN]**

#### SURFACE MOUNTING SOCKET

IP44/IP54

M20X1,5

M25X1,5

Poles	Hz	Volt	Colour	h	16A	
2P+E	50Hz 60Hz	100-130V		4h	<b>513.1650TH</b>	10/40
		200-250V		6h	<b>513.1653TH</b>	10/40
		380-415V		9h	<b>513.1658TH</b>	10/40
3P+E	50Hz 60Hz	200-250V				<b>513.1654TH</b> 10/40
		380-415V				<b>513.1656TH</b> 10/40
3P+N+E		346-415V		6h		<b>513.1657TH</b> 10/40

 Sockets with "SAFE-IN" safety device

- Threaded break-through knock out
- Rubber threaded cable sleeve included

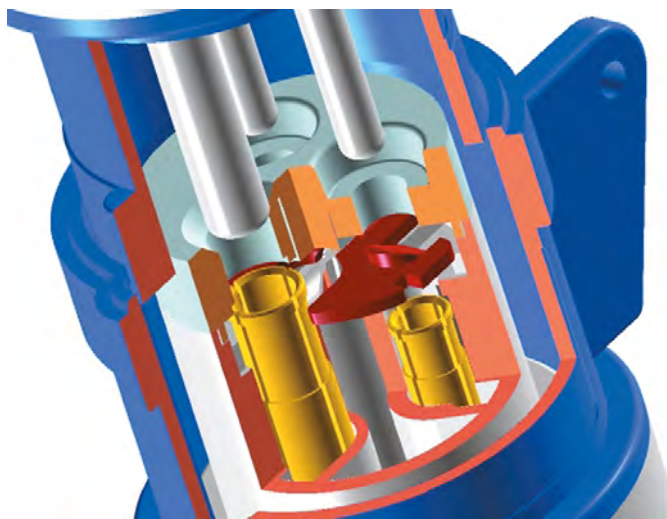

#### SAFE-IN

Connector tube protective shutter for increased safety against direct contacts. (The SAFE-IN safety device).



**Terminals**  
Screw terminals



**FRENCH STANDARD 16A**  
Shuttered socket



**FRENCH-GERMAN STANDARD 16A**  
Shuttered socket



**ITALIAN STANDARD P30 - 16A**  
Shuttered socket CEI 23-50



**PLURISTANDARD P40 16A**  
Shuttered socket



**BRITISH STANDARD 13A**  
Shuttered socket BS 1363-2



**ARGENTINIAN STANDARD 10A**  
Unshuttered socket



**BRAZILIAN STANDARD 10A**  
Unshuttered socket ABNT NBR 14136:2002



# Connectors and sockets for industrial applications

## Surface mounting socket outlets - IP44/IP54



### ■ OPTIMA Series >> Surface mounting socket outlets

#### OPTIMA-COMBI Series

513.



COMBI - Screw terminals

#### SURFACE MOUNTING SOCKET

IP44/IP54

M32X1,5

Poles	Hz	Volt	Colour	h	Version	16A		32A	
						Model	Quantity	Model	Quantity
2P+E	200-250V	■	■	5h	FRENCH	<b>513.1653-FN</b>	10	<b>513.3253-FF</b> <sup>1</sup>	10
					GERMAN	<b>513.1653-DN</b>	10	<b>513.3253-DF</b> <sup>1</sup>	10
					ITALIAN P30	<b>513.1653-PN</b>	10	<b>513.3253-PF</b> <sup>1</sup>	10
					ITALIAN P40	<b>513.1653-LN</b>	10	<b>513.3253-LF</b> <sup>1</sup>	10
					BRITISH BS1363	<b>513.1653-BN</b> <sup>1</sup>	10	<b>513.3253-BF</b> <sup>1</sup>	10
					ARGENTINE	<b>513.1653-AF</b> <sup>1</sup>	10	<b>513.3253-AF</b> <sup>1</sup>	10
					BRAZILIAN	<b>513.1653-CF</b> <sup>1</sup>	10	<b>513.3253-CF</b> <sup>1</sup>	10
					DANISH	<b>513.1653-KN</b>	10	<b>513.3253-KF</b> <sup>1</sup>	10
					FRENCH	<b>513.1656-FN</b>	10	<b>513.3256-FF</b> <sup>1</sup>	10
					GERMAN	<b>513.1656-DN</b>	10	<b>513.3256-DF</b> <sup>1</sup>	10
					ITALIAN P30	<b>513.1656-PN</b>	10	<b>513.3256-PF</b> <sup>1</sup>	10
					ITALIAN P40	<b>513.1656-LN</b>	10	<b>513.3256-LF</b> <sup>1</sup>	10
					BRITISH BS1363	<b>513.1656-BN</b> <sup>1</sup>	10	<b>513.3256-BF</b> <sup>1</sup>	10
					ARGENTINE	<b>513.1656-AF</b> <sup>1</sup>	10	<b>513.3256-AF</b> <sup>1</sup>	10
BRAZILIAN	<b>513.1656-CF</b> <sup>1</sup>	10	<b>513.3256-CF</b> <sup>1</sup>	10					
3P+E	50Hz 60Hz	■	■	6h	DANISH	<b>513.1656-KN</b>	10	<b>513.3256-KF</b> <sup>1</sup>	10
					FRENCH	<b>513.1657-FN</b>	10	<b>513.3257-FF</b> <sup>1</sup>	10
					GERMAN	<b>513.1657-DN</b>	10	<b>513.3257-DF</b> <sup>1</sup>	10
					ITALIAN P30	<b>513.1657-PN</b>	10	<b>513.3257-PF</b> <sup>1</sup>	10
					ITALIAN P40	<b>513.1657-LN</b>	10	<b>513.3257-LF</b> <sup>1</sup>	10
					BRITISH BS1363	<b>513.1657-BN</b> <sup>1</sup>	10	<b>513.3257-BF</b> <sup>1</sup>	10
					ARGENTINE	<b>513.1657-AF</b> <sup>1</sup>	10	<b>513.3257-AF</b> <sup>1</sup>	10
					BRAZILIAN	<b>513.1657-CF</b> <sup>1</sup>	10	<b>513.3257-CF</b> <sup>1</sup>	10
					DANISH	<b>513.1657-KN</b>	10	<b>513.3257-KF</b> <sup>1</sup>	10
					FRENCH	<b>513.1657-FN</b>	10	<b>513.3257-FF</b> <sup>1</sup>	10
					GERMAN	<b>513.1657-DN</b>	10	<b>513.3257-DF</b> <sup>1</sup>	10
					ITALIAN P30	<b>513.1657-PN</b>	10	<b>513.3257-PF</b> <sup>1</sup>	10
					ITALIAN P40	<b>513.1657-LN</b>	10	<b>513.3257-LF</b> <sup>1</sup>	10
					BRITISH BS1363	<b>513.1657-BN</b> <sup>1</sup>	10	<b>513.3257-BF</b> <sup>1</sup>	10
ARGENTINE	<b>513.1657-AF</b> <sup>1</sup>	10	<b>513.3257-AF</b> <sup>1</sup>	10					
BRAZILIAN	<b>513.1657-CF</b> <sup>1</sup>	10	<b>513.3257-CF</b> <sup>1</sup>	10					
DANISH	<b>513.1657-KN</b>	10	<b>513.3257-KF</b> <sup>1</sup>	10					
3P+N+E	346-415V	■	■	6h	FRENCH	<b>513.1657-FN</b>	10	<b>513.3257-FF</b> <sup>1</sup>	10
					GERMAN	<b>513.1657-DN</b>	10	<b>513.3257-DF</b> <sup>1</sup>	10
					ITALIAN P30	<b>513.1657-PN</b>	10	<b>513.3257-PF</b> <sup>1</sup>	10
					ITALIAN P40	<b>513.1657-LN</b>	10	<b>513.3257-LF</b> <sup>1</sup>	10
					BRITISH BS1363	<b>513.1657-BN</b> <sup>1</sup>	10	<b>513.3257-BF</b> <sup>1</sup>	10
					ARGENTINE	<b>513.1657-AF</b> <sup>1</sup>	10	<b>513.3257-AF</b> <sup>1</sup>	10
					BRAZILIAN	<b>513.1657-CF</b> <sup>1</sup>	10	<b>513.3257-CF</b> <sup>1</sup>	10
					DANISH	<b>513.1657-KN</b>	10	<b>513.3257-KF</b> <sup>1</sup>	10

<sup>1</sup> Household socket protected by 10A fuse [time-delay] (included)

- Open threaded cable entry
- Rubber threaded cable sleeve included
- COMBI version: combining industrial and household sockets



**DANISH STANDARD**  
Shuttered socket

1.2



# Connectors and sockets for industrial applications

## Surface mounting socket outlets - IP44/IP54

### ■ OPTIMA Series >> Surface mounting socket outlets

OPTIMA Series

512.



 **Screw terminals**  
[Angled box]

SURFACE MOUNTING SOCKET

IP44/IP54

M20X1,5

M25X1,5

M32X1,5

Poles	Hz	Volt	Colour	h	16A		32A		
2P+E	50Hz 60Hz	100-130V	Yellow	4h	<b>512.1650</b>	10/50	<b>512.3250</b>	10/40	
		200-250V	Blue	6h	<b>512.1653</b>	10/50	<b>512.3253</b>	10/40	
		380-415V	Red	9h	<b>512.1658</b>	10/50	<b>512.3258</b>	10/40	
3P+E	50Hz 60Hz	100-130V	Yellow	4h		<b>512.1651</b>	10/50	<b>512.3251</b>	10/40
		200-250V	Blue	9h		<b>512.1654</b>	10/50	<b>512.3254</b>	10/40
		380-415V	Red	6h		<b>512.1656</b>	10/50	<b>512.3256</b>	10/40
3P+N+E	50Hz 60Hz	100-130V	Yellow	4h		<b>512.1652</b>	10/50	<b>512.3252</b>	10/40
		208-250V	Blue	9h		<b>512.1655</b>	10/50	<b>512.3255</b>	10/40
		346-415V	Red	6h		<b>512.1657</b>	10/50	<b>512.3257</b>	10/40

- Open threaded cable entry
- Threaded cap/cable sleeve included



**Terminals**  
Screw terminals

# Connectors and sockets for industrial applications

## Surface mounting socket outlets - IP44/IP54



### ■ OPTIMA Series >> Surface mounting socket outlets

#### OPTIMA Series

522.



**Screw terminals**  
[Straight box]

SURFACE MOUNTING SOCKET

IP44/IP54

DRILLING POINT MARK

Poles	Hz	Volt	Colour	h	16A		32A	
					Part No.	Lead time	Part No.	Lead time
2P+E	50Hz 60Hz	100-130V	Yellow	4h	<b>522.1650</b>	10/50	<b>522.3250</b>	10/40
		200-250V	Blue	6h	<b>522.1653</b>	10/50	<b>522.3253</b>	10/40
		380-415V	Red	9h	<b>522.1658</b>	10/50	<b>522.3258</b>	10/40
3P+E	50Hz 60Hz	100-130V	Yellow	4h	<b>522.1651</b>	10/50	<b>522.3251</b>	10/40
		200-250V	Blue	9h	<b>522.1654</b>	10/50	<b>522.3254</b>	10/40
		380-415V	Red	6h	<b>522.1656</b>	10/50	<b>522.3256</b>	10/40
3P+N+E	50Hz 60Hz	100-130V	Yellow	4h	<b>522.1652</b>	10/50	<b>522.3252</b>	10/40
		208-250V	Blue	9h	<b>522.1655</b>	10/50	<b>522.3255</b>	10/40
		346-415V	Red	6h	<b>522.1657</b>	10/50	<b>522.3257</b>	10/40

- Blank side with drilling point mark
- Rubber cable sleeve included

1.2



# Connectors and sockets for industrial applications

## Surface mounting socket outlets - IP66/IP67/IP69

### ■ OPTIMA Series >> Surface mounting socket outlets

#### OPTIMA-TOP Series



























518.



 **TOP - Screw terminals**

#### SURFACE MOUNTING SOCKET

IP66/IP67/IP69

Poles	Hz	Volt	Colour	h	MOUNTING			10/40	10	
					IP66/IP67/IP69					
					M20X1,5	M25X1,5	M32X1,5			
					16A			32A		
2P+E	50Hz 60Hz	100-130V		4h	<b>518.1650T</b>	10/40		<b>518.3250T</b>	10	
		200-250V		6h	<b>518.1653T</b>	10/40		<b>518.3253T</b>	10	
		380-415V		9h	<b>518.1658T</b>	10/40		<b>518.3258T</b>	10	
		480-500V		7h	<b>518.16536T</b>	10/40		<b>518.32536T</b>	10	
	>300-500Hz	TST>50V		12h	<b>518.16533T</b>	10/40		<b>518.32533T</b>	10	
		>50V		2h	<b>518.16532T</b>	10/40		<b>518.32532T</b>	10	
		DC	>50-250V		3h	<b>518.16534T</b>	10/40		<b>518.32534T</b>	10
			>250V		8h	<b>518.16538T</b>	10/40		<b>518.32538T</b>	10
3P+E	50Hz 60Hz	100-130V		4h		<b>518.1651T</b>	10/40	<b>518.3251T</b>	10	
		200-250V		9h		<b>518.1654T</b>	10/40	<b>518.3254T</b>	10	
		380-415V		6h		<b>518.1656T</b>	10/40	<b>518.3256T</b>	10	
		380V 50Hz / 440V 60Hz		3h		<b>518.16564T</b>	10/40	<b>518.32564T</b>	10	
	60Hz	480-500V		7h		<b>518.16566T</b>	10/40	<b>518.32566T</b>	10	
		600-690V		5h		<b>518.16567T</b>	10/40	<b>518.32567T</b>	10	
		440-460V		11h		<b>518.16565T</b>	10/40	<b>518.32565T</b>	10	
	>300-500Hz	100-300Hz	>50V		10h		<b>518.16561T</b>	10/40	<b>518.32561T</b>	10
		60Hz	440-460V		11h		<b>518.16562T</b>	10/40	<b>518.32562T</b>	10
			>300-500Hz	>50V		2h		<b>518.16562T</b>	10/40	<b>518.32562T</b>
3P+N+E	50Hz 60Hz	100-130V		4h		<b>518.1652T</b>	10/40	<b>518.3252T</b>	10	
		208-250V		9h		<b>518.1655T</b>	10/40	<b>518.3255T</b>	10	
		346-415V		6h		<b>518.1657T</b>	10/40	<b>518.3257T</b>	10	
		380V 50Hz / 440V 60Hz		3h		<b>518.16574T</b>	10/40	<b>518.32574T</b>	10	
	60Hz	480-500V		7h		<b>518.16576T</b>	10/40	<b>518.32576T</b>	10	
		600-690V		5h		<b>518.16577T</b>	10/40	<b>518.32577T</b>	10	
		440-460V		11h		<b>518.16575T</b>	10/40	<b>518.32575T</b>	10	
	>300-500Hz	>50V		2h		<b>518.16572T</b>	10/40	<b>518.32572T</b>	10	

- Threaded break-through knock out



**Terminals**  
Screw terminals



**Terminals**  
Spring terminals (FAST WIRING)

# Connectors and sockets for industrial applications

## Surface mounting socket outlets - IP66/IP67/IP69



### ■ OPTIMA Series >> Surface mounting socket outlets

#### OPTIMA-TOP Series

518.



TOP - Spring terminals

#### SURFACE MOUNTING SOCKET

IP66/IP67/IP69

Poles	Hz	Volt	Colour	h	M20X1,5		M25X1,5		M32X1,5	
					16A		16A		32A	
2P+E	50Hz 60Hz	100-130V		4h	<b>518.1650TF</b>	10/40			<b>518.3250TF</b>	10
		200-250V		6h	<b>518.1653TF</b>	10/40			<b>518.3253TF</b>	10
		380-415V		9h	<b>518.1658TF</b>	10/40			<b>518.3258TF</b>	10
3P+E	50Hz 60Hz	200-250V					<b>518.1654TF</b>	10/40	<b>518.3254TF</b>	10
		380-415V		6h			<b>518.1656TF</b>	10/40	<b>518.3256TF</b>	10
3P+N+E	50Hz 60Hz	380V 50Hz / 440V 60Hz		3h					<b>518.32564TF</b>	10
		346-415V		6h			<b>518.1657TF</b>	10/40	<b>518.3257TF</b>	10

- Threaded break-through knock out

1.2



# Connectors and sockets for industrial applications

## Surface mounting socket outlets - IP66/IP67/IP69

### ■ OPTIMA Series >> Surface mounting socket outlets

#### OPTIMA-TOP Series

























518.



 **TOP - Mantle terminals**

#### SURFACE MOUNTING SOCKET

IP66/IP67/IP69

Poles	Hz	Volt	Colour	h	M40X1,5		M63X1,5		
					63A		125A		
2P+E	50Hz 60Hz	100-130V		4h	<b>518.6350T</b>	4	<b>518.12550T</b>	1/4	
		200-250V		6h	<b>518.6353T</b>	4	<b>518.12553T</b>	1/4	
		380-415V		9h	<b>518.6358T</b>	4	<b>518.12558T</b>	1/4	
		480-500V		7h	<b>518.63536T</b>		<b>518.125536T</b>		
		TST>50V		12h	<b>518.63533T</b>		<b>518.125533T</b>		
	DC	>300-500Hz	>50V		2h	<b>518.63532T</b>		<b>518.125532T</b>	
		>50-250V		3h	<b>518.63534T</b>		<b>518.125534T</b>		
		>250V		8h	<b>518.63538T</b>		<b>518.125538T</b>		
3P+E	50Hz 60Hz	100-130V		4h	<b>518.6351T</b>	4	<b>518.12551T</b>	1/4	
		200-250V		9h	<b>518.6354T</b>	4	<b>518.12554T</b>	1/4	
		380-415V		6h	<b>518.6356T</b>	4	<b>518.12556T</b>	1/4	
		380V 50Hz / 440V 60Hz		3h	<b>518.63564T</b>		<b>518.125564T</b>		
		480-500V		7h	<b>518.63566T</b>		<b>518.125566T</b>		
	60Hz	600-690V		5h	<b>518.63567T</b>		<b>518.125567T</b>		
		440-460V		11h	<b>518.63565T</b>		<b>518.125565T</b>		
		100-300Hz	>50V		10h	<b>518.63561T</b>		<b>518.125561T</b>	
		>300-500Hz	>50V		2h	<b>518.63562T</b>		<b>518.125562T</b>	
		3P+N+E	50Hz 60Hz	100-130V		4h	<b>518.6352T</b>	4	<b>518.12552T</b>
208-250V				9h	<b>518.6355T</b>	4	<b>518.12555T</b>	1/4	
346-415V				6h	<b>518.6357T</b>	4	<b>518.12557T</b>	1/4	
380V 50Hz / 440V 60Hz				3h	<b>518.63574T</b>		<b>518.125574T</b>		
480-500V				7h	<b>518.63576T</b>		<b>518.125576T</b>		
60Hz	600-690V			5h	<b>518.63577T</b>		<b>518.125577T</b>		
	440-460V			11h	<b>518.63575T</b>		<b>518.125575T</b>		
	>300-500Hz		>50V		2h	<b>518.63572T</b>		<b>518.125572T</b>	

- Open threaded cable entry
- Cable gland included



**Terminals**  
Mantle terminals (EASY-PLUG)



**Terminals**  
Screw terminals

# Connectors and sockets for industrial applications

## Surface mounting socket outlets - IP66/IP67/IP69



### ■ OPTIMA Series >> Surface mounting socket outlets

#### OPTIMA-TOP Series

518.



 **TOP - Screw terminals [SAFE-IN]**







#### SURFACE MOUNTING SOCKET

IP66/IP67/IP69

M20X1,5

M25X1,5

16A

Poles	Hz	Volt	Colour	h		
2P+E	50Hz 60Hz	100-130V		4h	<b>518.1650TH</b>	10/40
		200-250V		6h	<b>518.1653TH</b>	10/40
		380-415V		9h	<b>518.1658TH</b>	10/40
3P+E	50Hz 60Hz	200-250V				<b>518.1654TH</b> 10/40
		380-415V				<b>518.1656TH</b> 10/40
3P+N+E		346-415V		6h		<b>518.1657TH</b> 10/40

☉ Sockets with "SAFE-IN" safety device

- Threaded break-through knock out

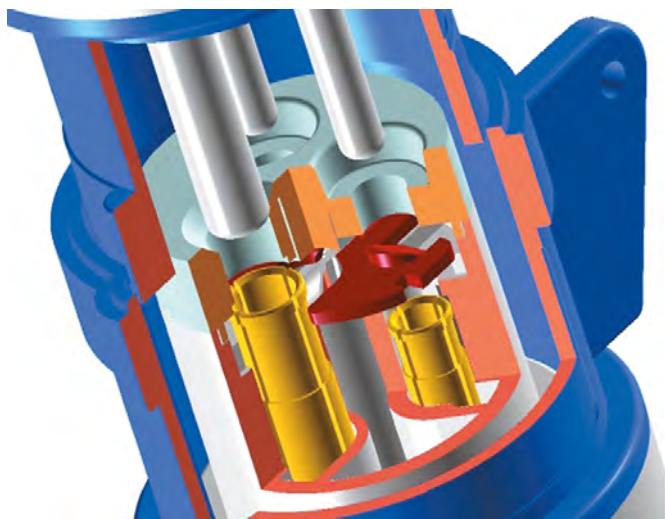

#### SAFE-IN

Connector tube protective shutter for increased safety against direct contacts. (The SAFE-IN safety device).

1.2



# Connectors and sockets for industrial applications

## Surface mounting socket outlets - IP66/IP67/IP69

### ■ OPTIMA Series >> Surface mounting socket outlets

OPTIMA Series

517.



 **Screw terminals  
[Angled box]**

SURFACE MOUNTING SOCKET

IP66/IP67/IP69

Poles	Hz	Volt	Colour	h	M20X1,5		M25X1,5		M32X1,5	
					16A				32A	
2P+E		100-130V	Yellow	4h	<b>517.1650</b>	10/50			<b>517.3250</b>	10/40
		200-250V	Blue	6h	<b>517.1653</b>	10/50			<b>517.3253</b>	10/40
		380-415V	Red	9h	<b>517.1658</b>	10/50			<b>517.3258</b>	10/40
3P+E	50Hz 60Hz	100-130V	Yellow	4h			<b>517.1651</b>	10/50	<b>517.3251</b>	10/40
		200-250V	Blue	9h			<b>517.1654</b>	10/50	<b>517.3254</b>	10/40
		380-415V	Red	6h			<b>517.1656</b>	10/50	<b>517.3256</b>	10/40
		380V 50Hz / 440V 60Hz	Red	3h					<b>517.32564</b>	10/40
3P+N+E		100-130V	Yellow	4h			<b>517.1652</b>	10/40	<b>517.3252</b>	10/40
		208-250V	Blue	9h			<b>517.1655</b>	10/40	<b>517.3255</b>	10/40
		346-415V	Red	6h			<b>517.1657</b>	10/40	<b>517.3257</b>	10/40

- Open threaded cable entry
- Threaded cap/cable sleeve included



**Terminals**  
Screw terminals



# Connectors and sockets for industrial applications

## Surface mounting socket outlets - IP66/IP67/IP69



### ■ OPTIMA Series >> Surface mounting socket outlets

OPTIMA Series

527.



Screw terminals  
[Straight box]

SURFACE MOUNTING SOCKET

IP66/IP67/IP69

DRILLING POINT MARK

Poles	Hz	Volt	Colour	h	16A		32A	
					Code	Dimensions	Code	Dimensions
2P+E	50Hz 60Hz	100-130V	Yellow	4h	<b>527.1650</b>	10/50	<b>527.3250</b>	10/40
		200-250V	Blue	6h	<b>527.1653</b>	10/50	<b>527.3253</b>	10/40
		380-415V	Red	9h	<b>527.1658</b>	10/50	<b>527.3258</b>	10/40
3P+E	50Hz 60Hz	100-130V	Yellow	4h	<b>527.1651</b>	10/50	<b>527.3251</b>	10/40
		200-250V	Blue	9h	<b>527.1654</b>	10/50	<b>527.3254</b>	10/40
		380-415V	Red	6h	<b>527.1656</b>	10/50	<b>527.3256</b>	10/40
3P+N+E	50Hz 60Hz	100-130V	Yellow	4h	<b>527.1652</b>	10/50	<b>527.3252</b>	10/40
		208-250V	Blue	9h	<b>527.1655</b>	10/50	<b>527.3255</b>	10/40
		346-415V	Red	6h	<b>527.1657</b>	10/50	<b>527.3257</b>	10/40

- Blank side with drilling point mark

1.2



# Connectors and sockets for industrial applications

## Surface mounting switched socket outlets without interlock - IP44/IP54

### ■ OPTIMA Series >> Surface mounting socket outlets

#### OPTIMA-TOP Series

513.





 **TOP SWITCH - Screw terminals**

#### SURFACE MOUNTING SOCKET

IP44/IP54

M25X1,5

M32X1,5

Poles	Hz	Volt	Colour	h	16A		32A			
					Part No.	Qty	Part No.	Qty		
2P+E		200-250V			<b>513.1653TS</b> <sup>1 2</sup>	10	<b>513.3253TS.A</b> <sup>1 2</sup>	10	<b>513.3253TS</b> <sup>3</sup>	10
3P+E	50Hz 60Hz	380-415V		6h	<b>513.1656TS</b> <sup>1 2</sup>	10	<b>513.3256TS.A</b> <sup>1 2</sup>	10	<b>513.3256TS</b> <sup>3</sup>	10
3P+N+E		346-415V			<b>513.1657TS</b> <sup>1 2</sup>	10	<b>513.3257TS.A</b> <sup>1 2</sup>	10	<b>513.3257TS</b> <sup>3</sup>	10

<sup>1</sup> Open threaded cable entry

<sup>2</sup> Threaded cap/cable sleeve included

<sup>3</sup> Threaded break-through knock out



**Terminals**  
Screw terminals



**FRENCH STANDARD 16A**  
Shuttered socket



**ARGENTINIAN STANDARD 10A**  
Unshuttered socket

# Connectors and sockets for industrial applications

## Surface mounting switched socket outlets without interlock - IP44/IP54



### ■ OPTIMA Series >> Surface mounting socket outlets

#### OPTIMA-COMBI Series

513.



**COMBI SWITCH - Screw terminals**

#### SURFACE MOUNTING SOCKET

IP44/IP54

M32X1,5

Poles	Hz	Volt	Colour	h	Version	no.	16A		32A	
2P+E		200-250V	Blue		☺ FRENCH	1	<b>513.1653-1FNS</b>	8	<b>513.3253-1FFS<sup>1</sup></b>	8
					☒ ARGENTINE	2	<b>513.1653-2AFS<sup>1</sup></b>	8	<b>513.3253-2AFS<sup>1</sup></b>	8
					☺ FRENCH	1	<b>513.1656-1FNS</b>	8	<b>513.3256-1FFS<sup>1</sup></b>	8
					☒ ARGENTINE	2	<b>513.1656-2AFS<sup>1</sup></b>	8	<b>513.3256-2AFS<sup>1</sup></b>	8
3P+E	50Hz 60Hz	380-415V	Red	6h	☺ FRENCH	1	<b>513.1657-1FNS</b>	8	<b>513.3257-1FFS<sup>1</sup></b>	8
					☒ ARGENTINE	2	<b>513.1657-2AFS<sup>1</sup></b>	8	<b>513.3257-2AFS<sup>1</sup></b>	8
					☺ FRENCH	1	<b>513.1657-1FNS</b>	8	<b>513.3257-1FFS<sup>1</sup></b>	8
					☒ ARGENTINE	2	<b>513.1657-2AFS<sup>1</sup></b>	8	<b>513.3257-2AFS<sup>1</sup></b>	8

<sup>1</sup> Household socket protected by 10A fuse [time-delay] (included)

- Open threaded cable entry
- Rubber threaded cable sleeve included
- COMBI version: combining industrial and household sockets

1.2



# Connectors and sockets for industrial applications

## Surface mounting switched socket outlets without interlock - IP44/IP54

### ■ OPTIMA Series >> Surface mounting socket outlets

#### OPTIMA-COMBI Series

513.



 **COMBI REVERSE  
L-0-R - Screw  
terminals**

#### SURFACE MOUNTING SOCKET

IP44/IP54

M32X1,5

Poles	Hz	Volt	Colour	h	Version	no.	16A		32A	
3P+E	50Hz 60Hz	380-415V		6h	☺ FRENCH	1	<b>513.1656-1FNR</b>	8	<b>513.3256-1FFR</b> <sup>1</sup>	8
						2	<b>513.1656-2FNR</b>	8	<b>513.3256-2FFR</b> <sup>1</sup>	8
3P+N+E		346-415V				1	<b>513.1657-1FNR</b>	8	<b>513.3257-1FFR</b> <sup>1</sup>	8
						2	<b>513.1657-2FNR</b>	8	<b>513.3257-2FFR</b> <sup>1</sup>	8

<sup>1</sup> Household socket protected by 10A fuse [time-delay] (included)

- Open threaded cable entry
- Rubber threaded cable sleeve included
- REVERSE L-0-R: With phase reversing switch
- COMBI version: combining industrial and household sockets



**FRENCH STANDARD  
16A**  
Shuttered socket



**Terminals**  
Screw terminals

# Connectors and sockets for industrial applications

## Surface mounting switched socket outlets without interlock - IP66/IP67/IP69



### ■ OPTIMA Series >> Surface mounting socket outlets

#### OPTIMA-TOP Series

518.



**TOP SWITCH - Screw terminals**

#### SURFACE MOUNTING SOCKET

IP66/IP67/IP69

M25X1,5

M32X1,5

Poles	Hz	Volt	Colour	h	16A		32A			
					Part No.	Qty	Part No.	Qty		
2P+E		200-250V	Blue		<b>518.1653TS</b> <sup>1 2</sup>	10	<b>518.3253TS.A</b> <sup>1 2</sup>	10	<b>518.3253TS</b> <sup>3</sup>	10
3P+E	50Hz 60Hz	380-415V	Red	6h	<b>518.1656TS</b> <sup>1 2</sup>	10	<b>518.3256TS.A</b> <sup>1 2</sup>	10	<b>518.3256TS</b> <sup>3</sup>	10
3P+N+E		346-415V			<b>518.1657TS</b> <sup>1 2</sup>	10	<b>518.3257TS.A</b> <sup>1 2</sup>	10	<b>518.3257TS</b> <sup>3</sup>	10

<sup>1</sup> Open threaded cable entry

<sup>2</sup> Threaded cap/cable sleeve included

<sup>3</sup> Threaded break-through knock out

1.2



# Connectors and sockets for industrial applications

## Domestic standard socket for industrial applications - IP54

### DOMO Series >> Flush mounting

#### DOMO Series

570.



50x60mm



70x87mm



70x87mm

#### FLUSH-MOUNTING SOCKET

50x60mm

70x87mm

#### SURFACE MOUNTING SOCKET

IP54

#### DRILLING POINT MARK

Current	Poles	Volt	Version	Colour	50x60mm		70x87mm		70x87mm	
10A			ARGENTINE		<b>570.2093</b>	10/100	<b>570.4093</b>	10/100	<b>570.4193</b>	9/90
13A			BRITISH BS1363		<b>570.2041</b>	10/100	<b>570.4041</b>	10/100	<b>570.4141</b>	9/90
16A	2P+E	250V	FRENCH		<b>570.2091</b>	10/100	<b>570.4091</b>	10/100	<b>570.4191</b>	9/90
					<b>570.2591</b>	10/100				
			GERMAN		<b>570.2062</b>	10/100	<b>570.4062</b>	10/100	<b>570.4162</b>	9/90
			ITALIAN P30		<b>570.2081</b>	10/100	<b>570.4081</b>	10/100	<b>570.4181</b>	9/90
			ITALIAN P40				<b>570.4051</b>	10/100	<b>570.4151</b>	9/90
			ITALIAN P17/11		<b>570.2071</b>	10/100	<b>570.4071</b>	10/100	<b>570.4171</b>	9/90
			GERMAN UNSHUTTER		<b>570.2061</b>	10/100	<b>570.4061</b>	10/100	<b>570.4161</b>	9/90
				<b>570.2561</b>	10/100					
20A			BRAZILIAN		<b>570.2092</b>	10/100	<b>570.4092</b>	10/100	<b>570.4192</b>	9/90

1 Shutterless socket, subject to normative restrictions or prohibitions in Europe or in other geographical areas. Check the national laws prior to using or installing it.

2 Blank side with drilling point mark

3 Rubber cable sleeve included



#### 570.2001

Accessory used to fix the DOMO Series sockets (50x60 mm) on the side entries of the ENERBOX Series



**FRENCH STANDARD 16A**  
Shuttered socket



**FRENCH-GERMAN STANDARD 16A**  
Shuttered socket



**ITALIAN STANDARD P30 - 16A**  
Shuttered socket CEI 23-50



**PLURISTANDARD P40 16A**  
Shuttered socket



**BRITISH STANDARD 13A**  
Shuttered socket BS 1363-2



**ITALIAN STANDARD P17/11 16A (bivalente)**  
Shuttered socket CEI 23-50



**ARGENTINIAN STANDARD 10A**  
Unshuttered socket



**BRAZILIAN STANDARD 10A**  
Unshuttered socket ABNT NBR 14136:2002

# Connectors and sockets for industrial applications

## Domestic standard socket for industrial applications - IP54



### DOMO Series

570.



With switch

SURF. MOUNT. SOCKET WITH SWITCH

IP54

Current	Poles	Volt	Version	Colour		
13A	2P+E	250V	BRITISH BS1363		<b>570.7180</b>	1/12

## Accessories for plugs and sockets

### ENCLOSURES ACCESSORIES

654.



Description	Flange	Notes	Colour	IP	Plates
CUT-OUT PLATE - With gasket	70x87mm	70x87 --> 50x60		IP66	<b>654.0103</b> 25



**GERMAN STANDARD  
16A**  
Unshuttered socket

1.2



# Connectors and sockets for industrial applications

## Domestic standard socket for industrial applications - IP54

### Accessories for plugs and sockets

#### DOMO Series

570.



Description	Flange	IP	Suitable for	Colour	Watertight cover	
CABINET FIXING					<b>570.2001</b>	10/100
FLUSH MOUNTING FRAME	70x87mm	IP55	EVOLUTION BTICINO	■	<b>570.5052</b> [1]	10/100
					<b>570.5012</b> [1] [2]	10/100

[1] Modules snap into place.

[2] Manufactured with the authorization from Bticino spa company and is suitable to house "Living International", "Luna", "Light" and "Light Tech" modules which are registered trademarks owned by Bticino.

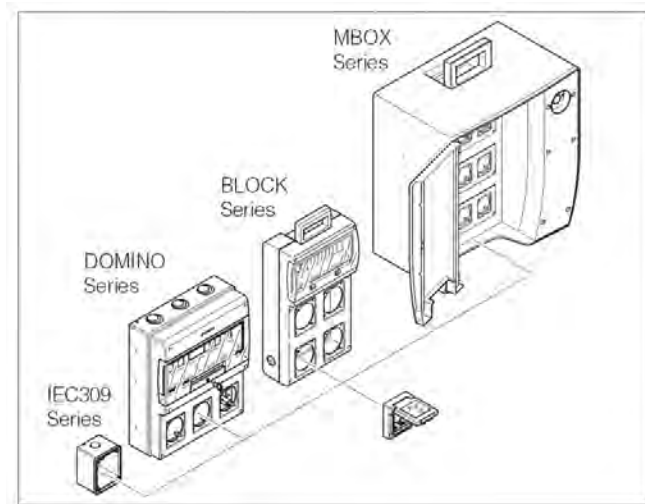

**DOMO Series**  
Examples of installation (flange 70x87mm)



**RJ45**  
Standard Ethernet



**ITALIAN STANDARD P17/11 16A (bivalente)**  
Shuttered socket CEI 23-50



**FRENCH STANDARD 16A**  
Shuttered socket



**BRITISH STANDARD 15A**  
Shuttered socket BS 546



**FRENCH-GERMAN STANDARD 16A**  
Shuttered socket



**ITALIAN STANDARD P30 - 16A**  
Shuttered socket CEI 23-50



**PLURISTANDARD P40 16A**  
Shuttered socket



**BRITISH STANDARD 13A**  
Shuttered socket BS 1363-2



# Connectors and sockets for industrial applications

## BS socket for industrial applications - IP66



### ■ DOMOPLUS Series - Domestic standard sockets for industrial applications - IP66

DOMOPLUS Series

570.



Description	Version	Current Dimension	Flush mounting 70x87mm	Accessories
RJ45 OUTLET	RJ45		<b>570.6481.50</b> <sup>[1]</sup> 1/12	
ENCLOSURE				<b>570.6001</b> <sup>[2] [3]</sup> 1/12
GERMAN STANDARD SOCKET	GERMAN		<b>570.6407</b> 1/12	
ITALIAN P30 STANDARD SOCKET	ITALIAN P30	16A	<b>570.6404</b> 1/12	
ITALIAN P40 STANDARD SOCKET	ITALIAN P40		<b>570.6405</b> 1/12	
SINGLE UNSWITCHED SOCKET	BRITISH BS546	15A	<b>570.6414</b> 1/12	
	BRITISH BS1363	13A	<b>570.6413</b> 1/12	
ITALIAN P17/11 STANDARD SOCKET	ITALIAN P17/11 (DUAL USE)	16A	<b>570.6403</b> 1/12	
FRENCH STANDARD SOCKET	FRENCH		<b>570.6411</b> 1/12	
ARGENTINIAN STANDARD SOCKET	ARGENTINE	10A	<b>570.6424</b> 1/12	
NEOZELANDER STANDARD SOCKET	NEW ZELAND		<b>570.6427</b> 1/12	
SOUTH AFRICAN STANDARD SOCKET	SOUTH AFRICAN	16A	<b>570.6428</b> 1/12	
SWISS STANDARD SOCKET	SWISS	10A	<b>570.6417</b> 1/12	
BRAZILIAN STANDARD SOCKET	BRAZILIAN		<b>570.6421</b> 1/12	
PANEL MOUNTING ADAPTOR				<b>570.6011</b> 5

- [1] RJ45 - Cat.5E
- [2] Empty enclosure
- [3] Accepts SCAME EVOLUTION Series inserts.



**570.6001**  
The empty container accepts EVOLUTION Series modules

<b>SWISS STANDARD 10A</b> Unshuttered socket SEV 1011:1998	<b>ARGENTINIAN STANDARD 10A</b> Unshuttered socket	<b>BRAZILIAN STANDARD 10A</b> Unshuttered socket ABNT NBR 14136:2002	<b>NEW ZEALAND STANDARD 10A</b> Unshuttered socket AS/NZS 3112	<b>SOUTH AFRICAN STANDARD 16A</b> Shuttered socket SANS 164:1 (2006)	<b>IP66</b> Specifically high formulated gel seal to maintain protection degree when the plug is inserted

1.2



# Connectors and sockets for industrial applications

## Accessories for sockets

### Boxes

#### DOMO Series

570.



Surface mounting boxes

Surface mounting boxes

Cable outlet	Current	Colour	SURFACE MOUNTING BOX			
			STRAIGHT		ANGLED	
			IP66/IP67/IP69			
DRILLING POINT MARK	16A		<b>570.0016</b> <sup>3</sup> <sub>4</sub>	10/100	<b>570.0116</b> <sup>3</sup> <sub>4</sub>	10
	32A		<b>570.0032</b> <sup>3</sup> <sub>4</sub>	10	<b>570.0132</b> <sup>3</sup> <sub>4</sub>	10
M20X1,5	16A				<b>570.0116.20</b> <sup>1</sup> <sub>2</sub>	10
M25X1,5	16A				<b>570.0116.25</b> <sup>1</sup> <sub>2</sub>	10
M32X1,5	32A				<b>570.0132.32</b> <sup>1</sup> <sub>2</sub>	10
M40X1,5	63A				<b>570.M0163</b> <sup>1</sup> <sub>2</sub>	6
M63X1,5	125A				<b>570.M0125</b> <sup>1</sup> <sub>2</sub>	6

- <sup>1</sup> Open threaded cable entry
- <sup>2</sup> Threaded cap/cable sleeve included
- <sup>3</sup> Blank side with drilling point mark
- <sup>4</sup> Rubber cable sleeve included
- Suitable for the sealing caps
- Supplied with socket fastening screws.

### Kit

#### ENCLOSURES ACCESSORIES

654.



Description	Flange	Notes	Colour	IP	Flange adapter
CUT-OUT PLATE	84x106mm	84x106 --> 75x75		IP66	<b>654.0108</b> 5
- With gasket					

# Connectors and sockets for industrial applications

## Accessories for sockets



### Kit

#### OPTIMA Series

654.



Description	Notes	Kit micro-switch (suitable for OPTIMA Series)	
MICROSWITCH KIT	16/32A NC	<b>654.0392</b>	10
	16/32A NO	<b>654.0391</b>	10
	63/125A NC	<b>654.0394</b>	10
	63/125A NO	<b>654.0393</b>	10

- Suited for flush mounting angled outlet versions only
- For inserted plug detection

#### OPTIMA-TOP Series

654.



Description	Notes	Kit accessories for plugs and sockets	
TERMINAL BLOCKS LOOP IN/OUT	6mm <sup>2</sup>	<b>654.0382</b>	10/100

- For 5-pole OPTIMA-TOP executions

#### UNION Series

805.



Description	IP	Colour	Cable outlet	Kit accessories for plugs and sockets
THREADED CABLE SLEEVE	IP55		M20X1,5	<b>805.5020</b> 100/1000
			M25X1,5	<b>805.5025</b> 100/1000
			M32X1,5	<b>805.5032</b> 100/1000

1.2



## 1.3

# Switched interlocked sockets outlets

- **OMNIA Series**  
Interlocked-switch socket outlets for industrial applications
- **OMNIAPLUS Series**  
Domestic interlocked socket
- **OMNIA System**  
Flush and surface mounting modular system
- **ADVANCE2 Series**  
Interlocked-switch socket outlets for industrial applications
- **ADVANCE2 System**  
Modular system for combination units - IP66
- **ADVANCE-GRP Series**  
Interlocked-switch socket outlets for industrial applications
- **ADVANCE-GRP System**  
Modular system - IP66





# Switched interlocked sockets outlets

## OMNIA Series

■ Rated voltage >50V >> Without fuse carrier >> Flush mounting

OMNIA Series

400.



IP44

INTERLOCKED SOCKET

IP44

136x125mm

Poles	Hz	Volt	Colour	h	16A		32A		
2P+E	50Hz 60Hz	100-130V	Yellow	4h	<b>400.1670</b>	6	<b>400.3270</b>	6	
		200-250V	Blue	6h	<b>400.1683</b>	6	<b>400.3283</b>	6	
		380-415V	Red	9h	<b>400.1678</b>	6	<b>400.3278</b>	6	
		480-500V	Black	7h	<b>400.16836</b>	6	<b>400.32836</b>	6	
		TST>50V	Grey	12h	<b>400.16833</b>	6	<b>400.32833</b>	6	
	>300-500Hz	>50V	Green	2h	<b>400.16832</b> <sup>[1]</sup>	6	<b>400.32832</b> <sup>[1]</sup>	6	
	DC	>50-250V	Grey	3h	<b>400.16834</b> <sup>[2]</sup>	6	<b>400.32834</b> <sup>[2]</sup>	6	
		>250V	Grey	8h	<b>400.16838</b> <sup>[2]</sup>	6	<b>400.32838</b> <sup>[2]</sup>	6	
3P+E	50Hz 60Hz	100-130V	Yellow	4h	<b>400.1672</b>	6	<b>400.3272</b>	6	
		200-250V	Blue	9h	<b>400.1674</b>	6	<b>400.3274</b>	6	
		380-415V	Red	6h	<b>400.1686</b>	6	<b>400.3286</b>	6	
		380V 50Hz / 440V 60Hz	Red	3h	<b>400.16864</b>	6	<b>400.32864</b>	6	
		480-500V	Black	7h	<b>400.16866</b>	6	<b>400.32866</b>	6	
	60Hz	440-460V	Red	11h	<b>400.16865</b>	6	<b>400.32865</b>	6	
	100-300Hz	>50V	Green	10h	<b>400.16861</b> <sup>[1]</sup>	6	<b>400.32861</b> <sup>[1]</sup>	6	
	>300-500Hz	>50V	Green	2h	<b>400.16862</b> <sup>[1]</sup>	6	<b>400.32862</b> <sup>[1]</sup>	6	
	3P+N+E	50Hz 60Hz	100-130V	Yellow	4h	<b>400.1679</b>	6	<b>400.3279</b>	6
			208-250V	Blue	9h	<b>400.1675</b>	6	<b>400.3275</b>	6
346-415V			Red	6h	<b>400.1687</b>	6	<b>400.3287</b>	6	
380V 50Hz / 440V 60Hz			Red	3h	<b>400.16874</b>	6	<b>400.32874</b>	6	
480-500V			Black	7h	<b>400.16876</b>	6	<b>400.32876</b>	6	
60Hz		440-460V	Red	11h	<b>400.16875</b>	6	<b>400.32875</b>	6	
>300-500Hz		>50V	Green	2h	<b>400.16872</b> <sup>[1]</sup>	6	<b>400.32872</b> <sup>[1]</sup>	6	

[1] The maximum amount of current available, taking into account the maximum overheating temperature allowed by the relevant standards, must be downgraded with respect to the nominal current by 25% for products with frequencies ranging above 100 Hz; contact Scame Technical Service for further information.

[2] When using DC we recommend that you make sure of implementing the protection scheme that is most suitable for the system involved; contact Scame Technical Service for further information.

[3] Pay special attention when selecting the appropriate fuse with respect to the tension of the installation.

- Supplied with stainless steel fixing screws.

1

INDUSTRY

2

3

4



# Switched interlocked sockets outlets

## OMNIA Series



■ Rated voltage >50V >> Without fuse carrier >> Flush mounting

OMNIA Series

405.



IP66/IP67

INTERLOCKED SOCKET

IP66/IP67

Poles	Hz	Volt	Colour	h	136x125mm								
					16A			32A			136x275mm		
					63A								
2P+E	50Hz 60Hz	100-130V	Yellow	4h	405.1670	6	405.3270	6	405.6370	1/6			
		200-250V	Blue	6h	405.1683	6	405.3283	6	405.6383	1/6			
		380-415V	Red	9h	405.1678	6	405.3278	6	405.6378	1/6			
		480-500V	Black	7h	405.16836	6	405.32836	6	405.63836	1/6			
		TST>50V	Grey	12h	405.16833	6	405.32833	6	405.63833	1/6			
	>300-500Hz	>50V	Green	2h	405.16832 <sup>[1]</sup>	6	405.32832 <sup>[1]</sup>	6					
		DC	>50-250V	Grey	3h	405.16834 <sup>[2]</sup>	6	405.32834 <sup>[2]</sup>	6				
	>250V		Grey	8h	405.16838 <sup>[2]</sup>	6	405.32838 <sup>[2]</sup>	6					
	3P+E	50Hz 60Hz	100-130V	Yellow	4h	405.1672	6	405.3272	6	405.6372	1/6		
			200-250V	Blue	9h	405.1674	6	405.3274	6	405.6374	1/6		
380-415V			Red	6h	405.1686	6	405.3286	6	405.6386	1/6			
380V 50Hz / 440V 60Hz			Red	3h	405.16864	6	405.32864	6					
480-500V			Black	7h	405.16866	6	405.32866	6	405.63866	1/6			
60Hz		600-690V	Black	5h	405.16867 <sup>[3]</sup>	6	405.32867 <sup>[3]</sup>	6	405.63867 <sup>[3]</sup>	1/6			
		440-460V	Red	11h	405.16865	6	405.32865	6	405.63865	1/6			
100-300Hz		>50V	Green	10h	405.16861 <sup>[1]</sup>	6	405.32861 <sup>[1]</sup>	6					
>300-500Hz		>50V	Green	2h	405.16862 <sup>[1]</sup>	6	405.32862 <sup>[1]</sup>	6					
3P+N+E		50Hz 60Hz	100-130V	Yellow	4h	405.1679	6	405.3279	6	405.6379	1/6		
	208-250V		Blue	9h	405.1675	6	405.3275	6	405.6375	1/6			
	346-415V		Red	6h	405.1687	6	405.3287	6	405.6387	1/6			
	380V 50Hz / 440V 60Hz		Red	3h	405.16874	6	405.32874	6					
	60Hz	480-500V	Black	7h	405.16876	6	405.32876	6	405.63876	1/6			
		600-690V	Black	5h	405.16877 <sup>[3]</sup>	6	405.32877 <sup>[3]</sup>	6	405.63877 <sup>[3]</sup>	1/6			
	>300-500Hz	>50V	Green	2h	405.16875	6	405.32875	6	405.63875	1/6			
	>300-500Hz	>50V	Green	2h	405.16872 <sup>[1]</sup>	6	405.32872 <sup>[1]</sup>	6					

[1] The maximum amount of current available, taking into account the maximum overheating temperature allowed by the relevant standards, must be downgraded with respect to the nominal current by 25% for products with frequencies ranging above 100 Hz; contact Scame Technical Service for further information.

[2] When using DC we recommend that you make sure of implementing the protection scheme that is most suitable for the system involved; contact Scame Technical Service for further information.

[3] Pay special attention when selecting the appropriate fuse with respect to the tension of the installation.

- Supplied with stainless steel fixing screws.

1.3



# Switched interlocked sockets outlets

## OMNIA Series

■ Rated voltage >50V >> Without fuse carrier >> Surface mounting

OMNIA Series

500.



IP44

INTERLOCKED SOCKET

IP44

136x125mm

Poles	Hz	Volt	Colour	h	16A		32A			
					Part No.	6	Part No.	6		
2P+E	50Hz 60Hz	100-130V	Yellow	4h	<b>500.1670</b>	6	<b>500.3270</b>	6		
		200-250V	Blue	6h	<b>500.1683</b>	6	<b>500.3283</b>	6		
		380-415V	Red	9h	<b>500.1678</b>	6	<b>500.3278</b>	6		
		480-500V	Black	7h	<b>500.16836</b>	6	<b>500.32836</b>	6		
		TST>50V	Grey	12h	<b>500.16833</b>	6	<b>500.32833</b>	6		
	DC	>300-500Hz	>50V	Green	2h	<b>500.16832</b> <sup>[1]</sup>	6	<b>500.32832</b> <sup>[1]</sup>	6	
		>50-250V	Grey	3h	<b>500.16834</b> <sup>[2]</sup>	6	<b>500.32834</b> <sup>[2]</sup>	6		
				8h	<b>500.16838</b> <sup>[2]</sup>	6	<b>500.32838</b> <sup>[2]</sup>	6		
		3P+E	50Hz 60Hz	100-130V	Yellow	4h	<b>500.1672</b>	6	<b>500.3272</b>	6
				200-250V	Blue	9h	<b>500.1674</b>	6	<b>500.3274</b>	6
380-415V	Red			6h	<b>500.1686</b>	6	<b>500.3286</b>	6		
380V 50Hz / 440V 60Hz	Black			3h	<b>500.16864</b>	6	<b>500.32864</b>	6		
480-500V	Black			7h	<b>500.16866</b>	6	<b>500.32866</b>	6		
60Hz	600-690V		Black	5h	<b>500.16867</b> <sup>[3]</sup>	6	<b>500.32867</b> <sup>[3]</sup>	6		
	440-460V		Red	11h	<b>500.16865</b>	6	<b>500.32865</b>	6		
	100-300Hz		>50V	Green	10h	<b>500.16861</b> <sup>[1]</sup>	6	<b>500.32861</b> <sup>[1]</sup>	6	
	>300-500Hz		>50V	Green	2h	<b>500.16862</b> <sup>[1]</sup>	6	<b>500.32862</b> <sup>[1]</sup>	6	
	3P+N+E		50Hz 60Hz	100-130V	Yellow	4h	<b>500.1679</b>	6	<b>500.3279</b>	6
208-250V		Blue		9h	<b>500.1675</b>	6	<b>500.3275</b>	6		
346-415V		Red		6h	<b>500.1687</b>	6	<b>500.3287</b>	6		
380V 50Hz / 440V 60Hz		Black		3h	<b>500.16874</b>	6	<b>500.32874</b>	6		
480-500V		Black		7h	<b>500.16876</b>	6	<b>500.32876</b>	6		
60Hz		600-690V	Black	5h	<b>500.16877</b> <sup>[3]</sup>	6	<b>500.32877</b> <sup>[3]</sup>	6		
		440-460V	Red	11h	<b>500.16875</b>	6	<b>500.32875</b>	6		
		>300-500Hz	>50V	Green	2h	<b>500.16872</b> <sup>[1]</sup>	6	<b>500.32872</b> <sup>[1]</sup>	6	

[1] The maximum amount of current available, taking into account the maximum overheating temperature allowed by the relevant standards, must be downgraded with respect to the nominal current by 25% for products with frequencies ranging above 100 Hz; contact Scame Technical Service for further information.

[2] When using DC we recommend that you make sure of implementing the protection scheme that is most suitable for the system involved; contact Scame Technical Service for further information.

[3] Pay special attention when selecting the appropriate fuse with respect to the tension of the installation.

- Supplied with stainless steel fixing screws.
- Note: in case of mounting with ADVANCE2 System, use METRIC drilling point mark.
- Blank side with drilling point mark



# Switched interlocked sockets outlets

## OMNIA Series



■ Rated voltage >50V >> Without fuse carrier >> Surface mounting

OMNIA Series

505.



IP66/IP67

INTERLOCKED SOCKET

IP66/IP67

Poles	Hz	Volt	Colour	h	136x125mm			136x275mm			
					16A		32A		63A		
2P+E	50Hz 60Hz	100-130V	Yellow	4h	505.1670	6	505.3270	6	505.6370		
		200-250V	Blue	6h	505.1683	6	505.3283	6	505.6383	1/6	
		380-415V	Red	9h	505.1678	6	505.3278	6	505.6378		
		480-500V	Black	7h	505.16836	6	505.32836	6	505.63836		
		TST>50V	Grey	12h	505.16833	6	505.32833	6	505.63833		
	DC	>300-500Hz	>50V	Green	2h	505.16832 <sup>[1]</sup>	6	505.32832 <sup>[1]</sup>	6		
		>50-250V		Grey	3h	505.16834 <sup>[2]</sup>	6	505.32834 <sup>[2]</sup>	6	505.63834 <sup>[2]</sup>	
		>250V		Grey	8h	505.16838 <sup>[2]</sup>	6	505.32838 <sup>[2]</sup>	6		
		100-130V	Yellow	4h	505.1672	6	505.3272	6	505.6372		
		200-250V	Blue	9h	505.1674	6	505.3274	6	505.6374		
3P+E	50Hz 60Hz	380-415V	Red	6h	505.1686	6	505.3286	6	505.6386	1/6	
		380V 50Hz / 440V 60Hz		3h	505.16864	6	505.32864	6			
		480-500V	Black	7h	505.16866	6	505.32866	6	505.63866		
		600-690V		5h	505.16867 <sup>[3]</sup>	6	505.32867 <sup>[3]</sup>	6	505.63867 <sup>[3]</sup>		
	60Hz	440-460V	Red	11h	505.16865	6	505.32865	6	505.63865		
	100-300Hz	>50V	Green	10h	505.16861 <sup>[1]</sup>	6	505.32861 <sup>[1]</sup>	6			
	>300-500Hz	>50V	Green	2h	505.16862 <sup>[1]</sup>	6	505.32862 <sup>[1]</sup>	6			
	3P+N+E	50Hz 60Hz	100-130V	Yellow	4h	505.1679	6	505.3279	6	505.6379	1/6
208-250V			Blue	9h	505.1675	6	505.3275	6	505.6375		
346-415V			Red	6h	505.1687	6	505.3287	6	505.6387	1/6	
380V 50Hz / 440V 60Hz				3h	505.16874	6	505.32874	6			
480-500V		Black	7h	505.16876	6	505.32876	6	505.63876			
600-690V			5h	505.16877 <sup>[3]</sup>	6	505.32877 <sup>[3]</sup>	6	505.63877 <sup>[3]</sup>			
60Hz		440-460V	Red	11h	505.16875	6	505.32875	6	505.63875		
>300-500Hz		>50V	Green	2h	505.16872 <sup>[1]</sup>	6	505.32872 <sup>[1]</sup>	6			

[1] The maximum amount of current available, taking into account the maximum overheating temperature allowed by the relevant standards, must be downgraded with respect to the nominal current by 25% for products with frequencies ranging above 100 Hz; contact Scame Technical Service for further information.

[2] When using DC we recommend that you make sure of implementing the protection scheme that is most suitable for the system involved; contact Scame Technical Service for further information.

[3] Pay special attention when selecting the appropriate fuse with respect to the tension of the installation.

- Supplied with stainless steel fixing screws.
- Note: in case of mounting with ADVANCE2 System, use METRIC drilling point mark.
- Blank side with drilling point mark

1.3



# Switched interlocked sockets outlets

## OMNIA Series

■ Rated voltage >50V >> With fuse carrier >> Flush mounting

OMNIA Series

401.



IP44

INTERLOCKED SOCKET

IP44

136x125mm

Poles	Hz	Volt	Colour	h	16A		32A	
					Code	Current	Code	Current
2P+E	50Hz 60Hz	100-130V	Yellow	4h	<b>401.1670</b>	6	<b>401.3270</b>	6
		200-250V	Blue	6h	<b>401.1683</b>	6	<b>401.3283</b>	6
		380-415V	Red	9h	<b>401.1678</b>	6	<b>401.3278</b>	6
		480-500V	Black	7h	<b>401.16836</b>	6		
		TST>50V	Grey	12h	<b>401.16833</b>	6		
	>300-500Hz	>50V	Green	2h	<b>401.16832</b> <sup>[1]</sup>	6		
	DC	>50-250V	Grey	3h	<b>401.16834</b> <sup>[2]</sup>	6		
		>250V	Grey	8h	<b>401.16838</b> <sup>[2]</sup>	6		
3P+E	50Hz 60Hz	100-130V	Yellow	4h	<b>401.1672</b>	6	<b>401.3272</b>	6
		200-250V	Blue	9h	<b>401.1674</b>	6	<b>401.3274</b>	6
		380-415V	Red	6h	<b>401.1686</b>	6	<b>401.3286</b>	6
		380V 50Hz / 440V 60Hz	Red	3h	<b>401.16864</b>	6		
		480-500V	Black	7h	<b>401.16866</b>	6		
	60Hz	440-460V	Red	11h	<b>401.16867</b> <sup>[3]</sup>	6		
	100-300Hz	>50V	Green	10h	<b>401.16861</b> <sup>[1]</sup>	6		
	>300-500Hz	>50V	Green	2h	<b>401.16862</b> <sup>[1]</sup>	6		
3P+N+E	50Hz 60Hz	100-130V	Yellow	4h	<b>401.1679</b>	6	<b>401.3279</b>	6
		208-250V	Blue	9h	<b>401.1675</b>	6	<b>401.3275</b>	6
		346-415V	Red	6h	<b>401.1687</b>	6	<b>401.3287</b>	6
		380V 50Hz / 440V 60Hz	Red	3h	<b>401.16874</b>	6		
		480-500V	Black	7h	<b>401.16876</b>	6		
	60Hz	440-460V	Red	11h	<b>401.16877</b> <sup>[3]</sup>	6		
	>300-500Hz	>50V	Green	2h	<b>401.16872</b> <sup>[1]</sup>	6		

[1] The maximum amount of current available, taking into account the maximum overheating temperature allowed by the relevant standards, must be downgraded with respect to the nominal current by 25% for products with frequencies ranging above 100 Hz; contact Scame Technical Service for further information.

[2] When using DC we recommend that you make sure of implementing the protection scheme that is most suitable for the system involved; contact Scame Technical Service for further information.

[3] Pay special attention when selecting the appropriate fuse with respect to the tension of the installation.

- Supplied with stainless steel fixing screws.
- Fuses not supplied

# Switched interlocked sockets outlets

## OMNIA Series



■ Rated voltage >50V >> With fuse carrier >> Flush mounting

OMNIA Series

406.



IP66/IP67

INTERLOCKED SOCKET

IP66/IP67

136x125mm

Poles	Hz	Volt	Colour	h	16A		32A		
					Code	Code	Code	Code	
2P+E	50Hz 60Hz	100-130V	Yellow	4h	<b>406.1670</b>	6	<b>406.3270</b>	6	
		200-250V	Blue	6h	<b>406.1683</b>	6	<b>406.3283</b>	6	
		380-415V	Red	9h	<b>406.1678</b>	6	<b>406.3278</b>	6	
		480-500V	Black	7h	<b>406.16836</b>	6			
		TST>50V	Grey	12h	<b>406.16833</b>	6			
	>300-500Hz	DC	>50V	Green	2h	<b>406.16832</b> <sup>[1]</sup>	6		
			>50-250V	Grey	3h	<b>406.16834</b> <sup>[2]</sup>	6		
			>250V	Grey	8h	<b>406.16838</b> <sup>[2]</sup>	6		
			100-130V	Yellow	4h	<b>406.1672</b>	6	<b>406.3272</b>	6
			200-250V	Blue	9h	<b>406.1674</b>	6	<b>406.3274</b>	6
3P+E	50Hz 60Hz	380-415V	Red	6h	<b>406.1686</b>	6	<b>406.3286</b>	6	
		380V 50Hz / 440V 60Hz	Red	3h	<b>406.16864</b>	6			
		480-500V	Black	7h	<b>406.16866</b>	6			
		600-690V	Black	5h	<b>406.16867</b> <sup>[3]</sup>	6			
		440-460V	Red	11h	<b>406.16865</b>	6			
	60Hz	440-460V	Red	11h	<b>406.16865</b>	6			
	100-300Hz	>50V	Green	10h	<b>406.16861</b> <sup>[1]</sup>	6			
	>300-500Hz	>50V	Green	2h	<b>406.16862</b> <sup>[1]</sup>	6			
	3P+N+E	50Hz 60Hz	100-130V	Yellow	4h	<b>406.1679</b>	6	<b>406.3279</b>	6
			208-250V	Blue	9h	<b>406.1675</b>	6	<b>406.3275</b>	6
346-415V			Red	6h	<b>406.1687</b>	6	<b>406.3287</b>	6	
380V 50Hz / 440V 60Hz			Red	3h	<b>406.16874</b>	6			
480-500V			Black	7h	<b>406.16876</b>	6			
600-690V		Black	5h	<b>406.16877</b> <sup>[3]</sup>	6				
60Hz		440-460V	Red	11h	<b>406.16875</b>	6			
>300-500Hz		>50V	Green	2h	<b>406.16872</b> <sup>[1]</sup>	6			

[1] The maximum amount of current available, taking into account the maximum overheating temperature allowed by the relevant standards, must be downgraded with respect to the nominal current by 25% for products with frequencies ranging above 100 Hz; contact Scame Technical Service for further information.

[2] When using DC we recommend that you make sure of implementing the protection scheme that is most suitable for the system involved; contact Scame Technical Service for further information.

[3] Pay special attention when selecting the appropriate fuse with respect to the tension of the installation.

- Supplied with stainless steel fixing screws.
- Fuses not supplied

1.3



# Switched interlocked sockets outlets

## OMNIA Series

■ Rated voltage >50V >> With fuse carrier >> Surface mounting

OMNIA Series

501.



IP44

INTERLOCKED SOCKET

IP44

136x125mm

Poles	Hz	Volt	Colour	h	16A		32A	
					Part No.	Current	Part No.	Current
2P+E	50Hz 60Hz	100-130V	Yellow	4h	<b>501.1670</b>	6	<b>501.3270</b>	6
		200-250V	Blue	6h	<b>501.1683</b>	6	<b>501.3283</b>	6
		380-415V	Red	9h	<b>501.1678</b>	6	<b>501.3278</b>	6
		480-500V	Black	7h	<b>501.16836</b>	6		
		TST>50V	Grey	12h	<b>501.16833</b>	6		
	>300-500Hz	>50V	Green	2h	<b>501.16832</b> <sup>[1]</sup>	6		
	DC	>50-250V	Grey	3h	<b>501.16834</b> <sup>[2]</sup>	6		
		>250V	Grey	8h	<b>501.16838</b> <sup>[2]</sup>	6		
3P+E	50Hz 60Hz	100-130V	Yellow	4h	<b>501.1672</b>	6	<b>501.3272</b>	6
		200-250V	Blue	9h	<b>501.1674</b>	6	<b>501.3274</b>	6
		380-415V	Red	6h	<b>501.1686</b>	6	<b>501.3286</b>	6
		380V 50Hz / 440V 60Hz	Red	3h	<b>501.16864</b>	6		
		480-500V	Black	7h	<b>501.16866</b>	6		
	60-690V	Black	5h	<b>501.16867</b> <sup>[3]</sup>	6			
	60Hz	440-460V	Red	11h	<b>501.16865</b>	6		
100-300Hz	>50V	Green	10h	<b>501.16861</b> <sup>[1]</sup>	6			
>300-500Hz	>50V	Green	2h	<b>501.16862</b> <sup>[1]</sup>	6			
3P+N+E	50Hz 60Hz	100-130V	Yellow	4h	<b>501.1679</b>	6	<b>501.3279</b>	6
		208-250V	Blue	9h	<b>501.1675</b>	6	<b>501.3275</b>	6
		346-415V	Red	6h	<b>501.1687</b>	6	<b>501.3287</b>	6
		380V 50Hz / 440V 60Hz	Red	3h	<b>501.16874</b>	6		
		480-500V	Black	7h	<b>501.16876</b>	6		
	600-690V	Black	5h	<b>501.16877</b> <sup>[3]</sup>	6			
	60Hz	440-460V	Red	11h	<b>501.16875</b>	6		
>300-500Hz	>50V	Green	2h	<b>501.16872</b> <sup>[1]</sup>	6			

[1] The maximum amount of current available, taking into account the maximum overheating temperature allowed by the relevant standards, must be downgraded with respect to the nominal current by 25% for products with frequencies ranging above 100 Hz; contact Scame Technical Service for further information.

[2] When using DC we recommend that you make sure of implementing the protection scheme that is most suitable for the system involved; contact Scame Technical Service for further information.

[3] Pay special attention when selecting the appropriate fuse with respect to the tension of the installation.

- Supplied with stainless steel fixing screws.
- Note: in case of mounting with ADVANCE2 System, use METRIC drilling point mark.
- Blank side with drilling point mark
- Fuses not supplied

# Switched interlocked sockets outlets

## OMNIA Series



■ Rated voltage >50V >> With fuse carrier >> Surface mounting

OMNIA Series

506.



IP66/IP67

INTERLOCKED SOCKET

IP66/IP67

136x125mm

Poles	Hz	Volt	Colour	h	16A		32A			
					Part No.	Quantity	Part No.	Quantity		
2P+E	50Hz 60Hz	100-130V	Yellow	4h	<b>506.1670</b>	6	<b>506.3270</b>	6		
		200-250V	Blue	6h	<b>506.1683</b>	6	<b>506.3283</b>	6		
		380-415V	Red	9h	<b>506.1678</b>	6	<b>506.3278</b>	6		
		480-500V	Black	7h	<b>506.16836</b>	6				
		TST>50V	Grey	12h	<b>506.16833</b>	6				
	>300-500Hz	>50V	Green	2h	<b>506.16832</b> <sup>[1]</sup>	6				
		DC	>50-250V	Grey	3h	<b>506.16834</b> <sup>[2]</sup>	6			
			>250V	Grey	8h	<b>506.16838</b> <sup>[2]</sup>	6			
		3P+E	50Hz 60Hz	100-130V	Yellow	4h	<b>506.1672</b>	6	<b>506.3272</b>	6
				200-250V	Blue	9h	<b>506.1674</b>	6	<b>506.3274</b>	6
380-415V	Red			6h	<b>506.1686</b>	6	<b>506.3286</b>	6		
380V 50Hz / 440V 60Hz	Black			3h	<b>506.16864</b>	6				
480-500V	Black			7h	<b>506.16866</b>	6				
>300-500Hz	600-690V		Black	5h	<b>506.16867</b> <sup>[3]</sup>	6				
	60Hz		440-460V	Red	11h	<b>506.16865</b>	6			
	100-300Hz		>50V	Green	10h	<b>506.16861</b> <sup>[1]</sup>	6			
	>300-500Hz		>50V	Green	2h	<b>506.16862</b> <sup>[1]</sup>	6			
	3P+N+E		50Hz 60Hz	100-130V	Yellow	4h	<b>506.1679</b>	6	<b>506.3279</b>	6
208-250V		Blue		9h	<b>506.1675</b>	6	<b>506.3275</b>	6		
346-415V		Red		6h	<b>506.1687</b>	6	<b>506.3287</b>	6		
380V 50Hz / 440V 60Hz		Black		3h	<b>506.16874</b>	6				
480-500V		Black		7h	<b>506.16876</b>	6				
>300-500Hz		600-690V	Black	5h	<b>506.16877</b> <sup>[3]</sup>	6				
		60Hz	440-460V	Red	11h	<b>506.16875</b>	6			
		>300-500Hz	>50V	Green	2h	<b>506.16872</b> <sup>[1]</sup>	6			

[1] The maximum amount of current available, taking into account the maximum overheating temperature allowed by the relevant standards, must be downgraded with respect to the nominal current by 25% for products with frequencies ranging above 100 Hz; contact Scame Technical Service for further information.

[2] When using DC we recommend that you make sure of implementing the protection scheme that is most suitable for the system involved; contact Scame Technical Service for further information.

[3] Pay special attention when selecting the appropriate fuse with respect to the tension of the installation.

- Supplied with stainless steel fixing screws.
- Note: in case of mounting with ADVANCE2 System, use METRIC drilling point mark.
- Blank side with drilling point mark
- Fuses not supplied

1.3



## Switched interlocked sockets outlets OMNIA Series

### ■ Extra low voltage <50V >> Flush mounting (with safety transformer)

OMNIA Series

1

INDUSTRY

400.

405.



With safety transformer  
- IP44

With safety transformer  
- IP66/IP67

INTERLOCKED SOCKET

IP44

IP66/IP67

136x125mm

Current	Poles	Hz	Volt	Colour	400.2416	6	405.2416	6
16A	2P	50Hz 60Hz	20-25V		<b>400.2416</b>	6	<b>405.2416</b>	6

SELV transformer 220/24V~ 60VA ( continuous duty)

- Unsuitable for ADVANCE2 System. Use box ref. 572.0309
- When plug is inserted a micro-switch is activated and closes the circuit

### ■ Extra low voltage <50V >> Flush mounting (without safety transformer)

OMNIA Series

400.

405.



Without safety transformer - IP44

Without safety transformer - IP66/IP67

INTERLOCKED SOCKET

IP44

IP66/IP67

136x125mm

Current	Poles	Hz	Volt	Colour	h	400.2420	6	405.2420	6
16A	2P	50Hz 60Hz	20-25V		12h	<b>400.2420</b>	6	<b>405.2420</b>	6
			40-50V		12h	<b>400.2421</b>	6	<b>405.2421</b>	6
32A			20-25V			<b>400.2620</b>	6	<b>405.2620</b>	6
			40-50V		12h	<b>400.2621</b>	6	<b>405.2621</b>	6

- The versions without transformer are particularly suitable for installations with centralised extra-low voltage transformer.
- When plug is inserted a micro-switch is activated and closes the circuit

# Switched interlocked sockets outlets OMNIA Series



■ Extra low voltage <50V >> Surface mounting

### OMNIA Series

500.

505.



Without safety transformer - IP44

Without safety transformer - IP66/IP67

### INTERLOCKED SOCKET

IP44

IP66/IP67

136x125mm

Current	Poles	Hz	Volt	Colour	h	500.2420	6	505.2420	6
16A	2P	50Hz 60Hz	20-25V			<b>500.2420</b>	6	<b>505.2420</b>	6
			40-50V		12h	<b>500.2421</b>	6	<b>505.2421</b>	6
32A			20-25V			<b>500.2620</b>	6	<b>505.2620</b>	6
			40-50V		12h	<b>500.2621</b>	6	<b>505.2621</b>	6

- The versions without transformer are particularly suitable for installations with centralised extra-low voltage transformer.
- Note: in case of mounting with ADVANCE2 System, use METRIC drilling point mark.
- When plug is inserted a micro-switch is activated and closes the circuit
- Blank side with drilling point mark



OMNIA Series  
Flange 136x125mm

1.3



# Switched interlocked sockets outlets

## OMNIAPLUS Series

### Flush mounting

#### OMNIAPLUS Series

409.



Without protection



Protection with fuse 6.3x32



Protection with MCB



Protection with RCBO

#### DOMESTIC INTERLOCKED SOCKET

2P+E

IP56

Current	Version	Without protection	Protection with fuse 6.3x32	Protection with MCB	Protection with RCBO
6A 16A	INDIAN	409.0429 1/6	409.1429 1/6	409.2429 1/6	409.3429 1/6
	SWISS	409.0417 1/6	409.1417 <sup>[2]</sup> 1/6	409.2417 1/6	409.3417 1/6
10A	ARGENTINE	409.0424 1/6	409.1424 <sup>[2]</sup> 1/6	409.2424 <sup>[3]</sup> 1/6	409.3424 <sup>[3]</sup> 1/6
	BRAZILIAN	409.0421 1/6	409.1421 <sup>[2]</sup> 1/6	409.2421 1/6	409.3421 1/6
	NEW ZELAND	409.0427 1/6	409.1427 1/6	409.2427 1/6	409.3427 1/6
13A	BRITISH BS1363	409.0413 1/6	409.1413 1/6	409.2413 1/6	409.3413 1/6
	ITALIAN P17/11 (DUAL USE)	409.0403 1/6	409.1403 <sup>[2]</sup> 1/6	409.2403 1/6	409.3403 1/6
	FRENCH	409.0411 1/6	409.1411 <sup>[2]</sup> 1/6	409.2411 1/6	409.3411 1/6
	GERMAN	409.0407 1/6	409.1407 <sup>[2]</sup> 1/6	409.2407 1/6	409.3407 1/6
16A	ITALIAN P30	409.0404 1/6	409.1404 <sup>[2]</sup> 1/6	409.2404 1/6	409.3404 1/6
	ITALIAN P40	409.0405 1/6	409.1405 <sup>[2]</sup> 1/6	409.2405 1/6	409.3405 1/6
	SOUTH AFRICAN	409.0428 1/6	409.1428 1/6	409.2428 1/6	409.3428 1/6
	GERMAN UNSHUTTER	409.0412 <sup>[1]</sup> 1/6	409.1412 <sup>[1]</sup> 1/6	409.2412 <sup>[1]</sup> 1/6	409.3412 <sup>[1]</sup> 1/6

<sup>[1]</sup> Shutterless socket, subject to normative restrictions or prohibitions in Europe or in other geographical areas. Check the national laws prior to using or installing it.

<sup>[2]</sup> Fuses supplied

<sup>[3]</sup> 10A (C10)



**ITALIAN STANDARD P17/11 16A (bivalente)**  
Shuttered socket CEI 23-50



**FRENCH STANDARD 16A**  
Shuttered socket



**FRENCH-GERMAN STANDARD 16A**  
Shuttered socket



**ITALIAN STANDARD P30 - 16A**  
Shuttered socket CEI 23-50



**PLURISTANDARD P40 16A**  
Shuttered socket



**BRITISH STANDARD 13A**  
Shuttered socket BS 1363-2



**SWISS STANDARD 10A**  
Unshuttered socket SEV 1011:1998



**ARGENTINIAN STANDARD 10A**  
Unshuttered socket



# Switched interlocked sockets outlets

## OMNIAPLUS Series



### Domestic interlocked socket

OMNIAPLUS Series

409.



Description	IP	Accessories
EMPTY DOMESTIC INTER. SOCKET	IP56	<b>409.0400</b> 1/6

- Not suitable with English, South African and Indian standards EVOLUTION Series socket outlets.



**OMNIAPLUS Series**  
Application examples (MBOX - OMNIA- ADVANCE2 - DOMINO)

1.3



**BRAZILIAN STANDARD 10A**  
Unshuttered socket ABNT NBR 14136:2002



**NEW ZEALAND STANDARD 10A**  
Unshuttered socket AS/NZS 3112



**SOUTH AFRICAN STANDARD 16A**  
Shuttered socket SANS 164:1 (2006)



**INDIAN STANDARD 6/16A**  
Shuttered socket IS 1293:1988



**GERMAN STANDARD 16A**  
Unshuttered socket



**IP66**  
Specifically high formulated gel seal to maintain protection degree when the plug is inserted

# Switched interlocked sockets outlets

## OMNIA System

### Flush and surface mounting modular system

1  
INDUSTRY

#### OMNIA System

572.



#### Components for flush mounting installation

		BOX	BOX FOR PLASTERBOARD WALLS	COUPLING INSERT	FRAME
2	<b>Dimension</b>				IP55
3	160x149x72mm	<b>572.0200</b> <sup>1</sup> <sub>2</sub>	6		
4	160x149x75mm		<b>572.0205</b> <sup>1</sup> <sub>2</sub>	6	
	174x163x19mm				<b>572.0220</b> <sup>3</sup> <sub>4</sub> 6/60
				<b>572.0210</b> 6/60	

- <sup>1</sup> Complete with coupling insert
- <sup>2</sup> Suited for being walled up in buried systems
- <sup>3</sup> IP55 when assembled together with the relevant component.
- <sup>4</sup> To be used in conjunction with flush-mounted boxes

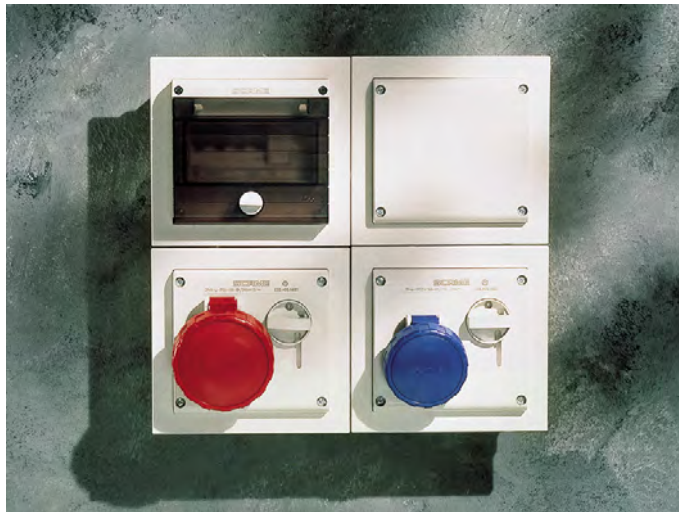

#### OMNIA System

Example of a flush mounting combination: consumer unit, junction box and OMNIA Series interlocked-switch socket outlet. IP55 weatherproof.

# Switched interlocked sockets outlets OMNIA System



## ■ Flush and surface mounting modular system

### OMNIA System

572.



### Components for surface mounting installation - Box

Dimension	Notes	BOX		ENCLOSURE FOR SWITCH		BOX	
				IP67			
135x125x70mm	16-32A	<b>572.0310</b>	<sup>1</sup> <sup>2</sup> <sup>3</sup>	6			
135x275x89mm	63A					<b>572.0308</b>	1/6
136x125x85mm	OMNIA				<b>572.3390</b>	<sup>4</sup>	6
136x125x98mm	32A FUSE	<b>572.0309</b>		6			

<sup>1</sup> When joined with consumer unit (product 572.0120) [10W]

<sup>2</sup> Not suitable for items 400.2416 and 405.2416.

<sup>3</sup> Except 32A fuse versions.

<sup>4</sup> For fitting with Y1 switch size panel mounting version (R) and relevant front operators handleless (IP65).

- Blank side with drilling point mark
- IP67 when assembled together with the relevant component.

## ■ Components for surface mounting installation - Equipment enclosure MBOX

### OMNIA System

572.



Blank cover



2 OMNIA

Dimension	Notes	BOX FOR WIRING ACCESSORIES			
		IP67			
136x275mm	2 OMNIA	<b>572.0320</b>	<sup>1</sup>	1/6	1/10

<sup>1</sup> IP67 when assembled together with the relevant component.

- Hole Ø 40.5 mm on the upper side
- They can be fitted into the MBOX5 enclosures
- For cable output, use tear-resistant cable glands fam. 805.
- Blank side with drilling point mark

1.3



# Switched interlocked sockets outlets OMNIA System

## Components for surface mounting installation

1  
INDUSTRY

### OMNIA System

572.



2 OMNIA + consumer units [6 DIN]



3 OMNIA + consumer units [6 DIN]



4 OMNIA + consumer units [16 DIN]

### MODULAR ENCLOSURE

IP66

Dimension	Power		
136x472x146mm		<b>572.0311</b>	1
136x616x146mm	12W	<b>572.0313</b>	1
287x408x146mm			<b>572.0315</b> 1

- IP66 when coupled with the relevant component
- Power dissipation calculated in conformity with CEI 23-49 italian standards
- Blank side with drilling point mark





**OMNIA System**  
Boxes flange 136x125mm

# Switched interlocked sockets outlets OMNIA System



## Components for surface mounting installation

			OMNIA System		
			572.		
					
			<b>2 OMNIA + junction box</b>	<b>3 OMNIA + junction box</b>	<b>4 OMNIA + junction box</b>
			MODULAR ENCLOSURE		
			IP66		
<b>Dimension</b>					
136x472x146mm	<b>572.0312</b>	1			
136x616x146mm			<b>572.0314</b>	1	
287x408x146mm					<b>572.0316</b> 1

- IP66 when coupled with the relevant component
- Power dissipation calculated in conformity with CEI 23-49 italian standards
- Blank side with drilling point mark

## Common components

			OMNIA System		
			572.		
					
			<b>Consumer unit assembly</b>		
			CONSUMER UNIT ASSEMBLY		
			IP55		
<b>Dimension</b>	<b>Notes</b>				
136x125x25mm	6 DIN		<b>572.0120</b>	6	

- When joined with surface mounting box (product 572.0310) [10W]
- Complete with locking knob, triangular locking key and stainless steel fixing screws.
- Installation in the flush mounting box through the frame item 572.0220.
- DIN modules and supports included.
- The consumer unit can also be installed in the IP66 DOMINO Series surface mounting enclosures.
- Power dissipation calculated in conformity with CEI 23-49 italian standards
- IP55 when assembled together with the relevant component.

1.3



# Switched interlocked sockets outlets

## OMNIA System

### Common components

1

INDUSTRY

OMNIA System

572.



Protection cover

2

Dimension

122x98x54mm

PROTECTION COVER

IP20

572.0330

4

3

4

- Top and bottom cable entries.
- For panel mounting of OMNIA Series interlocked switch sockets outlets without fuse carrier.
- Supplied with 2 fixing screws.

# Switched interlocked sockets outlets OMNIA System



## ■ Accessories for enclosures

### ENCLOSURES ACCESSORIES

654.



Description	Dimension	Suitable for	Kit folding stand
STAND KIT - Folding	376x691x70mm	DOMINO IP66 M550 OMNIA	<b>654.0610</b> 1



#### MOBIL Series

Support for DOMINO/OMNIA assemblies. The handy folding stand allows the panel to be transported even in limited-size motor vehicles .

1.3



# Switched interlocked sockets outlets OMNIA System

## Accessories for enclosures

### ENCLOSURES ACCESSORIES

654.



### Blank plates

	BLANK PLATE FOR PANEL CUT OUTS	COVER WITH INSERT	CUT-OUT PLATE	
	OMNIA	136x125mm	16A [70x87]	32A [84x106]
Colour	IP	EVOLUTION	BTICINO	
■	IP55	<b>654.0122</b> <sup>3</sup>	<b>654.0121</b> <sup>3</sup> <sup>4</sup>	
■	IP66	<b>654.0120</b> <sup>1</sup> <sup>2</sup> 6/72		<b>654.0125</b> <sup>1</sup> <sup>2</sup> 6/72 <b>654.0126</b> <sup>1</sup> <sup>2</sup> 6/72

<sup>1</sup> Covers for OMNIA Series cutouts

<sup>2</sup> IP66 when coupled with the relevant component

<sup>3</sup> Modules snap into place.

<sup>4</sup> Manufactured with the authorization from Bticino spa company and is suitable to house "Living International", "Luna", "Light" and "Light Tech" modules which are registered trademarks owned by Bticino.

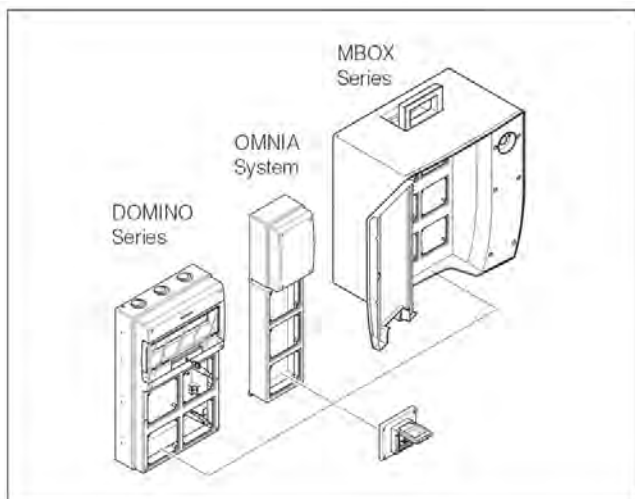

#### OMNIA Series

Examples of installation (flange 136x125mm)

1  
INDUSTRY

2

3

4



# Switched interlocked sockets outlets OMNIA System



## Accessories for enclosures

### ENCLOSURES ACCESSORIES

654.



Description	Notes	Colour	Din	Blank plate for DIN modules	
BLANK PLATE FOR DIN MODULES	9x45mm		1/2 DIN	<b>654.0420</b> <sup>[1]</sup>	25/400
	18x45mm	Grey	1 DIN	<b>654.0410</b> <sup>[1]</sup>	25/250
	72x45mm		4 DIN	<b>654.0400</b>	25

<sup>[1]</sup> To be fixed on DIN rail

- When put between the modular devices these plates help to dissipate heat

### TOP22 Series

590.



Description	Colour	Switch size	Contact blocks	
NC CONTACT	Red	Y1	<b>590.PL004001</b> <sup>[1]</sup>	10/60
		Y2	<b>590.PL004003</b> <sup>[1]</sup>	10
NO CONTACT	Green	Y1	<b>590.PL004002</b> <sup>[2]</sup>	10/60
		Y2	<b>590.PL004004</b> <sup>[2]</sup>	10

<sup>[1]</sup> NC=Normally closed

<sup>[2]</sup> NO=Normally open

- Snap catch

1.3



# Switched interlocked sockets outlets

## ADVANCE2 Series

■ Rated operating voltage >50V >> Standard version

### ADVANCE 2 Series

560.



Without fuse carrier IP44

#### INTERLOCKED SOCKET

IP44

106x240mm

M25X1,5

Poles	Hz	Volt	Colour	h	16A		32A		
					Part No.	1/12	Part No.	1/12	
2P+E	50Hz 60Hz	100-130V	Yellow	4h	<b>560.1670</b>	1/12	<b>560.3270</b>	1/12	
		200-250V	Blue	6h	<b>560.1683</b>	1/12	<b>560.3283</b>	1/12	
		380-415V	Red	9h	<b>560.1678</b>	1/12	<b>560.3278</b>	1/12	
		480-500V	Black	7h	<b>560.16836</b>	1/12	<b>560.32836</b>	1/12	
		TST>50V	Grey	12h	<b>560.16833</b>	1/12	<b>560.32833</b>	1/12	
	>300-500Hz	>50V	Green	2h	<b>560.16832</b> <sup>[1]</sup>	1/12	<b>560.32832</b> <sup>[1]</sup>	1/12	
	DC	>50-250V	Grey	3h	<b>560.16834</b> <sup>[2]</sup>	1/12	<b>560.32834</b> <sup>[2]</sup>	1/12	
		>250V	Grey	8h	<b>560.16838</b> <sup>[2]</sup>	1/12	<b>560.32838</b> <sup>[2]</sup>	1/12	
	3P+E	50Hz 60Hz	100-130V	Yellow	4h	<b>560.1672</b>	1/12	<b>560.3272</b>	1/12
			200-250V	Blue	9h	<b>560.1674</b>	1/12	<b>560.3274</b>	1/12
380-415V			Red	6h	<b>560.1686</b>	1/12	<b>560.3286</b>	1/12	
380V 50Hz / 440V 60Hz			Red	3h	<b>560.16864</b>	1/12	<b>560.32864</b>	1/12	
480-500V			Black	7h	<b>560.16866</b>	1/12	<b>560.32866</b>	1/12	
60Hz		440-460V	Red	11h	<b>560.16865</b>	1/12	<b>560.32865</b>	1/12	
600-690V		Black	5h	<b>560.16867</b> <sup>[3]</sup>	1/12	<b>560.32867</b> <sup>[3]</sup>	1/12		
100-300Hz		>50V	Green	10h	<b>560.16861</b> <sup>[1]</sup>	1/12	<b>560.32861</b> <sup>[1]</sup>	1/12	
>300-500Hz		>50V	Green	2h	<b>560.16862</b> <sup>[1]</sup>	1/12	<b>560.32862</b> <sup>[1]</sup>	1/12	
3P+N+E		50Hz 60Hz	100-130V	Yellow	4h	<b>560.1679</b>	1/12	<b>560.3279</b>	1/12
	208-250V		Blue	9h	<b>560.1675</b>	1/12	<b>560.3275</b>	1/12	
	346-415V		Red	6h	<b>560.1687</b>	1/12	<b>560.3287</b>	1/12	
	380V 50Hz / 440V 60Hz		Red	3h	<b>560.16874</b>	1/12	<b>560.32874</b>	1/12	
	480-500V		Black	7h	<b>560.16876</b>	1/12	<b>560.32876</b>	1/12	
	60Hz	440-460V	Red	11h	<b>560.16875</b>	1/12	<b>560.32875</b>	1/12	
	600-690V	Black	5h	<b>560.16877</b> <sup>[3]</sup>	1/12	<b>560.32877</b> <sup>[3]</sup>	1/12		
	>300-500Hz	>50V	Green	2h	<b>560.16872</b> <sup>[1]</sup>	1/12	<b>560.32872</b> <sup>[1]</sup>	1/12	

[1] The maximum amount of current available, taking into account the maximum overheating temperature allowed by the relevant standards, must be downgraded with respect to the nominal current by 25% for products with frequencies ranging above 100 Hz; contact Scame Technical Service for further information.

[2] When using DC we recommend that you make sure of implementing the protection scheme that is most suitable for the system involved; contact Scame Technical Service for further information.

[3] Pay special attention when selecting the appropriate fuse with respect to the tension of the installation.

- Supplied with stainless steel fixing screws.
- Open threaded cable entry
- Cable gland included
- Threaded cap/cable sleeve included

1  
INDUSTRY

2

3

4

# Switched interlocked sockets outlets

## ADVANCE2 Series



■ Rated operating voltage >50V >> Standard version

### ADVANCE 2 Series

561.



Without fuse carrier  
IP66/IP67

### INTERLOCKED SOCKET

IP66/IP67

Poles	Hz	Volt	Colour	h	106x240mm M25X1,5						136x390mm M40X1,5			
					16A		32A		63A					
2P+E	50Hz 60Hz	100-130V	Yellow	4h	<b>561.1670</b>	1/12	<b>561.3270</b>	1/12	<b>561.6370</b> <sup>[4]</sup>	1/4				
		200-250V	Blue	6h	<b>561.1683</b>	1/12	<b>561.3283</b>	1/12	<b>561.6383</b> <sup>[4]</sup>	1/4				
		380-415V	Red	9h	<b>561.1678</b>	1/12	<b>561.3278</b>	1/12	<b>561.6378</b> <sup>[4]</sup>	1/4				
		480-500V	Black	7h	<b>561.16836</b>	1/12	<b>561.32836</b>	1/12	<b>561.63836</b> <sup>[4]</sup>	1/4				
		TST>50V	Grey	12h	<b>561.16833</b>	1/12	<b>561.32833</b>	1/12	<b>561.63833</b> <sup>[4]</sup>	1/4				
	>300-500Hz	>50V	Green	2h	<b>561.16832</b> <sup>[1]</sup>	1/12	<b>561.32832</b> <sup>[1]</sup>	1/12						
		DC	>50-250V	Grey	3h	<b>561.16834</b> <sup>[2]</sup>	1/12	<b>561.32834</b> <sup>[2]</sup>	1/12	<b>561.63834</b> <sup>[2][4]</sup>	1/4			
			>250V	Grey	8h	<b>561.16838</b> <sup>[2]</sup>	1/12	<b>561.32838</b> <sup>[2]</sup>	1/12	<b>561.63838</b> <sup>[2][4]</sup>	1/4			
		3P+E	50Hz 60Hz	100-130V	Yellow	4h	<b>561.1672</b>	1/12	<b>561.3272</b>	1/12	<b>561.6372</b> <sup>[4]</sup>	1/4		
				200-250V	Blue	9h	<b>561.1674</b>	1/12	<b>561.3274</b>	1/12	<b>561.6374</b> <sup>[4]</sup>	1/4		
380-415V	Red			6h	<b>561.1686</b>	1/12	<b>561.3286</b>	1/12	<b>561.6386</b> <sup>[4]</sup>	1/4				
380V 50Hz / 440V 60Hz	Red			3h	<b>561.16864</b>	1/12	<b>561.32864</b>	1/12						
480-500V	Black			7h	<b>561.16866</b>	1/12	<b>561.32866</b>	1/12	<b>561.63866</b> <sup>[4]</sup>	1/4				
>300-500Hz	600-690V		Black	5h	<b>561.16867</b> <sup>[3]</sup>	1/12	<b>561.32867</b> <sup>[3]</sup>	1/12	<b>561.63867</b> <sup>[3][4]</sup>	1/4				
	60Hz		440-460V	Red	11h	<b>561.16865</b>	1/12	<b>561.32865</b>	1/12	<b>561.63865</b> <sup>[4]</sup>	1/4			
	100-300Hz		>50V	Green	10h	<b>561.16861</b> <sup>[1]</sup>	1/12	<b>561.32861</b> <sup>[1]</sup>	1/12					
	>300-500Hz		>50V	Green	2h	<b>561.16862</b> <sup>[1]</sup>	1/12	<b>561.32862</b> <sup>[1]</sup>	1/12					
	3P+N+E		50Hz 60Hz	100-130V	Yellow	4h	<b>561.1679</b>	1/12	<b>561.3279</b>	1/12	<b>561.6379</b> <sup>[4]</sup>	1/4		
208-250V		Blue		9h	<b>561.1675</b>	1/12	<b>561.3275</b>	1/12	<b>561.6375</b> <sup>[4]</sup>	1/4				
346-415V		Red		6h	<b>561.1687</b>	1/12	<b>561.3287</b>	1/12	<b>561.6387</b> <sup>[4]</sup>	1/4				
380V 50Hz / 440V 60Hz		Red		3h	<b>561.16874</b>	1/12	<b>561.32874</b>	1/12						
480-500V		Black		7h	<b>561.16876</b>	1/12	<b>561.32876</b>	1/12	<b>561.63876</b> <sup>[4]</sup>	1/4				
>300-500Hz		600-690V	Black	5h	<b>561.16877</b> <sup>[3]</sup>	1/12	<b>561.32877</b> <sup>[3]</sup>	1/12	<b>561.63877</b> <sup>[3][4]</sup>	1/4				
		60Hz	440-460V	Red	11h	<b>561.16875</b>	1/12	<b>561.32875</b>	1/12	<b>561.63875</b> <sup>[4]</sup>	1/4			
		>300-500Hz	>50V	Green	2h	<b>561.16872</b> <sup>[1]</sup>	1/12	<b>561.32872</b> <sup>[1]</sup>	1/12					

[1] The maximum amount of current available, taking into account the maximum overheating temperature allowed by the relevant standards, must be downgraded with respect to the nominal current by 25% for products with frequencies ranging above 100 Hz; contact Scame Technical Service for further information.

[2] When using DC we recommend that you make sure of implementing the protection scheme that is most suitable for the system involved; contact Scame Technical Service for further information.

[3] Pay special attention when selecting the appropriate fuse with respect to the tension of the installation.

[4] [LARGE] Possibility to enter from the bottom (smooth walls with drilling point mark)

- Supplied with stainless steel fixing screws.
- Open threaded cable entry
- Cable gland included
- Threaded cap/cable sleeve included

1.3



# Switched interlocked sockets outlets

## ADVANCE2 Series

■ Rated operating voltage >50V >> Standard version [FUSE]

### ADVANCE 2 Series

562.



With fuse carrier IP44

#### INTERLOCKED SOCKET

IP44

106x240mm

M25X1,5

Poles	Hz	Volt	Colour	h	16A		32A		
					Part No.	1/12	Part No.	1/12	
2P+E	50Hz 60Hz	100-130V	Yellow	4h	<b>562.1670</b>	1/12	<b>562.3270</b>	1/12	
		200-250V	Blue	6h	<b>562.1683</b>	1/12	<b>562.3283</b>	1/12	
		380-415V	Red	9h	<b>562.1678</b>	1/12	<b>562.3278</b>	1/12	
		480-500V	Black	7h	<b>562.16836</b>	1/12	<b>562.32836</b>	1/12	
		TST>50V	Grey	12h	<b>562.16833</b>	1/12	<b>562.32833</b>	1/12	
	>300-500Hz	>50V	Green	2h	<b>562.16832</b> <sup>[1]</sup>	1/12	<b>562.32832</b> <sup>[1]</sup>	1/12	
	DC	>50-250V	Grey	3h	<b>562.16834</b> <sup>[2]</sup>	1/12	<b>562.32834</b> <sup>[2]</sup>	1/12	
		>250V	Grey	8h	<b>562.16838</b> <sup>[2]</sup>	1/12	<b>562.32838</b> <sup>[2]</sup>	1/12	
	3P+E	50Hz 60Hz	100-130V	Yellow	4h	<b>562.1672</b>	1/12	<b>562.3272</b>	1/12
			200-250V	Blue	9h	<b>562.1674</b>	1/12	<b>562.3274</b>	1/12
380-415V			Red	6h	<b>562.1686</b>	1/12	<b>562.3286</b>	1/12	
380V 50Hz / 440V 60Hz			Red	3h	<b>562.16864</b>	1/12	<b>562.32864</b>	1/12	
480-500V			Black	7h	<b>562.16866</b>	1/12	<b>562.32866</b>	1/12	
60Hz		440-460V	Red	11h	<b>562.16865</b>	1/12	<b>562.32865</b>	1/12	
600-690V		Black	5h	<b>562.16867</b> <sup>[3]</sup>	1/12	<b>562.32867</b> <sup>[3]</sup>	1/12		
100-300Hz		>50V	Green	10h	<b>562.16861</b> <sup>[1]</sup>	1/12	<b>562.32861</b> <sup>[1]</sup>	1/12	
>300-500Hz		>50V	Green	2h	<b>562.16862</b> <sup>[1]</sup>	1/12	<b>562.32862</b> <sup>[1]</sup>	1/12	
3P+N+E		50Hz 60Hz	100-130V	Yellow	4h	<b>562.1679</b>	1/12	<b>562.3279</b>	1/12
	208-250V		Blue	9h	<b>562.1675</b>	1/12	<b>562.3275</b>	1/12	
	346-415V		Red	6h	<b>562.1687</b>	1/12	<b>562.3287</b>	1/12	
	380V 50Hz / 440V 60Hz		Red	3h	<b>562.16874</b>	1/12	<b>562.32874</b>	1/12	
	480-500V		Black	7h	<b>562.16876</b>	1/12	<b>562.32876</b>	1/12	
	60Hz	440-460V	Red	11h	<b>562.16875</b>	1/12	<b>562.32875</b>	1/12	
	600-690V	Black	5h	<b>562.16877</b> <sup>[3]</sup>	1/12	<b>562.32877</b> <sup>[3]</sup>	1/12		
	>300-500Hz	>50V	Green	2h	<b>562.16872</b> <sup>[1]</sup>	1/12	<b>562.32872</b> <sup>[1]</sup>	1/12	

[1] The maximum amount of current available, taking into account the maximum overheating temperature allowed by the relevant standards, must be downgraded with respect to the nominal current by 25% for products with frequencies ranging above 100 Hz; contact Scame Technical Service for further information.

[2] When using DC we recommend that you make sure of implementing the protection scheme that is most suitable for the system involved; contact Scame Technical Service for further information.

[3] Pay special attention when selecting the appropriate fuse with respect to the tension of the installation.

- Supplied with stainless steel fixing screws.
- Open threaded cable entry
- Cable gland included
- Threaded cap/cable sleeve included
- Fuses not supplied

1

INDUSTRY

2

3

4

# Switched interlocked sockets outlets

## ADVANCE2 Series



### Rated operating voltage >50V >> Standard version [FUSE]

#### ADVANCE 2 Series

563.



With fuse carrier IP66/  
IP67

#### INTERLOCKED SOCKET

IP66/IP67

106x240mm

136x390mm

M25X1,5

M40X1,5

Poles	Hz	Volt	Colour	h	106x240mm		136x390mm				
					16A	32A	63A				
2P+E	50Hz 60Hz	100-130V	Yellow	4h	<b>563.1670</b>	1/12	<b>563.3270</b>	1/12	<b>563.6370</b> <sup>[4]</sup>	1/4	
		200-250V	Blue	6h	<b>563.1683</b>	1/12	<b>563.3283</b>	1/12	<b>563.6383</b> <sup>[4]</sup>	1/4	
		380-415V	Red	9h	<b>563.1678</b>	1/12	<b>563.3278</b>	1/12	<b>563.6378</b> <sup>[5][4]</sup>	1/4	
		480-500V	Black	7h	<b>563.16836</b>	1/12	<b>563.32836</b>	1/12			
		TST>50V	Grey	12h	<b>563.16833</b>	1/12	<b>563.32833</b>	1/12	<b>563.63833</b> <sup>[4]</sup>	1/4	
	>300-500Hz	>50V	Green	2h	<b>563.16832</b> <sup>[1]</sup>	1/12	<b>563.32832</b> <sup>[1]</sup>	1/12			
		DC	>50-250V	Grey	3h	<b>563.16834</b> <sup>[2]</sup>	1/12	<b>563.32834</b> <sup>[2]</sup>	1/12	<b>563.63834</b> <sup>[2][4]</sup>	1/4
	3P+E	50Hz 60Hz	100-130V	Yellow	4h	<b>563.1672</b>	1/12	<b>563.3272</b>	1/12	<b>563.6372</b> <sup>[4]</sup>	1/4
			200-250V	Blue	9h	<b>563.1674</b>	1/12	<b>563.3274</b>	1/12	<b>563.6374</b> <sup>[4]</sup>	1/4
			380-415V	Red	6h	<b>563.1686</b>	1/12	<b>563.3286</b>	1/12	<b>563.6386</b> <sup>[5][4]</sup>	1/4
380V 50Hz / 440V 60Hz			Black	3h	<b>563.16864</b>	1/12	<b>563.32864</b>	1/12			
480-500V			Black	7h	<b>563.16866</b>	1/12	<b>563.32866</b>	1/12			
60Hz		600-690V	Black	5h	<b>563.16867</b> <sup>[3]</sup>	1/12	<b>563.32867</b> <sup>[3]</sup>	1/12			
		440-460V	Red	11h	<b>563.16865</b>	1/12	<b>563.32865</b>	1/12			
100-300Hz		>50V	Green	10h	<b>563.16861</b> <sup>[1]</sup>	1/12	<b>563.32861</b> <sup>[1]</sup>	1/12			
>300-500Hz		>50V	Green	2h	<b>563.16862</b> <sup>[1]</sup>	1/12	<b>563.32862</b> <sup>[1]</sup>	1/12			
3P+N+E		50Hz 60Hz	100-130V	Yellow	4h	<b>563.1679</b>	1/12	<b>563.3279</b>	1/12	<b>563.6379</b> <sup>[4]</sup>	1/4
	208-250V		Blue	9h	<b>563.1675</b>	1/12	<b>563.3275</b>	1/12	<b>563.6375</b> <sup>[4]</sup>	1/4	
	346-415V		Red	6h	<b>563.1687</b>	1/12	<b>563.3287</b>	1/12	<b>563.6387</b> <sup>[5][4]</sup>	1/4	
	380V 50Hz / 440V 60Hz		Black	3h	<b>563.16874</b>	1/12	<b>563.32874</b>	1/12			
	60Hz	480-500V	Black	7h	<b>563.16876</b>	1/12	<b>563.32876</b>	1/12			
		600-690V	Black	5h	<b>563.16877</b> <sup>[3]</sup>	1/12	<b>563.32877</b> <sup>[3]</sup>	1/12			
	440-460V	Red	11h	<b>563.16875</b>	1/12	<b>563.32875</b>	1/12				
	>300-500Hz	>50V	Green	2h	<b>563.16872</b> <sup>[1]</sup>	1/12	<b>563.32872</b> <sup>[1]</sup>	1/12			

[1] The maximum amount of current available, taking into account the maximum overheating temperature allowed by the relevant standards, must be downgraded with respect to the nominal current by 25% for products with frequencies ranging above 100 Hz; contact Scame Technical Service for further information.

[2] When using DC we recommend that you make sure of implementing the protection scheme that is most suitable for the system involved; contact Scame Technical Service for further information.

[3] Pay special attention when selecting the appropriate fuse with respect to the tension of the installation.

[4] [LARGE] Possibility to enter from the bottom (smooth walls with drilling point mark)

[5] 400V only

- Supplied with stainless steel fixing screws.
- Open threaded cable entry
- Cable gland included
- Threaded cap/cable sleeve included
- Fuses not supplied

1.3



# Switched interlocked sockets outlets

## ADVANCE2 Series

■ Rated operating voltage >50V >> Standard version [DIN]

### ADVANCE 2 Series

567.



With DIN rail (6 modules) IP44

#### INTERLOCKED SOCKET

IP44

136x390mm

M25X1,5

Poles	Hz	Volt	Colour	h	16A		32A		
					Part No.	1/4	Part No.	1/4	
2P+E	50Hz 60Hz	100-130V	Yellow	4h	<b>567.1670</b>	1/4	<b>567.3270</b>	1/4	
		200-250V	Blue	6h	<b>567.1683</b>	1/4	<b>567.3283</b>	1/4	
		380-415V	Red	9h	<b>567.1678</b>	1/4	<b>567.3278</b>	1/4	
		480-500V	Black	7h	<b>567.16836</b>	1/4	<b>567.32836</b>	1/4	
		TST>50V	Grey	12h	<b>567.16833</b>	1/4	<b>567.32833</b>	1/4	
	>300-500Hz	>50V	Green	2h	<b>567.16832</b> <sup>[1]</sup>	1/4	<b>567.32832</b> <sup>[1]</sup>	1/4	
	DC	>50-250V	Grey	3h	<b>567.16834</b> <sup>[2]</sup>	1/4	<b>567.32834</b> <sup>[2]</sup>	1/4	
		>250V	Grey	8h	<b>567.16838</b> <sup>[2]</sup>	1/4	<b>567.32838</b> <sup>[2]</sup>	1/4	
	3P+E	50Hz 60Hz	100-130V	Yellow	4h	<b>567.1672</b>	1/4	<b>567.3272</b>	1/4
			200-250V	Blue	9h	<b>567.1674</b>	1/4	<b>567.3274</b>	1/4
380-415V			Red	6h	<b>567.1686</b>	1/4	<b>567.3286</b>	1/4	
380V 50Hz / 440V 60Hz			Red	3h	<b>567.16864</b>	1/4	<b>567.32864</b>	1/4	
480-500V			Black	7h	<b>567.16866</b>	1/4	<b>567.32866</b>	1/4	
60Hz		440-460V	Red	11h	<b>567.16865</b>	1/4	<b>567.32865</b>	1/4	
600-690V		Black	5h	<b>567.16867</b> <sup>[3]</sup>	1/4	<b>567.32867</b> <sup>[3]</sup>	1/4		
100-300Hz		>50V	Green	10h	<b>567.16861</b> <sup>[1]</sup>	1/4	<b>567.32861</b> <sup>[1]</sup>	1/4	
>300-500Hz		>50V	Green	2h	<b>567.16862</b> <sup>[1]</sup>	1/4	<b>567.32862</b> <sup>[1]</sup>	1/4	
3P+N+E		50Hz 60Hz	100-130V	Yellow	4h	<b>567.1679</b>	1/4	<b>567.3279</b>	1/4
	208-250V		Blue	9h	<b>567.1675</b>	1/4	<b>567.3275</b>	1/4	
	346-415V		Red	6h	<b>567.1687</b>	1/4	<b>567.3287</b>	1/4	
	380V 50Hz / 440V 60Hz		Red	3h	<b>567.16874</b>	1/4	<b>567.32874</b>	1/4	
	480-500V		Black	7h	<b>567.16876</b>	1/4	<b>567.32876</b>	1/4	
	60Hz	440-460V	Red	11h	<b>567.16875</b>	1/4	<b>567.32875</b>	1/4	
	600-690V	Black	5h	<b>567.16877</b> <sup>[3]</sup>	1/4	<b>567.32877</b> <sup>[3]</sup>	1/4		
	>300-500Hz	>50V	Green	2h	<b>567.16872</b> <sup>[1]</sup>	1/4	<b>567.32872</b> <sup>[1]</sup>	1/4	

[1] The maximum amount of current available, taking into account the maximum overheating temperature allowed by the relevant standards, must be downgraded with respect to the nominal current by 25% for products with frequencies ranging above 100 Hz; contact Scame Technical Service for further information.

[2] When using DC we recommend that you make sure of implementing the protection scheme that is most suitable for the system involved; contact Scame Technical Service for further information.

[3] Pay special attention when selecting the appropriate fuse with respect to the tension of the installation.

- Supplied with stainless steel fixing screws.
- Open threaded cable entry
- Cable gland included
- Threaded cap/cable sleeve included
- [LARGE] Possibility to enter from the bottom (smooth walls with drilling point mark)

1  
INDUSTRY

2

3

4

# Switched interlocked sockets outlets

## ADVANCE2 Series



■ Rated operating voltage >50V >> Standard version [DIN]

### ADVANCE 2 Series

568.



With DIN rail (6 modules) IP66/IP67

#### INTERLOCKED SOCKET

IP66/IP67

136x390mm

Poles	Hz	Volt	Colour	h	M25X1,5		M40X1,5				
					16A	32A	63A				
2P+E	50Hz 60Hz	100-130V	Yellow	4h	<b>568.1670</b>	1/4	<b>568.3270</b>	1/4	<b>568.6370</b>	1/4	
		200-250V	Blue	6h	<b>568.1683</b>	1/4	<b>568.3283</b>	1/4	<b>568.6383</b>	1/4	
		380-415V	Red	9h	<b>568.1678</b>	1/4	<b>568.3278</b>	1/4	<b>568.6378</b>	1/4	
		480-500V	Black	7h	<b>568.16836</b>	1/4	<b>568.32836</b>	1/4	<b>568.63836</b>	1/4	
		TST>50V	Grey	12h	<b>568.16833</b>	1/4	<b>568.32833</b>	1/4	<b>568.63833</b>	1/4	
	>300-500Hz	>50V	Green	2h	<b>568.16832</b> <sup>[1]</sup>	1/4	<b>568.32832</b> <sup>[1]</sup>	1/4			
	DC	>50-250V	Grey	3h	<b>568.16834</b> <sup>[2]</sup>	1/4	<b>568.32834</b> <sup>[2]</sup>	1/4	<b>568.63834</b> <sup>[2]</sup>	1/4	
		>250V	Grey	8h	<b>568.16838</b> <sup>[2]</sup>	1/4	<b>568.32838</b> <sup>[2]</sup>	1/4	<b>568.63838</b> <sup>[2]</sup>	1/4	
	3P+E	50Hz 60Hz	100-130V	Yellow	4h	<b>568.1672</b>	1/4	<b>568.3272</b>	1/4	<b>568.6372</b>	1/4
			200-250V	Blue	9h	<b>568.1674</b>	1/4	<b>568.3274</b>	1/4	<b>568.6374</b>	1/4
380-415V			Red	6h	<b>568.1686</b>	1/4	<b>568.3286</b>	1/4	<b>568.6386</b>	1/4	
380V 50Hz / 440V 60Hz			Red	3h	<b>568.16864</b>	1/4	<b>568.32864</b>	1/4			
480-500V			Black	7h	<b>568.16866</b>	1/4	<b>568.32866</b>	1/4			
600-690V		Black	5h	<b>568.16867</b> <sup>[3]</sup>	1/4	<b>568.32867</b> <sup>[3]</sup>	1/4				
60Hz		440-460V	Red	11h	<b>568.16865</b>	1/4	<b>568.32865</b>	1/4			
100-300Hz		>50V	Green	10h	<b>568.16861</b> <sup>[1]</sup>	1/4	<b>568.32861</b> <sup>[1]</sup>	1/4			
>300-500Hz		>50V	Green	2h	<b>568.16862</b> <sup>[1]</sup>	1/4	<b>568.32862</b> <sup>[1]</sup>	1/4			
3P+N+E		50Hz 60Hz	100-130V	Yellow	4h	<b>568.1679</b>	1/4	<b>568.3279</b>	1/4	<b>568.6379</b>	1/4
	208-250V		Blue	9h	<b>568.1675</b>	1/4	<b>568.3275</b>	1/4	<b>568.6375</b>	1/4	
	346-415V		Red	6h	<b>568.1687</b>	1/4	<b>568.3287</b>	1/4	<b>568.6387</b>	1/4	
	380V 50Hz / 440V 60Hz		Red	3h	<b>568.16874</b>	1/4	<b>568.32874</b>	1/4			
	480-500V		Black	7h	<b>568.16876</b>	1/4	<b>568.32876</b>	1/4			
	600-690V	Black	5h	<b>568.16877</b> <sup>[3]</sup>	1/4	<b>568.32877</b> <sup>[3]</sup>	1/4				
	60Hz	440-460V	Red	11h	<b>568.16875</b>	1/4	<b>568.32875</b>	1/4			
	>300-500Hz	>50V	Green	2h	<b>568.16872</b> <sup>[1]</sup>	1/4	<b>568.32872</b> <sup>[1]</sup>	1/4			

[1] The maximum amount of current available, taking into account the maximum overheating temperature allowed by the relevant standards, must be downgraded with respect to the nominal current by 25% for products with frequencies ranging above 100 Hz; contact Scame Technical Service for further information.

[2] When using DC we recommend that you make sure of implementing the protection scheme that is most suitable for the system involved; contact Scame Technical Service for further information.

[3] Pay special attention when selecting the appropriate fuse with respect to the tension of the installation.

[4] 400V only

- Supplied with stainless steel fixing screws.
- Open threaded cable entry
- Cable gland included
- Threaded cap/cable sleeve included
- [LARGE] Possibility to enter from the bottom (smooth walls with drilling point mark)

1.3





# Switched interlocked sockets outlets

## ADVANCE2 Series

■ Rated operating voltage >50V >> HD version [HEAVY DUTY]

### ADVANCE 2 HD Series

564.



With fuse carrier IP66/  
IP67

#### INTERLOCKED SOCKET

IP66/IP67

106x240mm

136x390mm

M25X1,5

M40X1,5

Poles	Hz	Volt	Colour	h	16A		32A		63A		
2P+E	50Hz 60Hz	100-130V	Yellow	4h	<b>564.1670</b>	1/12	<b>564.3270</b>	1/12	<b>564.6370</b> <sup>[4]</sup>	1/4	
		200-250V	Blue	6h	<b>564.1683</b>	1/12	<b>564.3283</b>	1/12	<b>564.6383</b> <sup>[4]</sup>	1/4	
		380-415V	Red	9h	<b>564.1678</b>	1/12	<b>564.3278</b>	1/12	<b>564.6378</b> <sup>[5][4]</sup>	1/4	
		480-500V	Black	7h	<b>564.16836</b>	1/12	<b>564.32836</b>	1/12			
		TST>50V	Grey	12h	<b>564.16833</b>	1/12	<b>564.32833</b>	1/12	<b>564.63833</b> <sup>[4]</sup>	1/4	
	>300-500Hz	>50V	Green	2h	<b>564.16832</b> <sup>[1]</sup>	1/12	<b>564.32832</b> <sup>[1]</sup>	1/12	<b>564.63832</b> <sup>[1][4]</sup>	1/4	
	DC	>50-250V	Grey	3h	<b>564.16834</b> <sup>[2]</sup>	1/12	<b>564.32834</b> <sup>[2]</sup>	1/12	<b>564.63834</b> <sup>[2][4]</sup>	1/4	
		>250V	Grey	8h	<b>564.16838</b> <sup>[2]</sup>	1/12	<b>564.32838</b> <sup>[2]</sup>	1/12	<b>564.63838</b> <sup>[2][4]</sup>	1/4	
	3P+E	50Hz 60Hz	100-130V	Yellow	4h	<b>564.1672</b>	1/12	<b>564.3272</b>	1/12	<b>564.6372</b> <sup>[4]</sup>	1/4
			200-250V	Blue	9h	<b>564.1674</b>	1/12	<b>564.3274</b>	1/12	<b>564.6374</b> <sup>[4]</sup>	1/4
380-415V			Red	6h	<b>564.1686</b>	1/12	<b>564.3286</b>	1/12	<b>564.6386</b> <sup>[5][4]</sup>	1/4	
380V 50Hz / 440V 60Hz			Red	3h	<b>564.16864</b>	1/12	<b>564.32864</b>	1/12			
480-500V			Black	7h	<b>564.16866</b>	1/12	<b>564.32866</b>	1/12			
60Hz		440-460V	Red	11h	<b>564.16865</b>	1/12	<b>564.32865</b>	1/12			
100-300Hz		>50V	Green	10h	<b>564.16861</b> <sup>[1]</sup>	1/12	<b>564.32861</b> <sup>[1]</sup>	1/12			
>300-500Hz		>50V	Green	2h	<b>564.16862</b> <sup>[1]</sup>	1/12	<b>564.32862</b> <sup>[1]</sup>	1/12			
3P+N+E		50Hz 60Hz	100-130V	Yellow	4h	<b>564.1679</b>	1/12	<b>564.3279</b>	1/12	<b>564.6379</b> <sup>[4]</sup>	1/4
			208-250V	Blue	9h	<b>564.1675</b>	1/12	<b>564.3275</b>	1/12	<b>564.6375</b> <sup>[4]</sup>	1/4
	346-415V		Red	6h	<b>564.1687</b>	1/12	<b>564.3287</b>	1/12	<b>564.6387</b> <sup>[5][4]</sup>	1/4	
	380V 50Hz / 440V 60Hz	Red	3h	<b>564.16874</b>	1/12	<b>564.32874</b>	1/12				
	480-500V	Black	7h	<b>564.16876</b>	1/12	<b>564.32876</b>	1/12				
	600-690V	Black	5h	<b>564.16877</b> <sup>[3]</sup>	1/12	<b>564.32877</b> <sup>[3]</sup>	1/12				
	60Hz	440-460V	Red	11h	<b>564.16875</b>	1/12	<b>564.32875</b>	1/12			
>300-500Hz	>50V	Green	2h	<b>564.16872</b> <sup>[1]</sup>	1/12	<b>564.32872</b> <sup>[1]</sup>	1/12				

⚠ Heavy Duty products are especially suited to greivous working conditions and are also resistant to highly salty environments

[1] The maximum amount of current available, taking into account the maximum overheating temperature allowed by the relevant standards, must be downgraded with respect to the nominal current by 25% for products with frequencies ranging above 100 Hz; contact Scame Technical Service for further information.

[2] When using DC we recommend that you make sure of implementing the protection scheme that is most suitable for the system involved; contact Scame Technical Service for further information.

[3] Pay special attention when selecting the appropriate fuse with respect to the tension of the installation.

[4] [LARGE] Possibility to enter from the bottom (smooth walls with drilling point mark)

[5] 400V only

- Supplied with stainless steel fixing screws.
- Open threaded cable entry
- Cable gland included
- Threaded cap/cable sleeve included



# Switched interlocked sockets outlets

## ADVANCE2 Series



■ Rated operating voltage >50V >> HD version [HEAVY DUTY]

### ADVANCE 2 HD Series

569.



With DIN rail (6 modules) IP66/IP67

#### INTERLOCKED SOCKET

IP66/IP67

136x390mm

Poles	Hz	Volt	Colour	h	M25X1,5		M40X1,5				
					16A	32A	63A				
2P+E	50Hz 60Hz	100-130V	Yellow	4h	<b>569.1670</b>	1/4	<b>569.3270</b>	1/4	<b>569.6370</b>	1/4	
		200-250V	Blue	6h	<b>569.1683</b>	1/4	<b>569.3283</b>	1/4	<b>569.6383</b>	1/4	
		380-415V	Red	9h	<b>569.1678</b>	1/4	<b>569.3278</b>	1/4	<b>569.6378</b>	1/4	
		480-500V	Black	7h	<b>569.16836</b>	1/4	<b>569.32836</b>	1/4	<b>569.63836</b>	1/4	
		TST>50V	Grey	12h	<b>569.16833</b>	1/4	<b>569.32833</b>	1/4	<b>569.63833</b>	1/4	
	>300-500Hz	>50V	Green	2h	<b>569.16832</b> <sup>[1]</sup>	1/4	<b>569.32832</b> <sup>[1]</sup>	1/4	<b>569.63832</b> <sup>[1]</sup>	1/4	
	DC	>50-250V	Grey	3h	<b>569.16834</b> <sup>[2]</sup>	1/4	<b>569.32834</b> <sup>[2]</sup>	1/4	<b>569.63834</b> <sup>[2]</sup>	1/4	
		>250V	Grey	8h	<b>569.16838</b> <sup>[2]</sup>	1/4	<b>569.32838</b> <sup>[2]</sup>	1/4	<b>569.63838</b> <sup>[2]</sup>	1/4	
	3P+E	50Hz 60Hz	100-130V	Yellow	4h	<b>569.1672</b>	1/4	<b>569.3272</b>	1/4	<b>569.6372</b>	1/4
			200-250V	Blue	9h	<b>569.1674</b>	1/4	<b>569.3274</b>	1/4	<b>569.6374</b>	1/4
380-415V			Red	6h	<b>569.1686</b>	1/4	<b>569.3286</b>	1/4	<b>569.6386</b>	1/4	
380V 50Hz / 440V 60Hz			Red	3h	<b>569.16864</b>	1/4	<b>569.32864</b>	1/4			
480-500V			Black	7h	<b>569.16866</b>	1/4	<b>569.32866</b>	1/4			
60Hz		600-690V	Black	5h	<b>569.16867</b> <sup>[3]</sup>	1/4	<b>569.32867</b> <sup>[3]</sup>	1/4			
60Hz		440-460V	Red	11h	<b>569.16865</b>	1/4	<b>569.32865</b>	1/4			
100-300Hz		>50V	Green	10h	<b>569.16861</b> <sup>[1]</sup>	1/4	<b>569.32861</b> <sup>[1]</sup>	1/4			
>300-500Hz		>50V	Green	2h	<b>569.16862</b> <sup>[1]</sup>	1/4	<b>569.32862</b> <sup>[1]</sup>	1/4			
3P+N+E		50Hz 60Hz	100-130V	Yellow	4h	<b>569.1679</b>	1/4	<b>569.3279</b>	1/4	<b>569.6379</b>	1/4
	208-250V		Blue	9h	<b>569.1675</b>	1/4	<b>569.3275</b>	1/4	<b>569.6375</b>	1/4	
	346-415V		Red	6h	<b>569.1687</b>	1/4	<b>569.3287</b>	1/4	<b>569.6387</b>	1/4	
	380V 50Hz / 440V 60Hz		Red	3h	<b>569.16874</b>	1/4	<b>569.32874</b>	1/4			
	60Hz	480-500V	Black	7h	<b>569.16876</b>	1/4	<b>569.32876</b>	1/4			
		600-690V	Black	5h	<b>569.16877</b> <sup>[3]</sup>	1/4	<b>569.32877</b> <sup>[3]</sup>	1/4			
	60Hz	440-460V	Red	11h	<b>569.16875</b>	1/4	<b>569.32875</b>	1/4			
	>300-500Hz	>50V	Green	2h	<b>569.16872</b> <sup>[1]</sup>	1/4	<b>569.32872</b> <sup>[1]</sup>	1/4			

⚠ Heavy Duty products are especially suited to greivous working conditions and are also resistant to highly salty environments

[1] The maximum amount of current available, taking into account the maximum overheating temperature allowed by the relevant standards, must be downgraded with respect to the nominal current by 25% for products with frequencies ranging above 100 Hz; contact Scame Technical Service for further information.

[2] When using DC we recommend that you make sure of implementing the protection scheme that is most suitable for the system involved; contact Scame Technical Service for further information.

[3] Pay special attention when selecting the appropriate fuse with respect to the tension of the installation.

[4] 400V only

- Supplied with stainless steel fixing screws.
- Open threaded cable entry
- Cable gland included
- Threaded cap/cable sleeve included
- [LARGE] Possibility to enter from the bottom (smooth walls with drilling point mark)

1.3



## Switched interlocked sockets outlets

### ADVANCE2 Series

■ Rated operating voltage <50V

1  
INDUSTRY

#### ADVANCE 2 Series

565.



Version with safety transformer

#### INTERLOCKED SOCKET

		IP44		IP66/IP67	
		106x240mm	136x390mm	106x240mm	136x390mm
Current	Poles	M25X1,5			
16A	2P 24V	<b>565.2416</b>	1/10	<b>565.2516</b> [1][2]	1/4
				<b>565.2416/S</b>	1/10
				<b>565.2516/S</b> [1][2]	1/4

⊕ SELV transformer 220/24V~ 150VA (continuous duty).

[1] [LARGE] Possibility to enter from the bottom (smooth walls with drilling point mark)

[2] Provided protections: primary circuit (2A), secondary circuit (6A), fuses included.

- Supplied with stainless steel fixing screws.
- When plug is inserted a micro-switch is activated and closes the circuit
- Open threaded cable entry
- Cable gland included
- Threaded cap/cable sleeve included

#### ADVANCE 2 HD Series

566.



Version with safety transformer (HD - Heavy Duty)

#### INTERLOCKED SOCKET

		IP44		IP66/IP67	
		106x240mm	136x390mm	106x240mm	136x390mm
Current	Poles	M25X1,5			
16A	2P 24V	<b>566.2416</b>	1/10	<b>566.2516</b> [1][2]	1/4
				<b>566.2416/S</b>	1/10
				<b>566.2516/S</b> [1][2]	1/4

⊕ Heavy Duty products are especially suited to greivous working conditions and are also resistant to highly salty environments

⊕ SELV transformer 220/24V~ 150VA (continuous duty).

[1] [LARGE] Possibility to enter from the bottom (smooth walls with drilling point mark)

[2] Provided protections: primary circuit (2A), secondary circuit (6A), fuses included.

- Supplied with stainless steel fixing screws.
- When plug is inserted a micro-switch is activated and closes the circuit
- Open threaded cable entry
- Cable gland included
- Threaded cap/cable sleeve included

## Switched interlocked sockets outlets ADVANCE2 Series



### ■ Rated operating voltage <50V

#### ADVANCE 2 Series

565.



#### Version with DIN rail (6 modules)

#### INTERLOCKED SOCKET

IP44

IP66/IP67

106x240mm

M25X1,5

Current	Poles	Volt	Colour	h				
16A	2P	20-25V		12h	<b>565.2420</b>	1/10	<b>565.2420/S</b>	1/10
		40-50V			<b>565.2421</b>	1/10	<b>565.2421/S</b>	1/10
32A		20-25V		12h	<b>565.2432</b>	1/10	<b>565.2432/S</b>	1/10
		40-50V			<b>565.2433</b>	1/10	<b>565.2433/S</b>	1/10

- Supplied with stainless steel fixing screws.
- When plug is inserted a micro-switch is activated and closes the circuit
- Open threaded cable entry
- Cable gland included
- Threaded cap/cable sleeve included

#### ADVANCE 2 HD Series

566.



#### Version with DIN rail (6 modules) (HD - Heavy Duty)

#### INTERLOCKED SOCKET

IP44

IP66/IP67

106x240mm

M25X1,5

Current	Poles	Volt	Colour	h				
16A	2P	20-25V		12h	<b>566.2420</b>	1/10	<b>566.2420/S</b>	1/10
		40-50V			<b>566.2421</b>	1/10	<b>566.2421/S</b>	1/10
32A		20-25V		12h	<b>566.2432</b>	1/10	<b>566.2432/S</b>	1/10
		40-50V			<b>566.2433</b>	1/10	<b>566.2433/S</b>	1/10

Heavy Duty products are especially suited to greivous working conditions and are also resistant to highly salty environments

- Supplied with stainless steel fixing screws.
- When plug is inserted a micro-switch is activated and closes the circuit
- Open threaded cable entry
- Cable gland included
- Threaded cap/cable sleeve included

1.3



## Switched interlocked sockets outlets ADVANCE2 System

### ■ Standard version >> Compact module 106

#### ADVANCE 2 System

576.



1  
INDUSTRY

Description	Version	IP	Notes	Dimension	Power	Modular bases	Enclosures
CONSUMER UNIT			10 DIN	212x150x110mm	14W		
			4 DIN	106x150x110mm	8W		
JUNCTION BOX 106	CUT-OUT SINGLE	IP66	16/32A	106x150x105mm			<b>576.4301</b> <sup>[1]</sup> 12
	ONE-MODULE BLANK						
	TWO-MODULE BLANK						
MODULAR BASE 106			16-32A	106x434x18mm		<b>576.4300</b> 12	

[1] Metric break-through cable entry

[2] Power dissipation calculated in conformity with CEI 23-49 italian standards

### ■ Standard version >> Large module 136

#### ADVANCE 2 System

576.



Description	Version	IP	Notes	Dimension	Power	Modular bases	Enclosures
CONSUMER UNIT			13 DIN	272x150x110mm	17W		
			6 DIN	136x150x110mm	9W		
JUNCTION BOX 136	CUT-OUT SINGLE	IP66	16/32A	136x150x105mm			<b>576.4321</b> <sup>[1]</sup> 12
	ONE-MODULE BLANK						
	TWO-MODULE BLANK						
MODULAR BASE 136			16-32-63A	136x584x18mm		<b>576.4340</b> 6	
ENCLOSURE FOR SWITCH		IP66	ADVANCE2	136x150x105mm			

[1] Metric break-through cable entry

[2] For fitting with Y1 switch size panel mounting version (R) and relevant front operators handless (IP65).

[3] Power dissipation calculated in conformity with CEI 23-49 italian standards

# Switched interlocked sockets outlets ADVANCE2 System



## ADVANCE 2 System

576.



Consumer units

576.4302<sup>2</sup><sub>1</sub> 6



Enclosures

576.4303<sup>1</sup> 12



576.4304<sup>1</sup> 6



Consumer units

576.4305<sup>2</sup><sub>1</sub> 6

## ADVANCE 2 System

576.



Consumer units

576.4322<sup>3</sup><sub>1</sub> 6



Enclosures

576.4323<sup>1</sup> 12



576.4324<sup>1</sup> 6



Consumer units

576.4325<sup>3</sup><sub>1</sub> 6



Enclosures

576.4390<sup>2</sup><sub>1</sub> 6

1.3



## Switched interlocked sockets outlets ADVANCE2 System

### ■ HD version >> Compact module 106 HD - Heavy Duty

#### ADVANCE 2 HD System

578.



1  
INDUSTRY

Description	Version	IP	Notes	Dimension	Power	Modular bases	Enclosures
CONSUMER UNIT			10 DIN	212x150x110mm	14W		
			4 DIN	106x150x110mm	8W		
JUNCTION BOX 106	ONE-MODULE BLANK	IP66		106x150x105mm			<b>578.4301</b> <sup>[1]</sup> 12
	TWO-MODULE BLANK						
MODULAR BASE 106			16-32A	106x434x18mm		<b>578.4300</b> 12	

⚡ Heavy Duty products are especially suited to greivous working conditions and are also resistant to highly salty environments

[1] Metric break-through cable entry

[2] Power dissipation calculated in conformity with CEI 23-49 italian standards

### ■ HD version >> Large module 136 HD - Heavy Duty

#### ADVANCE 2 HD System

578.



Description	Version	IP	Notes	Dimension	Power	Modular bases	Enclosures
CONSUMER UNIT			13 DIN	272x150x110mm	17W		
			6 DIN	136x150x110mm	9W		
JUNCTION BOX 136	ONE-MODULE BLANK	IP66		136x150x105mm			<b>578.4321</b> <sup>[1]</sup> 12
	TWO-MODULE BLANK			272x150x105mm			
MODULAR BASE 136			16-32-63A	136x584x18mm		<b>578.4340</b> 6	

⚡ Heavy Duty products are especially suited to greivous working conditions and are also resistant to highly salty environments

[1] Metric break-through cable entry

[2] Power dissipation calculated in conformity with CEI 23-49 italian standards

# Switched interlocked sockets outlets ADVANCE2 System



## ADVANCE 2 HD System

578.



Consumer units



Enclosures



Consumer units

578.4302<sup>2</sup><sub>1</sub> 6

578.4304<sup>1</sup> 6

578.4305<sup>2</sup><sub>1</sub> 6

## ADVANCE 2 HD System

578.



Consumer units



Enclosures



Consumer units

578.4322<sup>2</sup><sub>1</sub> 6

578.4324<sup>1</sup> 6

578.4325<sup>2</sup><sub>1</sub> 6

1.3



# Switched interlocked sockets outlets ADVANCE2 System

■ Modular system for combination units - IP66

## ENCLOSURES ACCESSORIES

654.



### Description

### Kit accessories

TRIANGULAR LOCK KIT

**654.0079** 1/10

1  
INDUSTRY

2

3

4

## TOP22 Series

590.



Description	Colour	Switch size	Contact blocks
NC CONTACT	■	Y1	<b>590.PL004001</b> <sup>1</sup> 10/60
		Y2	<b>590.PL004003</b> <sup>1</sup> 10
NO CONTACT	■	Y1	<b>590.PL004002</b> <sup>2</sup> 10/60
		Y2	<b>590.PL004004</b> <sup>2</sup> 10

<sup>1</sup> NC=Normally closed

<sup>2</sup> NO=Normally open

- Snap catch



# Switched interlocked sockets outlets

## ADVANCE-GRP Series



### Without base IP66/IP67/IP69

#### ADVANCE GRP Series

402.



Without fuse carrier

#### INTERLOCKED SOCKET

IP66/IP67/IP69

Poles	Hz	Volt	Colour	h	130x260mm						170x380mm	
					16A		32A		63A			
2P+E	50Hz 60Hz	100-130V	Yellow	4h	<b>402.1670</b>	1/6	<b>402.3270</b>	1	<b>402.6370</b>	1		
		200-250V	Blue	6h	<b>402.1683</b>	1/6	<b>402.3283</b>	1/6	<b>402.6383</b>	1		
		380-415V	Red	9h	<b>402.1678</b>	1	<b>402.3278</b>	1	<b>402.6378</b>	1		
		480-500V	Black	7h	<b>402.16836</b>	1	<b>402.32836</b>	1	<b>402.63836</b>	1		
		TST>50V	Grey	12h	<b>402.16833</b>	1/6	<b>402.32833</b>	1	<b>402.63833</b>	1		
		>300-500Hz	>50V	Green	2h	<b>402.16832</b> <sup>[1]</sup>	1	<b>402.32832</b> <sup>[1]</sup>	1	<b>402.63832</b> <sup>[1]</sup>	1	
3P+E	50Hz 60Hz	100-130V	Yellow	4h	<b>402.1672</b>	1	<b>402.3272</b>	1/6	<b>402.6372</b>	1		
		200-250V	Blue	9h	<b>402.1674</b>	1/6	<b>402.3274</b>	1/6	<b>402.6374</b>	1		
	50Hz 60Hz	380-415V	Red	6h	<b>402.1686</b>	1/6	<b>402.3286</b>	1/6	<b>402.6386</b>	1		
		380V 50Hz / 440V 60Hz	Red	3h	<b>402.16864</b>	1	<b>402.32864</b>	1/6	<b>402.63864</b>	1		
		480-500V	Black	7h	<b>402.16866</b>	1/6	<b>402.32866</b>	1/6	<b>402.63866</b>	1		
		600-690V	Black	5h	<b>402.16867</b> <sup>[2]</sup>	1/6	<b>402.32867</b> <sup>[2]</sup>	1	<b>402.63867</b> <sup>[2]</sup>	1		
	60Hz	440-460V	Red	11h	<b>402.16865</b>	1	<b>402.32865</b>	1/6	<b>402.63865</b>	1		
	100-300Hz	>50V	Green	10h	<b>402.16861</b> <sup>[1]</sup>	1	<b>402.32861</b> <sup>[1]</sup>	1	<b>402.63861</b> <sup>[1]</sup>	1		
	>300-500Hz	>50V	Green	2h	<b>402.16862</b> <sup>[1]</sup>	1	<b>402.32862</b> <sup>[1]</sup>	1/6	<b>402.63862</b> <sup>[1]</sup>	1		
	3P+N+E	50Hz 60Hz	100-130V	Yellow	4h	<b>402.1679</b>	1	<b>402.3279</b>	1	<b>402.6379</b>	1	
208-250V			Blue	9h	<b>402.1675</b>	1	<b>402.3275</b>	1	<b>402.6375</b>	1		
50Hz 60Hz		346-415V	Red	6h	<b>402.1687</b>	1/6	<b>402.3287</b>	1/6	<b>402.6387</b>	1		
		380V 50Hz / 440V 60Hz	Red	3h	<b>402.16874</b>	1	<b>402.32874</b>	1	<b>402.63874</b>	1		
		480-500V	Black	7h	<b>402.16876</b>	1	<b>402.32876</b>	1	<b>402.63876</b>	1		
		600-690V	Black	5h	<b>402.16877</b> <sup>[2]</sup>	1	<b>402.32877</b> <sup>[2]</sup>	1	<b>402.63877</b> <sup>[2]</sup>	1		
60Hz		440-460V	Red	11h	<b>402.16875</b>	1	<b>402.32875</b>	1	<b>402.63875</b>	1		
>300-500Hz		>50V	Green	2h	<b>402.16872</b> <sup>[1]</sup>	1	<b>402.32872</b> <sup>[1]</sup>	1	<b>402.63872</b> <sup>[1]</sup>	1		

[1] The maximum amount of current available, taking into account the maximum overheating temperature allowed by the relevant standards, must be downgraded with respect to the nominal current by 25% for products with frequencies ranging above 100 Hz; contact Scame Technical Service for further information.

[2] Pay special attention when selecting the appropriate fuse with respect to the tension of the installation.

- Supplied with stainless steel fixing screws.
- Empty base: ADVANCE-GRP System (fam. 579)

1.3



# Switched interlocked sockets outlets

## ADVANCE-GRP Series

Without base IP66/IP67/IP69

ADVANCE GRP Series

403.



Without fuse carrier  
[With "i-Device"]

INTERLOCKED SOCKET

IP66/IP67/IP69

Poles	Hz	Volt	Colour	h	130x260mm						170x380mm		
					16A			32A			63A		
					16A	32A	63A	16A	32A	63A	16A	32A	63A
2P+E	50Hz 60Hz	100-130V	Yellow	4h	403.1670	1/6	403.3270	1/6	403.6370	1			
		200-250V	Blue	6h	403.1683	1/6	403.3283	1/6	403.6383	1			
		380-415V	Red	9h	403.1678	1	403.3278	1	403.6378	1			
		480-500V	Black	7h	403.16836	1	403.32836	1	403.63836	1			
		TST>50V	Grey	12h	403.16833	1	403.32833	1	403.63833	1			
		>300-500Hz	>50V	Green	2h	403.16832 <sup>[1]</sup>	1	403.32832 <sup>[1]</sup>	1	403.63832 <sup>[1]</sup>	1		
3P+E	50Hz 60Hz	100-130V	Yellow	4h	403.1672	1	403.3272	1	403.6372	1			
		200-250V	Blue	9h	403.1674	1/6	403.3274	1	403.6374	1			
		380-415V	Red	6h	403.1686	1/6	403.3286	1/6	403.6386	1			
		380V 50Hz / 440V 60Hz	Black	3h	403.16864	1	403.32864	1/6	403.63864	1			
		480-500V	Black	7h	403.16866	1	403.32866	1	403.63866	1			
		600-690V	Black	5h	403.16867 <sup>[2]</sup>	1	403.32867 <sup>[2]</sup>	1	403.63867 <sup>[2]</sup>	1			
		60Hz	440-460V	Red	11h	403.16865	1	403.32865	1	403.63865	1		
		100-300Hz	>50V	Green	10h	403.16861 <sup>[1]</sup>	1	403.32861 <sup>[1]</sup>	1	403.63861 <sup>[1]</sup>	1		
		>300-500Hz	>50V	Green	2h	403.16862 <sup>[1]</sup>	1	403.32862 <sup>[1]</sup>	1	403.63862 <sup>[1]</sup>	1		
		3P+N+E	50Hz 60Hz	100-130V	Yellow	4h	403.1679	1	403.3279	1	403.6379	1	
208-250V	Blue			9h	403.1675	1	403.3275	1	403.6375	1			
346-415V	Red			6h	403.1687	1/6	403.3287	1/6	403.6387	1			
380V 50Hz / 440V 60Hz	Black			3h	403.16874	1	403.32874	1	403.63874	1			
480-500V	Black			7h	403.16876	1	403.32876	1	403.63876	1			
600-690V	Black			5h	403.16877 <sup>[2]</sup>	1	403.32877 <sup>[2]</sup>	1	403.63877 <sup>[2]</sup>	1			
60Hz	440-460V			Red	11h	403.16875	1	403.32875	1	403.63875	1		
>300-500Hz	>50V			Green	2h	403.16872 <sup>[1]</sup>	1	403.32872 <sup>[1]</sup>	1	403.63872 <sup>[1]</sup>	1		

<sup>[1]</sup> The maximum amount of current available, taking into account the maximum overheating temperature allowed by the relevant standards, must be downgraded with respect to the nominal current by 25% for products with frequencies ranging above 100 Hz; contact Scame Technical Service for further information.

<sup>[2]</sup> Pay special attention when selecting the appropriate fuse with respect to the tension of the installation.

- Supplied with stainless steel fixing screws.
- Empty base: ADVANCE-GRP System (fam. 579)
- [i-Device]: an electronic device controls ("Intelligence Device") the status of the interlocked socket, monitoring the electrical functionality.

# Switched interlocked sockets outlets

## ADVANCE-GRP Series



### Without base IP66/IP67/IP69

#### ADVANCE GRP Series

402.



With fuse carrier

#### INTERLOCKED SOCKET

IP66/IP67/IP69

Poles	Hz	Volt	Colour	h	130x260mm			170x380mm		
					16A		32A		63A	
					Part No.	1/6	Part No.	1/6	Part No.	1/6
2P+E	50Hz 60Hz	100-130V	Yellow	4h	<b>402.1670-F</b>	1/6	<b>402.3270-F</b>	1	<b>402.6370-F</b>	1
		200-250V	Blue	6h	<b>402.1683-F</b>	1/6	<b>402.3283-F</b>	1/6	<b>402.6383-F</b>	1
		380-415V	Red	9h	<b>402.1678-F</b>	1	<b>402.3278-F</b>	1	<b>402.6378-F</b>	1
		480-500V	Black	7h	<b>402.16836-F</b>	1	<b>402.32836-F</b>	1	<b>402.63836-F</b>	1
		TST>50V	Grey	12h	<b>402.16833-F</b>	1	<b>402.32833-F</b>	1	<b>402.63833-F</b>	1
>300-500Hz	>50V	Green	2h	<b>402.16832-F<sup>[1]</sup></b>	1	<b>402.32832-F<sup>[1]</sup></b>	1	<b>402.63832-F<sup>[1]</sup></b>	1	
3P+E	50Hz 60Hz	100-130V	Yellow	4h	<b>402.1672-F</b>	1	<b>402.3272-F</b>	1	<b>402.6372-F</b>	1
		200-250V	Blue	9h	<b>402.1674-F</b>	1/6	<b>402.3274-F</b>	1	<b>402.6374-F</b>	1
	50Hz 60Hz	380-415V	Red	6h	<b>402.1686-F</b>	1/6	<b>402.3286-F</b>	1/6	<b>402.6386-F</b>	1
		380V 50Hz / 440V 60Hz	Black	3h	<b>402.16864-F</b>	1	<b>402.32864-F</b>	1/6	<b>402.63864-F</b>	1
		480-500V	Black	7h	<b>402.16866-F</b>	1	<b>402.32866-F</b>	1	<b>402.63866-F</b>	1
	60Hz	600-690V	Black	5h	<b>402.16867-F<sup>[2]</sup></b>	1/6	<b>402.32867-F<sup>[2]</sup></b>	1	<b>402.63867-F<sup>[2]</sup></b>	1
		440-460V	Red	11h	<b>402.16865-F</b>	1	<b>402.32865-F</b>	1/6	<b>402.63865-F</b>	1
	100-300Hz	>50V	Green	10h	<b>402.16861-F<sup>[1]</sup></b>	1	<b>402.32861-F<sup>[1]</sup></b>	1	<b>402.63861-F<sup>[1]</sup></b>	1
	>300-500Hz	>50V	Green	2h	<b>402.16862-F<sup>[1]</sup></b>	1	<b>402.32862-F<sup>[1]</sup></b>	1	<b>402.63862-F<sup>[1]</sup></b>	1
	3P+N+E	50Hz 60Hz	100-130V	Yellow	4h	<b>402.1679-F</b>	1	<b>402.3279-F</b>	1	<b>402.6379-F</b>
208-250V			Blue	9h	<b>402.1675-F</b>	1/6	<b>402.3275-F</b>	1/6	<b>402.6375-F</b>	1
50Hz 60Hz		346-415V	Red	6h	<b>402.1687-F</b>	1/6	<b>402.3287-F</b>	1/6	<b>402.6387-F</b>	1
		380V 50Hz / 440V 60Hz	Black	3h	<b>402.16874-F</b>	1	<b>402.32874-F</b>	1/6	<b>402.63874-F</b>	1
		480-500V	Black	7h	<b>402.16876-F</b>	1	<b>402.32876-F</b>	1	<b>402.63876-F</b>	1
600-690V		Black	5h	<b>402.16877-F<sup>[2]</sup></b>	1	<b>402.32877-F<sup>[2]</sup></b>	1	<b>402.63877-F<sup>[2]</sup></b>	1	
60Hz		440-460V	Red	11h	<b>402.16875-F</b>	1	<b>402.32875-F</b>	1/6	<b>402.63875-F</b>	1
>300-500Hz	>50V	Green	2h	<b>402.16872-F<sup>[1]</sup></b>	1	<b>402.32872-F<sup>[1]</sup></b>	1	<b>402.63872-F<sup>[1]</sup></b>	1	

<sup>[1]</sup> The maximum amount of current available, taking into account the maximum overheating temperature allowed by the relevant standards, must be downgraded with respect to the nominal current by 25% for products with frequencies ranging above 100 Hz; contact Scame Technical Service for further information.

<sup>[2]</sup> Pay special attention when selecting the appropriate fuse with respect to the tension of the installation.

- Supplied with stainless steel fixing screws.
- Empty base: ADVANCE-GRP System (fam. 579)

1.3



# Switched interlocked sockets outlets

## ADVANCE-GRP Series

Without base IP66/IP67/IP69

### ADVANCE GRP Series

403.



With fuse carrier [With "i-Device"]

### INTERLOCKED SOCKET

IP66/IP67/IP69

Poles	Hz	Volt	Colour	h	130x260mm						170x380mm		
					16A		32A		63A		63A		
2P+E	50Hz 60Hz	100-130V	Yellow	4h	403.1670-F	1	403.3270-F	1/6	403.6370-F	1			
		200-250V	Blue	6h	403.1683-F	1/6	403.3283-F	1/6	403.6383-F	1			
		380-415V	Red	9h	403.1678-F	1/6	403.3278-F	1	403.6378-F	1			
		480-500V	Black	7h	403.16836-F	1	403.32836-F	1	403.63836-F	1			
		TST>50V	Grey	12h	403.16833-F	1	403.32833-F	1	403.63833-F	1			
		>300-500Hz	>50V	Green	2h	403.16832-F <sup>[1]</sup>	1	403.32832-F <sup>[1]</sup>	1	403.63832-F <sup>[1]</sup>	1		
3P+E	50Hz 60Hz	100-130V	Yellow	4h	403.1672-F	1	403.3272-F	1	403.6372-F	1			
		200-250V	Blue	9h	403.1674-F	1	403.3274-F	1	403.6374-F	1			
	50Hz 60Hz	380-415V	Red	6h	403.1686-F	1/6	403.3286-F	1/6	403.6386-F	1			
		380V 50Hz / 440V 60Hz	Black	3h	403.16864-F	1	403.32864-F	1	403.63864-F	1			
		480-500V	Black	7h	403.16866-F	1	403.32866-F	1	403.63866-F	1			
		600-690V	Black	5h	403.16867-F <sup>[2]</sup>	1	403.32867-F <sup>[2]</sup>	1	403.63867-F <sup>[2]</sup>	1			
	60Hz	440-460V	Red	11h	403.16865-F	1	403.32865-F	1	403.63865-F	1			
	100-300Hz	>50V	Green	10h	403.16861-F <sup>[1]</sup>	1	403.32861-F <sup>[1]</sup>	1	403.63861-F <sup>[1]</sup>	1			
	>300-500Hz	>50V	Green	2h	403.16862-F <sup>[1]</sup>	1	403.32862-F <sup>[1]</sup>	1	403.63862-F <sup>[1]</sup>	1			
	3P+N+E	50Hz 60Hz	100-130V	Yellow	4h	403.1679-F	1	403.3279-F	1	403.6379-F	1		
208-250V			Blue	9h	403.1675-F	1	403.3275-F	1	403.6375-F	1			
50Hz 60Hz		346-415V	Red	6h	403.1687-F	1/6	403.3287-F	1/6	403.6387-F	1			
		380V 50Hz / 440V 60Hz	Black	3h	403.16874-F	1	403.32874-F	1/6	403.63874-F	1			
		480-500V	Black	7h	403.16876-F	1	403.32876-F	1	403.63876-F	1			
600-690V		Black	5h	403.16877-F <sup>[2]</sup>	1	403.32877-F <sup>[2]</sup>	1	403.63877-F <sup>[2]</sup>	1				
60Hz		440-460V	Red	11h	403.16875-F	1	403.32875-F	1	403.63875-F	1			
>300-500Hz	>50V	Green	2h	403.16872-F <sup>[1]</sup>	1	403.32872-F <sup>[1]</sup>	1	403.63872-F <sup>[1]</sup>	1				

<sup>[1]</sup> The maximum amount of current available, taking into account the maximum overheating temperature allowed by the relevant standards, must be downgraded with respect to the nominal current by 25% for products with frequencies ranging above 100 Hz; contact Scame Technical Service for further information.

<sup>[2]</sup> Pay special attention when selecting the appropriate fuse with respect to the tension of the installation.

- Supplied with stainless steel fixing screws.
- Empty base: ADVANCE-GRP System (fam. 579)
- [i-Device]: an electronic device controls ("Intelligence Device") the status of the interlocked socket, monitoring the electrical functionality.

# Switched interlocked sockets outlets

## ADVANCE-GRP Series



### Without base IP66/IP67/IP69

#### ADVANCE GRP Series

403.



With MCB

#### INTERLOCKED SOCKET

IP66/IP67/IP69

Poles	Hz	Volt	Colour	h	130x260mm		170x380mm			
					16A	32A	63A			
2P+E	50Hz 60Hz	100-130V	Yellow	4h	<b>403.1670-M</b>	1/6	<b>403.3270-M</b>	1/6	<b>403.6370-M</b>	1
		200-250V	Blue	6h	<b>403.1683-M</b>	1/6	<b>403.3283-M</b>	1/6	<b>403.6383-M</b>	1
		380-415V	Red	9h	<b>403.1678-M</b>	1/6	<b>403.3278-M</b>	1/6	<b>403.6378-M</b>	1
3P+E	50Hz 60Hz	100-130V	Yellow	4h	<b>403.1672-M</b>	1/6	<b>403.3272-M</b>	1/6	<b>403.6372-M</b>	1
		200-250V	Blue	9h	<b>403.1674-M</b>	1/6	<b>403.3274-M</b>	1/6	<b>403.6374-M</b>	1
		380-415V	Red	6h	<b>403.1686-M</b>	1/6	<b>403.3286-M</b>	1/6	<b>403.6386-M</b>	1
3P+N+E	50Hz 60Hz	380V 50Hz / 440V 60Hz	Red	3h	<b>403.16864-M</b>	1	<b>403.32864-M</b>	1	<b>403.63864-M</b>	1
		60Hz	440-460V		11h	<b>403.16865-M</b>	1	<b>403.32865-M</b>	1	<b>403.63865-M</b>
3P+N+E	50Hz 60Hz	100-130V	Yellow	4h	<b>403.1679-M</b>	1/6	<b>403.3279-M</b>	1/6	<b>403.6379-M</b>	1
		208-250V	Blue	9h	<b>403.1675-M</b>	1/6	<b>403.3275-M</b>	1/6	<b>403.6375-M</b>	1
		346-415V	Red	6h	<b>403.1687-M</b>	1/6	<b>403.3287-M</b>	1/6	<b>403.6387-M</b>	1
3P+N+E	60Hz	380V 50Hz / 440V 60Hz	Red	3h	<b>403.16874-M</b>	1	<b>403.32874-M</b>	1	<b>403.63874-M</b>	1
		60Hz	440-460V		11h	<b>403.16875-M</b>	1	<b>403.32875-M</b>	1	<b>403.63875-M</b>

☼ With power indicating led

- MCB = Miniature circuit breaker with thermal magnetic trip unit
- Supplied with stainless steel fixing screws.
- Empty base: ADVANCE-GRP System (fam. 579)

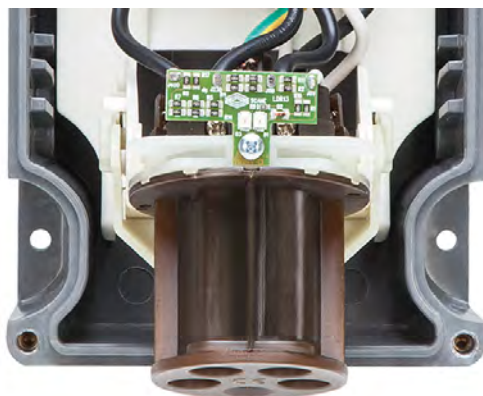

Voltage presence indicator led

1.3



# Switched interlocked sockets outlets

## ADVANCE-GRP Series

■ Surface mounting IP66 (125A)

ADVANCE GRP Series

503.



With switch-disconnector [With "i-Device"]

INTERLOCKED SOCKET

IP66

Current	Poles	Hz	Volt	Colour	h	Ex	503.12583	503.12586	503.125865	503.12587
125A	2P+E	50Hz 60Hz	200-250V	Blue	6h	II 3D	1	1	1	1
	3P+E		380-415V	Red	11h		1	1	1	
		60Hz	440-460V	Red	6h		1	1	1	
	3P+N+E	50Hz 60Hz	346-415V	Red	6h		1	1	1	

- Blank side with drilling point mark
- [i-Device]: an electronic device controls ("Intelligence Device") the status of the interlocked socket, monitoring the electrical functionality.

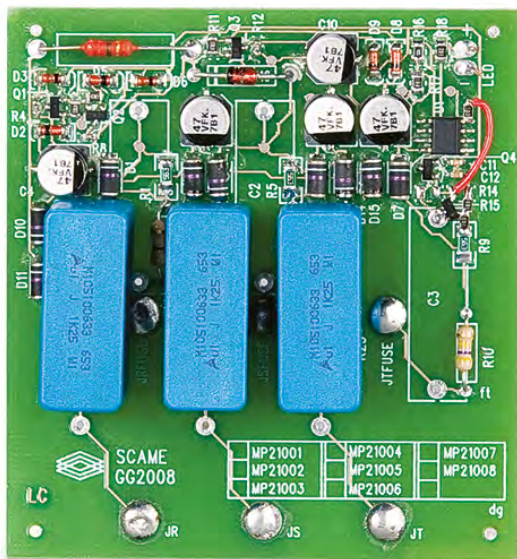

### i-Device

An electronic device controls (*Intelligence Device*) the status of the interlocked socket, monitoring the electrical functionality:

- operation of the signalling and control card is guaranteed even when the load is not connected;

#### INDICATOR LIGHT ON

- indicates that the fuses are not open and all the phases are present;

- indicates that the socket outlet is powered correctly;

#### INDICATOR LIGHT FLASHING

- signals the interruption of one or more fuses;

- signals the absence of a phase(\*);

#### INDICATOR LIGHT OFF

- indicates that the socket outlet is not powered.

(\*) For single-phase products in the event of phase/neutral loss led signaling appears off.

1  
INDUSTRY

2  
3  
4

# Switched interlocked sockets outlets

## ADVANCE-GRP Series



### ■ Surface mounting IP66 (125A)

ADVANCE GRP Series

503.



With switch-disconnector and fuse  
[With "i-Device"]

Current	Poles	Hz	Volt	Colour	h	Ex	INTERLOCKED SOCKET	
							IP66	
125A	2P+E	50Hz 60Hz	>50-250V	Grey	3h		503.125834-F <sup>[1]</sup>	1
			200-250V	Blue			503.12583-F	1
	3P+E		380-415V	Red	6h	II 3D	503.12586-F	1
	3P+N+E		346-415V				503.12587-F	1

<sup>[1]</sup> When using DC we recommend that you make sure of implementing the protection scheme that is most suitable for the system involved; contact Scame Technical Service for further information.

- Blank side with drilling point mark
- [i-Device]: an electronic device controls ("Intelligence Device") the status of the interlocked socket, monitoring the electrical functionality.

ADVANCE GRP Series

503.



With fuse and switch  
[With "i-Device"]

Current	Poles	Hz	Volt	Colour	h	Ex	INTERLOCKED SOCKET	
							IP66	
125A	2P+E	50Hz 60Hz	200-250V	Blue	6h	II 3D	503.12583-FS	1
	3P+E		380-415V	Red			503.12586-FS	1
	3P+N+E		346-415V				503.12587-FS	1

- Blank side with drilling point mark
- [i-Device]: an electronic device controls ("Intelligence Device") the status of the interlocked socket, monitoring the electrical functionality.

1.3





# Switched interlocked sockets outlets

## ADVANCE-GRP Series

■ Surface mounting IP66 (125A)

ADVANCE GRP Series



503.



With MCCB [With "i-Device"]

INTERLOCKED SOCKET

IP66

Current	Poles	Hz	Volt	Colour	h	Ex					
125A	2P+E	50Hz 60Hz	200-250V		6h	II 3D		503.12583-M	1		
	3P+E		380-415V							503.12586-M	1
	3P+N+E		346-415V							503.12587-M	1

- MCCB = Molded case circuit breaker with thermal magnetic trip unit
- Blank side with drilling point mark
- [i-Device]: an electronic device controls ("Intelligence Device") the status of the interlocked socket, monitoring the electrical functionality.

ADVANCE GRP Series



503.



With MCCB & RCD [With "i-Device"]

INTERLOCKED SOCKET

IP66

Current	Poles	Hz	Volt	Colour	h	Ex					
125A	2P+E	50Hz 60Hz	200-250V		6h	II 3D		503.12583-RM	1		
	3P+E		380-415V							503.12586-RM	1
	3P+N+E		346-415V							503.12587-RM	1

- MCCB & RCD = Molded case circuit breaker with thermal magnetic and residual current release trip unit
- Blank side with drilling point mark
- [i-Device]: an electronic device controls ("Intelligence Device") the status of the interlocked socket, monitoring the electrical functionality.

1  
INDUSTRY

2  
3  
4



# Switched interlocked sockets outlets

## ADVANCE-GRP Series



### ■ Surface mounting IP66 (125A)

ADVANCE GRP Series

503.



With contactor [With "i-Device"]

INTERLOCKED SOCKET

Current	Poles	Hz	Volt	Colour	h	Ex	INTERLOCKED SOCKET	
125A	2P+E	50Hz 60Hz	200-250V		6h	II 3D	IP66	
	3P+E		380-415V				503.12583-T	1
	3P+N+E		346-415V				503.12586-T	1
							503.12587-T	1

- Blank side with drilling point mark
- [i-Device]: an electronic device controls ("Intelligence Device") the status of the interlocked socket, monitoring the electrical functionality.



APPLICATION EXAMPLE

1.3



# Switched interlocked sockets outlets

## ADVANCE-GRP Series

■ Extra low voltage <50V - IP66/IP67/IP69

ADVANCE-GRP[<50V] Series

403.



**Version with safety transformer - Panel mounting**

INTERLOCKED SOCKET

IP66/IP67/IP69

130x260mm

Poles	Volt	Colour	h	16A		32A	
				Code	Rating	Code	Rating
2P	20-25V	■	12h	<b>403.2420</b>	1/6	<b>403.2620</b>	1/6
	24V			<b>403.2416</b> <sup>⊕</sup>	1/6		
	40-50V	□		<b>403.2421</b>	1/6	<b>403.2621</b>	1/6

⊕ SELV transformer 220/24V~ 150VA (continuous duty).

- For the choice of bases, refer to the 16A-32A module.
- Supplied with stainless steel fixing screws.
- When plug is inserted a micro-switch is activated and closes the circuit
- Empty base: ADVANCE-GRP System (fam. 579)



### AS panels

Example of Mega Panel available in customized configuration.

1

INDUSTRY

2

3

4

# Switched interlocked sockets outlets

## ADVANCE-GRP System



### Empty bases IP66/IP67/IP69

ADVANCE-GRP System

579.



Empty base 16A-32A

Empty base 63A

Notes	Dimension	MODULAR BASES	
		IP66/IP67/IP69	
16A-32A	130x260mm	<b>579.5100</b>	1
63A	170x380mm	<b>579.5200</b>	1

- Power dissipation calculated in conformity with CEI 23-49 italian standards
- IP66/IP67/IP69 when coupled with the respective component.
- Blank side with drilling point mark

ADVANCE-GRP System

579.



Empty base 16-32A with junction box

Empty base 16-32A with junction box (double)

Empty base 63A with junction box

Notes	Dimension	Power	MODULAR BASES	
			IP66/IP67/IP69	
16A-32A	130x460mm	9W	<b>579.5110</b>	1
	260x460mm	16W	<b>579.5120</b>	1
63A	170x580mm	9W	<b>579.5210</b>	1

- Power dissipation calculated in conformity with CEI 23-49 italian standards
- IP66/IP67/IP69 when coupled with the respective component.
- Blank side with drilling point mark

1.3





# Switched interlocked sockets outlets

## ADVANCE-GRP System

### Empty bases IP66/IP67/IP69

1  
INDUSTRY

ADVANCE-GRP System

579.



Empty base 16-32A with  
DIN rail

Empty base 16-32A with  
DIN rail (double)

Empty base 63A with  
DIN rail

MODULAR BASES

IP66/IP67/IP69

Notes	Dimension	Power			
16A-32A - 13 DIN	260x460mm	16W			
16A-32A - 6 DIN	130x460mm	13W	<b>579.5111</b>	1	
63A - 8 DIN	170x580mm				<b>579.5211</b> 1

- Power dissipation calculated in conformity with CEI 23-49 italian standards
- IP66/IP67/IP69 when coupled with the respective component.
- Blank side with drilling point mark



APPLICATION EXAMPLE

# Switched interlocked sockets outlets

## ADVANCE-GRP System



### Modular system - IP66

#### ADVANCE-GRP System

579.



#### Modular plate

Dimension	MODULAR PLATE				
	2x16-32A + 1x63A	2x16-32A + 2x63A	3x16-32A	3x16-32A + 1x63A	4x16-32A
390x555mm			<b>579.0030</b>		
430x685mm	<b>579.0021</b>				
520x555mm					<b>579.0040</b>
560x685mm				<b>579.0031</b>	
610x685mm		<b>579.0022</b>			



**579.0021**  
Composition example: 3x16-32A



**579.0031**  
Composition example: 3x16-32A + 1x63A

1.3



## Switched interlocked sockets outlets ADVANCE-GRP System

### Accessories

#### ADVANCE-GRP System

579.



Description	Cable outlet	Current	Kit microswitch	Junction box kit	Coupling kit
ADAPTOR COUPLING KIT	M32X1,5				<b>579.0332</b> <sup>[4][5]</sup> 12
MICROSWITCH KIT		16A 32A 63A	<b>579.0100</b> <sup>[1][2]</sup> 12		
		125A	<b>579.0125</b> <sup>[3][1]</sup> 1		
JUNCTION_BOX KIT	M40X1,5			<b>579.0200</b> <sup>[4][5]</sup> 1/12	
	M50X1,5			<b>579.0201</b> <sup>[4][5]</sup> 1/12	

<sup>[1]</sup> For plug-inserted control; not suitable for electrically interlocked socket.

<sup>[2]</sup> Max 1 kit for 16A-32A sockets; Max 2 kit for 63A sockets.

<sup>[3]</sup> Max. 2 kits

<sup>[4]</sup> Includes cable gland and gasket

<sup>[5]</sup> IP66/IP67/IP69 when coupled with the respective component.

### Modular system - IP66

#### TOP22 Series

590.



Description	Colour	Switch size	Contact blocks
NC CONTACT		Y1	<b>590.PL004001</b> <sup>[1]</sup> 10/60
		Y2	<b>590.PL004003</b> <sup>[1]</sup> 10
NO CONTACT		Y1	<b>590.PL004002</b> <sup>[2]</sup> 10/60
		Y2	<b>590.PL004004</b> <sup>[2]</sup> 10

<sup>[1]</sup> NC=Normally closed

<sup>[2]</sup> NO=Normally open

- Snap catch

# Switched interlocked sockets outlets

## ADVANCE-GRP System



### Modular system - IP66

#### ADVANCE-GRP System

579.



Description	IP	Notes	Accessories	
BLANK PLATE FOR DIN MODULES			<b>579.0450</b>	10
BASE BLANK COVER	IP66/IP67/IP69	16A-32A	<b>579.5001</b> <sup>[2]</sup>	10
SCREW KNOBS KIT			<b>579.0400</b> <sup>[1]</sup>	12

[1] For bases with control units instead of screws for closing the doors

[2] Cover used to close the socket compartment; allows other devices to be installed

1.3



1.4

## Plugs and sockets for special applications

- AMR System - Automated Meter Reading
- Plugs and sockets for industrial applications <50V~
- Events and exhibitions products
- Industrial plugs and sockets for military use
- Plugs and sockets UL/CSA
- Seven poles plugs and sockets
- OPTIMA-METAL Series - Industrial connectors





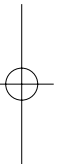

# Plugs and sockets for special applications

## AMR System - Automated Meter Reading

### ■ ADVANCE-GRP [AMR] Series >> Panel mounting IP66/IP67/IP69

ADVANCE-GRP[AMR] Series

403.



**AMR** Without fuse carrier [AMR]

INTERLOCKED SOCKET

IP66/IP67/IP69

Current	Poles	Volt	Colour	h	130x260mm		170x380mm	
					Model	Quantity	Model	Quantity
16A	2P+E	200-250V	Blue	6h	<b>403.AMR1683</b>	1		
	3P+E	380-415V	Red		<b>403.AMR1686</b>	1		
	3P+N+E	346-415V	Red		<b>403.AMR1687</b>	1		
32A	2P+E	200-250V	Blue	3h	<b>403.AMR3283</b>	1		
	3P+E	380-415V	Red		<b>403.AMR3286</b>	1		
		380V 50Hz / 440V 60Hz	Red		<b>403.AMR32864</b>	1		
	3P+N+E	346-415V	Red		<b>403.AMR3287</b>	1		
63A	2P+E	200-250V	Blue	6h			<b>403.AMR6383</b>	1
	3P+E	380-415V	Red				<b>403.AMR6386</b>	1
	3P+N+E	346-415V	Red				<b>403.AMR6387</b>	1

- Supplied with stainless steel fixing screws.

1

INDUSTRY

2

3

4



**AMR**  
AUTOMATED METER READING

# Plugs and sockets for special applications

## AMR System - Automated Meter Reading



### ■ ADVANCE-GRP [AMR] Series >> Panel mounting IP66/IP67/IP69

#### ADVANCE-GRP[AMR] Series

403.



**AMR** With fuse carrier  
[AMR]

#### INTERLOCKED SOCKET

IP66/IP67/IP69

Current	Poles	Volt	Colour	h	130x260mm		170x380mm	
					Model	Quantity	Model	Quantity
16A	2P+E	200-250V	Blue	6h	403.AMR1683-F	1		
	3P+E	380-415V	Red		403.AMR1686-F	1		
	3P+N+E	346-415V	Red		403.AMR1687-F	1		
32A	2P+E	200-250V	Blue	3h	403.AMR3283-F	1		
	3P+E	380-415V	Red		403.AMR3286-F	1		
	3P+N+E	380V 50Hz / 440V 60Hz	Red		403.AMR32864-F	1		
63A	2P+E	200-250V	Blue	6h			403.AMR6383-F	1
	3P+E	380-415V	Red				403.AMR6386-F	1
	3P+N+E	346-415V	Red				403.AMR6387-F	1

- Supplied with stainless steel fixing screws.



#### AMR System

The products of the AMR System, from the acronym AMR (Automated Meter Reading), feature advanced technology. Thanks to the AMR system, you can acquire energy consumption data, measure currents and power, analyse grid parameters and send/receive alarm messages through text message or by e-mail.

1.4



# Plugs and sockets for special applications

## AMR System - Automated Meter Reading

### ■ ADVANCE-GRP [AMR] Series >> Panel mounting IP66/IP67/IP69

#### ADVANCE-GRP[AMR] Series

403.



#### AMR With MCB [AMR]

#### INTERLOCKED SOCKET

IP66/IP67/IP69

Current	Poles	Volt	Colour	h	130x260mm		170x380mm	
					Model	Quantity	Model	Quantity
16A	2P+E	200-250V	Blue	6h	403.AMR1683-M	1		
	3P+E	380-415V	Red		403.AMR1686-M	1		
	3P+N+E	346-415V	Red		403.AMR1687-M	1		
32A	2P+E	200-250V	Blue	3h	403.AMR3283-M	1		
	3P+E	380-415V	Red		403.AMR3286-M	1		
		380V 50Hz / 440V 60Hz	Red		403.AMR32864-M	1		
	3P+N+E	346-415V	Red		403.AMR3287-M	1		
63A	2P+E	200-250V	Blue	6h			403.AMR6383-M	1
	3P+E	380-415V	Red				403.AMR6386-M	1
	3P+N+E	346-415V	Red				403.AMR6387-M	1

- MCB = Miniature circuit breaker with thermal magnetic trip unit
- Supplied with stainless steel fixing screws.



#### AMR System

Example of container terminal applications

- #### I/O MANAGEMENT
- Auxiliary input
  - Earth presence control
  - Inserted plug control
  - Manoeuvre status
  - Device internal temperature
  - Sending of alarms



AMR  
AUTOMATED METER READING

# Plugs and sockets for special applications

## AMR System - Automated Meter Reading



### ■ ADVANCE-GRP [AMR] Series >> Surface mounting IP66 (125A)

ADVANCE-GRP[AMR] Series

503.



**AMF** With switch-disconnector [AMR]

**AMF** With switch-disconnector and fuse [AMR]

**AMF** With MCCB [AMR]

INTERLOCKED SOCKET

IP66

Current	Poles	Volt	Colour	h	503.AMR12583	503.AMR12583-F	503.AMR12583-M
125A	2P+E	200-250V	Blue	6h	1	1	1
	3P+E	380-415V	Red		1	1	1
	3P+N+E	346-415V			1	1	1

1 MCCB = Molded case circuit breaker with thermal magnetic trip unit

- Blank side with drilling point mark

### ■ Components

SCABOX Series

686.



**AMF** Current transformer

Description	Notes	686.AMRTA-005	686.AMRTA-032	686.AMRTA-063	686.AMRTA-125	686.AMRTA-225
CURRENT TRANSFORMER	TA 5A					
	TA 32A					
	TA 63A					
	TA 125A					
	TA 225A					

1.4





# Plugs and sockets for special applications

## AMR System - Automated Meter Reading

### Components

SCABOX Series

686.



1  
INDUSTRY

Description	IP	GW	Colour	Dimension	AMF AMR-BOX
AMR-BOX WI-FI TA5A	IP56	GW 650°C		300x220x120mm	<b>686.AMR209-01</b>

2  
3  
4



#### AMR-BOX System

- [1] Earth connection
- [2] R-S-T-N power supply
- [3] Connection TA/5A
- [4] Energy meeter reading
- [5] Out contact NO/NC (load control)



- 1
- 2
- 3
- 4
- 5



AMR  
AUTOMATED METER READING

# Plugs and sockets for special applications

## AMR System - Automated Meter Reading



### Management

#### ADVANCE-GRP[AMR] Series

499.



Description	Notes	AMR Software
MANAGMENT SOFTWARE	BASIC PACKAGE SOFTWARE	<b>499.AMRSW-000</b> <sup>1</sup>
	LICENSE 001: 1 DEVICE	<b>499.AMRSW-001</b>
	LICENSE 010: 10 DEVICES	<b>499.AMRSW-010</b>
	LICENSE 030: 30 DEVICES	<b>499.AMRSW-030</b>
	LICENSE 060: 60 DEVICES	<b>499.AMRSW-060</b>
	LICENSE 100: 100 DEVICES	<b>499.AMRSW-100</b>
	LICENSE 999: FULL	<b>499.AMRSW-999</b>

<sup>1</sup> The software can be downloaded from SCAME website [www.scame.com]

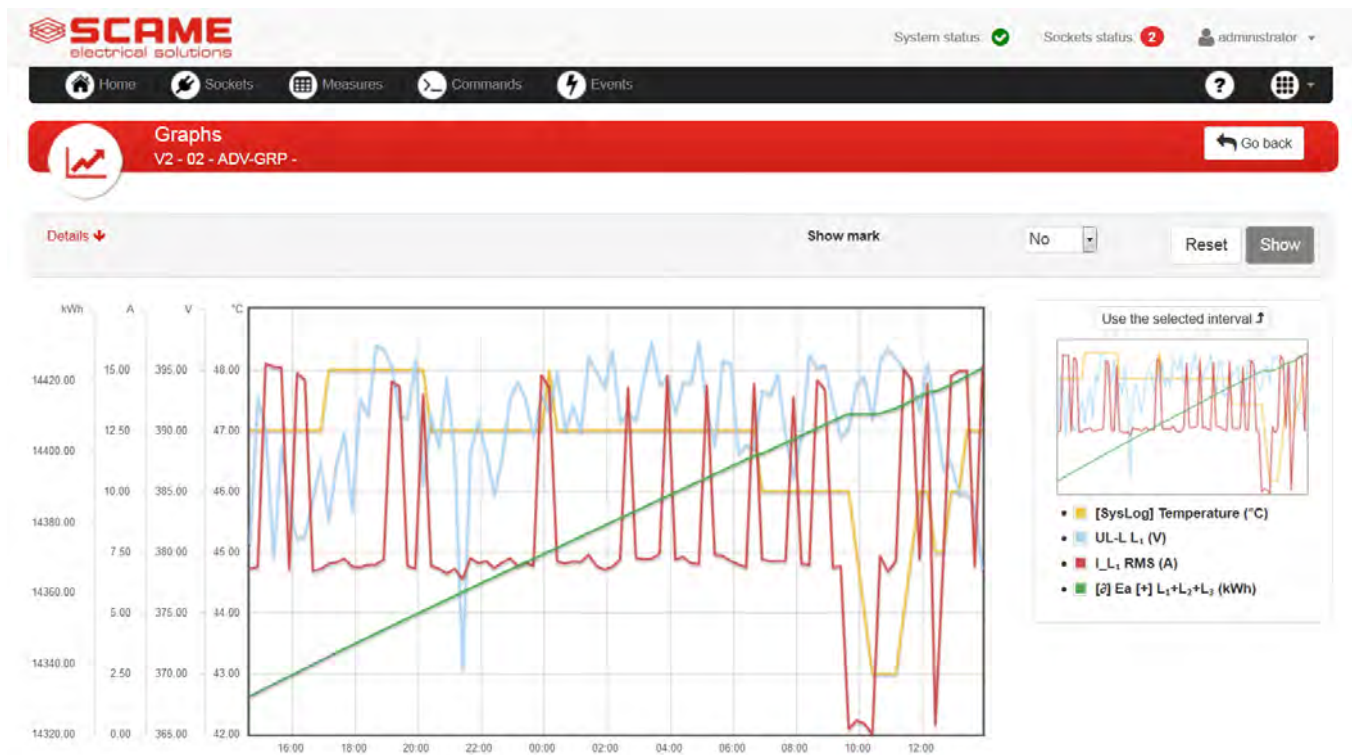

**AMR - Software**  
Load management and remote controls

1.4



# Plugs and sockets for special applications

## Plugs and sockets for industrial applications <50V~

### IEC309 Series - Plugs and connectors

#### IEC309 Series

230.

235.



Plugs - IP44

Plugs - IP66/IP67

#### PLUG

Current	Poles	Hz	Volt	Colour	h	PLUG			
						IP44	IP66/IP67		
16A	2P	50Hz 60Hz	20-25V	Green	12h	<b>230.1600</b>	10/100	<b>235.1600</b>	10/100
			40-50V	White	12h	<b>230.1601</b>	10/100	<b>235.1601</b>	10/100
		20-25V 40-50V	100-200Hz	White	4h	<b>230.16010</b>	10/100	<b>235.16010</b>	10/100
			300Hz	Green	2h	<b>230.16012</b>	10/100	<b>235.16012</b>	10/100
			400Hz	Green	3h	<b>230.16014</b>	10/100	<b>235.16014</b>	10/100
			>400-500Hz	White	11h	<b>230.16015</b>	10/100	<b>235.16015</b>	10/100
	DC	White	10h	<b>230.1602</b>	10/100	<b>235.1602</b>	10/100		
	3P	50Hz 60Hz	20-25V	Green	12h	<b>230.1604</b>	10/100	<b>235.1604</b>	10/100
			40-50V	White	12h	<b>230.1603</b>	10/100	<b>235.1603</b>	10/100
		20-25V 40-50V	100-200Hz	White	4h	<b>230.16030</b>	10/100	<b>235.16030</b>	10/100
			300Hz	Green	2h	<b>230.16032</b>	10/100	<b>235.16032</b>	10/100
			400Hz	Green	3h	<b>230.16034</b>	10/100	<b>235.16034</b>	10/100
>400-500Hz			White	11h	<b>230.16035</b>	10/100	<b>235.16035</b>	10/100	
32A	2P	50Hz 60Hz	20-25V	Green	12h	<b>230.3200</b>	10/100	<b>235.3200</b>	10/100
			40-50V	White	12h	<b>230.3201</b>	10/100	<b>235.3201</b>	10/100
		20-25V 40-50V	100-200Hz	White	4h	<b>230.32010</b>	10/100	<b>235.32010</b>	10/100
			300Hz	Green	2h	<b>230.32012</b>	10/100	<b>235.32012</b>	10/100
			400Hz	Green	3h	<b>230.32014</b>	10/100	<b>235.32014</b>	10/100
			>400-500Hz	White	11h	<b>230.32015</b>	10/100	<b>235.32015</b>	10/100
	DC	White	10h	<b>230.3202</b>	10/100	<b>235.3202</b>	10/100		
	3P	50Hz 60Hz	20-25V	Green	12h	<b>230.3204</b>	10/100	<b>235.3204</b>	10/100
			40-50V	White	12h	<b>230.3203</b>	10/100	<b>235.3203</b>	10/100
		20-25V 40-50V	100-200Hz	White	4h	<b>230.32030</b>	10/100	<b>235.32030</b>	10/100
			300Hz	Green	2h	<b>230.32032</b>	10/100	<b>235.32032</b>	10/100
			400Hz	Green	3h	<b>230.32034</b>	10/100	<b>235.32034</b>	10/100
>400-500Hz			White	11h	<b>230.32035</b>	10/100	<b>235.32035</b>	10/100	

1  
INDUSTRY

2

3

4



**Plugs and sockets for special applications**  
**Plugs and sockets for industrial applications <50V~**



**IEC309 Series**

330.

335.



**Connectors - IP44**

**Connectors - IP66/IP67**

CONNECTOR			
IP44		IP66/IP67	
<b>330.1605</b>	10/100	<b>335.1605</b>	10/100
<b>330.1606</b>	10/100	<b>335.1606</b>	10/100
<b>330.16060</b>	10/100	<b>335.16060</b>	10/100
<b>330.16062</b>	10/100	<b>335.16062</b>	10/100
<b>330.16064</b>	10/100	<b>335.16064</b>	10/100
<b>330.16065</b>	10/100	<b>335.16065</b>	10/100
<b>330.1607</b>	10/100	<b>335.1607</b>	10/100
<b>330.1609</b>	10/100	<b>335.1609</b>	10/100
<b>330.1608</b>	10/100	<b>335.1608</b>	10/100
<b>330.16080</b>	10/100	<b>335.16080</b>	10/100
<b>330.16082</b>	10/100	<b>335.16082</b>	10/100
<b>330.16084</b>	10/100	<b>335.16084</b>	10/100
<b>330.16085</b>	10/100	<b>335.16085</b>	10/100
<b>330.3205</b>	10/100	<b>335.3205</b>	10/50
<b>330.3206</b>	10/100	<b>335.3206</b>	10/50
<b>330.32060</b>	10/100	<b>335.32060</b>	10/50
<b>330.32062</b>	10/100	<b>335.32062</b>	10/50
<b>330.32064</b>	10/100	<b>335.32064</b>	10/50
<b>330.32065</b>	10/100	<b>335.32065</b>	10/50
<b>330.3207</b>	10/100	<b>335.3207</b>	10/50
<b>330.3209</b>	10/100	<b>335.3209</b>	10/50
<b>330.3208</b>	10/100	<b>335.3208</b>	10/50
<b>330.32080</b>	10/100	<b>335.32080</b>	10/50
<b>330.32082</b>	10/100	<b>335.32082</b>	10/50
<b>330.32084</b>	10/100	<b>335.32084</b>	10/50
<b>330.32085</b>	10/100	<b>335.32085</b>	10/50

1.4



# Plugs and sockets for special applications

## Plugs and sockets for industrial applications <50V~

### IEC309 Series - Flush mounting socket outlets

IEC309 Series

430.



Flush mounting socket outlets [Angled outlet] - IP44

Flush mounting socket outlets [Straight outlet] - IP44

FLUSH-MOUNTING SOCKET

IP44

Current	Poles	Hz	Volt	Colour	h	70x87mm		55x55mm	
						Part Number	Rating	Part Number	Rating
16A	2P	50Hz 60Hz	20-25V	Green	12h	<b>430.1615</b>	10/100	<b>430.1615/R</b>	10/100
			40-50V	White	12h	<b>430.1616</b>	10/100	<b>430.1616/R</b>	10/100
		100-200Hz	20-25V 40-50V	Green	4h	<b>430.16160</b>	10/100	<b>430.16160/R</b>	10/100
		300Hz		Green	2h	<b>430.16162</b>	10/100	<b>430.16162/R</b>	10/100
		400Hz		Green	3h	<b>430.16164</b>	10/100	<b>430.16164/R</b>	10/100
		>400-500Hz		White	11h	<b>430.16165</b>	10/100	<b>430.16165/R</b>	10/100
	DC	White	10h	<b>430.1617</b>	10/100	<b>430.1617/R</b>	10/100		
	3P	50Hz 60Hz	20-25V	Green	12h	<b>430.1619</b>	10/100	<b>430.1619/R</b>	10/100
			40-50V	White	12h	<b>430.1618</b>	10/100	<b>430.1618/R</b>	10/100
		100-200Hz	20-25V 40-50V	Green	4h	<b>430.16180</b>	10/100	<b>430.16180/R</b>	10/100
		300Hz		Green	2h	<b>430.16182</b>	10/100	<b>430.16182/R</b>	10/100
		400Hz		Green	3h	<b>430.16184</b>	10/100	<b>430.16184/R</b>	10/100
>400-500Hz		White		11h	<b>430.16185</b>	10/100	<b>430.16185/R</b>	10/100	
32A	2P	50Hz 60Hz	20-25V	Green	12h	<b>430.3215</b>	10/100	<b>430.3215/R</b>	10/100
			40-50V	White	12h	<b>430.3216</b>	10/100	<b>430.3216/R</b>	10/100
		100-200Hz	20-25V 40-50V	Green	4h	<b>430.32160</b>	10/100	<b>430.32160/R</b>	10/100
		300Hz		Green	2h	<b>430.32162</b>	10/100	<b>430.32162/R</b>	10/100
		400Hz		Green	3h	<b>430.32164</b>	10/100	<b>430.32164/R</b>	10/100
		>400-500Hz		White	11h	<b>430.32165</b>	10/100	<b>430.32165/R</b>	10/100
	DC	White	10h	<b>430.3217</b>	10/100	<b>430.3217/R</b>	10/100		
	3P	50Hz 60Hz	20-25V	Green	12h	<b>430.3219</b>	10/100	<b>430.3219/R</b>	10/100
			40-50V	White	12h	<b>430.3218</b>	10/100	<b>430.3218/R</b>	10/100
		100-200Hz	20-25V 40-50V	Green	4h	<b>430.32180</b>	10/100	<b>430.32180/R</b>	10/100
		300Hz		Green	2h	<b>430.32182</b>	10/100	<b>430.32182/R</b>	10/100
		400Hz		Green	3h	<b>430.32184</b>	10/100	<b>430.32184/R</b>	10/100
>400-500Hz		White		11h	<b>430.32185</b>	10/100	<b>430.32185/R</b>	10/100	

1  
INDUSTRY

2

3

4

**Plugs and sockets for special applications**  
**Plugs and sockets for industrial applications <50V~**



**IEC309 Series**

435.



**Flush mounting socket outlets [Angled outlet] - IP66/IP67**



**Flush mounting socket outlets [Straight outlet] - IP66/IP67**

**FLUSH-MOUNTING SOCKET**  
IP66/IP67

70x87mm		55x55mm	
<b>435.1615</b>	10/100	<b>435.1615/R</b>	10/100
<b>435.1616</b>	10/100	<b>435.1616/R</b>	10/100
<b>435.16160</b>	10/100	<b>435.16160/R</b>	10/100
<b>435.16162</b>	10/100	<b>435.16162/R</b>	10/100
<b>435.16164</b>	10/100	<b>435.16164/R</b>	10/100
<b>435.16165</b>	10/100	<b>435.16165/R</b>	10/100
<b>435.1617</b>	10/100	<b>435.1617/R</b>	10/100
<b>435.1619</b>	10/100	<b>435.1619/R</b>	10/100
<b>435.1618</b>	10/100	<b>435.1618/R</b>	10/100
<b>435.16180</b>	10/100	<b>435.16180/R</b>	10/100
<b>435.16182</b>	10/100	<b>435.16182/R</b>	10/100
<b>435.16184</b>	10/100	<b>435.16184/R</b>	10/100
<b>435.16185</b>	10/100	<b>435.16185/R</b>	10/100
<b>435.3215</b>	10/100	<b>435.3215/R</b>	10/100
<b>435.3216</b>	10/100	<b>435.3216/R</b>	10/100
<b>435.32160</b>	10/100	<b>435.32160/R</b>	10/100
<b>435.32162</b>	10/100	<b>435.32162/R</b>	10/100
<b>435.32164</b>	10/100	<b>435.32164/R</b>	10/100
<b>435.32165</b>	10/100	<b>435.32165/R</b>	10/100
<b>435.3217</b>	10/100	<b>435.3217/R</b>	10/100
<b>435.3219</b>	10/100	<b>435.3219/R</b>	10/100
<b>435.3218</b>	10/100	<b>435.3218/R</b>	10/100
<b>435.32180</b>	10/100	<b>435.32180/R</b>	10/100
<b>435.32182</b>	10/100	<b>435.32182/R</b>	10/100
<b>435.32184</b>	10/100	<b>435.32184/R</b>	10/100
<b>435.32185</b>	10/100	<b>435.32185/R</b>	10/100

1.4



# Plugs and sockets for special applications

## Plugs and sockets for industrial applications <50V~

### IEC309 Series - Surface mounting socket outlets

IEC309 Series

530.



Surface mounting socket outlets [Straight box] - IP44

Surface mounting socket outlets [Angled box] - IP44

SURFACE MOUNTING SOCKET

IP44

Current	Poles	Hz	Volt	Colour	h	SURFACE MOUNTING SOCKET			
						DRILLING POINT MARK	M20X1,5		
16A	2P	50Hz 60Hz	20-25V	Green		<b>530.1610</b> <sup>[1][2]</sup>	10/50	<b>530.01610</b> <sup>[3][4]</sup>	10/50
			40-50V	White	12h	<b>530.1611</b> <sup>[1][2]</sup>	10/50	<b>530.01611</b> <sup>[3][4]</sup>	10/50
		20-25V 40-50V	100-200Hz	White	4h	<b>530.16110</b> <sup>[1][2]</sup>	10/50	<b>530.016110</b> <sup>[3][4]</sup>	10/50
			300Hz	Green	2h	<b>530.16112</b> <sup>[1][2]</sup>	10/50	<b>530.016112</b> <sup>[3][4]</sup>	10/50
			400Hz	Green	3h	<b>530.16114</b> <sup>[1][2]</sup>	10/50	<b>530.016114</b> <sup>[3][4]</sup>	10/50
			>400-500Hz	White	11h	<b>530.16115</b> <sup>[1][2]</sup>	10/50	<b>530.016115</b> <sup>[3][4]</sup>	10/50
	DC	White	10h	<b>530.1612</b> <sup>[1][2]</sup>	10/50	<b>530.01612</b> <sup>[3][4]</sup>	10/50		
	3P	50Hz 60Hz	20-25V	Green		<b>530.1614</b> <sup>[1][2]</sup>	10/50	<b>530.01614</b> <sup>[3][4]</sup>	10/50
			40-50V	White	12h	<b>530.1613</b> <sup>[1][2]</sup>	10/50	<b>530.01613</b> <sup>[3][4]</sup>	10/50
		20-25V 40-50V	100-200Hz	White	4h	<b>530.16130</b> <sup>[1][2]</sup>	10/50	<b>530.016130</b> <sup>[3][4]</sup>	10/50
			300Hz	Green	2h	<b>530.16132</b> <sup>[1][2]</sup>	10/50	<b>530.016132</b> <sup>[3][4]</sup>	10/50
			400Hz	Green	3h	<b>530.16134</b> <sup>[1][2]</sup>	10/50	<b>530.016134</b> <sup>[3][4]</sup>	10/50
>400-500Hz			White	11h	<b>530.16135</b> <sup>[1][2]</sup>	10/50	<b>530.016135</b> <sup>[3][4]</sup>	10/50	
32A	2P	50Hz 60Hz	20-25V	Green		<b>530.3210</b> <sup>[1][2]</sup>	10/50		
			40-50V	White	12h	<b>530.3211</b> <sup>[1][2]</sup>	10/50		
		20-25V 40-50V	100-200Hz	White	4h	<b>530.32110</b> <sup>[1][2]</sup>	10/50		
			300Hz	Green	2h	<b>530.32112</b> <sup>[1][2]</sup>	10/50		
			400Hz	Green	3h	<b>530.32114</b> <sup>[1][2]</sup>	10/50		
			>400-500Hz	White	11h	<b>530.32115</b> <sup>[1][2]</sup>	10/50		
	DC	White	10h	<b>530.3212</b> <sup>[1][2]</sup>	10/50				
	3P	50Hz 60Hz	20-25V	Green		<b>530.3214</b> <sup>[1][2]</sup>	10/50		
			40-50V	White	12h	<b>530.3213</b> <sup>[1][2]</sup>	10/50		
		20-25V 40-50V	100-200Hz	White	4h	<b>530.32130</b> <sup>[1][2]</sup>	10/50		
			300Hz	Green	2h	<b>530.32132</b> <sup>[1][2]</sup>	10/50		
			400Hz	Green	3h	<b>530.32134</b> <sup>[1][2]</sup>	10/50		
>400-500Hz			White	11h	<b>530.32135</b> <sup>[1][2]</sup>	10/50			

- [1] Blank side with drilling point mark
- [2] Rubber cable sleeve included
- [3] Open threaded cable entry
- [4] Threaded cap/cable sleeve included

1

INDUSTRY

2

3

4

**Plugs and sockets for special applications**  
**Plugs and sockets for industrial applications <50V~**



IEC309 Series

530.		535.		
<b>Surface mounting socket outlets [Angled box] - IP44</b>		<b>Surface mounting socket outlets [Angled box] - IP66/IP67</b>		
SURFACE MOUNTING SOCKET				
IP44		IP66/IP67		
M25X1,5		M25X1,5	DRILLING POINT MARK	
	<b>535.01610</b> <sup>3</sup> / <sub>4</sub>	10/50	<b>535.1610</b> <sup>1</sup> / <sub>2</sub>	10/50
	<b>535.01611</b> <sup>3</sup> / <sub>4</sub>	10/50	<b>535.1611</b> <sup>1</sup> / <sub>2</sub>	10/50
	<b>535.016110</b> <sup>3</sup> / <sub>4</sub>	10/50	<b>535.16110</b> <sup>1</sup> / <sub>2</sub>	10/50
	<b>535.016112</b> <sup>3</sup> / <sub>4</sub>	10/50	<b>535.16112</b> <sup>1</sup> / <sub>2</sub>	10/50
	<b>535.016114</b> <sup>3</sup> / <sub>4</sub>	10/50	<b>535.16114</b> <sup>1</sup> / <sub>2</sub>	10/50
	<b>535.016115</b> <sup>3</sup> / <sub>4</sub>	10/50	<b>535.16115</b> <sup>1</sup> / <sub>2</sub>	10/50
	<b>535.01612</b> <sup>3</sup> / <sub>4</sub>	10/50	<b>535.1612</b> <sup>1</sup> / <sub>2</sub>	10/50
	<b>535.01614</b> <sup>3</sup> / <sub>4</sub>	10/50	<b>535.1614</b> <sup>1</sup> / <sub>2</sub>	10/50
	<b>535.01613</b> <sup>3</sup> / <sub>4</sub>	10/50	<b>535.1613</b> <sup>1</sup> / <sub>2</sub>	10/50
	<b>535.016130</b> <sup>3</sup> / <sub>4</sub>	10/50	<b>535.16130</b> <sup>1</sup> / <sub>2</sub>	10/50
	<b>535.016132</b> <sup>3</sup> / <sub>4</sub>	10/50	<b>535.16132</b> <sup>1</sup> / <sub>2</sub>	10/50
	<b>535.016134</b> <sup>3</sup> / <sub>4</sub>	10/50	<b>535.16134</b> <sup>1</sup> / <sub>2</sub>	10/50
	<b>535.016135</b> <sup>3</sup> / <sub>4</sub>	10/50	<b>535.16135</b> <sup>1</sup> / <sub>2</sub>	10/50
	<b>530.03210</b> <sup>3</sup> / <sub>4</sub>	10/50	<b>535.03210</b> <sup>3</sup> / <sub>4</sub>	10/50
	<b>530.03211</b> <sup>3</sup> / <sub>4</sub>	10/50	<b>535.03211</b> <sup>3</sup> / <sub>4</sub>	10/50
	<b>530.032110</b> <sup>3</sup> / <sub>4</sub>	10/50	<b>535.032110</b> <sup>3</sup> / <sub>4</sub>	10/50
	<b>530.032112</b> <sup>3</sup> / <sub>4</sub>	10/50	<b>535.032112</b> <sup>3</sup> / <sub>4</sub>	10/50
	<b>530.032114</b> <sup>3</sup> / <sub>4</sub>	10/50	<b>535.032114</b> <sup>3</sup> / <sub>4</sub>	10/50
	<b>530.032115</b> <sup>3</sup> / <sub>4</sub>	10/50	<b>535.032115</b> <sup>3</sup> / <sub>4</sub>	10/50
	<b>530.03212</b> <sup>3</sup> / <sub>4</sub>	10/50	<b>535.03212</b> <sup>3</sup> / <sub>4</sub>	10/50
	<b>530.03214</b> <sup>3</sup> / <sub>4</sub>	10/50	<b>535.03214</b> <sup>3</sup> / <sub>4</sub>	10/50
	<b>530.03213</b> <sup>3</sup> / <sub>4</sub>	10/50	<b>535.03213</b> <sup>3</sup> / <sub>4</sub>	10/50
	<b>530.032130</b> <sup>3</sup> / <sub>4</sub>	10/50	<b>535.032130</b> <sup>3</sup> / <sub>4</sub>	10/50
	<b>530.032132</b> <sup>3</sup> / <sub>4</sub>	10/50	<b>535.032132</b> <sup>3</sup> / <sub>4</sub>	10/50
	<b>530.032134</b> <sup>3</sup> / <sub>4</sub>	10/50	<b>535.032134</b> <sup>3</sup> / <sub>4</sub>	10/50
	<b>530.032135</b> <sup>3</sup> / <sub>4</sub>	10/50	<b>535.032135</b> <sup>3</sup> / <sub>4</sub>	10/50
	<b>535.3210</b> <sup>1</sup> / <sub>2</sub>	10/50	<b>535.3210</b> <sup>1</sup> / <sub>2</sub>	10/50
	<b>535.3211</b> <sup>1</sup> / <sub>2</sub>	10/50	<b>535.3211</b> <sup>1</sup> / <sub>2</sub>	10/50
	<b>535.32110</b> <sup>1</sup> / <sub>2</sub>	10/50	<b>535.32110</b> <sup>1</sup> / <sub>2</sub>	10/50
	<b>535.32112</b> <sup>1</sup> / <sub>2</sub>	10/50	<b>535.32112</b> <sup>1</sup> / <sub>2</sub>	10/50
	<b>535.32114</b> <sup>1</sup> / <sub>2</sub>	10/50	<b>535.32114</b> <sup>1</sup> / <sub>2</sub>	10/50
	<b>535.32115</b> <sup>1</sup> / <sub>2</sub>	10/50	<b>535.32115</b> <sup>1</sup> / <sub>2</sub>	10/50
	<b>535.3212</b> <sup>1</sup> / <sub>2</sub>	10/50	<b>535.3212</b> <sup>1</sup> / <sub>2</sub>	10/50
	<b>535.3214</b> <sup>1</sup> / <sub>2</sub>	10/50	<b>535.3214</b> <sup>1</sup> / <sub>2</sub>	10/50
	<b>535.3213</b> <sup>1</sup> / <sub>2</sub>	10/50	<b>535.3213</b> <sup>1</sup> / <sub>2</sub>	10/50
	<b>535.32130</b> <sup>1</sup> / <sub>2</sub>	10/50	<b>535.32130</b> <sup>1</sup> / <sub>2</sub>	10/50
	<b>535.32132</b> <sup>1</sup> / <sub>2</sub>	10/50	<b>535.32132</b> <sup>1</sup> / <sub>2</sub>	10/50
	<b>535.32134</b> <sup>1</sup> / <sub>2</sub>	10/50	<b>535.32134</b> <sup>1</sup> / <sub>2</sub>	10/50
	<b>535.32135</b> <sup>1</sup> / <sub>2</sub>	10/50	<b>535.32135</b> <sup>1</sup> / <sub>2</sub>	10/50

1.4



# Plugs and sockets for special applications

## Events and exhibitions products

### ■ OPTIMA Series - IP44/IP54 versions >> Plugs / Inlets (black version)

OPTIMA Series

213.







 Screw terminals

PLUG

IP44/IP54

CABLE GLAND

Poles	Hz	Volt	Colour	h	16A		32A	
					Part No.	10/50	Part No.	10/40
2P+E	50Hz 60Hz	200-250V		6h	<b>213.1633.K</b>	10/50	<b>213.3233.K</b>	10/40
3P+E		380-415V			<b>213.1636.K</b>	10/50	<b>213.3236.K</b>	10/40
3P+N+E		208-250V		9h	<b>213.1635.K</b>	10/50	<b>213.3235.K</b>	10/40
		346-415V		6h	<b>213.1637.K</b>	10/50	<b>213.3237.K</b>	10/40

- Black-coloured

OPTIMA Series

213.





 Perforating terminals

PLUG

IP44/IP54

CABLE GLAND

Poles	Hz	Volt	Colour	h	16A	
					Part No.	10/50
2P+E	50Hz 60Hz	200-250V		6h	<b>213.1633P.K</b>	10/50
3P+E		380-415V			<b>213.1636P.K</b>	10/50
3P+N+E		346-415V			<b>213.1637P.K</b>	10/50

- Black-coloured



**Terminals**  
Perforating terminals (FAST WIRING)



**Terminals**  
Screw terminals



**Terminals**  
Spring terminals (FAST WIRING)

# Plugs and sockets for special applications

## Events and exhibitions products



### ■ OPTIMA Series - IP44/IP54 versions >> Plugs / Inlets (black version)

**OPTIMA Series**  
213.





 **Spring terminals**

					PLUG
					IP44/IP54
					CABLE GLAND
					32A
Poles	Hz	Volt	Colour	h	<b>213.3233F.K</b> 10/40
2P+E		200-250V			
3P+E	50Hz 60Hz	380-415V		6h	<b>213.3236F.K</b> 10/40
3P+N+E		346-415V			<b>213.3237F.K</b> 10/40

- Black-coloured

**OPTIMA Series**  
243.



 **Screw terminals  
[Straight outlet]**

					APPLIANCE INLET	
					IP44/IP54	
					75x75mm	
Poles	Hz	Volt	Colour	h	16A	32A
2P+E		200-250V			<b>243.1693.K</b> 10/50	<b>243.3293.K</b> 10/50
3P+E	50Hz 60Hz	380-415V		6h	<b>243.1696.K</b> 10/50	<b>243.3296.K</b> 10/50
3P+N+E		346-415V			<b>243.1697.K</b> 10/50	<b>243.3297.K</b> 10/40

- Black-coloured



# Plugs and sockets for special applications

## Events and exhibitions products

### ■ OPTIMA Series - IP44/IP54 versions >> Connectors (black version)

1

INDUSTRY

2

3









4

#### OPTIMA Series

313.



#### Screw terminals

						CONNECTOR	
						IP44/IP54	
						CABLE GLAND	
Current	Poles	Hz	Volt	Colour	h		
16A	2P+E	50Hz 60Hz	200-250V		6h	<b>313.1643.K</b>	10/50
	3P+E		380-415V		6h	<b>313.1646.K</b>	10/50
	3P+N+E		208-250V		9h	<b>313.1645.K</b>	10/50
			346-415V		9h	<b>313.1647.K</b>	10/50
32A	2P+E	50Hz 60Hz	200-250V		6h	<b>313.3243.K</b>	10/40
	3P+E		380-415V		6h	<b>313.3246.K</b>	10/40
	3P+N+E		208-250V		9h	<b>313.3245.K</b>	10/40
			346-415V		6h	<b>313.3247.K</b>	10/40



- Black-coloured

#### OPTIMA Series

313.



#### Perforating terminals

						CONNECTOR	
						IP44/IP54	
						CABLE GLAND	
Current	Poles	Hz	Volt	Colour	h		
16A	2P+E	50Hz 60Hz	200-250V		6h	<b>313.1643P.K</b>	10/50
	3P+E		380-415V			<b>313.1646P.K</b>	10/50
	3P+N+E		346-415V			<b>313.1647P.K</b>	10/50

- Black-coloured



**Terminals**  
Perforating terminals (FAST WIRING)



**Terminals**  
Screw terminals



**Terminals**  
Spring terminals (FAST WIRING)



# Plugs and sockets for special applications

## Events and exhibitions products



### ■ OPTIMA Series - IP44/IP54 versions >> Connectors (black version)

#### OPTIMA Series

313.



Spring terminals

Current	Poles	Hz	Volt	Colour	h
32A	2P+E	50Hz 60Hz	200-250V		6h
	3P+E		380-415V		
	3P+N+E		346-415V		

- Black-coloured

CONNECTOR

IP44/IP54

CABLE GLAND

**313.3243F.K** 10/40

**313.3246F.K** 10/40

**313.3247F.K** 10/40

#### OPTIMA Series

313.



Screw terminals  
[SAFE-IN]

Current	Poles	Hz	Volt	Colour	h
16A	2P+E	50Hz 60Hz	200-250V		6h
	3P+E		380-415V		
	3P+N+E		346-415V		

Sockets with "SAFE-IN" safety device

- Black-coloured

CONNECTOR

IP44/IP54

CABLE GLAND

**313.1643H.K** 10/50

**313.1646H.K** 10/50

**313.1647H.K** 10/50

1.4



# Plugs and sockets for special applications

## Events and exhibitions products

### ■ OPTIMA Series - IP44/IP54 versions >> Flush mounting socket outlets (black version)

OPTIMA Series







413.



 **Screw terminals**  
[Angled outlet]

FLUSH-MOUNTING SOCKET

IP44/IP54

Current	Poles	Hz	Volt	Colour	h	70x87mm		84x106mm	
						Code	Rating	Code	Rating
16A	2P+E	50Hz 60Hz	200-250V		6h	<b>413.1663.K</b>	10/100		
	3P+E		380-415V			<b>413.1666.K</b>	10/100		
	3P+N+E		346-415V			<b>413.1667.K</b>	10/100		
32A	2P+E	50Hz 60Hz	200-250V		6h			<b>413.3263.K</b>	10/50
	3P+E		380-415V					<b>413.3266.K</b>	10/50
	3P+N+E		346-415V					<b>413.3267.K</b>	10/50

- Black-coloured



APPLICATION EXAMPLE



**Terminals**  
Screw terminals

# Plugs and sockets for special applications

## Events and exhibitions products



### ■ OPTIMA Series - IP44/IP54 versions >> Flush mounting socket outlets (black version)

OPTIMA Series

413.





 **Screw terminals  
[Angled outlet]  
[SAFE-IN]**

FLUSH-MOUNTING SOCKET

IP44/IP54

70x87mm

Current	Poles	Hz	Volt	Colour	h		
16A	2P+E	50Hz 60Hz	200-250V		6h	<b>413.1663H.K</b>	10/100
	3P+E		380-415V			<b>413.1666H.K</b>	10/100
	3P+N+E		346-415V			<b>413.1667H.K</b>	10/100

 Sockets with "SAFE-IN" safety device

- Black-coloured



#### THE "SAFE-IN" SAFETY DEVICE

The "SAFE-IN" safety device assembled on the 16A industrial sockets works like the protection installed on household sockets, i.e., by means of an appropriate shutter, it closes the input of the socket contact tubes and prevents accidental and voluntary contact of live parts of the socket with slim objects, such as screwdrivers or wires. This protection offers an additional safety guarantee, in addition to that already provided by the spring-loaded cover assembled on the mobile sockets.

1.4



# Plugs and sockets for special applications

## Events and exhibitions products

### ■ OPTIMA Series - IP44/IP54 versions >> Flush mounting socket outlets (black version)

OPTIMA Series







413.



 **Spring terminals**  
[Angled outlet]

FLUSH-MOUNTING SOCKET

IP44/IP54

Current	Poles	Hz	Volt	Colour	h	70x87mm		84x106mm	
						Part No.	10/100	Part No.	10/50
16A	2P+E	50Hz 60Hz	200-250V		6h	<b>413.1663F.K</b>	10/100		
	3P+E		380-415V			<b>413.1666F.K</b>	10/100		
	3P+N+E		346-415V			<b>413.1667F.K</b>	10/100		
32A	2P+E	50Hz 60Hz	200-250V		6h			<b>413.3263F.K</b>	10/50
	3P+E		380-415V					<b>413.3266F.K</b>	10/50
	3P+N+E		346-415V					<b>413.3267F.K</b>	10/50

- Black-coloured

EUREKA Series

422.



 **Screw terminals**  
[Straight outlet]

FLUSH-MOUNTING SOCKET

IP44

Current	Poles	Hz	Volt	Colour	h	62x62mm	
						Part No.	10/100
16A	2P+E	50Hz 60Hz	200-250V		6h	<b>422.1663/R.K</b>	10/100

- Black-coloured



**Terminals**  
Spring terminals (FAST WIRING)



**Terminals**  
Screw terminals

# Plugs and sockets for special applications

## Events and exhibitions products



### ■ OPTIMA Series - IP44/IP54 versions >> Flush mounting socket outlets (black version)

EUREKA Series

422.



Screw terminals  
[Straight outlet]

FLUSH-MOUNTING SOCKET

IP44

75x75mm

Current	Poles	Hz	Volt	Colour	h		
16A	2P+E	50Hz 60Hz	200-250V		6h	<b>422.1663.K</b>	10/100
32A	3P+N+E		346-415V			<b>422.3267.K</b>	10/50

- Black-coloured

### ■ OPTIMA Series - IP66/IP67/IP69 versions >> Plugs / inlets (black version)

OPTIMA Series

218.



Screw terminals

PLUG

IP66/IP67/IP69

CABLE GLAND

Poles	Hz	Volt	Colour	h	16A		32A	
2P+E	50Hz 60Hz	200-250V		6h	<b>218.1633.K</b>	10/40	<b>218.3233.K</b>	10/40
3P+E		380-415V			<b>218.1636.K</b>	10/40	<b>218.3236.K</b>	10/40
3P+N+E		346-415V			<b>218.1637.K</b>	10/40	<b>218.3237.K</b>	10/40

- Black-coloured

1.4



# Plugs and sockets for special applications

## Events and exhibitions products

### ■ OPTIMA Series - IP66/IP67/IP69 versions >> Plugs / inlets (black version)

1

INDUSTRY

2

3



4

OPTIMA Series

218.



 **Perforating terminals**

Poles	Hz	Volt	Colour	h	PLUG	CABLE GLAND
2P+E	50Hz 60Hz	200-250V		6h	16A	
3P+E		380-415V			<b>218.1633P.K</b>	10/40
3P+N+E		346-415V			<b>218.1636P.K</b>	10/40
					<b>218.1637P.K</b>	10/40



- Black-coloured

OPTIMA Series

218.



 **Spring terminals**

Poles	Hz	Volt	Colour	h	PLUG	CABLE GLAND
2P+E	50Hz 60Hz	200-250V		6h	32A	
3P+E		380-415V			<b>218.3233F.K</b>	10/40
3P+N+E		346-415V			<b>218.3236F.K</b>	10/40
					<b>218.3237F.K</b>	10/40

- Black-coloured



**Terminals**  
Spring terminals (FAST WIRING)



**Terminals**  
Perforating terminals (FAST WIRING)



**Terminals**  
Mantle terminals (EASY-PLUG)











**Terminals**  
Screw terminals





# Plugs and sockets for special applications

## Events and exhibitions products



### ■ OPTIMA Series - IP66/IP67/IP69 versions >> Plugs / inlets (black version)

						OPTIMA Series	
						218.	
							
						 <b>Mantle terminals</b>	
						PLUG	
						IP66/IP67/IP69	
						CABLE GLAND	
Current	Poles	Hz	Volt	Colour	h		
63A	2P+E	50Hz 60Hz	200-250V		6h	<b>218.6333.K</b>	6/24
	3P+E		380-415V			<b>218.6336.K</b>	6/24
	3P+N+E		346-415V			<b>218.6337.K</b>	6/24
125A	2P+E	50Hz 60Hz	200-250V		6h	<b>218.12533.K</b>	1/8
	3P+E		380-415V			<b>218.12536.K</b>	1/8
	3P+N+E		346-415V			<b>218.12537.K</b>	1/8
- Black-coloured							

						OPTIMA Series		
						248.		
								
						 <b>Screw terminals</b>		
						APPLIANCE INLET		
						IP66/IP67/IP69		
						75x75mm		
Poles	Hz	Volt	Colour	h				
2P+E	50Hz 60Hz	200-250V		6h	<b>248.1693.K</b>	10/50	<b>248.3293.K</b>	10/50
3P+E		380-415V			<b>248.1696.K</b>	10/50	<b>248.3296.K</b>	10/50
3P+N+E		346-415V			<b>248.1697.K</b>	10/50	<b>248.3297.K</b>	10/40
- Black-coloured								



# Plugs and sockets for special applications

## Events and exhibitions products

### ■ OPTIMA Series - IP66/IP67/IP69 versions >> Plugs / inlets (black version)

OPTIMA Series

248.



 **Mantle terminals**  
[Straight outlet]

APPLIANCE INLET

IP66/IP67/IP69

Current	Poles	Hz	Volt	Colour	h	100x110mm	114x114mm
63A	3P+N+E	50Hz 60Hz	346-415V		6h	<b>248.6397.K</b>	10
125A						<b>248.12597.K</b>	10

- Black-coloured







### ■ OPTIMA Series - IP66/IP67/IP69 versions >> Connectors (black version)

OPTIMA Series

318.



 **Screw terminals**

Current	Poles	Hz	Volt	Colour	h	CONNECTOR	CABLE GLAND
16A	2P+E	50Hz 60Hz	200-250V		6h	<b>318.1643.K</b>	10/40
	3P+E		380-415V			<b>318.1646.K</b>	10/40
	3P+N+E		346-415V			<b>318.1647.K</b>	10/40
32A	2P+E		200-250V		6h	<b>318.3243.K</b>	10/40
	3P+E		380-415V			<b>318.3246.K</b>	10/40
	3P+N+E		346-415V			<b>318.3247.K</b>	10/40

- Black-coloured



**Terminals**  
Mantle terminals (EASY-PLUG)



**Terminals**  
Screw terminals



**Terminals**  
Spring terminals (FAST WIRING)



**Terminals**  
Perforating terminals (FAST WIRING)







# Plugs and sockets for special applications

## Events and exhibitions products



### ■ OPTIMA Series - IP66/IP67/IP69 versions >> Connectors (black version)

						OPTIMA Series	
						318.	
							
						 <b>Perforating terminals</b>	
						CONNECTOR	
						IP66/IP67/IP69	
						CABLE GLAND	
Current	Poles	Hz	Volt	Colour	h		
16A	2P+E	50Hz 60Hz	200-250V		6h	<b>318.1643P.K</b>	10/40
	3P+E		380-415V			<b>318.1646P.K</b>	10/40
	3P+N+E		346-415V			<b>318.1647P.K</b>	10/40
- Black-coloured							

						OPTIMA Series	
						318.	
							
						 <b>Spring terminals</b>	
						CONNECTOR	
						IP66/IP67/IP69	
						CABLE GLAND	
Current	Poles	Hz	Volt	Colour	h		
32A	2P+E	50Hz 60Hz	200-250V		6h	<b>318.3243F.K</b>	10/40
	3P+E		380-415V			<b>318.3246F.K</b>	10/40
	3P+N+E		346-415V			<b>318.3247F.K</b>	10/40
- Black-coloured							

1.4



# Plugs and sockets for special applications

## Events and exhibitions products

### ■ OPTIMA Series - IP66/IP67/IP69 versions >> Connectors (black version)







1  
INDUSTRY

#### OPTIMA Series

318.



#### Mantle terminals

						CONNECTOR	
						IP66/IP67/IP69	
						CABLE GLAND	
Current	Poles	Hz	Volt	Colour	h		
63A	2P+E	50Hz 60Hz	200-250V		6h	<b>318.6343.K</b>	6/24
	3P+E		380-415V			<b>318.6346.K</b>	6/24
	3P+N+E		346-415V			<b>318.6347.K</b>	6/24
125A	2P+E	50Hz 60Hz	200-250V		6h	<b>318.12543.K</b>	1/8
	3P+E		380-415V			<b>318.12546.K</b>	1/8
	3P+N+E		346-415V			<b>318.12547.K</b>	1/8



- Black-coloured

#### OPTIMA Series

318.



#### Screw terminals [SAFE-IN]

						CONNECTOR	
						IP66/IP67/IP69	
						CABLE GLAND	
Current	Poles	Hz	Volt	Colour	h		
16A	2P+E	50Hz 60Hz	200-250V		6h	<b>318.1643H.K</b>	10/40
	3P+E		380-415V			<b>318.1646H.K</b>	10/40
	3P+N+E		346-415V			<b>318.1647H.K</b>	10/40

 Sockets with "SAFE-IN" safety device

- Black-coloured



**Terminals**  
Mantle terminals (EASY-PLUG)











**Terminals**  
Screw terminals

# Plugs and sockets for special applications



## Events and exhibitions products



### ■ OPTIMA Series - IP66/IP67/IP69 versions >> Flush mounting socket outlets (black version)

							OPTIMA Series		
							418.		
									
							 <b>Screw terminals</b> [Angled outlet]		
							FLUSH-MOUNTING SOCKET		
							IP66/IP67/IP69		
							70x87mm	84x106mm	
Current	Poles	Hz	Volt	Colour	h				
16A	2P+E	50Hz 60Hz	200-250V		6h	<b>418.1663.K</b>	10/100		
	3P+E		380-415V			<b>418.1666.K</b>	10/100		
	3P+N+E		346-415V			<b>418.1667.K</b>	10/100		
32A	2P+E	50Hz 60Hz	200-250V		6h			<b>418.3263.K</b>	10/50
	3P+E		380-415V					<b>418.3266.K</b>	10/50
	3P+N+E		346-415V					<b>418.3267.K</b>	10/50

- Black-coloured

							OPTIMA Series	
							418.	
								
							 <b>Mantle terminals</b> [Angled outlet]	
							FLUSH-MOUNTING SOCKET	
							IP66/IP67/IP69	
							100x110mm	
Current	Poles	Hz	Volt	Colour	h			
63A	3P+N+E	50Hz 60Hz	346-415V		6h	<b>418.6367.K</b>	6/30	

- Black-coloured



# Plugs and sockets for special applications

## Events and exhibitions products

### ■ OPTIMA Series - IP66/IP67/IP69 versions >> Flush mounting socket outlets (black version)

OPTIMA Series

418.





 **Screw terminals**  
[Angled outlet]  
[SAFE-IN]

FLUSH-MOUNTING SOCKET

IP66/IP67/IP69

70x87mm

Current	Poles	Hz	Volt	Colour	h		
16A	2P+E	50Hz 60Hz	200-250V		6h	<b>418.1663H.K</b>	10/100
	3P+E		380-415V			<b>418.1666H.K</b>	10/100
	3P+N+E		346-415V			<b>418.1667H.K</b>	10/100

 Sockets with "SAFE-IN" safety device

- Black-coloured

OPTIMA Series

418.









 **Spring terminals**  
[Angled outlet]

FLUSH-MOUNTING SOCKET

IP66/IP67/IP69

70x87mm

84x106mm

Current	Poles	Hz	Volt	Colour	h		
16A	2P+E	50Hz 60Hz	200-250V		6h	<b>418.1663F.K</b>	10/100
	3P+E		380-415V			<b>418.1666F.K</b>	10/100
	3P+N+E		346-415V			<b>418.1667F.K</b>	10/100
32A	2P+E	50Hz 60Hz	200-250V		6h	<b>418.3263F.K</b>	10/50
	3P+E		380-415V			<b>418.3266F.K</b>	10/50
	3P+N+E		346-415V			<b>418.3267F.K</b>	10/50

- Black-coloured



**Terminals**  
Spring terminals (FAST WIRING)



**Terminals**  
Screw terminals



**ITALIAN STANDARD**  
**P30 2P+E 16A**  
Shuttered socket CEI 23-50



**ITALIAN STANDARD**  
**P17/11 2P+E 16A**  
Shuttered socket CEI 23-50



**2P+E 16A**

# Plugs and sockets for special applications

## Events and exhibitions products



### ADAPTO Series - One-way adaptors

						ADAPTO Series	
						610.	
						<b>With IEC 309 industrial plug</b>	
						ONE-WAY ADAPTOR	
						IP20	
Supply	Current	Poles	Volt	Sockets		Notes	
						16A	
						2P+E	
Appliance inlet IEC309 16A	16A	2P+E	250V	1	2	2 BIV.+1 P30	<b>610.388.N</b> 10/100
						1	
						ITALIAN P17/11 BIV.	
						<b>610.380.N</b> 10/100	

- For temporary use only
- Black-coloured

						ADAPTO Series	
						610.	
						<b>With domestic plug</b>	
						ONE-WAY ADAPTOR	
						IP20	
Supply	Current	Poles	Volt	Sockets		Notes	
						16A	
						2P+E	
Appliance inlet 16A IT Std	16A	2P+E	250V	1		ITALIAN S17	<b>610.384.N</b> 10/100

- For temporary use only
- Black-coloured

1.4



# Plugs and sockets for special applications

## Industrial plugs and sockets for military use

### EUREKA-MIL Series

#### EUREKA - MIL Series

1

INDUSTRY

215.

216.



Plugs

Current	Poles	Hz	Volt	Colour	h	PLUG			
						CABLE GLAND			
16A	2P+E	50/60Hz	200-250V		6h				
	3P+E		380-415V						
	3P+N+E		346-415V						
32A	2P+E		200-250V					<b>216.81633</b>	1/5
	3P+E		380-415V					<b>216.81636</b>	1/5
	3P+N+E		346-415V					<b>216.81637</b>	1/5
63A	2P+E		200-250V					<b>216.83233</b>	1/5
	3P+E		380-415V					<b>216.83236</b>	1/5
	3P+N+E		346-415V					<b>216.83237</b>	1/5
125A	2P+E	200-250V				<b>215.86333</b>			
	3P+E	380-415V				<b>215.86336</b>	1		
	3P+N+E	346-415V				<b>215.86337</b>	1		
	2P+E	200-250V				<b>215.812533</b>			
	3P+E	380-415V				<b>215.812536</b>			
	3P+N+E	346-415V				<b>215.812537</b>			

- Green-coloured



**Terminals**  
Screw terminals

# Plugs and sockets for special applications

## Industrial plugs and sockets for military use



### EUREKA-MIL Series

#### EUREKA - MIL Series

247.



Appliance inlets  
[Straight outlet]

#### APPLIANCE INLET

IP67

Current	Poles	Hz	Volt	Colour	h	120x120mm		145x145mm
						Part No.	Rating	Part No.
16A	2P+E	50/60Hz	200-250V	Blue	6h	<b>247.81693</b>	1/5	
	3P+E		380-415V	Red		<b>247.81696</b>		
	3P+N+E		346-415V	Red		<b>247.81697</b>	1/5	
32A	2P+E	50/60Hz	200-250V	Blue	6h	<b>247.83293</b>	1/5	
	3P+E		380-415V	Red		<b>247.83296</b>		
	3P+N+E		346-415V	Red		<b>247.83297</b>	1/5	
63A	2P+E	50/60Hz	200-250V	Blue	6h	<b>247.86393</b>		
	3P+E		380-415V	Red		<b>247.86396</b>		
	3P+N+E		346-415V	Red		<b>247.86397</b>	1	
125A	2P+E	50/60Hz	200-250V	Blue	6h			<b>247.812593</b>
	3P+E		380-415V	Red				<b>247.812596</b>
	3P+N+E		346-415V	Red				<b>247.812597</b>

- Green-coloured



APPLICATION EXAMPLE

1.4



# Plugs and sockets for special applications

## Industrial plugs and sockets for military use

### EUREKA-MIL Series

#### EUREKA - MIL Series

1

INDUSTRY

315.

316.











 **Straight connectors**

CONNECTOR

IP67

CABLE GLAND

Current	Poles	Hz	Volt	Colour	h	CONNECTOR	CABLE GLAND	
16A	2P+E	50/60Hz	200-250V		6h			
	3P+E		380-415V				<b>316.81643</b> 1/5	
	3P+N+E		346-415V			<b>316.81646</b>		<b>316.81647</b> 1/5
32A	2P+E		200-250V				<b>316.83243</b> 1/5	
	3P+E		380-415V				<b>316.83246</b>	
	3P+N+E		346-415V			<b>316.83247</b> 1/5		
63A	2P+E		200-250V				<b>315.86343</b> 1	
	3P+E		380-415V				<b>315.86346</b>	
	3P+N+E		346-415V			<b>315.86347</b> 1		
125A	2P+E	200-250V			<b>315.812543</b>			
	3P+E	380-415V			<b>315.812546</b> 1			
	3P+N+E	346-415V		<b>315.812547</b>				

- Green-coloured



**Terminals**  
Screw terminals



# Plugs and sockets for special applications

## Industrial plugs and sockets for military use



### EUREKA-MIL Series

#### EUREKA - MIL Series

427.



Panel mounting sockets outlets [Straight outlet]

#### FLUSH-MOUNTING SOCKET

IP67

Current	Poles	Hz	Volt	Colour	h	FLUSH-MOUNTING SOCKET		
						100x100mm	120x120mm	145x145mm
16A	2P+E	50/60Hz	200-250V		6h	<b>427.81663</b>	1/5	
	3P+E		380-415V			<b>427.81666</b>		
	3P+N+E		346-415V			<b>427.81667</b>	1/5	
32A	2P+E	50/60Hz	200-250V		6h	<b>427.83263</b>	1/5	
	3P+E		380-415V			<b>427.83266</b>		
	3P+N+E		346-415V			<b>427.83267</b>	1/5	
63A	2P+E	50/60Hz	200-250V		6h		<b>427.86363</b>	
	3P+E		380-415V				<b>427.86366</b>	
	3P+N+E		346-415V				<b>427.86367</b>	1
125A	2P+E	50/60Hz	200-250V		6h			<b>427.812563</b>
	3P+E		380-415V					<b>427.812566</b>
	3P+N+E		346-415V					<b>427.812567</b>

- Green-coloured

1.4



# Plugs and sockets for special applications

## Industrial plugs and sockets for military use

### EUREKA-MIL Series

#### ACCESSORIES

570.



1  
INDUSTRY

Description	Current	Poles	Cover for IP67 plugs
PLUG CAP	16A 20A	2P+E	<b>570.80163</b> 10/100
		3P+E	<b>570.80164</b> 10/100
		3P+N+E	<b>570.80165</b> 10/100
	30A 32A	2/3P+E	<b>570.80325</b> 10/100
			<b>570.80324</b> 10/100
	60A 63A	ALL	<b>570.8063</b> 10
100A 125A		<b>570.8125</b> 10	

- Green-coloured



#### SNAP-ON DEVICE

##### Snap-action opening and closing

A patented "SNAP-ON" device provides snap-action opening and closing of EUREKA Series plugs and sockets. The "SNAP-ON" device significantly cuts down on wiring time: it opens by pressing down on the spring with a tool and closes simply by twisting the grip or the insert.



2P+E 16A



3P+E 16A



3P+N+E 16A

# Plugs and sockets for special applications

## Industrial plugs and sockets for military use



### EUREKA-MIL Series

ADAPTO Series

603.



Sockets

Adaptors

Current	Poles	Volt	16A			MULTI-WAY ADAPTOR	
			2P+E	3P+E	3P+N+E	IP66	Terminal block 16mm <sup>2</sup>
16A	2P+E	230V	3			<b>603.83505-062</b>	1/10
	3P+E			3		<b>603.83505-063</b>	
	3P+N+E	400V	2	1		<b>603.83505-059</b>	
			2		1	<b>603.83505-061</b>	1/10
					3	<b>603.83505-064</b>	

- Zinc-plated steel carrying handle.
- Equipped with PG21 cable gland, cable clamp and terminal block.
- Green-coloured

1.4



# Plugs and sockets for special applications

## Plugs and sockets UL/CSA

### ■ Series I [International] - IP44 splashproof

#### EUREKA[PIN&SLEEVE] Series

SCM.



 **Plugs IP44**

 **Appliance inlets IP44 [Straight outlet]**









PLUG

APPLIANCE INLET

IP44

120x120mm

CABLE SLEEVE

Current	Poles	Hz	Volt	Colour	h	CABLE SLEEVE			
16A	2P 3W	50/60Hz	100-130V		4h	<b>SCM316P4S</b>	1/5	<b>SCM316B4S</b>	1/5
			200-250V		6h	<b>SCM316P6S</b>	1/5	<b>SCM316B6S</b>	1/5
	3P 4W		380-415V		6h	<b>SCM416P6S</b>	1/5	<b>SCM416B6S</b>	1/5
	4P 5W		346-415V		6h	<b>SCM516P6S</b>	1/5		
32A	2P 3W	50/60Hz	100-130V		4h	<b>SCM332P4S</b>	1/5		
			200-250V		6h	<b>SCM332P6S</b>	1/5	<b>SCM332B6S</b>	1/5
	3P 4W		380-415V		3h	<b>SCM432P6S</b>	1/5	<b>SCM432B6S</b>	1/5
	4P 5W		380V 50Hz / 440V 60Hz		6h	<b>SCM532P6S</b>	1/5	<b>SCM532B6S</b>	1/5

- UL classified



**INTERNATIONAL RATINGS**  
 Products certified by UL laboratories according to standards IEC60309-1 and IEC60309-2



**Terminals**  
Screw terminals

# Plugs and sockets for special applications

## Plugs and sockets UL/CSA



### EUREKA[PIN&SLEEVE] Series

SCM.



**Straight connectors IP44**



**Panel mounting sockets outlets IP44 [Straight outlet]**

CONNECTOR		RECEPTACLE	
		IP44	
		100x100mm	
CABLE SLEEVE			
<b>SCM316C4S</b>	1/5	<b>SCM316R4S</b>	1/5
<b>SCM316C6S</b>	1/5	<b>SCM316R6S</b>	1/5
<b>SCM416C6S</b>	1/5	<b>SCM416R6S</b>	1/5
<b>SCM516C6S</b>	1/5	<b>SCM516R6S</b>	1/5
<b>SCM332C4S</b>	1/5	<b>SCM332R4S</b>	1/5
<b>SCM332C6S</b>	1/5	<b>SCM332R6S</b>	1/5
<b>SCM432C6S</b>	1/5	<b>SCM432R6S</b>	1/5
		<b>SCM432R3S</b>	1/5
<b>SCM532C6S</b>	1/5	<b>SCM532R6S</b>	1/5

1.4



# Plugs and sockets for special applications

## Plugs and sockets UL/CSA

### ■ Series I [International] - IP67 watertight

#### EUREKA[PIN&SLEEVE] Series

SCM.



 **Plugs IP67**

 **Appliance inlets IP67 [Straight outlet]**

















PLUG

APPLIANCE INLET

IP67

120x120mm

CABLE GLAND

Current	Poles	Hz	Volt	Colour	h	CABLE GLAND			
16A	2P 3W	50/60Hz	100-130V		4h	<b>SCM316P4W</b>	1/5	<b>SCM316B4W</b>	1/5
			200-250V		6h	<b>SCM316P6W</b>	1/5	<b>SCM316B6W</b>	1/5
	3P 4W		380-415V		6h	<b>SCM416P6W</b>	1/5	<b>SCM416B6W</b>	1/5
	4P 5W		346-415V		6h	<b>SCM516P6W</b>	1/5	<b>SCM516B6W</b>	1/5
32A	2P 3W	50/60Hz	100-130V		4h	<b>SCM332P4W</b>	1/5	<b>SCM332B4W</b>	1/5
			200-250V		6h	<b>SCM332P6W</b>	1/5	<b>SCM332B6W</b>	1/5
	380-415V			3h	<b>SCM432P6W</b>	1/5	<b>SCM432B6W</b>	1/5	
	380V 50Hz / 440V 60Hz			3h	<b>SCM432P3W</b>	1/5			
	3P 4W		600-690V		5h	<b>SCM432P5W</b>	1/5		
63A	4P 5W	50/60Hz	380V 50Hz / 440V 60Hz		3h	<b>SCM532P6W</b>	1/5	<b>SCM532B6W</b>	1/5
	2P 3W		200-250V		6h	<b>SCM363P6W</b>	1	<b>SCM363B6W</b>	1
	3P 4W		380-415V		6h	<b>SCM463P6W</b>	1	<b>SCM463B6W</b>	1
	4P 5W		600-690V		5h	<b>SCM463P5W</b>	1		
	4P 5W		346-415V		6h	<b>SCM563P6W</b>	1	<b>SCM563B6W</b>	1
125A	2P 3W	50/60Hz	200-250V		6h	<b>SCM3125P6W</b>	1		
	3P 4W		380-415V		6h	<b>SCM4125P6W</b>	1		
	4P 5W		346-415V		6h	<b>SCM5125P6W</b>	1		

- UL classified



#### INTERNATIONAL RATINGS

Products certified by UL laboratories according to standards IEC60309-1 and IEC60309-2



**Terminals**  
Screw terminals

# Plugs and sockets for special applications

## Plugs and sockets UL/CSA



### EUREKA[PIN&SLEEVE] Series

SCM.



**Appliance inlets  
IP67 [Straight  
outlet]**

**Straight  
connectors IP67**

**Panel mounting  
sockets outlets  
IP67 [Straight  
outlet]**

APPLIANCE INLET		CONNECTOR		RECEPTACLE	
145x145mm		CABLE GLAND		IP67	
				100x100mm	
				120x120mm	
				145x145mm	
		<b>SCM316C4W</b>	1/5	<b>SCM316R4W</b>	1/5
		<b>SCM316C6W</b>	1/5	<b>SCM316R6W</b>	1/5
		<b>SCM416C6W</b>	1/5	<b>SCM416R6W</b>	1/5
		<b>SCM516C6W</b>	1/5	<b>SCM516R6W</b>	1/5
		<b>SCM332C4W</b>	1/5	<b>SCM332R4W</b>	1/5
		<b>SCM332C6W</b>	1/5	<b>SCM332R6W</b>	1/5
		<b>SCM432C6W</b>	1/5	<b>SCM432R6W</b>	1/5
		<b>SCM432C3W</b>	1/5		
				<b>SCM432R5W</b>	
				<b>SCM432R3W</b>	1/5
		<b>SCM532C6W</b>	1/5	<b>SCM532R6W</b>	1/5
		<b>SCM363C6W</b>	1		<b>SCM363R6W</b> 1
		<b>SCM463C6W</b>	1		<b>SCM463R6W</b> 1
					<b>SCM463R5W</b>
		<b>SCM563C6W</b>	1		<b>SCM563R6W</b> 1
<b>SCM3125B6W</b>	1	<b>SCM3125C6W</b>	1		<b>SCM3125R6W</b> 1
<b>SCM4125B6W</b>	1	<b>SCM4125C6W</b>	1		<b>SCM4125R6W</b> 1
<b>SCM5125B6W</b>	1	<b>SCM5125C6W</b>	1		<b>SCM5125R6W</b> 1

1.4



# Plugs and sockets for special applications

## Plugs and sockets UL/CSA

### ■ Series II [North America] - IP44 splashproof [20A-30A]

EUREKA[PIN&SLEEVE] Series

SCM.

1  
INDUSTRY



Straight plugs IP44

Appliance inlets IP44 [Straight outlet]

Poles	Volt	Colour	h	CABLE SLEEVE		APPLIANCE INLET	
				20A	30A	20A	30A
2P 3W	125V		4h	SCM320P4S 1/5	SCM330P4S 1/5	SCM320B4S 1/5	SCM330B4S 1/5
	250V		6h	SCM320P6S <sup>[1][2]</sup> 1/5	SCM330P6S <sup>[1][2]</sup> 1/5	SCM320B6S <sup>[1]</sup> 1/5	SCM330B6S <sup>[1]</sup> 1/5
	277V		5h	SCM320P5S 1/5		SCM320B5S 1/5	
	480V		7h	SCM320P7S 1/5	SCM330P7S 1/5	SCM320B7S 1/5	SCM330B7S 1/5
	550VDC		8h		SCM330P8S 1/5		SCM330B8S 1/5
3P 4W	125/250V		12h	SCM420P12S 1/5	SCM430P12S 1/5	SCM420B12S 1/5	SCM430B12S 1/5
	3Ø250V		9h	SCM420P9S <sup>[1]</sup> 1/5	SCM430P9S <sup>[1]</sup> 1/5	SCM420B9S 1/5	SCM430B9S 1/5
	380-415V		6h	SCM420P6S <sup>[1][2]</sup> 1/5	SCM430P6S <sup>[1][2]</sup> 1/5	SCM420B6S <sup>[1]</sup> 1/5	SCM430B6S <sup>[1]</sup> 1/5
	3Ø480V		7h	SCM420P7S 1/5	SCM430P7S 1/5	SCM420B7S 1/5	SCM430B7S 1/5
	3Ø600V		5h	SCM420P5S 1/5	SCM430P5S 1/5	SCM420B5S 1/5	SCM430B5S 1/5
4P 5W	3ØY120/208V		9h	SCM520P9S <sup>[1]</sup> 1/5	SCM530P9S <sup>[1]</sup> 1/5	SCM520B9S 1/5	SCM530B9S 1/5
	200/346V 240/415V		6h	SCM520P6S <sup>[1][2]</sup> 1/5	SCM530P6S <sup>[1][2]</sup> 1/5	SCM520B6S <sup>[1]</sup> 1/5	SCM530B6S <sup>[1]</sup> 1/5
	3ØY347/600V		5h	SCM520P5S 1/5	SCM530P5S 1/5	SCM520B5S 1/5	SCM530B5S 1/5
	480V		7h	SCM520P7S 1/5	SCM530P7S 1/5	SCM520B7S 1/5	SCM530B7S 1/5

[1] Dual ratings - Products with dual classification: Series I (International) and Series II (North America)

[2] Products with dual certifications: UL listed (North America) and ENEC (International)

- UL listed



Terminals  
Screw terminals



# Plugs and sockets for special applications

## Plugs and sockets UL/CSA



### EUREKA[PIN&SLEEVE] Series

SCM.



**Straight connectors IP44**



**Panel mounting sockets outlets IP44 [Straight outlet]**

CONNECTOR				RECEPTACLE			
CABLE SLEEVE				100x100mm			
20A		30A		20A		30A	
SCM320C4S	1/5	SCM330C4S	1/5	SCM320R4S	1/5	SCM330R4S	1/5
SCM320C6S <sup>[1][2]</sup>	1/5	SCM330C6S <sup>[1][2]</sup>	1/5	SCM320R6S <sup>[1]</sup>	1/5	SCM330R6S <sup>[1]</sup>	1/5
SCM320C5S	1/5			SCM320R5S	1/5		
SCM320C7S		SCM330C7S	1/5	SCM320R7S		SCM330R7S	
		SCM330C8S	1			SCM330R8S	1/5
SCM420C12S	1/5	SCM430C12S	1/5	SCM420R12S	1/5	SCM430R12S	1/5
SCM420C9S <sup>[1]</sup>	1/5	SCM430C9S <sup>[1]</sup>	1/5	SCM420R9S	1/5	SCM430R9S	1/5
SCM420C6S <sup>[1][2]</sup>	1/5	SCM430C6S <sup>[1][2]</sup>	1/5	SCM420R6S <sup>[1]</sup>	1/5	SCM430R6S <sup>[1]</sup>	1/5
SCM420C7S	1/5	SCM430C7S		SCM420R7S	1/5	SCM430R7S	1/5
SCM420C5S	1/5	SCM430C5S	1/5	SCM420R5S	1/5	SCM430R5S	1/5
SCM520C9S <sup>[1]</sup>	1	SCM530C9S <sup>[1]</sup>	1/5	SCM520R9S	1/5	SCM530R9S	1/5
SCM520C6S <sup>[1][2]</sup>	1/5	SCM530C6S <sup>[1][2]</sup>	1/5	SCM520R6S <sup>[1]</sup>	1/5	SCM530R6S <sup>[1]</sup>	1/5
SCM520C5S	1/5	SCM530C5S		SCM520R5S	1/5	SCM530R5S	
SCM520C7S	1/5	SCM530C7S	1/5	SCM520R7S	1/5	SCM530R7S	1/5

1.4



# Plugs and sockets for special applications

## Plugs and sockets UL/CSA

### ■ Series II [North America] - IP67 watertight [20A-30A]

EUREKA[PIN&SLEEVE] Series

SCM.

1  
INDUSTRY



Straight plugs IP67

Appliance inlets IP67 [Straight outlet]

PLUG	APPLIANCE INLET
IP67	
120x120mm	
CABLE GLAND	

Poles	Volt	Colour	h	20A		30A		20A		30A	
				Part No.	1/5	Part No.	1/5	Part No.	1/5	Part No.	1/5
2P 3W	125V	Yellow	4h	SCM320P4W	1/5	SCM330P4W	1/5	SCM320B4W	1/5	SCM330B4W	1/5
	250V	Blue	6h	SCM320P6W <sup>[1][2]</sup>	1/5	SCM330P6W <sup>[1][2]</sup>	1/5	SCM320B6W <sup>[1]</sup>	1/5	SCM330B6W <sup>[1]</sup>	1/5
	277V	Grey	5h	SCM320P5W	1/5			SCM320B5W	1/5		
	480V	Red	7h	SCM320P7W	1/5	SCM330P7W	1/5	SCM320B7W	1/5	SCM330B7W	1/5
	550VDC	Black	8h			SCM330P8W	1/5			SCM330B8W	1/5
3P 4W	125/250V	Orange	12h	SCM420P12W	1/5	SCM430P12W	1/5	SCM420B12W	1/5	SCM430B12W	1/5
	3Ø250V	Blue	9h	SCM420P9W <sup>[1]</sup>	1/5	SCM430P9W <sup>[1]</sup>	1/5	SCM420B9W	1/5	SCM430B9W	1/5
	380-415V	Red	6h	SCM420P6W <sup>[1][2]</sup>	1/5	SCM430P6W <sup>[1][2]</sup>	1/5	SCM420B6W <sup>[1]</sup>	1/5	SCM430B6W <sup>[1]</sup>	1/5
	3Ø480V	Red	7h	SCM420P7W	1/5	SCM430P7W	1/5	SCM420B7W	1/5	SCM430B7W	1/5
	3Ø600V	Black	5h	SCM420P5W	1/5	SCM430P5W	1/5	SCM420B5W	1/5	SCM430B5W	1/5
4P 5W	3ØY120/208V	Blue	9h	SCM520P9W <sup>[1]</sup>	1/5	SCM530P9W <sup>[1]</sup>	1/5	SCM520B9W	1/5	SCM530B9W	1/5
	200/346V 240/415V	Red	6h	SCM520P6W <sup>[1][2]</sup>	1/5	SCM530P6W <sup>[1][2]</sup>	1/5	SCM520B6W <sup>[1]</sup>	1/5	SCM530B6W <sup>[1]</sup>	1/5
	3ØY347/600V	Black	5h	SCM520P5W	1/5	SCM530P5W	1/5	SCM520B5W		SCM530B5W	
	480V	Red	7h	SCM520P7W	1/5	SCM530P7W	1/5	SCM520B7W	1/5	SCM530B7W	1/5

[1] Dual ratings - Products with dual classification: Series I (International) and Series II (North America)

[2] Products with dual certifications: UL listed (North America) and ENEC (International)

- UL listed



Terminals  
Screw terminals

# Plugs and sockets for special applications

## Plugs and sockets UL/CSA



### EUREKA[PIN&SLEEVE] Series

SCM.



**Straight connectors IP67**



**Panel mounting sockets outlets IP67 [Straight outlet]**

CONNECTOR				RECEPTACLE			
CABLE GLAND				100x100mm			
20A		30A		20A		30A	
SCM320C4W	1/5	SCM330C4W	1/5	SCM320R4W	1/5	SCM330R4W	1/5
SCM320C6W <sup>[1][2]</sup>	1/5	SCM330C6W <sup>[1][2]</sup>	1/5	SCM320R6W <sup>[1]</sup>	1/5	SCM330R6W <sup>[1]</sup>	1/5
SCM320C5W	1/5			SCM320R5W	1/5		
SCM320C7W	1/5	SCM330C7W	1/5	SCM320R7W	1/5	SCM330R7W	1/5
		SCM330C8W	1			SCM330R8W	1/5
SCM420C12W	1/5	SCM430C12W	1/5	SCM420R12W	1/5	SCM430R12W	1/5
SCM420C9W <sup>[1]</sup>	1/5	SCM430C9W <sup>[1]</sup>	1/5	SCM420R9W	1/5	SCM430R9W	1/5
SCM420C6W <sup>[1][2]</sup>	1/5	SCM430C6W <sup>[1][2]</sup>	1/5	SCM420R6W <sup>[1]</sup>	1/5	SCM430R6W <sup>[1]</sup>	1/5
SCM420C7W	1/5	SCM430C7W	1/5	SCM420R7W	1/5	SCM430R7W	1/5
SCM420C5W	1/5	SCM430C5W	1/5	SCM420R5W	1/5	SCM430R5W	1/5
SCM520C9W <sup>[1]</sup>	1/5	SCM530C9W <sup>[1]</sup>	1/5	SCM520R9W	1/5	SCM530R9W	1/5
SCM520C6W <sup>[1][2]</sup>	1/5	SCM530C6W <sup>[1][2]</sup>	1/5	SCM520R6W <sup>[1]</sup>	1/5	SCM530R6W <sup>[1]</sup>	1/5
SCM520C5W	1/5	SCM530C5W	1/5	SCM520R5W	1/5	SCM530R5W	1/5
SCM520C7W	1/5	SCM530C7W	1/5	SCM520R7W	1/5	SCM530R7W	1/5

1.4



# Plugs and sockets for special applications

## Plugs and sockets UL/CSA

### ■ Series II [North America] - IP67 watertight [60A-100A]

EUREKA[PIN&SLEEVE] Series

SCM.



Straight plugs IP67

Appliance inlets IP67 [Straight outlet]

PLUG	APPLIANCE INLET
------	-----------------

IP67	
------	--

120x120mm	145x145mm
-----------	-----------

CABLE GLAND	
-------------	--

Poles	Volt	Colour	h	60A		100A	
				60A	100A	60A	100A
2P 3W	>50-250V	Grey	3h	SCM360P3W	1	SCM360B3W	1
	125V	Yellow	4h	SCM360P4W	1	SCM360B4W	1
	250V	Blue	6h	SCM360P6W <sup>[1][2]</sup>	1	SCM360B6W <sup>[1]</sup>	1
	277V	Grey	5h	SCM360P5W	1	SCM360B5W	1
	480V	Red	7h	SCM360P7W	1	SCM360B7W	1
	550VDC	Black	8h	SCM360P8W	1	SCM360B8W	1
3P 4W	125/250V	Orange	12h	SCM460P12W	1	SCM460B12W	1
	3Ø250V	Blue	9h	SCM460P9W <sup>[1]</sup>	1	SCM460B9W	1
	380-415V	Green	6h	SCM460P6W <sup>[1][2]</sup>	1/6	SCM460B6W <sup>[1]</sup>	1/10
	3Ø480V	Red	7h	SCM460P7W	1	SCM460B7W	1
	3Ø600V	Black	5h	SCM460P5W	1	SCM460B5W	1
	3ØY120/208V	Blue	9h	SCM560P9W <sup>[1]</sup>	1	SCM560B9W	1
4P 5W	200/346V 240/415V	Red	6h	SCM560P6W <sup>[1][2]</sup>	1/6	SCM560B6W <sup>[1]</sup>	1/10
	3ØY347/600V	Black	5h	SCM560P5W	1	SCM560B5W	1
	400VDC	Black	8h	SCM560P8W	1	SCM560B8W	1
	480V	Red	7h	SCM560P7W	1	SCM560B7W	1

[1] Dual ratings - Products with dual classification: Series I (International) and Series II (North America)

[2] Products with dual certifications: UL listed (North America) and ENEC (International)

- UL listed



**NORTH AMERICAN RATINGS**

Products certified by UL laboratories according to standards UL1682 and UL1686



**ENEC certified**

Products with dual certifications: UL listed (North America) and ENEC (International)



**Terminals**  
Screw terminals

# Plugs and sockets for special applications

## Plugs and sockets UL/CSA



### EUREKA[PIN&SLEEVE] Series

SCM.



**Straight connectors IP67**



**Panel mounting sockets outlets IP67 [Straight outlet]**

CONNECTOR				RECEPTACLE			
				120x120mm		145x145mm	
CABLE GLAND							
60A		100A		60A		100A	
SCM360C3W	1			SCM360R3W	1		
SCM360C4W	1	SCM3100C4W		SCM360R4W	1	SCM3100R4W	
SCM360C6W <sup>[1][2]</sup>	1	SCM3100C6W <sup>[1]</sup>	1	SCM360R6W <sup>[1]</sup>	1	SCM3100R6W <sup>[1]</sup>	1
SCM360C5W	1	SCM3100C5W		SCM360R5W	1	SCM3100R5W	
SCM360C7W	1	SCM3100C7W		SCM360R7W	1	SCM3100R7W	
SCM360C8W	1	SCM3100C8W	1	SCM360R8W	1	SCM3100R8W	1
SCM460C12W	1	SCM4100C12W	1	SCM460R12W	1	SCM4100R12W	1
SCM460C9W <sup>[1]</sup>	1	SCM4100C9W <sup>[1]</sup>	1	SCM460R9W	1	SCM4100R9W	1
SCM460C6W <sup>[1][2]</sup>	1	SCM4100C6W <sup>[1]</sup>	1/6	SCM460R6W <sup>[1]</sup>	1/10	SCM4100R6W <sup>[1]</sup>	1/10
SCM460C7W	1	SCM4100C7W	1	SCM460R7W	1	SCM4100R7W	1
SCM460C5W	1	SCM4100C5W	1	SCM460R5W	1	SCM4100R5W	1
SCM560C9W <sup>[1]</sup>	1	SCM5100C9W <sup>[1]</sup>	1	SCM560R9W	1	SCM5100R9W	1
SCM560C6W <sup>[1][2]</sup>	1/6	SCM5100C6W <sup>[1]</sup>	1/6	SCM560R6W <sup>[1]</sup>	1/10	SCM5100R6W <sup>[1]</sup>	1/10
SCM560C5W	1	SCM5100C5W	1	SCM560R5W	1	SCM5100R5W	1
		SCM5100C8W	1			SCM5100R8W	1
SCM560C7W	1	SCM5100C7W	1	SCM560R7W	1	SCM5100R7W	1

1.4



# Plugs and sockets for special applications

## Plugs and sockets UL/CSA

### Accessories

#### EUREKA[PIN&SLEEVE] Series

SCM.



1

INDUSTRY

Description	IP	Version	Liquid tight adapters	
LIQUID TIGHT ADAPTER	IP67	20A 3-4 WIRE 1/2" NPT	<b>SCMSAA12</b>	5
		20A 5 WIRE 1/2" NPT	<b>SCMSAB12</b>	5
		30A 3-4 WIRE 3/4" NPT	<b>SCMSAB34</b>	5
		30A 5 WIRE 1" NPT	<b>SCMSAC100</b>	5
		60A 3-4-5 WIRE 1 1/4" NPT	<b>SCMSAC125</b>	5
		30A 5 WIRE 3/4" NPT	<b>SCMSAC34</b>	5
		100A 3-4-5 WIRE 1 1/4" NPT	<b>SCMSAD125</b>	5

- UL listed
- For attaching flexible liquidtight metal conduit to Scame EUREKA[PIN&SLEEVE] Series plugs and connectors

**PIN & SLEEVE**  
Example of applications



# Plugs and sockets for special applications

## Plugs and sockets UL/CSA



### ■ Accessories

#### EUREKA[PIN&SLEEVE] Series

SCM.



Description	IP	Version	Non-metallic Back-Boxes	
BACK BOX	IP67	100x100mm - SMALL	<b>SCMBB01</b>	1/12
		120x120mm - MEDIUM	<b>SCMBB02</b>	1/12
		145x145mm - LARGE	<b>SCMBB03</b>	1/6

- For fixed plugs and sockets EUREKA Series [PIN&SLEEVE]
- UL listed

**BACK-BOXES**  
Ground plate and ground terminals



1.4



# Plugs and sockets for special applications

## Plugs and sockets UL/CSA

### Accessories

#### ACCESSORIES

570.



1

INDUSTRY

Description	Current	Poles	Cover for IP66/IP67/IP69 plugs	
PLUG CAP	16A 20A	2P+E	<b>570.90163</b>	10/100
		3P+E	<b>570.90164</b>	10/100
	30A 32A	3P+N+E	<b>570.90165</b>	10/100
			<b>570.90325</b>	10/100
		2/3P+E	<b>570.90324</b>	10/100
	60A 63A	ALL	<b>570.9063</b>	10
	100A 125A		<b>570.9125</b>	10

2

3

4



# Plugs and sockets for special applications

Plugs and sockets UL/CSA



## ■ ADVANCE-GRP[HD] Series - Interlocked-switch socket outlets >> Without base IP66/67/69 - Type 12, 3R, 4, 4X - Watertight

### ADVANCE-GRP[PIN&SLEEVE] Series

SCM.



Without fuse carrier

Current	Poles	Volt	Colour	h	INTERLOCKED SOCKET			
					IP66/IP67/IP69			
20A	2P 3W	125V		4h	SCM320MI4W-NB	1/6		
		250V		6h	SCM320MI6W-NB	1/6		
		480V		7h	SCM320MI7W-NB	1/6		
	3P 4W	125/250V		12h	SCM420MI12W-NB	1/6		
		3Ø250V		9h	SCM420MI9W-NB	1/6		
		3Ø480V		7h	SCM420MI7W-NB	1/6		
		3Ø600V		5h	SCM420MI5W-NB	1/6		
		3ØY120/208V		9h	SCM520MI9W-NB	1/6		
		3ØY347/600V		5h	SCM520MI5W-NB	1/6		
	4P 5W	480V		7h	SCM520MI7W-NB	1/6		
		30A	2P 3W	125V		4h	SCM330MI4W-NB	1/6
				250V		6h	SCM330MI6W-NB	1/6
480V				7h	SCM330MI7W-NB	1/6		
3P 4W	125/250V			12h	SCM430MI12W-NB	1/6		
	3Ø250V			9h	SCM430MI9W-NB	1/6		
	3Ø480V			7h	SCM430MI7W-NB	1/6		
	3Ø600V		5h	SCM430MI5W-NB	1/6			
4P 5W	3ØY120/208V		9h	SCM530MI9W-NB	1/6			
	3ØY347/600V		5h	SCM530MI5W-NB	1/6			
	480V		7h	SCM530MI7W-NB	1/6			
32A	3P 4W	380V 50Hz / 440V 60Hz		3h	SCM432MI3W-NB	1/6		
		250V		6h	SCM360MI6W-NB	1		
		480V		7h	SCM360MI7W-NB	1		
60A	3P 4W	3Ø250V		9h	SCM460MI9W-NB	1		
		3Ø600V		5h	SCM460MI5W-NB	1		
		3ØY120/208V		9h	SCM560MI9W-NB	1		
	4P 5W	3ØY347/600V		5h	SCM560MI5W-NB	1		
		480V		7h	SCM560MI7W-NB	1/1		

☼ With power indicating led

- UL listed
- To be matched with the respective bases
- Empty base: ADVANCE-GRP System (fam. 579)



**NORTH AMERICAN RATINGS**

Products certified by UL laboratories according to standards UL1682 and UL1686

1.4



# Plugs and sockets for special applications

## Plugs and sockets UL/CSA

■ **ADVANCE-GRP[HD] Series - Interlocked-switch socket outlets >> Surface mounting IP66/67/69 - Type 12K, 3R, 4, 4X - Watertight**

### ADVANCE-GRP[PIN&SLEEVE] Series

SCM.



Without fuse carrier

Current	Poles	Volt	Colour	h	INTERLOCKED SOCKET			
					IP66/IP67/IP69			
20A	2P 3W	125V	Yellow	4h	SCM320MI4W	1/6		
		250V	Blue	6h	SCM320MI6W	1/6		
		480V	Red	7h	SCM320MI7W	1/6		
	3P 4W	125/250V	Orange	12h	SCM420MI12W	1/6		
		3Ø250V	Blue	9h	SCM420MI9W	1/6		
		3Ø480V	Red	7h	SCM420MI7W	1/6		
		3Ø600V	Black	5h	SCM420MI5W	1/6		
		3ØY120/208V	Blue	9h	SCM520MI9W	1/6		
		3ØY347/600V	Black	5h	SCM520MI5W	1/6		
	4P 5W	480V	Red	7h	SCM520MI7W	1/6		
		30A	2P 3W	125V	Yellow	4h	SCM330MI4W	1/6
				250V	Blue	6h	SCM330MI6W	1/6
480V	Red			7h	SCM330MI7W	1/6		
3P 4W	125/250V		Orange	12h	SCM430MI12W	1/6		
	3Ø250V		Blue	9h	SCM430MI9W	1/6		
	3Ø480V		Red	7h	SCM430MI7W	1/6		
	3Ø600V	Black	5h	SCM430MI5W	1/6			
4P 5W	3ØY120/208V	Blue	9h	SCM530MI9W	1/6			
	3ØY347/600V	Black	5h	SCM530MI5W	1/6			
	480V	Red	7h	SCM530MI7W	1/6			
32A	3P 4W	380V 50Hz / 440V 60Hz	Red	3h	SCM432MI3W	1/6		
		250V	Blue	6h	SCM360MI6W	1		
		480V	Red	7h	SCM360MI7W	1		
60A	3P 4W	3Ø250V	Blue	9h	SCM460MI9W	1		
		3Ø480V	Red	7h	SCM460MI7W	1		
		3Ø600V	Black	5h	SCM460MI5W	1		
	4P 5W	3ØY120/208V	Blue	9h	SCM560MI9W	1		
		3ØY347/600V	Black	5h	SCM560MI5W	1		
		480V	Red	7h	SCM560MI7W	1/1		

☼ With power indicating led

- UL listed

- Already supplied with simple single bottom

1

INDUSTRY

2

3

4

# Plugs and sockets for special applications

Plugs and sockets UL/CSA



## ■ ADVANCE-GRP[HD] Series - Interlocked-switch socket outlets >> Surface mounting IP66/67/69 - Type 12K, 3R, 4, 4X - Watertight

### ADVANCE-GRP[PIN&SLEEVE] Series

SCM.



Without fuse carrier -  
With consumer units

Current	Poles	Volt	Colour	h	INTERLOCKED SOCKET		
					IP66/IP67/IP69		
20A	2P 3W	125V		4h	SCM320MI4W-C	1/6	
		250V		6h	SCM320MI6W-C	1/6	
		480V		7h	SCM320MI7W-C	1/6	
	3P 4W	125/250V		12h	SCM420MI12W-C	1/6	
		3Ø250V		9h	SCM420MI9W-C	1/6	
		3Ø480V		7h	SCM420MI7W-C	1/6	
		3Ø600V		5h	SCM420MI5W-C	1/6	
		3ØY120/208V		9h	SCM520MI9W-C	1/6	
		3ØY347/600V		5h	SCM520MI5W-C	1/6	
	4P 5W	480V		7h	SCM520MI7W-C	1/6	
		2P 3W	125V		4h	SCM330MI4W-C	1/6
			250V		6h	SCM330MI6W-C	1/6
480V			7h	SCM330MI7W-C	1/6		
30A	3P 4W	125/250V		12h	SCM430MI12W-C	1/6	
		3Ø250V		9h	SCM430MI9W-C	1/6	
		3Ø480V		7h	SCM430MI7W-C	1/6	
	4P 5W	3Ø600V		5h	SCM430MI5W-C	1/6	
		3ØY120/208V		9h	SCM530MI9W-C	1/6	
		3ØY347/600V		5h	SCM530MI5W-C	1/6	
32A	3P 4W	480V		7h	SCM530MI7W-C	1/6	
		380V 50Hz / 440V 60Hz		3h	SCM432MI3W-C	1/6	
		250V		6h	SCM360MI6W-C	1	
60A	2P 3W	480V		7h	SCM360MI7W-C	1	
		3Ø250V		9h	SCM460MI9W-C	1	
		3Ø480V		7h	SCM460MI7W-C	1	
	3P 4W	3Ø600V		5h	SCM460MI5W-C	1	
		3ØY120/208V		9h	SCM560MI9W-C	1	
		3ØY347/600V		5h	SCM560MI5W-C	1	
		480V		7h	SCM560MI7W-C	1	

☼ With power indicating led

- UL listed

- Already supplied with single bottom with control unit for installation of protective switches or other devices from DIN guide



**NORTH AMERICAN RATINGS**

Products certified by UL laboratories according to standards UL1682 and UL1686

1.4



## Plugs and sockets for special applications

### Seven poles plugs and sockets

#### ■ OPTIMA-SEVEN Series - IP44 versions

##### OPTIMA-SEVEN Series

213.

240.



Plugs

Surface mounting  
appliance inlets

PLUG

APPLIANCE INLET

IP44

M25X1,5

Current	Poles	Hz	Volt	Colour	h				
16A	6P+E	50Hz 60Hz	380-415V	Red	6h	<b>213.1637-7</b>	10	<b>240.1697-7</b> <sup>1</sup> <sub>2</sub>	10
32A						<b>213.3237-7</b>	10	<b>240.3297-7</b> <sup>1</sup> <sub>2</sub>	10

<sup>1</sup> Open threaded cable entry

<sup>2</sup> Threaded cap/cable sleeve included

- Screw terminals

#### ■ OPTIMA-SEVEN Series - IP66/IP67 versions

##### OPTIMA-SEVEN Series

218.

245.



Plugs

Surface mounting  
appliance inlets

PLUG

APPLIANCE INLET

IP66/IP67

M25X1,5

Current	Poles	Hz	Volt	Colour	h				
16A	6P+E	50Hz 60Hz	380-415V	Red	6h	<b>218.1637-7</b>	10	<b>245.1697-7</b> <sup>1</sup> <sub>2</sub>	5
32A						<b>218.3237-7</b>	10	<b>245.3297-7</b> <sup>1</sup> <sub>2</sub>	5

<sup>1</sup> Open threaded cable entry

<sup>2</sup> Threaded cap/cable sleeve included

- Screw terminals

1

INDUSTRY

2

3





4

# Plugs and sockets for special applications





## Seven poles plugs and sockets



### OPTIMA-SEVEN Series

243.	313.	413.	512.
			
<b>Flush mounting appliance inlets</b>	<b>Connectors</b>	<b>Flush mounting socket outlets</b>	<b>Surface mounting socket outlets</b>
APPLIANCE INLET	CONNECTOR	FLUSH-MOUNTING SOCKET	SURFACE MOUNTING SOCKET
75x75mm	IP44	75x75mm	
	M25X1,5		M25X1,5
<b>243.1697-7</b> 10	<b>313.1647-7</b> 10	<b>413.1667-7</b> 10	<b>512.1657-7</b> 1 2 10
<b>243.3297-7</b> 10	<b>313.3247-7</b> 10	<b>413.3267-7</b> 10	<b>512.3257-7</b> 1 2 10

### OPTIMA-SEVEN Series

248.	318.	418.	517.
			
<b>Flush mounting appliance inlets</b>	<b>Connectors</b>	<b>Flush mounting socket outlets</b>	<b>Surface mounting socket outlets</b>
APPLIANCE INLET	CONNECTOR	FLUSH-MOUNTING SOCKET	SURFACE MOUNTING SOCKET
75x75mm	IP66/IP67	75x75mm	
	M25X1,5		M25X1,5
<b>248.1697-7</b> 10	<b>318.1647-7</b> 10	<b>418.1667-7</b> 10	<b>517.1657-7</b> 1 2 5
<b>248.3297-7</b> 10	<b>318.3247-7</b> 10	<b>418.3267-7</b> 10	<b>517.3257-7</b> 1 2 5

1.4



## Plugs and sockets for special applications

### OPTIMA-METAL Series - Industrial connectors

■ ALUMINIUM versions [lever closing] >> HDAL250 Type - Max 250A - Up to 1.000V

OPTIMA-METAL Series

899.



Socket

IP	Current	Poles	Volt	Cable section	SOCKET	
IP67	250A	3P+E	1000V	50-70 mm <sup>2</sup>	<b>899.AL2DE350V</b> <sup>[1]</sup>	1
				70 mm <sup>2</sup>	<b>899.AL2DE370</b> <sup>[2]</sup>	1
				95 mm <sup>2</sup>	<b>899.AL2DE395</b> <sup>[2]</sup>	1
		3P+N+E		50-70 mm <sup>2</sup>	<b>899.AL2DE450V</b> <sup>[1]</sup>	1
				70 mm <sup>2</sup>	<b>899.AL2DE470</b> <sup>[2]</sup>	1

[1] Screw terminals

[2] Crimp terminals

OPTIMA-METAL Series

899.



Angled plug 60°

IP	Current	Poles	Volt	Cable section	PLUG	
IP67	250A	3P+E	1000V	50-70 mm <sup>2</sup>	<b>899.AL2PR350V</b> <sup>[1]</sup>	1
				70 mm <sup>2</sup>	<b>899.AL2PR370</b> <sup>[2]</sup>	1
				95 mm <sup>2</sup>	<b>899.AL2PR395</b> <sup>[2]</sup>	1
		3P+N+E		50-70 mm <sup>2</sup>	<b>899.AL2PR450V</b> <sup>[1]</sup>	1
				70 mm <sup>2</sup>	<b>899.AL2PR470</b> <sup>[2]</sup>	1

[1] Screw terminals

[2] Crimp terminals

1

INDUSTRY

2

3

4



# Plugs and sockets for special applications

## OPTIMA-METAL Series - Industrial connectors



■ ALUMINIUM versions [lever closing] >> HDAL250 Type - Max 250A - Up to 1.000V

OPTIMA-METAL Series

899.



Connector

IP	Current	Poles	Volt	Cable section	CONNECTOR	
					Model	Terminals
IP67	250A	3P+E	1000V	50-70 mm <sup>2</sup>	899.AL2CE350VS <sup>[1]</sup>	1
				70 mm <sup>2</sup>	899.AL2CE370S <sup>[2]</sup>	1
				95 mm <sup>2</sup>	899.AL2CE395S <sup>[2]</sup>	1
		3P+N+E		50-70 mm <sup>2</sup>	899.AL2CE450VS <sup>[1]</sup>	1
				70 mm <sup>2</sup>	899.AL2CE470S <sup>[2]</sup>	1

[1] Screw terminals

[2] Crimp terminals



APPLICATION EXAMPLE

1.4



# Plugs and sockets for special applications

## OPTIMA-METAL Series - Industrial connectors

■ ALUMINIUM versions [lever closing] >> HDAL500 Type - Max 570A - Up to 1.000V

### OPTIMA-METAL Series

899.



Socket

IP	Current	Poles	Volt	Cable section	SOCKET	
IP67	320A	3P+E	1000V	95 mm <sup>2</sup>	<b>899.AL5DE395</b>	1
		3P+N+E		120 mm <sup>2</sup>	<b>899.AL5DE412</b>	1
	150 mm <sup>2</sup>			<b>899.AL5DE415</b>	1	
	95 mm <sup>2</sup>			<b>899.AL5DE495</b>	1	
	370A	3P+E		120 mm <sup>2</sup>	<b>899.AL5DE312</b>	1
				150 mm <sup>2</sup>	<b>899.AL5DE315</b>	1
	420A	3P+N+E		185 mm <sup>2</sup>	<b>899.AL5DE318</b>	1
				150 mm <sup>2</sup>	<b>899.AL5DE415-16</b>	1
	500A	3P+N+E		185 mm <sup>2</sup>	<b>899.AL5DE418-16</b>	1
	570A	3P+E		240 mm <sup>2</sup>	<b>899.AL5DE324-18</b>	1

- Crimp terminals

### OPTIMA-METAL Series

899.



Angled plug 60°

IP	Current	Poles	Volt	Cable section	PLUG	
IP67	320A	3P+E	1000V	95 mm <sup>2</sup>	<b>899.AL5PR395</b>	1
		3P+N+E		120 mm <sup>2</sup>	<b>899.AL5PR412</b>	1
	150 mm <sup>2</sup>			<b>899.AL5PR415</b>	1	
	95 mm <sup>2</sup>			<b>899.AL5PR495</b>	1	
	370A	3P+E		120 mm <sup>2</sup>	<b>899.AL5PR312</b>	1
				150 mm <sup>2</sup>	<b>899.AL5PR315</b>	1
	420A	3P+N+E		185 mm <sup>2</sup>	<b>899.AL5PR318</b>	1
				150 mm <sup>2</sup>	<b>899.AL5PR415-16</b>	1
	500A	3P+N+E		185 mm <sup>2</sup>	<b>899.AL5PR418-16</b>	1
	570A	3P+E		240 mm <sup>2</sup>	<b>899.AL5PR324-18</b>	1

- Crimp terminals

1

INDUSTRY

2

3

4



# Plugs and sockets for special applications

## OPTIMA-METAL Series - Industrial connectors



### ALUMINIUM versions [lever closing] >> HDAL500 Type - Max 570A - Up to 1.000V

#### OPTIMA-METAL Series

899.



Straight plug

IP	Current	Poles	Volt	Cable section	PLUG	
					Model	Quantity
IP67	320A	3P+E	1000V	95 mm <sup>2</sup>	899.AL5PR395S	1
		3P+N+E		120 mm <sup>2</sup>	899.AL5PR412S	1
				150 mm <sup>2</sup>	899.AL5PR415S	1
		370A		3P+E	95 mm <sup>2</sup>	899.AL5PR495S
	120 mm <sup>2</sup>				899.AL5PR312S	1
	420A	3P+E		150 mm <sup>2</sup>	899.AL5PR315S	1
				185 mm <sup>2</sup>	899.AL5PR318S	1
	500A	3P+N+E		150 mm <sup>2</sup>	899.AL5PR415S-16	1
				185 mm <sup>2</sup>	899.AL5PR418S-16	1
	570A	3P+E		240 mm <sup>2</sup>	899.AL5PR324S-18	1

- Crimp terminals

#### OPTIMA-METAL Series

899.



Connector

IP	Current	Poles	Volt	Cable section	CONNECTOR	
					Model	Quantity
IP67	320A	3P+E	1000V	95 mm <sup>2</sup>	899.AL5CE395S	1
		3P+N+E		120 mm <sup>2</sup>	899.AL5CE412S	1
				150 mm <sup>2</sup>	899.AL5CE415S	1
		370A		3P+E	95 mm <sup>2</sup>	899.AL5CE495S
	120 mm <sup>2</sup>				899.AL5CE312S	1
	420A	3P+E		150 mm <sup>2</sup>	899.AL5CE315S	1
				185 mm <sup>2</sup>	899.AL5CE318S	1
	500A	3P+N+E		150 mm <sup>2</sup>	899.AL5CE415S-16	1
				185 mm <sup>2</sup>	899.AL5CE418S-16	1
	570A	3P+E		240 mm <sup>2</sup>	899.AL5CE324S-18	1

- Crimp terminals

1.4



## Plugs and sockets for special applications

### OPTIMA-METAL Series - Industrial connectors

■ ALUMINIUM versions [lever closing] >> HDAL800 Type - Max 800A - Up to 1.000V

OPTIMA-METAL Series

899.



Socket

IP	Current	Poles	Volt	Cable section	SOCKET	
IP67	570A	3P+E	1000V	240 mm <sup>2</sup>	<b>899.AL8DF324</b>	1
		3P+N+E			<b>899.AL8DF424</b>	1
	800A	3P+E		300 mm <sup>2</sup>	<b>899.AL8DF330</b>	1
		3P+N+E			<b>899.AL8DF430</b>	1

- Crimp terminals

OPTIMA-METAL Series

899.



Straight plug

IP	Current	Poles	Volt	Cable section	PLUG	
IP67	570A	3P+E	1000V	240 mm <sup>2</sup>	<b>899.AL8PM324S</b>	1
		3P+N+E			<b>899.AL8PM424S</b>	1
	800A	3P+E		300 mm <sup>2</sup>	<b>899.AL8PM330S</b>	1
		3P+N+E			<b>899.AL8PM430S</b>	1

- Crimp terminals

1  
INDUSTRY

2

3

4

# Plugs and sockets for special applications

## OPTIMA-METAL Series - Industrial connectors



### ALUMINIUM versions [lever closing] >> HDAL800 Type - Max 800A - Up to 1.000V

OPTIMA-METAL Series

899.



Connector

IP	Current	Poles	Volt	Cable section	CONNECTOR	
IP67	570A	3P+E	1000V	240 mm <sup>2</sup>	<b>899.AL8CF324S</b>	1
		3P+N+E			<b>899.AL8CF424S</b>	1
	800A	3P+E		<b>899.AL8CF330S</b>	1	
		3P+N+E		<b>899.AL8CF430S</b>	1	

- Crimp terminals

### ALUMINIUM versions [lever closing]

OPTIMA-METAL Series

899.



Description	Notes	IP	Accessories	
PLUG CAP	HDAL250	IP67	<b>899.AL2PC</b>	1
	HDAL500		<b>899.AL5PC</b>	1
	HDAL800		<b>899.AL8PC</b>	1

1.4



## Plugs and sockets for special applications

### OPTIMA-METAL Series - Industrial connectors

■ ALUMINIUM versions [screw closing] >> HDAS250 Type - Max 250A - Up to 1.000V

OPTIMA-METAL Series

899.



Socket

IP	Current	Poles	Volt	Cable section	SOCKET	
IP67	250A	3P+E	1000V	50-70 mm <sup>2</sup>	<b>899.AS2DE350V</b> <sup>[1]</sup>	1
				70 mm <sup>2</sup>	<b>899.AS2DE370</b> <sup>[2]</sup>	1
				95 mm <sup>2</sup>	<b>899.AS2DE395</b> <sup>[2]</sup>	1
		3P+N+E		50-70 mm <sup>2</sup>	<b>899.AS2DE450V</b> <sup>[1]</sup>	1
				70 mm <sup>2</sup>	<b>899.AS2DE470</b> <sup>[2]</sup>	1

[1] Screw terminals

[2] Crimp terminals

OPTIMA-METAL Series

899.



Straight plug

IP	Current	Poles	Volt	Cable section	PLUG	
IP67	250A	3P+E	1000V	50-70 mm <sup>2</sup>	<b>899.AS2PR350V</b> <sup>[1]</sup>	1
				70 mm <sup>2</sup>	<b>899.AS2PR370</b> <sup>[2]</sup>	1
				95 mm <sup>2</sup>	<b>899.AS2PR395</b> <sup>[2]</sup>	1
		3P+N+E		50-70 mm <sup>2</sup>	<b>899.AS2PR450V</b> <sup>[1]</sup>	1
				70 mm <sup>2</sup>	<b>899.AS2PR470</b> <sup>[2]</sup>	1

[1] Screw terminals

[2] Crimp terminals

1  
INDUSTRY

2

3

4

# Plugs and sockets for special applications

## OPTIMA-METAL Series - Industrial connectors



### ALUMINIUM versions [screw closing] >> HDAS250 Type - Max 250A - Up to 1.000V

#### OPTIMA-METAL Series

899.



Appliance inlet

IP	Current	Poles	Volt	Cable section	APPLIANCE INLET	
IP67	250A	3P+E	1000V	50-70 mm <sup>2</sup>	<b>899.AS2AR350V</b> <sup>1</sup>	1
				70 mm <sup>2</sup>	<b>899.AS2AR370</b> <sup>2</sup>	1
				95 mm <sup>2</sup>	<b>899.AS2AR395</b> <sup>2</sup>	1
		3P+N+E		50-70 mm <sup>2</sup>	<b>899.AS2AR450V</b> <sup>1</sup>	1
				70 mm <sup>2</sup>	<b>899.AS2AR470</b> <sup>2</sup>	1

<sup>1</sup> Screw terminals

<sup>2</sup> Crimp terminals

#### OPTIMA-METAL Series

899.



Connector

IP	Current	Poles	Volt	Cable section	CONNECTOR	
IP67	250A	3P+E	1000V	50-70 mm <sup>2</sup>	<b>899.AS2CE350V</b> <sup>1</sup>	1
				70 mm <sup>2</sup>	<b>899.AS2CE370</b> <sup>2</sup>	1
				95 mm <sup>2</sup>	<b>899.AS2CE395</b> <sup>2</sup>	1
		3P+N+E		50-70 mm <sup>2</sup>	<b>899.AS2CE450V</b> <sup>1</sup>	1
				70 mm <sup>2</sup>	<b>899.AS2CE470</b> <sup>2</sup>	1

<sup>1</sup> Screw terminals

<sup>2</sup> Crimp terminals

1.4



# Plugs and sockets for special applications

## OPTIMA-METAL Series - Industrial connectors

■ ALUMINIUM versions [screw closing] >> HDAS500 Type - Max 570A - Up to 1.000V

### OPTIMA-METAL Series

899.



Socket

IP	Current	Poles	Volt	Cable section	SOCKET	
					Part Number	Quantity
IP67	320A	3P+E	1000V	95 mm <sup>2</sup>	<b>899.AS5DE395</b>	1
		3P+N+E		120 mm <sup>2</sup>	<b>899.AS5DE412</b>	1
	150 mm <sup>2</sup>			<b>899.AS5DE415</b>	1	
	95 mm <sup>2</sup>			<b>899.AS5DE495</b>	1	
	370A	3P+E		120 mm <sup>2</sup>	<b>899.AS5DE312</b>	1
				150 mm <sup>2</sup>	<b>899.AS5DE315</b>	1
	420A	3P+N+E		185 mm <sup>2</sup>	<b>899.AS5DE318</b>	1
				150 mm <sup>2</sup>	<b>899.AS5DE415-16</b>	1
	500A	3P+N+E		185 mm <sup>2</sup>	<b>899.AS5DE418-16</b>	1
	570A	3P+E		240 mm <sup>2</sup>	<b>899.AS5DE324-18</b>	1

- Crimp terminals

### OPTIMA-METAL Series

899.



Straight plug

IP	Current	Poles	Volt	Cable section	PLUG	
					Part Number	Quantity
IP67	320A	3P+E	1000V	95 mm <sup>2</sup>	<b>899.AS5PR395</b>	1
		3P+N+E		120 mm <sup>2</sup>	<b>899.AS5PR412</b>	1
	150 mm <sup>2</sup>			<b>899.AS5PR415</b>	1	
	95 mm <sup>2</sup>			<b>899.AS5PR495</b>	1	
	370A	3P+E		120 mm <sup>2</sup>	<b>899.AS5PR312</b>	1
				150 mm <sup>2</sup>	<b>899.AS5PR315</b>	1
	420A	3P+N+E		185 mm <sup>2</sup>	<b>899.AS5PR318</b>	1
				150 mm <sup>2</sup>	<b>899.AS5PR415-16</b>	1
	500A	3P+N+E		185 mm <sup>2</sup>	<b>899.AS5PR418-16</b>	1
	570A	3P+E		240 mm <sup>2</sup>	<b>899.AS5PR324-18</b>	1

- Crimp terminals

1

INDUSTRY

2

3

4

# Plugs and sockets for special applications

## OPTIMA-METAL Series - Industrial connectors



### ALUMINIUM versions [screw closing] >> HDAS500 Type - Max 570A - Up to 1.000V

#### OPTIMA-METAL Series

899.



Appliance inlet

IP	Current	Poles	Volt	Cable section	APPLIANCE INLET	
					Model	Quantity
IP67	320A	3P+E	1000V	95 mm <sup>2</sup>	<b>899.AS5AR395</b>	1
		3P+N+E		120 mm <sup>2</sup>	<b>899.AS5AR412</b>	1
				150 mm <sup>2</sup>	<b>899.AS5AR415</b>	1
		370A		3P+E	95 mm <sup>2</sup>	<b>899.AS5AR495</b>
	120 mm <sup>2</sup>				<b>899.AS5AR312</b>	1
	420A	3P+E		150 mm <sup>2</sup>	<b>899.AS5AR315</b>	1
				185 mm <sup>2</sup>	<b>899.AS5AR318</b>	1
	500A	3P+N+E		150 mm <sup>2</sup>	<b>899.AS5AR415-16</b>	1
				185 mm <sup>2</sup>	<b>899.AS5AR418-16</b>	1
	570A	3P+E		240 mm <sup>2</sup>	<b>899.AS5AR324-18</b>	1

- Crimp terminals

#### OPTIMA-METAL Series

899.



Connector

IP	Current	Poles	Volt	Cable section	CONNECTOR	
					Model	Quantity
IP67	320A	3P+E	1000V	95 mm <sup>2</sup>	<b>899.AS5CE395</b>	1
		3P+N+E		120 mm <sup>2</sup>	<b>899.AS5CE412</b>	1
				150 mm <sup>2</sup>	<b>899.AS5CE415</b>	1
		370A		3P+E	95 mm <sup>2</sup>	<b>899.AS5CE495</b>
	120 mm <sup>2</sup>				<b>899.AS5CE312</b>	1
	420A	3P+E		150 mm <sup>2</sup>	<b>899.AS5CE315</b>	1
				185 mm <sup>2</sup>	<b>899.AS5CE318</b>	1
	500A	3P+N+E		150 mm <sup>2</sup>	<b>899.AS5CE415-16</b>	1
				185 mm <sup>2</sup>	<b>899.AS5CE418-16</b>	1
	570A	3P+E		240 mm <sup>2</sup>	<b>899.AS5CE324-18</b>	1

- Crimp terminals

1.4



# Plugs and sockets for special applications

## OPTIMA-METAL Series - Industrial connectors

■ ALUMINIUM versions [screw closing] >> HDAS800 Type - Max 800A - Up to 1.000V

OPTIMA-METAL Series

899.



Socket

IP	Current	Poles	Volt	Cable section	SOCKET	
IP67	570A	3P+E	1000V	240 mm <sup>2</sup>	<b>899.AS8DF324</b>	1
		3P+N+E			<b>899.AS8DF424</b>	1
	800A	3P+E		<b>899.AS8DF330</b>	1	
		3P+N+E		<b>899.AS8DF430</b>	1	

- Crimp terminals

OPTIMA-METAL Series

899.



Straight plug

IP	Current	Poles	Volt	Cable section	PLUG	
IP67	570A	3P+E	1000V	240 mm <sup>2</sup>	<b>899.AS8PM324</b>	1
		3P+N+E			<b>899.AS8PM424</b>	1
	800A	3P+E		<b>899.AS8PM330</b>	1	
		3P+N+E		<b>899.AS8PM430</b>	1	

- Crimp terminals

1

INDUSTRY

2

3

4



# Plugs and sockets for special applications

## OPTIMA-METAL Series - Industrial connectors



### ALUMINIUM versions [screw closing] >> HDAS800 Type - Max 800A - Up to 1.000V

OPTIMA-METAL Series

899.



Appliance inlet

IP	Current	Poles	Volt	Cable section	APPLIANCE INLET	
IP67	570A	3P+E	1000V	240 mm <sup>2</sup>	<b>899.AS8AM324</b>	1
		3P+N+E			<b>899.AS8AM424</b>	1
	800A	3P+E		300 mm <sup>2</sup>	<b>899.AS8AM330</b>	1
		3P+N+E			<b>899.AS8AM430</b>	1

- Crimp terminals

OPTIMA-METAL Series

899.



Connector

IP	Current	Poles	Volt	Cable section	CONNECTOR	
IP67	570A	3P+E	1000V	240 mm <sup>2</sup>	<b>899.AS8CF324</b>	1
		3P+N+E			<b>899.AS8CF424</b>	1
	800A	3P+E		300 mm <sup>2</sup>	<b>899.AS8CF330</b>	1
		3P+N+E			<b>899.AS8CF430</b>	1

- Crimp terminals

1.4



# Plugs and sockets for special applications

## OPTIMA-METAL Series - Industrial connectors

■ ALUMINIUM versions [screw closing]

OPTIMA-METAL Series

899.



1

INDUSTRY

Description	Notes	IP	Accessories
CAP	HDAS250	IP67	<b>899.AS2PC</b> 1
	HDAS500		<b>899.AS5PC</b> 1
	HDAS800		<b>899.AS8PC</b> 1

2

3

4

# Plugs and sockets for special applications

## OPTIMA-METAL Series - Industrial connectors



### SWITCHED INTERLOCKED SOCKETS versions [lever closing] >> HDIN250 Type - 250A

OPTIMA-METAL Series

899.



	With switch-disconnector	With switch-disconnector and fuse	With MCCB	With MCCB & RCD
INTERLOCKED SOCKET				
IP67				
250A				
<b>Poles Volt</b>				
3P+E	440V			<b>899.IN25086RM</b> <sup>[2]</sup>
	690V	<b>899.IN25086</b>	<b>899.IN25086F</b>	<b>899.IN25086M</b> <sup>[1]</sup>
3P+N+E	440V			<b>899.IN25087RM</b> <sup>[2]</sup>
	690V	<b>899.IN25087</b>	<b>899.IN25087F</b>	<b>899.IN25087M</b> <sup>[1]</sup>

<sup>[1]</sup> MCCB = Molded case circuit breaker with thermal magnetic trip unit

<sup>[2]</sup> MCCB & RCD = Molded case circuit breaker with thermal magnetic and residual current release trip unit

- To be mated with HDAL250 plugs



OPTIMA-METAL Series  
Application example

1.4



## Plugs and sockets for special applications

### OPTIMA-METAL Series - Industrial connectors

#### ALUMINIUM versions [disconnectors] >> HSD200 Type - 200A/250A

OPTIMA-METAL Series

899.

1  
INDUSTRY



Appliance inlet

Socket

Plug

APPLIANCE INLET

SOCKET

PLUG

Current	Poles	Volt	h	APPLIANCE INLET		SOCKET		PLUG	
200A	3P+N+E	380-440V				IP67			
		220-250V	6h	<b>899.SD2A30E03</b>	1	<b>899.SD2D30E03</b>	1	<b>899.SD2P30E01</b> <sup>1</sup>	1
250A	3P+E			<b>899.SD2A30E01</b>	1	<b>899.SD2D30E01</b>	1	<b>899.SD2P30E01</b> <sup>1</sup>	1
	3P+N+E	380-440V		<b>899.SD2A3NE01</b>	1	<b>899.SD2D3NE01</b>	1	<b>899.SD2P30E01</b> <sup>1</sup>	1

- <sup>1</sup> Rubber handle
- Screw terminals

#### ALUMINIUM versions [disconnectors]

OPTIMA-METAL Series

899.



Description

IP

Accessories: handles

RUBBER HANDLES		<b>899.SD2G</b>	1		
ALUMINUM HANDLES	IP67			<b>899.SD2GM</b>	1
ANGLED ALUMINUM HANDLES				<b>899.SD2GMA</b>	1

# Plugs and sockets for special applications

## OPTIMA-METAL Series - Industrial connectors



### ALUMINIUM versions [disconnectors]

OPTIMA-METAL Series

899.



Description	IP	Accessories: box and plug cap	
FLUSH MOUNTING BOX		<b>899.SD2LB</b> <sup>1</sup>	1
SURFACE MOUNTING BOX	IP67		<b>899.SD2WAS</b> <sup>1</sup> 1
PLUG CAP		<b>899.SD2PC</b>	1

<sup>1</sup> For fixed plugs and sockets

1.4



1.5

## Switchgears

- **COMMAND Series**  
Low-voltage rotary switchgear and controlgear
- **ISOLATORS Series**  
Switch-disconnectors IP65
- **TOP22 Series**  
Control and signalling accessories





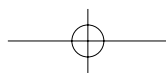
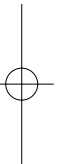
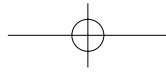

# Switchgears

## COMMAND Series

### Switch disconnectors

#### COMMAND Series

590.



#### Base mounting [16A-40A]

Version	Current	Poles	Switch size	SWITCH DISCONNECTOR	
BOX (B)	16A	2P	Y1	<b>590.YA162B</b> <sup>1</sup>	6
		3P		<b>590.YA163B</b> <sup>1</sup>	6
		4P		<b>590.YA164B</b> <sup>1</sup>	6
		3P+N		<b>590.YA165B</b> <sup>2 1</sup>	6
	20A	6P	Y3	<b>590.YA166B</b> <sup>3 4</sup>	6
		8P		<b>590.YA168B</b> <sup>3 2 4</sup>	6
	25A	2P	Y1	<b>590.YA202B</b> <sup>1</sup>	6
		3P		<b>590.YA203B</b> <sup>1</sup>	6
		4P		<b>590.YA204B</b> <sup>1</sup>	6
		3P+N		<b>590.YA205B</b> <sup>2 1</sup>	6
	32A	6P	Y3	<b>590.YA256B</b> <sup>3 4</sup>	6
		8P		<b>590.YA258B</b> <sup>3 2 4</sup>	6
	40A	2P	Y1	<b>590.YA322B</b> <sup>1</sup>	6
		3P		<b>590.YA323B</b> <sup>1</sup>	6
		4P		<b>590.YA324B</b> <sup>1</sup>	6
		3P+N		<b>590.YA325B</b> <sup>2 1</sup>	6
40A	6P	Y3	<b>590.YA326B</b> <sup>3 4</sup>	6	
	8P		<b>590.YA328B</b> <sup>3 2 4</sup>	6	
	40A	2P	Y1	<b>590.YA402B</b> <sup>1</sup>	6
		3P		<b>590.YA403B</b> <sup>1</sup>	6
4P		<b>590.YA404B</b> <sup>1</sup>		6	
3P+N		<b>590.YA405B</b> <sup>2 1</sup>		6	
40A	6P	Y3	<b>590.YA406B</b> <sup>3 4</sup>	6	
	8P		<b>590.YA408B</b> <sup>3 2 4</sup>	6	

<sup>1</sup> DIN rail fixing

<sup>2</sup> With late break and early make neutral pole

<sup>3</sup> Equipped with direct handle

<sup>4</sup> DIN rail / screw fixing

- BOX (B) = Base mounting

1

INDUSTRY

2

3

4



■ Switch disconnectors

COMMAND Series

590.



Base mounting  
[63A-160A]

Version	Current	Poles	Switch size	SWITCH DISCONNECTOR	
63A	3P+N	2P	Y2	590.YA632B <sup>[4]</sup>	6
		3P		590.YA633B <sup>[4]</sup>	6
		4P		590.YA634B <sup>[4]</sup>	6
		3P+N		590.YA635B <sup>[3][4]</sup>	6
	6P	Y4	590.YA636B <sup>[1][2]</sup>	6	
			590.YA638B <sup>[1][3][2]</sup>	6	
80A	3P+N	2P	Y2	590.YA802B <sup>[4]</sup>	6
		3P		590.YA803B <sup>[4]</sup>	6
		4P		590.YA804B <sup>[4]</sup>	6
		3P+N		590.YA805B <sup>[3][4]</sup>	6
	6P	Y4	590.YA806B <sup>[1][2]</sup>	6	
			590.YA808B <sup>[1][3][2]</sup>	6	
100A	3P+N	3P	Y4	590.YA1003B <sup>[1][2]</sup>	6
		4P		590.YA1004B <sup>[1][2]</sup>	6
		3P+N		590.YA1005B <sup>[1][3][2]</sup>	6
		6P		590.YA1006B <sup>[1][2]</sup>	6
	8P	Y4	590.YA1008B <sup>[1][3][2]</sup>	6	
125A	3P+N	3P	Y5	590.YA1253B <sup>[1][2]</sup>	6
		3P+N		590.YA1255B <sup>[1][3][2]</sup>	6
		6P		590.YA1256B <sup>[1][2]</sup>	6
		8P		590.YA1258B <sup>[1][3][2]</sup>	6
160A	3P+N	3P	Y5	590.YA1603B <sup>[1][2]</sup>	5
		3P+N		590.YA1605B <sup>[1][3][2]</sup>	5
		6P		590.YA1606B <sup>[1][2]</sup>	6
		8P		590.YA1608B <sup>[1][3][2]</sup>	6

- <sup>[1]</sup> Equipped with direct handle
- <sup>[2]</sup> DIN rail / screw fixing
- <sup>[3]</sup> With late break and early make neutral pole
- <sup>[4]</sup> DIN rail fixing
- BOX (B) = Base mounting

1.5



# Switchgears COMMAND Series

## Switch disconnectors

COMMAND Series

590.



Panel mounting

Version	Current	Poles	Switch size	SWITCH DISCONNECTOR		
REAR (R)	16A	2P	Y1	<b>590.YA162R</b>	6	
		3P		<b>590.YA163R</b>	6	
		4P		<b>590.YA164R</b>	6	
		3P+N		<b>590.YA165R<sup>[1]</sup></b>	6	
	32A	2P		<b>590.YA322R</b>	6	
		3P		<b>590.YA323R</b>	6	
		4P		<b>590.YA324R</b>	6	
		3P+N		<b>590.YA325R<sup>[1]</sup></b>	6	
	40A	2P		<b>590.YA402R</b>	6	
		3P		<b>590.YA403R</b>	6	
		4P		<b>590.YA404R</b>	6	
		3P+N		<b>590.YA405R<sup>[1]</sup></b>	6	
	63A	2P		Y2	<b>590.YA632R</b>	6
		3P			<b>590.YA633R</b>	6
		4P			<b>590.YA634R</b>	6
		3P+N			<b>590.YA635R<sup>[1]</sup></b>	6
80A	2P	<b>590.YA802R</b>	6			
	3P	<b>590.YA803R</b>	6			
	4P	<b>590.YA804R</b>	6			
	3P+N	<b>590.YA805R<sup>[1]</sup></b>	6			
100A	3P	<b>590.YA1003R</b>	6			
	4P	<b>590.YA1004R</b>	6			

<sup>[1]</sup> With late break and early make neutral pole

- REAR (R) = Panel mounting

1

INDUSTRY

2

3

4

■ Switch disconnectors

COMMAND Series

590.



Base mounting  
[160A-1600A]

Version	Current	Poles	Switch size	SWITCH DISCONNECTOR	
BOX (B)	160A	3P	K1	<b>590.K16003B</b>	1
		3P+N		<b>590.K16005B</b> <sup>1</sup>	1
	200A	3P	K2	<b>590.K20003B</b>	1
		3P+N		<b>590.K20005B</b> <sup>1</sup>	1
	250A	3P	K2	<b>590.K25003B</b>	1
		3P+N		<b>590.K25005B</b> <sup>1</sup>	1
	315A	3P	K2	<b>590.K31503B</b>	1
		3P+N		<b>590.K31505B</b> <sup>1</sup>	1
	400A	3P	K3	<b>590.K40003B</b>	1
		3P+N		<b>590.K40005B</b> <sup>1</sup>	1
	500A	3P	K3	<b>590.K50003B</b>	1
		3P+N		<b>590.K50005B</b> <sup>1</sup>	1
	630A	3P	K4	<b>590.K63003B</b>	1
		3P+N		<b>590.K63005B</b> <sup>1</sup>	1
	800A	3P	K4	<b>590.K80003B</b>	1
		3P+N		<b>590.K80005B</b> <sup>1</sup>	1
	1000A	3P	K5	<b>590.K100003B</b>	1
		3P+N		<b>590.K100005B</b> <sup>1</sup>	1
	1250A	3P	K5	<b>590.K125003B</b>	1
		3P+N		<b>590.K125005B</b> <sup>1</sup>	1
	1600A	3P	K6	<b>590.K160003B</b>	1
		3P+N		<b>590.K160005B</b> <sup>1</sup>	1

- <sup>1</sup> With late break and early make neutral pole
- Handle padlockable in OFF only (3 padlocks)
  - Door interlock handle and 200mm shaft included
  - BOX (B) = Base mounting
  - Screw fixing

1.5



# Switchgears

## COMMAND Series

### Switch disconnectors [DC - Direct Current]

COMMAND Series

590.



Base mounting - Direct current (DC)

Version	Current	Poles in series	Switch size	SWITCH DISCONNECTOR	
BOX (B)	15A	4	D1	<b>590.DC0815</b> <sup>[2]</sup>	6
	16A		Y1	<b>590.DC0416</b> <sup>[1]</sup>	6
	20A	5		<b>590.DC0820</b> <sup>[2]</sup>	6
	25A	6	D3	<b>590.DC0825</b> <sup>[2]</sup>	6
	30A	8		<b>590.DC0830</b> <sup>[2]</sup>	6
	40A		D5	<b>590.DC0840</b> <sup>[2]</sup>	6

<sup>[1]</sup> DIN rail fixing

<sup>[2]</sup> DIN rail / screw fixing

- Equipped with direct handle
- Links already wired
- BOX (B) = Base mounting

### Switch disconnectors [FUSES]

COMMAND Series

590.



Base mounting - With fuse carrier [Type gG] 16A - 32A

Version	Current	Poles	Switch size	Fuse type	SWITCH DISCONNECTOR FUSES	
BOX (B)	16A	2P	F1	gG 10,3x38mm	<b>590.YF162B</b>	6
		3P			<b>590.YF163B</b>	6
		4P			<b>590.YF164B</b>	6
	3P+N	<b>590.YF165B</b> <sup>[1]</sup>			6	
	32A	2P			<b>590.YF322B</b>	6
		3P			<b>590.YF323B</b>	6
4P		<b>590.YF324B</b>	6			
		3P+N	<b>590.YF325B</b> <sup>[1]</sup>	6		

<sup>[1]</sup> With late break and early make neutral pole

- Fuses not supplied
- BOX (B) = Base mounting
- DIN rail fixing

■ **Switch disconnectors [FUSES]**

COMMAND Series

590.



**Base mounting with fuse carrier [Type BS]  
63A - 630A**

Version	Current	Poles	Switch size	Fuse type	SWITCH DISCONNECTOR FUSES	
BOX (B)	63A	3P	KF1	BS	<b>590.KFB6303B</b>	1
		3P+N			<b>590.KFB6305B</b> <sup>1</sup>	1
	80A	3P	KF1		<b>590.KFB8003B</b>	1
		3P+N			<b>590.KFB8005B</b> <sup>1</sup>	1
	100A	3P	KF1		<b>590.KFB10003B</b>	1
		3P+N			<b>590.KFB10005B</b> <sup>1</sup>	1
	125A	3P	KF2		<b>590.KFB12503B</b>	1
		3P+N			<b>590.KFB12505B</b> <sup>1</sup>	1
	160A	3P	KF2		<b>590.KFB16003B</b>	1
		3P+N			<b>590.KFB16005B</b> <sup>1</sup>	1
	200A	3P	KF3		<b>590.KFB20003B</b>	1
		3P+N			<b>590.KFB20005B</b> <sup>1</sup>	1
	250A	3P	KF3		<b>590.KFB25003B</b>	1
		3P+N			<b>590.KFB25005B</b> <sup>1</sup>	1
	315A	3P	KF4		<b>590.KFB31503B</b>	1
		3P+N			<b>590.KFB31505B</b> <sup>1</sup>	1
	400A	3P	KF4		<b>590.KFB40003B</b>	1
		3P+N			<b>590.KFB40005B</b> <sup>1</sup>	1
	630A	3P	KF5		<b>590.KFB63003B</b>	1
		3P+N			<b>590.KFB63005B</b> <sup>1</sup>	1

- <sup>1</sup> With late break and early make neutral pole
- Handle padlockable in OFF only (3 padlocks)
  - Door interlock handle and 200mm shaft included
  - Fuses not supplied
  - BOX (B) = Base mounting
  - Screw fixing

1.5



# Switchgears

## COMMAND Series

### Switch disconnectors [FUSES]

COMMAND Series

590.



Base mounting - With fuse carrier [Type DIN-NH]  
63A - 630A

SWITCH DISCONNECTOR FUSES

Version	Current	Poles	Switch size	Fuse type		
BOX (B)	63A	3P	KF1	DIN-HN	590.KFD6303B	1
		3P+N			590.KFD6305B <sup>[1]</sup>	1
	80A	3P	KF2		590.KFD8003B	1
		3P+N			590.KFD8005B <sup>[1]</sup>	1
	100A	3P	KF3		590.KFD10003B	1
		3P+N			590.KFD10005B <sup>[1]</sup>	1
	125A	3P	KF4		590.KFD12503B	1
		3P+N			590.KFD12505B <sup>[1]</sup>	1
	160A	3P	KF5		590.KFD16003B	1
		3P+N			590.KFD16005B <sup>[1]</sup>	1
	200A	3P	KF1		590.KFD20003B	1
		3P+N			590.KFD20005B <sup>[1]</sup>	1
	250A	3P	KF2		590.KFD25003B	1
		3P+N			590.KFD25005B <sup>[1]</sup>	1
	315A	3P	KF3		590.KFD31503B	1
		3P+N			590.KFD31505B <sup>[1]</sup>	1
	400A	3P	KF4		590.KFD40003B	1
		3P+N			590.KFD40005B <sup>[1]</sup>	1
	630A	3P	KF5		590.KFD63003B	1
		3P+N			590.KFD63005B <sup>[1]</sup>	1

- <sup>[1]</sup> With late break and early make neutral pole
- Handle padlockable in OFF only (3 padlocks)
  - Door interlock handle and 200mm shaft included
  - Fuses not supplied
  - BOX (B) = Base mounting
  - Screw fixing



I-O-II  
Change-Over Switches [I-O-II]

Change-over switches [I-O-II]

COMMAND Series

590.



Base mounting

Version	Current	Poles	Switch size	CHANGE OVER SWITCH		
BOX (B)	16A	3P	C1	<b>590.YA163B-C</b>	6	
		3P+N		<b>590.YA165B-C</b> <sup>[1]</sup>	6	
	25A	3P		<b>590.YA253B-C</b>	6	
		3P+N		<b>590.YA255B-C</b> <sup>[1]</sup>	6	
	32A	3P		C2	<b>590.YA323B-C</b>	6
		3P+N			<b>590.YA325B-C</b> <sup>[1]</sup>	6
	40A	3P	<b>590.YA403B-C</b>		6	
		3P+N	<b>590.YA405B-C</b> <sup>[1]</sup>		6	
	63A	3P	C3		<b>590.YA633B-C</b>	6
		3P+N			<b>590.YA635B-C</b> <sup>[1]</sup>	6
	80A	3P		<b>590.YA803B-C</b>	6	
		3P+N		<b>590.YA805B-C</b> <sup>[1]</sup>	6	
	100A	3P		C3	<b>590.YA1003B-C</b>	6
		3P+N			<b>590.YA1005B-C</b> <sup>[1]</sup>	6
	125A	3P	<b>590.YA1253B-C</b>		6	
		3P+N	<b>590.YA1255B-C</b> <sup>[1]</sup>		6	
	160A	3P	<b>590.YA1603B-C</b>		6	
		3P+N	<b>590.YA1605B-C</b> <sup>[1]</sup>		6	

- <sup>[1]</sup> With late break and early make neutral pole
- Handle padlockable in OFF (1 padlock) position
  - Equipped with direct handle
  - BOX (B) = Base mounting

1.5



# Switchgears COMMAND Series

## Accessories

1  
INDUSTRY

### COMMAND Series



590.



### Front operator handles 48X48mm

#### FRONT OPERATOR

IP65

Switch size	Ø	Dimension	EMERGENCY		GENERAL	
						
F1 Y1	standard	48x48mm	<b>590.YM48B1</b> <sup>[1]</sup>	1/10	<b>590.YM48B2</b> <sup>[1]</sup>	1/10
			<b>590.YM48R1</b> <sup>[2]</sup>	1/10	<b>590.YM48R2</b> <sup>[2]</sup>	1/10
	ø22mm		<b>590.YM50B1</b> <sup>[1]</sup>	10	<b>590.YM50B2</b> <sup>[1]</sup>	10
			<b>590.YM50R1</b> <sup>[2]</sup>	10	<b>590.YM50R2</b> <sup>[2]</sup>	10

[1] For base mounting version with door interlock (B)

[2] For panel mounting version (R)

- Shaft not included (to buy separately)
- For general use and emergency switches.
- Handle not padlockable

### COMMAND Series



590.



### Front operator handles 48X48mm - Padlockable

#### FRONT OPERATOR PADLOCKABLE

IP65

Switch size	Ø	Dimension	EMERGENCY		GENERAL	
						
F1 Y1	standard	48x48mm	<b>590.YM49B1</b> <sup>[1]</sup>	1/10	<b>590.YM49B2</b> <sup>[1]</sup>	1/10
			<b>590.YM49R1</b> <sup>[2]</sup>	1/10	<b>590.YM49R2</b> <sup>[2]</sup>	1/10
	ø22mm		<b>590.YM51B1</b> <sup>[1]</sup>	10	<b>590.YM51B2</b> <sup>[1]</sup>	10
			<b>590.YM51R1</b> <sup>[2]</sup>	10	<b>590.YM51R2</b> <sup>[2]</sup>	10

[1] For base mounting version with door interlock (B)

[2] For panel mounting version (R)

- Shaft not included (to buy separately)
- For general use and emergency switches.
- Handle padlockable in OFF only (3 padlocks)



■ Accessories

COMMAND Series

590.



Front operator handles  
67X67mm

FRONT OPERATOR PADLOCKABLE

IP65

Switch size	Ø	Dimension	EMERGENCY		GENERAL	
F1 Y1	standard	67x67mm	<b>590.YM67B1</b> <sup>1</sup>	1/10	<b>590.YM67B2</b> <sup>1</sup>	1/10
			<b>590.YM67R1</b> <sup>2</sup>	1/10	<b>590.YM67R2</b> <sup>2</sup>	1/10
	ø22mm		<b>590.YM68B1</b> <sup>1</sup>	10	<b>590.YM68B2</b> <sup>1</sup>	10
			<b>590.YM68R1</b> <sup>2</sup>	10	<b>590.YM68R2</b> <sup>2</sup>	10
Y2	standard		<b>590.YM67B6</b> <sup>1</sup>	1/10	<b>590.YM67B7</b> <sup>1</sup>	1/10
			<b>590.YM67R6</b> <sup>2</sup>	1/10	<b>590.YM67R7</b> <sup>2</sup>	1/10
	ø22mm		<b>590.YM68B6</b> <sup>1</sup>	10	<b>590.YM68B7</b> <sup>1</sup>	10

<sup>1</sup> For base mounting version with door interlock (B)

<sup>2</sup> For panel mounting version (R)

- Shaft not included (to buy separately)
- For general use and emergency switches.
- Handle padlockable in OFF only (3 padlocks)

COMMAND Series

590.



Front operator handles  
Ø80mm

FRONT OPERATOR PADLOCKABLE

IP65

Switch size	Ø	Dimension	EMERGENCY		GENERAL	
Y3 Y4 Y5	ø22mm	Ø80mm	<b>590.YM80B1</b>	5	<b>590.YM80B2</b>	5
C1 C2 C3						<b>590.YM80B2-C</b>

- Shaft not included (to buy separately)
- Handle padlockable in OFF only (3 padlocks)
- For base mounting version with door interlock (B)

1.5



# Switchgears COMMAND Series

## Accessories

1

INDUSTRY



### COMMAND Series

590.



Front operator handles  
70x87mm

#### FRONT OPERATOR FOR SWITCHES

Switch size	Dimension	EMERGENCY		GENERAL	
					
Y1	70x87mm	<b>590.YM70R1</b>	10	<b>590.YM70R2</b>	10
Y2		<b>590.YM70R6</b>	10	<b>590.YM70R7</b>	10

- For general use and emergency switches.
- They can only be applied to SCAME enclosure system 70x87mm socket cut out
- Handle padlockable in OFF only (3 padlocks)
- For panel mounting version (R)
- Shaft included

2

3

4

### COMMAND Series

590.



Description	IP	Colour	Switch size	Direct handle
DIRECT HANDLE	IP65		F1 Y1	<b>590.YMC1</b> 10
			Y2	<b>590.YMC2</b> 10

- Shaft included
- For base mounting version (B)

# Switchgears COMMAND Series



## Accessories

COMMAND Series

590.



Description	Switch size	Direct handle kit for DIN rail window
WINDOW FOR DIN RAIL - Shaft included - For base mounting version (B)	Y1	<b>590.YMDIN</b> 10



APPLICATION EXAMPLE

1.5



# Switchgears COMMAND Series

## Accessories

COMMAND Series

590.



1  
INDUSTRY

Description	IP	Version	Switch size	Notes	Front operator handles
FRONT OPERATOR	IP65	EMERGENCY	KF1 KF2 K2		<b>590.KMM100EM</b> 10
			KF3 KF4 K3 K4		<b>590.KMM300EM</b> 10
			KF5 K5	DOUBLE	<b>590.KMM550EM</b> 10
					<b>590.KMM500EM</b> 10
			K6	DOUBLE	<b>590.KMM600EM</b> 10
		GENERAL	KF1 KF2 K2		<b>590.KMM100GE</b> 10
				KF3 KF4 K3 K4	
			KF5 K5	DOUBLE	<b>590.KMM550GE</b> 10
					<b>590.KMM500GE</b> 10
			K6	DOUBLE	<b>590.KMM600GE</b> 10

- Shaft not included (to buy separately)
- Handle padlockable in OFF only (3 padlocks)
- For base mounting version (B)

**Double**  
Door interlock handle: "double" handle



# Switchgears COMMAND Series



## Accessories

COMMAND Series

590.



Description	Switch size	Dimension	Notes	Shaft for front operator handles	
SHAFT	KF1 KF2 K2	200mm		<b>590.KMA200A</b> 10	
		300mm		<b>590.KMA300A</b> 10	
		400mm		<b>590.KMA400A</b> 10	
	KF3 KF4 KF5 K3 K4 K5	200mm		<b>590.KMA200B</b> 10	
		300mm		<b>590.KMA300B</b> 10	
		400mm		<b>590.KMA400B</b> 10	
	F1 Y1	185mm		<b>590.YMA185</b> 10/100	
		300mm	[5x5mm]	<b>590.YMA300</b> 10	
		70mm		<b>590.YMA070</b> 10/100	
	Y2	85mm		<b>590.YMA085</b> 10/100	
		185mm		<b>590.YMB185</b> 10/100	
		300mm	[6x6mm]	<b>590.YMB300</b> 10	
	Y3 Y4 Y5 D1 D3 D5	85mm		<b>590.YMB085</b> 10/100	
		100mm		<b>590.YMA101</b> 10/100	
		200mm	[5x5mm]	<b>590.YMA201</b> 10/100	
			300mm		<b>590.YMA301</b> 10/100

- To buy along with front operator handle
- For base mounting version (B)

COMMAND Series

590.



Description	Switch size	Shaft-hub
SHAFT-HUB REINFORCING RING	Y3 Y4 Y5 C1 C2 C3 D1 D3 D5	<b>590.YMZZ</b> 10/50

- Assembled instead of the handle, it reduces the switch height by 5mm
- To buy along with front operator handle
- For base mounting version (B)

1.5



# Switchgears COMMAND Series

## Accessories

1  
INDUSTRY

### ADVANCE 2 System

576.

### OMNIA System

572.



Single junction box

IP	Notes	Dimension	ENCLOSURE FOR SWITCH	
IP66	ADVANCE2	136x150x105mm	<b>576.4390</b> <sup>[3]</sup>	6
IP67	OMNIA	136x125x85mm	<b>572.3390</b> <sup>[1][2]</sup>	6

<sup>[1]</sup> Blank side with drilling point mark

<sup>[2]</sup> IP67 when assembled together with the relevant component.

<sup>[3]</sup> Metric break-through cable entry

- For fitting with Y1 switch size panel mounting version (R) and relevant front operators handleless (IP65).

### COMMAND Series

590.



Description	Switch size	Suitable for	Terminal protection cover	
TERMINAL PROTECTION COVER	KF1	TOP TERMINALS	<b>590.KMT11</b>	10
		BOTTOM TERMINALS	<b>590.KMT12</b>	10
	KF2 K2	TOP TERMINALS	<b>590.KMT21</b>	10
		BOTTOM TERMINALS	<b>590.KMT22</b>	10
	KF3 K3	TOP TERMINALS	<b>590.KMT31</b>	10
		BOTTOM TERMINALS	<b>590.KMT32</b>	10
	KF4 K4	TOP TERMINALS	<b>590.KMT41</b>	10
		BOTTOM TERMINALS	<b>590.KMT42</b>	10
	KF5 K5	TOP TERMINALS	<b>590.KMT51</b>	10
		BOTTOM TERMINALS	<b>590.KMT52</b>	10

■ Accessories

**COMMAND Series**

590.



Description	Switch size	Protection screen fuses	
PROTECTION SCREEN FUSES	KF1	<b>590.KFS1</b>	1/6
	KF2	<b>590.KFS2</b>	1/6
	KF3	<b>590.KFS3</b>	1/10
	KF4	<b>590.KFS4</b>	1/10
	KF5	<b>590.KFS5</b>	1/10

**TOP22 Series**

590.



Description	Colour	Switch size	Contact blocks	
NC CONTACT		Y1	<b>590.PL004001</b> <sup>[1]</sup>	10/60
		Y2	<b>590.PL004003</b> <sup>[1]</sup>	10
NO CONTACT		Y1	<b>590.PL004002</b> <sup>[2]</sup>	10/60
		Y2	<b>590.PL004004</b> <sup>[2]</sup>	10

[1] NC=Normally closed

[2] NO=Normally open

- Snap catch

1.5



# Switchgears COMMAND Series

## Accessories

1

INDUSTRY

### TOP22 Series

590.



Description	Switch size	Notes	Contact blocks
CHANGE OVER CONTACT - Break before main contacts	Y3 Y4 Y5 C1 C2 C3	15A 250V~ - 10A 415V~	<b>590.PL005</b> 50

2

3

4

### TOP22 Series

590.



Description	Switch size	Contact blocks
AUXILIARY CONTACT 1NA+1NC	KF1 KF2 K2	<b>590.PL006011</b> 10
	KF3 KF5 K3 K5 K6	<b>590.PL006012</b> 10
	KF4 K4	<b>590.PL006013</b> 10
AUXILIARY CONTACT 2NA+2NC	KF1 KF2 K2	<b>590.PL006021</b> 10
	KF3 KF5 K3 K5 K6	<b>590.PL006022</b> 10
	KF4 K4	<b>590.PL006023</b> 10

- Break before main contacts



# Switchgears

## ISOLATORS Series



### Enclosed switch disconnectors >> Flush mounting - Thermoplastic version [OMNIA enclosure]

ISOLATORS Series

590.



For emergency switching



For general use

				SWITCH DISCONNECTOR			
				IP65			
				EMERGENCY		GENERAL	
Current	Poles	Switch size	Dimension				
20A	2P	Y1	136x125mm	<b>590.ER2002</b> <sup>[3]</sup>	1/12	<b>590.GR2002</b> <sup>[1]</sup>	1/12
	3P			<b>590.ER2003</b> <sup>[3]</sup>	1/12	<b>590.GR2003</b> <sup>[1]</sup>	1/12
	4P			<b>590.ER2004</b> <sup>[3]</sup>	1/12	<b>590.GR2004</b> <sup>[1]</sup>	1/12
	3P+N			<b>590.ER2005</b> <sup>[3][2]</sup>	1/12	<b>590.GR2005</b> <sup>[1][2]</sup>	1/12
32A	2P	Y1	136x125mm	<b>590.ER3202</b> <sup>[3]</sup>	1/12	<b>590.GR3202</b> <sup>[1]</sup>	1/12
	3P			<b>590.ER3203</b> <sup>[3]</sup>	1/12	<b>590.GR3203</b> <sup>[1]</sup>	1/12
	4P			<b>590.ER3204</b> <sup>[3]</sup>	1/12	<b>590.GR3204</b> <sup>[1]</sup>	1/12
	3P+N			<b>590.ER3205</b> <sup>[3][2]</sup>	1/12	<b>590.GR3205</b> <sup>[1][2]</sup>	1/12
40A	2P	Y1	136x125mm	<b>590.ER4002</b> <sup>[3]</sup>	1/12	<b>590.GR4002</b> <sup>[1]</sup>	1/12
	3P			<b>590.ER4003</b> <sup>[3]</sup>	1/12	<b>590.GR4003</b> <sup>[1]</sup>	1/12
	4P			<b>590.ER4004</b> <sup>[3]</sup>	1/12	<b>590.GR4004</b> <sup>[1]</sup>	1/12
	3P+N			<b>590.ER4005</b> <sup>[3][2]</sup>	1/12	<b>590.GR4005</b> <sup>[1][2]</sup>	1/12

<sup>[1]</sup> Handle padlockable in OFF (3 padlocks) and ON (1 padlock) position

<sup>[2]</sup> With late break and early make neutral pole

<sup>[3]</sup> Handle padlockable in OFF only (3 padlocks)

- With panel mounting version (R) switch

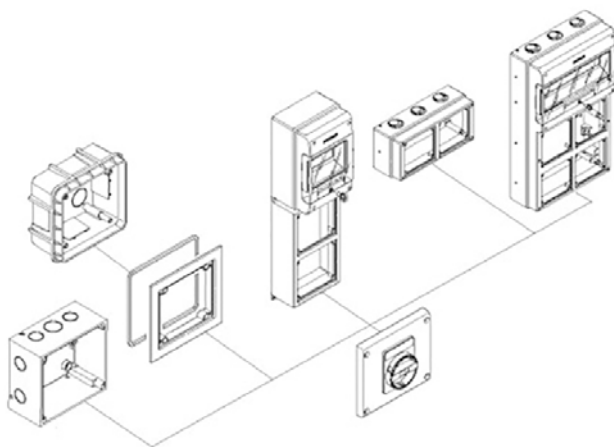

1.5



## Switchgears ISOLATORS Series

■ Enclosed switch disconnectors >> Surface mounting - Thermoplastic version [16A÷40A] [OMNIA enclosure]

ISOLATORS Series

590.

1

INDUSTRY



For emergency



For general use

SWITCH DISCONNECTOR

IP65

EMERGENCY

GENERAL

Current	Poles	Switch size	Dimension	EMERGENCY		GENERAL	
20A	2P	Y1	136x125x84mm	<b>590.EM2002</b> <sup>[3]</sup>	1/12	<b>590.GE2002</b> <sup>[1]</sup>	1/12
	3P			<b>590.EM2003</b> <sup>[3]</sup>	1/12	<b>590.GE2003</b> <sup>[1]</sup>	1/12
	4P			<b>590.EM2004</b> <sup>[3]</sup>	1/12	<b>590.GE2004</b> <sup>[1]</sup>	1/12
	3P+N			<b>590.EM2005</b> <sup>[3][2]</sup>	1/12	<b>590.GE2005</b> <sup>[1][2]</sup>	1/12
32A	2P	Y1	136x125x84mm	<b>590.EM3202</b> <sup>[3]</sup>	1/12	<b>590.GE3202</b> <sup>[1]</sup>	1/12
	3P			<b>590.EM3203</b> <sup>[3]</sup>	1/12	<b>590.GE3203</b> <sup>[1]</sup>	1/12
	4P			<b>590.EM3204</b> <sup>[3]</sup>	1/12	<b>590.GE3204</b> <sup>[1]</sup>	1/12
	3P+N			<b>590.EM3205</b> <sup>[3][2]</sup>	1/12	<b>590.GE3205</b> <sup>[1][2]</sup>	1/12
40A	2P	Y1	136x125x84mm	<b>590.EM4002</b> <sup>[3]</sup>	1/12	<b>590.GE4002</b> <sup>[1]</sup>	1/12
	3P			<b>590.EM4003</b> <sup>[3]</sup>	1/12	<b>590.GE4003</b> <sup>[1]</sup>	1/12
	4P			<b>590.EM4004</b> <sup>[3]</sup>	1/12	<b>590.GE4004</b> <sup>[1]</sup>	1/12
	3P+N			<b>590.EM4005</b> <sup>[3][2]</sup>	1/12	<b>590.GE4005</b> <sup>[1][2]</sup>	1/12

<sup>[1]</sup> Handle padlockable in OFF (3 padlocks) and ON (1 padlock) position

<sup>[2]</sup> With late break and early make neutral pole

<sup>[3]</sup> Handle padlockable in OFF only (3 padlocks)

- OMNIA Series enclosure
- Blank side with drilling point mark
- Equipped with door interlock

# Switchgears

## ISOLATORS Series



### Enclosed switch disconnectors >> Surface mounting - Thermoplastic version [16A÷40A] GE

ISOLATORS Series

590.



For general use [SPECIAL]

For general use

SWITCH DISCONNECTOR

IP65

GENERAL

Current	Poles	Switch size	Dimension	SWITCH DISCONNECTOR		GENERAL	
				590.EL	1/5	590.GE	1/5
16A	6P	Y3	155x210x107mm	590.EL1606	1/5	590.GE1606	1/5
	8P			590.EL1608 <sup>1</sup>	1/5	590.GE1608 <sup>1</sup>	1/5
20A	2P	Y1	105x150x82mm	590.EL2012	1/12	590.GE2012	1/12
	3P			590.EL2013	1/12	590.GE2013	1/12
	4P			590.EL2015 <sup>1</sup>	1/12	590.GE2015 <sup>1</sup>	1/12
	3P+N						
25A	6P	Y3	155x210x107mm	590.EL2506	1/5	590.GE2506	1/5
	8P			590.EL2508 <sup>1</sup>	1/5	590.GE2508 <sup>1</sup>	1/5
	2P			590.EL3212	1/12	590.GE3212	1/12
	3P			590.EL3213	1/12	590.GE3213	1/12
32A	4P	Y1	105x150x82mm			590.GE3214	1/12
	3P+N			590.EL3215 <sup>1</sup>	1/12	590.GE3215 <sup>1</sup>	1/12
	6P			590.EL3206	1/5	590.GE3206	1/5
	8P			590.EL3208 <sup>1</sup>	1/5	590.GE3208 <sup>1</sup>	1/5
40A	2P	Y1	105x150x82mm	590.EL4012	1/12	590.GE4012	1/12
	3P			590.EL4013	1/12	590.GE4013	1/12
	4P					590.GE4014	1/12
	3P+N			590.EL4015 <sup>1</sup>	1/12	590.GE4015 <sup>1</sup>	1/12
	6P			590.EL4006	1/5	590.GE4006	1/5
	8P			590.EL4008 <sup>1</sup>	1/5	590.GE4008 <sup>1</sup>	1/5

<sup>1</sup> With late break and early make neutral pole

- Handle padlockable in OFF (3 padlocks) and ON (1 padlock) position
- Equipped with door interlock
- Break-through cable entries

1.5



# Switchgears

## ISOLATORS Series

■ Enclosed switch disconnectors >> Surface mounting - Thermoplastic version [16A÷40A] EM

ISOLATORS Series

590.



For emergency

SWITCH DISCONNECTOR

IP65

EMERGENCY

Current	Poles	Switch size	Dimension				
16A	6P	Y3	155x210x107mm	<b>590.EM1606</b>	1/5		
	8P			<b>590.EM1608</b> <sup>[1]</sup>	1/5		
20A	2P	Y1	105x150x82mm	<b>590.EM2012</b>	1/12		
	3P			<b>590.EM2013</b>	1/12		
	4P			<b>590.EM2014</b>	1/12		
	3P+N			<b>590.EM2015</b> <sup>[1]</sup>	1/12		
	6P			<b>590.EM2506</b>	1/5		
25A	8P	Y3	155x210x107mm	<b>590.EM2508</b> <sup>[1]</sup>	1/5		
	2P			<b>590.EM3212</b>	1/12		
32A	3P	Y1	105x150x82mm	<b>590.EM3213</b>	1/12		
	4P			<b>590.EM3214</b>	1/12		
	3P+N			<b>590.EM3215</b> <sup>[1]</sup>	1/12		
	6P			Y3	155x210x107mm	<b>590.EM3206</b>	1/5
	8P					<b>590.EM3208</b> <sup>[1]</sup>	1/5
40A	2P	Y1	105x150x82mm	<b>590.EM4012</b>	1/12		
	3P			<b>590.EM4013</b>	1/12		
	4P			<b>590.EM4014</b>	1/12		
	3P+N			<b>590.EM4015</b> <sup>[1]</sup>	1/12		
	6P			Y3	155x210x107mm	<b>590.EM4006</b>	1/5
8P	<b>590.EM4008</b> <sup>[1]</sup>	1/5					

- <sup>[1]</sup> With late break and early make neutral pole
- Handle padlockable in OFF only (3 padlocks)
  - Equipped with door interlock
  - Break-through cable entries

1

INDUSTRY

2

3

4

■ Enclosed switch disconnectors >> Surface mounting - Thermoplastic version [63A÷160A] GE

ISOLATORS Series

590.



For general use [SPECIAL]

For general use

Current	Poles	Switch size	Dimension	SWITCH DISCONNECTOR			
				IP65		IP55	
				GENERAL		GENERAL	
63A	2P	Y2	155x210x107mm	<b>590.EL6302</b> <sup>1</sup>	1/5	<b>590.GE6302</b> <sup>1</sup>	1/5
	3P			<b>590.EL6303</b> <sup>1</sup>	1/5	<b>590.GE6303</b> <sup>1</sup>	1/5
	4P			<b>590.EL6305</b> <sup>2,1</sup>	1/5	<b>590.GE6304</b> <sup>1</sup>	1/5
	3P+N			<b>590.GE6305</b> <sup>2,1</sup>	1/5		
	6P	Y4	228x308x128mm			<b>590.GE6306</b> <sup>3</sup>	1
8P					<b>590.GE6308</b> <sup>2,3</sup>	1	
80A	2P	Y2	155x210x107mm	<b>590.EL8002</b> <sup>1</sup>	1/5	<b>590.GE8002</b> <sup>1</sup>	1/5
	3P			<b>590.EL8003</b> <sup>1</sup>	1/5	<b>590.GE8003</b> <sup>1</sup>	1/5
	4P			<b>590.EL8005</b> <sup>2,1</sup>	1/5	<b>590.GE8004</b> <sup>1</sup>	1/5
	3P+N			<b>590.GE8005</b> <sup>2,1</sup>	1/5		
	6P	Y4	228x308x128mm			<b>590.GE8006</b> <sup>3</sup>	1
8P					<b>590.GE8008</b> <sup>2,3</sup>	1	
100A	3P	Y2	155x210x107mm	<b>590.EL10003</b> <sup>1</sup>	1/5	<b>590.GE10003</b> <sup>1</sup>	1/5
	3P+N			<b>590.EL10005</b> <sup>2,1</sup>	1/5	<b>590.GE10005</b> <sup>2,1</sup>	1/5
	6P	Y4	228x308x128mm			<b>590.GE10006</b> <sup>3</sup>	1
8P					<b>590.GE10008</b> <sup>2,3</sup>	1	
125A	3P	Y5	308x388x128mm		<b>590.GE12503</b> <sup>3</sup>	1	
	3P+N			<b>590.GE12505</b> <sup>2,3</sup>	1		
	6P					<b>590.GE12506</b> <sup>3</sup>	1
	8P				<b>590.GE12508</b> <sup>2,3</sup>	1	
160A	3P			<b>590.GE16003</b> <sup>3</sup>	1		
	3P+N			<b>590.GE16005</b> <sup>2,3</sup>	1		
	6P					<b>590.GE16006</b> <sup>3</sup>	1
	8P					<b>590.GE16008</b> <sup>2,3</sup>	1

<sup>1</sup> Break-through cable entries

<sup>2</sup> With late break and early make neutral pole

<sup>3</sup> Blank sides

- Handle padlockable in OFF (3 padlocks) and ON (1 padlock) position
- Equipped with door interlock

1.5



# Switchgears

## ISOLATORS Series

### ■ Enclosed switch disconnectors >> Surface mounting - Thermoplastic version [63A÷160A] EM

ISOLATORS Series

590.



For emergency

SWITCH DISCONNECTOR

IP55

IP65

EMERGENCY

Current	Poles	Switch size	Dimension	EMERGENCY	
63A	2P	Y2	155x210x107mm		
	3P			<b>590.EM6302</b> <sup>[1]</sup>	1/5
	4P			<b>590.EM6303</b> <sup>[1]</sup>	1/5
	3P+N			<b>590.EM6304</b> <sup>[1]</sup>	1/5
	6P	Y4	228x308x128mm	<b>590.EM6306</b> <sup>[3]</sup>	1
	8P			<b>590.EM6308</b> <sup>[2][3]</sup>	1
80A	2P	Y2	155x210x107mm		
	3P			<b>590.EM8002</b> <sup>[1]</sup>	1/5
	4P			<b>590.EM8003</b> <sup>[1]</sup>	1/5
	3P+N			<b>590.EM8004</b> <sup>[1]</sup>	1/5
	6P	Y4	228x308x128mm	<b>590.EM8006</b> <sup>[3]</sup>	1
	8P			<b>590.EM8008</b> <sup>[2][3]</sup>	1
100A	3P	Y2	155x210x107mm		
	3P+N			<b>590.EM10003</b> <sup>[1]</sup>	1/5
	6P	Y4	228x308x128mm	<b>590.EM10006</b> <sup>[3]</sup>	1
	8P			<b>590.EM10008</b> <sup>[2][3]</sup>	1
125A	3P	Y5	308x388x128mm		
	3P+N			<b>590.EM12503</b> <sup>[3]</sup>	1
	6P			<b>590.EM12505</b> <sup>[2][3]</sup>	1
	8P			<b>590.EM12506</b> <sup>[3]</sup>	1
160A	3P	Y5	308x388x128mm		
	3P+N			<b>590.EM12508</b> <sup>[2][3]</sup>	1
	6P			<b>590.EM16003</b> <sup>[3]</sup>	1
	8P			<b>590.EM16005</b> <sup>[2][3]</sup>	1
160A	6P	Y5	308x388x128mm		
	3P+N			<b>590.EM16006</b> <sup>[3]</sup>	1
	8P			<b>590.EM16008</b> <sup>[2][3]</sup>	1

[1] Break-through cable entries

[2] With late break and early make neutral pole

[3] Blank sides

- Handle padlockable in OFF only (3 padlocks)
- Equipped with door interlock

1

INDUSTRY

2

3

4

■ Enclosed switch disconnectors >> Surface mounting - Thermoplastic version

ISOLATORS Series

590.



For general use

SWITCH DISCONNECTOR

IP65

GENERAL

Current	Poles	Dimension		
20A			<b>590.GE2021</b>	1/12
32A	1P	82x120x69mm	<b>590.GE3221</b>	1/12
40A			<b>590.GE4021</b>	1/12

- Single pole switch, not suitable to receive door-locking kit.
- Handle padlockable in OFF (3 padlocks) and ON (1 padlock) position
- Break-through cable entries
- Suitable to switch single phase motor loads or other inductive loads
- Integrated switch

1.5



# Switchgears

## ISOLATORS Series

### ■ Enclosed switch disconnectors >> Surface mounting [HD] - Engineering plastic version - Heavy Duty

ISOLATORS-HD Series

590.

1

INDUSTRY



For emergency

For general use

SWITCH DISCONNECTOR

IP66

EMERGENCY

GENERAL

Current	Poles	Switch size	Dimension	EMERGENCY		GENERAL	
				590.JEM	1/12	590.JGE	1/12
20A	2P	Y1	226x306x115mm	<b>590.JEM2002</b>	1/12	<b>590.JGE2002</b>	1/12
	3P			<b>590.JEM2003</b>	1/12	<b>590.JGE2003</b>	1/12
	3P+N			<b>590.JEM2005<sup>[1]</sup></b>	1/12	<b>590.JGE2005<sup>[1]</sup></b>	1/12
32A	2P			<b>590.JEM3202</b>	1/12	<b>590.JGE3202</b>	1/12
	3P			<b>590.JEM3203</b>	1/12	<b>590.JGE3203</b>	1/12
	3P+N			<b>590.JEM3205<sup>[1]</sup></b>	1/12	<b>590.JGE3205<sup>[1]</sup></b>	1/12
40A	2P			<b>590.JEM4002</b>	1/12	<b>590.JGE4002</b>	1/12
	3P			<b>590.JEM4003</b>	1/12	<b>590.JGE4003</b>	1/12
	3P+N			<b>590.JEM4005<sup>[1]</sup></b>	1/12	<b>590.JGE4005<sup>[1]</sup></b>	1/12

<sup>[1]</sup> With late break and early make neutral pole

- Handle padlockable in OFF (3 padlocks) and ON (1 padlock) position
- Blank side with drilling point mark



**HD**  
Heavy Duty



■ Enclosed switch disconnectors >> Surface mounting - Aluminium version [16A÷40A] GE

ISOLATORS Series

590.



For general use [SPECIAL]



For general use

Current	Poles	Switch size	Dimension	SWITCH DISCONNECTOR			
				IP65		GENERAL	
16A	6P	Y3	150x210x107mm	<b>590.HEL1606</b>	1/5	<b>590.HGE1606</b>	1/5
	8P			<b>590.HEL1608</b> <sup>1</sup>	1/5	<b>590.HGE1608</b> <sup>1</sup>	1/5
20A	2P	Y1	105x150x82mm	<b>590.HEL2002</b>	1/12	<b>590.HGE2002</b>	1/12
	3P			<b>590.HEL2003</b>	1/12	<b>590.HGE2003</b>	1/12
	4P			<b>590.HEL2005</b> <sup>1</sup>	1/12	<b>590.HGE2005</b> <sup>1</sup>	1/12
	3P+N						
	6P						
25A	6P	Y3	150x210x107mm	<b>590.HEL2506</b>	1/5	<b>590.HGE2506</b>	1/5
	8P			<b>590.HEL2508</b> <sup>1</sup>	1/5	<b>590.HGE2508</b> <sup>1</sup>	1/5
	2P			<b>590.HEL3202</b>	1/12	<b>590.HGE3202</b>	1/12
	3P			<b>590.HEL3203</b>	1/12	<b>590.HGE3203</b>	1/12
	4P			<b>590.HEL3205</b> <sup>1</sup>	1/12	<b>590.HGE3205</b> <sup>1</sup>	1/12
32A	6P	Y3	150x210x107mm	<b>590.HEL3206</b>	1/5	<b>590.HGE3206</b>	1/5
	8P			<b>590.HEL3208</b> <sup>1</sup>	1/5	<b>590.HGE3208</b> <sup>1</sup>	1/5
	2P			<b>590.HEL4002</b>	1/12	<b>590.HGE4002</b>	1/12
	3P			<b>590.HEL4003</b>	1/12	<b>590.HGE4003</b>	1/12
	4P			<b>590.HEL4005</b> <sup>1</sup>	1/12	<b>590.HGE4005</b> <sup>1</sup>	1/12
40A	6P	Y3	150x210x107mm	<b>590.HEL4006</b>	1/5	<b>590.HGE4006</b>	1/5
	8P			<b>590.HEL4008</b> <sup>1</sup>	1/5	<b>590.HGE4008</b> <sup>1</sup>	1/5

- <sup>1</sup> With late break and early make neutral pole
- Handle padlockable in OFF (3 padlocks) and ON (1 padlock) position
  - Equipped with door interlock
  - Open threaded cable entry with cap / cable sleeve

1.5



# Switchgears

## ISOLATORS Series

### Enclosed switch disconnectors >> Surface mounting - Aluminium version [16A÷40A] EM

ISOLATORS Series

590.



For emergency switching

SWITCH DISCONNECTOR

IP65

EMERGENCY

Current	Poles	Switch size	Dimension		
16A	6P	Y3	150x210x107mm	<b>590.HEM1606</b>	1/5
	8P			<b>590.HEM1608</b> <sup>[1]</sup>	1/5
20A	2P	Y1	105x150x82mm	<b>590.HEM2002</b>	1/12
	3P			<b>590.HEM2003</b>	1/12
	4P			<b>590.HEM2004</b>	1/12
	3P+N			<b>590.HEM2005</b> <sup>[1]</sup>	1/12
	6P			<b>590.HEM2506</b>	1/5
25A	8P	Y3	150x210x107mm	<b>590.HEM2508</b> <sup>[1]</sup>	1/5
	2P			<b>590.HEM3202</b>	1/12
32A	3P	Y1	105x150x82mm	<b>590.HEM3203</b>	1/12
	4P			<b>590.HEM3204</b>	1/12
	3P+N			<b>590.HEM3205</b> <sup>[1]</sup>	1/12
	6P			<b>590.HEM3206</b>	1/5
	8P			<b>590.HEM3208</b> <sup>[1]</sup>	1/5
40A	2P	Y1	105x150x82mm	<b>590.HEM4002</b>	1/12
	3P			<b>590.HEM4003</b>	1/12
	4P			<b>590.HEM4004</b>	1/12
	3P+N			<b>590.HEM4005</b> <sup>[1]</sup>	1/12
	6P			<b>590.HEM4006</b>	1/5
	8P	Y3	150x210x107mm	<b>590.HEM4008</b> <sup>[1]</sup>	1/5

- <sup>[1]</sup> With late break and early make neutral pole
- Handle padlockable in OFF only (3 padlocks)
  - Equipped with door interlock
  - Open threaded cable entry with cap / cable sleeve

1

INDUSTRY

2

3

4

■ Enclosed switch disconnectors >> Surface mounting - Aluminium version [63A÷160A] GE

ISOLATORS Series

590.



For general use [SPECIAL]





For general use

SWITCH DISCONNECTOR

IP65

GENERAL

Current	Poles	Switch size	Dimension				
63A	2P	Y2	150x210x107mm	<b>590.HEL6302</b> <sup>1</sup>	1/5	<b>590.HGE6302</b> <sup>1</sup>	1/5
	3P			<b>590.HEL6303</b> <sup>1</sup>	1/5	<b>590.HGE6303</b> <sup>1</sup>	1/5
	4P			<b>590.HEL6304</b> <sup>1</sup>	1/5	<b>590.HGE6304</b> <sup>1</sup>	1/5
	3P+N	Y4	264x315x122mm	<b>590.HEL6305</b> <sup>2</sup> <sup>1</sup>	1/5	<b>590.HGE6305</b> <sup>2</sup> <sup>1</sup>	1/5
	6P			<b>590.HGE6306</b>	1	<b>590.HGE6306</b>	1
	8P			<b>590.HGE6308</b> <sup>2</sup>	1	<b>590.HGE6308</b> <sup>2</sup>	1
80A	2P	Y2	150x210x107mm	<b>590.HEL8002</b> <sup>1</sup>	1/5	<b>590.HGE8002</b> <sup>1</sup>	1/5
	3P			<b>590.HEL8003</b> <sup>1</sup>	1/5	<b>590.HGE8003</b> <sup>1</sup>	1/5
	4P			<b>590.HEL8004</b> <sup>1</sup>	1/5	<b>590.HGE8004</b> <sup>1</sup>	1/5
	3P+N	Y4	264x315x122mm	<b>590.HEL8005</b> <sup>2</sup> <sup>1</sup>	1/5	<b>590.HGE8005</b> <sup>2</sup> <sup>1</sup>	1/5
	6P			<b>590.HGE8006</b> <sup>3</sup>	1	<b>590.HGE8006</b> <sup>3</sup>	1
	8P			<b>590.HGE8008</b> <sup>2</sup> <sup>3</sup>	1	<b>590.HGE8008</b> <sup>2</sup> <sup>3</sup>	1
100A	3P	Y2	150x210x107mm	<b>590.HEL10003</b> <sup>3</sup>	1/5	<b>590.HGE10003</b> <sup>1</sup>	1/5
	3P+N			<b>590.HEL10005</b> <sup>2</sup> <sup>3</sup>	1/5	<b>590.HGE10005</b> <sup>2</sup> <sup>1</sup>	1/5
	6P	Y4	264x315x122mm	<b>590.HGE10006</b> <sup>3</sup>	1	<b>590.HGE10006</b> <sup>3</sup>	1
8P	<b>590.HGE10008</b> <sup>2</sup> <sup>3</sup>			1	<b>590.HGE10008</b> <sup>2</sup> <sup>3</sup>	1	
125A	3P	Y5	315x410x128mm	<b>590.HGE12503</b> <sup>3</sup>	1	<b>590.HGE12503</b> <sup>3</sup>	1
	3P+N			<b>590.HGE12505</b> <sup>2</sup> <sup>3</sup>	1	<b>590.HGE12505</b> <sup>2</sup> <sup>3</sup>	1
	6P			<b>590.HGE12506</b> <sup>3</sup>	1	<b>590.HGE12506</b> <sup>3</sup>	1
160A	8P	Y5	315x410x128mm	<b>590.HGE12508</b> <sup>2</sup> <sup>3</sup>	1	<b>590.HGE12508</b> <sup>2</sup> <sup>3</sup>	1
	3P			<b>590.HGE16003</b> <sup>3</sup>	1	<b>590.HGE16003</b> <sup>3</sup>	1
	3P+N			<b>590.HGE16005</b> <sup>2</sup> <sup>3</sup>	1	<b>590.HGE16005</b> <sup>2</sup> <sup>3</sup>	1
	6P			<b>590.HGE16006</b> <sup>3</sup>	1	<b>590.HGE16006</b> <sup>3</sup>	1
	8P			<b>590.HGE16008</b> <sup>2</sup> <sup>3</sup>	1	<b>590.HGE16008</b> <sup>2</sup> <sup>3</sup>	1

<sup>1</sup> Open threaded cable entry with cap / cable sleeve

<sup>2</sup> With late break and early make neutral pole

<sup>3</sup> Blank sides

- Handle padlockable in OFF (3 padlocks) and ON (1 padlock) position
- Equipped with door interlock

1.5



# Switchgears

## ISOLATORS Series

### ■ Enclosed switch disconnectors >> Surface mounting - Aluminium version [63A÷160A] EM

ISOLATORS Series

590.



For emergency switching

SWITCH DISCONNECTOR

IP65

EMERGENCY

Current	Poles	Switch size	Dimension		
63A	2P	Y2	150x210x107mm	<b>590.HEM6302</b> <sup>[1]</sup>	1/5
	3P			<b>590.HEM6303</b> <sup>[1]</sup>	1/5
	4P			<b>590.HEM6304</b> <sup>[1]</sup>	1/5
	3P+N			<b>590.HEM6305</b> <sup>[2][1]</sup>	1/5
	6P	Y4	264x315x122mm	<b>590.HEM6306</b> <sup>[3]</sup>	1
8P	<b>590.HEM6308</b> <sup>[2][3]</sup>			1	
80A	2P	Y2	150x210x107mm	<b>590.HEM8002</b> <sup>[1]</sup>	1/5
	3P			<b>590.HEM8003</b> <sup>[1]</sup>	1/5
	4P			<b>590.HEM8004</b> <sup>[1]</sup>	1/5
	3P+N			<b>590.HEM8005</b> <sup>[2][1]</sup>	1/5
	6P	Y4	264x315x122mm	<b>590.HEM8006</b> <sup>[3]</sup>	1
8P	<b>590.HEM8008</b> <sup>[2][3]</sup>			1	
100A	3P	Y2	150x210x107mm	<b>590.HEM10003</b> <sup>[1]</sup>	1/5
	3P+N			<b>590.HEM10005</b> <sup>[2][1]</sup>	1/5
	6P	Y4	264x315x122mm	<b>590.HEM10006</b> <sup>[3]</sup>	1
	8P			<b>590.HEM10008</b> <sup>[2][3]</sup>	1
125A	3P	Y5	315x410x128mm	<b>590.HEM12503</b> <sup>[3]</sup>	1
	3P+N			<b>590.HEM12505</b> <sup>[2][3]</sup>	1
	6P			<b>590.HEM12506</b> <sup>[3]</sup>	1
	8P			<b>590.HEM12508</b> <sup>[2][3]</sup>	1
160A	3P	Y5	315x410x128mm	<b>590.HEM16003</b> <sup>[3]</sup>	1
	3P+N			<b>590.HEM16005</b> <sup>[2][3]</sup>	1
	6P			<b>590.HEM16006</b> <sup>[3]</sup>	1
	8P			<b>590.HEM16008</b> <sup>[2][3]</sup>	1

[1] Open threaded cable entry with cap / cable sleeve

[2] With late break and early make neutral pole

[3] Blank sides

- Handle padlockable in OFF only (3 padlocks)
- Equipped with door interlock

1

INDUSTRY

2

3

4

# Switchgears

## ISOLATORS Series



■ Enclosed switch disconnectors >> Surface mounting - Aluminium version [100A÷160A] - High wiring capacity terminals

### ISOLATORS Series

590.



For emergency switching



For general use

### SWITCH DISCONNECTOR

IP65

#### EMERGENCY

#### GENERAL

Current	Poles	Switch size	Dimension	EMERGENCY	GENERAL
100A	3P	K1	264x315x112mm	590.HEM10003.W <sup>[5][2]</sup>	590.HGE10003.W <sup>[1][2]</sup>
	3P+N			590.HEM10005.W <sup>[5][3][2]</sup>	590.HGE10005.W <sup>[1][3][2]</sup>
125A	3P	K1	315x410x150mm	590.HEM12503.W <sup>[5][4]</sup>	590.HGE12503.W <sup>[1][4]</sup>
	3P+N			590.HEM12505.W <sup>[5][3][4]</sup>	590.HGE12505.W <sup>[1][3][4]</sup>
160A	3P	K2	315x410x150mm	590.HEM16003.W <sup>[5][4]</sup>	590.HGE16003.W <sup>[1][4]</sup>
	3P+N			590.HEM16005.W <sup>[5][3][4]</sup>	590.HGE16005.W <sup>[1][3][4]</sup>

[1] Handle padlockable in OFF (3 padlocks) and ON (1 padlock) position

[2] Open threaded cable entry with cap / cable sleeve

[3] With late break and early make neutral pole

[4] Blank sides

[5] Handle padlockable in OFF only (3 padlocks)

- Switch and enclosure increased dimensions

1.5



# Switchgears

## ISOLATORS Series

### Enclosed switch disconnectors >> Surface mounting - Stainless steel version

ISOLATORS Series

590.



For emergency switching

For general use

SWITCH DISCONNECTOR

IP65

EMERGENCY

GENERAL

Current	Poles	Switch size	Dimension	EMERGENCY		GENERAL	
				590.SEM	1/12	590.SGE	1/12
16A	6P	Y3	226x306x115mm	590.SEM1606	1/12	590.SGE1606	1/12
	2P			590.SEM2002	1/12	590.SGE2002	1/12
20A	3P	Y1	125x165x90mm	590.SEM2003	1/12	590.SGE2003	1/12
	3P+N			590.SEM2005 <sup>[1]</sup>	1	590.SGE2005 <sup>[1]</sup>	1/12
25A	6P	Y3	226x306x115mm	590.SEM2506	1/12	590.SGE2506	1/12
	2P			590.SEM3202	1/12	590.SGE3202	1/12
32A	3P	Y1	125x165x90mm	590.SEM3203	1/12	590.SGE3203	1/12
	3P+N			590.SEM3205 <sup>[1]</sup>	1	590.SGE3205 <sup>[1]</sup>	1
	6P	Y3	226x306x115mm	590.SEM3206	1/12	590.SGE3206	1/12
40A	2P			590.SEM4002	1/12	590.SGE4002	1/12
	3P	Y1	125x165x90mm	590.SEM4003	1/12	590.SGE4003	1
	3P+N			590.SEM4005 <sup>[1]</sup>	1/12	590.SGE4005 <sup>[1]</sup>	1/12
63A	6P	Y3	226x306x115mm	590.SEM4006	1/12	590.SGE4006	1
	3P		176x226x90mm	590.SEM6303	1/5	590.SGE6303	1
	3P+N			590.SEM6305 <sup>[1]</sup>	1/5	590.SGE6305 <sup>[1]</sup>	1
80A	6P		226x306x115mm	590.SEM6306	1/5	590.SGE6306	1/5
	3P	Y4	176x226x90mm	590.SEM8003	1/5	590.SGE8003	1/5
	3P+N			590.SEM8005 <sup>[1]</sup>	1/5	590.SGE8005 <sup>[1]</sup>	1/5
100A	6P		226x306x115mm	590.SEM8006	1/5	590.SGE8006	1/5
	3P		176x226x90mm	590.SEM10003	1/5	590.SGE10003	1/5
	3P+N			590.SEM10005 <sup>[1]</sup>	1/5	590.SGE10005 <sup>[1]</sup>	1/5
125A	6P		226x306x115mm	590.SEM10006	1/5	590.SGE10006	1
	3P			590.SEM12503	1/5	590.SGE12503	1/5
	3P+N			590.SEM12505 <sup>[1]</sup>	1/5	590.SGE12505 <sup>[1]</sup>	1/5
160A	6P	Y5	312x412x115mm	590.SEM12506	1/5	590.SGE12506	1/5
	3P			590.SEM16003	1	590.SGE16003	1
	3P+N			590.SEM16005 <sup>[1]</sup>	1	590.SGE16005 <sup>[1]</sup>	1
	6P			590.SEM16006	1	590.SGE16006	1

<sup>[1]</sup> With late break and early make neutral pole

- Handle padlockable in OFF only (3 padlocks)
- Equipped with door interlock
- Blank sides

1

INDUSTRY

2

3

4

■ Enclosed switch disconnectors >> Surface mounting - Metal version (HR) - High Rating

ISOLATORS Series

590.



For general use [TOP/  
BOTTOM]

For emergency switching  
[TOP/BOTTOM]

SWITCH DISCONNECTOR

IP65

GENERAL

EMERGENCY

Current	Poles	Switch size	Dimension	GENERAL	EMERGENCY
160A	3P	K2	500x300x150mm	590.KGE16003 <sup>1</sup>	590.KEM16003 <sup>1</sup>
	3P+N			590.KGE16005 <sup>2 1</sup>	590.KEM16005 <sup>2 1</sup>
200A	3P	K2	300x500x150mm	590.KGE20003 <sup>1</sup>	590.KEM20003 <sup>1</sup>
	3P+N			590.KGE20005 <sup>2 1</sup>	590.KEM20005 <sup>2 1</sup>
250A	3P	K2	300x500x150mm	590.KGE25003 <sup>1</sup>	590.KEM25003 <sup>1</sup>
	3P+N			590.KGE25005 <sup>2 1</sup>	590.KEM25005 <sup>2 1</sup>
315A	3P	K3	400x600x200mm	590.KGE31503 <sup>1</sup>	590.KEM31503 <sup>1</sup>
	3P+N			590.KGE31505 <sup>2 1</sup>	590.KEM31505 <sup>2 1</sup>
400A	3P	K3	400x600x200mm	590.KGE40003 <sup>1</sup>	590.KEM40003 <sup>1</sup>
	3P+N			590.KGE40005 <sup>2 1</sup>	590.KEM40005 <sup>2 1</sup>
500A	3P	K3	400x600x200mm	590.KGE50003 <sup>1</sup>	590.KEM50003 <sup>1</sup>
	3P+N			590.KGE50005 <sup>2 1</sup>	590.KEM50005 <sup>2 1</sup>
630A	3P	K4	500x700x250mm	590.KGE63003 <sup>1</sup>	590.KEM63003 <sup>1</sup>
	3P+N			590.KGE63005 <sup>2 1</sup>	590.KEM63005 <sup>2 1</sup>
800A	3P	K4	500x700x250mm	590.KGE80003 <sup>1</sup>	590.KEM80003 <sup>1</sup>
	3P+N			590.KGE80005 <sup>2 1</sup>	590.KEM80005 <sup>2 1</sup>
1000A	3P	K5	500x700x250mm	590.KGE100003 <sup>1</sup>	590.KEM100003 <sup>1</sup>
	3P+N			590.KGE100005 <sup>2 1</sup>	590.KEM100005 <sup>2 1</sup>
1250A	3P	K5	500x700x250mm	590.KGE125003 <sup>1</sup>	590.KEM125003 <sup>1</sup>
	3P+N			590.KGE125005 <sup>2 1</sup>	590.KEM125005 <sup>2 1</sup>
1600A	3P	K6	600x1000x300mm	590.KGE160003 <sup>3</sup>	590.KEM160003 <sup>3</sup>
	3P+N			590.KGE160005 <sup>2 3</sup>	590.KEM160005 <sup>2 3</sup>

<sup>1</sup> Full current neutral pole up to 1250A

<sup>2</sup> With late break and early make neutral pole

<sup>3</sup> Neutral pole 1250A. Full current neutral pole on request.

- Handle padlockable in OFF only (3 padlocks)
- TOP/BOTTOM = Top/Bottom connection
- Equipped with door interlock
- Gland plate cable entry

1.5



# Switchgears

## ISOLATORS Series

### Enclosed switch disconnectors >> Surface mounting - Metal version (HR) - High Rating

ISOLATORS Series

590.



For general use  
[BOTTOM/BOTTOM]

SWITCH DISCONNECTOR

IP65

GENERAL

Current	Poles	Switch size	Dimension		
160A	3P	K2	500x300x150mm	<b>590.KGE16003B</b> <sup>[1]</sup>	1
	3P+N			<b>590.KGE16005B</b> <sup>[2][1]</sup>	1
200A	3P	K2	300x500x150mm	<b>590.KGE20003B</b> <sup>[1]</sup>	1
	3P+N			<b>590.KGE20005B</b> <sup>[2][1]</sup>	1
250A	3P	K2	300x500x150mm	<b>590.KGE25003B</b> <sup>[1]</sup>	1
	3P+N			<b>590.KGE25005B</b> <sup>[2][1]</sup>	1
315A	3P	K3	400x600x200mm	<b>590.KGE31503B</b> <sup>[1]</sup>	1
	3P+N			<b>590.KGE31505B</b> <sup>[2][1]</sup>	1
400A	3P	K3	400x600x200mm	<b>590.KGE40003B</b> <sup>[1]</sup>	1
	3P+N			<b>590.KGE40005B</b> <sup>[2][1]</sup>	1
500A	3P	K3	500x700x250mm	<b>590.KGE50003B</b> <sup>[1]</sup>	1
	3P+N			<b>590.KGE50005B</b> <sup>[2][1]</sup>	1
630A	3P	K4	800x800x300mm	<b>590.KGE63003B</b> <sup>[1]</sup>	1
	3P+N			<b>590.KGE63005B</b> <sup>[2][1]</sup>	1
800A	3P	K4	800x800x300mm	<b>590.KGE80003B</b> <sup>[1]</sup>	1
	3P+N			<b>590.KGE80005B</b> <sup>[2][1]</sup>	1
1000A	3P	K5	1000x1000x300mm	<b>590.KGE100003B</b> <sup>[1]</sup>	1
	3P+N			<b>590.KGE100005B</b> <sup>[2][1]</sup>	1
1250A	3P	K5	1000x1000x300mm	<b>590.KGE125003B</b> <sup>[1]</sup>	1
	3P+N			<b>590.KGE125005B</b> <sup>[2][1]</sup>	1
1600A	3P	K6	1000x1000x300mm	<b>590.KGE160003B</b> <sup>[3]</sup>	1
	3P+N			<b>590.KGE160005B</b> <sup>[2][3]</sup>	1

[1] Full current neutral pole up to 1250A

[2] With late break and early make neutral pole

[3] Neutral pole 1250A. Full current neutral pole on request.

- Handle padlockable in OFF only (3 padlocks)
- BOTTOM/BOTTOM = Bottom/Bottom connection with busbar
- Equipped with door interlock
- Gland plate cable entry

1

INDUSTRY

2

3

4



**Switchgears**  
ISOLATORS Series



■ Enclosed switch disconnectors >> Surface mounting - Thermoplastic version [DC]

ISOLATORS Series

590.



For general use [DC]

SWITCH DISCONNECTOR

IP55

IP65

GENERAL

Current	Poles	Poles in series	Switch size	Dimension		
15A	DC	3	Y1	105x150x127mm	<b>590.DCGE0815</b> <sup>1 2</sup>	1/10
16A		4		105x150x98mm	<b>590.DCGE0416</b> <sup>1 2</sup>	1/12
20A		5	Y3	105x150x127mm	<b>590.DCGE0820</b> <sup>1 2</sup>	1/10
25A		6		<b>590.DCGE0825</b> <sup>1 2</sup>	1/5	
30A		8		155x210x122mm	<b>590.DCGE0830</b> <sup>1 2</sup>	1/5
40A			Y5	228x308x173mm	<b>590.DCGE0840</b> <sup>3 4</sup>	1

<sup>1</sup> Handle padlockable in OFF (3 padlocks) and ON (1 padlock) position

<sup>2</sup> Break-through cable entries

<sup>3</sup> Handle padlockable in OFF only (3 padlocks)

<sup>4</sup> Blank sides

- Equipped with door interlock

1.5



# Switchgears

## ISOLATORS Series

### ■ Enclosed switch disconnecter [FUSES] >> Surface mounting - Thermoplastic version

ISOLATORS Series

590.



For emergency

For general use

SWITCH DISCONNECTOR

IP55

EMERGENCY

GENERAL

Current	Poles	Switch size	Fuse type	Dimension	EMERGENCY	GENERAL
16A	2P	F1	gG 10,3x38mm	190x240x125mm	<b>590.EMF1602</b>	<b>590.GEF1602</b>
	3P				<b>590.EMF1603</b>	<b>590.GEF1603</b>
	4P				<b>590.EMF1604</b>	<b>590.GEF1604</b>
	3P+N				<b>590.EMF1605</b> <sup>[1]</sup>	<b>590.GEF1605</b> <sup>[1]</sup>
32A	2P	F1	gG 10,3x38mm	190x240x125mm	<b>590.EMF3202</b>	<b>590.GEF3202</b>
	3P				<b>590.EMF3203</b>	<b>590.GEF3203</b>
	4P				<b>590.EMF3204</b>	<b>590.GEF3204</b>
	3P+N				<b>590.EMF3205</b> <sup>[1]</sup>	<b>590.GEF3205</b> <sup>[1]</sup>
63A	3P	KF1	DIN-HN	300x380x170mm	<b>590.EMD6303</b>	<b>590.GED6303</b>
			BS		<b>590.EMB6303</b>	<b>590.GEB6303</b>
	3P+N		DIN-HN		<b>590.EMD6305</b> <sup>[1]</sup>	<b>590.GED6305</b> <sup>[1]</sup>
			BS		<b>590.EMB6305</b> <sup>[1]</sup>	<b>590.GEB6305</b> <sup>[1]</sup>
80A	3P	KF1	DIN-HN	300x380x170mm	<b>590.EMD8003</b>	<b>590.GED8003</b>
			BS		<b>590.EMB8003</b>	<b>590.GEB8003</b>
	3P+N		DIN-HN		<b>590.EMD8005</b> <sup>[1]</sup>	<b>590.GED8005</b> <sup>[1]</sup>
			BS		<b>590.EMB8005</b> <sup>[1]</sup>	<b>590.GEB8005</b> <sup>[1]</sup>
100A	3P	KF2	DIN-HN	370x450x180mm	<b>590.EMD10003</b>	<b>590.GED10003</b>
			BS		<b>590.EMB10003</b>	<b>590.GEB10003</b>
	3P+N		DIN-HN		<b>590.EMD10005</b> <sup>[1]</sup>	<b>590.GED10005</b> <sup>[1]</sup>
			BS		<b>590.EMB10005</b> <sup>[1]</sup>	<b>590.GEB10005</b> <sup>[1]</sup>
125A	3P	KF2	DIN-HN	370x450x180mm	<b>590.EMD12503</b>	<b>590.GED12503</b>
			BS		<b>590.EMB12503</b>	<b>590.GEB12503</b>
	3P+N		DIN-HN		<b>590.EMD12505</b> <sup>[1]</sup>	<b>590.GED12505</b> <sup>[1]</sup>
			BS		<b>590.EMB12505</b> <sup>[1]</sup>	<b>590.GEB12505</b> <sup>[1]</sup>
160A	3P	KF2	DIN-HN	370x450x180mm	<b>590.EMD16003</b>	<b>590.GED16003</b>
			BS		<b>590.EMB16003</b>	<b>590.GEB16003</b>
	3P+N		DIN-HN		<b>590.EMD16005</b> <sup>[1]</sup>	<b>590.GED16005</b> <sup>[1]</sup>
			BS		<b>590.EMB16005</b> <sup>[1]</sup>	<b>590.GEB16005</b> <sup>[1]</sup>

[1] With late break and early make neutral pole

- Handle padlockable in OFF only (3 padlocks)
- Equipped with door interlock
- Blank sides

1

INDUSTRY

2

3

4

# Switchgears

## ISOLATORS Series



### Enclosed switch disconnecter [FUSES] >> Surface mounting - Aluminium version

ISOLATORS Series

590.



For emergency switching

For general use

SWITCH DISCONNECTOR

IP65

EMERGENCY

GENERAL

Current	Poles	Switch size	Fuse type	Dimension	SWITCH DISCONNECTOR	
					EMERGENCY	GENERAL
16A	2P	F1	gG 10,3x38mm	217x253x93mm	<b>590.HEMF1602</b>	<b>590.HGEF1602</b>
	3P				<b>590.HEMF1603</b>	<b>590.HGEF1603</b>
	4P				<b>590.HEMF1604</b>	<b>590.HGEF1604</b>
	3P+N				<b>590.HEMF1605</b> <sup>1</sup>	<b>590.HGEF1605</b> <sup>1</sup>
32A	2P	KF1	gG 10,3x38mm	217x253x93mm	<b>590.HEMF3202</b>	<b>590.HGEF3202</b>
	3P				<b>590.HEMF3203</b>	<b>590.HGEF3203</b>
	4P				<b>590.HEMF3204</b>	<b>590.HGEF3204</b>
	3P+N				<b>590.HEMF3205</b> <sup>1</sup>	<b>590.HGEF3205</b> <sup>1</sup>
63A	3P	KF1	DIN-HN	315x410x128mm	<b>590.HEMD6303</b>	<b>590.HGED6303</b>
			BS		<b>590.HEMB6303</b>	<b>590.HGEB6303</b>
	3P+N		DIN-HN		<b>590.HEMD6305</b> <sup>1</sup>	<b>590.HGED6305</b> <sup>1</sup>
			BS		<b>590.HEMB6305</b> <sup>1</sup>	<b>590.HGEB6305</b> <sup>1</sup>
80A	3P	KF1	DIN-HN	315x410x128mm	<b>590.HEMD8003</b>	<b>590.HGED8003</b>
			BS		<b>590.HEMB8003</b>	<b>590.HGEB8003</b>
	3P+N		DIN-HN		<b>590.HEMD8005</b> <sup>1</sup>	<b>590.HGED8005</b> <sup>1</sup>
			BS		<b>590.HEMB8005</b> <sup>1</sup>	<b>590.HGEB8005</b> <sup>1</sup>

- <sup>1</sup> With late break and early make neutral pole
- Handle padlockable in OFF only (3 padlocks)
  - Equipped with door interlock
  - Blank sides

1.5



# Switchgears

## ISOLATORS Series

■ Enclosed switch disconnecter [FUSES] >> Surface mounting - Metal version (HR) - High Rating [Fuse DIN-NH]

ISOLATORS Series

590.



For general use [TOP/  
BOTTOM]

For emergency switching  
[TOP/BOTTOM]

SWITCH DISCONNECTOR

IP65

GENERAL

EMERGENCY

Current	Poles	Switch size	Fuse type	Dimension	GENERAL	EMERGENCY
100A	3P	KF2	DIN-HN	300x500x200mm	590.KGED10003	590.KEMD10003
	3P+N				590.KGED10005 <sup>[1]</sup>	590.KEMD10005 <sup>[1]</sup>
125A	3P	KF2	DIN-HN	300x500x200mm	590.KGED12503	590.KEMD12503
	3P+N				590.KGED12505 <sup>[1]</sup>	590.KEMD12505 <sup>[1]</sup>
160A	3P	KF2	DIN-HN	300x500x200mm	590.KGED16003	590.KEMD16003
	3P+N				590.KGED16005 <sup>[1]</sup>	590.KEMD16005 <sup>[1]</sup>
200A	3P	KF3	DIN-HN	400x600x200mm	590.KGED20003	590.KEMD20003
	3P+N				590.KGED20005 <sup>[1]</sup>	590.KEMD20005 <sup>[1]</sup>
250A	3P	KF3	DIN-HN	400x600x200mm	590.KGED25003	590.KEMD25003
	3P+N				590.KGED25005 <sup>[1]</sup>	590.KEMD25005 <sup>[1]</sup>
315A	3P	KF4	DIN-HN	500x700x250mm	590.KGED31503	590.KEMD31503
	3P+N				590.KGED31505 <sup>[1]</sup>	590.KEMD31505 <sup>[1]</sup>
400A	3P	KF4	DIN-HN	500x700x250mm	590.KGED40003	590.KEMD40003
	3P+N				590.KGED40005 <sup>[1]</sup>	590.KEMD40005 <sup>[1]</sup>
630A	3P	KF5	DIN-HN	600x800x300mm	590.KGED63003	590.KEMD63003
	3P+N				590.KGED63005 <sup>[1]</sup>	590.KEMD63005 <sup>[1]</sup>

<sup>[1]</sup> With late break and early make neutral pole

- Handle padlockable in OFF only (3 padlocks)
- TOP/BOTTOM = Top/Bottom connection
- Equipped with door interlock
- Gland plate cable entry

1

INDUSTRY

2

3

4

■ Enclosed switch disconnecter [FUSES] >> Surface mounting - Metal version (HR) - High Rating [Fuse BS]

ISOLATORS Series

590.



For general use [TOP/  
BOTTOM]

For emergency switching  
[TOP/BOTTOM]

SWITCH DISCONNECTOR

IP65

GENERAL

EMERGENCY

Current	Poles	Switch size	Fuse type	Dimension	SWITCH DISCONNECTOR	
					GENERAL	EMERGENCY
100A	3P	KF2	BS	300x500x200mm	590.KGEB10003	590.KEMB10003
	3P+N				590.KGEB10005 <sup>1</sup>	590.KEMB10005 <sup>1</sup>
125A	3P	KF2	BS	300x500x200mm	590.KGEB12503	590.KEMB12503
	3P+N				590.KGEB12505 <sup>1</sup>	590.KEMB12505 <sup>1</sup>
160A	3P	KF2	BS	300x500x200mm	590.KGEB16003	590.KEMB16003
	3P+N				590.KGEB16005 <sup>1</sup>	590.KEMB16005 <sup>1</sup>
200A	3P	KF3	BS	400x600x200mm	590.KGEB20003	590.KEMB20003
	3P+N				590.KGEB20005 <sup>1</sup>	590.KEMB20005 <sup>1</sup>
250A	3P	KF3	BS	400x600x200mm	590.KGEB25003	590.KEMB25003
	3P+N				590.KGEB25005 <sup>1</sup>	590.KEMB25005 <sup>1</sup>
315A	3P	KF4	BS	500x700x250mm	590.KGEB31503	590.KEMB31503
	3P+N				590.KGEB31505 <sup>1</sup>	590.KEMB31505 <sup>1</sup>
400A	3P	KF4	BS	500x700x250mm	590.KGEB40003	590.KEMB40003
	3P+N				590.KGEB40005 <sup>1</sup>	590.KEMB40005 <sup>1</sup>
630A	3P	KF5	BS	600x800x300mm	590.KGEB63003	590.KEMB63003
	3P+N				590.KGEB63005 <sup>1</sup>	590.KEMB63005 <sup>1</sup>

- <sup>1</sup> With late break and early make neutral pole
- Handle padlockable in OFF only (3 padlocks)
  - TOP/BOTTOM = Top/Bottom connection
  - Equipped with door interlock
  - Gland plate cable entry

1.5



# Switchgears

## ISOLATORS Series

■ Enclosed switch disconnecter [FUSES] >> Surface mounting - Metal version (HR) - High Rating

ISOLATORS Series

590.



For general use  
[BOTTOM/BOTTOM]

SWITCH DISCONNECTOR

IP65

GENERAL

Current	Poles	Switch size	Fuse type	Dimension	
100A	3P	KF1	DIN-HN	300x500x200mm	<b>590.KGED10003B</b>
			BS		<b>590.KGEB10003B</b>
	3P+N		DIN-HN		<b>590.KGED10005B</b> <sup>[1]</sup>
			BS		<b>590.KGEB10005B</b> <sup>[1]</sup>
125A	3P		DIN-HN		<b>590.KGED12503B</b>
			BS		<b>590.KGEB12503B</b>
	3P+N		DIN-HN		<b>590.KGED12505B</b> <sup>[1]</sup>
			BS		<b>590.KGEB12505B</b> <sup>[1]</sup>
160A	3P	KF2	DIN-HN	400x600x250mm	<b>590.KGED16003B</b>
			BS		<b>590.KGEB16003B</b>
	3P+N		DIN-HN		<b>590.KGED16005B</b> <sup>[1]</sup>
			BS		<b>590.KGEB16005B</b> <sup>[1]</sup>
200A	3P		DIN-HN		<b>590.KGED20003B</b>
			BS		<b>590.KGEB20003B</b>
	3P+N		DIN-HN		<b>590.KGED20005B</b> <sup>[1]</sup>
			BS		<b>590.KGEB20005B</b> <sup>[1]</sup>
250A	3P	DIN-HN	<b>590.KGED25003B</b>		
		BS	<b>590.KGEB25003B</b>		
	3P+N	DIN-HN	<b>590.KGED25005B</b> <sup>[1]</sup>		
		BS	<b>590.KGEB25005B</b> <sup>[1]</sup>		

<sup>[1]</sup> With late break and early make neutral pole

- Handle padlockable in OFF only (3 padlocks)
- BOTTOM/BOTTOM = Bottom/Bottom connection with busbar
- Equipped with door interlock
- Gland plate cable entry



I-O-II  
Change-Over Switches [I-O-II]

■ Enclosed change-over switch disconnectors >> Surface mounting - Thermoplastic version

ISOLATORS Series

590.



For general use [I-O-II]

ENCLOSED CHANGE OVER SWITCH

IP55

IP65

GENERAL

Current	Poles	Switch size	Dimension				
16A	3P	C1	155x210x107mm		<b>590.GE1603-C</b> <sup>5</sup> <sup>6</sup> 1/5		
	3P+N				<b>590.GE1605-C</b> <sup>5</sup> <sup>4</sup> <sup>6</sup> 1/5		
25A	3P				<b>590.GE2503-C</b> <sup>5</sup> <sup>6</sup> 1/5		
	3P+N				<b>590.GE2505-C</b> <sup>5</sup> <sup>4</sup> <sup>6</sup> 1/5		
32A	3P				<b>590.GE3203-C</b> <sup>5</sup> <sup>6</sup> 1/5		
	3P+N				<b>590.GE3205-C</b> <sup>5</sup> <sup>4</sup> <sup>6</sup> 1/5		
40A	3P				<b>590.GE4003-C</b> <sup>5</sup> <sup>6</sup> 1/5		
	3P+N				<b>590.GE4005-C</b> <sup>5</sup> <sup>4</sup> <sup>6</sup> 1/5		
63A	3P			C2	228x308x128mm	<b>590.GE6303-C</b> <sup>1</sup> <sup>2</sup> <sup>3</sup> 1	
	3P+N					<b>590.GE6305-C</b> <sup>1</sup> <sup>2</sup> <sup>4</sup> <sup>3</sup> 1	
80A	3P					<b>590.GE8003-C</b> <sup>1</sup> <sup>2</sup> <sup>3</sup> 1	
	3P+N					<b>590.GE8005-C</b> <sup>1</sup> <sup>2</sup> <sup>4</sup> <sup>3</sup> 1	
100A	3P	<b>590.GE10003-C</b> <sup>1</sup> <sup>2</sup> <sup>3</sup> 1					
	3P+N	<b>590.GE10005-C</b> <sup>1</sup> <sup>2</sup> <sup>4</sup> <sup>3</sup> 1					
125A	3P	C3	308x388x128mm			<b>590.GE12503-C</b> <sup>1</sup> <sup>2</sup> <sup>3</sup> 1	
	3P+N					<b>590.GE12505-C</b> <sup>1</sup> <sup>2</sup> <sup>4</sup> <sup>3</sup> 1	
160A	3P					<b>590.GE16003-C</b> <sup>1</sup> <sup>2</sup> <sup>3</sup> 1	
	3P+N					<b>590.GE16005-C</b> <sup>1</sup> <sup>2</sup> <sup>4</sup> <sup>3</sup> 1	

- <sup>1</sup> Handle padlockable in OFF only (3 padlocks)
- <sup>2</sup> Equipped with door interlock
- <sup>3</sup> Blank sides
- <sup>4</sup> With late break and early make neutral pole
- <sup>5</sup> Handle padlockable in OFF (3 padlocks) and ON (1 padlock) position
- <sup>6</sup> Break-through cable entries

1.5



# Switchgears

## ISOLATORS Series

### Enclosed change-over switch disconnectors >> Surface mounting - Aluminium version

ISOLATORS Series

590.



For general use [I-O-II]

ENCLOSED CHANGE OVER SWITCH

IP65

GENERAL

Current	Poles	Switch size	Dimension				
16A	3P	C1	150x210x107mm	<b>590.HGE1603-C</b> <sup>[5][6]</sup>	1/5		
	3P+N			<b>590.HGE1605-C</b> <sup>[5][4][6]</sup>	1/5		
25A	3P			<b>590.HGE2503-C</b> <sup>[5][6]</sup>	1/5		
	3P+N			<b>590.HGE2505-C</b> <sup>[5][4][6]</sup>	1/5		
32A	3P			<b>590.HGE3203-C</b> <sup>[5][6]</sup>	1/5		
	3P+N			<b>590.HGE3205-C</b> <sup>[5][4][6]</sup>	1/5		
40A	3P			<b>590.HGE4003-C</b> <sup>[5][6]</sup>	1/5		
	3P+N			<b>590.HGE4005-C</b> <sup>[5][4][6]</sup>	1/5		
63A	3P			C2	264x315x122mm	<b>590.HGE6303-C</b> <sup>[1][2][3]</sup>	1
	3P+N					<b>590.HGE6305-C</b> <sup>[1][2][4][3]</sup>	1
80A	3P					<b>590.HGE8003-C</b> <sup>[1][2][3]</sup>	1
	3P+N					<b>590.HGE8005-C</b> <sup>[1][2][4][3]</sup>	1
100A	3P	<b>590.HGE10003-C</b> <sup>[1][2][3]</sup>	1				
	3P+N	<b>590.HGE10005-C</b> <sup>[1][2][4][3]</sup>	1				
125A	3P	C3	315x410x128mm	<b>590.HGE12503-C</b> <sup>[1][2][3]</sup>	1		
	3P+N			<b>590.HGE12505-C</b> <sup>[1][2][4][3]</sup>	1		
160A	3P			<b>590.HGE16003-C</b> <sup>[1][2][3]</sup>	1		
	3P+N			<b>590.HGE16005-C</b> <sup>[1][2][4][3]</sup>	1		

- [1] Handle padlockable in OFF only (3 padlocks)
- [2] Equipped with door interlock
- [3] Blank sides
- [4] With late break and early make neutral pole
- [5] Handle padlockable in OFF (3 padlocks) and ON (1 padlock) position
- [6] Open threaded cable entry with cap / cable sleeve



I-O-II  
Change-Over Switches [I-O-II]



■ Enclosed change-over switch disconnectors >> Surface mounting - Stainless steel version

ISOLATORS Series

590.



For general use [I-O-II]

ENCLOSED CHANGE OVER SWITCH

IP65

GENERAL

Current	Poles	Switch size	Dimension			
16A	3P	C1	226x306x115mm	<b>590.SGE1603-C</b>	1/12	
	3P+N			<b>590.SGE1605-C<sup>1</sup></b>	1/12	
25A	3P			<b>590.SGE2503-C</b>	1/12	
	3P+N			<b>590.SGE2505-C<sup>1</sup></b>	1/12	
32A	3P			<b>590.SGE3203-C</b>	1/12	
	3P+N			<b>590.SGE3205-C<sup>1</sup></b>	1/12	
40A	3P		C2	226x306x115mm	<b>590.SGE4003-C</b>	1/12
	3P+N				<b>590.SGE4005-C<sup>1</sup></b>	1/12
63A	3P				<b>590.SGE6303-C</b>	1/12
	3P+N				<b>590.SGE6305-C<sup>1</sup></b>	1/12
80A	3P				<b>590.SGE8003-C</b>	1/12
	3P+N				<b>590.SGE8005-C<sup>1</sup></b>	1/12
100A	3P	C3	312x412x115mm	<b>590.SGE10003-C</b>	1/12	
	3P+N			<b>590.SGE10005-C<sup>1</sup></b>	1/12	
125A	3P			<b>590.SGE12503-C</b>	1/12	
	3P+N			<b>590.SGE12505-C<sup>1</sup></b>	1/12	
160A	3P			<b>590.SGE16003-C</b>	1/12	
	3P+N			<b>590.SGE16005-C<sup>1</sup></b>	1/12	

- <sup>1</sup> With late break and early make neutral pole
- Handle padlockable in OFF only (3 padlocks)
  - Equipped with door interlock
  - Blank sides

1.5



# Switchgears

## ISOLATORS Series

### Switch-disconnectors IP65

#### ISOLATORS Series

590.



1  
INDUSTRY



Description	Switch size	Suitable for	Accessoires: dook-locking	
DOOR-LOCKING KIT	Y1	THERMOPLASTIC ENCLOSURES	<b>590.BK040</b>	12
		ALUMINIUM ENCLOSURES	<b>590.BK040H</b>	12
	Y2	THERMOPLASTIC ENCLOSURES	<b>590.BK080</b>	5
		ALUMINIUM ENCLOSURES	<b>590.BK080H</b>	5

2  
3  
4

#### TOP22 Series

590.



Description	Colour	Switch size	Contact blocks	
NC CONTACT		Y1	<b>590.PL004001</b> <sup>[1]</sup>	10/60
		Y2	<b>590.PL004003</b> <sup>[1]</sup>	10
NO CONTACT		Y1	<b>590.PL004002</b> <sup>[2]</sup>	10/60
		Y2	<b>590.PL004004</b> <sup>[2]</sup>	10

[1] NC=Normally closed

[2] NO=Normally open

- Snap catch

■ Switch-disconnectors IP65

TOP22 Series

590.



Description	Switch size	Notes	Contact blocks
CHANGE OVER CONTACT - Break before main contacts	Y3 Y4 Y5 C1 C2 C3	15A 250V~ - 10A 415V~	<b>590.PL005</b> 50

TOP22 Series

590.



Description	Switch size	Contact blocks
AUXILIARY CONTACT 1NA+1NC	KF1 KF2 K2	<b>590.PL006011</b> 10
	KF3 KF5 K3 K5 K6	<b>590.PL006012</b> 10
	KF4 K4	<b>590.PL006013</b> 10
AUXILIARY CONTACT 2NA+2NC	KF1 KF2 K2	<b>590.PL006021</b> 10
	KF3 KF5 K3 K5 K6	<b>590.PL006022</b> 10
	KF4 K4	<b>590.PL006023</b> 10

- Break before main contacts

1.5



# Switchgears

## ISOLATORS Series

### Switch-disconnectors IP65

#### COMMAND Series

590.



1

INDUSTRY

2

3

4

Description	Switch size	Suitable for	Terminal protection cover	
TERMINAL PROTECTION COVER	KF1	TOP TERMINALS	<b>590.KMT11</b>	10
		BOTTOM TERMINALS	<b>590.KMT12</b>	10
	KF2 K2	TOP TERMINALS	<b>590.KMT21</b>	10
		BOTTOM TERMINALS	<b>590.KMT22</b>	10
	KF3 K3	TOP TERMINALS	<b>590.KMT31</b>	10
		BOTTOM TERMINALS	<b>590.KMT32</b>	10
	KF4 K4	TOP TERMINALS	<b>590.KMT41</b>	10
		BOTTOM TERMINALS	<b>590.KMT42</b>	10
	KF5 K5	TOP TERMINALS	<b>590.KMT51</b>	10
		BOTTOM TERMINALS	<b>590.KMT52</b>	10

■ Auxiliary control equipments >> Push buttons

TOP22 Series

590.



Description	Version	Colour	Push buttons - Flush button	
PUSH BUTTON	FLUSH		<b>590.PPRN5</b>	1/10
			<b>590.PPRN8</b>	1/10
			<b>590.PPRN1</b>	1/10
			<b>590.PPRN2</b>	1/10

- Fixing by metal ring nut-hole diameter 22mm.
- Clamping of the baseplate to the equipment by swing lever.
- Provided with contact carrier base plate.

TOP22 Series

590.



Description	Version	Colour	Push buttons - Protruding button	
PUSH BUTTON	PROTRUDING		<b>590.PPSN8</b>	1/10
			<b>590.PPSN1</b>	1/10

1.5



# Switchgears

## TOP22 Series

### Auxiliary control equipments >> Push buttons

TOP22 Series

590.



1

INDUSTRY

Description	Version	Colour	Push buttons - Illuminated flush button	
PUSH BUTTON	ILLUMINATED FLUSH		<b>590.PPRL5</b>	1/10
			<b>590.PPRL2</b>	1/10

2

3

4

- Fixing by metal ring nut-hole diameter 22mm.
- Clamping of the baseplate to the equipment by swing lever.
- Provided with contact carrier base plate.

TOP22 Series

590.



Description	Version	Colour	Ø	Mushroom-head emergency push buttons	
EMERGENCY PUSH BUTTON	RELEASE BY ROTATION		ø40mm	<b>590.PPFN1R4N</b>	1/10
			ø60mm	<b>590.PPFN1R6N</b>	1/10
	RELEASE BY KEY		ø40mm	<b>590.PPFN1C4N</b>	1/10
	WITHOUT LOCKING			<b>590.PPFN1M4N</b>	1/10

- According to EN60418

# Switchgears

## TOP22 Series



### Auxiliary control equipments >> Selectors

TOP22 Series

590.



Description	Version	Colour	Selectors - Key selectors	Selectors - Lever selectors
LEVER SELECTOR	2 PULSE POSITIONS	■		<b>590.PSLN8D2</b> 1/10
	2 STEADY POSITIONS			<b>590.PSLN8D0</b> 1/10
	3 PULSE POSITIONS			<b>590.PSLN8T3</b> 1/10
	3 STEADY POSITIONS			<b>590.PSLN8T0</b> 1/10
KEY SELECTOR	2 STEADY POSITIONS		<b>590.PSCR8DOC</b> <sup>[1]</sup> 10	
	3 STEADY POSITIONS		<b>590.PSCR8TOC</b> <sup>[1]</sup> 10	

[1] Key drawing when on "zero" position

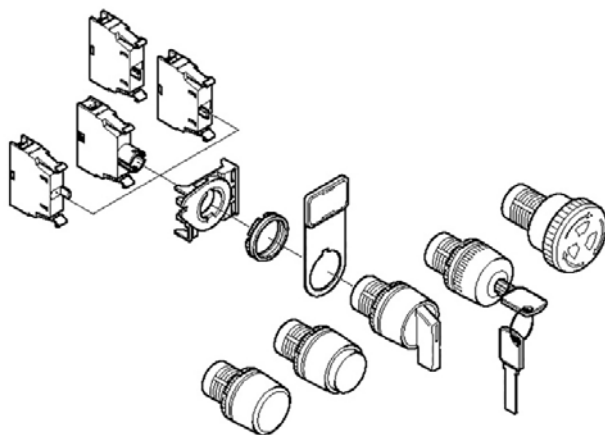

1.5



# Switchgears

## TOP22 Series

### Auxiliary control equipments

TOP22 Series

590.



1

INDUSTRY

Description	Colour	Ø	Notes	Enbloc pilot lamps (LED 220V)	
PILOT LAMP		ø22mm	LED	<b>590.PLML5L220</b>	10
				<b>590.PLML4L220</b>	10
				<b>590.PLML1L220</b>	10
				<b>590.PLML2L220</b>	10
				<b>590.PLML3L220</b>	10

2

3

4

TOP22 Series

590.



Description	Colour	Switch size	Contact blocks	
LAMPHOLDER			<b>590.PL004007</b> <sup>3</sup>	10/60
NC CONTACT		Y1	<b>590.PL004001</b> <sup>1</sup>	10/60
NO CONTACT			<b>590.PL004002</b> <sup>2</sup>	10/60

<sup>1</sup> NC=Normally closed

<sup>2</sup> NO=Normally open

<sup>3</sup> Maximum direct power supply 250V with max 2W bulbs.

- Snap catch





# Switchgears

## TOP22 Series



### Auxiliary control equipments

TOP22 Series	
590.	
	
Description	Accessories
PIN WRENCH	590.PCF 10

TOP22 Series		
590.		
		
Description	Colour	Accessories
LEGEND PLATE		590.PPTN8 10/100

TOP22 Series	
590.	
	
Description	Accessories
NEUTRAL LABEL	590.PTA00 10/100

1.5



# Switchgears

## TOP22 Series

### Auxiliary control equipments

#### TOP22 Series

590.



#### Description

#### Colour

#### Notes

#### Accessories

Description	Colour	Notes	Accessories
EMERGENCY MARKER		ENG	<b>590.PTE/A</b> 10/100
		ITA	<b>590.PTE/I</b> 10/100

#### TOP22 Series

590.



#### Description

#### Colour

#### Ø

#### Accessories

Description	Colour	Ø	Accessories
CAP		ø22mm	<b>590.PTRN8</b> 10/100

#### ENCLOSURES ACCESSORIES

654.



#### Description

#### Flange

#### Suitable for

#### Colour

#### IP

#### Blank plates

Description	Flange	Suitable for	Colour	IP	Blank plates
CUT-OUT PLATE	70x87mm	1 x TOP22		IP66	<b>654.0101Y</b> 25
		2 x TOP22			<b>654.0101</b> 25

- With gasket
- For components TOP22 Series.

# Switchgears TOP22 Series



## Control stations

TOP22 Series

590.



Description	IP	Colour	No. of places	Enclosures
ENCLOSURE	IP65		1 MOD.	<b>590.PR01K</b> 1/12
			2 MOD.	<b>590.PR02K</b> 1/10
			3 MOD.	<b>590.PR03K</b> 1/10
			4 MOD.	<b>590.PR04K</b>
			6 MOD.	<b>590.PR06K</b>

- Empty enclosures for auxiliary control equipment.

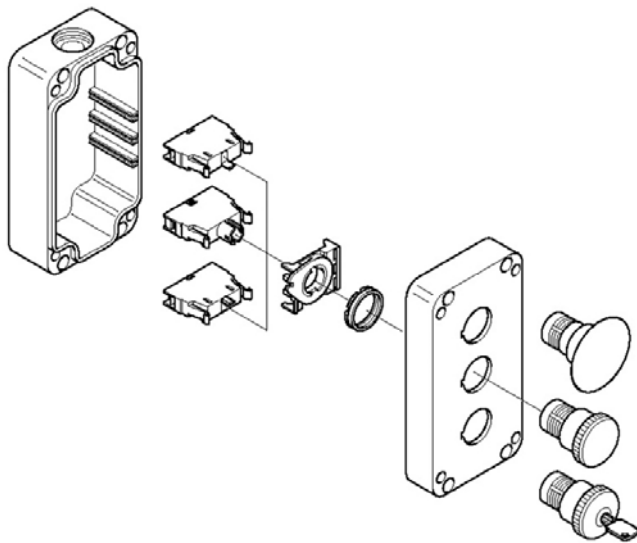

1.5



# Switchgears

## TOP22 Series

### Control stations

1  
INDUSTRY

TOP22 Series

590.



### Complete push-button panel

COMPLETE PUSH BUTTON PANEL

IP65

#### No. of places

No. of places	Model	Quantity
1 MOD.	<b>590.PR01RN8</b>	1/12
2 MOD.	<b>590.PR02A</b>	1/10
3 MOD.	<b>590.PR03A</b>	1/10

- Enclosures complete with control and indicator lamp.

TOP22 Series

590.



### Push-button panel [Ø60-90mm]

COMPLETE PUSH BUTTON PANEL

EMERGENCY PUSH BUTTON

IP65

RELEASE BY ROTATION

UNSTABLE

#### No. of places Ø

No. of places	Ø	Model	Quantity
1 MOD.	Ø60mm	<b>590.PR01R6N</b> <sup>[1][2]</sup>	12
	Ø90mm	<b>590.PG8M9W10</b> <sup>[4][5]</sup>	12
		<b>590.PG1M9W01</b> <sup>[1][2][3]</sup>	12

[1] Supplied with 1 NC contact block.

[2] Mushroom push-buttons for emergency stop

[3] Spring terminals

[4] Enclosures complete with control and indicator lamp.

[5] Supplied with 1 NO contact block.

# Switchgears TOP22 Series



## Control stations

TOP22 Series

590.



Emergency push-button  
panel

EMERGENCY PUSH BUTTON

IP65

No. of places	Notes	RELEASE BY KEY		RELEASE BY ROTATION			
		590.PRO1C4N	1/12	590.PRO1R4N	1/12	590.PRO1R4S	1/12
1 MOD.	VISUAL SIGNAL						

- Supplied with 1 NC contact block.
- Mushroom push-buttons for emergency stop

1.5



1.6

## Empty enclosures

- **DOMINO IP66 Series**  
Consumer units and enclosures
- **DOMINO IP40 Series**  
Consumer units
- **DOMINO System**  
Distribution assemblies - IP66
- **FLAT Series**  
Enclosures
- **BLOCK Series**  
Distribution assemblies - IP66
- **ENERBOX Series**  
Distribution assemblies - IP55
- **ADAPTO Series**  
Adaptors for industrial applications
- **MBOX Series**  
Distribution assemblies for construction site
- **EASYBOX Series**  
Weather-proof enclosures - IP65
- **KIOSK Series**  
Distribution pedestals terminals for campsites, public areas and marinas
- **GOMMA Series**  
Rubber distribution assemblies
- **EMERGENCY Series**  
Emergency switchboards
- **SCABOX Series**  
Surface mounting junction boxes - Metal screws
- **CUBIK Series**  
Surface mounting junction boxes - ¼ turn plastic screw cover
- **CUBOX Series**  
Surface mounting junction boxes - ¼ turn plastic screw cover
- **BEEBOX Series**  
Enclosures
- **WBOX Series**  
Flush mounting boxes
- **ALUBOX Series**  
Aluminium junction boxes







# Empty enclosures DOMINO IP66 Series

■ Consumer units IP66 >> M135

DOMINO IP66 Series [enclosure]

672.



2 DIN

CONSUMER UNIT

SURFACE MOUNTING

IP66

672.2002

1/24

Modularity	No. Modules	Dimension	Power
M135	2 MOD.	135x76x102mm	6W

- Power dissipation calculated in conformity with CEI 23-49 italian standards

DOMINO IP66 Series  
Modularity

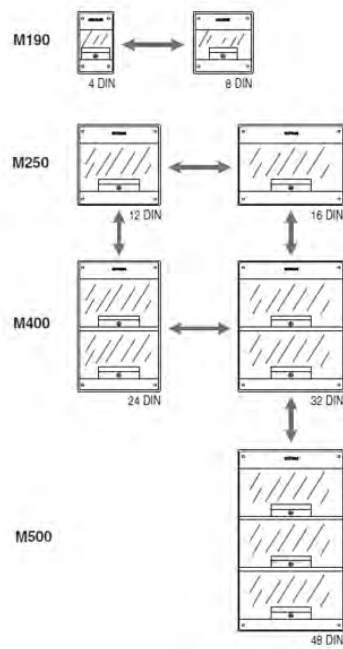

1

INDUSTRY

2

3

4



# Empty enclosures DOMINO IP66 Series



## ■ Consumer units IP66 >> M190

### DOMINO IP66 Series [enclosure]

672.



4 DIN



8 DIN

CONSUMER UNIT

SURFACE MOUNTING

IP66

Modularity	No. Modules	Dimension	Power		
M190	4 MOD.	190x112x106mm	10W	<b>672.2004</b>	1/16
	8 MOD.	190x184x106mm	14W	<b>672.2008</b> <b>672.2008.1101</b> <sup>1</sup>	1/10 1/10

<sup>1</sup>.1101: tinted window (standard) + with label + with triangular key + with IP00 connection device 1(5x10mm<sup>2</sup> - 5x16mm<sup>2</sup>)

- Power dissipation calculated in conformity with CEI 23-49 italian standards

## ■ Consumer units IP66 >> M250

### DOMINO IP66 Series [enclosure]

672.



12 DIN



16 DIN

CONSUMER UNIT

SURFACE MOUNTING

IP66

Modularity	No. Modules	Dimension	Power		
M250	12 MOD.	250x256x140mm	22W	<b>672.2012</b> <b>672.2012.1101</b> <sup>1</sup>	1/9 1/9
	16 MOD.	250x328x140mm	28W	<b>672.2016</b> <b>672.2016.1101</b> <sup>1</sup>	1/6 1/6

<sup>1</sup>.1101: tinted window (standard) + with label + with triangular key + with IP00 connection device 1(5x10mm<sup>2</sup> - 5x16mm<sup>2</sup>)

- Power dissipation calculated in conformity with CEI 23-49 italian standards

1.6



# Empty enclosures

## DOMINO IP66 Series

### Consumer units IP66 >> M400

1  
INDUSTRY

#### DOMINO IP66 Series [enclosure]

672.



24 DIN



32 DIN

CONSUMER UNIT

SURFACE MOUNTING

IP66

Modularity	No. Modules	Dimension	Power		
M400	24 MOD.	400x256x140mm	30W	<b>672.4024</b>	1/6
				<b>672.4024.1102</b> <sup>[1]</sup>	1/6
	32 MOD.	400x328x140mm	47W		<b>672.4032</b> 1/4
					<b>672.4032.1102</b> <sup>[1]</sup> 1/4

[1] .1102: tinted window (standard) + with label + with triangular key + with IP00 connection devices 2(5x10mm<sup>2</sup> - 5x16mm<sup>2</sup>)

- Power dissipation calculated in conformity with CEI 23-49 italian standards

### Consumer units IP66 >> M550

#### DOMINO IP66 Series [enclosure]

672.



48 DIN

CONSUMER UNIT

SURFACE MOUNTING

IP66

Modularity	No. Modules	Dimension	Power		
M550	48 MOD.	550x328x140mm	54W	<b>672.5048</b>	1/3
				<b>672.5048.1102</b> <sup>[1]</sup>	1/3

[1] .1102: tinted window (standard) + with label + with triangular key + with IP00 connection devices 2(5x10mm<sup>2</sup> - 5x16mm<sup>2</sup>)

- Power dissipation calculated in conformity with CEI 23-49 italian standards

# Empty enclosures DOMINO IP66 Series



## ■ Consumer units IP66 >> M700

DOMINO IP66 Series [enclosure]

672.



64 DIN

CONSUMER UNIT

SURFACE MOUNTING

IP66

Modularity	No. Modules	Dimension	Power		
M700	64 MOD.	700x328x140mm	60W	<b>672.7064</b>	1
				<b>672.7064.1102</b> <sup>1</sup>	1

<sup>1</sup>.1102: tinted window (standard) + with label + with triangular key + with IP00 connection devices 2(5x10mm<sup>2</sup> - 5x16mm<sup>2</sup>)

- Power dissipation calculated in conformity with CEI 23-49 italian standards

1.6



# Empty enclosures DOMINO IP66 Series

## ■ Modular enclosures - IP66 >> Enclosures with blank front panel >> M150

DOMINO IP66 Series [enclosure]

672.



**BOX**

MODULAR ENCLOSURE

SURFACE MOUNTING

IP66

Modularity	Dimension	Power		
M150	150x256x115mm	18W	<b>672.1101</b>	6
	150x328x115mm	20W	<b>672.1100</b>	1/6

- Power dissipation calculated in conformity with CEI 23-49 italian standards

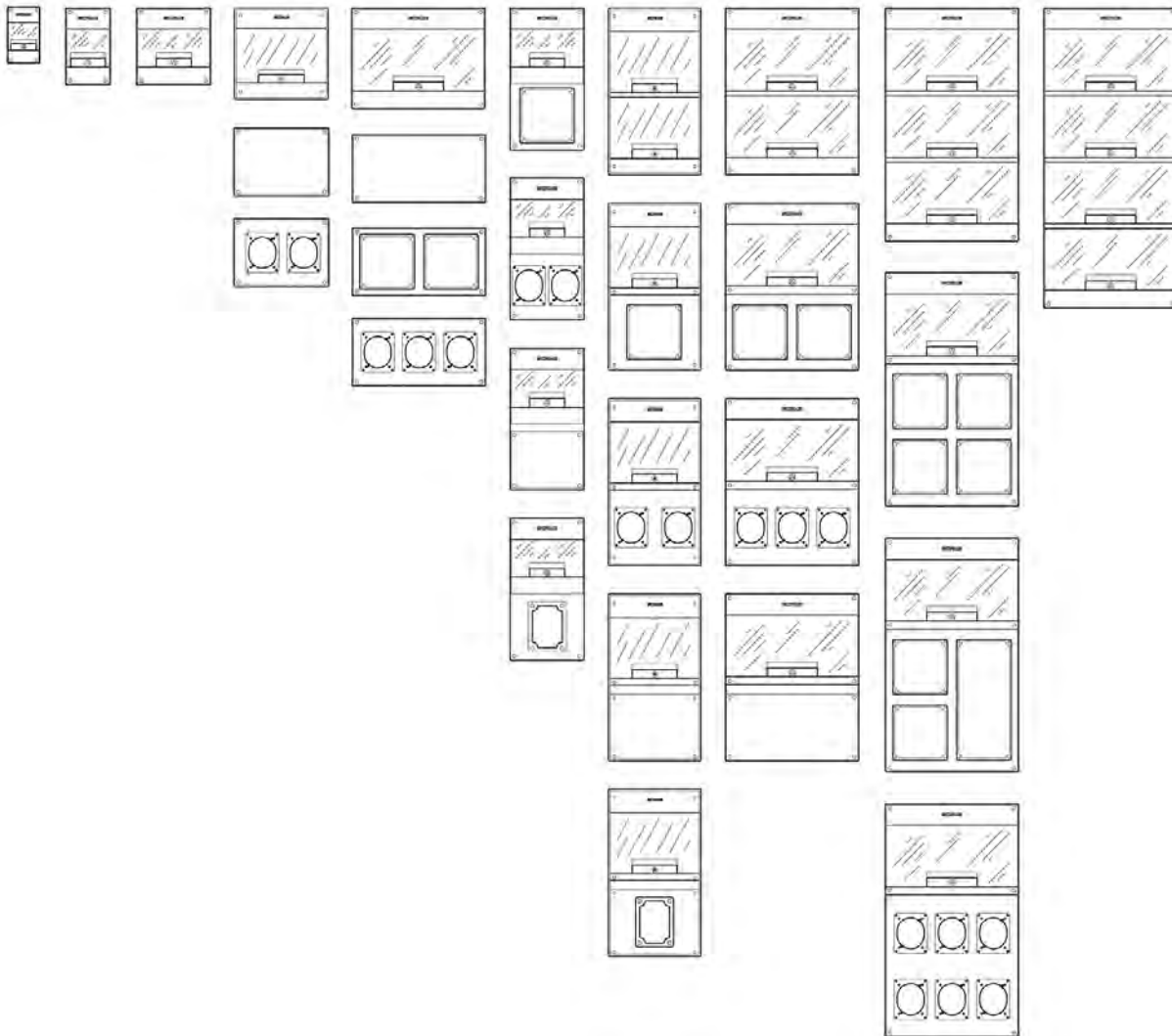

**DOMINO IP66 System**  
Modularity

# Empty enclosures DOMINO IP66 Series



## ■ Modular enclosures - IP66 >> Enclosures with blank front panel >> M340

DOMINO IP66 Series [enclosure]

672.



8 DIN

MODULAR ENCLOSURE

SURFACE MOUNTING

Modularity	No. Modules	Dimension	Power	IP66	
M340	8 MOD.	340x184x106mm	14W	<b>672.2100</b>	1/10

- Power dissipation calculated in conformity with CEI 23-49 italian standards

## ■ Modular enclosures - IP66 >> Enclosures with blank front panel >> M400

DOMINO IP66 Series [enclosure]

672.



12 DIN



16 DIN

MODULAR ENCLOSURE

SURFACE MOUNTING

Modularity	No. Modules	Dimension	Power	IP66	
M400	12 MOD.	400x256x140mm	22W	<b>672.3100</b>	1/6
				<b>672.3100.1102</b> <sup>[1]</sup>	6
	16 MOD.	400x328x140mm	28W	<b>672.4116</b>	1/4

[1].1102: tinted window (standard) + with label + with triangular key + with IP00 connection devices 2(5x10mm<sup>2</sup> - 5x16mm<sup>2</sup>)

- Power dissipation calculated in conformity with CEI 23-49 italian standards

1.6



## Empty enclosures DOMINO IP66 Series

### ■ Modular enclosures - IP66 >> Enclosures with blank front panel >> M550

DOMINO IP66 Series [enclosure]

672.

1

INDUSTRY



16 DIN



24 DIN

MODULAR ENCLOSURE

SURFACE MOUNTING

IP66

Modularity	No. Modules	Dimension	Power			
	16 MOD.	550x328x140mm		<b>672.5116</b>	1/3	
M550	24 MOD.	550x477x150mm	28W			<b>672.5122</b> 3
						<b>672.5122.1102</b> <sup>[1]</sup> 3

[1] .1102: tinted window (standard) + with label + with triangular key + with IP00 connection devices 2(5x10mm<sup>2</sup> - 5x16mm<sup>2</sup>)

- Power dissipation calculated in conformity with CEI 23-49 italian standards

### ■ Modular enclosures - IP66 >> Enclosures with OMNIA Series cutouts >> M150

DOMINO IP66 Series [enclosure]

672.



2 OMNIA

MODULAR ENCLOSURE

SURFACE MOUNTING

IP66

Modularity	Dimension	Power		
M150	150x328x115mm	20W	<b>672.1200</b>	1/6

- Power dissipation calculated in conformity with CEI 23-49 italian standards

# Empty enclosures

## DOMINO IP66 Series



### ■ Modular enclosures - IP66 >> Enclosures with OMNIA Series cutouts >> M340

DOMINO IP66 Series [enclosure]

672.



1 OMNIA - 8 DIN

MODULAR ENCLOSURE

SURFACE MOUNTING

Modularity	No. Modules	Dimension	Power	IP66	
M340	8 MOD.	340x184x106mm	14W	<b>672.2200</b>	1/10

- Power dissipation calculated in conformity with CEI 23-49 italian standards

### ■ Modular enclosures - IP66 >> Enclosures with OMNIA Series cutouts >> M400

DOMINO IP66 Series [enclosure]

672.



1 OMNIA - 12 DIN



2 OMNIA - 16 DIN

MODULAR ENCLOSURE

SURFACE MOUNTING

Modularity	No. Modules	Dimension	Power	IP66	
M400	12 MOD.	400x256x140mm	22W	<b>672.3200</b>	1/6
	16 MOD.	400x328x140mm	28W	<b>672.4216</b>	1/4

- Power dissipation calculated in conformity with CEI 23-49 italian standards

1.6



## Empty enclosures DOMINO IP66 Series

### ■ Modular enclosures - IP66 >> Enclosures with OMNIA Series cutouts >> M550

DOMINO IP66 Series [enclosure]

672.



4 OMNIA - 16 DIN



4 OMNIA + 2 OPTIMA -  
24 DIN

MODULAR ENCLOSURE

SURFACE MOUNTING

IP66

Modularity	No. Modules	Dimension	Power	672.5416	1/3	672.5622 <sup>[1]</sup>	3
M550	16 MOD.	550x328x140mm	28W				
	24 MOD.	550x477x150mm					

[1] With cutouts to contain 4 OMNIA Series 16A or 32A and 2 OPTIMA Series 16A or 32A

- Power dissipation calculated in conformity with CEI 23-49 italian standards
- Connection device to be fixed in the upper side.



#### CombiWizard

ScameOnLine

Discover the new application directly on the web, [www.scame.com/Combiwizard.asp](http://www.scame.com/Combiwizard.asp)  
Identifies the products compatible with pre-drilled enclosures SCAME!

1

INDUSTRY

2

3

4



# Empty enclosures DOMINO IP66 Series



## ■ Modular enclosures - IP66 >> Enclosures with OMNIA Series cutouts >> M550 (63A)

DOMINO IP66 Series [enclosure]

672.



2+1(63A) OMNIA - 16  
DIN



4+1(63A) OMNIA - 24  
DIN

MODULAR ENCLOSURE

SURFACE MOUNTING

IP66

Modularity	No. Modules	Dimension	Power		
M550	16 MOD.	550x328x140mm	28W	<b>672.5316</b> <sup>[1]</sup>	1/3
	24 MOD.	550x477x150mm		<b>672.5522</b> <sup>[2]</sup>	3

[1] With cutouts to contain 2 OMNIA Series 16A or 32A and 1 OMNIA Series 63A.

[2] With cutouts to contain 4 OMNIA Series 16A or 32A and 1 OMNIA Series 63A

- Power dissipation calculated in conformity with CEI 23-49 italian standards
- Connection device to be fixed in the upper side.



**DOMINO IP66 Series**  
Flange 136x125mm (16A/32A)  
Flange 136x275mm (63A)

1.6



## Empty enclosures DOMINO IP66 Series

### ■ Modular enclosures - IP66 >> Enclosures with OPTIMA Series cutouts >> M150

DOMINO IP66 Series [enclosure]

672.



3 SOCKETS



2 SOCKETS

MODULAR ENCLOSURE

SURFACE MOUNTING

IP66

Modularity	Dimension	Power		
M150	150x256x115mm	18W	<b>672.1300</b>	1/6
	150x328x115mm	20W		
			<b>672.1301</b>	6

- Power dissipation calculated in conformity with CEI 23-49 italian standards
- 16A (70x87mm) or, with suitable adaption, 32A socket (84x106mm).

### ■ Modular enclosures - IP66 >> Enclosures with OPTIMA Series cutouts >> M340

DOMINO IP66 Series [enclosure]

672.



2 SOCKETS - 8 DIN



1 SOCKET 32A - 8 DIN

MODULAR ENCLOSURE

SURFACE MOUNTING

IP66

Modularity	No. Modules	Dimension	Power		
M340	8 MOD.	340x184x106mm	14W	<b>672.2300</b> <sup>[1]</sup>	1/10
				<b>672.2301</b> <sup>[2]</sup>	1/10

[1] 16A (70x87mm)

[2] 32A (84x106mm).

- Power dissipation calculated in conformity with CEI 23-49 italian standards

## Empty enclosures DOMINO IP66 Series



### ■ Modular enclosures - IP66 >> Enclosures with OPTIMA Series cutouts >> M400

DOMINO IP66 Series [enclosure]

672.



2 SOCKETS - 12 DIN

1 SOCKET 63A - 12 DIN

3 SOCKETS - 16 DIN

MODULAR ENCLOSURE

SURFACE MOUNTING

Modularity	No. Modules	Dimension	Power	IP66	
M400	12 MOD.	400x256x140mm	22W	<b>672.3300</b> <sup>1</sup> <sup>2</sup>	1/6
	16 MOD.	400x328x140mm	28W	<b>672.3302</b> <sup>3</sup>	1/6
				<b>672.4316</b> <sup>2</sup>	1/4

<sup>1</sup> Connection device to be fixed in the upper side.

<sup>2</sup> 16A (70x87mm) or, with suitable adaption, 32A socket (84x106mm).

<sup>3</sup> 63A (100x110mm)

- Power dissipation calculated in conformity with CEI 23-49 italian standards

### ■ Modular enclosures - IP66 >> Enclosures with OPTIMA Series cutouts >> M550

DOMINO IP66 Series [enclosure]

672.



6 SOCKETS - 16 DIN

8 SOCKETS - 24 DIN

MODULAR ENCLOSURE

SURFACE MOUNTING

Modularity	No. Modules	Dimension	Power	IP66	
M550	16 MOD.	550x328x140mm	28W	<b>672.5616</b>	1/3
	24 MOD.	550x477x150mm		<b>672.5822</b>	3
				<b>672.5822.1102</b> <sup>1</sup>	3

<sup>1</sup> .1102: tinted window (standard) + with label + with triangular key + with IP00 connection devices 2(5x10mm<sup>2</sup> - 5x16mm<sup>2</sup>)

- Power dissipation calculated in conformity with CEI 23-49 italian standards

- 16A (70x87mm) or, with suitable adaption, 32A socket (84x106mm).

1.6



## Empty enclosures DOMINO IP66 Series

### ■ Modular enclosures - IP66 >> Single components >> M150(x256)

DOMINO System

674.



**BASE**

**BLANK COVER**

**2 SOCKETS 70x87MM**

Dimension	WALL MOUNTING BASE	BLANK COVER	COVER WITH OPTIMA CUTOUTS
150x256mm		<b>674.1101</b> 6	<b>674.1301</b> <sup>[1]</sup> 6
150x256x115mm	<b>674.1001</b> 6		

[1] 16A (70x87mm) or, with suitable adaption, 32A socket (84x106mm).

### ■ Modular enclosures - IP66 >> Single components >> M150(x328)

DOMINO System

674.



**BASE**

**BLANK COVER**

**2 OMNIA**

**3 SOCKETS 70x87MM**

Dimension	WALL MOUNTING BASE	BLANK COVER	COVER WITH OMNIA CUTOUTS	COVER WITH OPTIMA CUTOUTS
150x328mm		<b>674.1100</b> 1/6	<b>674.1200</b> 1/6	<b>674.1300</b> <sup>[1]</sup> 1/6
150x328x115mm	<b>674.1000</b> 1/6			

[1] 16A (70x87mm) or, with suitable adaption, 32A socket (84x106mm).

1  
INDUSTRY

2

3

4

# Empty enclosures DOMINO IP40 Series



## ■ Surface mounting version >> Modular consumer units

### DOMINO IP40 Series [surface]

673.



Without window

CONSUMER UNIT

SURFACE MOUNTING

Modularity	No. Modules	Dimension	Power	IP40			
				Code	Ratio	Code	Ratio
2/4 DIN	2/4 MOD.	130x97x84mm	9W	<b>673.2102B</b>	1/36	<b>673.2102</b>	1/36
4 DIN	4+1/2 MOD.	190x135x108mm	11W	<b>673.2104B</b>	1/24	<b>673.2104</b>	1/24
8 DIN	8+2 MOD.	190x254x108mm	18W	<b>673.2108B</b>	1/12	<b>673.2108</b>	1/12
				<b>673.2108B.0012</b> <sup>[1]</sup>	1/10		
12 DIN	12+2 MOD.	250x326x108mm	25W (50W*)	<b>673.2112B</b>	1/7	<b>673.2112</b>	1/7
				<b>673.2112B.0012</b> <sup>[1]</sup>	1/6		
18 DIN	18+2 MOD.	250x434x140mm	43W (85W*)	<b>673.2118B</b>	1/6	<b>673.2118</b>	1/6
				<b>673.2118B.0012</b> <sup>[1]</sup>	1	<b>673.2118.0011</b> <sup>[2]</sup>	1/6
24 DIN	24+4 MOD.	400x326x108mm	41W (87W*)	<b>673.4124B</b>	1/5	<b>673.4124</b>	1/5
				<b>673.4124B.0012</b> <sup>[1]</sup>	1		
36 DIN	36+4 MOD.	400x434x140mm	75W (108W*)	<b>673.4136B</b>	1/4	<b>673.4136</b>	1/4
				<b>673.4136B.0012</b> <sup>[1]</sup>	1		
54 DIN	54+6 MOD.	550x434x140mm	103W (140W*)	<b>673.5154B</b>	1/2	<b>673.5154</b>	1/2
				<b>673.5154B.0012</b> <sup>[1]</sup>	1		

[1] .0012: without label + with IP00 connection devices 2(5x10mm<sup>2</sup> - 5x16mm<sup>2</sup>)

[2] .0011: without label + with IP00 connection device 1(5x10mm<sup>2</sup> - 5x16mm<sup>2</sup>)

- Power dissipation calculated in conformity with CEI 23-49 italian standards

- (\*) Power dissipation calculated when 2 consumer units are on top of each other joined by specially designed accessories.

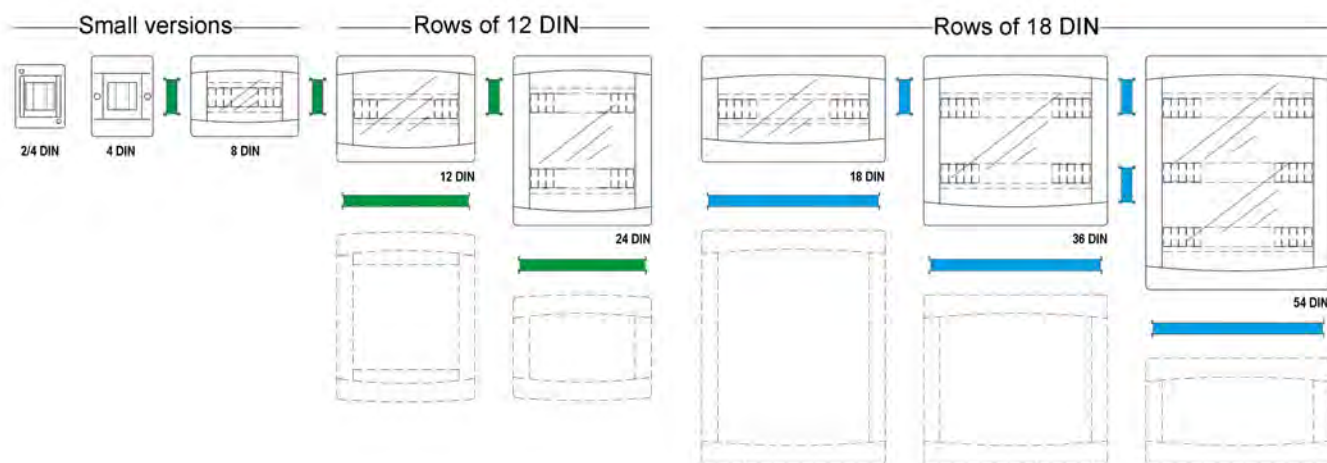

DOMINO IP40 Series  
Modularity

1.6



## Empty enclosures DOMINO IP40 Series

### ■ Surface mounting version >> Modular consumer units

#### DOMINO IP40 Series [surface]

673.



With window

#### CONSUMER UNIT

#### SURFACE MOUNTING

IP40

Modularity	No. Modules	Dimension	Power	IP40			
8 DIN	8+1 MOD.	190x254x108mm	17W	<b>673.2008B</b>	1/12	<b>673.2008</b>	1/12
				<b>673.2008B.2010</b> <sup>[2]</sup>	1/12	<b>673.2008.1102</b> <sup>[1]</sup>	1/12
				<b>673.2008B.2012</b> <sup>[3]</sup>	1/10		
12 DIN	12+1 MOD.	250x326x108mm	24W (48W*)	<b>673.2012B</b>	1/7	<b>673.2012</b>	1/7
				<b>673.2012B.2010</b> <sup>[2]</sup>	1/7	<b>673.2012.1102</b> <sup>[1]</sup>	6
				<b>673.2012B.2012</b> <sup>[3]</sup>	1/6		
18 DIN	18+1 MOD.	250x434x140mm	42W (74W*)	<b>673.2018B</b>	1/6	<b>673.2018</b>	1/6
				<b>673.2018B.2010</b> <sup>[2]</sup>	1/6		
				<b>673.2018B.2012</b> <sup>[3]</sup>	1		
24 DIN	24+4 MOD.	400x326x108mm	35W (63W*)	<b>673.4024B</b>	1/5	<b>673.4024</b>	1/5
				<b>673.4024B.2010</b> <sup>[2]</sup>	1/5		
				<b>673.4024B.2012</b> <sup>[3]</sup>	1		
36 DIN	36+4 MOD.	400x434x140mm	57W (96W*)	<b>673.4036B</b>	1/4	<b>673.4036</b>	1/4
				<b>673.4036B.2010</b> <sup>[2]</sup>	1/4		
				<b>673.4036B.2012</b> <sup>[3]</sup>	1		
54 DIN	54+5 MOD.	550x434x140mm	75W (125W*)	<b>673.5054B</b>	1/2	<b>673.5054</b>	1/2
				<b>673.5054B.2010</b> <sup>[2]</sup>	1/2		
				<b>673.5054B.2012</b> <sup>[3]</sup>	1		

<sup>[1]</sup>.1102: tinted window (standard) + with label + with triangular key + with IP00 connection devices 2(5x10mm<sup>2</sup> - 5x16mm<sup>2</sup>)

<sup>[2]</sup>.2010: white window + without label + without triangular key + without connection device

<sup>[3]</sup>.2012: white window + without label + without triangular key + with IP00 connection devices 2(5x10mm<sup>2</sup> - 5x16mm<sup>2</sup>)

- Power dissipation calculated in conformity with CEI 23-49 italian standards

- (\*) Power dissipation calculated when 2 consumer units are on top of each other joined by specially designed accessories.

1

INDUSTRY

2

3

4

# Empty enclosures DOMINO IP40 Series



## ■ Flush mounting version >> Modular consumer units

### DOMINO IP40 Series [flush]

675.



With window

CONSUMER UNIT

FLUSH MOUNTING

Modularity	No. Modules	Dimension	Power	IP40			
				Product Code	Ratio	Product Code	Ratio
4 DIN	4+1/2 MOD.	180x150x75mm	17W	<b>675.2104B</b> <sup>[4]</sup>	1/38	<b>675.2104</b> <sup>[4]</sup>	1/38
8 DIN	8+1 MOD.	210x254x75mm	21W	<b>675.2008B</b>	1/10	<b>675.2008</b>	1/10
				<b>675.2008B.2010</b> <sup>[2]</sup>	1/10	<b>675.2008.1102</b> <sup>[1]</sup>	1/10
				<b>675.2008B.2012</b> <sup>[3]</sup>	1/6		
12 DIN	12+1 MOD.	270x326x75mm	32W	<b>675.2012B</b>	1/7	<b>675.2012</b>	1/7
				<b>675.2012B.2010</b> <sup>[2]</sup>	1/7	<b>675.2012.1102</b> <sup>[1]</sup>	1/7
				<b>675.2012B.2012</b> <sup>[3]</sup>	1/4		
18 DIN	18+1 MOD.	270x434x75mm	36W	<b>675.2018B</b>	1/7	<b>675.2018</b>	1/7
				<b>675.2018B.2010</b> <sup>[2]</sup>	1/7		
				<b>675.2018B.2012</b> <sup>[3]</sup>	1		
24 DIN	24+4 MOD.	420x326x95mm	52W (74W*)	<b>675.4024B</b>	1/5	<b>675.4024</b>	1/5
				<b>675.4024B.2010</b> <sup>[2]</sup>	1/5		
				<b>675.4024B.2012</b> <sup>[3]</sup>	1		
36 DIN	36+4 MOD.	420x434x95mm	61W	<b>675.4036B</b>	1/3	<b>675.4036</b>	1/3
				<b>675.4036B.2010</b> <sup>[2]</sup>	1/3		
				<b>675.4036B.2012</b> <sup>[3]</sup>	1		
54 DIN	54+3 MOD.	570x434x95mm	71W	<b>675.5054B</b>	1/2	<b>675.5054</b>	1/2
				<b>675.5054B.2010</b> <sup>[2]</sup>	1/2		
				<b>675.5054B.2012</b> <sup>[3]</sup>	1		

[1] .1102: tinted window (standard) + with label + with triangular key + with IP00 connection devices 2(5x10mm<sup>2</sup> - 5x16mm<sup>2</sup>)

[2] .2010: white window + without label + without triangular key + without connection device

[3] .2012: white window + without label + without triangular key + with IP00 connection devices 2(5x10mm<sup>2</sup> - 5x16mm<sup>2</sup>)

[4] Without window.

- Power dissipation calculated in conformity with CEI 23-49 italian standards

- (\*) Power dissipation calculated when 2 consumer units are on top of each other joined by specially designed accessories.

1.6



## Empty enclosures DOMINO System

### Accessories for modular enclosures

1  
INDUSTRY

#### ENCLOSURES ACCESSORIES

654.



Description	Suitable for	Colour	Fixing pole kit	
MOUNTING/FIXING PLATE	DOMINO IP66 M340	■	<b>654.0655</b>	4
	DOMINO IP66 M400		<b>654.0657</b>	1
	DOMINO IP66 M550		<b>654.0652</b>	2
	DOMINO IP66 M700		<b>654.0656</b>	4
METAL POLE	DOMINO IP66		<b>654.0650</b>	1
PLATE WITH PROTECTION ROOF	DOMINO IP66 M400			<b>654.0653</b> 2
	DOMINO IP66 M550			<b>654.0654</b> 2

#### ENCLOSURES ACCESSORIES

654.



Description	Notes	Suitable for	Colour	Wall mounting brackets kit	
WALL MOUNTING BRACKETS KIT	(4 pz.)	DOMINO IP66	■	<b>654.0020</b>	1/10



# Empty enclosures DOMINO System



## Accessories for modular enclosures

### ENCLOSURES ACCESSORIES

654.



Description	Dimension	Suitable for	Zinc-coated steel mounting plate	
MOUNTING PLATE	275x110mm	DOMINO IP66 M190	<b>654.0700</b>	1
	275x180mm	DOMINO IP66 M250	<b>654.0710</b>	<sup>1</sup> <sup>2</sup> 1

<sup>1</sup> Can be mounted in DOMINO IP66 M400 and M550 enclosures

<sup>2</sup> The plate comes with slots for fitting the safety transformer through cable ties (item 654.0210 or 654.0220).

### ENCLOSURES ACCESSORIES

654.



Description	Notes	Suitable for	Colour	Connection kit [DOMINO IP66]	
CONNECTION KIT	PG21	DOMINO IP66		<b>654.0038</b>	25
	PG36			<b>654.0040</b>	1/25

1.6



# Empty enclosures DOMINO System

## Accessories for modular enclosures

### ENCLOSURES ACCESSORIES

654.



1  
INDUSTRY

Description	Notes	Colour	Din	Connection kit [DOMINO IP40 surface mounting]		
CONNECTION KIT	LATERAL.	White	12/24 DIN	<b>654.0041B</b>	6/60	
			18/36/54 DIN	<b>654.0042B</b>	6/60	
		Grey	12/24 DIN	<b>654.0041</b>	6/60	
			18/36/54 DIN	<b>654.0042</b>	6/60	
	TOP-BOTTOM	White	12/24 DIN		<b>654.0043B</b>	6
			18/36/54 DIN		<b>654.0044B</b>	6
		Grey	12/24 DIN		<b>654.0043</b>	6
			18/36/54 DIN		<b>654.0044</b>	6

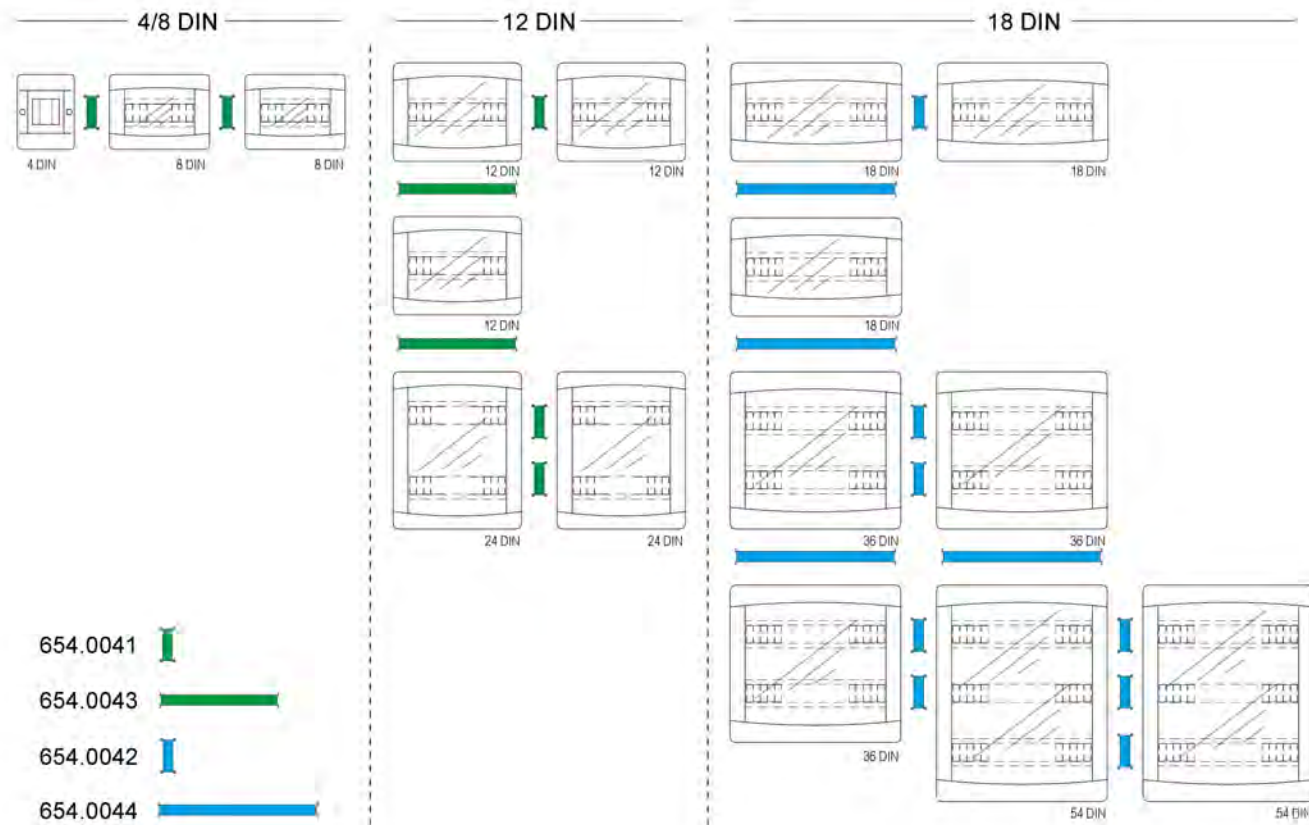

#### DOMINO IP40 Series

- Item 654.0041: coupler for horizontal connection rows of 12 DIN
- Item 654.0043: coupler for vertical connection rows of 12 DIN
- Item 654.0042: coupler for horizontal connection rows of 18 DIN
- Item 654.0044: coupler for vertical connection rows of 18 DIN

# Empty enclosures DOMINO System



## Accessories for modular enclosures

### ENCLOSURES ACCESSORIES

654.



Description	Suitable for	Colour	Connection kit [DOMINO IP40 flush mounting]
ADAPTOR			<b>654.0046</b> 200
CONNECTION KIT	DOMINO IP40 12-24 DIN DOMINO IP40 18-36-54-72 DIN		<b>654.0045</b> 6/72

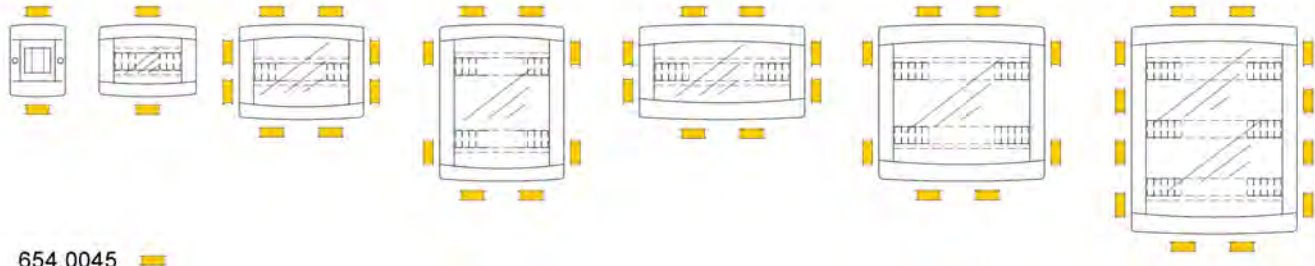

654.0045

#### DOMINO IP40 Series

Modularity  
Item 654.0045: coupler for connection of flush mounting models

1.6



## Empty enclosures DOMINO System

### Accessories for modular enclosures

#### ENCLOSURES ACCESSORIES

654.



Description	Dimension	Suitable for	Stand kit
STAND KIT	320x794x320mm	DOMINO IP66 M550	<b>654.0615</b>
	376x691x70mm	DOMINO IP66 M550 OMNIA	<b>654.0610</b> <sup>1</sup> 1
<sup>1</sup> Folding			



#### MOBIL Series

Support for DOMINO/OMNIA assemblies. The handy folding stand allows the panel to be transported even in limited-size motor vehicles .

1

INDUSTRY

2

3

4

# Empty enclosures DOMINO System



## ■ Accessories for modular enclosures

### ENCLOSURES ACCESSORIES

654.



Description	Suitable for	Colour	Cover sealing kit (2 pieces)	
COVER SEALING KIT	DOMINO IP40		<b>654.0033</b>	1/25
	DOMINO IP66		<b>654.0030</b>	1/25

### ENCLOSURES ACCESSORIES

654.



Description	Suitable for	Yale key kit	
YALE KEY KIT	DOMINO IP40 MBOX (WIN)	<b>654.0072</b> <sup>[2]</sup>	1/10
	DOMINO IP66	<b>654.0070</b> <sup>[1]</sup>	1/10

[1] Unique Yale keys, the same key opens all locks

[2] For DIN window. Unique Yale keys, the same key opens all locks.

- For door (2 pieces).

### ENCLOSURES ACCESSORIES

654.



Description	Suitable for	Handle kit	
HANDLE KIT	DOMINO IP66 GOMMA	<b>654.0060</b>	1/10

1.6



# Empty enclosures DOMINO System

## Accessories for modular enclosures

### ENCLOSURES ACCESSORIES

654.



1  
INDUSTRY

Description	Suitable for	Colour	Ridget profile for DIN rail	
DIN RAIL BRACKET	1 x EVOLUTION 2 x EVOLUTION		<b>654.0091</b>	12/120
RIDGED PROFILE FOR DIN RAIL			<b>654.0090</b>	20/100
				<b>654.0092</b> 12/120

2  
3  
4



**EVOLUTION Series**  
EVOLUTION Series module mounted on DIN rail support

# Empty enclosures DOMINO System



## Accessories for modular enclosures

### ENCLOSURES ACCESSORIES

654.



Description	Notes	Din	DIN rail adjustable height	
DIN RAIL KIT	DOMINO IP66	12 DIN	<b>654.0751</b>	1/10
		16 DIN	<b>654.0750</b>	1/10
		24 DIN	<b>654.0753</b>	10
		2x12 DIN	<b>654.0752</b>	10

- With mounting brackets

### ENCLOSURES ACCESSORIES

654.



Description	Notes	Colour	Din	Blank plate for DIN modules	
BLANK PLATE FOR DIN MODULES	9x45mm		1/2 DIN	<b>654.0420</b> <sup>[1]</sup>	25/400
	18x45mm		1 DIN	<b>654.0410</b> <sup>[1]</sup>	25/250
	70x50mm		4 DIN	<b>654.0400B</b>	25
	72x45mm			<b>654.0400</b>	25

<sup>[1]</sup> To be fixed on DIN rail

- When put between the modular devices these plates help to dissipate heat

1.6



# Empty enclosures DOMINO System

## Accessories for modular enclosures

1  
INDUSTRY

2  
3  
4

### ENCLOSURES ACCESSORIES

654.



Description	Flange	Notes	Colour	IP	Blank plates	
BLANK PLATE FOR PANEL CUT OUTS	70x87mm				<b>654.0100</b>	25
CUT-OUT PLATE		70x87 --> 50x60	■	IP66	<b>654.0103</b>	25
	84x106mm	84x106 --> 75x75			<b>654.0108</b>	5

- With gasket

### ENCLOSURES ACCESSORIES

654.



Description	Flange	Suitable for	Colour	IP	Blank plates [TOP22]	
CUT-OUT PLATE	70x87mm	1 x TOP22	■	IP66	<b>654.0101</b>	25
		2 x TOP22	■		<b>654.0102</b>	25

- With gasket
- For components TOP22 Series.



# Empty enclosures DOMINO System



## Accessories for modular enclosures

### ENCLOSURES ACCESSORIES

654.



Description	Flange	Notes	Colour	IP	Blank plates [OMNIA]	
BLANK PLATE FOR PANEL CUT OUTS		OMNIA			<b>654.0120</b>	6/72
CUT-OUT PLATE	136x125mm	16A [70x87]	■	IP66	<b>654.0125</b>	6/72
		32A [84x106]				

- Covers for OMNIA Series cutouts
- IP66 when coupled with the relevant component

### ENCLOSURES ACCESSORIES

654.



Description	Dimension	Notes	Transformers
SAFETY TOROIDAL TRANSFORMER	Ø170xØ39xh38mm L=270mm	300VA	<b>654.0220</b> 1
	Ø170xØ45xh25mm L=270mm	150VA	<b>654.0210</b> 1

⚡ Safety Extra Low Voltage (SELV).

- Cables: black 220V~, red 24V~.
- F class

1.6



# Empty enclosures DOMINO System

## Accessories for modular enclosures

1  
INDUSTRY

### ENCLOSURES ACCESSORIES

654.

### DOMO Series

570.



Description	Flange	IP	Suitable for	Colour	Domestic kit
FLUSH MOUNTING FRAME	70x87mm	IP55	EVOLUTION	■	<b>570.5052</b> 10/100
			BTICINO		<b>570.5012</b> <sup>[1]</sup> 10/100
COVER WITH INSERT	136x125mm	IP55	EVOLUTION	■	<b>654.0122</b> 6
			BTICINO		<b>654.0121</b> <sup>[1]</sup> 6

<sup>[1]</sup> Manufactured with the authorization from Bticino spa company and is suitable to house "Living International", "Luna", "Light" and "Light Tech" modules which are registered trademarks owned by Bticino.

- Modules snap into place.

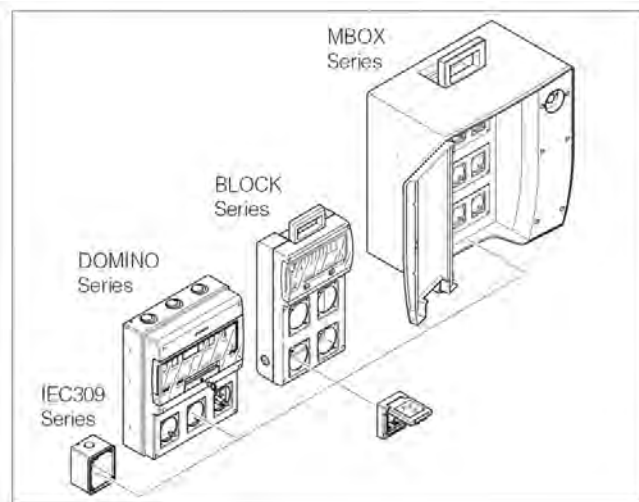

**DOMO Series**  
Examples of installation (flange 70x87mm)

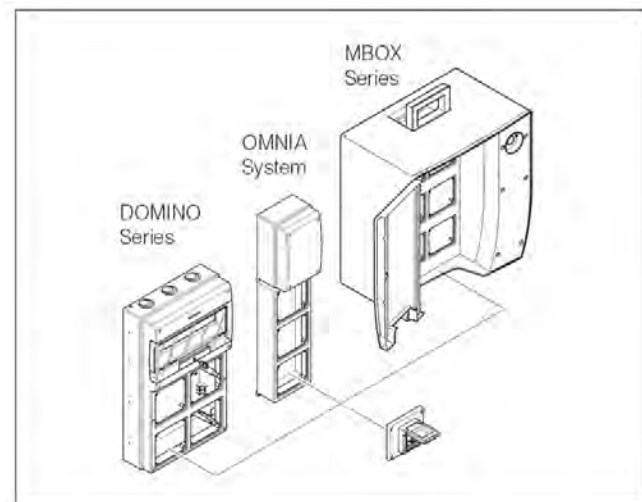

**OMNIA Series**  
Examples of installation (flange 136x125mm)

# Empty enclosures DOMINO System



## DOMINO terminal blocks - T85

### ENCLOSURES ACCESSORIES

654.



Description	Colour	IP	Version	Terminal blocks for DIN rail	
TERMINAL BLOCK	■	IP20	HORIZONTAL VERTICAL	<b>654.0358</b>	1/10
				<b>654.0359</b>	1/10

- Terminals: 1x (5x10mm<sup>2</sup> and 5x16mm<sup>2</sup>).
- Phase R-S-T and earth/neutral terminal blocks

## DOMINO terminal blocks >> Modular terminal blocks - IP20

### ENCLOSURES ACCESSORIES

654.



Description	Suitable for	Colour	IP	x1	
TERMINAL BLOCK	DOMINO IP66 4 DIN DOMINO IP66 8 DIN	■	IP20	<b>654.0363</b>	1/10
				<b>654.0365</b>	10

- Insulated by a plastic cover for the connection of the flexible cables
- For earth, phase and neutral conductors

1.6



## Empty enclosures DOMINO System

### ■ DOMINO terminal blocks >> Modular terminal blocks - IP20

#### ENCLOSURES ACCESSORIES

654.



1

INDUSTRY

Description	Suitable for	Colour	IP	x2
TERMINAL BLOCK	DOMINO IP40 8 DIN DOMINO IP66 12-24 DIN	■	IP20	<b>654.0361</b> <sup>[1]</sup> 1/10 <b>654.0361C</b> <sup>[2]</sup> 10

- [1] There is special left for one additional terminal block
- [2] Complete terminal block, supplied with one additional terminal block art. 654.0360.
- Insulated by a plastic cover for the connection of the flexible cables
  - For earth, phase and neutral conductors

2

3

4

#### ENCLOSURES ACCESSORIES

654.



Description	Suitable for	Colour	IP	x3
TERMINAL BLOCK	DOMINO IP40 12-24 DIN DOMINO IP40 18-36-54-72 DIN DOMINO IP66 16-32-48-64 DIN	■	IP20	<b>654.0362</b> <sup>[1]</sup> 1/10 <b>654.0362C</b> <sup>[2]</sup> 10

- [1] There is special left for two additional terminal blocks
- [2] Complete terminal block, supplied with two additional terminal blocks art. 654.0360.
- Insulated by a plastic cover for the connection of the flexible cables
  - For earth, phase and neutral conductors

# Empty enclosures

## DOMINO System



### ■ DOMINO terminal blocks >> Modular terminal blocks - IP20

#### ENCLOSURES ACCESSORIES

654.



Description	Suitable for	Colour	IP	x4	
TERMINAL BLOCK	DOMINO IP40 18-36-54-72 DIN		IP20	<b>654.0364</b> <sup>[1]</sup>	1/10
				<b>654.0364C</b> <sup>[2]</sup>	10

[1] There is special left for three additional terminal blocks.

[2] Complete terminal block, supplied with three additional terminal blocks Art. 654.0360.

- Insulated by a plastic cover for the connection of the flexible cables
- For earth, phase and neutral conductors

#### ENCLOSURES ACCESSORIES

654.



Description	Notes	Colour	IP	Additional	
TERMINAL BLOCK	EXTRA		IP20	<b>654.0360</b>	1/10

- Insulated by a plastic cover for the connection of the flexible cables
- For earth, phase and neutral conductors

### ■ DOMINO terminal blocks - T85

#### ENCLOSURES ACCESSORIES

654.



Description	Suitable for	IP	Terminal blocks without insulated base - IP00	
TERMINAL BLOCK	DOMINO IP40 MBOX2 MBOX3 BLOCK4	IP00	<b>654.0349</b>	10/100

- Terminals: 1x (5x10mm<sup>2</sup> and 5x16mm<sup>2</sup>).
- Earth/neutral terminal blocks

1.6



# Empty enclosures

## FLAT Series

### Enclosures

#### FLAT Series

677.



GW650°C

GW850°C (suitable for plasterboard walls)

FLAT WALL FLUSH MTG CONS. UNIT

No. Modules	Dimension	Power	IP40	
			Standard	HW
12+2 MOD.	343x368x90mm	25W	<b>677.1012.1</b> <sup>[1]</sup>	<b>677.1012.1-HW</b> <sup>[1]</sup>
24+4 MOD.	443x368x90mm	41W	<b>677.2024.1</b> <sup>[1]</sup>	<b>677.2024.1-HW</b> <sup>[1]</sup>
36+6 MOD.	568x368x90mm	54W	<b>677.3036.2</b> <sup>[2]</sup>	<b>677.3036.2-HW</b> <sup>[2]</sup>
48+8 MOD.	753x368x91mm	75W	<b>677.4048.2</b> <sup>[2]</sup>	<b>677.4048.2-HW</b> <sup>[2]</sup>
60+10 MOD.	878x368x93mm		<b>677.5060.2</b> <sup>[2]</sup>	<b>677.5060.2-HW</b> <sup>[2]</sup>

[1] .1 = 1x terminal block 2x(2x16mm<sup>2</sup> + 14x10mm<sup>2</sup>)

[2] .2 = 2x terminal block 2x(2x16mm<sup>2</sup> + 14x10mm<sup>2</sup>)



**FLAT Series**  
Terminal block 2x(2x16mm<sup>2</sup> + 14x10mm<sup>2</sup>)

# Empty enclosures FLAT Series



## ■ Enclosures

### ENCLOSURES ACCESSORIES

654.



Description	Notes	Accessories and components	
TERMINAL BLOCK	2x25mm <sup>2</sup> + 14x16mm <sup>2</sup>	<b>654.0377</b>	25
YALE KEY KIT	FOR FLAT METAL	<b>654.0074</b>	10
WALL MOUNTING BRACKETS KIT	(4 pz.)	<b>654.0026</b>	15
KIT BRACKETS FOR PLASTER WALL		<b>654.0025</b>	50

1.6



## Empty enclosures BLOCK Series

### Empty enclosures [BLANK PANEL]

BLOCK Series

632.



Description	Installation	IP	Dimension	Power	BLOCK1 - 4 DIN	BLOCK3 - 6 DIN
MODULAR ENCLOSURE	SURFACE MOUNTING	IP66	110x280x95mm	8W	<b>632.1510-000</b> <sup>4</sup>	<b>632.3510-000</b> <sup>4</sup>
			136x440x105mm	9W		
			212x415x105mm	14W		
			272x414x110mm	15W		

- Power dissipation calculated in conformity with CEI 23-49 italian standards

### Empty enclosures [with cutouts 70x87]

BLOCK Series

632.



Description	Installation	IP	Dimension	Power	BLOCK1 - 1 SOCKET - 4 DIN	BLOCK3 - 3 SOCKETS - 6 DIN
MODULAR ENCLOSURE	SURFACE MOUNTING	IP66	110x280x95mm	8W	<b>632.1500-000</b> <sup>1</sup> <sup>4</sup>	<b>632.3500-000</b> <sup>4</sup>
			136x440x105mm	9W		
			212x415x105mm	14W		
			272x414x110mm	15W		

<sup>1</sup> Does not accept COMMAND Series 63A switches and above

- Power dissipation calculated in conformity with CEI 23-49 italian standards
- 70x87mm cut-outs
- (\*) Cut-outs suitable for 32A socket outlets with 84x106 mm flange







# Empty enclosures BLOCK Series







## BLOCK Series

632.

			
<b>BLOCK3</b>	<b>BLOCK4 - 11 DIN</b>	<b>BLOCK4 - 11 DIN - YALE KEY</b>	<b>BLOCK5 - 14 DIN</b>
<b>632.3511-000</b> 4	<b>632.4510-000</b> 4	<b>632.4710-000</b> 4	<b>632.5510-000</b> 2

## BLOCK Series

632.

			
<b>BLOCK3 - 4 SOCKETS</b>	<b>BLOCK4 - 4 SOCKETS - 11 DIN</b>	<b>BLOCK4 - 4 SOCKETS - 11 DIN - YALE KEY</b>	<b>BLOCK5 - 5 SOCKETS - 14 DIN</b>
<b>632.3501-000</b> 4	<b>632.4500-000</b> 4	<b>632.4700-000</b> 4	<b>632.5500-000</b> 2

1.6



# Empty enclosures

## BLOCK Series

### Empty enclosures [with cutouts 70x87 + 50x60]

#### BLOCK Series

632.



Description	Installation	IP	Dimension	Power	BLOCK1 - 3 SOCKETS - 4 DIN	BLOCK3 - 4 SOCKETS - 6 DIN
MODULAR ENCLOSURE	SURFACE MOUNTING	IP66	110x280x95mm	8W	<b>632.1530-000</b> <sup>[1][2]</sup> 4	<b>632.3520-000</b> <sup>[1][2]</sup> 4
			136x440x105mm	9W		
			212x415x105mm	14W		
			272x414x110mm	15W		

[1] 70x87mm cut-outs

[2] (\*) Cut-outs suitable for 32A socket outlets with 84x106 mm flange

- Power dissipation calculated in conformity with CEI 23-49 italian standards
- 50x60 mm cut-outs

### Accessories

#### ENCLOSURES ACCESSORIES

654.



#### Blank plates

Flange	Notes	Colour	IP	BLANK PLATE FOR PANEL CUT OUTS	CUT-OUT PLATE	BLANK PLATE FOR PANEL CUT OUTS
70x87mm	70x87 --> 50x60	■	IP66	<b>654.0100</b> 25	<b>654.0103</b> 25	<b>654.0105</b> 25
50x60mm						

- With gasket

# Empty enclosures BLOCK Series



## BLOCK Series

632.



**BLOCK3 - 6 SOCKETS - 6  
DIN**

**632.3530-000**

4



**BLOCK4 - 5 SOCKETS - 11  
DIN**

**632.4520-000** 1 2

4



**BLOCK4 - 6 SOCKETS - 11  
DIN**

**632.4530-000** 1 2

4



**BLOCK5 - 7 SOCKETS - 14  
DIN**

**632.5520-000** 1

2

1.6



# Empty enclosures

## BLOCK Series

### Accessories

1  
INDUSTRY

#### ENCLOSURES ACCESSORIES

654.



#### Blank plates [TOP22]

Flange	Suitable for	Colour	IP	CUT-OUT PLATE	
70x87mm	1 x TOP22		IP66	<b>654.0101Y</b>	25
	<b>654.0101</b>	25		<b>654.0102</b>	25
	2 x TOP22				
					<b>654.0102</b> 25

- With gasket
- For components TOP22 Series.

#### ENCLOSURES ACCESSORIES

654.



#### Blank plate for DIN modules

Notes	Colour	Din	BLANK PLATE FOR DIN MODULES	
9x45mm		1/2 DIN	<b>654.0420</b> <sup>[1]</sup>	25/400
18x45mm		1 DIN	<b>654.0410</b> <sup>[1]</sup>	25/250
70x50mm		4 DIN	<b>654.0400B</b>	25
72x45mm			<b>654.0400</b>	25

[1] To be fixed on DIN rail

- When put between the modular devices these plates help to dissipate heat

# Empty enclosures BLOCK Series



## ■ Accessories

### ENCLOSURES ACCESSORIES

654.



Description	Suitable for	IP	Terminal blocks without insulated base - IP00
TERMINAL BLOCK	DOMINO IP40 MBOX2 MBOX3 BLOCK4	IP00	<b>654.0349</b> 10/100

- Terminals: 1x (5x10mm<sup>2</sup> and 5x16mm<sup>2</sup>).
- Earth/neutral terminal blocks

### ENCLOSURES ACCESSORIES

654.



Description	Dimension	Notes	Transformers
SAFETY TOROIDAL TRANSFORMER	Ø170xØ39xh38mm L=270mm	300VA	<b>654.0207</b> 1
	Ø170xØ45xh25mm L=270mm	150VA	<b>654.0205</b> 1

- Ⓢ Safety Extra Low Voltage (SELV).
- Cables: black 220V~, red 24V~.
- F class

1.6



# Empty enclosures BLOCK Series

## Accessories

### ENCLOSURES ACCESSORIES

654.



Description	Suitable for	Support kit
SUPPORT	BLOCK4	<b>654.0600</b> 2



**BLOCK Series**  
Support

1

INDUSTRY

2

3

4

# Empty enclosures

## ENERBOX Series



### Empty enclosures [BLANK PANEL]

#### ENERBOX Series

633.



Enclosures 6 DIN



Enclosures 11 DIN

EMPTY ENCLOSURE

SURFACE MOUNTING

IP55

Dimension	Version	Notes	Power		
285x145x107mm	PLAIN	4 DOMO	9W	<b>633.1010</b>	12
285x235x107mm			15W		<b>633.2020</b>

- Side knockouts (DOMO 50x60mm): 4 closed
- Power dissipation calculated in conformity with CEI 23-49 italian standards



#### Side entrances

When fixing the DOMO Series side sockets (50x60 mm), use the special accessory (art. 570.2001)

1.6



## Empty enclosures ENERBOX Series

### Empty enclosures [70x87]

ENERBOX Series

633.



Enclosures 6 DIN

Enclosures 11 DIN

EMPTY ENCLOSURE  
SURFACE MOUNTING  
IP55

Dimension	Notes	Power		
285x145x107mm	4 DOMO + 1x16-32A	9W	<b>633.1013</b>	12
	4 DOMO + 1x63A		<b>633.1014</b>	12
285x235x107mm	4 DOMO + 1x16-32A + 1x63A	15W		<b>633.2026</b> 6
	4 DOMO + 2x16-32A			<b>633.2024</b> 6
	4 DOMO + 2x63A			<b>633.2025</b> 6

- Side knockouts (DOMO 50x60mm): 4 closed
- Power dissipation calculated in conformity with CEI 23-49 italian standards

### Empty enclosures [70x87 + 50x60]

ENERBOX Series

633.



Enclosures 6 DIN

Enclosures 11 DIN

EMPTY ENCLOSURE  
SURFACE MOUNTING  
IP55

Dimension	Notes	Power		
285x145x107mm	4 DOMO + 1x16-32A	9W	<b>633.1011</b>	12
	4 DOMO + 1x63A		<b>633.1012</b>	12
285x235x107mm	4 DOMO + 1x16-32A + 1x63A	15W		<b>633.2023</b> 6
	4 DOMO + 2x16-32A			<b>633.2021</b> 6
	4 DOMO + 2x63A			<b>633.2022</b> 6

- Side knockouts (DOMO 50x60mm): 2 open - 2 closed
- Power dissipation calculated in conformity with CEI 23-49 italian standards

1

INDUSTRY

2

3

4



# Empty enclosures ADAPTO Series



## Empty enclosures

### ADAPTO Series

603.

623.



Description	IP	Notes	Portable or suspended	
MULTI-WAY ADAPTOR	IP44	3x(70x87mm)+2x(50x60mm)	<b>603.3005-000</b>	1/10
	IP66	3x(70x87mm/84x106mm) - 6 DIN	<b>623.3500-000</b>	1/4
		4x(70x87mm/84x106mm)	<b>623.4500-000</b>	1/4

- Zinc-plated steel carrying handle.
- Equipped with PG21 cable gland, cable clamp and terminal block.

### ADAPTO Series

625.



Description	IP	Notes	Elevated installation	
MULTI-WAY ADAPTOR	IP66	3x(70x87mm/84x106mm) - 6 DIN	<b>625.3500-000</b>	1/4
		4x(70x87mm/84x106mm)	<b>625.4500-000</b>	1/4

- Tubular stand to be ordered separately
- Equipped with PG21 cable gland, cable clamp and terminal block.

1.6



# Empty enclosures ADAPTO Series

## Accessories

1

INDUSTRY

### ENCLOSURES ACCESSORIES

692.



Description

Adaptors coupling kit

ADAPTOR COUPLING KIT

692.4342

1/5

- 3-way and 4-way adaptors can be coupled together as shown in the drawing
- The kit includes all the screws, nuts, washers and seals required to couple together 3-way and 4-way adaptors.

2

3

4

### ENCLOSURES ACCESSORIES

692.



Description

Tubular stand

TUBULAR STAND

692.4340

1

### ENCLOSURES ACCESSORIES

654.



Description

Mounting bracket for  
compressed air

PLATE FOR COMP. AIR MOSE

654.0050

10

# Empty enclosures ADAPTO Series



## Accessories

### ENCLOSURES ACCESSORIES

654.



Description	Flange	Notes	Colour	IP	Blank plates	
BLANK PLATE FOR PANEL CUT OUTS	70x87mm		■	IP66	<b>654.0100</b>	25
CUT-OUT PLATE		70x87 --> 50x60			<b>654.0103</b>	25

- With gasket

### ENCLOSURES ACCESSORIES

654.



Description	Flange	Suitable for	Colour	IP	Blank plates [TOP22]	
CUT-OUT PLATE	70x87mm	1 x TOP22	■	IP66	<b>654.0101Y</b>	25
		2 x TOP22	■		<b>654.0101</b>	25
					<b>654.0102</b>	25

- With gasket  
- For components TOP22 Series.

1.6



# Empty enclosures

## MBOX Series

### Empty enclosures [MBOX2]

#### MBOX2 Series

656.



1  
INDUSTRY

Description	Version	Notes	Power	Empty enclosures	Empty enclosures - With emergency push button
EMPTY ENCLOSURE	WITHOUT DOOR	4 OMNIA	27W	<b>656.0024-000</b>	<b>656.0924-000</b>
		4 OMNIA + KIT LUX		<b>656.0024-000L</b> <sup>[1]</sup>	<b>656.0924-000L</b> <sup>[1]</sup>
		6 OPTIMA	29W	<b>656.0026-000</b> <sup>[2]</sup>	<b>656.0926-000</b> <sup>[2]</sup>
		6 OPTIMA + KIT LUX		<b>656.0026-000L</b> <sup>[2][1]</sup>	<b>656.0926-000L</b> <sup>[2][1]</sup>

[1] Complete with lights kit

[2] 16A (70x87mm) or, with suitable adaption, 32A socket (84x106mm).

- Power dissipation calculated in conformity with CEI 23-49 italian standards

2  
3  
4



#### Night & day [Kit LUX]

MBOX turns on a new era with a box that is even more functional and complete. The addition of an automatic device (LED with extremely low consumption hooked up to a sensor) ensures proper lighting of the compartment containing outlets and switch gear and protection devices when the outdoor light intensity diminishes. This allows the product to be identified and used under conditions of poor lighting: ideal for the worksite, MBOX is also perfect for campsites and parking areas. Extremely compact and totally safe, MBOX features an innovative design and it is made in collision-proof and self-extinguishing technopolymer, to withstand collisions and atmospheric agents. In compliance with the highest safety standards, the MBOX series includes a complete product range and comes in many customized versions, with fast delivery.

# Empty enclosures

## MBOX Series



### Empty enclosures [MBOX3]

#### MBOX3 Series

657.



Description	Version	Notes	Empty enclosures	Empty enclosures - With emergency push button
EMPTY ENCLOSURE	WITH DOOR	6 OMNIA	<b>657.0036-000</b> 1	<b>657.0936-000</b> 1
		9 OPTIMA	<b>657.0038-000</b> <sup>1</sup> 1	<b>657.0938-000</b> <sup>1</sup> 1
	WITHOUT DOOR	4+1 63A OMNIA	<b>657.0035-000</b> 1	<b>657.0935-000</b> 1

<sup>1</sup> 16A (70x87mm) or, with suitable adaption, 32A socket (84x106mm).

- Power dissipation calculated in conformity with CEI 23-49 italian standards
- Complete with lights kit

### Empty enclosures [MBOX5]

#### MBOX5 Series

658.



Description	Version	Notes	Empty enclosures	Empty enclosures - With emergency push button
EMPTY ENCLOSURE	WITH DOOR	12 OMNIA	<b>658.0050-000</b> 1	<b>658.0950-000</b> 1

- Power dissipation calculated in conformity with CEI 23-49 italian standards
- Complete with lights kit

1.6



## Empty enclosures MBOX Series

### Accessories for enclosures

1

INDUSTRY

MBOX2 Series

656.

MBOX3 Series

657.

MBOX5 Series

658.



Description	Dimension	Version	Emergency push button kit	
EMERGENCY PUSH BUTTON KIT	MBOX2	WITHOUT DOOR	<b>656.0320</b>	10
	MBOX3	WITH DOOR	<b>657.0340</b>	10
		WITHOUT DOOR	<b>657.0330</b>	10
	MBOX5	WITH DOOR	<b>658.0360</b>	10
WITHOUT DOOR		<b>658.0350</b>	10	

- Emergency push button kit composed of illuminated emergency push button, yellow faceplate with seat for emergency push button, neon lamp 230V~, NO contact and NC contact, lamp holder.

MBOX2 Series

656.



Description	Notes	Suitable for	Emergency push button kit (button)
EMERGENCY PUSH BUTTON KIT	(5 pz.)	MBOX2 MBOX3 MBOX5	<b>656.0300</b>

- Kit made up of pushbutton, contacts and light bulb

# Empty enclosures

## MBOX Series



### Accessories for enclosures

#### MBOX3 Series

657.



#### Disconnecter kit [MBOX3]

Dimension	Notes	Version	ISOLATOR KIT	
MBOX3	100A	WITH DOOR	<b>657.0343</b>	10
		WITHOUT DOOR	<b>657.0333</b>	10
	16-32-40A	WITH DOOR	<b>657.0341</b>	10
		WITHOUT DOOR	<b>657.0331</b>	10
	63-80A	WITH DOOR	<b>657.0342</b>	10
		WITHOUT DOOR	<b>657.0332</b>	10

- Disconnecter kit complete with: yellow faceplate and handle. Suitable for backpanel switches 590.YA... (not provided).

#### MBOX5 Series

658.



#### Disconnecter kit [MBOX5]

Dimension	Notes	Version	ISOLATOR KIT	
MBOX5	100A	WITH DOOR	<b>658.0363</b>	10
		WITHOUT DOOR	<b>658.0353</b>	10
	16-32-40A	WITH DOOR	<b>658.0361</b>	10
		WITHOUT DOOR	<b>658.0351</b>	10
	63-80A	WITH DOOR	<b>658.0362</b>	10
		WITHOUT DOOR	<b>658.0352</b>	10

- Disconnecter kit complete with: yellow faceplate and handle. Suitable for backpanel switches 590.YA... (not provided).

1.6



# Empty enclosures

## MBOX Series

### Accessories for enclosures

1  
INDUSTRY

MBOX2 Series	MBOX3 Series	MBOX5 Series
656.	657.	658.



#### Tinted door kit

2  
3  
4

Notes		DOOR KIT	
FUME'	656.0012	657.0014	658.0016

#### MBOX2 Series

656.



#### Door spare parts (5 pz.)

Suitable for	HINGES KIT	TRIANGULAR LOCK KIT
MBOX2 MBOX3 MBOX5		656.0110 5/10
MBOX3 MBOX5	656.0010 10	

#### MBOX5 Series

658.



Description	Dimension	Plain panel
PLAIN PANEL	MBOX5 WITH DOOR	658.0369 10



# Empty enclosures MBOX Series



## Accessories for enclosures

### ENCLOSURES ACCESSORIES

654.



Description	Suitable for	Yale key kit	
YALE KEY KIT	DOMINO IP40 MBOX (WIN)	<b>654.0072</b> <sup>[1][2]</sup>	1/10
	MBOX3-5 (DOOR)	<b>654.0071</b>	1/10

[1] For DIN window. Unique Yale keys, the same key opens all locks.

[2] For door (2 pieces).

### MBOX2 Series

656.

### MBOX3 Series

657.

### MBOX5 Series

658.



Description	Fuse-testing kit					
FUSE CHECKER	<b>656.0420</b>	10	<b>657.0421</b>	10	<b>658.0422</b>	10

- Fuse-testing kit composed of fuse-testing device (654.0010) and facing with seat for fuse-tester and spare fuses

### MBOX2 Series

656.

### MBOX3 Series

657.



Description	Suitable for	Stand kit	
STAND KIT	MBOX2	<b>656.0120</b>	1
	MBOX3 MBOX5	<b>657.0121</b>	1

1.6



# Empty enclosures

## MBOX Series

### Accessories for enclosures

1

INDUSTRY

#### MBOX2 Series

656.



Description

Turret fixing

TURRET FIXING KIT	<b>656.0220</b>	1		
MOUNTING/FIXING PLATE			<b>656.0222</b>	1
BACK CLOSING PLATE			<b>656.0221</b>	1

2

3

4



**MBOX Series**  
Pedestal application

# Empty enclosures

## MBOX Series



### Accessories for enclosures

#### ENCLOSURES ACCESSORIES

654.



#### Accessories and components

Suitable for	ACCESSORIES KIT	LIGHT KIT FOR MBOX	WALL MOUNTING BRACKETS KIT	CABLE SUPPORT KIT
MBOX2				<b>654.0051</b> 10
MBOX2 MBOX3 MBOX5		<b>654.0003</b> 10	<b>654.0024</b> 10	
MBOX3 MBOX5	<b>654.0002</b> 10			

1 The kit includes: 5x35mm<sup>2</sup> terminal block, M40 cable gland, wall mounting brackets, blank plate for 4 DIN modules.



**MBOX2 Series**  
Wall fixing brackets kit and cable support kit

1.6



# Empty enclosures

## MBOX Series

### Accessories for enclosures

#### ENCLOSURES ACCESSORIES

654.



#### Appliance inlets (kit)

##### APPLIANCE INLET

IP67

Current	Poles	Volt	h		
63A	3P+E	380-415V	6h	<b>654.906396</b>	1
				<b>654.906397</b>	1
125A	3P+N+E	346-415V		<b>654.912597</b>	1

1

INDUSTRY

2

3

4

# Empty enclosures EASYBOX Series



## Enclosures

### EASYBOX Series

655.



Thermoplastic alloy

Stainless steel  
Supplied with blank door  
already mounted

Varnished metal  
[suitable for inside use]

Modularity	Din	Version	Dimension	CABINET					
				Thermoplastic alloy	Stainless steel Supplied with blank door already mounted	Varnished metal [suitable for inside use]			
M320	12 DIN (for row)	TYPE 1	320x370x210mm	655.0010 <sup>[1]</sup>	1	655.02101 <sup>[2]</sup>	1	655.0110 <sup>[1]</sup>	1
		TYPE 2	460x370x245mm	655.0020 <sup>[1]</sup>	1	655.02201 <sup>[2]</sup>	1	655.0120 <sup>[1]</sup>	1
M460	20 DIN (for row)	TYPE 3	460x520x245mm	655.0030 <sup>[1]</sup>	1	655.02301 <sup>[2]</sup>	1	655.0130 <sup>[1]</sup>	1
		TYPE 4	460x670x245mm	655.0040 <sup>[1]</sup>	1	655.02401 <sup>[2]</sup>	1	655.0140 <sup>[1]</sup>	1
M750	35 DIN (for row)	TYPE 5	755x715x345mm	655.0050 <sup>[1]</sup>	1	655.02501 <sup>[2]</sup>	1	655.0150 <sup>[1]</sup>	1

<sup>[1]</sup> Base supplied without door

<sup>[2]</sup> Base supplied with blank door already mounted



### EASYBOX Series

Key:  
LT = Thermoplastic alloy  
MV = Varnished metal  
Al = Stainless steel

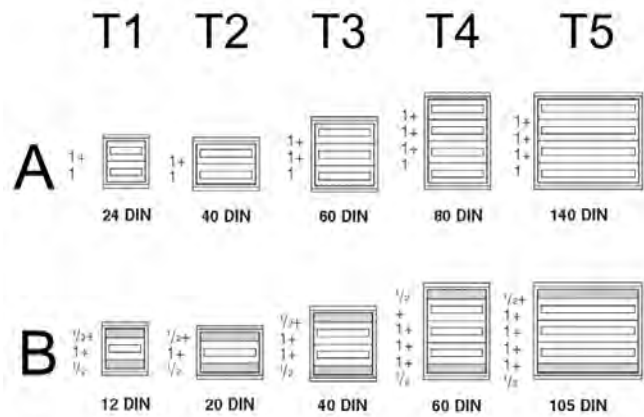

### EASYBOX Series

Possible formats

1.6



# Empty enclosures

## EASYBOX Series

### Enclosures

#### EASYBOX Series

655.



**Thermoplastic alloy -  
Base + door + panels +  
DIN rails**

Modularity	Din	Version	Dimension	CABINET	
M460	20 DIN (for row)	TYPE 2	460x370x245mm	<b>655.0020-K40</b>	1
		TYPE 3	460x520x245mm	<b>655.0030-K60</b>	1
		TYPE 4	460x670x245mm	<b>655.0040-K80</b>	1

### Plain door

#### EASYBOX Series

655.



**Thermoplastic alloy**



**Varnished metal**

Modularity	Version	PLAIN DOOR			
M320	TYPE 1	<b>655.0011</b>	1	<b>655.0111</b>	1
	TYPE 2	<b>655.0021</b>	1	<b>655.0121</b>	1
M460	TYPE 3	<b>655.0031</b>	1	<b>655.0131</b>	1
	TYPE 4	<b>655.0041</b>	1	<b>655.0141</b>	1
M750	TYPE 5	<b>655.0051</b>	1	<b>655.0151</b>	1

# Empty enclosures EASYBOX Series



## ■ Transparent door

EASYBOX Series

655.



Thermoplastic alloy -  
Fumé



Varnished metal - Door  
with marine window

Modularity	Version	DOOR WITH WINDOW			
		Part No.	Qty	Part No.	Qty
M320	TYPE 1	655.0012	1	655.0112	1
	TYPE 2	655.0022	1	655.0122	1
M460	TYPE 3	655.0032	1	655.0132	1
	TYPE 4	655.0042	1	655.0142	1
M750	TYPE 5	655.0052	1	655.0152	1

## ■ Mounting plate and internal door

EASYBOX Series

655.



Mounting plate  
In thermoplastic  
material



Mounting plate  
Stainless steel smooth  
zinc-coated



Internal door  
Blank grey

Modularity	Version	Dimension	MOUNTING PLATE		INTERNAL DOOR	
			Part No.	Qty	Part No.	Qty
M320	TYPE 1	267x294mm	655.0014	1/4	655.0015	1/4
		267x294x4,5mm				
M460	TYPE 2	407x294mm	655.0024	1/4	655.0025	1/4
		407x294x4,5mm				
	TYPE 3	407x444mm	655.0034	1/2	655.0035	1/2
		407x444x4,5mm				
TYPE 4	407x594mm	655.0044	1/2	655.0045	1/2	
	407x594x4,5mm					655.0046
M750	TYPE 5	679x633mm	655.0054	1/2	655.0055	1/2
		679x633x4,5mm				

1.6



# Empty enclosures

## EASYBOX Series

### ■ "Bars up"

EASYBOX Series

655.



"bars up" - Mounting plate



"bars up" - Internal door

Modularity	Version	Dimension	MOUNTING PLATE	INTERNAL DOOR
M750	TYPE 5	267x633x2mm	<b>655.00550</b> 1/5	<b>655.00560</b> 1/4

### ■ Weather-proof enclosures - IP65

EASYBOX Series

655.



Chassis (couple)

Modularity	Version	UPRIGHT
M320 M460	TYPE 1 - 2	<b>655.0019</b> 1/8
M460	TYPE 3	<b>655.0039</b> 1/10
M460 M750	TYPE 4 - 5	<b>655.0059</b> 1/6



## Empty enclosures EASYBOX Series



### ■ Cabinet

#### EASYBOX Series

655.



Modular plates (1 module)



Modular plates (2 modules)

Modularity	Version	MODULAR PLATE	
		Part Number	Quantity
M320	TYPE 1	<b>655.32011</b>	1/8
M460	TYPE 2 - 3 - 4	<b>655.46011</b>	1/8
M750	TYPE 5	<b>655.75011</b>	1/6
		<b>655.32012</b>	1/4
		<b>655.46012</b>	1/4
		<b>655.75012</b>	1/6

- In metal, with brackets.

### ■ Standard panels [DIN]

#### EASYBOX Series

655.



DIN rail



Panel with DIN vent-hole

Modularity	Version	DIN RAIL		PANEL WITH DIN VENT-HOLE	
		Part Number	Quantity	Part Number	Quantity
M320	TYPE 1	<b>655.32010</b>	1/10	<b>655.32020</b>	1/5
M460	TYPE 2 - 3 - 4	<b>655.46010</b>	1/18	<b>655.46020</b>	1/4
M750	TYPE 5	<b>655.75010</b>	1/20	<b>655.75020</b>	1/12

1.6



## Empty enclosures EASYBOX Series

### Standard panels

1  
INDUSTRY

EASYBOX Series

655.



Plain panel 1 module  
h=150mm



Plain panel 1/2 module  
[h=75mm]



Plain panel 1/4 module  
"Sfalsapasso" h=37.5mm  
(2 pc.)

Modularity	Version	PLAIN PANEL					
		Plain panel 1 module h=150mm		Plain panel 1/2 module [h=75mm]		Plain panel 1/4 module "Sfalsapasso" h=37.5mm (2 pc.)	
M320	TYPE 1	<b>655.32021</b>	1/8	<b>655.32022</b> <sup>[1]</sup>	1/10		
M460	TYPE 2 - 3 - 4	<b>655.46021</b>	1/10	<b>655.46022</b> <sup>[1]</sup>	1/10		
M750	TYPE 5	<b>655.75021</b>	1/24	<b>655.75022</b>	1/16	<b>655.75023</b> <sup>[1]</sup>	1/18

[1] 2 parts

### Special panels

EASYBOX Series

655.



Panel for moulded-case  
circuit breaker



Internal door panel with  
lock

Modularity	Version	PANEL FOR MOULDED-CASE CIRCUIT		INTERNAL DOOR PANEL	
M320	TYPE 1	<b>655.32024</b> <sup>[1]</sup>	1/5		
M460	TYPE 2 - 3 - 4	<b>655.46024</b> <sup>[1]</sup>	1/4	<b>655.46025</b>	1/9
M750	TYPE 5	<b>655.75024</b> <sup>[1]</sup>	1/10		

[1] Includes metal plate with DIN rail

# Empty enclosures EASYBOX Series



## ■ Accessories

### EASYBOX Series

655.



Description	Version	Dimension	Pole fixing kit	
POLE FIXING KIT	TYPE 1	max Ø300mm	<b>655.32090</b>	1/3
	TYPE 5		<b>655.75090</b>	1
	TYPE 2 - 3 - 4		<b>655.46090</b>	1/3

### EASYBOX Series

655.



Description	YALE KEY KIT		TRIPLE KEY KIT		Locking kit	
YALE KEY KIT					<b>655.910</b>	1/10
TRIPLE KEY KIT	<b>655.900</b>	10			<b>655.911</b>	1/10

### EASYBOX Series

655.



### Kit accessories

KIT FOR PADLOCKING	KIT BRACKETS	VENTILATION KIT	DOCUMENT HOLDER	METAL FIXING BRACKETS
<b>655.920</b> <sup>1</sup>	<b>655.930</b>	<b>655.950</b>	<b>655.960</b>	<b>655.970</b>
1/10	1/10	1	1/10	1/10

<sup>1</sup> Not suitable for metal doors. Padlock not supplied.

1.6



# Empty enclosures EASYBOX Series

## Accessories

### ENCLOSURES ACCESSORIES

654.



**Blank plate for DIN  
modules**

Notes	Suitable for	Colour	Din	BLANK PLATE FOR DIN MODULES
70x50mm (10pz)	EASYBOX		4 DIN	<b>654.0401</b> 5/20

1

INDUSTRY

2

3

4

# Empty enclosures KIOSK Series



## Empty enclosures [METAL]

### KIOSK Series

659.



Description	IP	Dimension	Version	Type BLOCK
EMPTY PILLAR BLOCK	IP56	400x1250x220mm	SINGLE-FACE	<b>659.BA5040-00</b>

- Pillar only, enclosures to be purchased separately.

### KIOSK Series

659.



Description	IP	Dimension	Version	Type DOMINO
EMPTY PILLAR DOMINO METAL	IP66	487x1235x375mm	SINGLE-FACE	<b>659.DA5041-00</b>
			DOUBLE-FACE	<b>659.DA5081-00</b>
EMPTY PILLAR DOMINO S.STEEL			SINGLE-FACE	<b>659.DB5041-00</b>
			DOUBLE-FACE	<b>659.DB5081-00</b>

- Pillar only, enclosures to be purchased separately.

### KIOSK Series

659.



Description	IP	Dimension	Version	Type MBOX
EMPTY PILLAR MBOX2 METAL	IP56	560x1235x350mm	SINGLE-FACE	<b>659.MA5041-00</b>
EMPTY PILLAR MBOX2 S.STEEL				<b>659.MB5041-00</b>

- Pillar only, enclosures to be purchased separately.

1.6



# Empty enclosures KIOSK Series

## Empty enclosures [PLAST]

KIOSK Series

659.

1

INDUSTRY



Description	IP	Dimension	Type SMART-C
EMPTY PILLAR SMART-C BASE	IP56	580x1400x450mm	<b>659.SCBASE</b>
EMPTY PILLAR SMART-C			

2

3

4

- <sup>1</sup> Structure not pre-drilled for the sockets
- <sup>2</sup> Complete with lights kit



**SMART-C**  
Water service detail

# Empty enclosures KIOSK Series



## Empty enclosures [PLAST]

KIOSK Series

659.



Description	IP	Dimension	Type SMART-K	
EMPTY PILLAR SMART-K	IP56	340x810x260mm	<b>659.SK5041-00</b> <sup>[1]</sup> <sup>[2]</sup>	
EMPTY PILLAR SMART-K BASE			<b>659.SKBASE</b>	

[1] Structure not pre-drilled for the sockets

[2] Complete with lights kit



### SMART-K

Dispensers also available with water service (upon request)

1.6



# Empty enclosures KIOSK Series

## Empty enclosures [PLAST]

KIOSK Series

659.



1  
INDUSTRY

Description	IP	Dimension	Type SMART-X
-------------	----	-----------	--------------

EMPTY PILLAR SMART-X NO LIGHT	IP56	368x980x318mm	<b>659.SX5040-00</b>
-------------------------------	------	---------------	----------------------

- Structure not pre-drilled for the sockets
- Without lights kit

2

3

4

## Empty enclosures [FIRE]

KIOSK Series

659.



Description	IP	Dimension	Version	Notes	Type SMART-C
-------------	----	-----------	---------	-------	--------------

EMPTY PILLAR SMART-C FIRE	IP56	580x1400x450mm	FIRE EXTINGUISHER		<b>659.SCFIRE-E<sup>[1]</sup></b>
			FIRE HOSE	UNI45 - 20m	<b>659.SCFIRE-M<sup>[2]</sup></b>

<sup>[1]</sup> Fire extinguisher not included

<sup>[2]</sup> Fire hose included

KIOSK Series

659.



Description	IP	Dimension	Version	Notes	Type SMART-K
-------------	----	-----------	---------	-------	--------------

EMPTY PILLAR SMART-K FIRE	IP56	340x810x260mm	FIRE EXTINGUISHER		<b>659.SKFIRE-E<sup>[1]</sup></b>
			FIRE HOSE	UNI45 - 20m	<b>659.SKFIRE-M<sup>[2]</sup></b>

<sup>[1]</sup> Fire extinguisher not included

<sup>[2]</sup> Fire hose included



# Empty enclosures GOMMA Series



## ■ Empty enclosures - IP54

GOMMA Series

692.



Type 1

IP	Dimension	DISTRIBUTION ASSEMBLY	
IP54	235x235x180mm	<b>692.4202-00</b>	1
	400x400x275mm	<b>692.4201-00</b>	1



**GOMMA Series**  
Example of panel available in customized configuration.

1.6



# Empty enclosures GOMMA Series

## Empty enclosures - IP54

1

INDUSTRY

### GOMMA Series

692.



Type 3

IP	Dimension	DISTRIBUTION ASSEMBLY	
IP54	270x270x231mm	<b>692.4203-00</b>	1

2

3

4

### GOMMA Series

692.



Type 4

IP	Dimension	DISTRIBUTION ASSEMBLY	
IP54	210x260x98mm	<b>692.4204-00</b>	1
	230x130x70mm	<b>692.4206-00</b>	1
	380x130x83mm	<b>692.4205-00</b>	1

### GOMMA Series

690.

692.



Type A - One front units

Installation	IP	No. Modules	Dimension	Power	DISTRIBUTION ASSEMBLY	SURFACE MOUNTING ENCLOSURE
SURFACE MOUNTING	IP54	12 MOD.	380x260x130mm	20W	<b>690.4200-00</b> <sup>1</sup>	<b>692.4200-00</b>
PORTABLE						1

<sup>1</sup> Complete with handle

# Empty enclosures

## GOMMA Series



### Empty enclosures - IP54

#### GOMMA Series

692.



Type B - Two front units

IP	No. Modules	Dimension	Power	DISTRIBUTION ASSEMBLY	
IP54	8 MOD.	325x260x196mm	14W	<b>692.4300-00</b>	1

### Accessories for enclosures

#### GOMMA Series

692.



Description

Kit tubular stand

TUBULAR STAND	<b>692.4330</b>	1
---------------	-----------------	---

#### ENCLOSURES ACCESSORIES

654.



Description

Suitable for

Handle kit A

HANDLE KIT	DOMINO IP66 GOMMA	<b>654.0060</b>	1/10
------------	-------------------	-----------------	------

1.6



# Empty enclosures GOMMA Series

## Accessories for enclosures

### ENCLOSURES ACCESSORIES

654.



1  
INDUSTRY

2

3

4

Description	Notes	Din	IP	Kit window A	
KIT FOR PADLOCKING				<b>654.0077</b>	10
		8 DIN			<b>654.0141-08</b> 10
	+ KIT DIN	12 DIN			<b>654.0141-12</b> 10
WINDOW KIT		6 DIN	IP65		<b>654.0141-06</b> 10
		8 DIN		<b>654.0140-08</b>	10
		12 DIN		<b>654.0140-12</b>	10
		6 DIN		<b>654.0140-06</b>	10
SCREW KNOBS KIT			<b>654.0140</b>	50	

# Empty enclosures

## EMERGENCY Series



### Emergency switchboards

#### EMERGENCY Series

676.



Description	Colour	Installation	Dimension	Emergency switchboards
ENC. FOR EMERGENCY SYSTEMS		FLUSH MOUNTING	100x100x50mm	<b>676.25100</b> 1/13
<ul style="list-style-type: none"> <li>- With 1 NO contact and 1 NC contact (2A, 250V)</li> <li>- Complete with glass-breaking hammer.</li> <li>- Can be mounted in flush mounting box with centre-to-centre distance 83.5 mm.</li> <li>- With illuminated push button (24V incandescent or 250V fluorescent bayonet lamp -12V).</li> </ul>				

#### EMERGENCY Series

676.



Description	Colour	Installation	Dimension	Emergency switchboards
ENC. FOR EMERGENCY SYSTEMS		SURFACE MOUNTING	100x100x50mm	<b>676.35100</b> 1/14
<ul style="list-style-type: none"> <li>- With 1 NO contact and 1 NC contact (2A, 250V)</li> <li>- Complete with glass-breaking hammer.</li> <li>- With illuminated push button (24V incandescent or 250V fluorescent bayonet lamp -12V).</li> </ul>				

#### EMERGENCY Series

676.



Description	Colour	Installation	Dimension	Notes	Emergency switchboards
ENC. FOR EMERGENCY SYSTEMS		SURFACE MOUNTING	205x220x140mm	6 DIN	<b>676.35201</b> 1/6
<ul style="list-style-type: none"> <li>- Equipped with flange to facilitate junctions.</li> </ul>					

1.6



# Empty enclosures EMERGENCY Series

## Emergency switchboards

EMERGENCY Series

676.



1  
INDUSTRY

Description	Colour	Installation	Dimension	Emergency switchboards
ENC. FOR EMERGENCY SYSTEMS - Equipped with flange to facilitate junctions. - With bottom plate		SURFACE MOUNTING	205x220x140mm	<b>676.35205</b> 1/6

2  
3  
4

EMERGENCY Series

676.



Description	Dimension	Kit accessories
METAL FIXING BRACKETS		<b>676.10103</b> 20
BREAKABLE GLASS	100x100mm	<b>676.10101</b> 10
GLASS BREAKER		<b>676.10102</b> 10

# Empty enclosures

## SCABOX Series



### ■ Junction boxes >> Box with cable sleeves

#### SCABOX Series

680.

685.



Clipped cover



Screw cover

#### JUNCTION BOX

IP55

GW 650°C

Dimension	Cable outlet	Entries				
Ø65x40mm	PG 16	4xØ23mm	<b>680.001</b>	4/100		
Ø80x40mm			<b>680.002</b>	4/100		
80x80x40mm			<b>680.003</b>	4/60		
100x100x50mm	PG 21	6xØ29mm		<b>685.004</b>	1/48	
120x80x50mm				<b>685.005</b>	1/54	
150x110x70mm			10xØ29mm		<b>685.006</b> <sup>[1]</sup>	1/40
190x140x70mm			10xØ38mm		<b>685.007</b> <sup>[1]</sup>	1/24
240x190x90mm	PG 29	12xØ38mm		<b>685.008</b> <sup>[2][1]</sup>	1/12	
300x220x120mm				<b>685.009</b> <sup>[2][1]</sup>	1/6	
380x300x120mm			12xØ48mm		<b>685.010</b> <sup>[2][1]</sup>	1/4
460x380x130mm	PG 36	14xØ48mm		<b>685.011</b> <sup>[2][3]</sup>	1	

[1] It is possible to use the wall mounting brackets kit item 654.0021 (K1)

[2] Suitable for the hinges mounting

[3] It is possible to use the wall mounting brackets kit item 654.0023 (K2)

1.6



## Empty enclosures SCABOX Series

### ■ Junction boxes >> Box with blank sides

1  
INDUSTRY

#### SCABOX Series

686.



IP56 - Lower box - Blank cover



IP56 - Lower box - Clear cover

#### JUNCTION BOX

IP56

GW 650°C

#### Dimension

Dimension	Part Number	Quantity	Part Number	Quantity
100x100x50mm	<b>686.204</b>	1/40	<b>686.224</b>	1/40
120x80x50mm	<b>686.205</b>	1/42	<b>686.225</b>	1/42
150x110x70mm	<b>686.206</b> <sup>[1]</sup>	1/48	<b>686.226</b> <sup>[1]</sup>	1/48
190x140x70mm	<b>686.207</b> <sup>[1]</sup>	1/30	<b>686.227</b> <sup>[1]</sup>	1/30
240x190x90mm	<b>686.208</b> <sup>[2][1]</sup>	1/16	<b>686.228</b> <sup>[2][1]</sup>	1/16
300x220x120mm	<b>686.209</b> <sup>[2][1]</sup>	1/8	<b>686.229</b> <sup>[2][1]</sup>	1/8
380x300x120mm	<b>686.210</b> <sup>[2][1]</sup>	1/4	<b>686.230</b> <sup>[2][1]</sup>	1/4
450x370x130mm	<b>686.211</b> <sup>[2][3]</sup>	1	<b>686.231</b> <sup>[2][3]</sup>	1

[1] It is possible to use the wall mounting brackets kit item 654.0021 (K1)

[2] Suitable for the hinges mounting

[3] It is possible to use the wall mounting brackets kit item 654.0023 (K2)

#### SCABOX Series

686.



IP56 - Higher box - Blank cover



IP56 - Higher box - Clear cover

#### JUNCTION BOX

IP56

GW 650°C

#### Dimension

Dimension	Part Number	Quantity	Part Number	Quantity
100x100x80mm	<b>686.404</b>	1/24	<b>686.424</b>	1/24
240x190x125mm	<b>686.408</b> <sup>[1]</sup>	1/6	<b>686.428</b> <sup>[1]</sup>	1/6
300x220x170mm	<b>686.409</b> <sup>[1]</sup>	1/6	<b>686.429</b> <sup>[1]</sup>	1/6
380x300x170mm	<b>686.410</b> <sup>[1][2]</sup>	1/3	<b>686.430</b> <sup>[1][2]</sup>	1/3
450x370x180mm	<b>686.411</b> <sup>[1][3]</sup>	1	<b>686.431</b> <sup>[1][3]</sup>	1

[1] Suitable for the hinges mounting

[2] It is possible to use the wall mounting brackets kit item 654.0021 (K1)

[3] It is possible to use the wall mounting brackets kit item 654.0023 (K2)



## Empty enclosures SCABOX Series



### ■ Surface mounting junction boxes - Metal screws

#### ENCLOSURES ACCESSORIES

654.



Mounting plate

Dimension	Colour	MOUNTING PLATE	
190x140mm		<b>654.0787</b>	1/30
240x190mm		<b>654.0788</b>	1/20
300x220mm		<b>654.0789</b>	1/15
380x300mm		<b>654.0790</b>	1/10
460x380mm		<b>654.0791</b>	1/10

#### ENCLOSURES ACCESSORIES

654.



Description	Notes	Colour	Wall mounting kit	
FIXING PLUG			<b>654.0022</b> <sup>1</sup>	100/2000
WALL MOUNTING BRACKETS KIT	K1 (4 pz.) K2 (4 pz.)		<b>654.0021</b>	1/10
			<b>654.0023</b>	1/10

<sup>1</sup> Suitable for SCABOX, CUBIK and CUBOX clipped cover box.

1.6



# Empty enclosures

## SCABOX Series

### ■ Surface mounting junction boxes - Metal screws

#### ENCLOSURES ACCESSORIES

654.



1

INDUSTRY

Description	Notes	Colour	Kit accessories	
HINGES KIT			<b>654.0085</b>	1/20
COVER SEALING KIT	MBOX - SCABOX (2 pz.)		<b>654.0032</b>	1/25
SEALING CAPS	(12 pz.)		<b>654.0080</b> <sup>[1]</sup> <sub>[2]</sub>	10/100

[1] For providing total insulation e according to EN 60439-1.

[2] Only for surface mounting enclosure.

2

3

4





HF  
HALOGEN FREE

# Empty enclosures CUBIK Series



## ■ Box with cable sleeves (release cover)

			CUBIK 650 Series		CUBIK 960 Series	
			687.		688.	
						
			 <b>Glow wire 650°C - HALOGEN FREE</b>		<b>Glow wire 960°C</b>	
			JUNCTION BOX			
			IP55			
			GW 650°C		GW 960°C	
Dimension	Cable outlet	Entries				
Ø65x35mm		4xØ23mm	<b>687.001</b>	4/100	<b>688.001</b>	4/100
Ø80x40mm	Ø23MM	4xØ23mm	<b>687.002</b>	4/100	<b>688.002</b>	4/100
80x80x40mm		7xØ23mm	<b>687.003</b>	4/60	<b>688.003.R</b> <sup>1</sup>	4/60

<sup>1</sup> Box base red colored

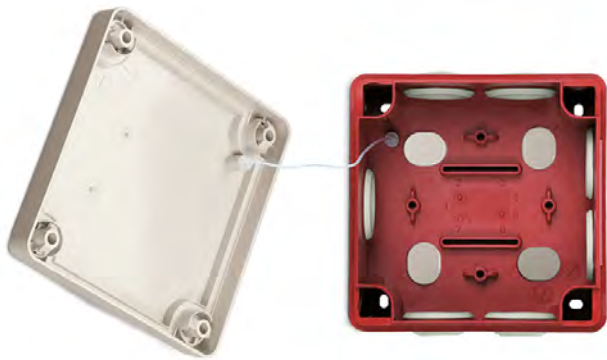

### CUBIK Series

Glow wire 960°C versions (also in red) are identifiable by the symbol marked on the external side.

1.6



# Empty enclosures

## CUBIK Series

### ■ Box with cable sleeves (¼ turn plastic screw cover)

CUBIK 650 Series

687.

CUBIK 960 Series

688.



**HF** HALOGEN FREE  
Glow wire 650°C -  
HALOGEN FREE

Glow wire 960°C

JUNCTION BOX

IP55

GW 650°C

GW 960°C

Dimension	Cable outlet	Entries	GW 650°C		GW 960°C	
100x100x50mm		7xØ29mm	<b>687.004</b>	1/48	<b>688.004.R</b> <sup>[1]</sup>	1/48
120x80x50mm	Ø29MM	6xØ29mm	<b>687.005</b>	1/54	<b>688.005.R</b> <sup>[1]</sup>	1/54
150x110x70mm		10xØ29mm	<b>687.006</b>	1/40	<b>688.006</b>	1/40

[1] Box base red colored



**CUBIK Series**  
Surface mounting junction boxes - ¼ plastic screws - Cable sleeve (insulation perforation)



**HF**  
HALOGEN FREE

# Empty enclosures CUBIK Series



## ■ Box with blank sides (¼ turn plastic screw cover)

	CUBIK 650 Series		CUBIK 960 Series	
	687.		688.	
	<b>Glow wire 650°C - HALOGEN FREE</b>		<b>Glow wire 960°C</b>	
	JUNCTION BOX			
	IP55			
	GW 650°C		GW 960°C	
Dimension				
100x100x50mm	<b>687.204</b>	1/40	<b>688.204.R</b> <sup>1</sup>	1/40
120x80x50mm	<b>687.205</b>	1/42	<b>688.205.R</b> <sup>1</sup>	1/42
150x110x70mm	<b>687.206</b>	1/48	<b>688.206.R</b> <sup>1</sup>	48

<sup>1</sup> Box base red colored

## ■ Surface mounting junction boxes - ¼ turn plastic screw cover

		ENCLOSURES ACCESSORIES	
		654.	
Description	Colour	Kit accessories	
FIXING PLUG		<b>654.0022</b>	100/2000

- Suitable for SCABOX, CUBIK and CUBOX clipped cover box.

1.6



# Empty enclosures

## CUBOX Series

### ■ Surface mounting junction boxes - ¼ turn plastic screw cover

CUBOX Series

689.



Glow wire 650°C -  
Version with cable  
sleeves (Release cover)



Glow wire 650°C -  
Version with cable  
sleeves (¼ turn screw  
cover)



Glow wire 650°C -  
Version with blank sides  
(¼ turn screw cover)

JUNCTION BOX

IP55

GW 650°C

Dimension	Cable outlet	Entries				
Ø65x40mm		4xØ23mm	<b>689.001</b>	4/100		
Ø80x40mm	Ø23MM	4xØ23mm	<b>689.002</b>	4/100		
80x80x40mm		7xØ23mm	<b>689.003</b>	4/60		
100x100x50mm	Ø29MM	7xØ29mm			<b>689.004</b>	48
						<b>689.204</b> 40
120x80x50mm	Ø29MM	6xØ29mm			<b>689.005</b>	54
						<b>689.205</b> 42
150x110x70mm	Ø29MM	10xØ29mm			<b>689.006</b>	40
						<b>689.206</b> 48

1

INDUSTRY

2

3

4

# Empty enclosures BEEBOX Series



## Enclosures

### BEEBOX Series

639.



Description	IP	Colour	Dimension	Enclosures
SURFACE MOUNTING ENCLOSURE	IP41	■	200x150x40mm	<b>639.1040</b> 26
			200x150x60mm	<b>639.1060</b> 38
			200x150x80mm	<b>639.1080</b> 25
			200x300x120mm	<b>639.2120</b> 8
			200x300x40mm	<b>639.2040</b> 24
			200x300x60mm	<b>639.2060</b> 18
			200x300x80mm	<b>639.2080</b> 12
			400x300x120mm	<b>639.4120</b> 4
			400x300x60mm	<b>639.4060</b> 8
			400x300x80mm	<b>639.4080</b> 6



**BEEBOX Series**  
Enclosures (200x150mm - 200x300mm - 400x300mm)

1.6



## Empty enclosures WBOX Series

### ■ Flush mounting boxes

WBOX Series

875.



Description

Colour

Dimension

Telephone flush  
mounting box

FLUSH MOUNTING BOX



70x70mm

**875.4301**

12/60

- Provided complete with box, cover and screws.

### ■ Flush mounting round box ø65mm

WBOX Series

875.



Description

Colour

Dimension

Flush junction boxes

Cover

FLUSH MOUNTING BOX



ø65mm

**875.4201**

500

COVER WITH FASTENERS



ø80mm

**875.4501**

50/600

**875.4502**

40/480

[1] Provided without cover and screw.

[2] Supplied as spare parts.



## Empty enclosures WBOX Series



### ■ Flush mounting box 3 modules

		DATATEL Series		WBOX Series	
		180.		875.	
Description	Colour	Dimension	Cover (screws not included)	Flush mounting junction boxes	Protective cover
SCREW-DOWN COVER		83,5mm	<b>180.692</b> 12/72		
FLUSH MOUNTING BOX				<b>875.4303</b> <sup>1</sup> 6/300	
PROTECTIVE COVER		108x74mm			<b>875.4603</b> <sup>2</sup> <sup>3</sup> 120

<sup>1</sup> Provided without cover and screw.

<sup>2</sup> For 3-module boxes item 875.4303.

<sup>3</sup> Clip cover

### ■ Flush mounting junction boxes - Provided complete with box, cover and screws

		WBOX Series	
		875.	
Description	Colour	Dimension	Flush mounting junction boxes
FLUSH MOUNTING BOX		92x92x45mm	<b>875.4410</b> 1/170
		118x96x50mm	<b>875.4411</b> 1/120
		118x96x70mm	<b>875.4411P</b> 90
		153x98x70mm	<b>875.4412</b> 1/70
		160x130x70mm	<b>875.4413</b> 1/44
		196x152x70mm	<b>875.4414</b> <sup>1</sup> 1/40
		294x152x70mm	<b>875.4415</b> <sup>1</sup> 1/24
		392x152x70mm	<b>875.4416</b> <sup>1</sup> 1/20
		480x160x70mm	<b>875.4417</b> <sup>1</sup> 1/12

<sup>1</sup> Provided without separator.

- Provided complete with box, cover and screws.

1.6



# Empty enclosures

## WBOX Series

■ Flush mounting junction boxes - Provided complete with box, cover and screws

WBOX Series

875.



1

INDUSTRY

Description	Colour	Dimension	Separator
SEPARATOR		152mm	<b>875.4490</b> 25/200
		160mm	<b>875.4491</b> 25/200

- Application: to divide electric circuits.

2

3

4

WBOX Series

875.



Description	Colour	Dimension	Cover (screws not included)
SCREW-DOWN COVER		92x92mm	<b>875.4510</b> 5/100
		118x96mm	<b>875.4511</b> 5/160
		153x98mm	<b>875.4512</b> 5/140
		160x130mm	<b>875.4513</b> 5/80
		196x152mm	<b>875.4514</b> 5/60
		294x152mm	<b>875.4515</b> 2/40
		392x152mm	<b>875.4516</b> 2/30
		480x160mm	<b>875.4517</b> 2/24
SCREWS FOR COVERS		3x19mm	<b>875.4500</b> 1/120

# Empty enclosures

## WBOX Series



■ Flush mounting junction boxes - Provided complete with box, cover and screws

WBOX Series

875.



Description	Colour	Dimension	Protective cover	
PROTECTIVE COVER		92x92mm	<b>875.4610</b>	5/100
		118x96mm	<b>875.4611</b>	5/160
		153x98mm	<b>875.4612</b>	5/140
		160x130mm	<b>875.4613</b>	5/80
		196x152mm	<b>875.4614</b>	5/60
		294x152mm	<b>875.4615</b>	2/40
		392x152mm	<b>875.4616</b>	2/30
		480x160mm	<b>875.4617</b>	2/24

- Clip cover

1.6



# Empty enclosures

## ALUBOX Series

### Aluminium junction boxes

ALUBOX Series

653.



1

INDUSTRY

Description	IP	Colour	Dimension	Enclosures
JUNCTION BOX	IP66	■	100x100x59mm	<b>653.00</b> ☞ 1/32
			140x115x60mm	<b>653.01</b> ☞ 1/24
			166x142x64mm	<b>653.02</b> ☞ 1/16
			192x168x80mm	<b>653.03</b> ☞ 1/12
			253x217x93mm	<b>653.04</b> ☞ 1/6
			314x264x122mm	<b>653.05</b> ☞ 1/2
			410x315x153mm	<b>653.07</b> ☞ 1

☞ Flat head screw

☞ Counter-sunk head screw

- Enclosure and cover in die-cast aluminium.
- Externally varnished
- With stainless steel screws for attaching cover and self-tapping zincoated steel screws for earthing the enclosure and cover.

2

3

4

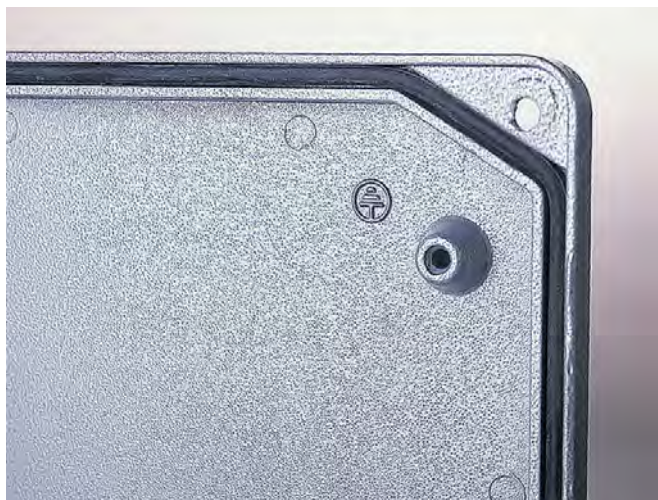

**EPDM**

Holding seal in expanded EPDM, already mounted in place on the cover



**Aluminium**

Enclosures and covers in aluminium alloy with blank walls and covered.

# Empty enclosures

## ALUBOX Series



### Aluminium junction boxes

ALUBOX Series

653.



Description	Colour	Dimension	Mounting plates
MOUNTING PLATE		140x115x60mm	<b>653.011</b> 1/40
		166x142x64mm	<b>653.012</b> 1/20
		192x168x80mm	<b>653.013</b> 1/20
		253x217x93mm	<b>653.014</b> 1/10
		314x264x122mm	<b>653.015</b> 1/10
		410x315x153mm	<b>653.017</b> 1/5

- Zinc-coated steel plate
- With zinc-coated steel self-tapping screws for attaching the plate

ALUBOX Series

653.



Description	Colour	Dimension	DIN RAIL KIT
DIN RAIL KIT		100x100x59mm	<b>653.020</b> 1/25
		140x115x60mm	<b>653.021</b> 1/25
		166x142x64mm	<b>653.022</b> 1/20
		192x168x80mm	<b>653.023</b> 1/25
		253x217x93mm	<b>653.024</b> 1/20
		314x264x122mm	<b>653.025</b> 1/30
		410x315x153mm	<b>653.027</b> 1/50

1.6



1.7

## Light-fittings

- MIZAR Series  
Light-fittings for fixed installations -  
60W
- HYDRA Series  
Light-fittings for fixed installations -  
100W
- HALE Series  
Portable lighting - 60W







# Light-fittings

## MIZAR Series

### Light-fittings for fixed installations - 60W

1

INDUSTRY

#### MIZAR Series

780.



For incandescent lamps  
Thermoplastic diffuser

Lamp power	Lamp holder	Colour	MIZAR Series	
			780.2262	780.2762
60W	B22	[Red Box]	BULKHEAD LIGHT	
	E27		RECTANGULAR	
			IP44	
			12	12

- Thermoplastic diffuser. For continuous use, use the version with polycarbonate diffuser.
- Electric bulb not included.

#### MIZAR Series

781.

786.



For incandescent lamps  
Polycarbonate diffuser

Lamp power	Lamp holder	Colour	MIZAR Series			
			781.		786.	
60W	B22	[Red Box]	BULKHEAD LIGHT			
		TRANSPARENT	RECTANGULAR			
	E27	[Red Box]	IP44	IP55		
		TRANSPARENT	1/12	1/12	1/12	1/12

- Polycarbonate diffuser
- Electric bulb not included.



# Light-fittings

## MIZAR Series



### ■ Light-fittings for fixed installations - 60W

MIZAR Series

781.



Red bulkhead lights for indicating working areas [E27]

IP	Lamp holder	Volt	Cable length	Notes	Colour	BULKHEAD LIGHT	
IP44	E27	24V	10m	x1 LAMP.	■	RECTANGULAR	
			10+6m	x2 LAMP.		<b>781.2761/1</b>	1
			10+6+6+1m	x3 LAMP.		<b>781.2761/2</b>	1
						<b>781.2761/3</b>	1

- Rubber cable, 2x1.5mm<sup>2</sup>.
- Diffuser colour: red.
- Bulb included, E27 25W 24V~.



#### LV-LUX Series

Distribution assemblies for night-time power supply of lights indicating working areas (art. 630.001 / 630.002)

1.7



# Light-fittings

## MIZAR Series

### Light-fittings for fixed installations - 60W

MIZAR Series

786.



**Red bulkhead lights for  
indicating working areas  
[LED+BATTERY]**

BULKHEAD LIGHT

RECTANGULAR

**786.0100**

1/12

IP	Lamp holder	Colour
IP55	LED	Red

Power supply: four 1.5V "AA" batteries (not included).

- Switching on: automatic with twilight switch.
- Double operation: fixed light and flashing with switch that selects the desired function.

1

INDUSTRY

2

3

4

# Light-fittings

## MIZAR Series



### Light-fittings for fixed installations - 60W

MIZAR Series

786.



Red bulkhead lights for indicating working areas [LED]

IP	Lamp holder	Colour	BULKHEAD LIGHT RECTANGULAR	
IP55	LED		<b>786.0200</b> <sup>1</sup>	1/12
			<b>786.0210</b> <sup>2</sup>	1/12
			<b>786.0220</b> <sup>3</sup>	1/12

- <sup>1</sup> Automatic twilight turn-on. Fixed light.
- <sup>2</sup> Automatic twilight turn-on. Two operation modes: fixed light or flashing light. With mode selector switch.
- <sup>3</sup> Direct turn-on (without twilight turn-on) and fixed light
  - With 220V-powered LED flasher.



#### MIZAR Series

MIZAR Series light-fittings are fitted with a slot on the rear of the base for hooking onto a nail, screw or hook, or for fastening to poles, pipes, bars or scaffolding using one or two cable ties.

1.7



# Light-fittings

## HYDRA Series

### Light-fittings for fixed installations - 100W

1  
INDUSTRY

#### HYDRA Series

791.

796.



#### Bulkhead light ROUND

Version	IP	Lamp power	Lamp holder	BULKHEAD LIGHT	
ROUND	IP44	100W	B22	<b>791.12210</b> <sup>[1]</sup>	1/6
			E27	<b>791.12710</b> <sup>[2]</sup>	1/6
	IP65		B22	<b>796.12210</b> <sup>[1]</sup>	1/6
			E27	<b>796.12710</b> <sup>[2]</sup>	1/6

[1] Lampholder in porcelain

[2] Lampholder in resin

- Diffuser and shell in polycarbonate.
- Lighting devices for fixed installation
- Steel screws with galvanised anti-rust treatment.
- Reflecting parabola in aluminium.

#### HYDRA Series

791.

796.



#### Bulkhead light SQUARE

Version	IP	Lamp power	Lamp holder	BULKHEAD LIGHT	
SQUARE	IP44	100W	B22	<b>791.22210</b> <sup>[1]</sup>	1/6
			E27	<b>791.22710</b> <sup>[2]</sup>	1/6
	IP65		B22	<b>796.22210</b> <sup>[1]</sup>	1/6
			E27	<b>796.22710</b> <sup>[2]</sup>	1/6

[1] Lampholder in porcelain

[2] Lampholder in resin

- Diffuser and shell in polycarbonate.
- Lighting devices for fixed installation
- Steel screws with galvanised anti-rust treatment.
- Reflecting parabola in aluminium.

# Light-fittings

## HYDRA Series



### Light-fittings for fixed installations - 100W

#### HYDRA Series

791.

796.



**Bulkhead light OVAL**

Version	IP	Lamp power	Lamp holder	BULKHEAD LIGHT		
OVAL	IP44	100W	B22	<b>791.32210</b> <sup>[1]</sup>	1/6	
			E27	<b>791.32710</b> <sup>[2]</sup>	1/6	
	IP65		B22		<b>796.32210</b> <sup>[1]</sup>	1/6
			E27		<b>796.32710</b> <sup>[2]</sup>	1/6

[1] Lampholder in porcelain

[2] Lampholder in resin

- Diffuser and shell in polycarbonate.
- Lighting devices for fixed installation
- Steel screws with galvanised anti-rust treatment.
- Reflecting parabola in aluminium.

#### HYDRA Series

790.



**Decorative frames**

Version	Colour	FRAME	
ROUND		<b>790.101</b>	1/6
		<b>790.102</b>	1/6
OVAL			<b>790.301</b> 1/6
			<b>790.302</b> 1/6

1.7



# Light-fittings

## HALE Series

### Portable lighting - 60W

#### HALE Series

770.



With protective guard  
and zinc-plated steel  
reflector

#### PORTABLE LAMP

STANDARD LID

HEAVY DUTY

IP20

60W

E27

Plug	Volt	Cable length	Cable	Cable section		
☹	250V	5m	H05VV-F	2x0,75mm <sup>2</sup>	<b>770.207</b>	1/24
		10m			<b>770.208</b>	1/18
		without cable			<b>770.200</b>	1/24
					<b>770.250</b>	1/24

☹ Heavy Duty products are especially suited to greivous working conditions and are also resistant to highly salty environments

- Protective guard that can be opened for light bulb replacement.
- Lighting devices with protective guard and zinc-plated steel reflector:
- Handgrip in insulating, non-hygroscopic thermoplastic material with tilting system that prevents the lamp, when placed on a flat surface, to directly irradiate said surface and thus prevent dangerous overheating.
- Tapered cable gland
- Cable gland
- Adjustable hook.
- Rocker switch and screw clamp for cable replacement.
- For lamps up to 60W (incandescent)
- Screw cable stay.
- Cable H05VV-F (PVC)



2P+E-16A-(S17)

# Light-fittings

## HALE Series



### Portable lighting - 60W

#### HALE Series

770.



With impact-resistant protective diffuser

					PORTABLE LAMP			
					IP65	IP20		
					60W			
					E27			
Plug	Volt	Cable length	Cable	Cable section				
☰	250V	5m	H05VV-F	2x1mm <sup>2</sup>		<b>770.407</b> <sup>1</sup> 1/6		
		10m				<b>770.408</b> <sup>1</sup> 1/6		
IEC309	24V	5m				<b>770.405</b> 1/6		
		10m				<b>770.406</b> 1/6		
	250V	5m				<b>770.409</b> 1/6		
		10m				<b>770.410</b> 1/6		
without cable					<b>770.400</b> 1/6			

<sup>1</sup> The degree of protection IP20 is due to preserve of plug for domestic use, while the apparatus is IP65; for example, if plugged into a socket in the garage the lamp can be used in the garden.

- Protective shell in collision-proof technopolymer
- Lighting devices with protective shell
- Cable H05RN-F (RUBBER)
- Handgrip in non-hygroscopic technopolymer.
- Cable gland
- Reflecting parabola in aluminium.
- Adjustable hook.
- Rocker switch and screw clamp for cable replacement.
- For lamps up to 60W (incandescent)
- Screw cable stay.

1.7



2

# ASSEMBLIES

Combined units



2.1	Distribution assemblies	PAG. 374
2.2	Industrial adaptors	PAG. 424
2.3	Industrial cable reels	PAG. 440

## 2.1

# Distribution assemblies

- **MBOX Series**  
Distribution assemblies for construction site
- **MEGA Series**  
Distribution assemblies for construction site
- **DOMINO Series**  
Distribution assemblies
- **BLOCK Series**  
Distribution assemblies
- **KIOSK Series**  
Distribution pedestals terminals for campsites, public areas and marinas
- **GOMMA Series**  
Rubber distribution assemblies
- **LV-LUX Series**  
Distribution assemblies
- **TRANSFORMER Series**  
ACS IP55 portable unit with safety and isolating transformer
- **MOBIL Series**  
ACS IP55 distribution boxes with foldable stand
- **SALVAMOTORE Series**  
Stop-start units and motor cut-out - IP55
- **Accessories and spare parts**







## Distribution assemblies

### MBOX Series

■ For construction sites >> Interlocked-switch sockets without fuse >> MBOX2

1

2

ASSEMBLIES

3

4

no.	Sockets					General	Max power	MCB	
	16A			32A				16A	
	2P+E	3P+E	3P+N+E	3P+E	3P+N+E			1P	3P
4	2	1	1			MCB 4P 32A RCD 4P 40A 0,03A	18 KW	2	2
4	2	1		1		MCB 4P 32A RCD 4P 40A 0,03A	18 KW	2	1
4	2	2				MCB 4P 32A RCD 4P 40A 0,03A	18 KW	2	2
4	2			1	1	MCB 4P 32A RCD 4P 40A 0,03A	18 KW	2	

1 2m rubber cable H07RN-F

2 Plug IEC309 32A 3P+N+E

■ For construction sites >> Interlocked-switch sockets without fuse >> MBOX3

no.	Sockets				General	Max power	MCB		
	16A		32A				16A		32A
	2P+E	3P+E	3P+N+E	3P+N+E			1P	3P	
4	2	1	1		MCB 4P 63A RCD 4P 63A 0,03A	35 KW	2	1	1
4	2	2			MCB 4P 32A RCD 4P 40A 0,03A	18 KW	2	2	
5	2	2	1		MCB 4P 63A RCD 4P 63A 0,03A	35 KW	2	1	1
5	2	2		1	MCB 4P 63A RCD 4P 63A 0,03A	35 KW	2	1	1
5	3	1	1		MCB 4P 63A RCD 4P 63A 0,03A	35 KW		1	1

1 Appliance inlet IEC309 63A 3P+N+E

- With door



2P+E 16A



3P+E 16A



3P+N+E 16A



3P+E 32A



3P+N+E 32A

# Distribution assemblies

## MBOX Series



### MBOX2 Series

656.



Power supply with terminal block		Power supply with plug		Power supply with plug and emergency push button	
DISTRIBUTION ASSEMBLY (ACS)					
IP66		Plug		IP65	
Supply by terminal block		Plug			
<b>656.7024-056</b>	1	<b>656.7124-056</b> <sup>1</sup> <sub>2</sub>	1		
<b>656.7024-006</b>	1	<b>656.7124-006</b> <sup>1</sup> <sub>2</sub>	1	<b>656.7824-006</b> <sup>1</sup> <sub>2</sub>	1
<b>656.7024-008</b>	1	<b>656.7124-008</b> <sup>1</sup> <sub>2</sub>	1	<b>656.7824-008</b> <sup>1</sup> <sub>2</sub>	1
<b>656.7024-611</b>	1	<b>656.7124-611</b> <sup>1</sup> <sub>2</sub>	1	<b>656.7824-611</b> <sup>1</sup> <sub>2</sub>	1

### MBOX3 Series

657.



Power supply with terminal block		Power supply with terminal block and emergency push button		Power supply with appliance inlet		Power supply with appliance inlet and emergency push button	
DISTRIBUTION ASSEMBLY (ACS)							
IP66		IP65		IP66		IP65	
Supply by terminal block				Appliance inlet			
<b>657.8034-006</b>	1						
<b>657.8034-008</b>	1						
<b>657.8035-012</b>	1	<b>657.8935-012</b>	1	<b>657.8135-012</b> <sup>1</sup>	1	<b>657.8835-012</b> <sup>1</sup>	1
<b>657.8035-087</b>	1	<b>657.8935-087</b>	1	<b>657.8135-087</b> <sup>1</sup>	1	<b>657.8835-087</b> <sup>1</sup>	1
<b>657.8035-013</b>	1	<b>657.8935-013</b>	1	<b>657.8135-013</b> <sup>1</sup>	1	<b>657.8835-013</b> <sup>1</sup>	1

2.1



# Distribution assemblies

## MBOX Series

■ For construction sites >> Interlocked-switch sockets without fuse >> MBOX5

1

2

ASSEMBLIES

3

4

### Sockets

no.	16A			32A		63A		General	Max power
	2P+E	3P+E	3P+N+E	3P+E	3P+N+E	3P+E	3P+N+E		
10	4		2		2		2	RCBO 4P 100A 0,03A	55 KW
11	6		2		2		1	RCBO 4P 100A 0,03A	55 KW
6	2	1	1		1		1	RCBO 4P 100A 0,03A	55 KW
8	3	3		1		1		MCB 4P 100A	55 KW
9	4		3		1		1	MCB 4P 63A	35 KW

1 Appliance inlet IEC309 125A 3P+N+E

2 Appliance inlet IEC309 63A 3P+N+E

- With door

■ For construction sites >> Standard sockets >> MBOX2

### Sockets

no.	16A			32A		General	Max power	MCB	
	2P+E	3P+E	3P+N+E	3P+E	3P+N+E			16A	
								1P	3P
6	2	1		2	1	MCB 4P 32A	18 KW	3	2
6		4	2			MCB 4P 32A RCD 4P 40A 0,03A	18 KW	3	1
6		6				MCB 4P 32A RCD 4P 40A 0,03A	18 KW	6	

1 2m rubber cable H07RN-F

2 Plug IEC309 32A 3P+N+E



3P+E 63A



3P+N+E 63A



GERMAN STANDARD  
2P+E 16A  
Shuttered socket



2P+E 16A



3P+E 16A



3P+N+E 16A



3P+E 32A



3P+N+E 32A

# Distribution assemblies

## MBOX Series



### MBOX5 Series

658.



MCB		RCD 0,03A		Power supply with terminal block	Power supply with terminal block and emergency push button	Power supply with appliance inlet	Power supply with plug and emergency push button			
16A	32A	63A		DISTRIBUTION ASSEMBLY (ACS)						
1P	3P	4P		IP66	IP65	IP66	IP65			
				Supply by terminal block		Appliance inlet				
4	2	2	2	<b>658.8050-702</b>	1	<b>658.8950-702</b>	1	<b>658.8150-702</b> <sup>[1]</sup>	1	<b>658.8850-702</b> <sup>[1]</sup>
6	2	2	1	<b>658.8050-705</b>	1	<b>658.8950-705</b>	1			<b>658.8850-705</b> <sup>[1]</sup>
2	2	1	1	<b>658.8056-138</b>	1	<b>658.8956-138</b>	1	<b>658.8156-138</b> <sup>[1]</sup>	1	<b>658.8856-138</b> <sup>[1]</sup>
3	3	1	1	<b>658.8058-040</b>	1			<b>658.8158-040</b> <sup>[1]</sup>	1	
4	3	1	1	2	<b>658.8059-043</b>	1	<b>658.8959-043</b>	1	<b>658.8159-043</b> <sup>[2]</sup>	1

### MBOX2 Series

656.



Power supply with terminal block	Power supply with terminal block and emergency push button	Power supply with plug	Power supply with plug and emergency push button		
DISTRIBUTION ASSEMBLY (ACS)					
IP66	IP65	IP66	IP65		
Supply by terminal block		Plug			
<b>656.7026-739</b>	1				
<b>656.7026-640</b>	1	<b>656.7126-640</b> <sup>[1][2]</sup>	1	<b>656.7826-640</b> <sup>[1][2]</sup>	1
<b>656.7026-639</b>	1	<b>656.7126-639</b> <sup>[1][2]</sup>	1	<b>656.7826-639</b> <sup>[1][2]</sup>	1

2.1





# Distribution assemblies

## MBOX Series

■ For construction sites >> Standard sockets >> MBOX3









ASSEMBLIES

1

2

3

4

no.	Sockets					General	Max power	MCB	
	16A			32A				16A	
	2P+E	3P+E	3P+N+E	3P+E	3P+N+E			1P+N	3P
9						MCB 4P 63A RCD 4P 63A 0,03A	35 KW	3	1
9						MCB 4P 63A RCD 4P 63A 0,03A	35 KW	5	1
9						MCB 4P 63A RCD 4P 63A 0,03A	35 KW	9	

- Appliance inlet IEC309 63A 3P+N+E





# Distribution assemblies

## MBOX Series



### MBOX3 Series

657.



**Power supply with  
appliance inlet and  
emergency push button**

MCB

16A			32A			DISTRIBUTION ASSEMBLY (ACS)
4P	3P	4P	4P	3P	4P	
	1	1	1			Appliance inlet
	1					<b>657.8839-827</b> 1
						<b>657.8839-826</b> 1
						<b>657.8839-825</b> 1

2.1



# Distribution assemblies

## MEGA Series

### ■ Distribution assemblies for construction site

ASSEMBLIES

1

2

3

4

no.	Sockets					Terminal block		Outlet w/switch	Terminal block	General	Max power	MCB				
	16A		32A	63A	125A	16A	40A	50A	80A			16A 32A 40A				
	2P+E	3P+E	3P+N+E			2P	3P+N					1P	3P	2P	3P	4P
11						4	1	1	1	MCB 4P 160A	90 KW	2	2	4		1
12	4	4								MCB 4P 160A	90 KW					
8	4		2	1	1					MCB 4P 160A	90 KW	3			2	
9	4		4						1	MCB 4P 160A	90 KW	3			4	

no.	Sockets							General	Max power	MCB					RCBO 0,03A			
	24V	16A		32A	63A	125A	40A			10A	16A	32A	63A					
	2P	2P+E	3P+E	3P+N+E			1P			2P	1P	3P	4P					
2								1	1	MCB 4P 160A	90 KW					1		
7		1		2	1	3				MCB 4P 160A	90 KW							
9	2	2	2		2	1				DISC. 4P 250A	110 KW	1	2	2	2	2	1	3



3P+N+E 63A



3P+N+E 125A



24V



2P+E 16A



3P+E 16A



3P+N+E 16A



3P+N+E 32A

# Distribution assemblies

## MEGA Series



### MEGA Series

661.



### Standard stand

MCB		MCB+RC relay	RCBO 0,03A	RCBO 0,3A	RCD 0,03A			DISTRIBUTION ASSEMBLY (ACS)		
50A 4P	63A 3P	125A	80A 4P	25A 2P	40A 4P	63A 2P	40A 4P	63A 4P	IP55	
			1		4		1	2	1	
	1	1				1			2	
				1		1			2	
									With terminal block I/O	
									<b>661.0160-057</b>	1
									<b>661.0160-075</b>	1
									<b>661.0160-065</b>	1
									<b>661.0160-068</b>	1

### MEGA Series

661.



### Reduced stand

RCBO reg.		RCD 0,03A		DISTRIBUTION ASSEMBLY (ACS)		
125A 4P	40A 4P	63A 4P	IP55			
	1					
		1				
			4			
						With terminal block I/O
						<b>661.5160-053</b>
						<b>661.5160-160</b>
						<b>661.5250-008</b>

2.1



## Distribution assemblies DOMINO Series

### ■ With terminal blocks

#### DOMINO IP66 Series [assembly]

671.



Without emergency push  
button

With emergency push  
button

DISTRIBUTION ASSEMBLY (ACS)

IP66

IP65

Direct supply to main switch

General	Max power	Without emergency push button		With emergency push button	
		IP66	Direct supply to main switch	IP65	Direct supply to main switch
MCB 1P+N 16A RCD 2P 25A 0,03A	3 KW	<b>671.2012-005</b>	1		
MCB 2P 32A RCD 2P 40A 0,03A	6 KW	<b>671.2012-009</b>	1		
MCB 4P 16A RCD 4P 25A 0,03A	9 KW	<b>671.2012-006</b>	1		
MCB 4P 32A RCD 4P 40A 0,03A	18 KW	<b>671.2012-004</b>	1	<b>671.2912-004</b>	1
MCB 4P 63A RCD 4P 63A 0,03A	35 KW	<b>671.2012-003</b>	1	<b>671.2912-003</b>	1
MCB 4P 80A RCBO 4P 80A REG	45 KW	<b>671.2016-008</b>	1		
RCBO 4P 100A 0,03A	55 KW	<b>671.2012-002</b>	1	<b>671.2912-002</b>	1
RCBO 4P 125A	70 KW	<b>671.2012-001</b>	1	<b>671.2912-001</b>	1



2P+E 16A



3P+E 16A

## Distribution assemblies DOMINO Series

**SCAME**

### ■ With sockets [interlocked]

#### DOMINO IP66 Series [assembly]

670.



Portable - With cable  
and IEC309 plug

#### DISTRIBUTION ASSEMBLY (ACS)

no.	Sockets		General	Max power	DISTRIBUTION ASSEMBLY (ACS)	
	2P+E	3P+E			IP44	IP66
	16A				Plug	
	2P+E	3P+E				
2	1	1	MCB 4P 16A RCD 4P 25A 0,03A	9 KW	<b>670.3026-75</b> <sup>[1]</sup>	1
2	2		MCB 2P 16A RCD 2P 25A 0,03A	3 KW	<b>670.3026-77</b> <sup>[2]</sup>	1
4	2	2	MCB 4P 16A RCD 4P 25A 0,03A	9 KW	<b>670.6046-03</b> <sup>[1]</sup>	1
4	3	1	MCB 4P 16A RCD 4P 25A 0,03A	9 KW	<b>670.6046-08</b> <sup>[1]</sup>	1
4	4		MCB 2P 16A RCD 2P 25A 0,03A	3 KW	<b>670.6046-12</b> <sup>[2]</sup>	1

[1] Plug IEC309 16A 3P+N+E

[2] Plug IEC309 16A 2P+E

- 4m rubber cable H07RN-F

#### DOMINO IP66 Series [assembly]

671.



Surface mounting with  
protection devices

no.	Sockets		General	Max power	MCB		DISTRIBUTION ASSEMBLY	
	2P+E	3P+E			1P	3P	IP44	Supply by terminal block
	16A							
	2P+E	3P+E						
2	1	1	-	12 KW	1	1	<b>671.3020-75</b>	1
2	2		-	6 KW	2		<b>671.3020-77</b>	1
4	1	3	-	30 KW	1	3	<b>671.6040-07</b>	1
4	2	2	-	24 KW	2	2	<b>671.6040-03</b>	1
4	4		-	12 KW	4		<b>671.6040-95</b>	1

2.1



## Distribution assemblies DOMINO Series

### ■ With sockets [interlocked]

#### DOMINO IP66 Series [assembly]

671.



Surface mounting -  
partly wired  
Without protection  
devices

Sockets

16A

no.	Sockets			Supply	Volt	Poles	DISTRIBUTION ASSEMBLY	
	2P+E	3P+E	3P+N+E				IP44	IP66
2	1	1		-	400V	3P+N+E	<b>671.3025-75</b>	1
4	1	3		-	400V	3P+N+E	<b>671.6045-07</b>	1
4	2	2		-	400V	3P+N+E	<b>671.6045-03</b>	1
4	2		2	-	400V	3P+N+E	<b>671.6045-06</b>	1
4	3	1		-	400V	3P+N+E	<b>671.6045-08</b>	1
4	4			-	230V	2P+E	<b>671.6045-95</b>	1

### ■ With sockets [standard]

#### DOMINO IP66 Series [assembly]

670.



Portable - With cable  
and IEC309 plug

no.	Sockets			General	Max power	MCB DISC.				DISTRIBUTION ASSEMBLY (ACS)			
	16A					16A		32A		IP66		Plug	
	2P+E	3P+E				1P	3P	1P	3P				
3	2	1		MCB 4P 16A RCD 4P 25A 0,03A	9 KW			2	1	<b>670.3536-59</b> <sup>[1]</sup>	1		
3	3			MCB 2P 16A RCD 2P 25A 0,03A	3 KW			3		<b>670.3536-62</b> <sup>[2]</sup>	1		
6	3	3		MCB 4P 16A RCD 4P 25A 0,03A	9 KW			3	1	<b>670.6566-117</b> <sup>[1]</sup>	1		
6	3	3		RCD 4P 40A 0,03A	18 KW	3	1			<b>670.6566-137</b> <sup>[3]</sup>	1		
6	6			RCD 4P 40A 0,03A	18 KW	6				<b>670.6566-126</b> <sup>[3]</sup>	1		

[1] Plug IEC309 16A 3P+N+E

[2] Plug IEC309 16A 2P+E

[3] Plug IEC309 32A 3P+N+E

- 4m rubber cable H07RN-F



2P+E 16A



3P+E 16A



3P+N+E 16A

# Distribution assemblies DOMINO Series



## ■ With sockets [standard]

### DOMINO IP66 Series [assembly]

671.



Sockets				MCB		Surface mounting with protection devices				
no.	16A		General	Max power	16A		DISTRIBUTION ASSEMBLY			
	2P+E	3P+E			1P	3P	IP44		IP66	
3	2	1	-	15 KW	2	1	Supply by terminal block			
3	3		-	9 KW	3		<b>671.3030-59</b>	1	<b>671.3530-59</b>	1
3	3		-	9 KW	3		<b>671.3030-97</b>	1	<b>671.3530-97</b>	1
6	3	3	-	35 KW	3	3			<b>671.6560-117</b>	1

### DOMINO IP66 Series [assembly]

671.



Sockets						Surface mounting - partially wired Without protection devices			
no.	16A		Supply	Volt	Poles	DISTRIBUTION ASSEMBLY			
	2P+E	3P+E				IP44		IP66	
3	2	1	-	400V	3P+N+E	<b>671.3035-59</b>	1	<b>671.3535-59</b>	1
3	3		-	230V	2P+E	<b>671.3035-97</b>	1	<b>671.3535-97</b>	1
6	3	3	-	400V	3P+N+E	<b>671.6065-117</b>	1	<b>671.6565-117</b>	1

2.1



# Distribution assemblies

## BLOCK Series

### Wired assemblies - Portable >> MCB protected versions

BLOCK Series

630.



1  
2  
3  
4  
ASSEMBLIES

Sockets

BLOCK3 [IP44]

BLOCK3 [IP66]

no.	16A					General	Max power	DISTRIBUTION ASSEMBLY			
	2P+E		3P+E					IP44	Plug		IP66
	⏏	⏏	⏏	⏏	⏏						
3	1			1	1	MCB 4P 16A	9 KW	<b>630.3000-052</b> <sup>[1]</sup>	1		
3	1			2		MCB 2P 16A	3 KW	<b>630.3000-054</b> <sup>[2]</sup>	1		
3	3					MCB 2P 16A	3 KW	<b>630.3000-055</b> <sup>[2]</sup>	1		
3		1		2		MCB 2P 16A	3 KW	<b>630.3000-056</b> <sup>[2]</sup>	1		
3			1	2		MCB 2P 16A	3 KW	<b>630.3000-401</b> <sup>[2]</sup>	1		
3				1	2	MCB 4P 16A	9 KW	<b>630.3000-060</b> <sup>[1]</sup>	1	<b>630.3500-060</b> <sup>[1]</sup>	1
3				2	1	MCB 4P 16A	9 KW	<b>630.3000-059</b> <sup>[1]</sup>	1	<b>630.3500-059</b> <sup>[1]</sup>	1
3				3		MCB 2P 16A	3 KW	<b>630.3000-062</b> <sup>[2]</sup>	1	<b>630.3500-062</b> <sup>[2]</sup>	1
3					3	MCB 3P 16A	9 KW	<b>630.3000-063</b> <sup>[3]</sup>	1	<b>630.3500-063</b> <sup>[3]</sup>	1

[1] Plug IEC309 16A 3P+N+E

[2] Plug IEC309 16A 2P+E

[3] Plug IEC309 16A 3P+E

- 1,5m rubber cable H07RN-F



**GERMAN STANDARD**  
2P+E 16A  
Shuttered socket



**FRENCH STANDARD**  
2P+E 16A  
Shuttered socket



**ITALIAN STANDARD**  
P17/11 2P+E 16A  
Shuttered socket CEI 23-50



2P+E 16A



3P+E 16A



3P+N+E 16A



3P+E 32A



3P+N+E 32A





# Distribution assemblies

## BLOCK Series

### ■ Wired assemblies - Portable >> MCB+RCD protected versions [AS]

BLOCK Series

630.



**BLOCK3 [IP44]**

DISTRIBUTION ASSEMBLY

IP44

Plug

no.	Sockets			General	Max power	Product Code	Quantity
	16A	2P+E	3P+E				
3	1	1	1	RCBO 4P 16A 0,03A	9 KW	<b>630.3006-052</b> <sup>[1]</sup>	1
3	1	2		MCB 2P 16A RCD 2P 25A 0,03A	3 KW	<b>630.3006-054</b> <sup>[2]</sup>	1
3	2	1		MCB 2P 16A RCD 2P 25A 0,03A	3 KW	<b>630.3006-362</b> <sup>[2]</sup>	1
3	3			MCB 2P 16A RCD 2P 25A 0,03A	3 KW	<b>630.3006-055</b> <sup>[2]</sup>	1
3	1	2		MCB 2P 16A RCD 2P 25A 0,03A	3 KW	<b>630.3006-056</b> <sup>[2]</sup>	1

[1] Plug IEC309 16A 3P+N+E

[2] Plug IEC309 16A 2P+E

- 1,5m rubber cable H07RN-F



**GERMAN STANDARD**  
2P+E 16A  
Shuttered socket



**ITALIAN STANDARD**  
P17/11 2P+E 16A  
Shuttered socket CEI 23-50



2P+E 16A



3P+E 16A



**PLURISTANDARD P40**  
2P+E 16A  
Shuttered socket

# Distribution assemblies

## BLOCK Series



### ■ Wired assemblies - Portable >> MCB+RCD protected versions [ASC]

BLOCK Series

630.



Sockets				General	Max power	BLOCK3 [IP44]		BLOCK3 [IP66]	
16A						DISTRIBUTION ASSEMBLY (ACS)			
no.	2P+E		3P+E			IP44		IP66	
	1	2	3			Plug			
3	1	2		MCB 2P 16A RCD 2P 25A 0,03A	3 KW			<b>630.3506-054</b> <sup>[2]</sup>	1
3	2	1		MCB 2P 16A RCD 2P 25A 0,03A	3 KW			<b>630.3506-362</b> <sup>[2]</sup>	1
3	3			MCB 2P 16A RCD 2P 25A 0,03A	3 KW			<b>630.3506-055</b> <sup>[2]</sup>	1
3	1	1	1	RCBO 4P 16A 0,03A	9 KW			<b>630.3506-052</b> <sup>[1]</sup>	1
3	1	2		MCB 2P 16A RCD 2P 25A 0,03A	3 KW			<b>630.3506-056</b> <sup>[4][2]</sup>	1
3		1	2	RCBO 4P 16A 0,03A	9 KW	<b>630.3006-060</b> <sup>[1]</sup>	1	<b>630.3506-060</b> <sup>[1]</sup>	1
3		2	1	RCBO 4P 16A 0,03A	9 KW	<b>630.3006-059</b> <sup>[1]</sup>	1	<b>630.3506-059</b> <sup>[1]</sup>	1
3		3		MCB 2P 16A RCD 2P 25A 0,03A	3 KW	<b>630.3006-062</b> <sup>[2]</sup>	1	<b>630.3506-062</b> <sup>[2]</sup>	1
3			3	RCBO 4P 16A 0,03A	9 KW	<b>630.3006-063</b> <sup>[3]</sup>	1	<b>630.3506-063</b> <sup>[3]</sup>	1

<sup>[1]</sup> Plug IEC309 16A 3P+N+E

<sup>[2]</sup> Plug IEC309 16A 2P+E

<sup>[3]</sup> Plug IEC309 16A 3P+E

<sup>[4]</sup> Products with domestic standard sockets IP66 even with plug inserted.

- 1,5m rubber cable H07RN-F

2.1



# Distribution assemblies

## BLOCK Series

### ■ Wired assemblies - Portable >> MCB+RCD protected versions

BLOCK Series

630.



1  
2  
3  
4  
ASSEMBLIES

Sockets

BLOCK4 [IP44]

BLOCK4 [IP66]

no.	16A					General	Max power	DISTRIBUTION ASSEMBLY (ACS)			
	no.	2P+E		3P+E	3P+N+E			IP44		IP66	
		no.	no.	no.	no.			Plug			
4	1	1	1	1		MCB 4P 16A RCD 4P 25A 0,03A	9 KW	<b>630.4006-001</b> <sup>[1]</sup>	1	<b>630.4506-001</b> <sup>[1]</sup>	1
4	1	1	2			MCB 2P 16A RCD 2P 25A 0,03A	3 KW	<b>630.4006-002</b> <sup>[2]</sup>	1	<b>630.4506-002</b> <sup>[2]</sup>	1
4	2	2				MCB 2P 16A RCD 2P 25A 0,03A	3 KW	<b>630.4006-010</b> <sup>[2]</sup>	1	<b>630.4506-010</b> <sup>[2]</sup>	1
4			1	3		MCB 4P 16A RCD 4P 25A 0,03A	9 KW	<b>630.4006-007</b> <sup>[1]</sup>	1	<b>630.4506-007</b> <sup>[1]</sup>	1
4			2	2		MCB 4P 16A RCD 4P 25A 0,03A	9 KW	<b>630.4006-003</b> <sup>[1]</sup>	1	<b>630.4506-003</b> <sup>[1]</sup>	1
4			2		2	MCB 4P 16A RCD 4P 25A 0,03A	9 KW	<b>630.4006-006</b> <sup>[1]</sup>	1	<b>630.4506-006</b> <sup>[1]</sup>	1
4			3	1		MCB 4P 16A RCD 4P 25A 0,03A	9 KW	<b>630.4006-008</b> <sup>[1]</sup>	1	<b>630.4506-008</b> <sup>[1]</sup>	1
4			4			MCB 2P 16A RCD 2P 25A 0,03A	3 KW	<b>630.4006-012</b> <sup>[2]</sup>	1	<b>630.4506-012</b> <sup>[2]</sup>	1
4				4		MCB 3P 16A RCD 4P 25A 0,03A	9 KW	<b>630.4006-013</b> <sup>[3]</sup>	1	<b>630.4506-013</b> <sup>[3]</sup>	1
4					4	MCB 4P 16A RCD 4P 25A 0,03A	9 KW	<b>630.4006-188</b> <sup>[1]</sup>	1		

[1] Plug IEC309 16A 3P+N+E

[2] Plug IEC309 16A 2P+E

[3] Plug IEC309 16A 3P+E

- 4m rubber cable H07RN-F



**GERMAN STANDARD**  
2P+E 16A  
Shuttered socket



**ITALIAN STANDARD**  
P17/11 2P+E 16A  
Shuttered socket CEI 23-50



2P+E 16A



3P+E 16A



3P+N+E 16A

# Distribution assemblies

## BLOCK Series



### ■ Wired assemblies - Portable >> MCB+RCD protected versions

BLOCK Series

630.



Sockets				General	Max power	Portable with support With IEC309 cable and plug	Portable with support With IEC309 cable and plug
16A						DISTRIBUTION ASSEMBLY (ACS)	
no.	2P+E	3P+E	3P+N+E			IP44	IP66
						Plug	
4	2	2		MCB 4P 16A RCD 4P 25A 0,03A	9 KW	<b>630.4106-003</b> <sup>[1]</sup>	<b>630.4606-003</b> <sup>[1]</sup>
4	2		2	MCB 4P 16A RCD 4P 25A 0,03A	9 KW	<b>630.4106-006</b> <sup>[1]</sup>	
4	3	1		MCB 4P 16A RCD 4P 25A 0,03A	9 KW	<b>630.4106-008</b> <sup>[1]</sup>	<b>630.4606-008</b> <sup>[1]</sup>
4	4			MCB 2P 16A RCD 2P 25A 0,03A	3 KW	<b>630.4106-012</b> <sup>[2]</sup>	<b>630.4606-012</b> <sup>[2]</sup>
4		4		MCB 3P 16A RCD 4P 25A 0,03A	9 KW	<b>630.4106-013</b> <sup>[3]</sup>	<b>630.4606-013</b> <sup>[3]</sup>

[1] Plug IEC309 16A 3P+N+E

[2] Plug IEC309 16A 2P+E

[3] Plug IEC309 16A 3P+E

- Support with roof in steel: allows the distribution assembly to be sustained for a correct earth usage.

2.1



# Distribution assemblies

## BLOCK Series

### Wired assemblies - Portable

BLOCK Series

630.



ASSEMBLIES

1

2

3

4

Sockets

MCB DISC.

With safety transformer

no.	Sockets			General	Max power	MCB DISC.		With safety transformer				
	24V 2P	16A 2P+E	3P+E			6A 1P+N	10A 1P	16A	DISTRIBUTION ASSEMBLY (ACS)			
							IP44	IP66	Plug			
4	2	1	1	RCBO 4P 16A 0,03A	9 KW	1			<b>630.4009-017</b> <sup>[2]</sup>	1	<b>630.4509-017</b> <sup>[2]</sup>	1
4	2	2		MCB 2P 16A RCD 2P 25A 0,03A	3 KW	1		2	<b>630.4009-323</b> <sup>[1]</sup>	1	<b>630.4509-323</b> <sup>[1]</sup>	1
4	2		2	RCBO 4P 16A 0,03A	9 KW	1			<b>630.4009-016</b> <sup>[2]</sup>	1	<b>630.4509-016</b> <sup>[2]</sup>	1
4	4			MCB 1P+N 3A	Trafo 300 VA (230/24V)		1		<b>630.4009-014</b> <sup>[1]</sup>	1	<b>630.4509-014</b> <sup>[1]</sup>	1

<sup>[2]</sup> Safety transformer 220/24V~ - SELV

<sup>[1]</sup> Plug IEC309 16A 2P+E

<sup>[2]</sup> Plug IEC309 16A 3P+N+E

- 4m rubber cable H07RN-F



#### CombiFinder

ScameOnLine

Discover the new application directly on the web: [www.scame.com/CombiFinder.asp](http://www.scame.com/CombiFinder.asp)  
An application to help you find just the right assembled panel you need!

"CombiFINDER" allows you to quickly find a pre-assembled panel available from SCAME PARRE S.p.A., already certified and ready for use, with immediate shipping to your local wholesaler!



24V



2P+E 16A



3P+E 16A



GERMAN STANDARD  
2P+E 16A  
Shuttered socket



ITALIAN STANDARD  
P17/11 2P+E 16A  
Shuttered socket CEI 23-50

# Distribution assemblies

## BLOCK Series



### ■ Wired assemblies - Surface mounting >> MCB protected versions

BLOCK Series

632.



Sockets							BLOCK3 [IP44]		BLOCK3 [IP66]	
					DISTRIBUTION ASSEMBLY					
							IP44		IP66	
					Direct supply to main switch					
no.	16A				General	Max power				
	2P+E	3P+E	3P+E	3P+E			IP44	IP66		
3	1	1	1		MCB 4P 16A	9 KW	<b>632.3000-052</b>	1		
3	1	2			MCB 1P+N 16A	3 KW	<b>632.3000-054</b>	1		
3	3				MCB 1P+N 16A	3 KW	<b>632.3000-055</b>	1		
3	1	2			MCB 1P+N 16A	3 KW	<b>632.3000-056</b>	1		
3		1	2		MCB 4P 16A	9 KW	<b>632.3000-060</b>	1	<b>632.3500-060</b>	1
3		2	1		MCB 4P 16A	9 KW	<b>632.3000-059</b>	1	<b>632.3500-059</b>	1
3		3			MCB 1P+N 16A	3 KW	<b>632.3000-062</b>	1	<b>632.3500-062</b>	1
3			3		MCB 3P 16A	9 KW	<b>632.3000-063</b>	1	<b>632.3500-063</b>	1

2.1



# Distribution assemblies

## BLOCK Series

■ Wired assemblies - Surface mounting >> MCB protected versions

BLOCK Series

632.



1  
2  
3  
4  
ASSEMBLIES

Sockets

BLOCK4 [IP44]

BLOCK4 [IP66]

no.	Sockets						General	Max power	DISTRIBUTION ASSEMBLY			
	16A			32A					IP44	IP66		
	2P+E	3P+E	3P+N+E	Direct supply to main switch		Direct supply to main switch						
4	1	1	1	1			MCB 4P 16A	9 KW	<b>632.4000-001</b>	1		
4	1	1	2				MCB 1P+N 16A	3 KW	<b>632.4000-002</b>	1		
4	2	2					MCB 1P+N 16A	3 KW	<b>632.4000-010</b>	1		
4	2		1	1			MCB 4P 16A	9 KW	<b>632.4000-342</b>	1		
4			1	3			MCB 4P 16A	9 KW	<b>632.4000-007</b>	1	<b>632.4500-007</b>	1
4			1		2	1	MCB 4P 16A	9 KW	<b>632.4000-329</b>	1	<b>632.4500-329</b>	1
4			2	2			MCB 4P 16A	9 KW	<b>632.4000-003</b>	1	<b>632.4500-003</b>	1
4			2		1	1	MCB 4P 16A	9 KW	<b>632.4000-328</b>	1	<b>632.4500-328</b>	1
4			2		2		MCB 4P 16A	9 KW	<b>632.4000-006</b>	1	<b>632.4500-006</b>	1
4			3	1			MCB 4P 16A	9 KW	<b>632.4000-008</b>	1	<b>632.4500-008</b>	1
4			4				MCB 2P 16A	3 KW	<b>632.4000-012</b>	1	<b>632.4500-012</b>	1
4				4			MCB 3P 16A	9 KW	<b>632.4000-013</b>	1	<b>632.4500-013</b>	1



GERMAN STANDARD  
2P+E 16A  
Shuttered socket



ITALIAN STANDARD  
P17/11 2P+E 16A  
Shuttered socket CEI 23-50



2P+E 16A



3P+E 16A



3P+N+E 16A



3P+N+E 32A



3P+E 32A



# Distribution assemblies

## BLOCK Series



### ■ Wired assemblies - Surface mounting >> MCB+RCD protected versions

BLOCK Series

632.



BLOCK3 [IP44]

BLOCK3 [IP66]

Sockets

no.	Sockets						General	Max power	DISTRIBUTION ASSEMBLY	
	16A			32A					IP44	IP66
	2P+E	3P+E	3P+N+E	3P+E	3P+N+E	Direct supply to main switch				
3	1	1	1				RCBO 4P 16A 0,03A	9 KW	<b>632.3006-052</b>	1
3	1	2					MCB 1P+N 16A RCD 2P 25A 0,03A	3 KW	<b>632.3006-054</b>	1
3	3						MCB 1P+N 16A RCD 2P 25A 0,03A	3 KW	<b>632.3006-055</b>	1
3	1	2					MCB 1P+N 16A RCD 2P 25A 0,03A	3 KW	<b>632.3006-056</b>	1
3		1	1		1		RCBO 4P 16A 0,03A	9 KW	<b>632.3006-324</b>	1 <b>632.3506-324</b>
3		1	2				RCBO 4P 16A 0,03A	9 KW	<b>632.3006-060</b>	1 <b>632.3506-060</b>
3		1		1		1	RCBO 4P 16A 0,03A	9 KW	<b>632.3006-325</b>	1 <b>632.3506-325</b>
3		2	1				RCBO 4P 16A 0,03A	9 KW	<b>632.3006-059</b>	1 <b>632.3506-059</b>
3		3					MCB 1P+N 16A RCD 2P 25A 0,03A	3 KW	<b>632.3006-062</b>	1 <b>632.3506-062</b>
3			3				RCBO 4P 16A 0,03A	9 KW	<b>632.3006-063</b>	1 <b>632.3506-063</b>

2.1



# Distribution assemblies

## BLOCK Series

### ■ Wired assemblies - Surface mounting >> MCB+RCD protected versions

BLOCK Series

632.



1  
2  
ASSEMBLIES

3

4

Sockets

no.	16A		32A		General	Max power	BLOCK4 [IP44]		BLOCK4 [IP66]	
	2P+E	3P+E	3P+N+E							
4	1	1	1	1	MCB 4P 16A RCD 4P 25A 0,03A	9 KW	<b>632.4006-001</b>	1		
4	1	1	2		MCB 1P+N 16A RCD 2P 25A 0,03A	3 KW	<b>632.4006-002</b>	1		
4	2	2			MCB 1P+N 16A RCD 2P 25A 0,03A	3 KW	<b>632.4006-010</b>	1		
4		1	3		MCB 4P 16A RCD 4P 25A 0,03A	9 KW	<b>632.4006-007</b>	1	<b>632.4506-007</b>	1
4		1		2	MCB 4P 16A RCD 4P 25A 0,03A	9 KW	<b>632.4006-329</b>	1	<b>632.4506-329</b>	1
4		2	2		MCB 4P 16A RCD 4P 25A 0,03A	9 KW	<b>632.4006-003</b>	1	<b>632.4506-003</b>	1
4		2		1	MCB 4P 16A RCD 4P 25A 0,03A	9 KW	<b>632.4006-328</b>	1	<b>632.4506-328</b>	1
4		2		2	MCB 4P 16A RCD 4P 25A 0,03A	9 KW	<b>632.4006-006</b>	1	<b>632.4506-006</b>	1
4		3	1		MCB 4P 16A RCD 4P 25A 0,03A	9 KW	<b>632.4006-008</b>	1	<b>632.4506-008</b>	1
4		4			MCB 1P+N 16A RCD 2P 25A 0,03A	3 KW	<b>632.4006-012</b>	1	<b>632.4506-012</b>	1
4			4		MCB 3P 16A RCD 4P 25A 0,03A	9 KW	<b>632.4006-013</b>	1	<b>632.4506-013</b>	1
4				4	MCB 4P 16A RCD 4P 25A 0,03A	9 KW	<b>632.4006-013</b>	1	<b>632.4506-188</b>	1



GERMAN STANDARD  
2P+E 16A  
Shuttered socket



ITALIAN STANDARD  
P17/11 2P+E 16A  
Shuttered socket CEI 23-50



2P+E 16A



3P+E 16A



3P+N+E 16A



3P+N+E 32A

# Distribution assemblies

## BLOCK Series



### ■ Wired assemblies - Surface mounting >> Without protection devices

BLOCK Series

632.



Sockets

16A

BLOCK3 [IP44]

BLOCK3 [IP66]

no.	Sockets			Supply	Current	Volt	Poles	DISTRIBUTION ASSEMBLY			
	2P+E	3P+E	3P+E					IP44	IP66		
3	1	1	1	-	16A	400V	3P+N+E	<b>632.3005-052</b>	1		
3	1	2		-	16A	230V	2P+E	<b>632.3005-054</b>	1		
3	3			-	16A	230V	2P+E	<b>632.3005-055</b>	1		
3	1	2		-	16A	230V	2P+E	<b>632.3005-056</b>	1		
3		1	2	-	16A	400V	3P+N+E	<b>632.3005-060</b>	1	<b>632.3505-060</b>	1
3		2	1	-	16A	400V	3P+N+E	<b>632.3005-059</b>	1	<b>632.3505-059</b>	1
3		3		-	16A	230V	2P+E	<b>632.3005-062</b>	1	<b>632.3505-062</b>	1
3			3	-	16A	400V	3P+E	<b>632.3005-063</b>	1	<b>632.3505-063</b>	1

2.1



# Distribution assemblies

## BLOCK Series

■ **Wired assemblies - Surface mounting >> Without protection devices**



































ASSEMBLIES

1

2

3

4

no.	Sockets							Supply	Current	Volt	Poles
	16A		32A		16A	32A					
	2P+E	3P+E	3P+N+E	3P+N+E							
4								-	16A	400V	3P+N+E
4								-	16A	230V	2P+E
4								-	16A	230V	2P+E
4								-	16A	400V	3P+N+E
4								-	16A	400V	3P+N+E
4								-	16A	400V	3P+N+E
4								-	16A	400V	3P+N+E
4								-	16A	400V	3P+N+E
4								-	16A	400V	3P+N+E
4								-	16A	400V	3P+N+E
4								-	16A	400V	3P+N+E
4								-	16A	230V	2P+E
4								-	16A	400V	3P+E



**GERMAN STANDARD**  
2P+E 16A  
Shuttered socket



**ITALIAN STANDARD**  
P17/11 2P+E 16A  
Shuttered socket CEI 23-50



2P+E 16A



3P+E 16A



3P+N+E 16A



3P+E 32A



3P+N+E 32A

# Distribution assemblies

## BLOCK Series



### BLOCK Series

632.



#### BLOCK4 [IP44]

#### BLOCK4 [IP66]

DISTRIBUTION ASSEMBLY			
IP44		IP66	
<b>632.4005-001</b>	1		
<b>632.4005-002</b>	1		
<b>632.4005-010</b>	1		
<b>632.4005-327</b>	1	<b>632.4505-327</b>	1
<b>632.4005-007</b>	1	<b>632.4505-007</b>	1
<b>632.4005-329</b>	1	<b>632.4505-329</b>	1
<b>632.4005-326</b>	1	<b>632.4505-326</b>	1
<b>632.4005-003</b>	1	<b>632.4505-003</b>	1
<b>632.4005-328</b>	1	<b>632.4505-328</b>	1
<b>632.4005-006</b>	1	<b>632.4505-006</b>	1
<b>632.4005-008</b>	1	<b>632.4505-008</b>	1
<b>632.4005-012</b>	1	<b>632.4505-012</b>	1
<b>632.4005-013</b>	1	<b>632.4505-013</b>	1

2.1



# Distribution assemblies

## BLOCK Series

### Wired assemblies - Surface mounting

BLOCK Series

632.



1  
2  
3  
4  
ASSEMBLIES

Sockets

MCB

With safety transformer

no.	Sockets			General	Max power	MCB	DISTRIBUTION ASSEMBLY	
	24V 2P	16A 2P+E	3P+E				6A 1P+N	10A IP44
							Direct supply to main switch	
4	2	1	1	MCB 4P 16A	Trafo 150 VA (230/24V)	1	<b>632.4009-017</b>	<b>632.4509-017</b>
4	2	2		MCB 1P+N 16A	Trafo 150 VA (230/24V)	1	<b>632.4009-015</b>	<b>632.4509-015</b>
4	2		2	MCB 4P 16A	Trafo 150 VA (230/24V)	1	<b>632.4009-016</b>	<b>632.4509-016</b>
4	4			MCB 1P+N 3A	Trafo 300 VA (230/24V)	1	<b>632.4009-014</b>	<b>632.4509-014</b>

⊕ Safety transformer 220/24V~ - SELV



24V



2P+E 16A



3P+E 16A



3P+N+E 16A

# Distribution assemblies

## KIOSK Series



### With OPTIMA [SAFE-IN] sockets

#### KIOSK Series

659.



#### Type BLOCK

no.	Sockets		General	RCBO 0,03A		Supply by terminal block	659.BA5140-02
	16A	2P+E		16A	2P		
4	4		-	4			

☉ Sockets with "SAFE-IN" safety device

#### KIOSK Series

659.



#### Type DOMINO

no.	Sockets			General	MCB		RCBO 0,03A		RCD 0,03A		Supply by terminal block	IP66		
	16A	2P+E	3P+N+E		6A	25A	1P+N	4P	2P	4P				
2	2			DISC. 4P 63A	2			2			<b>659.DA5121-01</b>	1	<b>659.DB5121-01</b>	1
4	3	1		-		1	3		1		<b>659.DA5141-04</b>	1	<b>659.DB5141-04</b>	
4	4			DISC. 4P 63A	4			4			<b>659.DA5141-02</b>	1	<b>659.DB5141-02</b>	1
8	6	2		DISC. 4P 63A	6	2		6	2		<b>659.DA5181-05</b>	1	<b>659.DB5181-05</b>	
8	8			DISC. 4P 63A	8			8			<b>659.DA5181-03</b>	1	<b>659.DB5181-03</b>	

☉ Sockets with "SAFE-IN" safety device

- Upon request, versions can be built with the water kit (contact the CIT - Technical Information Centre)

2.1



# Distribution assemblies

## KIOSK Series

### With OPTIMA [SAFE-IN] sockets

#### KIOSK Series

659.



#### Type MBOX

Sockets		MCB		RCD 0,03A		Type MBOX			
16A		6A		25A		PILLAR MBOX2-OPTIMA METAL			
2P+E	3P+N+E	1P+N	4P	2P	4P	PILLAR MBOX2-OPTIMA S.STEEL			
no.			General				Supply by terminal block		
2	2		DISC. 4P 63A	2		2		<b>659.MA5121-01</b>	<b>659.MB5121-01</b>
4	3	1	-	3	1	3	1	<b>659.MA5141-04</b>	<b>659.MB5141-04</b>
4	4		DISC. 4P 63A	4		4		<b>659.MA5141-02</b>	<b>659.MB5141-02</b>

Sockets with "SAFE-IN" safety device

- Upon request, versions can be built with the water kit (contact the CIT - Technical Information Centre)

#### KIOSK Series

659.



#### Type SMART-C

Sockets		RCBO 0,03A		Type SMART-C					
16A		6A		PILLAR SMART C - OPTIMA					
2P+E	3P+N+E	2P	4P	IP56					
no.			General				Supply by terminal block		
2	2		DISC. 4P 40A	2				<b>659.SC5121-01</b>	
4	3	1	DISC. 4P 40A	3	1			<b>659.SC5141-04</b>	
4	4		DISC. 4P 40A	4				<b>659.SC5141-02</b>	

Sockets with "SAFE-IN" safety device

- Upon request, versions can be built with the water kit (contact the CIT - Technical Information Centre)



2P+E 16A



3P+N+E 16A



# Distribution assemblies

## KIOSK Series



### With OPTIMA [SAFE-IN] sockets

#### KIOSK Series

659.



no.	Sockets		Kit water	General	RCBO 0,03A			Type SMART-K
	16A				6A	16A		
	2P+E	3P+N+E			2P	4P	2P	
2	2		2	DISC. 4P 40A			2	PILLAR SMART K - OPTIMA
2	2			DISC. 4P 40A	2			IP56
4	3	1		DISC. 4P 40A	3	1		Supply by terminal block
4	4		4	DISC. 4P 40A	4			<b>659.SK5123-12</b>
4	4			DISC. 4P 40A	4			<b>659.SK5121-01</b>
4	4			DISC. 4P 40A	4			<b>659.SK5141-04</b>
4	4			DISC. 4P 40A	4			<b>659.SK5143-07</b>
4	4			DISC. 4P 40A	4			<b>659.SK5141-02</b>
6	6		2	DISC. 4P 40A	6			<b>659.SK5163-06</b>

☉ Sockets with "SAFE-IN" safety device

- Upon request, versions can be built with the water kit (contact the CIT - Technical Information Centre)

#### KIOSK Series

659.



no.	Sockets		General	RCBO 0,03A		Type SMART-X	
	16A			6A	PILLAR SMART-X - OPTIMA		
	2P+E			2P	IP56		
4	4		DISC. 4P 40A	4		Supply by terminal block	
						<b>659.SX5140-02</b>	

☉ Sockets with "SAFE-IN" safety device

- Upon request, versions can be built with the water kit (contact the CIT - Technical Information Centre)

2.1



# Distribution assemblies

## KIOSK Series

### With OMNIA [interlocked sockets]

#### KIOSK Series

659.



#### Type DOMINO

Sockets			MCB				RCBO 0,03A		RCD 0,03A		Type DOMINO	
16A			6A		25A		PILLAR DOMINO-OMNIA METAL		PILLAR DOMINO-OMNIA S.STEEL			
no.	2P+E	3P+N+E	1P	4P	2P	4P	IP66		Supply by terminal block			
2	2		DISC. 4P 63A	2			2		<b>659.DA5221-01</b>	1	<b>659.DB5221-01</b>	
4	3	1	-	1	3		1		<b>659.DA5241-04</b>	1	<b>659.DB5241-04</b>	
4	4		DISC. 4P 63A	4			4		<b>659.DA5241-02</b>	1	<b>659.DB5241-02</b>	
8	6	2	DISC. 4P 63A	6	2		6	2	<b>659.DA5281-05</b>	1	<b>659.DB5281-05</b>	
8	8		DISC. 4P 63A	8			8		<b>659.DA5281-03</b>	1	<b>659.DB5281-03</b>	

- Upon request, versions can be built with the water kit (contact the CIT - Technical Information Centre)

#### KIOSK Series

659.



#### Type MBOX

Sockets			MCB				RCD 0,03A		Type MBOX	
16A			6A		25A		PILLAR MBOX2-OMNIA METAL		PILLAR MBOX2-OMNIA S.STEEL	
no.	2P+E	3P+N+E	1P	4P	2P	4P	IP66		Supply by terminal block	
2	2		DISC. 4P 63A	2		2			<b>659.MA5221-01</b>	<b>659.MB5221-01</b>
4	3	1	-	3	1	3	1		<b>659.MA5241-04</b>	<b>659.MB5241-04</b>
4	4		DISC. 4P 63A	4		4			<b>659.MA5241-02</b>	<b>659.MB5241-02</b>

- Upon request, versions can be built with the water kit (contact the CIT - Technical Information Centre)



2P+E 16A



3P+N+E 16A



3P+N+E 125A



2P+E 32A

## Distribution assemblies KIOSK Series



### ■ With OMNIA [interlocked sockets]

#### KIOSK Series

659.



#### Sockets

#### RCBO 0,03A

#### Type SMART-C

no.	16A		32A		125A		Kit water	General	RCBO 0,03A				PILLAR SMART C - OMNIA IP56 Supply by terminal block
	2P+E	3P+N+E	2P+E	3P+N+E	2P	4P			2P	4P	2P	4P	
2	2							DISC. 4P 40A	2				<b>659.SC5221-01</b>
4	3	1						DISC. 4P 40A	3	1			<b>659.SC5241-04</b>
4	4							DISC. 4P 40A	4				<b>659.SC5241-02</b>
4			3	1		4	-			3	1		<b>659.SC5243-07</b>
6	6					4	DISC. 4P 40A		6				<b>659.SC5263-09</b>
6			6			4	DISC. 4P 63A			6			<b>659.SC5263-06</b>

- Upon request, versions can be built with the water kit (contact the CIT - Technical Information Centre)

#### KIOSK Series

659.



#### Sockets

#### RCBO 0,03A

#### Type SMART-K

no.	16A		Kit water	General	6A		PILLAR SMART-K - OMNIA IP56 Supply by terminal block
	2P+E	3P+N+E			2P	4P	
2	2			DISC. 4P 40A	2		<b>659.SK5221-01</b>
4	3	1		DISC. 4P 40A	3	1	<b>659.SK5241-04</b>
4	4		4	DISC. 4P 40A	4		<b>659.SK5243-08</b>
4	4			DISC. 4P 40A	4		<b>659.SK5241-02</b>

- Upon request, versions can be built with the water kit (contact the CIT - Technical Information Centre)

2.1



# Distribution assemblies

## GOMMA Series

### Rubber distribution assemblies

ASSEMBLIES

1

2

3

4

no.	Sockets				General	Max power	MCB				DISC.
	16A						16A				
	2P+E	3P+E	3P+N+E				1P	1P+N	3P	4P	
4	1	2		1	RCD 4P 40A 0,03A	18 KW	3			1	
4			4		RCD 4P 40A 0,03A	18 KW			2		
5		5			MCB 2P 16A RCD 2P 25A 0,03A	3 KW		1			5

- 1 Plug IEC309 32A 3P+E
- 2 Plug IEC309 16A 2P+E
- 3 Plug IEC309 32A 3P+N+E
- 3m rubber cable H07RN-F

### GOMMA Series

692.



no.	Sockets		General	Max power	MCB		RCD 0,03A		Two-front units	
	16A				2A	25A	DISTRIBUTION ASSEMBLY			
	2P+E				1P+N	4P	IP44			
6	6		-	2,3 KW	6	2			<b>692.4300-305</b>	1
8	8		-	4 KW	8	2			<b>692.4300-69</b>	1
8	8		-	3 KW	8				<b>692.4300-70</b>	1



ITALIAN STANDARD  
P30 2P+E 16A  
Shuttered socket CEI 23-50



2P+E 16A



3P+E 16A



3P+N+E 16A

**Distribution assemblies**  
GOMMA Series



**GOMMA Series**

690.



**Portable**  
**With cable and plug**

DISTRIBUTION ASSEMBLY	
IP44	
Plug	
<b>690.4200-301</b> <sup>3</sup>	1
<b>690.4200-295</b> <sup>1</sup>	1
<b>690.4200-300</b> <sup>2</sup>	1

2.1



# Distribution assemblies

## LV-LUX Series

### Distribution assemblies

LV-LUX Series  
630.



**Distribution assemblies  
for night-time power  
supply of lights  
indicating working areas**

DISTRIBUTION ASSEMBLY (ACS)

IP44

Plug

no.	Sockets		General		Max power		FUSES		Plug
	24V	2P	FUSES 5x20mm	Trafo	6,3A	12A			
2	2		FUSES 5x20mm 3,15A	Trafo 150 VA (230/24V)	1			<b>630.001</b>	1
2	2		FUSES 5x20mm 6,3A	Trafo 300 VA (230/24V)		1		<b>630.002</b>	1

- A light sensor turns the lights (see p.181) on and off according to the amount of atmospheric light.
- With twilight switch
- Provided with housing mod. SCABOX complete with lifting handle.
- Plug IEC309 16A 2P+E



24V



# Distribution assemblies

## TRANSFORMER Series

### ACS IP55 portable unit with safety and isolating transformer

TRANSFORMER Series

630.



ASSEMBLIES

1

2

3

4

no.	Sockets		MCB		230/48V version	
	48V	2P	10A	16A	DISTRIBUTION ASSEMBLY (ACS)	
			1P		IP55	
					Plug	
				2	<b>630.022</b>	1
			2		<b>630.021</b>	1

⚠ Safety transformer: SELV protection (230/24V and 230/48V).

- Rubber electric cable 2x1,5 mm<sup>2</sup> H07RN-F (length 1,5 m).
- MCB with operating time complying with D curve diagram.
- Note: the equipment must be kept outside narrow conducting spaces.
- Provided with housing mod. SCABOX complete with lifting handle.
- Plug IEC309 16A 2P+E



48V



2P+E 16A



# Distribution assemblies

## TRANSFORMER Series



### ACS IP55 portable unit with safety and isolating transformer

TRANSFORMER Series

630.



no.	Sockets		General	Max power	MCB		230/230V version	
	16A 2P+E	1			6A	10A	DISTRIBUTION ASSEMBLY (ACS)	IP55
1	1	1	MCB 2P 10A	Trafo 2000 VA (230/220V)		1	<b>630.032</b>	1
1	1	1	MCB 2P 6A	Trafo 1000 VA (230/220V)	1		<b>630.031</b>	1

- ⊕ Isolating transformer: electric shielding protection (230/230V).
- Rubber electric cable 2x1,5 mm<sup>2</sup> H07RN-F (length 1,5 m).
- MCB with operating time complying with D curve diagram.
- Note: the equipment must be kept outside narrow conducting spaces.
- Provided with housing mod. SCABOX complete with lifting handle.
- Plug IEC309 16A 2P+E

2.1



# Distribution assemblies

## MOBIL Series

### ACS IP55 distribution boxes with foldable stand

MOBIL Series

670.



Portable  
With cable and appliance  
inlet

1  
2  
3  
4  
ASSEMBLIES

Sockets

MCB

no.	Sockets					General	Max power	MCB		DISTRIBUTION ASSEMBLY (ACS)	
	16A			32A				16A		IP66	
	2P+E	3P+E	3P+N+E	3P+E	3P+N+E			1P	3P	Appliance inlet	
6	3	1	1		1	RCBO 4P 32A 0,03A	18 KW	2	2	<b>670.9566-458</b> <sup>1</sup>	1
6	3	1	2			RCBO 4P 32A 0,03A	18 KW	2	2	<b>670.9566-459</b> <sup>1</sup>	1
6	4	1	1			RCBO 4P 32A 0,03A	18 KW	2	2	<b>670.9566-457</b> <sup>1</sup>	1
6	4	1		1		RCBO 4P 32A 0,03A	18 KW	4	1	<b>670.9566-466</b> <sup>1</sup>	1
6	4		1	1		RCBO 4P 32A 0,03A	18 KW	4	1	<b>670.9566-456</b> <sup>1</sup>	1
6	4		1		1	RCBO 4P 32A 0,03A	18 KW	4	1	<b>670.9566-467</b> <sup>1</sup>	1
6	6					DISC. 4P 40A	18 KW	6		<b>670.9566-465</b> <sup>1</sup>	1
6	6					MCB 2P 16A RCD 2P 25A 0,03A	3 KW			<b>670.9566-464</b> <sup>2</sup>	1

<sup>1</sup> Appliance inlet IEC309 32A 3P+N+E

<sup>2</sup> Appliance inlet IEC309 16A 2P+E



2P+E 16A



3P+E 16A



3P+N+E 16A



3P+E 32A



3P+N+E 32A

# Distribution assemblies

## SALVAMOTORE Series



### ■ Stop-start units - IP55

#### MOTOR START UNITS Series

299.



Description	Version	Empty enclosure	
EMPTY ENCLOSURE	WITHOUT PLUG	<b>299.1600-00</b>	1/10

- Hinged cover fixed with stainless steel screws.
- Equipped DIN Rail and cable gland.
- Enclosure made of insulating material grey colour RAL 7035.
- Mounting by brackets.

#### MOTOR START UNITS Series

299.



Description	Version	Current	Poles	Volt	Motor power	Single phase stop-start unit	
STOP-START UNIT	THERMIC	16A	2P+E	230V	2,2kW (3,0CV)	<b>299.1693-00</b>	1/10
STOP-START UNIT	THERMIC+FUSE	16A	2P+E	230V	2,2kW (3,0CV)	<b>299.1693-01</b>	1/10
STOP-START UNIT	THERMIC+FUSE	16A	2P+E	230V		<b>299.1600-01</b>	1/10

- Hinged cover fixed with stainless steel screws.
- Appliance inlet EUREKA Series IP67 (SNAP-ON couplet).
- Enclosure made of insulating material grey colour RAL 7035.
- Mounting by brackets.
- With appliance inlet and 1,2m of H07RN-F (rubber cable).
- The combination relay + thermal device is set for a current not exceeding 16A.
- Motor power calculated with, rated voltage 230/400V and  $\cos \phi$  0,7.

2.1



## Distribution assemblies

### SALVAMOTORE Series

#### ■ Stop-start units - IP55

#### MOTOR START UNITS Series

299.



1

2

ASSEMBLIES

Description	Version	Current	Poles	Volt	Motor power	Stop-start unit
STOP-START UNIT	THERMIC	16A	3P+E	400V	4,8-7,7kW (6,6-10,5CV)	<b>299.1686-16</b> 1/10

- Hinged cover fixed with stainless steel screws.
- Appliance inlet EUREKA Series IP67 (SNAP-ON couplet).
- Enclosure made of insulating material grey colour RAL 7035.
- Mounting by brackets.
- With appliance inlet and 1,2m of H07RN-F (rubber cable).
- Motor power calculated with, rated voltage 230/400V and  $\cos \phi$  0,7.

3

4

#### ■ Motor cut-out - IP55

#### MOTOR START UNITS Series

299.



Single phase stop-start unit

Three phase stop-start unit

Current	Poles	Volt	Emergency current	Motor power	MOTOR STARTER	
16A	2P+E	230V	1,6-2,5A	0,2-0,4kW (0,3-0,5CV)	<b>299.1693-02</b>	1/10
16A	2P+E	230V	2,5-4,0A	0,4-0,6kW (0,5-0,9CV)	<b>299.1693-04</b>	1/10
16A	2P+E	230V	4,0-6,3A	0,6-1,0kW (0,9-1,4CV)	<b>299.1693-06</b>	1/10
16A	2P+E	230V	6,3-10A	1,0-1,6kW (1,4-2,2CV)	<b>299.1693-10</b>	1/10
16A	2P+E	230V	10-16A	1,6-2,6kW (2,2-3,5CV)	<b>299.1693-16</b>	1/10
16A	3P+E	400V	1,6-2,5A	0,7-1,2kW (1,0-1,5CV)	<b>299.1696-02</b>	1/10
16A	3P+E	400V	2,5-4,0A	1,2-1,9kW (1,5-2,5CV)	<b>299.1696-04</b>	1/10
16A	3P+E	400V	4,0-6,3A	1,9-3,0kW (2,5-4,1CV)	<b>299.1696-06</b>	1/10
16A	3P+E	400V	6,3-10A	3,0-4,8kW (4,1-6,6CV)	<b>299.1696-10</b>	1/10
16A	3P+E	400V	10-16A	4,8-7,7kW (6,6-10,5CV)	<b>299.1696-16</b>	1/10

- Hinged cover fixed with stainless steel screws.
- Appliance inlet EUREKA Series IP67 (SNAP-ON couplet).
- Enclosure made of insulating material grey colour RAL 7035.
- Mounting by brackets.
- With appliance inlet and 1,2m of H07RN-F (rubber cable).
- Motor power calculated with, rated voltage 230/400V and  $\cos \phi$  0,7.

# Distribution assemblies

## Accessories and spare parts



### ■ Accessories

#### ACCESSORIES

MP3.



Description	Notes	Current	Fuses
FUSE	Ø10,3X38 TYPE GG	16A	<b>MP36275</b>
	Ø13X50	6A	<b>MP36246</b>
	Ø13X50 RIT.	2A	<b>MP36247</b>
	Ø14X51 TYPE GG	32A	<b>MP36276</b>

#### ENCLOSURES ACCESSORIES

654.



#### Accessories and components

Suitable for	ACCESSORIES KIT
MBOX3 MBOX5	<b>654.0002</b> 10

- The kit includes: 5x35mm<sup>2</sup> terminal block, M40 cable gland, wall mounting brackets, blank plate for 4 DIN modules.

2.1



# Distribution assemblies

## Accessories and spare parts

### Accessories

#### ENCLOSURES ACCESSORIES

654.



Accessories and components

Suitable for

CABLE SUPPORT KIT

MBOX2

**654.0051**

10

1

2

ASSEMBLIES

3

4

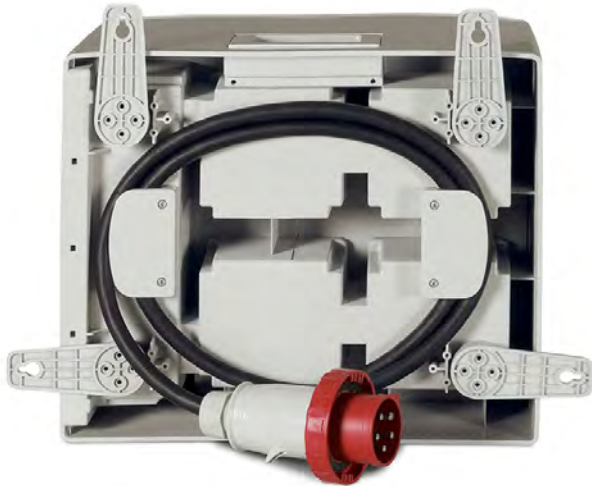

#### MBOX2 Series

Wall fixing brackets kit and cable support kit

# Distribution assemblies Accessories and spare parts



## ■ Accessories

### ENCLOSURES ACCESSORIES

654.



#### Accessories and components

#### Suitable for

DOMINO IP40 MBOX (WIN)

YALE KEY KIT

**654.0072** 1/10

- For DIN window. Unique Yale keys, the same key opens all locks.
- For door (2 pieces).

2.1



## Distribution assemblies Accessories and spare parts

### Accessories

#### ENCLOSURES ACCESSORIES

#### MBOX2 Series

#### MBOX3 Series

654.

656.

657.



1

2

ASSEMBLIES

3

4

Description	Dimension	Suitable for	Fixing kit	
SUPPORT		BLOCK4	<b>654.0600</b>	2
	376x691x70mm	DOMINO IP66 M550 OMNIA	<b>654.0610</b> <sup>[1]</sup>	1
STAND KIT		MBOX2	<b>656.0120</b>	1
		MBOX3 MBOX5		<b>657.0121</b>
				1

[1] Folding



**BLOCK Series**  
Support



**MOBIL Series**  
Support for DOMINO/OMNIA assemblies. The handy folding stand allows the panel to be transported even in limited-size motor vehicles.



# Distribution assemblies Accessories and spare parts



## ■ Accessories

### MBOX2 Series

656.



#### Description

#### Turret fixing

TURRET FIXING KIT	<b>656.0220</b>	1		
MOUNTING/FIXING PLATE				<b>656.0222</b> 1
BACK CLOSING PLATE			<b>656.0221</b> 1	



**MBOX Series**  
Pedestal application

2.1



## Distribution assemblies Accessories and spare parts

### ■ Spare parts

#### ENCLOSURES ACCESSORIES

654.



Knob kit (5 pz.)

#### Suitable for

KNOB KIT

OMNIA

**654.2110**

5/10

OMNIA (FUSE)

**654.2111**

#### ENCLOSURES ACCESSORIES

654.















Description	Notes	Din	Window for enclosures (5 pz.)	
WINDOW KIT	ADVANCE 212	10 DIN	<b>654.0190</b>	10
	ADVANCE 272	13 DIN	<b>654.0191</b>	10
	BLOCK1	4 DIN	<b>654.0181-01</b>	1/10
	BLOCK3	6 DIN	<b>654.0181-03</b>	5/10
	BLOCK4	11 DIN	<b>654.0181-04</b>	5/10
	BLOCK4 + YALE		<b>654.0181-04Y</b>	5/10
	BLOCK5	14 DIN	<b>654.0181-05</b>	5/10
	DOMINO IP66	4 DIN	<b>654.0180-04</b>	10
		8 DIN	<b>654.0180-08</b>	10
		12 DIN	<b>654.0180-12</b>	10
		16 DIN	<b>654.0180-16</b>	1/10
		24 DIN	<b>654.0180-24</b>	
		6 DIN	<b>654.0180-06</b>	10
	OMNIA 14DIN	14 DIN	<b>654.0181-07</b>	

## Distribution assemblies Accessories and spare parts



### ■ Spare parts >> Cover kit for socket (5 pz.)

			ADVANCE 2 Series	ADVANCE GRP Series	OMNIA Series	OPTIMA Series
654.						
						
			[ADVANCE2]	[ADVANCE-GRP]	[OMNIA]	[OPTIMA]
			COVER			
			IP66/IP67			
Current	Poles	Colour				
16A	2P+E		<b>654.13163</b>		<b>654.11163</b>	<b>654.16163</b> <small>25</small>
	3P+E		<b>654.13164</b>		<b>654.11164</b>	<b>654.16164</b>
	3P+N+E		<b>654.13165</b> <small>5/25</small>		<b>654.11165</b>	<b>654.16165</b>
32A	2P+E					<b>654.16323</b>
	3P+E		<b>654.13324</b>	<b>654.12324</b> <small>25</small>	<b>654.11324</b> <small>5/25</small>	<b>654.16324</b>
	3P+N+E		<b>654.13325</b> <small>5/25</small>	<b>654.12325</b> <small>25</small>	<b>654.11325</b>	<b>654.16325</b>
63A	2P+E					<b>654.16633</b>
	3P+E		<b>654.13634</b>		<b>654.11634</b>	
	3P+N+E		<b>654.13635</b>		<b>654.11635</b>	<b>654.16635</b>
125A	2P+E					<b>654.161253</b>
	3P+N+E					<b>654.161255</b>

- Suitable for sockets with thermoplastic pivot only

2.1



2.2

## Industrial adaptors

- ADAPTO Series  
Adaptors for industrial applications





# Industrial adaptors

## ADAPTO Series

### ■ ONE-WAY >> One-way adaptors >> With IEC 309 industrial plug

ADAPTO Series

610.



Sockets

16A

Italian standard socket outlets

2P+E

ONE-WAY ADAPTOR

IP20

Supply	Current	Poles	Volt	Icons			Notes		
Plug IEC309 16A	16A	2P+E	250V	1		1	1 BIV,+1 P30		
Plug IEC309 16A	16A	2P+E	250V	1		2	2 BIV,+1 P30		
Plug IEC309 16A	16A	2P+E	250V	1			1 P30	<b>610.372</b>	10/100
Plug IEC309 16A	16A	2P+E	250V		1		1 P40	<b>610.371</b>	10/100
Plug IEC309 16A	16A	2P+E	250V			1	1 BIV.		<b>610.380</b> 10/100
Plug IEC309 16A	16A	2P+E	250V			2	2 BIV.	<b>610.370</b>	10/100

- For temporary use only

ADAPTO Series

610.



Sockets

16A 13A 16A

European standard socket outlets

2P+E

ONE-WAY ADAPTOR

IP20

Supply	Current	Poles	Volt	Icons			Notes		
Plug IEC309 16A	10A	2P+E	250V	2			2 x SUISSE	<b>610.368</b>	10/100
Plug IEC309 16A	13A	2P+E	250V		1		BRITISH		
Plug IEC309 16A	13A	2P+E	250V		1		BRITISH 13A		
Plug IEC309 16A	15A	2P+E	250V		1		BRITISH 15A		
Plug IEC309 16A	16A	2P+E	250V			1	GERMAN		
Plug IEC309 16A	16A	2P+E	250V			1	FRENCH		
Plug IEC309 16A	16A	2P+E	250V			1	GERMAN	<b>610.373</b> <sup>1</sup>	10/100

<sup>1</sup> Shutterless socket, subject to normative restrictions or prohibitions in Europe or in other geographical areas. Check the national laws prior to using or installing it.

- For temporary use only



**ITALIAN STANDARD**  
P30 2P+E 16A  
Shuttered socket CEI 23-50



**SWISS STANDARD**  
2P+E 10A  
Unshuttered socket SEV 1011:1998



**BRITISH STANDARD**  
2P+E 13A  
Shuttered socket BS 1363-2



**GERMAN STANDARD**  
2P+E 16A  
Shuttered socket



**FRENCH STANDARD**  
2P+E 16A  
Shuttered socket



**ITALIAN STANDARD**  
P17/11 2P+E 16A  
Shuttered socket CEI 23-50



**PLURISTANDARD P40**  
2P+E 16A  
Shuttered socket



**Industrial adaptors**  
ADAPTO Series



ADAPTO Series

610.



**Italian standard socket outlets**

ONE-WAY ADAPTOR

IP20

			<b>610.390</b>	10/100
<b>610.382</b>	10/100	<b>610.388</b>	10/100	

ADAPTO Series

610.



**European standard socket outlets**

ONE-WAY ADAPTOR

IP20

IP54

				<b>610.392</b>	10/100
	<b>610.375</b>	10/100			
		<b>610.376</b>	10/100		
<b>610.374</b>	10/100		<b>610.381</b>	10/100	
				<b>610.391</b>	10/100

2.2



# Industrial adaptors

## ADAPTO Series

### ■ ONE-WAY >> One-way adaptors >> With IEC 309 industrial plug

ADAPTO Series

610.



International standard socket outlets

ONE-WAY ADAPTOR

IP20

Supply	Current	Poles	Volt					Notes		
Plug IEC309 16A	10A	2P+E	250V	1				1 BRASIL		
Plug IEC309 16A	10A	2P+E	250V	2				2 BRASIL	<b>610.395</b>	10/100
Plug IEC309 16A	10A	2P+E	250V			1		1 NEW ZEALAND		
Plug IEC309 16A	16A	2P+E	250V	1				ARGENTINIAN		<b>610.377</b> 10/100
Plug IEC309 16A	16A	2P+E	250V		1			SOUTH AFRICAN	<b>610.367</b>	10/100

- For temporary use only

### ■ ONE-WAY >> One-way adaptors

ADAPTO Series

610.



Sockets

16A

With domestic plug

Supply	Current	Poles	Volt	2P+E	Notes		
Plug IEC309 16A	16A	2P+E	250V	1	FR/DE	<b>610.379</b>	10/100
Plug 2P+E 16A IT Std	16A	2P+E	250V	1	ITALIAN S17		<b>610.384</b> 10/100
Plug 2P+E 16A D-F Std	16A	2P+E	250V	1	GERMAN	<b>610.383</b>	10/100

- For temporary use only



**ARGENTINIAN STANDARD 10A**  
Unshuttered socket



**BRAZILIAN STANDARD 10A**  
Unshuttered socket ABNT NBR 14136:2002



**NEW ZEALAND STANDARD 10A**  
Unshuttered socket AS/NZS 3112



**SOUTH AFRICAN STANDARD 16A**  
Shuttered socket SANS 164:1 (2006)



**2P+E 16A**



**Industrial adaptors**  
ADAPTO Series



ADAPTO Series

610.



International standard  
socket outlets

ONE-WAY ADAPTOR

IP20		IP54	
		<b>610.394</b>	10/100
<b>610.369</b>	10/100		
<b>610.378</b>	10/100		

2.2



# Industrial adaptors

## ADAPTO Series

### ONE-WAY

ASSEMBLIES

1

2

3

4

ADAPTO Series

610.



Sockets

16A    16A 230V    16A

Phase sequence adaptors

Supply	Current	Poles	Volt	Sockets		ONE-WAY ADAPTOR	
				3P+E	3P+N+E	IP44	
Plug IEC309 16A	16A	3P+E	230V	1		<b>610.3444</b>	10/50
			400V	1		<b>610.3646</b>	10/50
Plug IEC309 16A		3P+N+E			1	<b>610.3747</b>	10/50

- This device reverses the sequence of phases between the power supply and the rotating machine. It must be plugged in between the rotating machine plug and the power supply socket.
- Specially useful for temporary connection to the three-phase power supply of machines such as concrete mixers, small cranes, sanders, drills, circular saws, etc.
- For temporary use only

ADAPTO Series

610.



Sockets

16A    16A 230V

Current adaptors from 32A to 16A

Supply	Current	Poles	Volt	Sockets		ONE-WAY ADAPTOR	
				3P+E	2P+E	IP44	
Plug IEC309 32A	16A	3P+E	230V		1	<b>610.3464</b>	10
			400V	1		<b>610.3666</b>	10

- Used to supply 16A loads with 3P+E plugs from 32A 3P+E power supply sockets.
- The adaptor's 32A plug is first plugged into the 32A power supply socket and then the 16A plug of the load to be supplied is plugged into the adaptor's 16A socket.
- For temporary use only



3P+E 16A 230V



3P+E 16A



3P+N+E 16A



2P+E 16A

# Industrial adaptors

## ADAPTO Series



### ONE-WAY

#### ADAPTO Series

610.



#### Sockets

16A

Configuration adaptors  
from 3P+N+E to 3P+E

3P+N+E

ONE-WAY ADAPTOR



IP44

Supply	Current	Poles	Volt			
Plug IEC309 16A	16A	3P+N+E	400V	1	<b>610.3746</b>	10

- Used to supply 16A loads with 3P+E plugs from 16A 3P+N+E power supply sockets.
- The adaptor's 16A 3P+N+E plug is first plugged into the 16A 3P+N+E power supply socket and then the 16A 3P+E plug of the load to be supplied is plugged into the adaptor's 16A 3P+E socket.
- For temporary use only

### 2-WAY

#### ADAPTO Series

600.

601.



#### Sockets

16A 16A 230V 16A

With appliance inlet

Supply	Current	Poles	Volt	Sockets			MULTI-WAY ADAPTOR			
				2P+E	3P+E	3P+N+E	IP44	IP66		
Appliance inlet IEC309 16A	16A	2P+E	230V	2			<b>600.1623</b>	1/6	<b>601.1623</b>	1/6
		3P+E			2		<b>600.1624</b>	1/6		
		3P+E	400V		2		<b>600.1626</b>	1/6	<b>601.1626</b>	1/6
		3P+N+E		1	1		<b>600.1626/I<sup>1</sup></b>	1/6	<b>601.1626</b>	1/6
		3P+N+E	400V			2	<b>600.1629</b>	1/6	<b>601.1629</b>	1/6
		3P+N+E	400V			2	<b>600.1627</b>	1/6	<b>601.1627</b>	1/6

<sup>1</sup> One socket with reversed phases.

- 2-way adaptors
- Casing provided with lug for hanging from above (16A).

2.2



# Industrial adaptors

## ADAPTO Series

### 2-WAY

#### ADAPTO Series

604.

605.



#### Sockets

16A

32A

#### With cable and plug

#### MULTI-WAY ADAPTOR

Supply	Current	Poles	Volt	Sockets					Cable section	MULTI-WAY ADAPTOR			
				2P+E	3P+E	3P+N+E	3P+E	3P+N+E		IP44	IP66		
Plug IEC309 16A	16A	2P+E	230V	2					3x2,5mm <sup>2</sup>	<b>604.1623/C</b>	1/6	<b>605.1623/C</b>	1/6
Plug IEC309 16A		3P+E				2			4x4mm <sup>2</sup>	<b>604.1626/C</b>	1/6	<b>605.1626/C</b>	1/6
Plug IEC309 16A	32A	3P+N+E	400V	1	1				5x2,5mm <sup>2</sup>	<b>604.1629/C</b>	1/6	<b>605.1629/C</b>	1/6
							2				<b>604.1627/C</b>	1/6	<b>605.1627/C</b>
Plug IEC309 32A	32A	3P+E					2		4x4mm <sup>2</sup>	<b>604.3226/C</b> <sup>[2]</sup>	1/6	<b>605.3226/C</b> <sup>[2]</sup>	1/6
Plug IEC309 32A		3P+N+E						2	5x4mm <sup>2</sup>	<b>604.3227/C</b> <sup>[2]</sup>	1/6	<b>605.3227/C</b> <sup>[2]</sup>	1/6

[1] One socket with reversed phases.

[2] Zinc-plated steel carrying handle (32A).

- 2m rubber cable H07RN-F
- Equipped with PG21 cable gland, cable clamp and terminal block.

### 3-WAY

#### ADAPTO Series

606.



#### Sockets

16A 110V

16A

#### With appliance inlet

Supply	Current	Poles	Volt	Sockets			MULTI-WAY ADAPTOR			
				2P+E	3P+E	3P+N+E	IP44	IP66/IP67		
Appliance inlet IEC309 16A	16A	2P+E	230V		3		<b>606.3005-062</b>	1/6	<b>606.3505-062</b>	1/6
		3P+E				3	<b>606.3005-063</b>	1/6	<b>606.3505-063</b>	1/6
		3P+N+E	400V		2	1	<b>606.3005-059</b>	1/6	<b>606.3505-059</b>	1/6
Appliance inlet IEC309 16A 110V		2P+E	110V	3			<b>606.3005-479</b>	1/6	<b>606.3505-479</b>	1/6



2P+E 16A 110V



2P+E 16A



3P+E 16A



3P+N+E 16A



3P+E 32A



3P+N+E 32A

# Industrial adaptors

## ADAPTO Series



### 3-WAY

#### ADAPTO Series

606.



#### With cable and plug

Supply	Current	Poles	Volt	Sockets			Cable section	MULTI-WAY ADAPTOR	
				2P+E	3P+E	3P+N+E		IP44	IP66/IP67
Plug IEC309 16A	16A	2P+E	110V	3			3x2,5mm <sup>2</sup>		606.3515-479 1/6
			230V		3			606.3015-062 1/6	606.3515-062 1/6
Plug IEC309 16A	16A	3P+E	400V			3	4x2,5mm <sup>2</sup>	606.3015-063 1/6	606.3515-063 1/6
Plug IEC309 16A		3P+N+E		2	1	5x2,5mm <sup>2</sup>	606.3015-059 1/6	606.3515-059 1/6	
Plug IEC309 16A 110V	16A	2P+E	110V	3			3x2,5mm <sup>2</sup>	606.3015-740 6	606.3515-479 1/6

- 2m rubber cable H07RN-F
- Equipped with PG21 cable gland, cable clamp and terminal block.

### 3-WAY and 5-WAY

#### ADAPTO Series

603.



#### Without cable and plug (x3)

Supply	Current	Poles	Volt	Sockets			MULTI-WAY ADAPTOR	
				2P+E	3P+E	3P+N+E	IP44	IP66
Terminal block 16mm <sup>2</sup>	16A	2P+E	230V	3			603.3005-062 1/10	603.3505-062 1/10
Terminal block 16mm <sup>2</sup>	16A	3P+E	400V		3		603.3005-063 1/10	603.3505-063 1/10
Terminal block 16mm <sup>2</sup>	16A	3P+N+E	400V	2	1		603.3005-059 1/10	603.3505-059 1/10
Terminal block 16mm <sup>2</sup>	16A	3P+N+E	400V	2		1	603.3005-061 1/10	603.3505-061 1/10
Terminal block 16mm <sup>2</sup>	16A	3P+N+E	400V			3	603.3005-064 1/10	603.3505-064 1/10

- Zinc-plated steel carrying handle.
- Equipped with PG21 cable gland, cable clamp and terminal block.

2.2



# Industrial adaptors

## ADAPTO Series

### 3-WAY and 5-WAY

1  
2  
3  
4  
ASSEMBLIES

#### ADAPTO Series

603.



#### Sockets

16A

32A

Without cable and plug (x5)

Supply	Current	Poles	Volt	Sockets					MULTI -WAY ADAPTOR	
				2P+E	3P+E	3P+N+E	IP44			
Terminal block 16mm <sup>2</sup>	16A	2P+E	230V	2	3				<b>603.5005-358</b>	1/10
Terminal block 16mm <sup>2</sup>	16A	3P+N+E	400V	1	1		3		<b>603.5005-359</b>	1/10
Terminal block 16mm <sup>2</sup>	16A	3P+N+E	400V	2		1		1	<b>603.5005-427</b>	1/10
Terminal block 16mm <sup>2</sup>	16A	3P+N+E	400V	2		2	2		<b>603.5005-415</b>	1/10
Terminal block 16mm <sup>2</sup>	16A	3P+N+E	400V	2				3	<b>603.5005-360</b>	1/10

- Zinc-plated steel carrying handle.
- Equipped with PG21 cable gland, cable clamp and terminal block.

#### ADAPTO Series

602.



#### Sockets

16A

32A

With cable and plug (x3)

Supply	Current	Poles	Volt	Sockets					Cable section	MULTI -WAY ADAPTOR			
				2P+E	3P+E	3P+N+E	3P+E	3P+N+E		IP44	IP66		
Plug IEC309 16A	16A	2P+E	230V	3					3x2,5mm <sup>2</sup>	<b>602.3005-062</b>	1/6	<b>602.3505-062</b>	1/6
Plug IEC309 16A	16A	3P+E	400V		3				4x2,5mm <sup>2</sup>	<b>602.3005-063</b>	1/6	<b>602.3505-063</b>	1/6
Plug IEC309 16A	16A	3P+N+E	400V	2	1				5x2,5mm <sup>2</sup>	<b>602.3005-059</b>	1/6	<b>602.3505-059</b>	1/6
Plug IEC309 16A	16A	3P+N+E	400V	2		1			5x2,5mm <sup>2</sup>	<b>602.3005-061</b>	1/6	<b>602.3505-061</b>	1/6
Plug IEC309 16A	16A	3P+N+E	400V			3			5x2,5mm <sup>2</sup>	<b>602.3005-064</b>	1/6	<b>602.3505-064</b>	1/6
Plug IEC309 32A	32A	3P+E	400V				3		4x4mm <sup>2</sup>			<b>602.3505-443</b>	1/6
Plug IEC309 32A	32A	3P+N+E	400V					3	5x4mm <sup>2</sup>	<b>602.3005-215</b>	1/6		

- Zinc-plated steel carrying handle.
- 2m rubber cable H07RN-F
- Equipped with PG21 cable gland, cable clamp and terminal block.



**ITALIAN STANDARD**  
**P30 2P+E 16A**  
Shuttered socket CEI 23-50



**ITALIAN STANDARD**  
**P17/11 2P+E 16A**  
Shuttered socket CEI 23-50



**2P+E 16A**



**3P+E 16A**



**3P+N+E 16A**



**3P+E 32A**



**3P+N+E 32A**

# Industrial adaptors

## ADAPTO Series



### 3-WAY and 5-WAY

ADAPTO Series

602.



Sockets

16A

With cable and plug (x5)

Supply	Current	Poles	Volt	Sockets					Cable section	MULTI-WAY ADAPTOR	
				2P+E	3P+E	3P+N+E	IP44	IP66			
Plug IEC309 16A	16A	2P+E	230V	2	3			3x2,5mm <sup>2</sup>	<b>602.5005-358</b>	1/6	
Plug IEC309 16A	16A	3P+N+E	400V	1	1	3		5x2,5mm <sup>2</sup>	<b>602.5005-359</b>	1/6	
Plug IEC309 16A	16A	3P+N+E	400V	2			3	5x2,5mm <sup>2</sup>	<b>602.5005-360</b>	1/6	

- Zinc-plated steel carrying handle.
- 2m rubber cable H07RN-F
- Equipped with PG21 cable gland, cable clamp and terminal block.

### 3-WAY with protection devices >> Protection device: MCB

ADAPTO Series

623.



Sockets

16A

Without cable and plug

no.	Sockets			General	Max power	MULTI-WAY ADAPTOR	
	2P+E	3P+E				IP44	IP66
3	1	2		MCB 2P 16A	3 KW	<b>623.3000-056</b>	1
3		3		MCB 2P 16A	3 KW	<b>623.3000-062</b>	1
3			3	MCB 3P 16A	9 KW	<b>623.3000-063</b>	1

- Zinc-plated steel carrying handle.
- Equipped with PG21 cable gland, cable clamp and terminal block.

2.2



# Industrial adaptors

## ADAPTO Series

### ■ 3-WAY with protection devices >> Protection device: MCB

ADAPTO Series

625.



Sockets

no.	16A		General	Max power
	2P+E	3P+E		
3	1	2	MCB 4P 16A	9 KW
3	2	1	MCB 4P 16A	9 KW
3	3		MCB 2P 16A	3 KW
3		3	MCB 3P 16A	9 KW

Elevated installation

MULTI-WAY ADAPTOR

IP66

Supply by terminal block

					<b>625.3500-060</b>	1
					<b>625.3500-059</b>	1
					<b>625.3500-062</b>	1
					<b>625.3500-063</b>	1

- Tubular stand to be ordered separately
- Equipped with PG21 cable gland, cable clamp and terminal block.

### ■ 3-WAY with protection devices >> Protection devices: MCB+RCD

ADAPTO Series

623.



Sockets

no.	16A		General	Max power
	2P+E	3P+E		
3	1	2	MCB 2P 16A RCD 2P 25A 0,03A	3 KW
3		3	MCB 2P 16A RCD 2P 25A 0,03A	3 KW
3		3	RCBO 4P 16A 0,03A	9 KW

Without cable and plug

MULTI-WAY ADAPTOR

IP44

IP66

Direct supply to main switch

					<b>623.3006-054</b>	1	
					<b>623.3006-062</b>	1	<b>623.3506-062</b>
					<b>623.3006-063</b>	1	<b>623.3506-063</b>

- Zinc-plated steel carrying handle.
- Equipped with PG21 cable gland, cable clamp and terminal block.



ITALIAN STANDARD  
P17/11 2P+E 16A  
Shuttered socket CEI 23-50



2P+E 16A



3P+E 16A



ITALIAN STANDARD  
P30 2P+E 16A  
Shuttered socket CEI 23-50



3P+N+E 16A



# Industrial adaptors

## ADAPTO Series



### 3-WAY with protection devices >> Protection devices: MCB+RCD

ADAPTO Series

625.



Elevated installation

no.	Sockets		General	Max power	MULTI -WAY ADAPTOR	
	16A 2P+E	3P+E			IP66	Supply by terminal block
3	1	2	RCBO 4P 16A 0,03A	9 KW	<b>625.3506-060</b>	1
3	2	1	RCBO 4P 16A 0,03A	9 KW	<b>625.3506-059</b>	1
3	3		MCB 2P 16A RCD 2P 25A 0,03A	3 KW	<b>625.3506-062</b>	1

- Tubular stand to be ordered separately
- Equipped with PG21 cable gland, cable clamp and terminal block.

### 4-WAY

ADAPTO Series

623.



Without cable and plug

Current	Poles	Volt	Sockets			MULTI -WAY ADAPTOR		
			16A 2P+E	3P+E	3P+N+E	IP44	IP66	
16A	2P+E	230V	2	2		<b>623.4005-010</b>	1	Terminal block 16mm <sup>2</sup>
16A	2P+E	230V		4		<b>623.4005-012</b>	1	<b>623.4505-012</b>
16A	3P+N+E	400V		2	2	<b>623.4005-003</b>	1	<b>623.4505-003</b>
16A	3P+N+E	400V		2	2	<b>623.4005-006</b>	1	<b>623.4505-006</b>

- Zinc-plated steel carrying handle.
- Equipped with PG21 cable gland, cable clamp and terminal block.

2.2



# Industrial adaptors

## ADAPTO Series

### 4-WAY

ADAPTO Series

625.



ASSEMBLIES

1

2

3

4

Sockets

Elevated installation

Current	Poles	Volt	16A		MULTI-WAY ADAPTOR	
			2P+E	3P+E	IP66	Terminal block 16mm <sup>2</sup>
16A	2P+E	230V	4		<b>625.4505-012</b>	1
16A	3P+N+E	400V	2	2	<b>625.4505-003</b>	1

- Tubular stand to be ordered separately
- Equipped with PG21 cable gland, cable clamp and terminal block.



#### Elevated installation

Handle and cable gland not supplied for elevated-installation versions. The cable inlet is from below, where the adaptor is fastened to the stand.



2P+E 16A



3P+E 16A



# Industrial adaptors

## ADAPTO Series



### Accessories

#### ENCLOSURES ACCESSORIES

	654.	692.	
			
Description	Mounting bracket for compressed air	Tubular stand	Adaptors coupling kit
PLATE FOR COMP. AIR MOSE	<b>654.0050</b> 10		
TUBULAR STAND		<b>692.4340</b> 1	
ADAPTOR COUPLING KIT			<b>692.4342</b> <sup>1</sup> <sup>2</sup> 1/5

<sup>1</sup> 3-way and 4-way adaptors can be coupled together as shown in the drawing

<sup>2</sup> The kit includes all the screws, nuts, washers and seals required to couple together 3-way and 4-way adaptors.

2.2



## 2.3

### Industrial cable reels

- **AUTOROLLER Series**  
Cable reels with automatic rewind
- **ROLLER 330 Series**  
Cable reels for industrial, commercial and domestic applications
- **ROLLER-BLOCK 330 Series**  
Cable reels
- **ROLLER 450 Series**  
Cable reels for industrial applications
- **ROLLER-BLOCK 450 Series**  
Cable reels for industrial applications
- **ROLLER Series**  
Spare parts





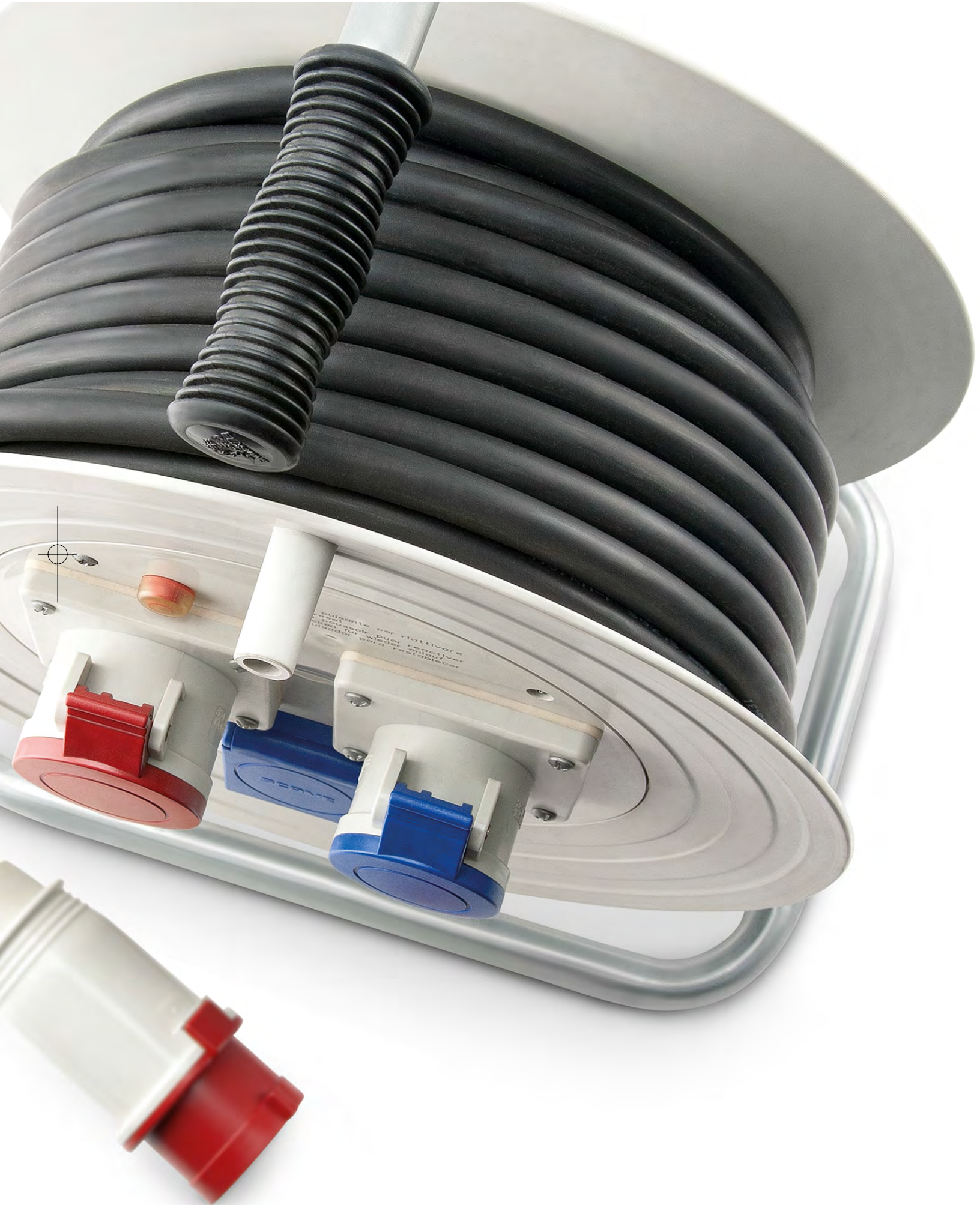

# Industrial cable reels

## AUTOROLLER Series

### Without plug and connector

AUTOROLLER Series

751.



With H05VV-F PVC cable

AUTOMATIC REWIND CABLE REEL

IP41

no.	Poles	Volt	Cable length	Cable section	@	⊙		
1	2P	250V	10m	2,5mm <sup>2</sup>	2000W	2300W	<b>751.0225-D</b>	1
			12m	1,5mm <sup>2</sup>	1500W	2100W	<b>751.0215-D</b>	1
			16m	1mm <sup>2</sup>	1100W	1400W	<b>751.0210-D</b>	1
	2P+E		8m	2,5mm <sup>2</sup>	2000W	2300W	<b>751.0325-D</b>	1
			12m	1,5mm <sup>2</sup>	1500W	2100W	<b>751.0315-D</b>	1
			14m	1mm <sup>2</sup>	1100W	1400W	<b>751.0310-D</b>	1

- Cable H05W-F (PVC)

### With plug and connector

AUTOROLLER Series

751.



With domestic plug and trailing socket for domestic application

AUTOMATIC REWIND CABLE REEL

IP40

no.	⏏	Current	Poles	Volt	Cable length	Cable section	@	⊙		
1	1	16A	2P+E	230V	12m	1,5mm <sup>2</sup>	1500W	2100W	<b>751.1315-D</b>	1

- Cable H05W-F (PVC)



ITALIAN STANDARD  
P17/11 2P+E 16A  
Shuttered socket CEI 23-50



Wound cable power



Unwound cable power

# Industrial cable reels

## AUTOROLLER Series



### ■ With plug and connector

#### AUTOROLLER Series

751.



**With portable Heavy Duty lamp**

AUTOMATIC REWIND CABLE REEL

IP20

Plug 2P 10A IT Std

Poles	Volt	Cable length	Cable section	@
2P	24V	16m	1mm <sup>2</sup>	60W
	230V			

<b>751.9210</b> <sup>[1]</sup>	1
<b>751.7210-D</b>	1

<sup>[2]</sup> SELV transformer 60 VA - 50 Hz

<sup>[1]</sup> Without thermal overload switch.

- Lampholder E27.
- Max. bulb 60 W.
- Protection on the transformer secondary: thermal overload switch.
- Cable H05VV-F (PVC)

2.3



## Industrial cable reels

### AUTOROLLER Series

#### ■ With plug and connector

#### HALE Series

770.



**Lamp with protective guard and zinc-plated steel reflector**

PORTABLE LAMP

HEAVY DUTY

IP20

**770.250**

1/24

#### Lamp holder

#### Cable length

E27

without cable

1

2

ASSEMBLIES

3

4

ⓘ Heavy Duty products are especially suited to greivous working conditions and are also resistant to highly salty environments

- Protective guard that can be opened for light bulb replacement.
- Lighting devices with protective guard and zinc-plated steel reflector:
- Handgrip in insulating, non-hygrosopic thermoplastic material with tilting system that prevents the lamp, when placed on a flat surface, to directly irradiate said surface and thus prevent dangerous overheating.
- Tapered cable gland
- Cable gland
- Adjustable hook.
- Rocker switch and screw clamp for cable replacement.
- For lamps up to 60W (incandescent)
- Screw cable stay.
- Cable H05W-F (PVC)



Wound cable power



# Industrial cable reels

## AUTOROLLER Series



### ■ With plug and connector

AUTOROLLER Series

756.



With portable lamp

AUTOMATIC REWIND CABLE REEL

IP40

Plug IEC309 16A

no.	Poles	Volt	Cable length	Cable section	@		
1	2P+E	230/24V	14m	1mm <sup>2</sup>	60W	<b>756.9211</b>	1

Ⓢ SELV transformer 60 VA - 50 Hz

- Lampholder E27.
- Max. bulb 60 W.
- Protection on the transformer secondary: thermal overload switch.
- Cable H07RN-F (RUBBER)

2.3



# Industrial cable reels

## ROLLER 330 Series

### ■ Cable reels for domestic and similar applications

ASSEMBLIES

1

2

3

4

Supply	no.	Sockets					Current	Poles	Volt	Cable length	Cable section
		16A		13A							
		2P+E									
Plug 2P+E 16A IT Std	1	1				16A	2P+E	230V	40m	1,5mm <sup>2</sup>	
Plug 2P+E 16A IT Std	1		1			16A	2P+E	230V	40m	1,5mm <sup>2</sup>	
Plug 2P+E 16A IT Std	1			1		16A	2P+E	230V	30m	1,5mm <sup>2</sup>	
Plug 2P+E 16A IT Std	1			1		16A	2P+E	230V	40m	1,5mm <sup>2</sup>	
Plug 2P+E 16A IT Std	4	2	2			16A	2P+E	230V	30m	2,5mm <sup>2</sup>	
Plug 2P+E 16A IT Std	4	2	2			16A	2P+E	230V	40m	1,5mm <sup>2</sup>	
Plug 2P+E 16A IT Std	4	3	1			16A	2P+E	230V	30m	2,5mm <sup>2</sup>	
Plug 2P+E 16A IT Std	4	3	1			16A	2P+E	230V	40m	1,5mm <sup>2</sup>	
Plug 2P+E 16A D-F Std	1		1			16A	2P+E	230V	40m	1,5mm <sup>2</sup>	
Plug 2P+E 16A D-F Std	2			2		16A	2P+E	230V	30m	2,5mm <sup>2</sup>	
Plug 2P+E 16A D-F Std	2			2		16A	2P+E	230V	40m	1,5mm <sup>2</sup>	
Plug 2P+E 16A D-F Std	4		4			16A	2P+E	230V	30m	2,5mm <sup>2</sup>	
Plug 2P+E 16A D-F Std	4		4			16A	2P+E	230V	40m	1,5mm <sup>2</sup>	
Plug 2P+E 16A D-F Std	4			4		16A	2P+E	230V	30m	2,5mm <sup>2</sup>	
Plug 2P+E 16A D-F Std	4			4		16A	2P+E	230V	40m	1,5mm <sup>2</sup>	
Plug 2P+E 13A GB Std	2				2	13A	2P+E	230V	30m	2,5mm <sup>2</sup>	
Plug 2P+E 13A GB Std	2				2	13A	2P+E	230V	40m	1,5mm <sup>2</sup>	

- Cable H05W-F (PVC)
- Note: Same domestic socket outlets guarantee protection degree IP44 when the lid is closed.
- Cable reels for domestic and similar applications:
- The maximum power supply is shown on every single item.



**ITALIAN STANDARD  
P30 2P+E 16A**  
Shuttered socket CEI 23-50



**BRITISH STANDARD  
2P+E 13A**  
Shuttered socket BS 1363-2



**FRENCH STANDARD  
2P+E 16A**  
Shuttered socket



**ITALIAN STANDARD  
P17/11 2P+E 16A**  
Shuttered socket CEI 23-50



**PLURISTANDARD P40  
2P+E 16A**  
Shuttered socket



Wound cable power



Unwound cable power

# Industrial cable reels

## ROLLER 330 Series



### ROLLER 330 Series

746.



With 4 socket outlets



With 2 socket outlets



With 1 socket outlet

#### DOMESTIC CABLE REEL

IP20

⊙	○				
1500W	3600W			<b>746.4005-897</b>	1
1500W	3600W			<b>746.4005-896</b>	1
2000W	3600W			<b>746.3005-894</b>	1
				<b>746.3005-895</b>	1
1500W	3600W			<b>746.4005-895</b>	1
2000W	3600W	<b>746.3000-010</b>	1		
1500W	3600W	<b>746.4000-010</b>	1		
2000W	3600W	<b>746.3000-385</b>	1		
1500W	3600W	<b>746.4000-385</b>	1		
1500W	3600W			<b>746.4005-898</b>	1
2000W	3600W			<b>746.3000-388</b>	1
1500W	3600W			<b>746.4000-388</b>	1
2000W	3600W	<b>746.3000-384</b>	1		
1500W	3600W	<b>746.4000-384</b>	1		
2000W	3600W	<b>746.3000-349</b>	1		
1500W	3600W	<b>746.4000-349</b>	1		
2000W	3600W			<b>746.3000-389</b>	1
1500W	3600W			<b>746.4000-389</b>	1

2.3



# Industrial cable reels

## ROLLER 330 Series

### ■ Cable reels for industrial applications

ASSEMBLIES

1

2

3

4

		Sockets					Current	Poles	Volt	Cable length	Cable section
		16A									
Supply	no.	2P+E	3P+E	3P+N+E							
Plug IEC309 16A	1		1			16A	2P+E	230V	30m	2,5mm <sup>2</sup>	
Plug IEC309 16A	2		2			16A	2P+E	230V	30m	2,5mm <sup>2</sup>	
Plug IEC309 16A	3	1	2			16A	2P+E	230V	30m	2,5mm <sup>2</sup>	
Plug IEC309 16A	3	1	2			16A	2P+E	230V	30m	2,5mm <sup>2</sup>	
Plug IEC309 16A	1			1		16A	3P+E	400V	30m	2,5mm <sup>2</sup>	
Plug IEC309 16A	2			2		16A	3P+E	400V	30m	2,5mm <sup>2</sup>	
Plug IEC309 16A	1				1	16A	3P+N+E	400V	20m	2,5mm <sup>2</sup>	
Plug IEC309 16A	2		1	1		16A	3P+N+E	400V	20m	2,5mm <sup>2</sup>	
Plug IEC309 16A	2				2	16A	3P+N+E	400V	20m	2,5mm <sup>2</sup>	
Plug IEC309 16A	3	1	1	1		16A	3P+N+E	400V	20m	2,5mm <sup>2</sup>	
Plug IEC309 16A	3	1		2		16A	3P+N+E	400V	20m	2,5mm <sup>2</sup>	
Plug IEC309 16A	3	1			2	16A	3P+N+E	400V	20m	2,5mm <sup>2</sup>	
Plug IEC309 16A	3	2		2		16A	3P+N+E	400V	20m	2,5mm <sup>2</sup>	

- Fully wired, ready to use.
- Cable H07RN-F (RUBBER)
- Note: Same domestic socket outlets guarantee protection degree IP44 when the lid is closed.
- Cable reels for industrial applications:
- The maximum power supply is shown on every single item.



**ITALIAN STANDARD**  
**P30 2P+E 16A**  
Shuttered socket CEI 23-50



**ITALIAN STANDARD**  
**P17/11 2P+E 16A**  
Shuttered socket CEI 23-50



**2P+E 16A**



**3P+E 16A**



**3P+N+E 16A**



**Wound cable power**



**Unwound cable power**

# Industrial cable reels

## ROLLER 330 Series



### ROLLER 330 Series

746.



With 1 interlocked switch socket outlet



With 2 socket outlets



With 2 IEC309 socket outlets and 1 domestic socket outlet

		INDUSTRIAL CABLE REEL			
⊙	⊙	IP55	IP44	IP55	IP20
1800W	3600W	<b>746.3512-350</b>			
		1			
1800W	3600W		<b>746.3010-077</b>	<b>746.3510-077</b>	
			1	1	
1800W	3600W				<b>746.3010-054</b>
					1
1800W	3600W				<b>746.3010-056</b>
					1
4500W	11000W	<b>746.3512-351</b>			
		1			
4500W	11000W		<b>746.3010-091</b>	<b>746.3510-091</b>	
			1	1	
5000W	11000W	<b>746.2512-352</b>			
		1			
5000W	11000W		<b>746.2010-075</b>	<b>746.2510-075</b>	
			1	1	
5000W	11000W		<b>746.2010-093</b>	<b>746.2510-093</b>	
			1	1	
5000W	11000W				<b>746.2010-052</b>
					1
5000W	11000W				<b>746.2010-101</b>
					1
5000W	11000W				<b>746.2010-102</b>
					1
5000W	11000W				<b>746.2010-390</b>
					1

2.3



# Industrial cable reels

## ROLLER-BLOCK 330 Series

### Cable reels

ASSEMBLIES

1

2

3

4

Sockets

16A

Supply	no.	Sockets			Current	Poles	Volt	Cable length	Cable section	@	⊙
		2P+E	3P+E	3P+N+E							
Plug IEC309 16A	1	1			16A	2P+E	230V	30m	2,5mm <sup>2</sup>	1800W	3600W
Plug IEC309 16A	1		1		16A	3P+E	400V	30m	2,5mm <sup>2</sup>	4500W	11000W
Plug IEC309 16A	1			1	16A	3P+N+E	400V	20m	2,5mm <sup>2</sup>	5000W	11000W

- Fully wired, ready to use.
- Cable H07RN-F (RUBBER)
- Note: Same domestic socket outlets guarantee protection degree IP44 when the lid is closed.
- Cable reels for industrial applications:
- The maximum power supply is shown on every single item.
- With standard for BLOCK4 Series distribution assemblies



2P+E 16A



3P+E 16A



3P+N+E 16A



Wound cable power



Unwound cable power

**Industrial cable reels**  
**ROLLER-BLOCK 330 Series**



**ROLLER 330 Series**

746.



**Cable reels with stand  
for BLOCK 4 Series  
distribution assemblies**

INDUSTRIAL CABLE REEL

IP44		IP55	
<b>746.3025-350</b>	1	<b>746.3525-350</b>	1
<b>746.3025-351</b>	1	<b>746.3525-351</b>	1
<b>746.2025-352</b>	1	<b>746.2525-352</b>	1

2.3





# Industrial cable reels

## ROLLER 450 Series

### ■ Cable reels for industrial applications

1  
2  
3  
4  
ASSEMBLIES

Sockets			
16A	32A	16A	
2P+E	3P+E	3P+N+E	

Supply	no.				Current	Poles	Volt	Cable length	Cable section	@
Plug IEC309 16A	4	4			16A	2P+E	230V	30m	2,5mm <sup>2</sup>	1800W
Plug IEC309 16A	4	4			16A	2P+E	230V	50m	2,5mm <sup>2</sup>	1600W
Plug IEC309 16A	4		4		16A	3P+E	400V	30m	2,5mm <sup>2</sup>	4500W
Plug IEC309 16A	4		4		16A	3P+E	400V	50m	2,5mm <sup>2</sup>	4000W
Plug IEC309 16A	4	2	2		16A	3P+N+E	400V	30m	2,5mm <sup>2</sup>	5000W
Plug IEC309 16A	4	2	2		16A	3P+N+E	400V	50m	2,5mm <sup>2</sup>	4000W
Plug IEC309 16A	4	2		2	16A	3P+N+E	400V	30m	2,5mm <sup>2</sup>	5000W
Plug IEC309 16A	4	2		2	16A	3P+N+E	400V	50m	2,5mm <sup>2</sup>	4000W
Plug IEC309 16A	4	3	1		16A	3P+N+E	400V	30m	2,5mm <sup>2</sup>	5000W
Plug IEC309 16A	4	3	1		16A	3P+N+E	400V	50m	2,5mm <sup>2</sup>	4000W
Plug IEC309 16A	4	3		1	16A	3P+N+E	400V	30m	2,5mm <sup>2</sup>	5000W
Plug IEC309 16A	4	3		1	16A	3P+N+E	400V	50m	2,5mm <sup>2</sup>	4000W
Plug IEC309 16A	4			4	16A	3P+N+E	400V	30m	2,5mm <sup>2</sup>	5000W
Plug IEC309 16A	4			4	16A	3P+N+E	400V	50m	2,5mm <sup>2</sup>	4000W
Plug IEC309 32A	4		4		32A	3P+E	400V	30m	2,5mm <sup>2</sup>	7000W

- Cable H07RN-F (RUBBER)
- Cable reels for industrial applications:
- The maximum power supply is shown on every single item.



2P+E 16A



3P+E 16A



3P+N+E 16A



3P+E 32A



Wound cable power



Unwound cable power



**Industrial cable reels**  
**ROLLER 450 Series**



**ROLLER 450 Series**

745.



**With 4 sockets**

**INDUSTRIAL CABLE REEL**

Ø	IP44		IP55	
	3600W	<b>745.3005-012</b>	1	<b>745.3505-012</b>
3600W	<b>745.5005-012</b>	1	<b>745.5505-012</b>	1
11000W	<b>745.3005-013</b>	1	<b>745.3505-013</b>	1
11000W	<b>745.5005-013</b>	1	<b>745.5505-013</b>	1
11000W	<b>745.3005-003</b>	1	<b>745.3505-003</b>	1
11000W	<b>745.5005-003</b>	1	<b>745.5505-003</b>	1
11000W	<b>745.3005-006</b>	1	<b>745.3505-006</b>	1
11000W	<b>745.5005-006</b>	1	<b>745.5505-006</b>	1
11000W	<b>745.3005-008</b>	1	<b>745.3505-008</b>	1
11000W	<b>745.5005-008</b>	1	<b>745.5505-008</b>	1
11000W	<b>745.3005-094</b>	1	<b>745.3505-094</b>	1
11000W	<b>745.5005-094</b>	1	<b>745.5505-094</b>	1
11000W	<b>745.3005-096</b>	1	<b>745.3505-096</b>	1
11000W	<b>745.5005-096</b>	1	<b>745.5505-096</b>	1
14000W	<b>745.3005-441</b>	1	<b>745.3505-441</b>	1

2.3



# Industrial cable reels

## ROLLER-BLOCK 450 Series

### ■ Cable reels for industrial applications

ASSEMBLIES

1

2

3

4

Supply	no.	Sockets					Current	Poles	Volt	Cable length	Cable section	
		16A		32A		16A						32A
		2P+E	3P+E	3P+N+E	3P+N+E	3P+N+E						
Plug IEC309 16A	1	1					16A	2P+E	230V	30m	2,5mm <sup>2</sup>	
Plug IEC309 16A	1	1					16A	2P+E	230V	50m	2,5mm <sup>2</sup>	
Plug IEC309 16A	1		1				16A	3P+E	400V	30m	2,5mm <sup>2</sup>	
Plug IEC309 16A	1		1				16A	3P+E	400V	50m	2,5mm <sup>2</sup>	
Plug IEC309 16A	1				1		16A	3P+N+E	400V	30m	2,5mm <sup>2</sup>	
Plug IEC309 16A	1				1		16A	3P+N+E	400V	50m	2,5mm <sup>2</sup>	
Plug IEC309 32A	1			1			32A	3P+E	400V	30m	4mm <sup>2</sup>	
Plug IEC309 32A	1					1	32A	3P+N+E	400V	30m	4mm <sup>2</sup>	

- Cable H07RN-F (RUBBER)
- Cable reels for industrial applications:
- With standard for BLOCK4 Series distribution assemblies



2P+E 16A



3P+E 16A



3P+N+E 16A



3P+E 32A



3P+N+E 32A



Wound cable power



Unwound cable power

**Industrial cable reels**  
**ROLLER-BLOCK 450 Series**



**ROLLER 450 Series**

749.



**Cable reels with wheeled stand for BLOCK4 Series distribution assemblies**

INDUSTRIAL CABLE REEL

	⊙	○	IP44		IP55	
			Code	Qty	Code	Qty
	1800W	3600W	<b>749.3005-350</b>	1	<b>749.3505-350</b>	1
	1600W	3600W	<b>749.5005-350</b>	1	<b>749.5505-350</b>	1
	4500W	11000W	<b>749.3005-351</b>	1	<b>749.3505-351</b>	1
	4000W	11000W	<b>749.5005-351</b>	1	<b>749.5505-351</b>	1
	5000W	11000W	<b>749.3005-352</b>	1	<b>749.3505-352</b>	1
	4000W	11000W	<b>749.5005-352</b>	1	<b>749.5505-352</b>	1
	7000W	14000W	<b>749.3005-353</b>	1	<b>749.3505-353</b>	1
	7000W	14000W	<b>749.3005-354</b>	1	<b>749.3505-354</b>	1

2.3



# Industrial cable reels

## ROLLER Series

### Spare parts (ROLLER 330)

#### ROLLER 330 Series

746.

Sockets

16A

2P+E

3P+E



Drum

Socket-holder disc

IP	Sockets				⊙	○	ROLLER 330 Series		
	⋮	⋯	●	●			DRUM FOR GENERIC USE	SOCKET-HOLDER DISC	
IP20	1		1	1	5000W	11000W			
	1		2					<b>746.2010-052.P</b>	1
	2	2						<b>746.3010-054.P</b>	1
	2	2						<b>746.3000-010.P</b>	1
	3	1						<b>746.4000-010.P</b>	1
IP44			2				<b>746.3000-385.P</b>	1	
			2				<b>746.4000-385.P</b>	1	
			2				<b>746.3010-056.P</b>	1	
IP55			2				<b>746.3010-077.P</b>	1	
			2				<b>746.3510-077.P</b>	1	
							<b>746.3510-091.P</b>	1	
							<b>746.0000-000</b>	1	

1  
2  
ASSEMBLIES

3  
4



**ITALIAN STANDARD**  
**P30 2P+E 16A**  
Shuttered socket CEI 23-50



**ITALIAN STANDARD**  
**P17/11 2P+E 16A**  
Shuttered socket CEI 23-50



**2P+E 16A**



**3P+E 16A**



**Wound cable power**



**Unwound cable power**





# Industrial cable reels

## ROLLER Series



### ■ Spare parts (ROLLER 450)

#### ROLLER 450 Series

Sockets				ROLLER 450 Series		745.	
16A							
2P+E 3P+E				<b>Drum</b>		<b>Socket-holder disc</b>	
IP	no.			Cable length	@	⊙	
IP55	4	1	1	50m	5000W	11000W	DRUM FOR GENERIC USE
		4		30m			SOCKET-HOLDER DISC
							<b>745.5505-006.P</b> 1
							<b>745.5505-012.P</b> 1
							<b>745.3505-012.P</b> 1
							<b>745.0000-000</b> 1



ROLLER Series  
Internal wiring

2.3



# Industrial cable reels

## ROLLER Series

### Disassembled

1  
2  
3  
4  
ASSEMBLIES

#### ROLLER 330 Series

SC9.



Description	Notes	Disassembled (ROLLER 330)
CABLE REEL WITHOUT HOLDER DISC	OPEN DRUM ROLLER 330	<b>SC92063</b> 20
	ROLLER 330	<b>SC92062</b> 20
1 IND. SOCKET HOLDER DISC	1x(70x87mm)	<b>SC92082</b>
1 OMNIA SOCKET HOLDER DISC	1x(136x125mm)	<b>SC92078</b>
	2x(70x87mm)	<b>SC92080</b> 80
2 IND. SOCKET HOLDER DISC	2x(75x75mm)	<b>SC92074</b> 80
	2x(75x75mm)+1x(50x60mm)	<b>SC92076</b>
3 DOMESTIC SOCKETS HOLDER DISC	3x(50x60mm)	<b>SC92070</b>
4 DOMESTIC SOCKETS HOLDER DISC	4x(50x60mm)	<b>SC92072</b> 80
BLANK SOCKET HOLDER DISC 330	BLANK	<b>SC92068</b> 80

#### ROLLER 330 Series

SC9.



Description	Notes	Disassembled (ROLLER-BLOCK 330)
CABLE REEL WITHOUT HOLDER DISC	ROLLER-BLOCK 330	<b>SC92064</b> 1
1 IND. SOCKET HOLDER DISC	1x(70x87mm)	<b>SC92082</b>
1 OMNIA SOCKET HOLDER DISC	1x(136x125mm)	<b>SC92078</b>
	2x(70x87mm)	<b>SC92080</b> 80
2 IND. SOCKET HOLDER DISC	2x(75x75mm)	<b>SC92074</b> 80
	2x(75x75mm)+1x(50x60mm)	<b>SC92076</b>
3 DOMESTIC SOCKETS HOLDER DISC	3x(50x60mm)	<b>SC92070</b>
4 DOMESTIC SOCKETS HOLDER DISC	4x(50x60mm)	<b>SC92072</b> 80
BLANK SOCKET HOLDER DISC 330	BLANK	<b>SC92068</b> 80

# Industrial cable reels

## ROLLER Series



### Disassembled

#### ROLLER 450 Series

SC9.



Description	Notes	Disassembled (ROLLER 450)	
CABLE REEL WITHOUT HOLDER DISC	ROLLER 450	<b>SC92065</b>	1
1 IND. SOCKET HOLDER DISC	1x(75x75mm)	<b>SC92086</b>	1
3 IND. SOCKET HOLDER DISC	3x(70x87mm)	<b>SC92092</b>	1
4 IND. SOCKET HOLDER DISC	4x(75x75mm)	<b>SC92089</b>	1
BLANK SOCKET HOLDER DISC 450	BLANCK	<b>SC92088</b>	1
1 QUADRA SOCKET HOLDER DISC	1x(136x172mm)	<b>SC92094</b>	1
6 DOMESTIC SOCKETS HOLDER DISC	6x(50x60mm)	<b>SC92085</b>	1

#### ROLLER 450 Series

SC9.



Description	Notes	Disassembled (ROLLER-BLOCK 450)	
CABLE REEL WITHOUT HOLDER DISC	ROLLER-BLOCK 450	<b>SC92066</b>	1
1 IND. SOCKET HOLDER DISC	1x(75x75mm)	<b>SC92086</b>	1
3 IND. SOCKET HOLDER DISC	3x(70x87mm)	<b>SC92092</b>	1
4 IND. SOCKET HOLDER DISC	4x(75x75mm)	<b>SC92089</b>	1
BLANK SOCKET HOLDER DISC 450	BLANCK	<b>SC92088</b>	1
1 QUADRA SOCKET HOLDER DISC	1x(136x172mm)	<b>SC92094</b>	1
6 DOMESTIC SOCKETS HOLDER DISC	6x(50x60mm)	<b>SC92085</b>	1

2.3



3

# ACCESSORIES

Components and accessories  
for electrical installations



3.1	Installation accessories	PAG. 462
3.2	Connecting accessories	PAG. 484
3.3	Conduit	PAG. 498
3.4	Trunking systems	PAG. 508

## 3.1

# Installation accessories

- **UNION Series**  
Installation accessories
- **TIES Series**  
Cable ties
- **FIXO Series**  
Fastening accessories
- **CABLO Series**  
INSTALLATION Accessories
- **FASTY Series**  
Cable clips and insulated pins
- **RAILDIN Series**  
Metallic DIN rails

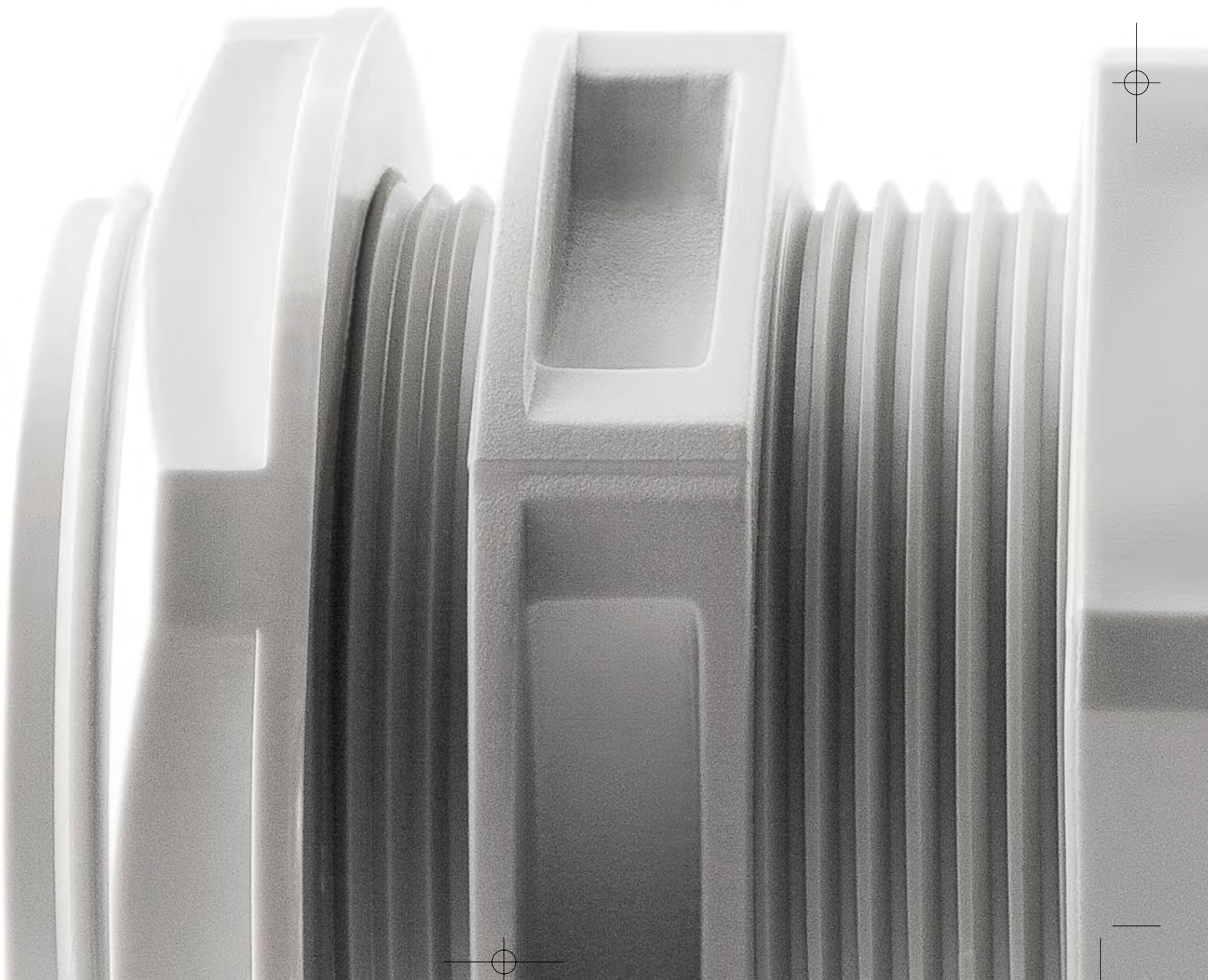

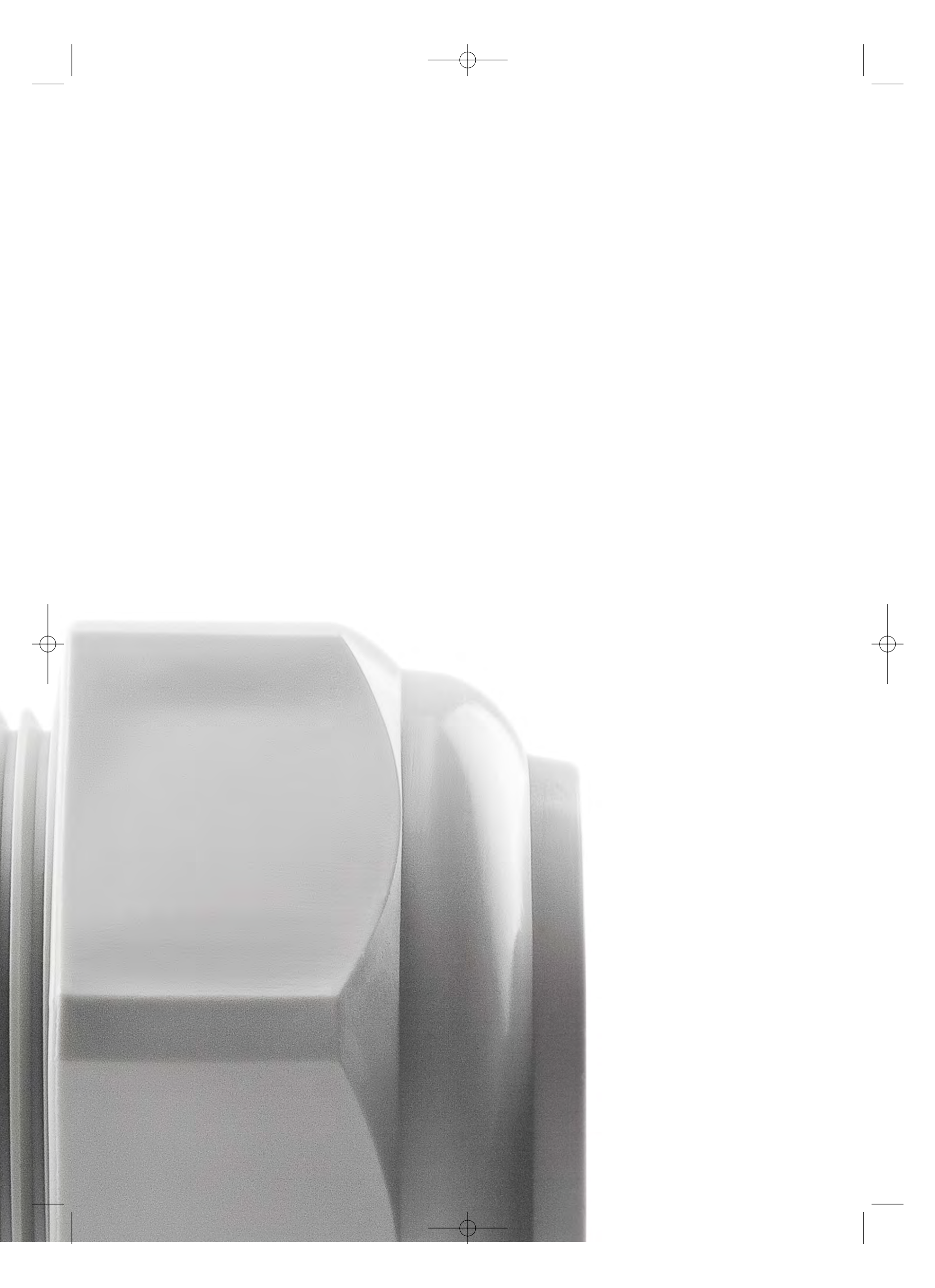

## Installation accessories

### UNION Series

#### ■ Cable glands >> Anti-tear cable glands [LIGHT] - With device preventing any unscrewing

UNION Series

805.



With nut, without diaphragm - IP66

CABLE GLAND

IP66

LIGHT

Cable outlet	Fixing hole	Cable size	Spanner size	Thread length	Nut spanner coupler	Seal spanner coupler		
1/4"	ø13mm	ø3-6mm	15mm	9,5mm	2,5N/m	2,5N/m	<b>805.7340</b>	50/600
3/8"	ø16mm	ø4-8mm	19mm	9,5mm	4N/m	2,5N/m	<b>805.7341</b>	50/600
1/2"	ø21mm	ø7-12mm	24mm	12mm	6N/m	5N/m	<b>805.7343</b>	25/500
5/8"	ø23mm	ø10-14mm	27mm	12mm	6N/m	5,5N/m	<b>805.7344</b>	25/300
3/4"	ø29mm	ø13-18mm	33mm	14mm	9N/m	7N/m	<b>805.7345</b>	25/400
1"	ø37,5mm	ø18-25mm	42mm	15mm	14N/m	10N/m	<b>805.7346</b>	25/350
1.1/8"	ø37,5mm	ø18-25mm	42mm	15mm	14N/m	10N/m	<b>805.7347</b>	10/140
1.1/2"	ø47,5mm	ø22-32mm	53mm	17,5mm	15N/m	12,5N/m	<b>805.7348</b>	10/140
2"	ø60mm	ø34-44mm	68mm	20mm	15N/m	12,5N/m	<b>805.7349</b>	10/100
M12X1,5	ø12mm	ø3-6mm	15mm	9,5mm	2,5N/m	2,5N/m	<b>805.5412</b>	50/600
M16X1,5	ø16mm	ø4-8mm	19mm	9,5mm	4N/m	2,5N/m	<b>805.5416</b>	50/600
M20X1,5	ø20mm	ø7-12mm	24mm	12mm	6N/m	5N/m	<b>805.5420</b>	25/500
M25X1,5	ø25mm	ø13-18mm	33mm	14mm	9N/m	5,5N/m	<b>805.5425</b>	25/400
M32X1,5	ø32mm	ø18-25mm	42mm	15mm	14N/m	7N/m	<b>805.5432</b>	25/350
M40X1,5	ø40mm	ø22-32mm	53mm	17,5mm	15N/m	11,5N/m	<b>805.5440</b>	10/140
M50X1,5	ø50mm	ø30-38mm	60mm	19mm	15N/m	11,5N/m	<b>805.5450</b>	10/100
M63X1,5	ø63mm	ø34-44mm	68mm	14mm	15N/m	11,5N/m	<b>805.5463</b>	10/100
PG 7	ø13mm	ø3-6mm	15mm	9,5mm	2,5N/m	2,5N/m	<b>805.3340</b>	50/600
PG 9	ø16mm	ø4-8mm	19mm	9,5mm	4N/m	2,5N/m	<b>805.3341</b>	50/600
PG 11	ø19mm	ø5-10mm	22mm	10mm	5,5N/m	5N/m	<b>805.3342</b>	25/500
PG 13.5	ø21mm	ø7-12mm	24mm	12mm	6N/m	5N/m	<b>805.3343</b>	25/600
PG 16	ø23mm	ø10-14mm	27mm	12mm	6N/m	5,5N/m	<b>805.3344</b>	25/300
PG 21	ø29mm	ø13-18mm	33mm	14mm	9N/m	7N/m	<b>805.3345</b>	25/400
PG 29	ø37,5mm	ø18-25mm	42mm	15mm	14N/m	10N/m	<b>805.3346</b>	25/350
PG 36	ø47,5mm	ø22-32mm	53mm	17,5mm	15N/m	12,5N/m	<b>805.3347</b>	10/140
PG 42	ø54,5mm	ø30-38mm	60mm	19mm	15N/m	12,5N/m	<b>805.3348</b>	10/100
PG 48	ø60mm	ø34-44mm	68mm	20mm	15N/m	12,5N/m	<b>805.3349</b>	10/100

- Cable glands are provided without gasket
- STANDARD version: IP66

1  
2  
3

ACCESSORIES

4



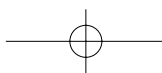

## Installation accessories UNION Series



### UNION Series

805.



Without nut, without  
diaphragm - IP66



With nut and diaphragm -  
IP66



Without nut, with  
diaphragm - IP66

CABLE GLAND

IP66

LIGHT

**805.5412.0** 50/600

**805.5416.0** 50/600

**805.5420.0** 25/500

**805.5425.0** 25/400

**805.5432.0** 25/350

**805.5440.0** 10/140

**805.5450.0** 10/100

**805.5463.0** 10/100

**805.3340.0** 50/600

**805.3341.0** 50/600

**805.3342.0** 25/500

**805.3343.0** 25/500

**805.3344.0** 25/300

**805.3345.0** 25/400

**805.3346.0** 25/350

**805.3347.0** 10/140

**805.3348.0** 10/100

**805.3349.0** 10/100

**805.5412.1** 50/600

**805.5416.1** 50/600

**805.5420.1** 25/500

**805.5425.1** 25/400

**805.5432.1** 25/350

**805.5440.1** 10/140

**805.5450.1** 10/100

**805.5463.1** 10/100

**805.3340.1** 50/600

**805.3341.1** 50/600

**805.3342.1** 25/500

**805.3343.1** 25/500

**805.3344.1** 25/300

**805.3345.1** 25/400

**805.3346.1** 25/350

**805.3347.1** 10/140

**805.3348.1** 10/100

**805.3349.1** 10/100

**805.5412.2** 50/600

**805.5416.2** 50/600

**805.5420.2** 25/500

**805.5425.2** 25/400

**805.5432.2** 25/350

**805.5440.2** 10/140

**805.5450.2** 10/100

**805.5463.2** 10/100

**805.3340.2** 50/600

**805.3341.2** 50/600

**805.3342.2** 25/500

**805.3343.2** 25/500

**805.3344.2** 25/300

**805.3345.2** 25/400

**805.3346.2** 25/350

**805.3347.2** 10/140

**805.3348.2** 10/100

**805.3349.2** 10/100

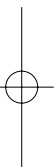
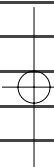

3.1

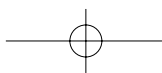

## Installation accessories

### UNION Series

#### ■ Cable glands >> Anti-tear cable glands [HEAVY DUTY] - With device preventing any unscrewing

UNION Series

805.



With nut, without diaphragm - IP68 (1bar)

CABLE GLAND

IP68

HEAVY DUTY

Cable outlet	Fixing hole	Cable size	Spanner size	Thread length	Nut spanner coupler	Seal spanner coupler		
1/4"	ø13mm	ø3-6mm	15mm	9,5mm	2,5N/m	2,5N/m	<b>805.7350</b>	50/600
3/8"	ø16mm	ø4-8mm	19mm	9,5mm	4N/m	2,5N/m	<b>805.7351</b>	50/600
1/2"	ø21mm	ø7-12mm	24mm	12mm	6N/m	5N/m	<b>805.7353</b>	25/500
5/8"	ø23mm	ø10-14mm	27mm	12mm	6N/m	5,5N/m	<b>805.7354</b>	25/300
3/4"	ø29mm	ø13-18mm	33mm	14mm	9N/m	7N/m	<b>805.7355</b>	25/400
1"							<b>805.7356</b>	25/350
1.1/8"	ø37,5mm	ø18-25mm	42mm	15mm	14N/m	10N/m	<b>805.7357</b>	10/140
1.1/2"	ø47,5mm	ø22-32mm	53mm	17,5mm	15N/m	12,5N/m	<b>805.7358</b>	10/140
2"	ø60mm	ø34-44mm	68mm	20mm	15N/m	12,5N/m	<b>805.7359</b>	10/100
M12X1,5	ø12mm	ø3-6mm	15mm	9,5mm	2,5N/m	2,5N/m	<b>805.5512</b>	50/600
M16X1,5	ø16mm	ø4-8mm	19mm	9,5mm	4N/m	2,5N/m	<b>805.5516</b>	50/600
M20X1,5	ø20mm	ø7-12mm	24mm	12mm	6N/m	5N/m	<b>805.5520</b>	25/500
M25X1,5	ø25mm	ø13-18mm	33mm	14mm	9N/m	5,5N/m	<b>805.5525</b>	25/400
M32X1,5	ø32mm	ø18-25mm	42mm	15mm	14N/m	7N/m	<b>805.5532</b>	25/350
M40X1,5	ø40mm	ø22-32mm	53mm	17,5mm	15N/m	11,5N/m	<b>805.5540</b>	10/140
M50X1,5	ø50mm	ø30-38mm	60mm	19mm	15N/m	11,5N/m	<b>805.5550</b>	10/100
M63X1,5	ø63mm	ø34-44mm	68mm	14mm	15N/m	11,5N/m	<b>805.5563</b>	10/100
PG 7	ø13mm	ø3-6mm	15mm	9,5mm	2,5N/m	2,5N/m	<b>805.3350</b>	50/600
PG 9	ø16mm	ø4-8mm	19mm	9,5mm	4N/m	2,5N/m	<b>805.3351</b>	50/600
PG 11	ø19mm	ø5-10mm	22mm	10mm	5,5N/m	5N/m	<b>805.3352</b>	25/500
PG 13.5	ø21mm	ø7-12mm	24mm	12mm	6N/m	5N/m	<b>805.3353</b>	25/500
PG 16	ø23mm	ø10-14mm	27mm	12mm	6N/m	5,5N/m	<b>805.3354</b>	25/300
PG 21	ø29mm	ø13-18mm	33mm	14mm	9N/m	7N/m	<b>805.3355</b>	25/400
PG 29	ø37,5mm	ø18-25mm	42mm	15mm	14N/m	10N/m	<b>805.3356</b>	25/350
PG 36	ø47,5mm	ø22-32mm	53mm	17,5mm	15N/m	12,5N/m	<b>805.3357</b>	10/140
PG 42	ø54,5mm	ø30-38mm	60mm	19mm	15N/m	12,5N/m	<b>805.3358</b>	10/100
PG 48	ø60mm	ø34-44mm	68mm	20mm	15N/m	12,5N/m	<b>805.3359</b>	10/100

- Fixing type A (metric HD).
- HEAVY DUTY version IP66 or IP68 (1 bar) if installed with corresponding seal.



HD  
Heavy Duty

# Installation accessories

## UNION Series



### Accessories

#### UNION Series

805.



Nuts [LIGHT]



Nuts [HEAVY DUTY]

Screw caps

Seals - Thermoplastic

LOCK NUT

SCREW CAP

GASKET

LIGHT

HEAVY DUTY

LIGHT

#### Cable outlet

	LIGHT		HEAVY DUTY		LIGHT			
M12X1,5	<b>805.5612</b> <sup>[2]</sup>	100/1000	<b>805.5712</b> <sup>[3]</sup>	100/1000	<b>805.5812</b> <sup>[1]</sup>	100/1000	<b>805.5912</b>	100/1000
M16X1,5	<b>805.5616</b> <sup>[2]</sup>	100/1000	<b>805.5716</b> <sup>[3]</sup>	100/1000	<b>805.5816</b> <sup>[1]</sup>	100/1000	<b>805.5916</b>	100/1000
M20X1,5	<b>805.5620</b> <sup>[2]</sup>	100/1000	<b>805.5720</b> <sup>[3]</sup>	100/1000	<b>805.5820</b> <sup>[1]</sup>	100/1000	<b>805.5920</b>	100/1000
M25X1,5	<b>805.5625</b> <sup>[2]</sup>	100/1000	<b>805.5725</b> <sup>[3]</sup>	100/1000	<b>805.5825</b> <sup>[1]</sup>	100/1000	<b>805.5925</b>	100/1000
M32X1,5	<b>805.5632</b> <sup>[2]</sup>	50/500	<b>805.5732</b> <sup>[3]</sup>	50/500	<b>805.5832</b> <sup>[1]</sup>	50/500	<b>805.5932</b>	100/1000
M40X1,5	<b>805.5640</b> <sup>[2]</sup>	50/500	<b>805.5740</b> <sup>[3]</sup>	50/500	<b>805.5840</b> <sup>[1]</sup>	25/250	<b>805.5940</b>	50/500
M50X1,5	<b>805.5650</b> <sup>[2]</sup>	50/500	<b>805.5750</b> <sup>[3]</sup>	50/500	<b>805.5850</b> <sup>[1]</sup>	25/250	<b>805.5950</b>	50/500
M63X1,5	<b>805.5663</b> <sup>[2]</sup>	50/500	<b>805.5763</b> <sup>[3]</sup>	50/500	<b>805.5863</b> <sup>[1]</sup>	25/250	<b>805.5963</b>	50/500
PG 7	<b>805.3360</b> <sup>[2]</sup>	100/1000	<b>805.3370</b> <sup>[3]</sup>	100/1000	<b>805.3380</b> <sup>[1]</sup>	100/1000	<b>805.3390</b>	100/1000
PG 9	<b>805.3361</b> <sup>[2]</sup>	100/1000	<b>805.3371</b> <sup>[3]</sup>	100/1000	<b>805.3381</b> <sup>[1]</sup>	100/1000	<b>805.3391</b>	100/1000
PG 11	<b>805.3362</b> <sup>[2]</sup>	100/1000	<b>805.3372</b> <sup>[3]</sup>	100/1000	<b>805.3382</b> <sup>[1]</sup>	100/1000	<b>805.3392</b>	100/1000
PG 13.5	<b>805.3363</b> <sup>[2]</sup>	100/1000	<b>805.3373</b> <sup>[3]</sup>	100/1000	<b>805.3383</b> <sup>[1]</sup>	100/1000	<b>805.3393</b>	100/1000
PG 16	<b>805.3364</b> <sup>[2]</sup>	100/1000	<b>805.3374</b> <sup>[3]</sup>	100/1000	<b>805.3384</b> <sup>[1]</sup>	100/1000	<b>805.3394</b>	100/1000
PG 21	<b>805.3365</b> <sup>[2]</sup>	100/1000	<b>805.3375</b> <sup>[3]</sup>	100/1000	<b>805.3385</b> <sup>[1]</sup>	100/1000	<b>805.3395</b>	100/1000
PG 29	<b>805.3366</b> <sup>[2]</sup>	50/500	<b>805.3376</b> <sup>[3]</sup>	50/500	<b>805.3386</b> <sup>[1]</sup>	50/500	<b>805.3396</b>	50/500
PG 36	<b>805.3367</b> <sup>[2]</sup>	50/500	<b>805.3377</b> <sup>[3]</sup>	50/500	<b>805.3387</b> <sup>[1]</sup>	25/250	<b>805.3397</b>	50/500
PG 42	<b>805.3368</b> <sup>[2]</sup>	50/500	<b>805.3378</b> <sup>[3]</sup>	50/500	<b>805.3388</b> <sup>[1]</sup>	25/250	<b>805.3398</b>	50/500
PG 48	<b>805.3369</b> <sup>[2]</sup>	50/500	<b>805.3379</b> <sup>[3]</sup>	50/500	<b>805.3389</b> <sup>[1]</sup>	25/250	<b>805.3399</b>	50/500

[1] Without nut.

[2] STANDARD version: IP66

[3] HEAVY DUTY version IP66 or IP68 (1 bar) if installed with corresponding seal.

3.1



## Installation accessories UNION Series

### Installation accessories

#### UNION Series

805.



#### Couplers - IP66 With nut and seal

##### COUPLER

IP66

LIGHT

HEAVY DUTY

Cable outlet	Cable size	LIGHT		HEAVY DUTY	
M25X1,5	19,6mm	<b>805.5225</b>	10/50	<b>805.5325</b>	10/50
M40X1,5	33,6mm	<b>805.5240</b>	5/25	<b>805.5340</b>	5/25
PG 16		<b>805.3334</b> <sup>1</sup>	10/50		
PG 21	22mm	<b>805.3335</b>	10/50		
PG 29	27,8mm	<b>805.3336</b>	10/50		
PG 36	38,7mm	<b>805.3337</b>	5/25		

<sup>1</sup> Only for surface mounting enclosure.



APPLICATION EXAMPLE

1

2

3

ACCESSORIES

4



# Installation accessories

## UNION Series



### ■ Cable sleeves

#### UNION Series

805.



**Cable sleeves (insulating perforation) - IP55 [RUBBER]**

**Cable sleeves (5 circles) - IP55 [PVC]**

**Cable sleeves (5 circles) - IP55 [RUBBER]**

CABLE SLEEVE

IP55

Cable outlet	Fixing hole	Cable sleeves (insulating perforation) - IP55 [RUBBER]		Cable sleeves (5 circles) - IP55 [PVC]		Cable sleeves (5 circles) - IP55 [RUBBER]	
PG 16	23mm	<b>805.3324</b>	100/1000	<b>805.3304</b> <sup>[1]</sup>	100/1000	<b>805.3314</b> <sup>[1]</sup>	100/1000
		<b>805.3324HF</b> <sup>[2]</sup>	100/1000			<b>805.3314HF</b> <sup>[1][2]</sup>	100/1000
PG 21	29mm	<b>805.3325</b>	100/1000	<b>805.3305</b> <sup>[1]</sup>	100/1000	<b>805.3315</b> <sup>[1]</sup>	100/1000
		<b>805.3325HF</b> <sup>[2]</sup>	100/1000			<b>805.3315HF</b> <sup>[1][2]</sup>	100/1000
PG 29	39,5mm			<b>805.3306</b> <sup>[1]</sup>	50/500		
PG 36	47,5mm			<b>805.3307</b> <sup>[1]</sup>	25/200		

<sup>[1]</sup> SCABOX - CUBIK - CUBOX Series type

<sup>[2]</sup> Halogen free (Glow Wire 650°C)

3.1



# Installation accessories

## TIES Series

### ■ Cable ties

#### TIES Series

839.



For indoor wiring

#### CABLE TIE

Dimension	Clamping diameter	Traction resistance	□	■
2,2x75mm	15mm	6,12Kg	<b>839.42080</b> 100/2000	<b>839.52080</b> 100/2000
2,5x135mm	32mm	8,16Kg	<b>839.42120</b> 100/2000	<b>839.52120</b> 100/2000
2,5x98mm	21mm		<b>839.42100</b> 100/2000	<b>839.52100</b> 100/2000
2,6x160mm	40mm		<b>839.42160</b> 100/2000	<b>839.52160</b> 100/2000
2,6x200mm	52mm		<b>839.42200</b> 100/2000	<b>839.52200</b> 100/2000
3,5x140mm	32mm	18,36Kg	<b>839.43140</b> 100/2000	<b>839.53140</b> 100/2000
3,5x200mm	50mm		<b>839.43200</b> 100/2000	<b>839.53200</b> 100/2000
3,5x290mm	80mm		<b>839.43300</b> 100/2000	<b>839.53300</b> 100/2000
3,5x370mm	103mm		<b>839.43370</b> 100/2000	<b>839.53370</b> 100/2000
4,5x290mm	78mm	22,44Kg	<b>839.44300</b> 100/2000	<b>839.54300</b> 100/2000
4,5x360mm	100mm		<b>839.44370</b> 100/2000	<b>839.54370</b> 100/2000
4,5x430mm	115mm		<b>839.44430</b> 100/2000	<b>839.54430</b> 100/2000
4,8x178mm	45mm		<b>839.44190</b> 100/2000	<b>839.54190</b> 100/2000
4,8x200mm	50mm	55,08Kg	<b>839.44200</b> 100/2000	<b>839.54200</b> 100/2000
4,8x250mm	68mm		<b>839.44250</b> 100/2000	<b>839.54250</b> 100/2000
7,5x365mm	100mm		<b>839.47370</b> 100/2000	<b>839.57370</b> 100/2000
7,8x180mm	45mm		<b>839.47200</b> 100/2000	<b>839.57200</b> 100/2000
7,8x300mm	80mm	71,4Kg	<b>839.47290</b> 100/2000	<b>839.57290</b> 100/2000
9x780mm	233mm		<b>839.47780</b> 100/1000	<b>839.57780</b> 100/1000

- Good resistance to external agents: oil, grease, oil derivatives, alcohol, saline mist and chlorates.
- Colour black: increased resistance to UV rays (not suited for prolonged exposure).
- Do not withstand UV rays



TIES Series  
Cable ties for indoor wiring

# Installation accessories

## TIES Series



### ■ Cable ties

#### TIES Series

839.



For outdoor wiring

Dimension	Clamping diameter	Traction resistance	CABLE TIE	
6x115mm	4÷25mm	25Kg	<b>839.39/6115</b>	100/2000
6x180mm	10÷45mm	28Kg	<b>839.39/6175</b>	100/2000
9x120mm	4÷22mm	48Kg	<b>839.39/9120</b>	100/2000
9x180mm	10÷42mm		<b>839.39/9180</b>	100/2000
9x260mm	30÷60mm	51Kg	<b>839.39/9260</b>	100/2000
9x360mm	30÷93mm		<b>839.39/9350</b>	100/2000

- Rounded edges to avoid cutting into cable insulation.
- Good resistance to external agents: oil, grease, oil derivatives and saline mist.
- Withstands UV rays.

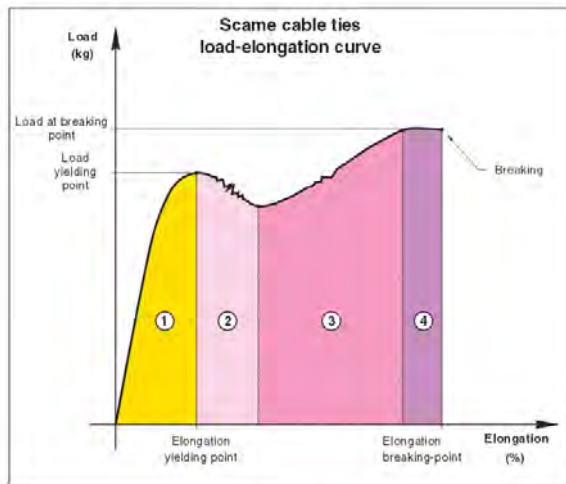

#### Loading diagram

SCAME cable ties load-elongation curve

4 zones with different characteristics are clearly distinguished:

- 1) Elastic elongation (area of use).  
The cable tie is subjected to traction forces and lengthens, elastically. When the forces are taken away, the tie returns to its initial state, without any alteration of its physical characteristics.
- 2) Stretching of the molecular links.  
The tie is subjected to such a load that some of the intermolecular links are broken. The elastic properties are altered.
- 3) Permanent deformity.  
All the inter-molecular links are broken.
- 4) Breaking-point.  
Length at which the tie breaks.

3.1



# Installation accessories

## TIES Series

### Cable ties

TIES Series

839.



Plier for cable tie  
clamping-trimming

PLIER

839.39/104

20

- Made of red stove-enamelled steel.

ACCESSORIES

1

2

3

4

# Installation accessories

## TIES Series



### ■ Cable ties

TIES Series

839.



Description	Dimension	Fastening accessories for cable ties
SELF-ADESIVE CABLE TIE BASE - Max. cable tie width: 4.8 mm.	28,5x28,5mm	<b>839.39/100</b> 100/1000

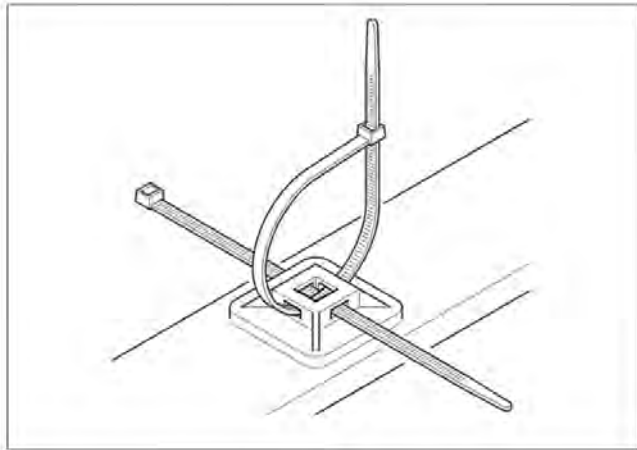

Adhesive support

3.1



# Installation accessories

## TIES Series

### ■ Cable ties

TIES Series

839.



Description

Dimension

Fastening accessories for cable ties

WALL ANCHOR BASE

7÷8mm

**839.39/101**

100/1000

1

2

3

ACCESSORIES

4

TIES Series

839.



Description

Dimension

Fastening accessories for cable ties

PANEL CLIP-ON BASE

6,4mm max

**839.39/102**

100/1000

- Max. cable tie width: 4.8 mm.

TIES Series

839.



Description

Dimension

Fastening accessories for cable ties

CABLE TIE BASE ANTI-VIBRATION

15,5x22,5mm

**839.39/103**

100/1000

- Max. cable tie width: 4.8 mm.

# Installation accessories

## FIXO Series



### Fastening accessories

#### FIXO Series

845.



Description	Version	Sprung ceiling hooks	
SPRUNG CEILING HOOK	THREADED BAR		<b>845.46/2</b> 50/500
	EYELET	<b>845.46</b> 50/500	
	SCREW	<b>845.46/1</b> 50/1000	

- To install, fold down the tabs and push them into a 12-mm hole in the ceiling. Once through, the tabs open up and are anchored in the ceiling.
- Made of metal.

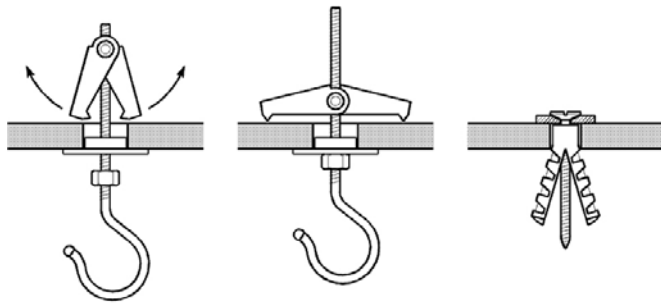

**FIXO Series**  
Sprung hook - Fixing plug

3.1



# Installation accessories

## FIXO Series

### ■ Fixing plugs

FIXO Series

846.



Fixing plugs without screws

Fixing plugs with screws

FIXING PLUG

FIXING PLUG WITH SCREW

Dimension

Dimension	FIXING PLUG		FIXING PLUG WITH SCREW	
Ø4mm	<b>846.13-4</b>	100/2000	<b>846.14-4</b>	100/2000
Ø5mm	<b>846.13-5</b>	100/2000	<b>846.14-5</b>	100/2000
Ø6mm	<b>846.13-6</b>	100/2000	<b>846.14-6</b>	100/2000
Ø7mm	<b>846.13-7</b>	100/2000	<b>846.14-7</b>	100/2000
Ø8mm	<b>846.13-8</b>	100/2000	<b>846.14-8</b>	100/2000
Ø10mm	<b>846.13-10</b>	100/2000	<b>846.14-10</b>	100/2000

- Suitable for all type of screws (for wood, metal, concrete etc.)
- Stainless steel screws.

ACCESSORIES

1

2

3

4



# Installation accessories

## CABLO Series



### ■ INSTALLATION Accessories

#### CABLO Series

865.



#### Cable sheaths (1 meter)

Diameter		CABLE SHEATHS	
Ø2mm		<b>865.002</b>	200/1600
Ø3mm		<b>865.003</b>	200/1000
Ø4mm		<b>865.004</b>	200/1000
Ø5mm		<b>865.005</b>	200/1000
Ø6mm	<b>865.106</b> 200/800	<b>865.006</b>	200/600
Ø7mm		<b>865.007</b>	200/600
Ø8mm		<b>865.008</b>	200/400
Ø9mm		<b>865.009</b>	200/600
Ø10mm		<b>865.010</b>	200/400
Ø12mm		<b>865.012</b>	100/200
Ø14mm		<b>865.014</b>	100/200
Ø16mm		<b>865.016</b>	100/200
Ø18mm		<b>865.018</b>	100/200
Ø20mm		<b>865.020</b>	50/150
Ø22mm		<b>865.022</b>	50/150
Ø24mm		<b>865.024</b>	50/100
Ø26mm		<b>865.026</b>	50/100
Ø28mm		<b>865.028</b>	50/150
Ø30mm		<b>865.030</b>	50/100
Ø36mm		<b>865.036</b>	25/100
Ø40mm		<b>865.040</b>	25/50

- 0.41 mm thick.
- Made of self-extinguishing, soft and flexible insulated thermoplastic material.

3.1



## Installation accessories CABLO Series

### ■ INSTALLATION Accessories

#### CABLO Series

865.



#### Spiral cable binding (1 meter)

##### SPIRAL CABLE BINDING

Diameter		
Ø3mm	<b>865.603</b>	25/700
Ø4mm	<b>865.604</b>	25/600
Ø6mm	<b>865.606</b>	25/500
Ø8mm	<b>865.608</b>	25/400
Ø10mm	<b>865.610</b>	25/200
Ø12mm	<b>865.612</b>	20/160
Ø14mm	<b>865.614</b>	20/120

- Made of self-extinguishing, soft and flexible insulated thermoplastic material.

ACCESSORIES

1

2

3

4

# Installation accessories

## FASTY Series



### ■ Cable clips and insulated pins

FASTY Series

830.



Flat clips

CLIP

FLAT

Dimension				
3,5mm	<b>830.30/P3</b>	100/5000	<b>830.30/P3G</b>	100/5000
5mm	<b>830.30/P5</b>	100/3000	<b>830.30/P5G</b>	100/3000
6mm	<b>830.30/P6</b>	100/5000	<b>830.30/P6G</b>	100/5000
8mm	<b>830.30/P8</b>	100/3000	<b>830.30/P8G</b>	100/3000
11mm	<b>830.30/P11</b>	100/1000	<b>830.30/P11G</b>	100/1000
13mm	<b>830.30/P13</b>	100/1000	<b>830.30/P13G</b>	100/1000

- Pre-inserted pins
- Pins made of hardened and nickel-plated steel
- Clips made of thermoplastic material

3.1



## Installation accessories

### FASTY Series

#### ■ Cable clips and insulated pins

#### FASTY Series

830.



#### Round clips

CLIP

ROUND

Ø				
ø3-4mm	<b>830.30/3-4</b>	100/5000	<b>830.30/3-4G</b>	100/5000
ø5mm	<b>830.30/5</b>	100/5000	<b>830.30/5G</b>	100/5000
ø6mm	<b>830.30/6</b>	100/5000	<b>830.30/6G</b>	100/5000
ø7mm	<b>830.30/7</b>	100/5000	<b>830.30/7G</b>	100/5000
ø8mm	<b>830.30/8</b>	100/5000	<b>830.30/8G</b>	100/5000
ø10mm	<b>830.30/10</b>	100/5000	<b>830.30/10G</b>	100/5000
ø12mm	<b>830.30/12</b>	100/3000	<b>830.30/12G</b>	100/3000
ø14mm			<b>830.30/14G</b>	100/3000
ø16mm			<b>830.30/16G</b>	100/5000
ø19mm			<b>830.30/19G</b>	100/3000
ø22mm			<b>830.30/22G</b>	100/1000
ø26mm			<b>830.30/26G</b>	100/1000
ø28mm			<b>830.30/28G</b>	100/1000
ø32mm			<b>830.30/32G</b>	100/1000

- Pre-inserted pins
- Pins made of hardened and nickel-plated steel
- Clips made of thermoplastic material

#### FASTY Series

818.



Description	Colour	Insulated pins (100 pieces bag)
INSULATED PIN		<b>818.2</b> 100/1000

- Pre-inserted pins
- Pins made of hardened and nickel-plated steel
- Clips made of thermoplastic material

# Installation accessories

## RAILDIN Series



### ■ Metallic DIN rails

		RAILDIN Series	
		865.	
			
Description	Dimension	G type - 32x15mm (1 meter)	
DIN RAIL	32x15x1,5mm	<b>865.210</b>	20
	35x15x1,5mm	<b>865.211</b>	20

- DIN metallic rails
- Drilled rail with slots.
- Non drilled rail with drilling points provided.
- Steel rail or mounting modular electrical equipment
- Steel, cold lamination.
- Thickness of zinc coating: 8 micron.
- Electrolytic zinc coating, followed by passivation and yellow colouring.
- Standard bar length: 2m.

		RAILDIN Series	
		865.	
			
Description	Dimension	OMEGA type - 35x15mm (1 meter)	
DIN RAIL	35x15x1,5mm	<b>865.230</b>	20
		<b>865.231</b>	20

- DIN metallic rails
- Drilled rail with slots.
- Non drilled rail with drilling points provided.
- Steel rail or mounting modular electrical equipment
- Steel, cold lamination.
- Thickness of zinc coating: 8 micron.
- Electrolytic zinc coating, followed by passivation and yellow colouring.
- Standard bar length: 2m.

3.1

## Installation accessories

### RAILDIN Series

#### ■ Metallic DIN rails

#### RAILDIN Series

865.

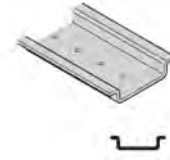

#### OMEGA type - 35x7.5mm (1 meter)

Description	Dimension	OMEGA type - 35x7.5mm (1 meter)	
DIN RAIL	35x7,5x1mm	<b>865.220</b>	40
		<b>865.221</b>	40

- DIN metallic rails
- Drilled rail with slots.
- Non drilled rail with drilling points provided.
- Steel rail or mounting modular electrical equipment
- Steel, cold lamination.
- Thickness of zinc coating: 8 micron.
- Electrolytic zinc coating, followed by passivation and yellow colouring.
- Standard bar length: 2m.

#### RAILDIN Series

865.



#### OMEGA type - 15x5.5mm (1 meter)

Description	Dimension	OMEGA type - 15x5.5mm (1 meter)	
DIN RAIL	15x5,5x1mm	<b>865.240</b>	100
		<b>865.241</b>	100

- Electrolytic zinc coating, followed by passivation and yellow colouring.
- Standard bar length: 2m.

ACCESSORIES

1

2

3

4

# Installation accessories

## RAILDIN Series



### ■ Metallic DIN rails

#### RAILDIN Series

865.

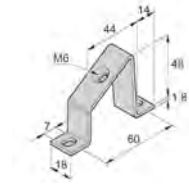

Description	Dimension	Support bracket
SUPPORT BRACKET	80x49x20mm	<b>865.200</b> 50/500

- Electrolytic zinc coating, followed by passivation and yellow colouring.

3.1



3.2

## Connecting accessories

- CONNECTO Series  
Insulated wire connectors - T85
- CONNECTO Series  
Terminal strips
- CONNECTO Series  
DOMINO terminal blocks - T85

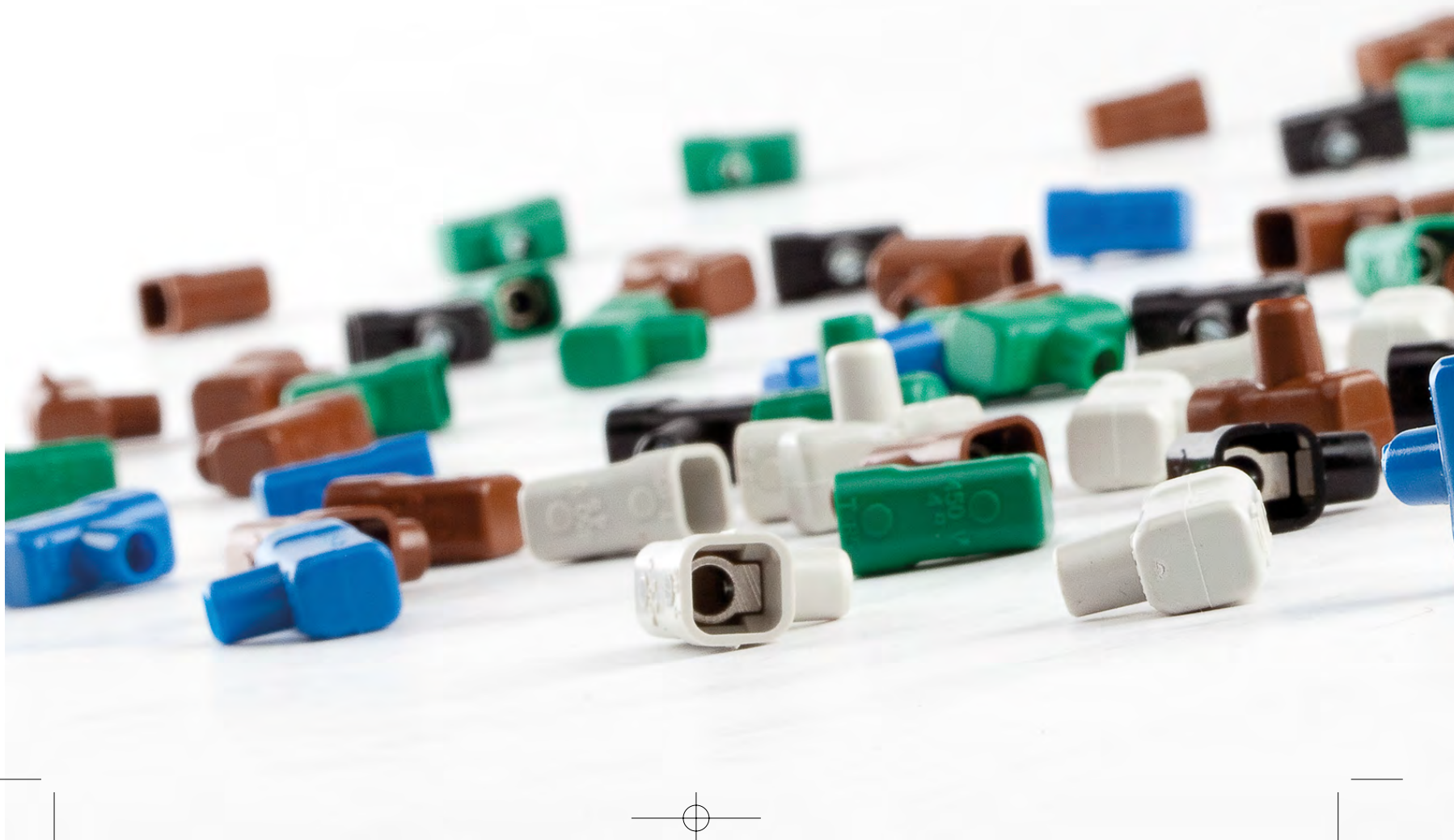



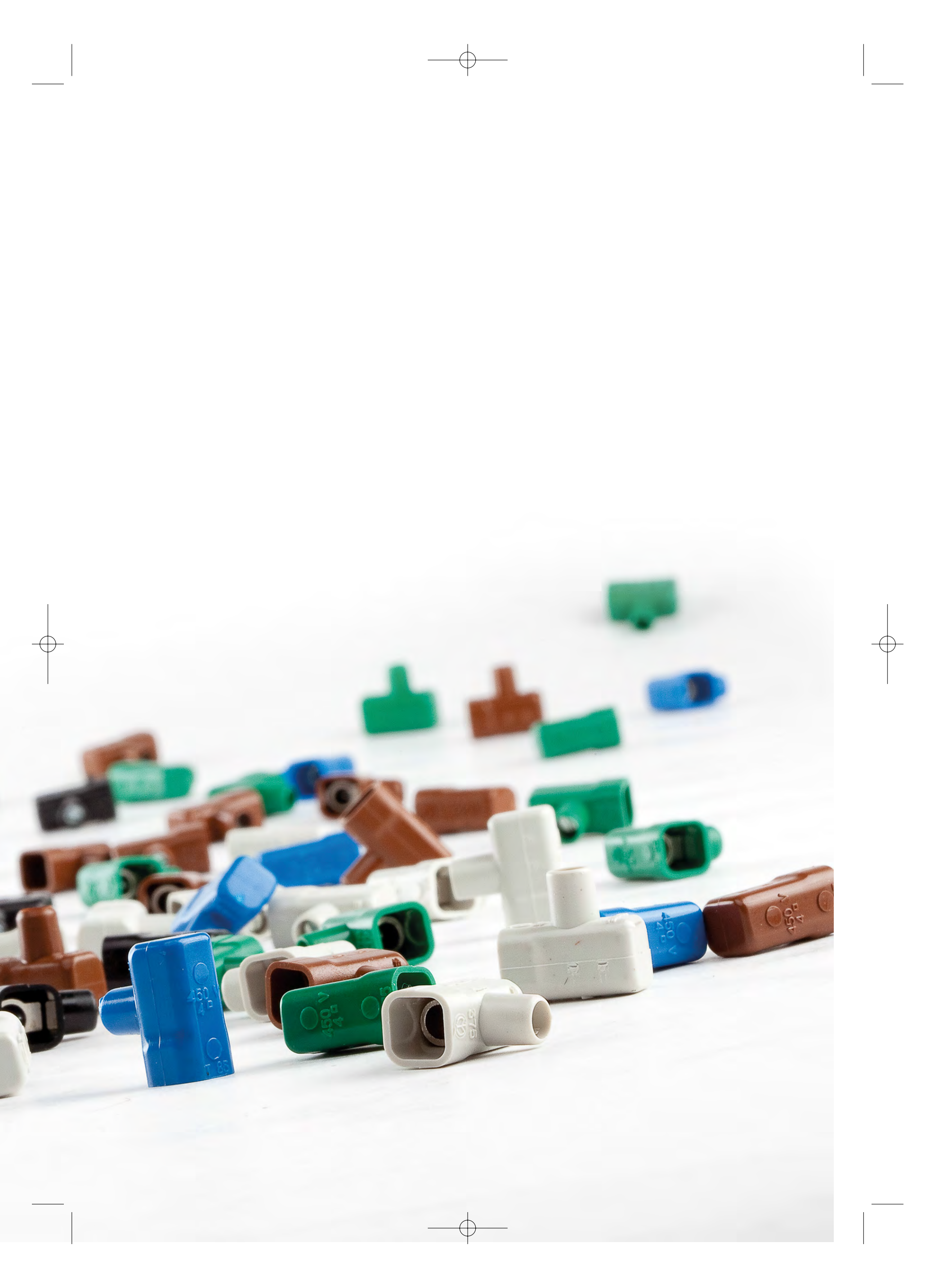

## Connecting accessories CONNECTO Series

### Insulated wire connectors - T85

CONNECTO Series

810.



Insulated wire  
connectors - T85

ACCESSORIES

1

2

3

4

Connecting capacity	Current	Volt	Colour	WIRE CONNECTOR
1,5mm <sup>2</sup>	17,5A	450V		<b>810.372/N</b> 100/600
				<b>810.372/B</b> 100/600
				<b>810.372/G</b> 100/600
				<b>810.372/V</b> 100/600
				<b>810.372/M</b> 100/600
			TRANSPARENT	<b>810.372/TR</b> 600/6000
2,5mm <sup>2</sup>	24A	450V		<b>810.374/N</b> 100/1000
				<b>810.374/B</b> 100/1000
				<b>810.374/G</b> 100/1000
				<b>810.374/V</b> 100/1000
				<b>810.374/M</b> 100/1000
			TRANSPARENT	<b>810.374/TR</b> 1000/4000
4mm <sup>2</sup>	32A	450V		<b>810.375/N</b> 100/1000
				<b>810.375/B</b> 100/1000
				<b>810.375/G</b> 100/1000
				<b>810.375/V</b> 100/1000
				<b>810.375/M</b> 100/1000
			TRANSPARENT	<b>810.375/TR</b> 100/1000
6mm <sup>2</sup>	41A	450V		<b>810.376/N</b> 100/1000
				<b>810.376/B</b> 100/1000
				<b>810.376/G</b> 100/1000
				<b>810.376/V</b> 100/1000
				<b>810.376/M</b> 100/1000
			TRANSPARENT	<b>810.376/TR</b> 100/1000
10mm <sup>2</sup>	57A	450V		<b>810.378/N</b> 100/1000
				<b>810.378/B</b> 100/1000
				<b>810.378/G</b> 100/1000
				<b>810.378/V</b> 100/1000
				<b>810.378/M</b> 100/1000
			TRANSPARENT	<b>810.378/TR</b> 100/1000
16mm <sup>2</sup>	76A	450V		<b>810.379/N</b> 50/500
				<b>810.379/B</b> 50/500
				<b>810.379/G</b> 50/500
				<b>810.379/V</b> 50/500
				<b>810.379/M</b> 50/500
			TRANSPARENT	<b>810.379/TR</b> 50/500
25mm <sup>2</sup>	101A	450V	TRANSPARENT	<b>810.425/TR</b> 10/100
35mm <sup>2</sup>	125A		TRANSPARENT	<b>810.435/TR</b> 5/250

# Connecting accessories

## CONNECTO Series



### ■ Insulated wire connectors - T85

#### CONNECTO Series

810.



**Insulated wire connectors - T85 [ASSORTED]**

Connecting capacity	Current	Volt	Colour	WIRE CONNECTOR
1,5mm <sup>2</sup>	17,5A	450V	ASSORTED	<b>810.372/AS</b> 100/600
2,5mm <sup>2</sup>	24A			<b>810.374/AS</b> 1000/4000
4mm <sup>2</sup>	32A			<b>810.375/AS</b> 100/1000
6mm <sup>2</sup>	41A			<b>810.376/AS</b> 100/1000
10mm <sup>2</sup>	57A			<b>810.378/AS</b> 100/1000
16mm <sup>2</sup>	76A			<b>810.379/AS</b> 50/500

- Transparent excluded



#### CONNECTO Series

SCAME's insulated wire connectors have clear or coloured the insulating casing. The clear casings provide the advance of allowing visual control of the connections,, while the coloured ones make for faster identification of the circuits.

3.2



## Connecting accessories CONNECTO Series

### ■ Insulated wire connectors - T85

CONNECTO Series

812.



**Insulated wire  
connectors - 10 poles  
strips (1 strip)**

Connecting capacity	Dimension	Pitch	Colour	WIRE CONNECTOR BLOCK
1,5mm <sup>2</sup>	96mm	9,8mm	TRANSPARENT	<b>812.372</b> 10/200
2,5mm <sup>2</sup>	120mm	12,2mm		<b>812.374</b> 10/400
4mm <sup>2</sup>				<b>812.375</b> 10/400
6mm <sup>2</sup>	145mm	14,7mm		<b>812.376</b> 10/200
10mm <sup>2</sup>	168mm	17mm		<b>812.378</b> 10/150
16mm <sup>2</sup>	211mm	21,3mm		<b>812.379</b> 10/60

ACCESSORIES

1

2

3

4

# Connecting accessories

## CONNECTO Series



### Multi-way wire connectors - T85

CONNECTO Series

817.



2 WAY

Number of ways	Connecting capacity	Volt	Dimension	MULTI-WAY WIRE CONNECTOR	
2 WAYS	2x6mm <sup>2</sup>	450V	23x31x24mm	<b>817.0602</b>	25/650
	2x16mm <sup>2</sup>		33x28x24mm	<b>817.1602</b>	10/270
	2x35mm <sup>2</sup>		35x46x30mm	<b>817.3502</b>	10/160

- Protection degree: IP20
- Cage clamp connectors.
- Rated voltage 450V~.
- Captive screws.
- Self-extinguishing material in compliance with IEC 60695-2-1 standard 850°C.
- Engineering plastic casing
- Max. service temperature - continuous duty: 85°C.

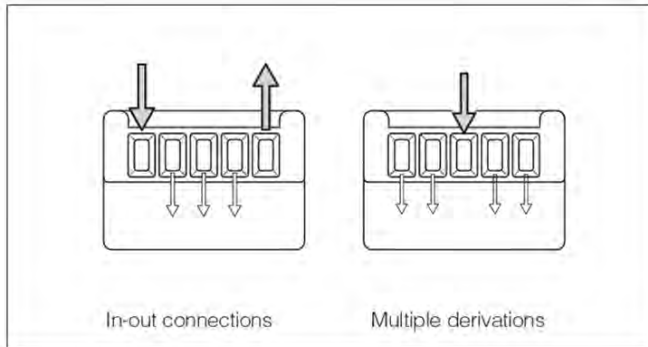

In-out connections and multiple derivations

3.2



## Connecting accessories

### CONNECTO Series

#### Multi-way wire connectors - T85

CONNECTO Series

817.



3 WAY

Number of ways	Connecting capacity	Volt	Dimension	MULTI-WAY WIRE CONNECTOR	
				Part Number	Quantity
3 WAYS	3x6mm <sup>2</sup>	450V	31x31x24mm	<b>817.0603</b>	25/400
	3x16mm <sup>2</sup>		45x28x24mm	<b>817.1603</b>	10/270
	3x35mm <sup>2</sup>		49x46x30mm	<b>817.3503</b>	10/260

- Protection degree: IP20
- Cage clamp connectors.
- Rated voltage 450V~.
- Captive screws.
- Self-extinguishing material in compliance with IEC 60695-2-1 standard 850°C.
- Engineering plastic casing
- Max. service temperature - continuous duty: 85°C.

CONNECTO Series

817.



5 WAY

Number of ways	Connecting capacity	Volt	Dimension	MULTI-WAY WIRE CONNECTOR	
				Part Number	Quantity
5 WAYS	5x6mm <sup>2</sup>	450V	49x31x24mm	<b>817.0605</b>	10/270
	5x16mm <sup>2</sup>		71x38x24mm	<b>817.1605</b>	10/260

- Protection degree: IP20
- Cage clamp connectors.
- Rated voltage 450V~.
- Captive screws.
- Self-extinguishing material in compliance with IEC 60695-2-1 standard 850°C.
- Engineering plastic casing
- Max. service temperature - continuous duty: 85°C.

# Connecting accessories

## CONNECTO Series



### Multi-way wire connectors - T85

CONNECTO Series

817.



6 WAY

Number of ways	Connecting capacity	Volt	Dimension	MULTI-WAY WIRE CONNECTOR	
				Part Number	Quantity
6 WAYS	4x6mm <sup>2</sup> 2x16mm <sup>2</sup>	450V	66x38x24mm	<b>817.1606C</b>	10/260
	4x16mm <sup>2</sup> 2x35mm <sup>2</sup>		83x46x30mm	<b>817.3506C</b>	10/120

- Protection degree: IP20
- Cage clamp connectors.
- Rated voltage 450V~.
- Captive screws.
- Self-extinguishing material in compliance with IEC 60695-2-1 standard 850°C.
- Engineering plastic casing
- Max. service temperature - continuous duty: 85°C.

Derivations

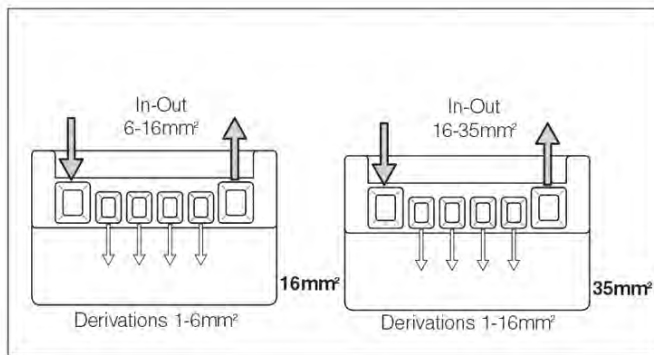

3.2



## Connecting accessories

### CONNECTO Series

#### Multi-way wire connectors - T85

CONNECTO Series

817.



ACCESSORIES

1

2

3

4

Description	Volt	Accessories
DIN RAIL BRACKET	450V	<b>817.001</b> 10/500

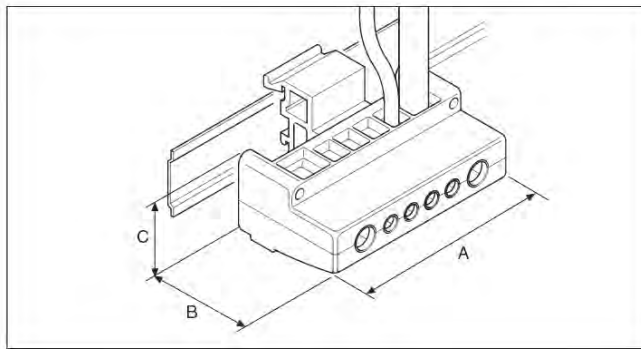

#### DIN rail bracket

The bracket for the DIN rail is the same for all versions of the multi-way wire connectors and is designed for spring-fixing onto the rail "OMEGA" and "G". It is detached from the rail by using a screw-driver.



## Connecting accessories CONNECTO Series

**SCAME**

### ■ Terminal strips

CONNECTO Series

815.



Description	Connecting capacity	Volt	Dimension	Pitch	Ø fixing hole	Colour	T85 terminal strips
TERMINAL BLOCK T85	2,5mm <sup>2</sup>	250V	95,5x15,5x16mm	8mm	2,6mm		<b>815.2361B</b> 50/800
							<b>815.2361</b> 50/800
	4mm <sup>2</sup>	450V	120x16,6x17,4mm	10mm	3,5mm		<b>815.2362B</b> 50/400
							<b>815.2362</b> 50/400
	6mm <sup>2</sup>						<b>815.23625B</b> 50/400
							<b>815.23625</b> 50/400
	10mm <sup>2</sup>	750V	138x23,5x20,5mm	11,5mm	4,3mm		<b>815.2363B</b> 25/300
							<b>815.2363</b> 25/300
	16mm <sup>2</sup>	750V	174x30x24mm	14,5mm	4,3mm		<b>815.2364B</b> 25/150
							<b>815.2364</b> 25/150
	25mm <sup>2</sup>	750V	210x38x36mm	17,5mm	4,3mm		<b>815.2365B</b> 15/60
							<b>815.2365</b> 15/60
35mm <sup>2</sup>	750V	264x46x39mm	22mm	5,5mm		<b>815.2366B</b> 10/40	
						<b>815.2366</b> 10/40	

- Self-extinguishing material in compliance with IEC 60695-2-1 standard 850°C.
- Engineering plastic casing
- Max. service temperature - continuous duty: 85°C.
- Nickel-plated brass terminal
- 12 poles
- Captive screws of zinc-plated steel

3.2



## Connecting accessories

### CONNECTO Series

#### Terminal strips

CONNECTO Series

815.



ACCESSORIES

1

2

3

4

Description	Connecting capacity	Volt	Dimension	Pitch	Ø fixing hole	Colour	T140 terminal strips
TERMINAL BLOCK T140	2,5mm <sup>2</sup>	250V	95,5x15,5x16mm	8mm	2,6mm	TRANSPARENT	<b>815.1361</b> 50/800
	4mm <sup>2</sup>	450V	120x16,6x17,4mm	10mm	3,5mm		<b>815.1362</b> 50/400
	6mm <sup>2</sup>						<b>815.13625</b> 50/400
	10mm <sup>2</sup>						<b>815.1363</b> 25/300
	16mm <sup>2</sup>	750V	174x30x24mm	14,5mm	4,3mm		<b>815.1364</b> 25/150
	25mm <sup>2</sup>						<b>815.1365</b> 15/60
	35mm <sup>2</sup>						<b>815.1366</b> 10/40
			264x46x39mm	22mm	5,5mm		

- Max. service temperature - continuous duty: 140°C.
- Self-extinguishing material in compliance with IEC 60695-2-1 standard 850°C.
- Engineering plastic casing
- Nickel-plated brass terminal
- 12 poles
- Captive screws of zinc-plated steel

# Connecting accessories

## CONNECTO Series



### ■ DOMINO terminal blocks - T85

#### ENCLOSURES ACCESSORIES

654.



Description	Suitable for	IP	Terminal blocks without insulated base
TERMINAL BLOCK	DOMINO IP40 MBOX2 MBOX3 BLOCK4	IP00	<b>654.0349</b> 10/100

- Terminals: 1x (5x10mm<sup>2</sup> and 5x16mm<sup>2</sup>).
- Earth/neutral terminal blocks

#### ENCLOSURES ACCESSORIES

654.



Description	Colour	IP	Version	Terminal blocks for DIN rail - IP20
TERMINAL BLOCK		IP20	HORIZONTAL	<b>654.0359</b> 1/10
			VERTICAL	<b>654.0358</b> 1/10

- Terminals: 1x (5x10mm<sup>2</sup> and 5x16mm<sup>2</sup>).
- Phase R-S-T and earth/neutral terminal blocks

### ■ Modular terminal blocks - IP20

#### ENCLOSURES ACCESSORIES

654.



Description	Suitable for	Colour	IP	x1
TERMINAL BLOCK	DOMINO IP66 4 DIN		IP20	<b>654.0365</b> 10
	DOMINO IP66 8 DIN			<b>654.0363</b> 1/10

- Insulated by a plastic cover for the connection of the flexible cables
- For earth, phase and neutral conductors

3.2



## Connecting accessories CONNECTO Series

### ■ Modular terminal blocks - IP20

#### ENCLOSURES ACCESSORIES

654.



1  
2  
3

ACCESSORIES

Description	Suitable for	Colour	IP	x2
TERMINAL BLOCK	DOMINO IP40 8 DIN DOMINO IP66 12-24 DIN	■	IP20	<b>654.0361</b> <sup>[1]</sup> 1/10 <b>654.0361C</b> <sup>[2]</sup> 10

- [1] There is special left for one additional terminal block  
 [2] Complete terminal block, supplied with one additional terminal block art. 654.0360.  
 - Insulated by a plastic cover for the connection of the flexible cables  
 - For earth, phase and neutral conductors

4

#### ENCLOSURES ACCESSORIES

654.



Description	Suitable for	Colour	IP	x3
TERMINAL BLOCK	DOMINO IP40 12-24 DIN DOMINO IP40 18-36-54-72 DIN DOMINO IP66 16-32-48-64 DIN	■	IP20	<b>654.0362</b> <sup>[1]</sup> 1/10 <b>654.0362C</b> <sup>[2]</sup> 10

- [1] There is special left for two additional terminal blocks  
 [2] Complete terminal block, supplied with two additional terminal blocks art. 654.0360.  
 - Insulated by a plastic cover for the connection of the flexible cables  
 - For earth, phase and neutral conductors

# Connecting accessories

## CONNECTO Series



### Modular terminal blocks - IP20

#### ENCLOSURES ACCESSORIES

654.



Description	Suitable for	Colour	IP	x4
TERMINAL BLOCK	DOMINO IP40 18-36-54-72 DIN		IP20	<b>654.0364</b> <sup>[1]</sup> 1/10 <b>654.0364C</b> <sup>[2]</sup> 10

[1] There is special left for three additional terminal blocks.

[2] Complete terminal block, supplied with three additional terminal blocks Art. 654.0360.

- Insulated by a plastic cover for the connection of the flexible cables
- For earth, phase and neutral conductors

#### ENCLOSURES ACCESSORIES

654.



Description	Notes	Colour	IP	Additional
TERMINAL BLOCK	EXTRA		IP20	<b>654.0360</b> 1/10

- Insulated by a plastic cover for the connection of the flexible cables
- For earth, phase and neutral conductors

3.2



3.3

## Conduit

- **FIXER Series**  
Conduit FIXING accessories
- **TUBE Series**  
COUPLING Accessories
- **SMART Series**  
IP66/67



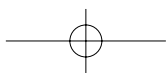
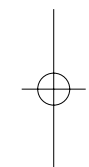
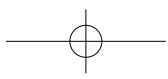

## Conduit FIXER Series

■ Made of self-extinguishing thermoplastic material >> Clips

FIXER Series

860.



ACCESSORIES

Description	Colour	Ø	Snap clip
SNAP CLIPS	■	Ø16mm	<b>860.1316/G</b> 100/1000
		Ø20mm	<b>860.1320/G</b> 100/1000
		Ø25mm	<b>860.1325/G</b> 100/800
		Ø32mm	<b>860.1332/G</b> 100/800
		Ø40mm	<b>860.1340/G</b> 50/400
		Ø50mm	<b>860.1350/G</b> 25/250

FIXER Series

860.



Description	Colour	Ø	Collar clip
COLLAR CLIPS	■	Ø16mm	<b>860.1516</b> 100/1000
		Ø20mm	<b>860.1520</b> 100/1000
		Ø25mm	<b>860.1525</b> 100/800
		Ø32mm	<b>860.1532</b> 50/500
		Ø40mm	<b>860.1540</b> 50/400
		Ø50mm	<b>860.1550</b> 25/250



# Conduit FIXER Series



■ Made of self-extinguishing thermoplastic material >> Clips

FIXER Series

860.



Description	Colour	Ø	Snap clip with plug and screw	
SNAP CLIPS W/PLUG & SCREW		Ø16mm	<b>860.2016</b>	100/1000
		Ø20mm	<b>860.2020</b>	100/1000
		Ø25mm	<b>860.2025</b>	100/800
		Ø32mm	<b>860.2032</b>	50/400

- Screws made of zinc-plated steel.

FIXER Series

860.



Description	Colour	Ø	Ties	
COLLAR CLIPS		Ø13-32mm	<b>860.1616</b>	100/1000
		Ø40-63mm	<b>860.1640</b>	100/500

FIXER Series

860.



Description	Colour	Ø	Pressure clips	
PRESSURE CLIPS		Ø16-20mm	<b>860.01620</b>	100/1200
		Ø25-32mm	<b>860.02532</b>	50/600
		Ø40-50mm	<b>860.04050</b>	40/320

3.3



## Conduit FIXER Series

■ Made of zinc-bichromate steel

FIXER Series

820.



Spacer bracket  
With M6 threaded base

Half-saddle - Standard  
type

Half-saddle - Heavy Duty  
type

Saddle

Ø	COLLAR		CLIP		SADDLE			
	Part No.	QTY	Part No.	QTY	Part No.	QTY		
Ø10-11mm	<b>820.610</b>	100/1000	<b>820.710</b>	200/1000	<b>820.710/P</b>	100/1000		
Ø12-13mm	<b>820.612</b>	100/1000	<b>820.712</b>	200/1000	<b>820.712/P</b>	100/1000		
Ø14-15mm	<b>820.614</b>	100/1000	<b>820.714</b>	200/1000	<b>820.714/P</b>	100/1000		
Ø16-17mm	<b>820.616</b>	100/1000	<b>820.716</b>	100/1000	<b>820.716/P</b>	100/1000		
Ø19-20mm	<b>820.620</b>	100/1000	<b>820.720</b>	100/1000	<b>820.720/P</b>	100/1000		
Ø21-22mm	<b>820.622</b>	100/1000	<b>820.722</b>	100/1000	<b>820.722/P</b>	100/1000		
Ø25-26mm	<b>820.625</b>	100/1000	<b>820.725</b>	100/1000	<b>820.725/P</b>	100/1000		
Ø28-29mm	<b>820.628</b>	100/1000				<b>820.828</b>	100/1000	
Ø31-32mm	<b>820.632</b>	100/1000			<b>820.732/P</b>	100/1000	<b>820.832</b>	100/1000
Ø38-40mm	<b>820.640</b>	100/1000			<b>820.740/P</b>	100/500	<b>820.838</b>	100/1000
Ø48-50mm	<b>820.650</b>	50/400			<b>820.750/P</b>	50/500	<b>820.850</b>	50/500

- Electrolytic zinc coating, followed by passivation and yellow colouring.
- Made of zinc-plated steel.

ACCESSORIES

4

# Conduit TUBE Series



## ■ IP40 >> Inspection

TUBE Series

860.



Inspection elbow

Flat tee inspection

IP	Colour	Ø	INSPECTION ELBOW		FLAT TEE INSPECTION	
			Part No.	Length	Part No.	Length
IP40	Grey	Ø16mm	<b>860.1116/G</b>	50/800	<b>860.1216/G</b>	50/800
		Ø20mm	<b>860.1120/G</b>	50/600	<b>860.1220/G</b>	50/400
		Ø25mm	<b>860.1125/G</b>	50/400	<b>860.1225/G</b>	25/300
		Ø32mm	<b>860.1132/G</b>	25/200	<b>860.1232/G</b>	20/160

## ■ IP40 >> Monobloc

TUBE Series

862.



Conduit coupling

Conduit coupling

Bend with two couplings

IP	Colour	Ø	CONDUIT COUPLING		BEND WITH TWO COUPLINGS	
			Part No.	Length	Part No.	Length
IP40	Grey	Ø16mm	<b>862.1016/G</b>	100/1200	<b>862.916/G</b>	50/800
		Ø20mm	<b>862.1020/G</b>	100/800	<b>862.920/G</b>	50/400
		Ø25mm	<b>862.1025/G</b>	50/600	<b>862.925/G</b>	25/200
		Ø32mm	<b>862.1032/G</b>	25/300	<b>862.932/G</b>	25/150
		Ø40mm	<b>862.1040/G</b>	20/160	<b>862.940/G</b>	15/60
	TRANSPARENT	Ø50mm	<b>862.1050/G</b>	20/120	<b>862.950/G</b>	10/40
		Ø16mm	<b>862.1916</b>	100/2000		
		Ø20mm	<b>862.1920</b>	100/1200		
		Ø25mm	<b>862.1925</b>	50/700		
		Ø32mm	<b>862.1932</b>	25/400		
	Ø40mm	<b>862.1940</b>	300			
	Ø50mm	<b>862.1950</b>	150			

3.3



## Conduit TUBE Series

### ■ IP65 >> Bends

TUBE Series

864.



Flexible bend

Bend with two couplings

Conduit coupling

IP	Colour	Ø	FLEXIBLE BEND		BEND WITH TWO COUPLINGS		CONDUIT COUPLING	
			Part No.	Length	Part No.	Length	Part No.	Length
IP65	■	Ø16mm	<b>864.2016</b>	50	<b>864.216</b>	50/600	<b>864.316</b>	50/800
		Ø20mm	<b>864.2020</b>	50	<b>864.220</b>	50/400	<b>864.320</b>	50/600
		Ø25mm	<b>864.2025</b>	50	<b>864.225</b>	25/200	<b>864.325</b>	50/400
		Ø32mm	<b>864.2032</b>	25	<b>864.232</b>	25/100	<b>864.332</b>	25/200
		Ø40mm	<b>864.2040</b>	25	<b>864.240</b>	15/60	<b>864.340</b>	20/160
		Ø50mm	<b>864.2050</b>	15	<b>864.250</b>	10/40	<b>864.350</b>	10/80

- The internal seal ensures IP65 protection even in the case of dilation due to temperature changes.
- Made of rigid, insulated, self-extinguishing and impact-resistant thermoplastic material.

### ■ IP65 >> Conduit to box couplings

TUBE Series

864.



Conduit to box couplings

Flexible coupling for  
connection rigid tube

IP	Colour	Cable outlet	Ø	CONDUIT COUPLING		FLEXIBLE BEND	
				Part No.	Length	Part No.	Length
IP65	■	M16X1,5	Ø16mm	<b>864.516</b>	50/800	<b>864.9016</b>	50
		M20X1,5	Ø20mm	<b>864.520</b>	50/600	<b>864.9020</b>	50
		M25X1,5	Ø25mm	<b>864.525</b>	50/400	<b>864.9025</b>	50
		M32X1,5	Ø32mm	<b>864.532</b>	25/300	<b>864.9032</b>	25
		M40X1,5	Ø40mm	<b>864.540</b>	25/200	<b>864.9040</b>	25
		M50X1,5	Ø50mm	<b>864.550</b>	15/120	<b>864.9050</b>	15

- The internal seal ensures IP65 protection even in the case of dilation due to temperature changes.
- Supplied complete with threaded lock nut and relative seal.

1  
2  
3

ACCESSORIES

4

# Conduit TUBE Series



## ■ IP65 >> Conduit to sheath couplings

TUBE Series

864.



Conduit to sheath couplings (flex)

Conduit to sheath couplings

IP	Colour	Cable outlet	Ø	CONDUIT COUPLING			
				Conduit to sheath couplings (flex)		Conduit to sheath couplings	
IP65	■	M12X1,5	Ø16mm	<b>864.7016</b>	50/800	<b>864.716</b>	50/800
		M16X1,5		<b>864.8016</b>	50/600	<b>864.816</b>	50/600
		M20X1,5	Ø20mm	<b>864.7020</b>	50/600	<b>864.720</b>	50/600
			<b>864.8020</b>	50/400	<b>864.820</b>	50/400	
		M25X1,5	Ø25mm	<b>864.7025</b>	50/400	<b>864.725</b>	50/400
			<b>864.8025</b>	25/200	<b>864.825</b>	25/200	
		M32X1,5	Ø32mm	<b>864.7032</b>	25/200	<b>864.732</b>	25/200
			<b>864.8032</b>	20/160	<b>864.832</b>	20/160	
		M40X1,5	Ø40mm	<b>864.7040</b>	20/160	<b>864.740</b>	20/160
			<b>864.8040</b>	15/120	<b>864.840</b>	15/120	
M50X1,5	Ø50mm	<b>864.7050</b>	15/120	<b>864.750</b>	15/120		
	<b>864.8050</b>	10/80	<b>864.850</b>	10/80			

- The internal seal ensures IP65 protection even in the case of dilation due to temperature changes.

3.3



## Conduit TUBE Series

### ■ IP65 >> Sheath to box couplings

TUBE Series

864.



Sheath to box couplings  
(with bush)

Sheath to box couplings

IP	Colour	Cable outlet	Ø	CONDUIT COUPLING			
				Part Number	Length		
IP65	■	M16X1,5	Ø10mm		<b>864.651</b>	50/1200	
			Ø12mm	<b>864.0653</b>	50/1200	<b>864.653</b>	50/1200
		M20X1,5	Ø16mm	<b>864.0655</b>	50/800	<b>864.655</b>	50/800
		M25X1,5	Ø20mm	<b>864.0657</b>	50/400	<b>864.657</b>	50/400
		M32X1,5	Ø25mm	<b>864.0659</b>	25/300	<b>864.659</b>	25/300
		M40X1,5	Ø32mm	<b>864.0661</b>	25/200	<b>864.661</b>	25/200
		M50X1,5	Ø40mm	<b>864.0663</b>	15/120	<b>864.663</b>	15/120
		M63X1,5	Ø50mm	<b>864.0665</b>	10/80	<b>864.665</b>	10/80
		PG 11	Ø12mm	<b>864.0601</b>	50/1200	<b>864.601</b>	50/1200
				<b>864.0603</b>	50/1200	<b>864.603</b>	50/1200
		PG 13.5		<b>864.0605</b>	50/800	<b>864.605</b>	50/800
				<b>864.0606</b>	50/800	<b>864.606</b>	50/800
		PG 16	Ø16mm	<b>864.0606</b>	50/800	<b>864.606</b>	50/800
		PG 21	Ø20mm	<b>864.0607</b>	50/400	<b>864.607</b>	50/400
		PG 29	Ø25mm	<b>864.0609</b>	25/300	<b>864.609</b>	25/300
		PG 36	Ø32mm	<b>864.0611</b>	20/160	<b>864.611</b>	25/200

- Supplied complete with threaded lock nut and relative seal.



**TUBE Series**  
Flexible joints for rigid-box tube connections

# Conduit SMART Series



■ IP66/67

## SMART Series

866.



**Bend with two couplings**

**Conduit coupling**

**Conduit to box couplings**

**Conduit to sheath couplings**

BEND WITH TWO COUPLINGS

JOINT COVER

CONDUIT COUPLING

IP66/IP67

IP66

Ø	BEND WITH TWO COUPLINGS		JOINT COVER IP66/IP67		CONDUIT COUPLING		CONDUIT COUPLING IP66	
Ø16mm	<b>866.216</b>	10/200	<b>866.316</b>	10/200	<b>866.516</b>	10/240	<b>866.816</b>	10/240
Ø20mm	<b>866.220</b>	10/200	<b>866.320</b>	10/200	<b>866.520</b>	10/240	<b>866.820</b>	10/240
Ø25mm	<b>866.225</b>	10/160	<b>866.325</b>	10/160	<b>866.525</b>	10/200	<b>866.825</b>	10/200
Ø32mm	<b>866.232</b>	10/100	<b>866.332</b>	10/100	<b>866.532</b>	10/100	<b>866.832</b>	10/100
Ø40mm	<b>866.240</b>	5/50	<b>866.340</b>	5/50	<b>866.540</b>	5/60	<b>866.840</b>	5/60
Ø50mm	<b>866.250</b>	5/30	<b>866.350</b>	5/30	<b>866.550</b>	5/40	<b>866.850</b>	5/40

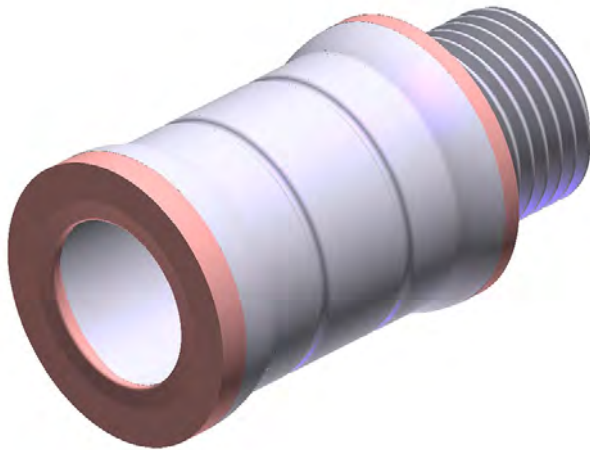

### Co-injection moulded gasket

The use of a co-injection moulding system makes it possible to turn the technopolymer gasket into an extension of the piece and disguise it as part of the pipe. It also provides a greater degree of sealing efficiency and makes it easier to insert pipe fittings without squashing or deforming the gasket.

3.3



## 3.4

# Trunking systems

- WADO Series - Mini-trunking
- WADO Series - Skirting trunking
- WADO Series - Cable and set housing trunking
- WADO Series - Slotted cable trunking
- WADO Series - Trunking for air conditioning systems





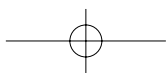
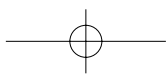

## Trunking systems

### WADO Series - Mini-trunking

#### Adhesive mini-trunking

#### WADO Series - Mini Trunking

876.



ACCESSORIES

Colour	Dimension	N° compt.	Equipped with hinged coverage (1 meter)
	12x12mm	1	<b>876.1212AD</b> 90
	12x7mm		<b>876.1207AD</b> 160
	16x12mm		<b>876.1612AD</b> 70

- Mounting: wall or ceiling
- Can be removed without any tool.
- Standard bar length: 2m.

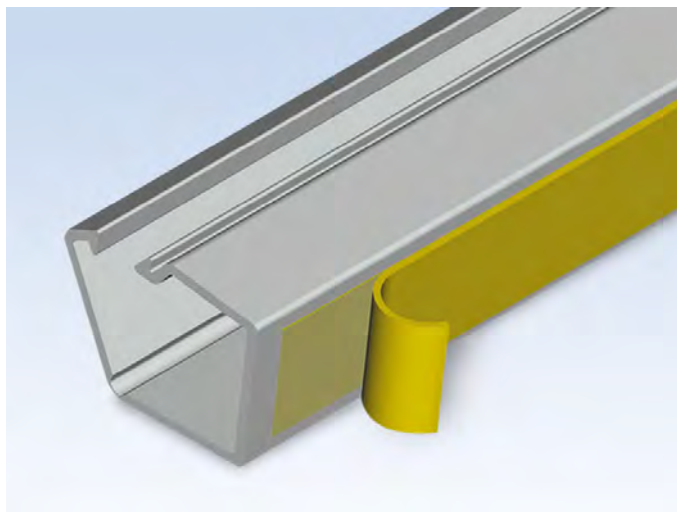

The mini-trunking base is equipped with a strip of bi-adhesive tape allowing sticking to even and clean surfaces.



**LID**  
Hinged coverage



**LID**  
Enveloping lid



**LID**  
Standard lid

# Trunking systems

## WADO Series - Mini-trunking







### ■ Mini-trunking

#### WADO Series - Mini Trunking

876.



Colour	Dimension	N° compt.	 Standard lid (1 meter)	 Enveloping lid (1 meter)
	20x10mm	1	<b>876.2010</b> 80	
	20x15mm		<b>876.2015</b> 50	<b>876.2015AV</b> 50
	30x15mm		<b>876.3015</b> 60	<b>876.3015AV</b> 60
	40x10mm	2	<b>876.4010</b> 72	
	40x15mm		<b>876.4015</b> 48	<b>876.4015AV</b> 48
	40x20mm	1	<b>876.4021</b> 36	
	40x20mm	2	<b>876.4020</b> 36	<b>876.4020AV</b> 36
	60x20mm	3	<b>876.6020</b> 32	<b>876.6020AV</b> 32
	20x10mm	1	<b>876.2010G</b> 80	
	20x15mm		<b>876.2015G</b> 50	
	30x15mm		<b>876.3015G</b> 60	
	40x10mm	2	<b>876.4010G</b> 72	
	40x15mm		<b>876.4015G</b> 48	
	40x20mm	1	<b>876.4021G</b> 36	
	40x20mm	2	<b>876.4020G</b> 36	
	60x20mm	3	<b>876.6020G</b> 32	

- Standard bar length: 2m.

3.4



## Trunking systems

### WADO Series - Mini-trunking

#### ■ Accessories >> Angles

#### WADO Series - Mini Trunking

876.



ACCESSORIES

Colour	Dimension	N° compt.	External angle		Internal angle		Flat angle		
■	20x10mm	1	<b>876.AE2010</b>	30	<b>876.AI2010</b>	30	<b>876.AP2010</b>	30	
	20x15mm		<b>876.AE2015</b>	30	<b>876.AI2015</b>	30	<b>876.AP2015</b>	30	
	30x15mm		<b>876.AE3015</b>	30	<b>876.AI3015</b>	30	<b>876.AP3015</b>	30	
	40x10mm	2	<b>876.AE4010</b>	30	<b>876.AI4010</b>	30	<b>876.AP4010</b>	30	
	40x15mm		<b>876.AE4015</b>	30	<b>876.AI4015</b>	30	<b>876.AP4015</b>	30	
	40x20mm		<b>876.AE4020</b>	30	<b>876.AI4020</b>	30	<b>876.AP4020</b>	30	
	60x20mm	3	<b>876.AE6020</b>	30	<b>876.AI6020</b>	30	<b>876.AP6020</b>	30	
	■	20x10mm	1	<b>876.AE2010G</b>	30	<b>876.AI2010G</b>	30	<b>876.AP2010G</b>	30
		20x15mm		<b>876.AE2015G</b>	30	<b>876.AI2015G</b>	30	<b>876.AP2015G</b>	30
30x15mm		<b>876.AE3015G</b>		30	<b>876.AI3015G</b>	30	<b>876.AP3015G</b>	30	
40x10mm		2	<b>876.AE4010G</b>	30	<b>876.AI4010G</b>	30	<b>876.AP4010G</b>	30	
40x15mm			<b>876.AE4015G</b>	30	<b>876.AI4015G</b>	30	<b>876.AP4015G</b>	30	
40x20mm			<b>876.AE4020G</b>	30	<b>876.AI4020G</b>	30	<b>876.AP4020G</b>	30	
60x20mm		3	<b>876.AE6020G</b>	30	<b>876.AI6020G</b>	30	<b>876.AP6020G</b>	30	

# Trunking systems

## WADO Series - Mini-trunking



### ■ Accessories >> Adaptor

#### WADO Series - Mini Trunking

876.



Colour	Dimension	N° compt.	Side adaptor		End adaptor	
■	20x10mm	1	<b>876.AL2010</b>	30	<b>876.AT2010</b>	30
	20x15mm		<b>876.AL2015</b>	30	<b>876.AT2015</b>	30
	30x15mm		<b>876.AL3015</b>	30	<b>876.AT3015</b>	30
	40x10mm		<b>876.AL4010</b>	6/30		
	40x15mm	2			<b>876.AT4010</b>	30
	40x15mm	1	<b>876.AL4015</b>	6/30		
		2			<b>876.AT4015</b>	30
	40x20mm	1	<b>876.AL4020</b>	6/30		
		2			<b>876.AT4020</b>	30
	60x20mm	1	<b>876.AL6020</b>	6/30		
		3			<b>876.AT6020</b>	30
	■	20x10mm	1	<b>876.AL2010G</b>	30	<b>876.AT2010G</b>
20x15mm		<b>876.AL2015G</b>		30	<b>876.AT2015G</b>	30
30x15mm		<b>876.AL3015G</b>		30	<b>876.AT3015G</b>	30
40x10mm		<b>876.AL4010G</b>		6/30		
40x10mm		2			<b>876.AT4010G</b>	30
40x15mm		1	<b>876.AL4015G</b>	6/30		
		2			<b>876.AT4015G</b>	30
40x20mm		1	<b>876.AL4020G</b>	6/30		
		2			<b>876.AT4020G</b>	30
60x20mm		1	<b>876.AL6020G</b>	6/30		
		3			<b>876.AT6020G</b>	30

3.4



## Trunking systems

### WADO Series - Mini-trunking

#### Accessories >> Joints

#### WADO Series - Mini Trunking

876.



Colour	Dimension	N° compt.	Flat tee	Cover joint	End cap	
White	20x10mm	1	<b>876.GT2010</b> 30	<b>876.GU2010</b> 30	<b>876.TT2010</b> 30	
	20x15mm		<b>876.GT2015</b> 30	<b>876.GU2015</b> 30	<b>876.TT2015</b> 30	
	30x15mm		<b>876.GT3015</b> 30	<b>876.GU3015</b> 30	<b>876.TT3015</b> 30	
	40x10mm	2	<b>876.GT4010</b> 30	<b>876.GU4010</b> 30	<b>876.TT4010</b> 30	
	40x15mm		<b>876.GT4015</b> 30	<b>876.GU4015</b> 30	<b>876.TT4015</b> 30	
	40x20mm		<b>876.GT4020</b> 30	<b>876.GU4020</b> 30	<b>876.TT4020</b> 30	
	60x20mm	3	<b>876.GT6020</b> 30	<b>876.GU6020</b> 30	<b>876.TT6020</b> 30	
	Grey	20x10mm	1	<b>876.GT2010G</b> 30	<b>876.GU2010G</b> 30	<b>876.TT2010G</b> 30
		20x15mm		<b>876.GT2015G</b> 30	<b>876.GU2015G</b> 30	<b>876.TT2015G</b> 30
30x15mm		<b>876.GT3015G</b> 30		<b>876.GU3015G</b> 30	<b>876.TT3015G</b> 30	
40x10mm		2	<b>876.GT4010G</b> 30	<b>876.GU4010G</b> 30	<b>876.TT4010G</b> 30	
40x15mm			<b>876.GT4015G</b> 30	<b>876.GU4015G</b> 30	<b>876.TT4015G</b> 30	
40x20mm			<b>876.GT4020G</b> 30	<b>876.GU4020G</b> 30	<b>876.TT4020G</b> 30	
60x20mm		3	<b>876.GT6020G</b> 30	<b>876.GU6020G</b> 30	<b>876.TT6020G</b> 30	

#### Accessories >> Others

#### WADO Series - Mini Trunking

876.



Colour	Dimension	N° compt.	Ø	Connection Ø16mm	Cable retainer
White	20x10mm	1	Ø16mm	<b>876.RT2010</b> 30	<b>876.TF20</b> 30
	20x15mm			<b>876.RT2015</b> 30	
Blue	30x15mm	2	Ø16mm		<b>876.TF30</b> 30
	40x15mm				<b>876.TF40</b> 30
	60x20mm				<b>876.TF60</b> 30
Grey	20x10mm	1	Ø16mm	<b>876.RT2010G</b> 30	
	20x15mm			<b>876.RT2015G</b> 30	

## Trunking systems

### WADO Series - Mini-trunking

**SCAME**

#### Boxes

#### WADO Series - Mini Trunking

876.



Colour	Dimension	Wheel-base	Box for wiring accessories	
□	100x100x35mm	55mm	<b>876.PA5530</b> <sup>[1]</sup>	10
	100x100x43mm	60mm	<b>876.PA6040</b> <sup>[2]</sup>	10
	100x100x53mm		<b>876.PA6050</b> <sup>[2]</sup>	10
	142x100x43mm	83,5mm	<b>876.PA8040</b> <sup>[3]</sup>	10
	142x100x53mm		<b>876.PA8050</b> <sup>[3]</sup>	10
■	100x100x35mm	55mm	<b>876.PA5530G</b> <sup>[1]</sup>	10
	100x100x43mm	60mm	<b>876.PA6040G</b> <sup>[2]</sup>	10
	100x100x53mm		<b>876.PA6050G</b> <sup>[2]</sup>	10
	142x100x43mm	83,5mm	<b>876.PA8040G</b> <sup>[3]</sup>	10
	142x100x53mm		<b>876.PA8050G</b> <sup>[3]</sup>	10

[1] Suitable for OTEO Series inserts by LEGRAND®.

[2] They consist of a base and a lid and can accommodate switch-and-plug frames whose distance between centers is 60mm.

[3] They consist of a base and a lid and can accommodate switch-and-plug frames whose distance between centers is 83.5mm.

- They can be mounted on all WADO series Scame mini-trunking.
- When combined to the proper end adaptor (AT) or side adaptor (AL), they allow for quick installation and complete the connection to the mini-trunking; the outcome is an elegant and attractive look, free from any imperfections.

#### WADO Series - Mini Trunking

876.



Colour	Wheel-base	Junction box kit	
□	60mm	<b>876.PK60</b>	10
	83,5mm	<b>876.PK80</b>	10
■	60mm	<b>876.PK60G</b>	10
	83,5mm	<b>876.PK80G</b>	10

- The kit includes a cover and a circuit separation accessory.
- When combined to the back box, it allows to obtain a spacious junction box.
- Snap-on fixing

3.4



## Trunking systems



### WADO Series - Mini-trunking

#### Boxes

#### WADO Series - Mini Trunking

876.



Colour	Dimension	Junction box	
	67x67mm	<b>876.SA70</b>	10
		<b>876.SA70G</b>	10

- Compact box of reduced size, equipped with circuit separation accessory.
- Ideal to shunt micro raceways up to 40x20mm, it has the same characteristics of PK60 and PK80 boxes.
- Steel screw class 4.8 and yellow passivated zinc-plating  $\geq 5\mu$ .

#### WADO Series - Mini Trunking

876.



Colour	Ø	Fixing plugs	
	Ø4mm	<b>876.PK04</b>	100/1000

- Countersunk collar.
- Quick application, with only a few hammer blows.
- Hole passing through the object to be anchored.
- Polyamide body equipped with a special pre-assembled, cross-slotted nail type screw.
- Steel screw class 4.8 and yellow passivated zinc-plating  $\geq 5\mu$ .

ACCESSORIES

1

2

3

4



## Trunking systems

### WADO Series - Skirting trunking



#### ■ Skirting trunking >> Skirting trunking

#### WADO Series - SkirtingTrunking

879.



Colour	Dimension	N° compt.	80mm (1 meter)	120mm (1 meter)
	80mm	3	<b>879.0080</b> 20	
	120mm	5		<b>879.0120</b> 20
	80mm	3	<b>879.0080M</b> 20	
	120mm	5		<b>879.0120M</b> 20
	80mm	3	<b>879.0080A</b> 20	
	120mm	5		<b>879.0120A</b> 20

- Standard bar length: 2m.

#### ■ Skirting trunking

#### WADO Series - SkirtingTrunking

879.



Colour	Dimension	Floor trunking (1 meter)
	70mm	<b>879.0007</b> 20
		<b>879.0007G</b> 20
		<b>879.0007M</b> 20
		<b>879.0007A</b> 20

- Resistant to aging.
- Type of installation: on the floor.
- Removable with tool.
- Voltage rating: 1000 V~.
- Shock resistance: 2J.
- Standard bar length: 2m.
- Made of rigid, insulated, self-extinguishing and impact-resistant thermoplastic material.

3.4



## Trunking systems

### WADO Series - Skirting trunking

#### Accessories >> Angles

##### WADO Series - SkirtingTrunking

879.



Colour	Dimension	N° compt.	Variable external angle	Variable internal angle	Flat angle	Variable flat angle
White	80mm	3	<b>879.AE0080</b> 10	<b>879.AI0080</b> 10	<b>879.AP0080</b> 10	
	120mm	5	<b>879.AE0120</b> 10	<b>879.AI0120</b> 10		<b>879.AV0120</b> 10
Brown	80mm	3	<b>879.AE0080M</b> 10	<b>879.AI0080M</b> 10	<b>879.AP0080M</b> 10	
	120mm	5	<b>879.AE0120M</b> 10	<b>879.AI0120M</b> 10		<b>879.AV0120M</b> 10
Grey	80mm	3	<b>879.AE0080A</b> 10	<b>879.AI0080A</b> 10	<b>879.AP0080A</b> 10	
	120mm	5	<b>879.AE0120A</b> 10	<b>879.AI0120A</b> 10		<b>879.AV0120A</b> 10

#### Accessories >> Joints

##### WADO Series - SkirtingTrunking

879.



Colour	Dimension	N° compt.	Flat tee for mini-trunking	Flat tee for floor trunking	Flat tee	Joint cover
White	80mm	3	<b>879.GM0080</b> 10	<b>879.GS0080</b> 10	<b>879.GT0080</b> 10	<b>879.GU0080</b> 10
	120mm	5	<b>879.GM0120</b> 10	<b>879.GS0120</b> 10	<b>879.GT0120</b> 10	<b>879.GU0120</b> 10
Brown	80mm	3	<b>879.GM0080M</b> 10	<b>879.GS0080M</b> 10	<b>879.GT0080M</b> 10	<b>879.GU0080M</b> 10
	120mm	5	<b>879.GM0120M</b> 10	<b>879.GS0120M</b> 10	<b>879.GT0120M</b> 10	<b>879.GU0120M</b> 10
Grey	80mm	3	<b>879.GM0080A</b> 10	<b>879.GS0080A</b> 10	<b>879.GT0080A</b> 10	<b>879.GU0080A</b> 10
	120mm	5	<b>879.GM0120A</b> 10	<b>879.GS0120A</b> 10	<b>879.GT0120A</b> 10	<b>879.GU0120A</b> 10

# Trunking systems

## WADO Series - Skirting trunking



### ■ Accessories >> Closing cap

WADO Series - SkirtingTrunking  
879.



Colour	Dimension	N° compt.	Blind closing cap	Closing cap - With output for 80 skirting trunking	Closing cap - With output for mini-trunking
White	80mm	3	<b>879.CC0080</b> 10	<b>879.CC0121</b> 10	<b>879.CC0122</b> 10
	120mm	5	<b>879.CC0120</b> 10		
Brown	80mm	3	<b>879.CC0080M</b> 10	<b>879.CC0121M</b> 10	<b>879.CC0122M</b> 10
	120mm	5	<b>879.CC0120M</b> 10		
Grey	80mm	3	<b>879.CC0080A</b> 10	<b>879.CC0121A</b> 10	<b>879.CC0122A</b> 10
	120mm	5	<b>879.CC0120A</b> 10		

### ■ Accessories >> Terminal

WADO Series - SkirtingTrunking  
879.



Colour	Dimension	N° compt.	Through-wall terminal	End cap
White	80mm	3	<b>879.TM0080</b> 5	<b>879.TT0080</b> 10
	120mm	5	<b>879.TM0120</b> 5	<b>879.TT0120</b> 10
Brown	80mm	3	<b>879.TM0080M</b> 5	<b>879.TT0080M</b> 10
	120mm	5	<b>879.TM0120M</b> 5	<b>879.TT0120M</b> 10
Grey	80mm	3	<b>879.TM0080A</b> 5	<b>879.TT0080A</b> 10
	120mm	5	<b>879.TM0120A</b> 5	<b>879.TT0120A</b> 10

3.4

# Trunking systems

## WADO Series - Skirting trunking

### Accessories

- 1
- 2
- 3

ACCESSORIES

#### WADO Series - SkirtingTrunking

879.



Colour	Dimension	N° compt.	Fittings for phone jack	
	80mm	3	<b>879.TE80</b>	5
			<b>879.TE80M</b>	5
			<b>879.TE80A</b>	5

- For 3-module boxes

- 4

#### WADO Series - SkirtingTrunking

879.



Colour	Cable retainer
	<b>879.TF80</b> 30

#### WADO Series - SkirtingTrunking

879.



Colour	Dimension	Section cover (1 meter)
	80-120mm	<b>879.CP80</b> 20/200

- Standard bar length: 2m.

# Trunking systems

## WADO Series - Skirting trunking



### Box for wiring accessories

WADO Series - SkirtingTrunking

879.



Colour	Dimension	Wheel-base	Horizontal - 2 modules 60-mm centres distance	
	80mm (h53mm)	60mm	<b>879.PA6050</b>	5
	120mm (h53mm)		<b>879.PA6051</b>	5
	80mm (h53mm)		<b>879.PA6050M</b>	5
	120mm (h53mm)		<b>879.PA6051M</b>	5
	80mm (h53mm)		<b>879.PA6050A</b>	5
	120mm (h53mm)		<b>879.PA6051A</b>	5

### Accessories

WADO Series - SkirtingTrunking

879.



Colour	Flat tee for floor trunking	
	<b>879.GT0007</b>	10
	<b>879.GT0007G</b>	10
	<b>879.GT0007M</b>	10
	<b>879.GT0007A</b>	10

3.4



## Trunking systems

### WADO Series - Skirting trunking

#### Box for wiring accessories

#### WADO Series - SkirtingTrunking

879.



#### Horizontal - 3 modules 83.5-mm centres distance

Colour	Dimension	Wheel-base		
White	80mm (h43mm)	83,5mm	<b>879.PA8040</b>	5
	80mm (h53mm)		<b>879.PA8050</b>	5
	120mm (h53mm)		<b>879.PA8051</b>	5
Brown	80mm (h43mm)		<b>879.PA8040M</b>	5
	80mm (h53mm)		<b>879.PA8050M</b>	5
	120mm (h53mm)		<b>879.PA8051M</b>	5
Black	80mm (h43mm)		<b>879.PA8040A</b>	5
	80mm (h53mm)		<b>879.PA8050A</b>	5
	120mm (h53mm)		<b>879.PA8051A</b>	5

#### WADO Series - SkirtingTrunking

879.



#### Horizontal - 4 modules 108.5-mm centres distance

Colour	Dimension	Wheel-base		
White	80mm (h53mm)	108,5mm	<b>879.PA8450</b>	5
	120mm (h53mm)		<b>879.PA8451</b>	5
Brown	80mm (h53mm)		<b>879.PA8450M</b>	5
	120mm (h53mm)		<b>879.PA8451M</b>	5
Black	80mm (h53mm)		<b>879.PA8450A</b>	5
	120mm (h53mm)		<b>879.PA8451A</b>	5

1  
2  
3

ACCESSORIES

4

# Trunking systems

## WADO Series - Skirting trunking



### ■ Box for wiring accessories

#### WADO Series - SkirtingTrunking

879.



Colour	Dimension	Wheel-base	Horizontal - 6 modules 120-mm centres distance	
White	80mm (h53mm)	120mm	<b>879.PA9050</b>	5
	120mm (h53mm)		<b>879.PA9051</b>	5
Brown	80mm (h53mm)		<b>879.PA9050M</b>	5
	120mm (h53mm)		<b>879.PA9051M</b>	5
Black	80mm (h53mm)		<b>879.PA9050A</b>	5
	120mm (h53mm)		<b>879.PA9051A</b>	5

#### WADO Series - SkirtingTrunking

879.



Colour	Dimension	Wheel-base	Vertical - 3 modules 83.5-mm centres distance	
White	80mm (h43mm)	83,5mm	<b>879.PB8040</b>	5
	80mm (h53mm)		<b>879.PB8050</b>	5
Brown	80mm (h43mm)		<b>879.PB8040M</b>	5
	80mm (h53mm)		<b>879.PB8050M</b>	5
Black	80mm (h43mm)		<b>879.PB8040A</b>	5
	80mm (h53mm)		<b>879.PB8050A</b>	5

3.4



## Trunking systems

### WADO Series - Skirting trunking







#### Box for wiring accessories

#### WADO Series - SkirtingTrunking

879.



ACCESSORIES

Colour	Wheel-base	Blank cover	
	60mm	<b>879.PD60</b>	5/30
	83,5mm	<b>879.PD80</b>	5/30
	60mm	<b>879.PD60M</b>	5/30
	83,5mm	<b>879.PD80M</b>	5/30
	60mm	<b>879.PD60A</b>	5/30
	83,5mm	<b>879.PD80A</b>	5/30

- When combined to the back box, it allows to obtain a spacious junction box.
- Snap-on fixing

#### WADO Series - Mini Trunking

876.



Colour	Ø	Fixing device	
	ø5mm	<b>876.PK05</b>	100/1000
	ø6mm	<b>876.PK06</b>	100/1000

- Countersunk collar.
- Quick application, with only a few hammer blows.
- Hole passing through the object to be anchored.
- Polyamide body equipped with a special pre-assembled, cross-slotted nail type screw.
- Steel screw class 4.8 and yellow passivated zinc-plating  $\geq 5\mu$ .



## Trunking systems

### WADO Series - Cable and set housing trunking



#### ■ Cable and set housing trunking

#### WADO Series - Cable Trunking

872.



Colour	Dimension	N° compt.	Cable trunking (1 meter)	Cable and set housing trunking (1 meter)
	40x40mm	1	<b>872.04040</b> <sup>[1]</sup> 60	
	60x40mm		<b>872.06040</b> <sup>[1]</sup> 40	
	60x60mm		<b>872.06060</b> <sup>[1]</sup> 32	
	80x60mm	3	<b>872.08060</b> <sup>[1]</sup> 24	
	100x60mm			<b>872.10060</b> <sup>[2]</sup> 18
	100x80mm		<b>872.10080</b> <sup>[1]</sup> 16	
	150x60mm			<b>872.15060</b> <sup>[2]</sup> 12
	150x80mm	5		<b>872.15080</b> <sup>[2]</sup> 8
	200x80mm	7		<b>872.20080</b> <sup>[2]</sup> 8

[1] This separator can be installed by means of a specific fastener for fixing components to the bottom (TE).

[2] Each bar is provided with cable fixing ties.

- Standard bar length: 2m.

#### ■ Angles

#### WADO Series - Cable Trunking

872.



External angle

Internal angle

Flat angle

Dimension	N° compt.	External angle	Internal angle	Flat angle
40x40mm	1	<b>872.AE04040</b> 10/60	<b>872.AI04040</b> 10/60	<b>872.AP04040</b> 10/120
60x40mm		<b>872.AE06040</b> 10/40	<b>872.AI06040</b> 10/60	<b>872.AP06040</b> 10/60
60x60mm		<b>872.AE06060</b> 10/40	<b>872.AI06060</b> 10/40	<b>872.AP06060</b> 10/40
80x60mm	3	<b>872.AE08060</b> 10/30	<b>872.AI08060</b> 10/30	<b>872.AP08060</b> 10/20
100x60mm		<b>872.AE10060</b> 8/16	<b>872.AI10060</b> 10/30	<b>872.AP10060</b> 1/20
100x80mm		<b>872.AE10080</b> 8/16	<b>872.AI10080</b> 10/20	<b>872.AP10080</b> 10/20
150x60mm		<b>872.AE15060</b> 1/6	<b>872.AI15060</b> 1/8	<b>872.AP15060</b> 1/12
150x80mm	5	<b>872.AE15080</b> 1/6	<b>872.AI15080</b> 1/6	<b>872.AP15080</b> 1/9
200x80mm	7	<b>872.AE20080</b> 1/4	<b>872.AI20080</b> 1/4	<b>872.AP20080</b> 1/6

3.4



## Trunking systems

### WADO Series - Cable and set housing trunking

#### Accessories

#### WADO Series - Cable Trunking

872.



Joint cover



End cap

Dimension	N° compt.		
40x40mm	1		<b>872.TT04040</b> 20
60x40mm			<b>872.TT06040</b> 20
60x60mm	3		<b>872.TT06060</b> 20
80x60mm			<b>872.TT08060</b> 20
100mm		<b>872.GU100</b> 20	
100x60mm			<b>872.TT10060</b> 20
100x80mm	3		<b>872.TT10080</b> 20
150mm		<b>872.GU150</b> 20	
150x60mm			<b>872.TT15060</b> 20
150x80mm	5		<b>872.TT15080</b> 20
200mm		<b>872.GU200</b> 20	
200x80mm	7		<b>872.TT20080</b> 20
40mm		<b>872.GU040</b> 20	
60mm		<b>872.GU060</b> 20	
80mm		<b>872.GU080</b> 20	

#### Joints

#### WADO Series - Cable Trunking

872.



Linear joint



Flat joint



Flat tee



Variable joint

Dimension				
40mm		<b>872.GP40</b> 20	<b>872.GT40</b> 20	
60mm		<b>872.GP60</b> 20	<b>872.GT60</b> 10	
80mm		<b>872.GP80</b> 20	<b>872.GT80</b> 10	
	<b>872.GL02</b> 10			<b>872.GV02</b> <sup>1</sup> 10

<sup>1</sup> To be installed on the trunking sides.

# Trunking systems

## WADO Series - Cable and set housing trunking



### Switch holder and plate >> Flat connector block

WADO Series - Cable Trunking

872.



Flat connector block

Modular switches unit

Dimension	Modularity		
40mm		<b>872.SA40</b>	1/10
60mm		<b>872.SA60</b>	1/4
	4 DIN		<b>872.SC01</b> 1/9
	10 DIN		<b>872.SC02</b> 1/10

### Switch holder and plate >> Switch holder 60mm

WADO Series - Cable Trunking

872.



Switch holder 60mm

Switch holder 60mm

Switch holder 60mm

Dimension	Wheel-base		
80mm			<b>872.PB080</b> 20
100mm			<b>872.PB100</b> 15
150mm	60mm		<b>872.PB150</b> 15
200mm			<b>872.PB200</b> 10
		<b>872.PB02</b> <sup>1</sup>	1/30
		<b>872.PB04</b> <sup>1</sup>	1/20

<sup>1</sup> Note: for 80x60 and 100x80 versions, use the specific bottom fixing accessory.

3.4



## Trunking systems

### WADO Series - Cable and set housing trunking

#### ■ Switch holder and plate >> Switch holder 83.5mm

WADO Series - Cable Trunking

872.



Switch holder 83,5mm

Switch holder 83,5mm

Dimension	Wheel-base		
80mm	83,5mm		<b>872.PA080</b> 20
100mm			<b>872.PA100</b> 15
150mm			<b>872.PA150</b> 15
200mm			<b>872.PA200</b> 10
		<b>872.PA02</b> <sup>[1]</sup> 1/20	

[1] Note: for 80x60 and 100x80 versions, use the specific bottom fixing accessory.

#### ■ Switch holder and plate >> IEC socket holder

WADO Series - Cable Trunking

872.



IEC socket holder

IEC socket holder

6 DIN modular switch plate

Dimension			
80mm		<b>872.PC080</b> 20	
100mm		<b>872.PC100</b> 15	
150mm		<b>872.PC150</b> 15	<b>872.PD150</b> 10
200mm		<b>872.PC200</b> 10	<b>872.PD200</b> 10
	<b>872.PC02</b> 1/30		

ACCESSORIES

1

2

3

4

# Trunking systems

## WADO Series - Cable and set housing trunking



### ■ Supports and ties

#### WADO Series - Cable Trunking

872.



Apparatus support



Home installation support tie



Collar cable fastener



Cable fastening tie

Dimension					
100mm		<b>872.TB100</b>	20	<b>872.TF100</b>	20
100x60mm				<b>872.TC10060</b>	10/120
100x80mm				<b>872.TC10080</b>	10/120
150mm		<b>872.TB150</b>	20	<b>872.TF150</b>	20
200mm				<b>872.TF200</b>	20
60-80mm	<b>872.TA02</b>		1/10		

### ■ Complements

#### WADO Series - Cable Trunking

872.



Separator (1 meter)



Wall shelf



Fasteners for fixing components to the base

Dimension					
40÷100mm		<b>872.MP01</b>	20/80	<b>872.TE100</b>	20
100mm					
150÷200mm		<b>872.MP02</b>	1/20		
40mm	<b>872.CS40</b> <sup>[1]</sup>		100	<b>872.TE060</b>	20
60mm	<b>872.CS60</b> <sup>[1]</sup>		72	<b>872.TE080</b>	20
80mm					

[1] Standard bar length: 2m.

3.4



## Trunking systems

### WADO Series - Slotted cable trunking

#### WADO Series - Slotted Cable

874.



 Short pitch [4/6/4]  
(1 meter)

 Standard pitch [8/  
12/8 - 6/8/6] (1  
meter)

Dimension	N° compt.	Quarry height	Short pitch [4/6/4] (1 meter)		Standard pitch [8/12/8 - 6/8/6] (1 meter)	
80x60mm	1	50mm	<b>874.R8060</b>	24	<b>874.8060</b>	24
100x40mm		30mm	<b>874.R0040</b>	24	<b>874.0040</b>	24
100x60mm		50mm	<b>874.R0060</b>	20	<b>874.0060</b>	20
100x80mm		68mm	<b>874.R0080</b>	16	<b>874.0080</b>	16
120x40mm		30mm	<b>874.R0240</b>	20	<b>874.0240</b>	20
120x60mm		50mm	<b>874.R0260</b>	14	<b>874.0260</b>	14
120x80mm		68mm	<b>874.R0280</b>	12	<b>874.0280</b>	12
25x30mm		23,5mm	<b>874.R2530</b>	58	<b>874.2530</b> <sup>[1]</sup>	58
25x40mm		30mm	<b>874.R2540</b>	48	<b>874.2540</b>	48
25x60mm		50mm	<b>874.R2560</b>	34	<b>874.2560</b>	34
25x80mm		68mm	<b>874.R2580</b>	28	<b>874.2580</b>	28
40x30mm		23,5mm	<b>874.R4030</b>	38	<b>874.4030</b> <sup>[1]</sup>	38
40x40mm		30mm	<b>874.R4040</b>	30	<b>874.4040</b>	30
40x60mm		50mm	<b>874.R4060</b>	22	<b>874.4060</b>	22
40x80mm		68mm	<b>874.R4080</b>	36	<b>874.4080</b>	36
60x40mm		30mm	<b>874.R6040</b>	40	<b>874.6040</b>	40
60x60mm		50mm	<b>874.R6060</b>	32	<b>874.6060</b>	32
60x80mm		68mm	<b>874.R6080</b>	24	<b>874.6080</b>	24
80x40mm		30mm	<b>874.R8040</b>	32	<b>874.8040</b>	32
80x80mm		68mm	<b>874.R8080</b>	16	<b>874.8080</b>	16

[1] For trunking h 30 pitch 6/8/6.

- Standard bar length: 2m.



**PITCH**  
Standard pitch



**PITCH**  
Short pitch

# Trunking systems

## WADO Series - Trunking for air conditioning systems



### WADO Series - Conditioning

871.



Colour	Dimension	Trunking (1 meter)	
□	60x45mm	<b>871.060</b>	24
	80x60mm	<b>871.080</b>	16
	110x75mm	<b>871.110</b>	8

- Standard bar length: 2m.

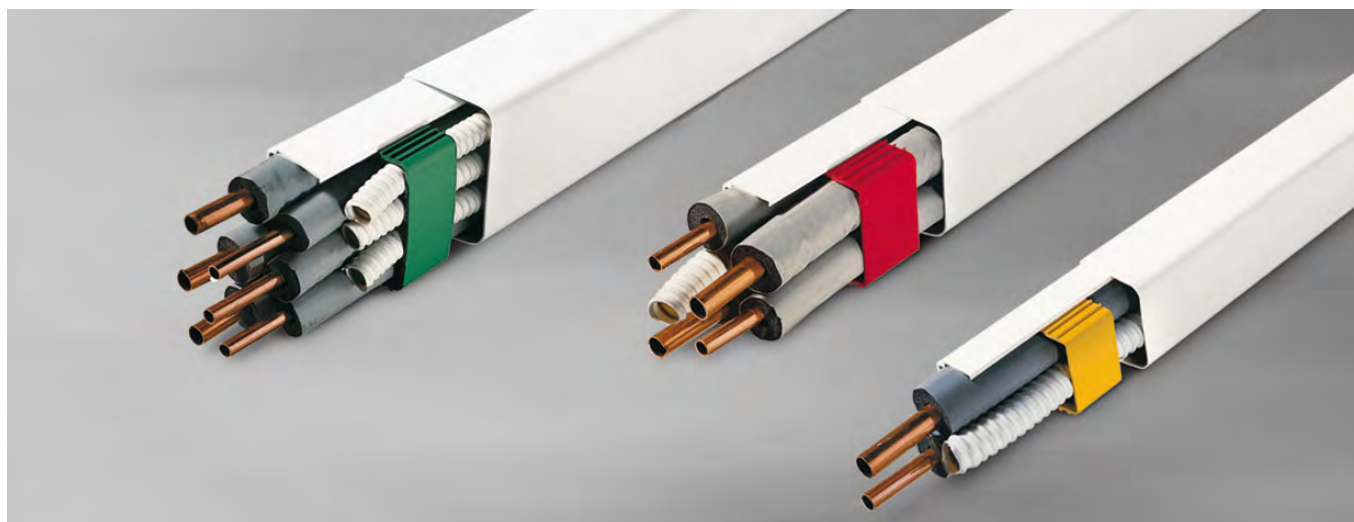

3.4



## Trunking systems

### WADO Series - Trunking for air conditioning systems

#### Angles (internal-external)

##### WADO Series - Conditioning

871.



Colour	Dimension	External angle	Variable external angle	Internal angle	Variable internal angle
	60x45mm	<b>871.AE060</b> 12	<b>871.AEV060</b> 8	<b>871.AI060</b> 8	<b>871.AIV060</b> 6
	80x60mm	<b>871.AE080</b> 9	<b>871.AEV080</b> 6	<b>871.AI080</b> 6	<b>871.AIV080</b> 4
	110x75mm	<b>871.AE110</b> 6		<b>871.AI110</b> 4	

#### Angles (flat-vertical)

##### WADO Series - Conditioning

871.



Colour	Dimension	Flat angle	Variable flat angle	Vertical right angle	Vertical left angle
	60x45mm	<b>871.AP060</b> 10	<b>871.APV060</b> 8	<b>871.AVD060</b> 6	<b>871.AVS060</b> 6
	80x60mm	<b>871.AP080</b> 8	<b>871.APV080</b> 6	<b>871.AVD080</b> 4	<b>871.AVS080</b> 4
	110x75mm	<b>871.AP110</b> 6			

#### Joint

##### WADO Series - Conditioning

871.



Colour	Dimension	Wall bend	Flexible coupling	Flat tees	Joint cover
	60x45mm	<b>871.CM060</b> 9	<b>871.GF060</b> 6		<b>871.GU060</b> 30
	80x60mm	<b>871.CM080</b> 6	<b>871.GF080</b> 4	<b>871.GT080</b> 4	<b>871.GU080</b> 30
	110x75mm	<b>871.CM110</b> 4		<b>871.GT110</b> 2	<b>871.GU110</b> 20



# Trunking systems

## WADO Series - Trunking for air conditioning systems



### ■ Terminals

WADO Series - Conditioning

871.



Colour	Dimension	Through-wall terminal	End cap
■	60x45mm	<b>871.TM060</b> 10	<b>871.TT060</b> 12
	80x60mm	<b>871.TM080</b> 8	<b>871.TT080</b> 9
	110x75mm	<b>871.TM110</b> 8	

WADO Series - Conditioning

871.



Colour	Dimension	Tube fixing sleeper
■	80x60mm	<b>871.TF080</b> 30
■	60x45mm	<b>871.TF060</b> 30
■	110x75mm	<b>871.TF110</b> 20

3.4



# Trunking systems

## WADO Series - Trunking for air conditioning systems

### Complements

WADO Series - Conditioning

871.



Colour	Dimension	Coupling	Flush mounting box	Reduction
□	540x85mm	<b>871.GY16</b> <sup>[1]</sup> 20	<b>871.PA85</b> <sup>[2]</sup> 15	
			<b>871.PK85</b> <sup>[3]</sup> 5	
	110-->80mm			<b>871.RD080</b> 8
	80-->60mm			<b>871.RD060</b> 12

- [1] Two ways for spring pipe
- [2] With condensate discharge
- [3] Box cover

### Fixing

WADO Series - Conditioning

871.



Colour	Dimension	Basis
□	U-0350mm	<b>871.SP035</b> 2
	U-0450mm	<b>871.SP045</b> 2
	U-1000mm	<b>871.SP100</b> 4
		<b>871.SP001</b> 24

ACCESSORIES

4

# Trunking systems

## WADO Series - Trunking for air conditioning systems



### ■ Fixing

#### WADO Series - Conditioning

871.



Colour	Dimension	Stirrup (standard fixing)	
□	max 100kg	<b>871.MP100</b>	1
	max 140kg		<b>871.MP140</b> 1

- 2 parts

#### WADO Series - Conditioning

871.



Dimension	Ø	Vibration damper kit	
h20mm	ø30mm	<b>871.AV101</b>	1
h40mm	ø40mm		<b>871.AV201</b> 1
			<b>871.AV202</b> 1

- 4 parts

3.4



4

# DOMESTIC

Electrical components for  
domestic and similar  
applications

4.1	Plugs and sockets	PAG. 538
4.2	Adaptors	PAG. 544
4.3	Multi sockets	PAG. 554
4.4	Cable reels	PAG. 572
4.5	Lampholders and switches	PAG. 578
4.6	TV/SAT - TEL - DATA	PAG. 590
4.7	Wiring accessories	PAG. 604

4.1

## Plugs and sockets

- **AZZURRA Series**  
Plugs and trailing sockets
- **BLUELINE Series**  
Plugs and trailing sockets
- **QUICK Series**  
Plugs and trailing sockets
- **UNEL Series**  
Plugs and sockets with side earth contact



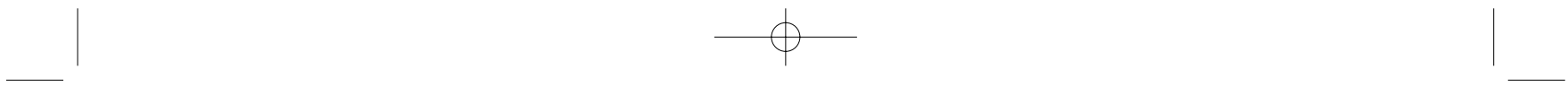

# Plugs and sockets

## AZZURRA Series

### Plugs and trailing sockets

AZZURRA Series

104.



Plugs with straight cable outlet

Trailing sockets with straight cable outlet

Flat plugs with 90° angled cable outlet

DOMESTIC

Poles	Current	Standard	Colour	PLUG	SOCKET	PLUG	
2P	10A	 Standard	White			<b>104.4010</b> 50/500 <b>104.4010/N</b> 50/500	
			Black				
		 Shuttered	White	<b>104.4000</b> <sup>1</sup> 50/500 <b>104.4000/N</b> <sup>1</sup> 50/500			
			Black				
2P+E	16A	 Standard	White	<b>104.4011</b> 50/500 <b>104.4011/N</b> 50/500		<b>104.4068</b> <sup>1</sup> 100 <b>104.4068/N</b> <sup>1</sup> 100	
			Black				
		 Shuttered	White	<b>104.4001</b> <sup>1</sup> 50/500 <b>104.4001/N</b> <sup>1</sup> 50/500		<b>104.4070</b> <sup>1</sup> 100 <b>104.4070/N</b> <sup>1</sup> 100	
			Black	<b>104.4003</b> <sup>1</sup> 50/500 <b>104.4003/N</b> <sup>1</sup> 50/500			
		 Standard	White		<b>104.4013</b> 50/500 <b>104.4013/N</b> 50/500		
			Black				

<sup>1</sup> Sleeved pin  
- Individual packing

<b>ITALIAN STANDARD P10 - 10A</b> Shuttered socket CEI 23-50	<b>ITALIAN STANDARD P11 - 10A</b> Shuttered socket CEI 23-50	<b>ITALIAN STANDARD S10 - 10A</b> Plug	<b>ITALIAN STANDARD S11 - 10A</b> Plug	<b>ITALIAN STANDARD S17 - 16A</b> Plug	<b>ITALIAN STANDARD P11/P17 - 16A (bivalente)</b> Shuttered socket CEI 23-50



# Plugs and sockets

## BLUELINE Series



### ■ Plugs and trailing sockets

#### BLUELINE Series

106.

116.



Plugs with straight cable outlet

Trailing sockets with straight cable outlet

Flat plugs with 90° angled cable outlet

Poles	Current	Standard	Colour	PLUG	SOCKET	PLUG
2P	10A	Standard	White		<b>106.3010</b> 50/500 <b>106.3010/N</b> 50/500	
			Black	<b>106.3000</b> <sup>1</sup> 50/500 <b>106.3000/N</b> <sup>1</sup> 50/500		
2P+E	10A	Standard	White		<b>106.3011</b> 50/500 <b>106.3011/N</b> 50/500	
			Black	<b>106.3001</b> <sup>1</sup> 50/500 <b>106.3001/N</b> <sup>1</sup> 50/500	<b>116.68</b> <sup>1</sup> 100 <b>116.68/N</b> <sup>1</sup> 100	
2P+E	16A	Standard	White		<b>106.3013</b> 50/500 <b>106.3013/N</b> 50/500	<b>116.70</b> <sup>1</sup> 100 <b>116.70/N</b> <sup>1</sup> 100
			Black	<b>106.3003</b> <sup>1</sup> 50/500 <b>106.3003/N</b> <sup>1</sup> 50/500		

<sup>1</sup> Sleeved pin  
 - Individual packing

4.1



# Plugs and sockets

## QUICK Series

### Plugs and trailing sockets

QUICK Series

110.



Rubber housing

Thermoplastic housing

Poles	Current	Standard	Colour	CONNECTOR		PLUG		PLUG		
2P+E	13A							<b>110.3000</b> <sup>[1]</sup>	20/400	
	15A							<b>110.3010</b>	20/400	
	16A						<b>110.3100</b>	10/150		
						<b>110.3150</b>	10/150			
					<b>110.3160</b>	10/150				

[1] Fused

DOMESTIC

- 1
- 2
- 3
- 4



**BRITISH STANDARD**  
2P+E 13A  
Plug



**BRITISH STANDARD**  
2P+E 15A  
Plug



**FRENCH-GERMAN**  
STANDARD 2P+E 16A  
Plug



**GERMAN STANDARD**  
2P+E 16A  
Shuttered socket



**FRENCH STANDARD**  
2P+E 16A  
Shuttered socket



**ITALIAN STANDARD**  
P30 2P+E 16A  
Shuttered socket CEI 23-50



**PLURISTANDARD P40**  
2P+E 16A  
Shuttered socket



**GERMAN STANDARD**  
2P+E 16A  
Plug

# Plugs and sockets

## UNEL Series



### ■ Plugs and sockets with side earth contact

UNEL Series

130.



Plugs with straight cable outlet

Trailing sockets with straight cable outlet

Plugs with 90° angled cable outlet

Poles	Current	Standard	Colour	PLUG	SOCKET	PLUG			
2P+E	16A	⊕	□		🌱 <b>130.2084</b>	25/250			
			■		🌱 <b>130.2084/N</b>	25/250			
		⊕	□			<b>130.2085</b>	25/250		
			■			<b>130.2085/N</b>	25/250		
		⊕	□		🌱 <b>130.2063</b>	50/500			
			■		🌱 <b>130.2063/N</b>	50/500			
		⊕	□					🌱 <b>130.83</b>	50/500
			■					🌱 <b>130.83/N</b>	50/500
		⊕	□				<b>130.2083</b>	25/250	
			■				<b>130.2083/N</b>	25/250	

4.1



4.2

## Adaptors

- AZZURRA Series Adaptors
- BLUELINE Series Adaptors

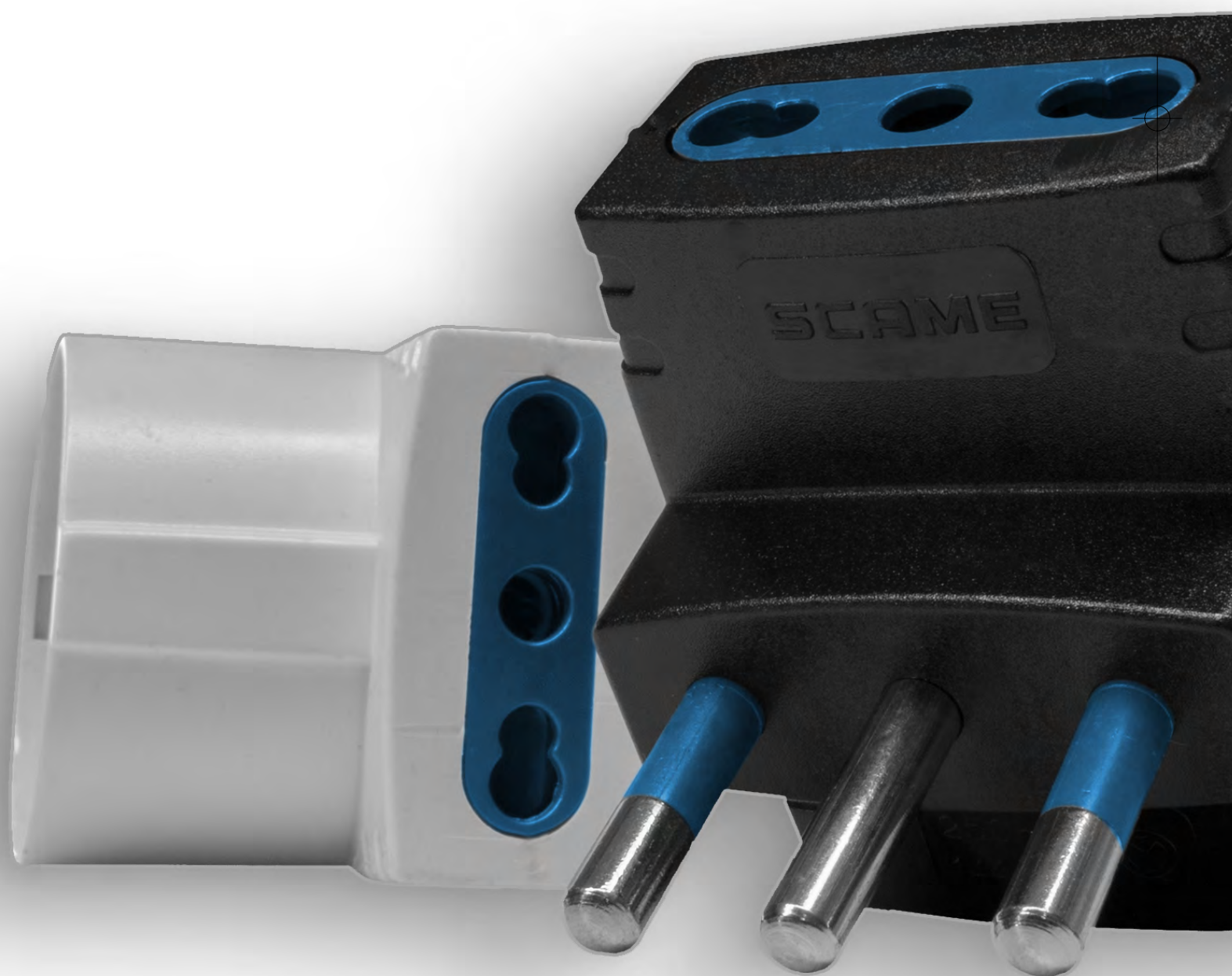



# Adaptors

## AZZURRA Series

### One-way adaptors

AZZURRA Series

144.



#### Standard P30

Poles	Current	Plug	Standard	Sockets	Colour	ONE-WAY ADAPTOR
2P+E	10A			1x2P+E-16A-(P30)		<b>144.441</b> 50
						<b>144.441/N</b> 50
	16A				<b>144.451</b> 50	
					<b>144.451/N</b> 50	

- Sleeved pin
- Individual packing

### Multi-way adaptors

AZZURRA Series

144.



#### 3-way adaptors

Poles	Current	Plug	Standard	Sockets	Colour	3-WAY ADAPTOR
2P+E	10A			3x2P+E-10A-(P11)		<b>144.455</b> 50
						<b>144.455/N</b> 50
	16A					<b>144.450</b> 25/250
						<b>144.450/N</b> 25/250

- Sleeved pin
- Individual packing



**ITALIAN STANDARD P11 - 10A**  
Shuttered socket CEI 23-50



**ITALIAN STANDARD P11/P17 - 16A (bivalente)**  
Shuttered socket CEI 23-50



**ITALIAN STANDARD P30 2P+E 16A**  
Shuttered socket CEI 23-50



**2P+E-10A-(S11)**



**2P+E-16A-(S17)**



**ITALIAN STANDARD P17 - 16A**  
Shuttered socket CEI 23-50



**PLURISTANDARD P40 2P+E 16A**  
Shuttered socket

# Adaptors

## AZZURRA Series



### Multi-way adaptors

AZZURRA Series

144.



3-way multi-standard adaptors

Poles	Current	Plug	Standard	Sockets	Colour	3-WAY ADAPTOR	
2P+E	10A			1x2P+E-16A-(P30) 2x2P+E-10A-(P11)		<b>144.457</b>	25
						<b>144.457/N</b>	25
	16A			2x2P+E-16A-(P17/11) 1x2P+T-16A-(P40)		<b>144.470</b>	25
						<b>144.470/N</b>	25
				1x2P+E-16A-(P30) 2x2P+E-16A-(P17/11)		<b>144.459</b>	25
				1x2P+E-16A-(P30) 2x2P+E-16A-(P17/11)		<b>144.459/N</b>	25

- Sleeved pin
- Individual packing

4.2



# Adaptors

## BLUELINE Series

### One-way adaptors

- 1
- 2
- 3
- 4

DOMESTIC

BLUELINE Series

146.



Side earth P30

Poles	Current	Plug	Standard	Sockets	Colour	ONE-WAY ADAPTOR
2P+E	10A			1x2P+E-16A-(P30)		<b>146.641</b> 50
	16A					<b>146.641/N</b> 50
						<b>146.651</b> 50
						<b>146.651/N</b> 50

- Sleeved pin
- Individual packing

BLUELINE Series

146.



Side earth P30 -  
Spacesaver

Poles	Current	Plug	Standard	Sockets	Colour	SPACE SAVER ADAPTER
2P+E	10A			1x2P+E-16A-(P30)		<b>146.661</b> 50
						<b>146.661/N</b> 50

- Sleeved pin
- Individual packing



**ITALIAN STANDARD**  
**P30 2P+E 16A**  
Shuttered socket CEI 23-50



**2P+E-10A-(S11)**



**2P+E-16A-(S17)**



**ITALIAN STANDARD**  
**P11/P17 - 16A**  
**(bivalente)**  
Shuttered socket CEI 23-50



**2P+E-16A-(FRENCH)**



# Adaptors

## BLUELINE Series



### ■ One-way adaptors

BLUELINE Series

146.



Aligned poles

Poles	Current	Plug	Standard	Sockets	Colour	ONE-WAY ADAPTOR
2P+E	16A			1x2P+E-16A-(P17/11)		<b>146.351</b> 50/500
						<b>146.351/N</b> 50/500

- Sleeved pin
- Individual packing

BLUELINE Series

146.



French-german standard

Poles	Current	Plug	Standard	Sockets	Colour	ONE-WAY ADAPTOR
2P+E	16A			1x2P+E-16A-(P17/11)		<b>146.361</b> 50
						<b>146.361/N</b> 50

- Individual packing

4.2



# Adaptors

## BLUELINE Series

### Multi-way adaptors

1  
2  
3  
4

DOMESTIC

BLUELINE Series

146.



### 3-way adaptors

Poles	Current	Plug	Standard	Sockets	Colour	3-WAY ADAPTOR	
2P+E	10A			3x2P+E-10A-(P11)			<b>146.555/3</b> 50
							<b>146.555/3-N</b> 50
2P+E	16A			3x2P+E-16A-(P17/11)			<b>146.550/3</b> 25/250
							<b>146.550/3-N</b> 25/250

- Sleeved pin
- Individual packing

BLUELINE Series

146.



### 3-way multi-standard adaptors

Poles	Current	Plug	Standard	Sockets	Colour	3-WAY ADAPTOR	
2P+E	10A			1x2P+E-16A-(P30) 2x2P+E-10A-(P11)			<b>146.557</b> 25
							<b>146.557/N</b> 25
2P+E	16A			1x2P+E-16A-(P30) 2x2P+E-16A-(P17/11)			<b>146.559</b> 25
							<b>146.559/N</b> 25
				2x2P+E-16A-(P17/11) 1x2P+T-16A-(P40)			<b>146.570</b> 25
							<b>146.570/N</b> 25

- Sleeved pin
- Individual packing



**ITALIAN STANDARD P11 - 10A**  
Shuttered socket CEI 23-50



**ITALIAN STANDARD P11/P17 - 16A (bivalente)**  
Shuttered socket CEI 23-50



**ITALIAN STANDARD P30 2P+E 16A**  
Shuttered socket CEI 23-50



**PLURISTANDARD P40 2P+E 16A**  
Shuttered socket



**2P+E-10A-(S11)**



**2P+E-16A-(S17)**



**ITALIAN STANDARD P17 - 16A**  
Shuttered socket CEI 23-50

# Adaptors

## BLUELINE Series



### Multi-way adaptors

BLUELINE Series

146.



3-way multi-standard adaptors (space saver)

Poles	Current	Plug	Standard	Sockets	Colour	SPACE SAVER ADAPTER
2P+E	10A			1x2P+E-16A-(P30) 2x2P+E-10A-(P11)		<b>146.560</b> 25
						<b>146.560/N</b> 25
2P+E	16A			1x2P+E-16A-(P30) 2x2P+E-16A-(P17/11)		<b>146.561</b> 25
						<b>146.561/N</b> 25

- Sleeved pin
- Individual packing

BLUELINE Series

146.



4-way adaptors

Poles	Current	Plug	Standard	Sockets	Colour	4-WAY ADAPTOR
2P+E	10A			4x2P+E-10A-(P11)		<b>146.534</b> 25/250
						<b>146.534/N</b> 25/250
2P+E	16A			4x2P+E-16A-(P17/11)		<b>146.530</b> 25/250
						<b>146.530/N</b> 25/250

- Sleeved pin
- Individual packing

4.2



# Adaptors

## BLUELINE Series

### Multi-way adaptors

1  
2  
3  
4

DOMESTIC

BLUELINE Series

146.



2-way adaptors with luminous indicator

Poles	Current	Plug	Standard	Sockets	Colour	2-WAY ADAPTOR
2P+E	10A			2x2P+E-10A-(P11)		<b>146.500</b> 25/250
	16A			2x2P+E-16A-(P17/11)		<b>146.501</b> 25/250

- Sleeved pin
- Individual packing

BLUELINE Series

146.



2-way adaptors with USB

Poles	Current	Plug	Standard	Sockets	Colour	USB ADAPTOR
2P+E	10A			2x2P+E-10A-(P11)		<b>146.510</b> 10
						<b>146.510/N</b> 10
	16A			2x2P+E-16A-(P17/11)		<b>146.511</b> 10
						<b>146.511/N</b> 10

- USB socket (Universal Serial Bus) for power supply of electronic devices (1,2A max)



**ITALIAN STANDARD P11 - 10A**  
Shuttered socket CEI 23-50



**ITALIAN STANDARD P17 - 16A**  
Shuttered socket CEI 23-50



**ITALIAN STANDARD P11/P17 - 16A (bivalente)**  
Shuttered socket CEI 23-50



**2P+E-10A-(S11)**



**2P+E-16A-(S17)**



**USB**  
USB (Universal Serial Bus)



**Lighting protection**  
With special device to protect against voltage overload in the electrical supply.

# Adaptors

## BLUELINE Series



### Adaptors

BLUELINE Series - Lighting pr.

146.



**Lightning protection**

Poles	Current	Plug	Standard	Sockets	Colour	LIGHTNING PROTECTION	
2P+E	10A			1x2P+E-10A-(P11)		<b>146.360</b>	12/48

With lightning protection

- Sleeved pin
- Individual packing

4.2



4.3

## Multi sockets

- TREND Series  
Multi sockets
- BLUELINE Series  
Multi sockets
- SICURA Series  
Multi sockets
- Serie SPYROS  
Extension cords for domestic  
applications



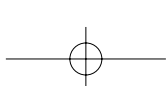
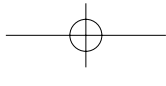

## Multi sockets TREND Series

### Multi sockets

TREND Series

165.



With cable and plug -  
Without luminous switch

Current	Plug	Standard	no.	Sockets	Cable section	Max power	Colour	MULTI SOCKET
16A			3	1x2P+E-16A-(P30) 2x2P+E-16A-(P17/11)	1mm <sup>2</sup>	MAX 3.600W		<b>165.10401.N</b> 10
								<b>165.10401.R</b> 10
			6	2x2P+E-16A-(P30) 4x2P+E-16A-(P17/11)				<b>165.20401.N</b> 10
								<b>165.20401.R</b> 10
			9	3x2P+E-16A-(P30) 6x2P+E-16A-(P17/11)				<b>165.30401.N</b> 10
								<b>165.30401.R</b> 10

With 1,5m H05VV-F (PVC) cable and plug

TREND Series

165.



With cable and plug -  
With luminous switch

Current	Plug	Standard	no.	Sockets	Cable section	Max power	Colour	MULTI SOCKET
16A			12	4x2P+E-16A-(P30) 8x2P+E-16A-(P17/11)	1mm <sup>2</sup>	MAX 3.600W		<b>165.40411.N</b> 10
								<b>165.40411.R</b> 10
			6	2x2P+E-16A-(P30) 4x2P+E-16A-(P17/11)				<b>165.20411.N</b> 10
								<b>165.20411.R</b> 10
			9	3x2P+E-16A-(P30) 6x2P+E-16A-(P17/11)				<b>165.30411.N</b> 10
								<b>165.30411.R</b> 10

With 1,5m H05VV-F (PVC) cable and plug



ITALIAN STANDARD  
P11/P17 - 16A  
(bivalente)  
Shuttered socket CEI 23-50



ITALIAN STANDARD  
P30 2P+E 16A  
Shuttered socket CEI 23-50



2P+E-16A-(S17)



2P+E-10A-(S11)



# Multi sockets

## TREND Series



### Multi sockets

TREND Series

165.



With cable and plug -  
With luminous switch  
[SAFETY SWITCH]

Current	Plug	Standard	no.	Sockets	Cable section	Max power	Colour	MULTI SOCKET	
10A			6	2x2P+E-16A-(P30) 4x2P+E-16A-(P17/11)	0,75mm <sup>2</sup>	MAX 2.300W		<b>165.20441.N</b>	10
								<b>165.20441.R</b>	10

With 1,5m H05VV-F (PVC) cable and plug

- SAFETY-SWITCH: Luminous switch with overload protection device



APPLICATION EXAMPLE

4.3



# Multi sockets

## TREND Series

### Multi sockets

TREND Series

165.



**With lightning protection - With luminous switch**

- 1
- 2
- 3
- 4

DOMESTIC

Current	Plug	Standard no.	Sockets	Cable section	Max power	Colour	MULTI SOCKET
16A		6	2x2P+E-16A-(P30) 4x2P+E-16A-(P17/11)	1mm <sup>2</sup>	MAX 3.600W		<b>165.20421.T</b> 10
		9	3x2P+E-16A-(P30) 6x2P+E-16A-(P17/11)				<b>165.30421.T</b> 10

- With 1,5m H05V-F (PVC) cable and plug
- Transparent case



**TREND Series**  
Multi-outlet socket with lightning protection



**ITALIAN STANDARD P11/P17 - 16A (bivalente)**  
Shuttered socket CEI 23-50



**ITALIAN STANDARD P30 2P+E 16A**  
Shuttered socket CEI 23-50



**2P+E-16A-(S17)**



**Lighting protection**  
With special device to protect against voltage overload in the electrical supply.



**2P+E-16A-(GERMAN)**



**USB**  
USB (Universal Serial Bus)

# Multi sockets

## TREND Series



### Multi sockets

TREND Series

165.



USB socket - With luminous switch

Current	Plug	Standard	Sockets	Cable section	Max power	Colour	MULTI SOCKET WITH USB
16A			1x2P+E-16A-(P30) 2x2P+E-16A-(P17/11)	1mm <sup>2</sup>	MAX 3.600W		<b>165.20431.N</b> 10
							<b>165.20431.R</b> 10
							<b>165.20431.ND</b> 10
							<b>165.20431.RD</b> 10

With 1,5m H05VV-F (PVC) cable and plug

- USB socket (Universal Serial Bus) for power supply of electronic devices (1,2A max)

4.3



# Multi sockets

## BLUELINE Series

### Multi sockets

BLUELINE Series - Lighting pr.

160.



**With lightning protection - With luminous switch**

DOMESTIC

Current	Plug	Standard	no.	Sockets	Cable section	Max power	Colour	MULTI SOCKET
10A			6	6x2P+E-10A-(P11)	1mm <sup>2</sup>	MAX 2.300W		<b>160.237/C</b> 10
								<b>160.237/C-F</b> <sup>1</sup> 10
								<b>160.237/C-T</b> <sup>1</sup> 10
								<b>160.232/C</b> 10
								<b>160.232/C-F</b> <sup>1</sup> 10
								<b>160.232/C-T</b> <sup>1</sup> 10
			6	6x2P+E-16A-(P17/11)	1mm <sup>2</sup>	MAX 2.300W		<b>160.233/C</b> 10
								<b>160.233/C-F</b> <sup>1</sup> 10
								<b>160.233/C-T</b> <sup>1</sup> 10
								<b>160.240/C</b> 10
								<b>160.240/C-F</b> <sup>1</sup> 10
								<b>160.240/C-T</b> <sup>1</sup> 10
16A			6	3x2P+E-16A-(P17/11) 3x2P+E-16A-(P30)	1mm <sup>2</sup>	MAX 3.600W		<b>160.233/D</b> 10
								<b>160.233/D-F</b> <sup>1</sup> 10
								<b>160.233/D-T</b> <sup>1</sup> 10
								<b>160.243/D</b> 10
								<b>160.243/D-F</b> 10
								<b>160.243/D-T</b> 10
			4	4x2P+E-16A-(P30)	1mm <sup>2</sup>	MAX 3.600W		<b>160.249/C</b> 10
								<b>160.249/C-F</b> <sup>1</sup> 10
								<b>160.249/C-T</b> <sup>1</sup> 10
								<b>160.243/D</b> 10
								<b>160.243/D-F</b> 10
								<b>160.243/D-T</b> 10

With 1,5m H05W-F (PVC) cable and plug

With luminous switch

With lightning protection

Transparent case



**ITALIAN STANDARD  
P11 - 10A**  
Shuttered socket CEI 23-50



**ITALIAN STANDARD  
P11/P17 - 16A  
(bivalente)**  
Shuttered socket CEI 23-50



**ITALIAN STANDARD  
P30 2P+E 16A**  
Shuttered socket CEI 23-50



**GERMAN STANDARD  
2P+E 16A**  
Shuttered socket



**FRENCH STANDARD  
2P+E 16A**  
Shuttered socket



**2P+E-10A-(S11)**



**2P+E-16A-(S17)**



**2P+E-16A-(GERMAN)**

# Multi sockets

## BLUELINE Series



### Multi sockets

BLUELINE Series

160.



With cable and plug -  
With luminous switch

Current	Plug	Standard	no.	Sockets	Cable section	Max power	Colour	MULTI SOCKET
10A	☰	⋮	6	6x2P+E-10A-(P11)	0,75mm <sup>2</sup>	MAX 2.300W	White	160.250/C 10
				Black			160.250/C-N 10	
				White			160.229/C 10	
				Black			160.229/C-N 10	
				Grey			160.229/C-F <sup>1</sup> 10	
				Blue			160.229/C-T <sup>1</sup> 10	
	☰	⋮	6	3x2P+E-16A-(P17/11) 3x2P+E-16A-(P30)	1mm <sup>2</sup>	MAX 3.600W	White	160.230/C 10
				Black			160.230/C-N 10	
				Grey			160.230/C-F <sup>1</sup> 10	
				Blue			160.230/C-T <sup>1</sup> 10	
				White			160.239/C 10	
				Black			160.239/C-N 10	
16A	☰	⋮	6	3x2P+E-16A-(P17/11) 3x2P+E-16A-(P30)	1mm <sup>2</sup>	MAX 3.600W	White	160.239/C 10
				Black			160.239/C-N 10	
				Grey			160.239/C-F <sup>1</sup> 10	
				Blue			160.239/C-T <sup>1</sup> 10	
				White			160.230/D 10	
				Black			160.230/D-N 10	
	☰	⋮	6	4x2P+E-16A-(P30)	1mm <sup>2</sup>	MAX 3.600W	White	160.239/D 10
				Black			160.239/D-N 10	
				Grey			160.239/D-F <sup>1</sup> 10	
				Blue			160.239/D-T <sup>1</sup> 10	
				White			160.242/C 10	
				Black			160.242/C-N 10	
☰	⋮	6	4x2P+E-16A-(GERMAN)	1mm <sup>2</sup>	MAX 3.600W	White	160.242/C-F 10	
			Black			160.242/C-T 10		
			White			160.248/C 10		
			Black			160.248/C-N 10		
			Grey			160.248/C-F <sup>1</sup> 10		
			Blue			160.248/C-T <sup>1</sup> 10		

☰ With 1,5m H05VV-F (PVC) cable and plug

☰ With luminous switch

<sup>1</sup> Transparent case



2P+E-16A-(FRENCH)



**Lighting protection**

With special device to protect against voltage overload in the electrical supply.

4.3



# Multi sockets

## BLUELINE Series

### Multi sockets

BLUELINE Series

160.



Without cable and plug -  
With luminous switch

- 1
- 2
- 3
- 4

DOMESTIC

Current	Standard	no.	Sockets	Max power	Colour	MULTI SOCKET		
16A		6x2P+E-16A-(P17/11)	6		MAX 3.600W		<b>160.229</b> 10/100	
							<b>160.229/N</b> 10/100	
							<b>160.229/F</b> <sup>1</sup> 10/100	
							<b>160.229/T</b> <sup>1</sup> 10/100	
							<b>160.230</b> 10/40	
							<b>160.230/N</b> 10/40	
		3x2P+E-16A-(P17/11) 3x2P+E-16A-(P30)			MAX 3.600W	MAX 3.600W		<b>160.230/F</b> <sup>1</sup> 10/40
								<b>160.230/T</b> <sup>1</sup> 10/40
								<b>160.239</b> 10/50
								<b>160.239/N</b> 10/50
								<b>160.239/F</b> <sup>1</sup> 10/50
								<b>160.239/T</b> <sup>1</sup> 10/50
	4x2P+E-16A-(P30)			MAX 3.600W	MAX 3.600W		<b>160.242</b> 10/50	
							<b>160.242/N</b> 10/50	
							<b>160.242/F</b> 10/50	
							<b>160.242/T</b> 10/50	
							<b>160.248</b> 10/50	
							<b>160.248/N</b> 10/50	
	4x2P+E-16A-(GERMAN)			MAX 3.600W	MAX 3.600W		<b>160.248/F</b> <sup>1</sup> 10/50	
							<b>160.248/T</b> <sup>1</sup> 10/50	
							<b>160.248</b> 10/50	
							<b>160.248/N</b> 10/50	
							<b>160.248/F</b> <sup>1</sup> 10/50	
							<b>160.248/T</b> <sup>1</sup> 10/50	

With luminous switch

Transparent case



**ITALIAN STANDARD**  
**P11/P17 - 16A**  
**(bivalente)**  
Shuttered socket CEI 23-50



**ITALIAN STANDARD**  
**P30 2P+E 16A**  
Shuttered socket CEI 23-50



**GERMAN STANDARD**  
**2P+E 16A**  
Shuttered socket



**FRENCH STANDARD**  
**2P+E 16A**  
Shuttered socket



**ITALIAN STANDARD**  
**P11 - 10A**  
Shuttered socket CEI 23-50



**2P+E-10A-(S11)**



**2P+E-16A-(S17)**

# Multi sockets BLUELINE Series



## Multi sockets

BLUELINE Series

160.



With cable and plug -  
Without luminous switch  
(Italian plug)

Current	Plug	Standard	no.	Sockets	Cable section	Max power	Colour	MULTI SOCKET
10A			4	4x2P+E-10A-(P11)	0,75mm <sup>2</sup>	MAX 2.300W		160.219/C 10
								160.219/C-N 10
								160.219/C-F <sup>1</sup> 10
								160.219/C-T <sup>1</sup> 10
								160.224/C 10
								160.224/C-N 10
				160.224/C-F <sup>1</sup> 10				
				160.224/C-T <sup>1</sup> 10				
				160.220/C 10				
				160.220/C-N 10				
				160.220/C-F <sup>1</sup> 10				
				160.220/C-T <sup>1</sup> 10				
16A			3	3x2P+E-16A-(P17/11)	1mm <sup>2</sup>	MAX 3.600W		160.223/C 10
								160.223/C-N 10
								160.223/C-F <sup>1</sup> 10
								160.223/C-T <sup>1</sup> 10
								160.225/C 10
								160.225/C-N 10
				160.225/C-F <sup>1</sup> 10				
				160.225/C-T <sup>1</sup> 10				
				160.231/C 10				
				160.231/C-N 10				
				160.231/C-F <sup>1</sup> 10				
				160.231/C-T <sup>1</sup> 10				
	160.238/C 10							
	160.238/C-N 10							
	160.238/C-F <sup>1</sup> 10							
	160.238/C-T <sup>1</sup> 10							

With 1,5m H05VV-F (PVC) cable and plug

<sup>1</sup> Transparent case

4.3



# Multi sockets

## BLUELINE Series

### Multi sockets

BLUELINE Series

160.



With cable and plug -  
Without luminous switch  
(European plug)

1  
2  
3  
4

DOMESTIC

Current	Plug	Standard	no.	Sockets	Cable section	Max power	Colour	MULTI SOCKET
16A			4	4x2P+E-16A-(P30)	1mm <sup>2</sup>	MAX 3.600W		<b>160.238/D</b> 10
								<b>160.238/D-N</b> 10
								<b>160.238/D-F</b> <sup>1</sup> 10
								<b>160.238/D-T</b> <sup>1</sup> 10
			4	4x2P+E-16A-(GERMAN)	1mm <sup>2</sup>			<b>160.241/C</b> 10
								<b>160.241/C-N</b> 10
								<b>160.241/C-F</b> 10
								<b>160.241/C-T</b> 10
								<b>160.247/C</b> 10
								<b>160.247/C-N</b> 10
								<b>160.247/C-F</b> <sup>1</sup> 10
								<b>160.247/C-T</b> <sup>1</sup> 10
		4	4x2P+E-16A-(FRENCH)	1mm <sup>2</sup>		<b>160.247/C</b> 10		
						<b>160.247/C-N</b> 10		
						<b>160.247/C-F</b> <sup>1</sup> 10		
						<b>160.247/C-T</b> <sup>1</sup> 10		

With 1,5m H05VV-F (PVC) cable and plug

<sup>1</sup> Transparent case



**ITALIAN STANDARD**  
**P30 2P+E 16A**  
Shuttered socket CEI 23-50



**GERMAN STANDARD**  
**2P+E 16A**  
Shuttered socket



**FRENCH STANDARD**  
**2P+E 16A**  
Shuttered socket



**2P+E-16A-(GERMAN)**



**2P+E-16A-(FRENCH)**



**ITALIAN STANDARD**  
**P11 - 10A**  
Shuttered socket CEI 23-50



**ITALIAN STANDARD**  
**P11/P17 - 16A**  
**(bivalente)**  
Shuttered socket CEI 23-50



# Multi sockets BLUELINE Series



## Multi sockets

BLUELINE Series

160.



Without cable and plug -  
Without luminous switch

Current	Standard	no.	Sockets	Max power	Colour	MULTI SOCKET
10A	I	4	4x2P+E-10A-(P11)	MAX 2.300W		<b>160.219</b> 10/100
						<b>160.219/N</b> 10/100
						<b>160.219/F</b> <sup>1</sup> 10/100
			<b>160.219/T</b> <sup>1</sup> 10/100			
			<b>160.224</b> 10/120			
			<b>160.224/N</b> 10/120			
	6	I	6x2P+E-10A-(P11)			<b>160.224/F</b> <sup>1</sup> 10/120
						<b>160.224/T</b> <sup>1</sup> 10/120
						<b>160.220</b> 10/100
					<b>160.220/N</b> 10/100	
					<b>160.220/F</b> <sup>1</sup> 10/100	
					<b>160.220/T</b> <sup>1</sup> 10/100	
16A	I	3	3x2P+E-16A-(P17/11)	MAX 3.600W		<b>160.223</b> 10/100
						<b>160.223/N</b> 10/100
						<b>160.223/F</b> <sup>1</sup> 10/100
			<b>160.223/T</b> <sup>1</sup> 10/100			
			<b>160.225</b> 10/120			
			<b>160.225/N</b> 10/120			
	6	I	4x2P+E-16A-(P17/11)			<b>160.225/F</b> <sup>1</sup> 10/120
						<b>160.225/T</b> <sup>1</sup> 10/120
						<b>160.231</b> 10/40
					<b>160.231/N</b> 10/40	
					<b>160.231/F</b> <sup>1</sup> 10/40	
					<b>160.231/T</b> <sup>1</sup> 10/40	
	I	4x2P+E-16A-(P30)			<b>160.238</b> 10/50	
					<b>160.238/N</b> 10/50	
					<b>160.238/F</b> <sup>1</sup> 10/50	
				<b>160.238/T</b> <sup>1</sup> 10/50		
				<b>160.241</b> 10/50		
				<b>160.241/N</b> 10/50		
I	4	4x2P+E-16A-(GERMAN)			<b>160.241/F</b> 10/50	
					<b>160.241/T</b> 10/50	
					<b>160.247</b> 10/50	
		<b>160.247/N</b> 10/50				
		<b>160.247/F</b> <sup>1</sup> 10/50				
		<b>160.247/T</b> <sup>1</sup> 10/50				

<sup>1</sup> Transparent case

4.3



## Multi sockets BLUELINE Series

### Multi sockets

BLUELINE Series

160.



Desk multi sockets

Current	Plug	Standard	no.	Sockets	Max power	Colour	MULTI SOCKET FOR DESK
16A			3	1x2P+E-16A-(P30) 2x2P+E-16A-(P17/11)	MAX 3.600W		<b>160.5013</b> 6/24
							<b>160.5014</b> 6/24

With 2m H05VV-F (PVC) 3x1mm<sup>2</sup> cable and plug 16A 2P+E

With luminous switch

BLUELINE Series

160.



Description	Colour	Support kit
MULTI SOCKET SUPPORT KIT		<b>160.001</b> 10/100



**ITALIAN STANDARD  
P11/P17 - 16A  
(bivalente)**  
Shuttered socket CEI 23-50



**ITALIAN STANDARD  
P30 2P+E 16A**  
Shuttered socket CEI 23-50



**2P+E-16A-(S17)**



**PLURISTANDARD P40  
2P+E 16A**  
Shuttered socket



**Lighting protection**  
With special device to protect  
against voltage overload in the  
electrical supply.

# Multi sockets

## SICURA Series



### Multi sockets

SICURA Series

161.



**With lightning protection - With luminous switch**

Current	Plug	Standard	no.	Sockets	Max power	Colour	MULTI SOCKET	
16A			4	4x2P+E-16A-(P40)	MAX 3.600W		<b>161.246/C-F</b>	10
							<b>161.246/C-T</b>	10

- With 1,5m H05VV-F (PVC) cable and plug
- With luminous switch
- With lightning protection
- Transparent case

SICURA Series

161.



**With cable and plug - With luminous switch**

Current	Plug	Standard	no.	Sockets	Max power	Colour	MULTI SOCKET	
16A			10	4x2P+E-16A-(P17/11) 6x2P+T-16A-(P40)	MAX 3.600W		<b>161.60511.N</b>	10
							<b>161.60511.R</b>	10
							<b>161.40511.N</b>	10
			<b>161.40511.F<sup>1</sup></b>	10				
			<b>161.40511.T<sup>1</sup></b>	10				
			<b>161.40511.R</b>	10				
			4	4x2P+E-16A-(P40)				

- With 1,5m H05VV-F (PVC) cable and plug
- With luminous switch
- <sup>1</sup> Transparent case

4.3



# Multi sockets

## SICURA Series

### Multi sockets

SICURA Series

161.



With cable and plug -  
Without luminous switch

1  
2  
3  
4

DOMESTIC

Current	Plug	Standard	no.	Sockets	Max power	Colour	MULTI SOCKET
16A			10	4x2P+E-16A-(P17/11) 6x2P+T-16A-(P40)	MAX 3.600W		<b>161.60501.N</b> 10
							<b>161.60501.R</b> 10
			4	4x2P+E-16A-(P40)			<b>161.40501.N</b> 10
							<b>161.40501.F</b> <sup>1</sup> 10
						<b>161.40501.T</b> <sup>1</sup> 10	
							<b>161.40501.R</b> 10

With 1,5m H05VV-F (PVC) cable and plug

<sup>1</sup> Transparent case



ITALIAN STANDARD  
P11/P17 - 16A  
(bivalente)  
Shuttered socket CEI 23-50



PLURISTANDARD P40  
2P+E 16A  
Shuttered socket



2P+E-16A-(S17)

# Multi sockets

## SICURA Series



### Multi sockets

SICURA Series

161.



Without cable and plug -  
With luminous switch

Current	Standard	no.	Sockets	Max power	Colour	MULTI SOCKET	
16A		10	4x2P+E-16A-(P17/11) 6x2P+T-16A-(P40)	MAX 3.600W		<b>161.60510.N</b>	10
						<b>161.60510.R</b>	10
		4	4x2P+E-16A-(P40)			<b>161.40510.N</b>	10
						<b>161.40510.F</b> <sup>1</sup>	10
						<b>161.40510.T</b> <sup>1</sup>	10
						<b>161.40510.R</b>	10

<sup>+</sup> With luminous switch

<sup>1</sup> Transparent case



APPLICATION EXAMPLE

4.3



# Multi sockets

## SICURA Series

### Multi sockets

SICURA Series









161.



Without cable and plug -  
Without luminous switch

1  
2  
3  
4

DOMESTIC

Current	Standard	no.	Sockets	Max power	Colour	MULTI SOCKET
16A		10	4x2P+E-16A-(P17/11) 6x2P+T-16A-(P40)	MAX 3.600W		<b>161.60500.N</b> 10
						<b>161.60500.R</b> 10
						<b>161.40500.N</b> 10
		<b>161.40500.F</b> <sup>1</sup> 10				
		<b>161.40500.T</b> <sup>1</sup> 10				
		<b>161.40500.R</b> 10				
		4	4x2P+E-16A-(P40)			

<sup>1</sup> Transparent case



#### Random colour

Random colour (.R) means casual "white base - grey lid" or "grey base - white lid".



**ITALIAN STANDARD**  
P11/P17 - 16A  
(bivalente)  
Shuttered socket CEI 23-50



**PLURISTANDARD P40**  
2P+E 16A  
Shuttered socket

# Multi sockets

## Serie SPYROS



### Extension cords for domestic applications

SPYROS Series

168.



Description	Cable length	Cable section	Colour	Without plug and connector	With plug and connector 2P+E 10A	
EXTENSION CORD	3m	0,75mm <sup>2</sup>		<b>168.0072B-03</b> 10	<b>168.4272B-03</b> 10	
				<b>168.0072N-03</b> 10	<b>168.4272N-03</b> 10	
		1mm <sup>2</sup>		<b>168.0073B-03</b> 10	<b>168.4273B-03</b> 10	
				<b>168.0073N-03</b> 10	<b>168.4273N-03</b> 10	
			5m		<b>168.0073B-05</b> 10	<b>168.4273B-05</b> 10
					<b>168.0073N-05</b> 10	<b>168.4273N-05</b> 10

4.3





## 4.4

### Cable reels

- TRIS (ENERGY) Series  
Cable reels - Low voltage versions  
with thermal switch
- TRIS Series (TV)  
Cable reels - TV versions
- TRIS (TEL) Series  
Cable reels - Telephone versions







## Cable reels

### TRIS (ENERGY) Series

#### ■ Cable reels - Low voltage versions with thermal switch

1  
2  
3  
4

DOMESTIC

Plug	Standard	no.	Sockets	Cable	Cable section	Cable length	@	
☰	⋮	2	2x2P+E-10A-(P11)	H05W-F	1mm <sup>2</sup>	5m	1200W	
						10m	1100W	
						4m	1700W	
	⋮	2	2x2P+E-16A-(P17/11)			10m		
						15m		
						20m		
☰	⋮ ☰	3	1x2P+E-16A-(P30) 2x2P+E-16A-(P17/11)	5m				
				10m				
	☰	3	1x2P+E-16A-(P30) 2x2P+E-16A-(P17/11)	15m				
				20m				
				☰	4	4x2P+E-16A-(P30)	10m	1200W
							20m	
				☰	4	4x2P+E-16A-(GERMAN)	10m	
							20m	
☰	4	4x2P+E-16A-(FRENCH)	10m					
			20m					
☰	⋮	2	2x2P-10A-(P10)	H05W-F	1mm <sup>2</sup>	5m		
						10m		
						15m	1100W	

- After use rewind the cable carefully back into the reel.
- With thermal overload switch.
- The maximum power supply is shown on every single item.



#### Thermal overload switch

A bimetallic device is put in close contact with the supply cable and protects it from excessive overheating resulting from the Joule effect. If activated, the device opens the circuit to the socket, interrupting the supply of electrical energy. Reactivation is only possible manually and if the temperature is below intervention threshold.

**Warning:** The thermal overload switch is not an isolator switch, therefore maintenance operations are carried out after having disconnected the circuit. The thermal overload switch does not protect.

<b>ITALIAN STANDARD</b> <b>P10 - 10A</b> Shuttered socket CEI 23-50	<b>ITALIAN STANDARD</b> <b>P11 - 10A</b> Shuttered socket CEI 23-50	<b>ITALIAN STANDARD</b> <b>P11/P17 - 16A</b> <b>(bivalente)</b> Shuttered socket CEI 23-50	<b>ITALIAN STANDARD</b> <b>P30 2P+E 16A</b> Shuttered socket CEI 23-50	<b>GERMAN STANDARD</b> <b>2P+E 16A</b> Shuttered socket	<b>FRENCH STANDARD</b> <b>2P+E 16A</b> Shuttered socket	<b>2P+E-10A-(S11)</b>	<b>2P+E-16A-(S17)</b>

# Cable reels

## TRIS (ENERGY) Series



### TRIS Series

709.



TRIS 150 Series



TRIS 190 Series



TRIS 230 Series

	Volt	Colour	DOMESTIC CABLE REEL				
2200W			709.2505	1/12			
2300W			709.2605	1/12			
2850W							
	250V	■			709.3510	1/6	
						709.3610	1/6
						709.3705	1/6
						709.3710	1/6
						709.3810	1/6
						709.3910	1/6
						709.4615	1/6
						709.4620	1/6
						709.4715	1/6
						709.4720	1/6
				709.4820	1/6		
				709.4320	1/6		
				709.4920	1/6		
				709.4420	1/6		
2200W			709.2405	1/12			
2300W			709.3410	1/6			
			709.3415	1/6			

4.4



2P-10A-(S10)



Wound cable power



Unwound cable power

## Cable reels TRIS Series (TV)

### ■ Cable reels - TV versions

TRIS Series

707.



TRIS 130 Series



TRIS 150 Series

Plug	no.	Sockets	Cable	Cable length	Colour	DOMESTIC CABLE REEL			
TV Ø9,5	1	1xTV	COAXIAL	5m		<b>707.1105</b>	1/12		
				10m				<b>707.2110</b>	1/12
				15m				<b>707.2115</b>	1/12

- Rewind the cable completely after use.



#### Outlet to outlet connector - Plug to plug connector

Coaxial cable connectors are available, as well as "outlet to outlet connector" and "plug to plug connector" for old adaptors and TV installations and ew TV installations according to CEI EN 50083.



#### TRIS Series

Cable reel for TV socket IEC connector, diameter 9.5mm for coaxial cable.

# Cable reels

## TRIS (TEL) Series



### ■ Cable reels - Telephone versions

TRIS Series

707.



TRIS 130 Series



TRIS 150 Series

Plug	no.	Sockets	Cable	Cable length	Colour	DOMESTIC CABLE REEL	
						Part No.	Quantity
TELEPHONE 3P	2	1xTEL. 1xPLUG	TELEPHONE 3P	5m	■	<b>707.1205</b>	1/12
				10m		<b>707.1210</b>	1/12
				15m		<b>707.1215</b>	1/12
				20m		<b>707.2220</b>	1/12

- Cable reels are provided with a 6/4 plug and line duplicator.
- Rewind the cable completely after use.



**Plug**  
The telephone cable reels of the TRIS Series are provided with a 6/4 plug and a line duplicator.



**TRIS Series**  
Plug to plug connector

4.4





4.5

## Lampholders and switches

- LUX [Lampholders] Series  
Lampholders
- LUX [switches] Series  
Single pole switches
- LUX [celing] Series  
Ceiling accessories



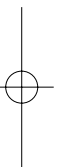
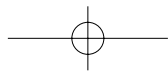

# Lampholders and switches

## LUX [Lampholders] Series

■ For incandescent lamps

LUX Series

190.



1

2

3

4

DOMESTIC

Description	Lamp holder	Dimension	Fixing	Colour	Plastic candles
CANDLE DRIP COVER	E14	h65mm			<b>190.CP70B</b> 50/300
					<b>190.CP70A</b> 50/300
h85mm				<b>190.CP85B</b> 50/300	
				<b>190.CP85A</b> 50/300	
CANDLE LAMPHOLDER	h65mm	2 PARTS HIGHER			<b>190.3570S</b> <sup>[1]</sup> 50/500
					<b>190.3570ES</b> <sup>[1]</sup> 50/500
	h85mm	2 PARTS HIGHER			<b>190.3585S</b> <sup>[1]</sup> 50/500
					<b>190.3585ES</b> <sup>[1]</sup> 50/500

[1] Metal bracket.

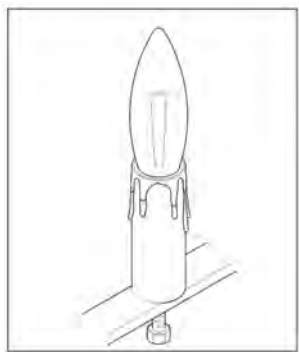

**LUX Series**  
Fixing thread: M10x1mm



# Lampholders and switches

## LUX [Lampholders] Series



■ For incandescent lamps

LUX Series

190.



Description	Lamp holder	Cap	Colour	Lampholders - Skirt smooth
LAMPHOLDER	E14	THREADED METAL ENTRY		<b>190.2000LNB</b> 100/600
				<b>190.2000LN</b> 100/600
		THREADED PLASTIC ENTRY		<b>190.2000LGB</b> 100/600
				<b>190.2000LG</b> 100/600
		THREADED METAL ENTRY AND EARTH		<b>190.2000LTB</b> 100/600
				<b>190.2000LT</b> 100/600
	E27	THREADED METAL ENTRY		<b>190.6000LNB</b> 50/300
				<b>190.6000LN</b> 50/300
		THREADED PLASTIC ENTRY		<b>190.6000LGB</b> 50/300
				<b>190.6000LG</b> 50/300
		THREADED METAL ENTRY AND EARTH		<b>190.6000LTB</b> 50/300
				<b>190.6000LT</b> 50/300

- Cable 2.5mm<sup>2</sup> (max).
- Entry: M10 x 1.

4.5



## Lampholders and switches

### LUX [Lampholders] Series

■ For incandescent lamps

LUX Series

190.



1  
2  
3  
4

DOMESTIC

Description	Lamp holder	Cap	Colour	Lampholders - Skirt threaded
LAMPHOLDER	E14	THREADED METAL ENTRY		<b>190.2000FNB</b> 100/600
				<b>190.2000FN</b> 100/600
		THREADED PLASTIC ENTRY		<b>190.2000FGB</b> 100/600
				<b>190.2000FG</b> 100/600
				<b>190.2000FGO</b> 100/600
				<b>190.6000FNB</b> 50/300
	E27	THREADED METAL ENTRY		<b>190.6000FN</b> 50/300
				<b>190.6000FGB</b> 50/300
		THREADED PLASTIC ENTRY		<b>190.6000FG</b> 50/300
				<b>190.6000FGO</b> 50/300
				<b>190.6000FTB</b> 50/300
				<b>190.6000FT</b> 50/300

- Cable 2.5mm<sup>2</sup> (max).
- Entry: M10 x 1.

LUX Series

190.



Description	Lamp holder	Cap	Colour	Lampholders - Skirt partially threaded
LAMPHOLDER	E14	THREADED METAL ENTRY		<b>190.2000FCNB</b> 100/600
				<b>190.2000FCN</b> 100/600
		THREADED PLASTIC ENTRY		<b>190.2000FCGB</b> 100/600
				<b>190.2000FCG</b> 100/600
				<b>190.6000FCNB</b> 50/300
				<b>190.6000FCN</b> 50/300
	E27	THREADED METAL ENTRY		<b>190.7350Z</b> 50/300
				<b>190.6000FCGB</b> 50/300
		THREADED PLASTIC ENTRY		<b>190.6000FCG</b> 50/300
				<b>190.6000CTB</b> 50/300
				<b>190.6000CT</b> 50/300

- Cable 2.5mm<sup>2</sup> (max).
- Entry: M10 x 1.

# Lampholders and switches

## LUX [Lampholders] Series



### ■ For incandescent lamps

LUX Series

190.



Description	Lamp holder	Dimension	Colour	Material	Shade ring
SHADE RING	E14	Ø43x15mm		THERMOPLASTIC	<b>190.31B</b> 50/500
					<b>190.31</b> 50/500
			<b>190.31Z</b> 50/500		
			<b>190.147B</b> 50/500		
	E27	Ø43x8,5mm			<b>190.71B</b> 50/500
					<b>190.71</b> 50/500
		Ø48x8mm			<b>190.73B</b> 50/500
					<b>190.73N</b> 50/500
					<b>190.73Z</b> 50/500
					<b>190.74B</b> 50/500
Ø65x12mm		<b>190.74N</b> 50/500			

- To be used with threaded skirt lampholders.
- Lamphshade holding ring.

LUX Series

190.



Description	Lamp holder	Version	Colour	Material	Lampholder [Special T210°C]
LAMPHOLDER	E27	T210°C		THERMOPLASTIC	<b>190.5778/304T</b> 20/200
					<b>190.5778/306L</b> 20/200
					<b>190.5778/311T</b> 20/200
					<b>190.5778/313T</b> 20/200
					<b>190.5778/348</b> 20/200
					<b>190.5778B</b> 20/200

Earth terminal.

- Cable: 4mm<sup>2</sup> (max).
- 2 holes for screw fixing
- Screw terminals

4.5



# Lampholders and switches

## LUX [Lampholders] Series

■ For incandescent lamps

LUX Series

190.



Lampholder [Special T300°C]

Description	Lamp holder	Version	Colour	Material	Lampholder [Special T300°C]
LAMPHOLDER	E40	T300°C		CERAMIC	<b>190.5740B1</b> 10

- Cable section 1.5-4mm<sup>2</sup>.
- Unscrewing brake.
- Screw terminals

LUX Series

190.



Lampholders - Brass plated metal

Description	Lamp holder	Version	Dimension	Cap	Colour	Material	Lampholders - Brass plated metal
SHADE RING			Ø58,5x15mm				<b>190.81</b> <sup>[1][2]</sup> 50/500
LAMPHOLDER	E27	T210°C		THREADED METAL ENTRY		BRASS PLATED METAL	<b>190.8200</b> <sup>[3][4][5][6][7]</sup> 50/300
				THREADED METAL ENTRY AND EARTH			<b>190.8200T</b> <sup>[3][4][5][6][7]</sup> 50/300

- [1] To be used with threaded skirt lampholders.
- [2] Lampshade holding ring.
- [3] With locking screw.
- [4] With tube stop.
- [5] Cable 2.5mm<sup>2</sup> (max).
- [6] Entry: M10 x 1.
- [7] Screw terminals

DOMESTIC

# Lampholders and switches

## LUX [Lampholders] Series



### ■ For incandescent lamps

LUX Series  
190.



Description	Lamp holder	Colour	IP	Volt	Lamp power	Surface mounting lampholder	
LAMPHOLDER	E27		IP20	12V	60W	<b>190.100</b>	1/10
						<b>190.5501/15TB</b>	100

☑ Total insulation e class II.

▽ Suitable for being installed on usually flammable surface

- Surface mounting

### ■ For halogen lamps

LUX Series  
191.



For low voltage halogen lamps

Dimension	Colour	LAMPHOLDER	
Ø17X10,2mm		<b>191.5031</b>	100/1000

- Type of coupling: G4/GZ4/GX5.3/GY6.35.

- Cable: Teflon-Fep 150mm.

- Made of steatite.

- Push-in terminals.

4.5



# Lampholders and switches

## LUX [Lampholders] Series

■ For halogen lamps

LUX Series

191.



For halogen lamps - with bracket

Version	Dimension	Colour	LAMPHOLDER
LOW VOLTAGE HALOGEN LAMPS	140mm		<b>191.5122</b> 20/200

- Type of coupling: R7s.
- Cable: Teflon-Fep 200mm.
- Made of steatite.
- Profiled.
- Bracket with central hole and slots.

LUX Series

191.



For halogen lamps

Version	Dimension	Colour	Material	LAMPHOLDER
HALOGEN LAMPS	∅19x24,8mm		METAL	<b>191.5124</b> 50/500

- Type of coupling: R7s/RX7s/RX7s-24/RX7s-26/RX7s-32.
- Cable: Teflon-Fep 200mm.
- With fixing nut: M14 x 1.
- Made of aluminium and steatite.

DOMESTIC

# Lampholders and switches

## LUX [switches] Series



### ■ Single pole switches

LUX Series

195.



Description	Colour	Volt	Current	Press switches - T 125°C
PUSH BOTTON SWITCH		250V	2A	<b>195.115B</b> <sup>1</sup> <sup>2</sup> <sup>3</sup> <sup>4</sup> 100/1000 <b>195.135B</b> 3000

<sup>1</sup> NTR 1119/IMQ.

<sup>2</sup> Cable: 1mm<sup>2</sup> (max).

<sup>3</sup> With locknut.

<sup>4</sup> Push-in terminals.

LUX Series

195.



Description	Colour	Volt	Current	Pull switches - T 125°C
PULL SWITCH		250V	2A	<b>195.200B</b> 20/200

- Fixing Ø 3,2mm.

- Single pole switch with cord and white handle grip.

4.5



# Lampholders and switches

## LUX [switches] Series

### Single pole switches

LUX Series

195.





1

2

3

4

DOMESTIC



Description	Colour	Volt	Current	Slide in-line switches
SLIDE SWITCH		250V	2A	<b>195.450B</b> 20/200
				<b>195.450N</b> 20/200
				<b>195.450P</b> 20/200

- ASEV approved.
- Screw closed cover.
- Single pole switches.
- With neutral connection for flat cable.
- Cable: 0.75mm<sup>2</sup> (max).
- Also for inductive current.

LUX Series

195.



Description	Colour	Volt	Current	Foot switches
FOOT SWITCH		250V	2A	<b>195.565B</b> 20/160
				<b>195.565N</b> 20/160
				<b>195.565P</b> 20/160

- Clip together case.
- Single pole foot switch.
- With neutral and earth terminals.
- Cable: 0.75mm<sup>2</sup> (max).
- Also for inductive current.



# Lampholders and switches

## LUX [ceiling] Series



### ■ Ceiling accessories

LUX Series

190.



Description	Colour	Material	Cylindrical ceiling rose	Conical ceiling rose	Spherical ceiling rose
DECORATION					<b>190.378</b> 500
CYLINDRICAL CUP			<b>190.363B</b> 50/500		
			<b>190.363N</b> 50/500		
CONICAL CUP		THERMOPLASTIC		<b>190.366B</b> 50	
				<b>190.366N</b> 50	
SPHERICAL CUP					<b>190.376B</b> 50/250
					<b>190.376N</b> 50/250

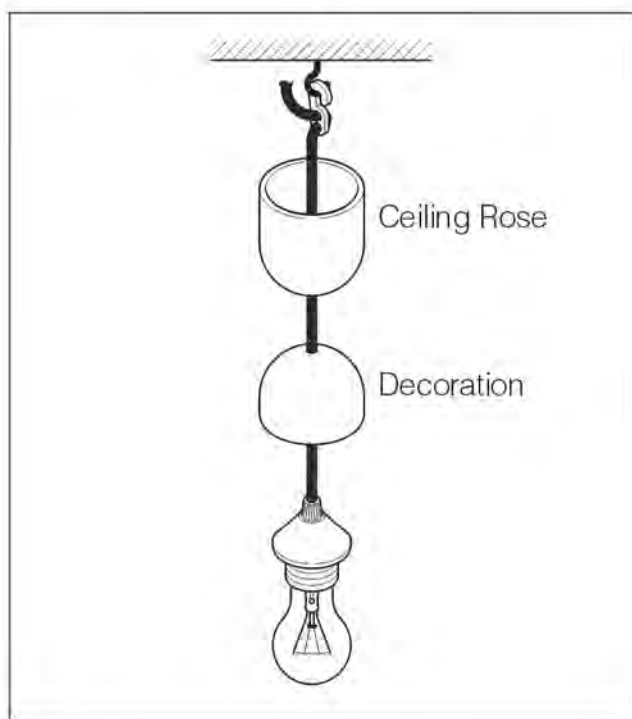

LUX Series  
Ceiling Rose + Decoration

4.5



4.6

## TV/SAT - TEL - DATA

- **DATATEL-TEL Series**  
Components for telephone installations
- **DATATEL-DATA Series**  
Component for structured cabling
- **DATATEL-TV/SAT Series**  
Plugs, sockets and accessories for tv installations





**TV/SAT - TEL - DATA**  
**DATATEL-TEL Series**

**PLUG Standard**

**DATATEL Series**

180.



DOMESTIC

Description	Plug	Colour	Mobile plugs
PLUG	PLUG 4/4	TRANSPARENT	<b>180.790</b> 100/1000
	PLUG 6/4		<b>180.791</b> 100/1000
	PLUG 6/6		<b>180.792</b> 100/1000
	PLUG 10/10		<b>180.793</b> 100/1000

- To be wired using the specially designed plug pincers.

**DATATEL Series**

180.



Description	Installation	Sockets	Colour	Fixed telephone sockets
SOCKET	SURFACE MOUNTING	1xPLUG 6/4		<b>180.701</b> 12/60
		1xPLUG 6/6		<b>180.702</b> 12/60
	FLUSH/SURFACE MOUNTING	1xPLUG 6/4		<b>180.705</b> 12/60
		2xPLUG 6/4		<b>180.706</b> 12/60

■ PLUG Standard

DATATEL Series

180.



Description	Plug	Colour	RJ plug couplers	
COUPLER	PLUG 6/4		<b>180.794</b>	12/60
	PLUG 6/6		<b>180.795</b>	12/60
	PLUG 8/8		<b>180.7951</b>	60

- Suitable for connecting 2 cords with RJ plugs.

DATATEL Series

180.



Description	Plug	Colour	Multiplier RJ plug	
DUPLICATOR	PLUG 6/4		<b>180.796</b>	12/60
TRIPLICATOR			<b>180.799</b>	12/60

- Doubles the connection capacity, allowing another appliance to be connected (eg. telephone + modem).

DATATEL Series

180.



Description	Material	Dimension	Plug pincers	
PLUG PINCERS	METAL	4/4-6/6-8/8	<b>180.798</b>	10
	PLASTIC	4/4-6/4	<b>180.797</b>	1/10
		4/4-6/6-8/8	<b>180.7971</b>	10

- Suitable for wiring the RJ plugs.

4.6



## TV/SAT - TEL - DATA

### DATATEL-TEL Series

#### ■ PLUG Standard >> Telephone cords

DATATEL Series

180.



Straight telephone cords  
with spade terminals  
and RJ plug

Straight telephone cords  
with RJ plugs

Extendable telephone  
cords with RJ plugs

Plug	Cable length	Colour	TELEPHONE CORD		
PLUG 4/4	2m				<b>180.741</b> <sup>1</sup> 12/60
					<b>180.742</b> <sup>1</sup> 12/60
	4,8m				<b>180.743</b> <sup>1</sup> 12/60
					<b>180.744</b> <sup>1</sup> 12/60
PLUG 6/4	2m		<b>180.723</b> 12/60	<b>180.724</b> 12/60	
				<b>180.725</b> 12/60	
	4,8m				<b>180.745</b> <sup>1</sup> 12/60
					<b>180.746</b> <sup>1</sup> 12/60
PLUG 6/6	5m			<b>180.728</b> 12/60	
				<b>180.729</b> 12/60	
	2m			<b>180.726</b> 12/60	
				<b>180.727</b> 12/60	

<sup>1</sup> Plug with gold-plated contacts.

#### ■ Components for telephone installations

DATATEL Series

180.



Flush mounting box

Dimension	Colour	SURFACE MOUNTING BOX		COVER PLAIN		SCREW-DOWN COVER	
		83,5mm			<b>180.690</b> 12/72		<b>180.691</b> 12/72

■ Telephone cable

DATATEL Series

180.



Description	Poles	Cable length	Colour	Round telephone cable (1 meter)	Flat telephone cable (1 meter)
ROUND TELEPHONE CABLE	3P	100m		<b>180.910</b> 100/1000	
				<b>180.911</b> 100/1000	
FLAT TELEPHONE CABLE	4P			<b>180.921</b> <sup>1</sup> 100/800	
				<b>180.920</b> <sup>1</sup> 100/800	
	6P			<b>180.931</b> <sup>1</sup> 100/1000	
				<b>180.930</b> <sup>1</sup> 100/1000	
	8P			<b>180.940</b> <sup>1</sup> 100/1000	
	10P			<b>180.970</b> <sup>1</sup> 100/1000	

<sup>1</sup> Suitable for RJ connectors.

- In coils of 100m.
- Not shuttered.

4.6





## TV/SAT - TEL - DATA

### DATATEL-DATA Series

#### ■ Component for structured cabling

DATATEL Series

180.



DOMESTIC

Description	Plug	Version	Sockets	Colour	Free modular plugs for flexible cable	
SHELL					<b>180.800</b>	100/1000
SHIELDED PLUG	CAT. 5 FTP	SHIELDED TYPE	RJ45	■	<b>180.813</b>	100/1000
		SHIELDED TYPE+INSERT			<b>180.814</b>	100/1000
UNSHIELDED PLUG	CAT. 5 UTP	UNSHIELDED TYPE	RJ45	□	<b>180.811</b>	100/1000
		UNSHIELDED TYPE+INSERT			<b>180.812</b>	100/1000
	CAT. 6 UTP CAT. 3	UNSHIELDED TYPE		■	<b>180.815</b>	100/1000
				□	<b>180.810</b>	100/1000

DATATEL Series

180.



Description	N° outlets	Category of use	Version	Sockets	Colour	Wall telephone outlets - plug 8/8	
SURFACE MOUNTING SOCKET	1 INLETS	CAT. 5E	UNSHIELDED TYPE	CAT. 5E RJ45	□	<b>180.830</b>	10/100
			SHIELDED TYPE			<b>180.831</b>	10/100
	UNSHIELDED TYPE		<b>180.832</b>			10/100	
	SHIELDED TYPE		<b>180.833</b>			10/100	
	2 INLETS						

- Supplied with screws or both sides adhesive tape for wall fastening.



**TV/SAT - TEL - DATA**  
**DATATEL-DATA Series**



■ **Component for structured cabling**

DATATEL Series

180.



Description	Category of use	Version	Sockets	Colour	Socket
RJ45 OUTLET	CAT. 5E FTP	SHIELDED TYPE 100Mbps	RJ45	■	<b>180.821</b> 25/100
	CAT. 5E UTP	UNSHIELDED TYPE 100 Mbps		□	<b>180.820</b> 25/100
	CAT. 6 FTP	SHIELDED TYPE 100Mbps		■	<b>180.823</b> 25/100
	CAT. 6 UTP	UNSHIELDED TYPE 100 Mbps		□	<b>180.822</b> 25/100

DATATEL Series

180.



Description	N° outlets	Colour	Flush telephone outlets for 114x70mm built in box
COVER PLATE	1 INLETS	□	<b>180.841</b> 12/60
	2 INLETS		<b>180.842</b> 12/60
	3 INLETS		<b>180.843</b> 12/60
	4 INLETS		<b>180.844</b> 12/60
	6 INLETS		<b>180.846</b> 12/60
OUTLET COVERING CAP			<b>180.840</b> 50/1000

4.6



**TV/SAT - TEL - DATA**  
**DATATEL-DATA Series**

■ **Component for structured cabling**

DATATEL Series

180.



1

2

3

4

DOMESTIC

Description	Cable length	Category of use	Version	Colour	Connecting patch cords - plug-plug 8/8
PATCH CORD RJ45	1m	CAT. 5E FTP	FTP SHIELDED	■	<b>180.851</b> 12/60
		CAT. 5E UTP	UTP UNSHIELDED		<b>180.850</b> 12/60
		CAT. 6 FTP	FTP SHIELDED		<b>180.855</b> 12/60
		CAT. 6 UTP	UTP UNSHIELDED		<b>180.854</b> 12/60
	3m	CAT. 5E FTP	FTP SHIELDED		<b>180.853</b> 12/60
		CAT. 5E UTP	UTP UNSHIELDED		<b>180.852</b> 12/60
		CAT. 6 FTP	FTP SHIELDED		<b>180.857</b> 12/60
		CAT. 6 UTP	UTP UNSHIELDED		<b>180.856</b> 12/60

- Heat-sealed plugs

DATATEL Series

180.



Description	Category of use	Dimension	Colour	Round rigid cable 24AWG cat.5 (1 meter)
ROUND RIGID CABLE	CAT. 5 FTP	24AWG	■	<b>180.950</b> 100/500
	CAT. 5 UTP			<b>180.960</b> 100/500

- 4 pairs

**TV/SAT - TEL - DATA**  
**DATATEL-TV/SAT Series**



■ For signals up to 2400 MHz

**DATATEL Series**

180.



Description	Outlets type	Ø	Colour	Plugs and sockets Ø9,5mm		
CONNECTOR	STRAIGHT	Ø9,5mm	White	<b>180.5520</b>	50	
	90°			<b>180.5521</b>	50	
PLUG	STRAIGHT			<b>180.5510</b>	50	
	90°			<b>180.5511</b>	50	

- Impedance: 75Ω.
- For antenna system
- For signals up to 2,400 Mhz.

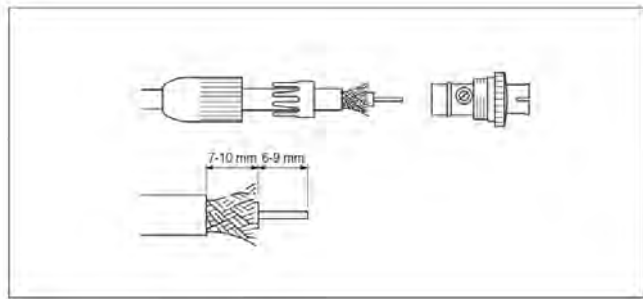

**DATATEL-TV/SAT Series**  
 PLUGS AND SOCKETS Ø 9,5mm (straight)  
 Wiring instructions

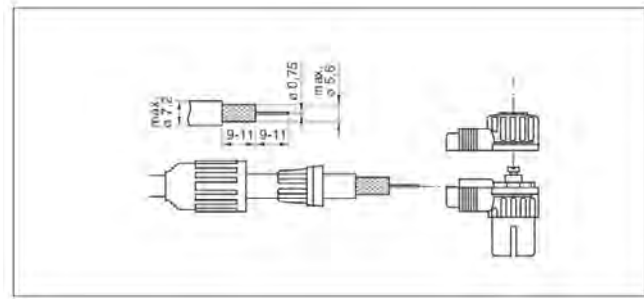

**DATATEL-TV/SAT Series**  
 PLUGS AND SOCKETS Ø 9,5mm (90°)  
 Wiring instructions

4.6



# TV/SAT - TEL - DATA

## DATATEL-TV/SAT Series

■ For signals up to 2400 MHz

### DATATEL Series

180.



1  
2  
3  
4

DOMESTIC

Description	Version	Connector
COUPLER	OUTLET TO OUTLET CONNECTOR	<b>180.5640</b> 10/100
	PLUG TO PLUG CONNECTOR	<b>180.5641</b> 10/100

- Also suitable to connect old systems with new CEI EN 50083 systems.
- Impedance: 75Ω.
- For antenna system
- For signals up to 2,400 Mhz.

### DATATEL Series

180.



Description	Version	Ø	Accessories for television system with satellite receiver		
SCREW F-CONNECTOR	STANDARD LID	ø5,2mm	<b>180.4521</b>	100/1600	
		ø7mm		<b>180.4701</b>	100/1600
	HEAVY	ø5,2mm	<b>180.4520</b>	10/100	
		ø7mm		<b>180.4700</b>	10/100

- Impedance: 75Ω.
- For antenna system
- For signals up to 2,400 Mhz.

**TV/SAT - TEL - DATA**  
**DATATEL-TV/SAT Series**



■ For signals up to 862 MHz

**DATATEL Series**

180.



Description	Version	Ø	Colour	Angled plugs 90° angled coaxial cable exit	Coaxial TV cable divider	Cable connectors Straight coaxial
SOCKET						<b>180.60/CEI-P</b> <sup>[2]</sup> 200/2000
PLUG				<b>180.58/CEI</b> <sup>[1]</sup> 200/2000		<b>180.60/CEI-S</b> <sup>[2]</sup> 200/2000
PLUG/SOCKET		ø9,5mm				<b>180.60/CEI</b> <sup>[2]</sup> 200/2000
SPLITTER	1 SOCKET + 2 PLUGS				<b>180.563</b> <sup>[4]</sup> 10/50	
	1 PLUG + 2 SOCKETS				<b>180.561</b> <sup>[3]</sup> 50/500	

[1] 90° angled coaxial cable exit.

[2] Straight coaxial.

[3] 2 inductive side outlets.

[4] 2 resistive side outlets.

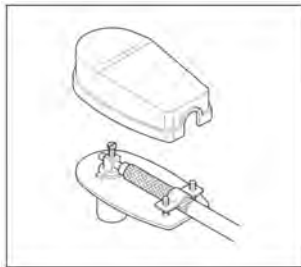

**DATATEL-TV/SAT Series**  
Screw-down cable clamp

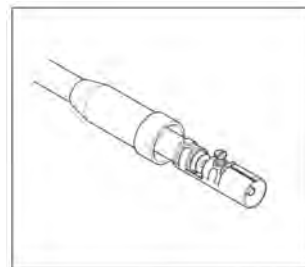

**DATATEL-TV/SAT Series**  
Push in cable clamp

4.6



**TV/SAT - TEL - DATA**  
**DATATEL-TV/SAT Series**

■ **Plugs, sockets and accessories for tv installations**

DATATEL Series

180.



1

2

3

4

DOMESTIC

Description	Cable length	Colour	TV extension cords
TV EXTENSION CORD 9.5mm	2m		<b>180.5902</b> 60
			<b>180.5902/N</b> 60

DATATEL Series

180.



Description	Cable length	Colour	TV extension cords + adaptor
TV EXTENSION CORD 9.5mm	2m		<b>180.5912</b> 60
	3m		<b>180.5913</b> 50
	5m		<b>180.5915</b> 35

**TV/SAT - TEL - DATA**  
**DATATEL-TV/SAT Series**



■ **Plugs, sockets and accessories for tv installations**

TRIS Series

707.



TV cable reel  
 TRIS series

Description	Plug	no.	Sockets	Cable	Cable length	Colour	TV cable reel TRIS series
DOMESTIC CABLE REEL	TV Ø9,5	1	1xTV	COAXIAL	5m		<b>707.1105</b> 1/12
					10m		<b>707.2110</b> 1/12
					15m		<b>707.2115</b> 1/12

- Rewind the cable completely after use.



**Outlet to outlet connector - Plug to plug connector**

Coaxial cable connector are available, as well as "outlet to outlet connector" and "plug to plug connector" for old adaptors and TV installations and ew TV installations according to CEI EN 50083.



**TRIS Series**

Cable reel for TV socket IEC connector, diameter 9.5mm for coaxial cable.

4.6



4.7

## Wiring accessories

- PROTECTA Series  
IP66 weatherproof switches & sockets
- UNIBOX Series [+EVOLUTION]  
Enclosures for wiring accessories
- EVOLUTION Series  
Plates and devices







## Wiring accessories

### PROTECTA Series

#### ■ Surface mounting - IP66 >> Control devices

PROTECTA Series

137.



1  
2  
3  
4  
DOMESTIC

Description	Version	Current	Dimension	1 GANG	2 GANG		
REVERSING SWITCH		10AX	M95(95x95mm)	<b>137.5111</b>	1/12		
		20AX		<b>137.5112</b>	1/12		
DP SWITCH		20A		<b>137.5462</b>	1/12		
SP BELL PUSH SWITCH "BELL"		10A		<b>137.5311B</b>	1/12		
SP BELL PUSH SWITCH "PRESS"	WITH NEON	10A		<b>137.5311P</b>	1/12		
		20A		<b>137.5312P</b>	1/12		
SP ONE WAY SWITCH		10AX		<b>137.5011</b>	1/12	<b>137.5021</b>	1/12
		20AX		<b>137.5012</b>	1/12	<b>137.5022</b>	1/12
SP TWO WAY SWITCH		10AX		<b>137.5211</b>	1/12	<b>137.5221</b>	1/12
		20AX		<b>137.5212</b>	1/12	<b>137.5222</b>	1/12
PUSH BUTTON SINGLE POLE 2 GANG		10A			<b>137.5321</b>	1/12	

#### ■ Surface mounting - IP66

PROTECTA Series

137.



Description	Version	Current	Dimension	Spur units
SPUR UNIT	WITH FUSE AND SWITCH	13A	M115(115x115mm)	<b>137.5410</b> 1/12



**IP66**  
Specifically high formulated gel seal to maintain protection degree when the plug is inserted



**RJ45**  
Standard Ethernet



**ITALIAN STANDARD P17/11 16A (bivalente)**  
Shuttered socket CEI 23-50



**FRENCH STANDARD 16A**  
Shuttered socket



**FRENCH-GERMAN STANDARD 16A**  
Shuttered socket



**ITALIAN STANDARD P30 - 16A**  
Shuttered socket CEI 23-50



**SWISS STANDARD 10A**  
Unshuttered socket SEV 1011:1998



**ARGENTINIAN STANDARD 10A**  
Unshuttered socket

# Wiring accessories

## PROTECTA Series



### ■ Surface mounting - IP66

PROTECTA Series

137.



Modular socket outlets

Description	Version	Current	Dimension		
RJ45 OUTLET	RJ45			<b>137.6481.50</b> <sup>2</sup>	1/12
GERMAN STANDARD SOCKET	GERMAN			<b>137.6407</b>	1/12
	GERMAN UNSHUTTER			<b>137.6412</b> <sup>1</sup>	1/12
ITALIAN P30 STANDARD SOCKET	ITALIAN P30	16A		<b>137.6404</b>	1/12
ITALIAN P17/11 STANDARD SOCKET	ITALIAN P17/11 (DUAL USE)		M95(95x95mm)	<b>137.6403</b>	1/12
FRENCH STANDARD SOCKET	FRENCH			<b>137.6411</b>	1/12
ARGENTINIAN STANDARD SOCKET	ARGENTINE			<b>137.6424</b>	1/12
NEOZELANDER STANDARD SOCKET	NEW ZELAND	10A		<b>137.6427</b>	1/12
SWISS STANDARD SOCKET	SWISS			<b>137.6417</b>	1/12
BRAZILIAN STANDARD SOCKET	BRAZILIAN			<b>137.6421</b>	1/12

<sup>1</sup> Shutterless socket, subject to normative restrictions or prohibitions in Europe or in other geographical areas. Check the national laws prior to using or installing it.

<sup>2</sup> RJ45 - Cat.5E

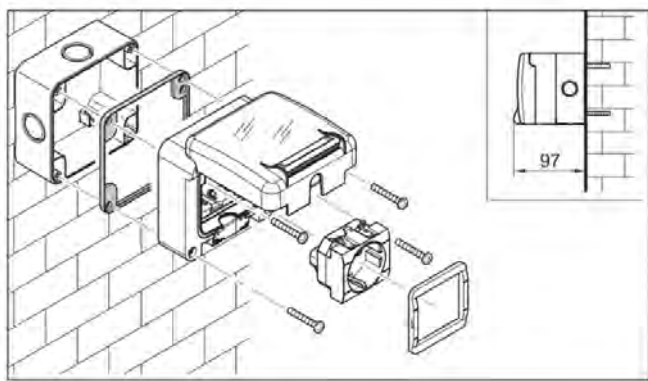

**PROTECTA Series**  
Surface mounting



**BRAZILIAN STANDARD 10A**  
Unshuttered socket ABNT NBR 14136:2002



**NEW ZEALAND STANDARD 10A**  
Unshuttered socket AS/NZS 3112



**GERMAN STANDARD 16A**  
Unshuttered socket

4.7



# Wiring accessories

## PROTECTA Series

### ■ Surface mounting - IP66

PROTECTA Series

137.



1  
2  
3  
4

DOMESTIC

Description	Version	Current	Dimension	 BS socket outlets
13A SOCKET + 20A DP SWITCH			M95x2(195x95mm)	<b>137.6003</b> 1/12
DOUBLE DP SWITCHSOCKET	■ BRITISH BS1363	13A	M195(195x115mm)	<b>137.6042</b> 1/12
DOUBLE UNSWITCHED SOCKET			M95x2(195x95mm)	<b>137.6043</b> <sup>1</sup> 1/12
SINGLE DP SWITCHSOCKET				<b>137.6002</b> 1/12
SINGLE SP SWITCHSOCKET	■ BRITISH BS546	15A	M115(115x115mm)	<b>137.6022</b> 1/12
SINGLE UNSWITCHED SOCKET	■ BRITISH BS1363	13A	M95(95x95mm)	<b>137.6111</b> 1/12
SINGLE UNSWITCHED SOCKET	■ BRITISH BS1363	13A	M95(95x95mm)	<b>137.6001</b> 1/12

<sup>1</sup> RCD protection (passive)

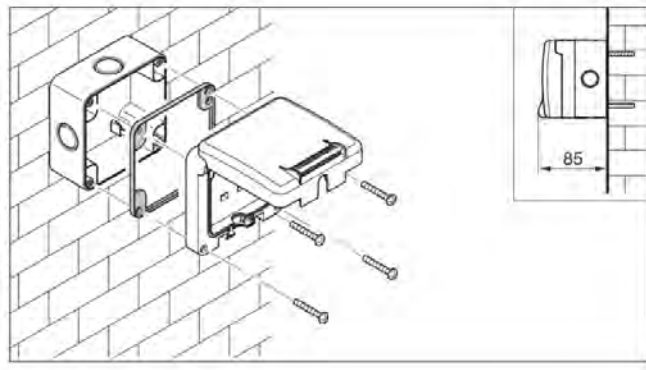

**PROTECTA Series**  
Surface mounting



**BRITISH STANDARD 15A**  
Shuttered socket BS 546



**BRITISH STANDARD 13A**  
Shuttered socket BS 1363-2



**IP66**  
Specifically high formulated gel seal to maintain protection degree when the plug is inserted

## Wiring accessories PROTECTA Series



### ■ Surface mounting - IP66

#### PROTECTA Series

137.



Description	Dimension	Surface mounting box	
SURFACE MOUNTING BOX	M115(115x115mm)	<b>137.103</b>	1/12
	M195(195x115mm)		<b>137.104</b> 1/12
	M95(95x95mm)	<b>137.101</b>	1/12
	M95x2(195x95mm)	<b>137.102</b>	1/12

### ■ Flush mounting - IP66 >> Control devices

#### PROTECTA Series

137.



Description	Version	Current	Dimension	1 GANG	2 GANG
REVERSING SWITCH		10AX	M95(95x95mm)	<b>137.3111</b>	1/12
		20AX		<b>137.3112</b>	1/12
DP SWITCH		20A		<b>137.3462</b>	1/12
SP BELL PUSH SWITCH "BELL"		10A		<b>137.3311B</b>	1/12
SP BELL PUSH SWITCH "PRESS"	WITH NEON	10A		<b>137.3311P</b>	1/12
		20A		<b>137.3312P</b>	1/12
SP ONE WAY SWITCH		10AX		<b>137.3011</b>	1/12
		20AX		<b>137.3012</b>	1/12
SP TWO WAY SWITCH		10AX		<b>137.3211</b>	1/12
		20AX		<b>137.3212</b>	1/12
PUSH BUTTON SINGLE POLE 2 GANG		10A			<b>137.3321</b> 1/12

- Flush mounting: box not included.

4.7



# Wiring accessories

## PROTECTA Series

### Flush mounting - IP66

PROTECTA Series

137.



Spur units

Description	Version	Current	Dimension	Spur units
SPUR UNIT	WITH FUSE AND SWITCH	13A	M115(115x115mm)	<b>137.3410</b> 1/12

- Flush mounting: box not included.

DOMESTIC

- 1
- 2
- 3
- 4



**IP66**  
Specifically high formulated gel seal to maintain protection degree when the plug is inserted



**RJ45**  
Standard Ethernet



**ITALIAN STANDARD P17/11 16A (bivalente)**  
Shuttered socket CEI 23-50



**FRENCH STANDARD 16A**  
Shuttered socket



**FRENCH-GERMAN STANDARD 16A**  
Shuttered socket



**ITALIAN STANDARD P30 - 16A**  
Shuttered socket CEI 23-50



**SWISS STANDARD 10A**  
Unshuttered socket SEV 1011:1998



**ARGENTINIAN STANDARD 10A**  
Unshuttered socket

# Wiring accessories

## PROTECTA Series



### ■ Flush mounting - IP66

PROTECTA Series

137.



Modular socket outlets

Description	Version	Current	Dimension		
RJ45 OUTLET	RJ45			<b>137.4481.50</b> <sup>[2]</sup>	1/12
GERMAN STANDARD SOCKET	GERMAN			<b>137.4407</b>	1/12
	GERMAN UNSHUTTER			<b>137.4412</b> <sup>[1]</sup>	1/12
ITALIAN P30 STANDARD SOCKET	ITALIAN P30	16A	M95(95x95mm)	<b>137.4404</b>	1/12
ITALIAN P17/11 STANDARD SOCKET	ITALIAN P17/11 (DUAL USE)			<b>137.4403</b>	1/12
FRENCH STANDARD SOCKET	FRENCH			<b>137.4411</b>	1/12
ARGENTINIAN STANDARD SOCKET	ARGENTINE			<b>137.4424</b>	1/12
NEOZELANDER STANDARD SOCKET	NEW ZELAND	10A		<b>137.4427</b>	1/12
SWISS STANDARD SOCKET	SWISS			<b>137.4417</b>	1/12
BRAZILIAN STANDARD SOCKET	BRAZILIAN			<b>137.4421</b>	1/12

[1] Shutterless socket, subject to normative restrictions or prohibitions in Europe or in other geographical areas. Check the national laws prior to using or installing it.

[2] RJ45 - Cat.5E

- Flush mounting: box not included.

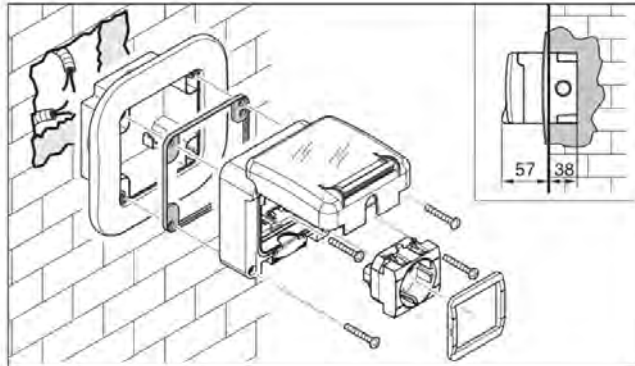

**PROTECTA Series**  
Flush mounting



**BRAZILIAN STANDARD 10A**  
Unshuttered socket ABNT NBR 14136:2002



**NEW ZEALAND STANDARD 10A**  
Unshuttered socket AS/NZS 3112



**GERMAN STANDARD 16A**  
Unshuttered socket



4.7



# Wiring accessories

## PROTECTA Series

### Flush mounting - IP66





PROTECTA Series

137.



1  
2  
3  
4

DOMESTIC

Description	Version	Current	Dimension	 BS socket outlets
13A SOCKET + 20A DP SWITCH			M95x2(195x95mm)	<b>137.4003</b> 1/12
DOUBLE DP SWITCHSOCKET	 BRITISH BS1363	13A	M195(195x115mm)	<b>137.4042</b> 1/12
DOUBLE UNSWITCHED SOCKET			M95x2(195x95mm)	<b>137.4002</b> 1/12
SINGLE DP SWITCHSOCKET				<b>137.4022</b> 1/12
SINGLE SP SWITCHSOCKET	 BRITISH BS546	15A	M115(115x115mm)	<b>137.4111</b> 1/12
SINGLE UNSWITCHED SOCKET	 BRITISH BS1363	13A	M95(95x95mm)	<b>137.4001</b> 1/12

<sup>1</sup> RCD protection (passive)

- Flush mounting: box not included.

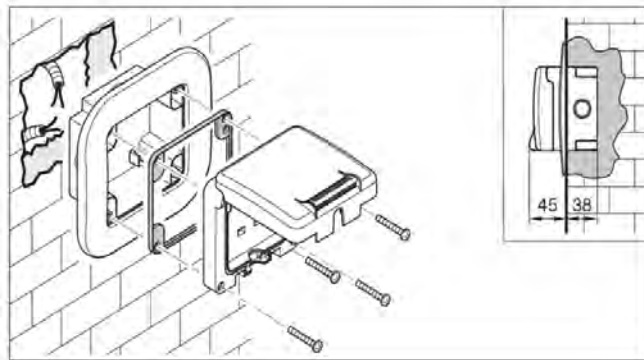

**PROTECTA Series**  
Flush mounting (BS standard)



**BRITISH STANDARD  
15A**  
Shuttered socket BS 546



**BRITISH STANDARD  
13A**  
Shuttered socket BS 1363-2



**IP66**  
Specifically high formulated gel seal to maintain protection degree when the plug is inserted



# Wiring accessories

## PROTECTA Series



### Flush mounting - IP66

PROTECTA Series

137.



Description	Dimension	Flush mounting box	
FLUSH MOUNTING BOX	M115(115x115mm)	<b>137.123</b>	1/12
	M195(195x115mm)		<b>137.124</b> 1/12
	M95(95x95mm)	<b>137.121</b>	1/12
	M95x2(195x95mm)	<b>137.122</b>	1/12



APPLICATION EXAMPLE

4.7



## Wiring accessories PROTECTA Series

### Flush mounting - IP66

PROTECTA Series

137.



1  
2  
3  
4

DOMESTIC

Description	Dimension	Adapter M95
ADAPTOR	M95(95x95mm)	<b>137.125</b> 12/120

- The IP55 degree of protection is obtained with the cover closed and with the item installed on smooth, impermeable walls without grooves (smooth tiles, marble).

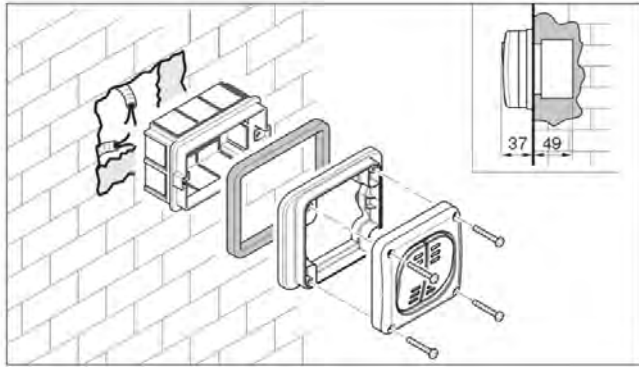

**PROTECTA Series**  
Flush-mounting box adapter

# Wiring accessories

## PROTECTA Series



### ■ Flush mounting - IP66

#### PROTECTA Series

137.



Description	Dimension	Box	
TOP POLE ENCLOSURE	M95(95x95mm)	<b>137.131</b>	1/12
SIDE BY SIDE POLE		<b>137.141</b>	1/12

- Accepts SCAME EVOLUTION Series inserts.

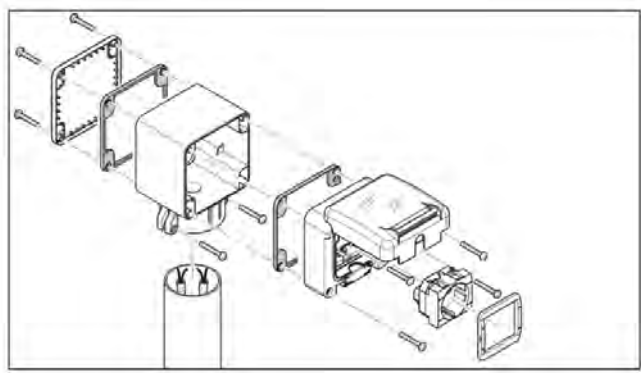

**PROTECTA Series**  
Pole-top mounting

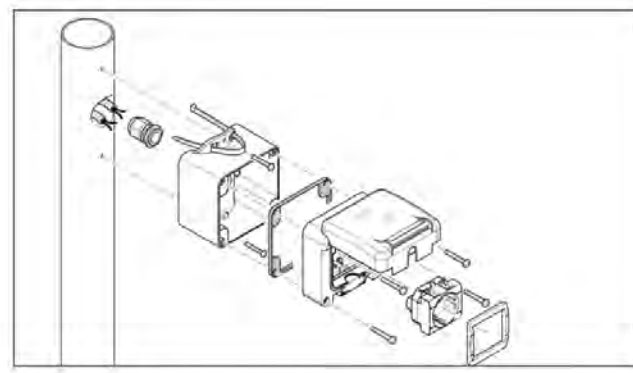

**PROTECTA Series**  
Pole side by side mounting

4.7



# Wiring accessories

## PROTECTA Series

■ Flush mounting - IP66

PROTECTA Series

137.



Adapter 70x87mm

Description	Dimension	Adapter 70x87mm
PRE DRILLED COVER WITH FLANGE - 70x87mm cut-outs	M95(95x95mm)	<b>137.151</b> 1/12

DOMESTIC

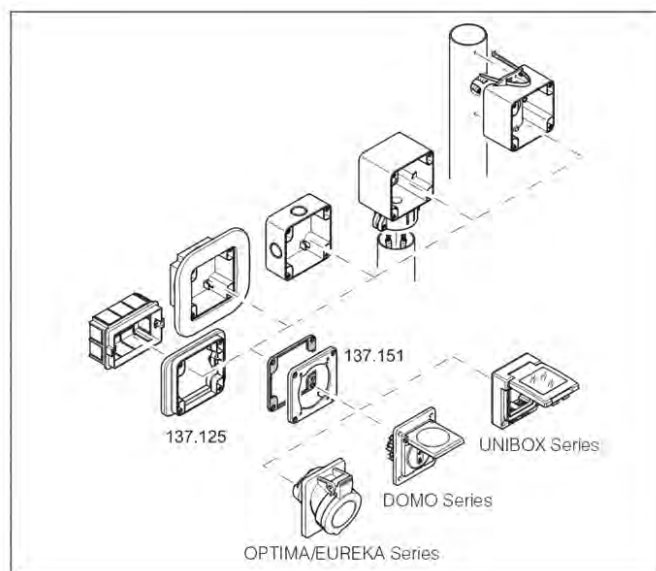

### PROTECTA Series

Cover for M95 boxes with 70x87mm predrilling

# Wiring accessories

## PROTECTA Series



### ■ Flush mounting - IP66

#### PROTECTA Series

137.



Description	Dimension	Empty enclosure	
EMPTY ENCLOSURE	M95(95x95mm)	<b>137.001</b> 1/12	<b>137.002</b> 1/12

- Accepts SCAME EVOLUTION Series inserts.

#### PROTECTA Series

137.



Description	Accessories	
EARTH TERMINAL	<b>137.201</b> 10/100	
LED 220V	<b>137.200</b> 10/100	
TPE SEAL		<b>137.202</b> 10/100

4.7



## Wiring accessories

### UNIBOX Series [+EVOLUTION]

#### ■ Empty box (surface mounting)

#### UNIBOX Series

136.



#### Without cover - IP40

#### COVER FLANGE FOR MODULAR DEV.

IP40

No. Modules	Colour	68x82x52mm	98x82x52mm	137x82x66mm	198x82x66mm
1 MOD.	■	👍 <b>136.4121</b> 5/100			
2 MOD.	■		👍 <b>136.4122</b> 5/100		
3 MOD.	■			👍 <b>136.4123</b> 3/60	
2+2 MOD.	■				👍 <b>136.4124</b> 1/24
3+3 MOD.	■				👍 <b>136.4126</b> 1/16

- Accepts SCAME EVOLUTION Series inserts.
- Glow-wire test: 650°C.
- Wall-mounting enclosures
- Cable inlet: 3 knock-outs Ø23 mm and one with cable gland PG16.
- Note: Versions pre-fitted with EVOLUTION Series inserts in RAL 7035 grey available upon request.

#### UNIBOX Series

136.



#### With cover - IP55 Soft transparent membrane

#### COVER FLANGE FOR MODULAR DEV.

IP55

No. Modules	Colour	68x82x66mm	98x82x66mm	137x82x66mm	198x82x66mm
1 MOD.	■	👍 <b>136.5121</b> 5/80			
2 MOD.	■		👍 <b>136.5122</b> 5/80		
3 MOD.	■			👍 <b>136.5123</b> 3/60	
2+2 MOD.	■				👍 <b>136.5124</b> 1/24
3+3 MOD.	■				👍 <b>136.5126</b> 1/16

- Accepts SCAME EVOLUTION Series inserts.
- Glow-wire test: 650°C.
- Wall-mounting enclosures
- Cable inlet: 3 knock-outs Ø23 mm and one with cable gland PG16.
- Note: Versions pre-fitted with EVOLUTION Series inserts in RAL 7035 grey available upon request.

DOMESTIC

## Wiring accessories UNIBOX Series [+EVOLUTION]

**SCAME**

### ■ Preassembled box

#### UNIBOX Series

136.



#### IP40 - 3 MOD

IP	Dimension	No. Modules	Colour	Volt	Switches	Sockets	COVER FLANGE FOR MODULAR DEV.	
							Part No.	Quantity
IP40	98x82x52mm	3 MOD.	■	250V	1x16AX 1W S.P. SWITCH	1x13A BRITISH SOCKET	<b>136.4123-413</b>	50
						1x15A BRITISH SOCKET	<b>136.4123-414</b>	50
						1x16A FRENCH SOCKET	<b>136.4123-411</b>	50
						1x16A GERMAN SOCKET	<b>136.4123-412</b>	50

#### UNIBOX Series

136.



#### IP55 - 1 MOD

IP	Dimension	No. Modules	Colour	Volt	Switches	Sockets	COVER FLANGE FOR MODULAR DEV.	
							Part No.	Quantity
IP55	68x82x66mm	1 MOD.	■	250V	1x16AX 1W S.P. SWITCH	1x16A SUISSSE SOCKET	<b>136.5121-303</b>	32/128
					1x16AX 2W S.P. SWITCH		<b>136.5121-323</b>	32/128
					1x16A S.P. PUSH BUTTON		<b>136.5121-333</b>	32/128
					1x20A D.P. SWITCH		<b>136.5121-302</b>	32/128
					1x20A D.P. SWITCH WITH NEON		<b>136.5121-304</b>	32/128

4.7





## Wiring accessories

### UNIBOX Series [+EVOLUTION]

#### ■ Preassembled box

UNIBOX Series

136.



IP55 - 2 MOD

IP	Dimension	No. Modules	Colour	Volt	Switches	Sockets	COVER FLANGE FOR MODULAR DEV.	
IP55	68x82x66mm	2 MOD.	■	250V	2x16AX 1W S.P. SWITCH		<b>136.5122-303</b>	32/128
					2x16AX 2W S.P. SWITCH		<b>136.5122-323</b>	32/128
						1x13A BRITISH SOCKET	<b>136.5122-413</b>	32/128
						1x15A BRITISH SOCKET	<b>136.5122-414</b>	32/128
						1x16A FRENCH SOCKET	<b>136.5122-411</b>	32/128
						1x16A GERMAN SOCKET	<b>136.5122-412</b>	32/128
						1x16A GERMAN SHUTTERED SOCKET	<b>136.5122-407</b>	32/128
						1x10A NEW ZEALAND SOCKET	<b>136.5122-427</b>	32/128
						1x6-16A INDIAN SOCKET	<b>136.5122-429</b>	32/128

UNIBOX Series

136.



IP55 - 3 MOD

IP	Dimension	No. Modules	Colour	Volt	Switches	Sockets	COVER FLANGE FOR MODULAR DEV.	
IP55	98x82x66mm	3 MOD.	■	250V	3x16AX 1W S.P. SWITCH		<b>136.5123-303</b>	24/96
					3x16AX 2W S.P. SWITCH		<b>136.5123-323</b>	24/96
						1x13A BRITISH SOCKET	<b>136.5123-413</b>	24/96
						1x15A BRITISH SOCKET	<b>136.5123-414</b>	24/96
						1x16A FRENCH SOCKET	<b>136.5123-411</b>	24/96
						1x16A GERMAN SOCKET	<b>136.5123-412</b>	24/96
						1x16A GERMAN SHUTTERED SOCKET	<b>136.5123-407</b>	24/96
						1x6-16A INDIAN SOCKET	<b>136.5123-429</b>	24/96



## Wiring accessories UNIBOX Series [+EVOLUTION]



### ■ Preassembled box

#### UNIBOX Series

136.



#### IP55 - 2+2 MOD

IP	Dimension	No. Modules	Colour	Volt	Switches	Sockets	COVER FLANGE FOR MODULAR DEV.
IP55	137x82x66mm	2+2 MOD.	■	250V	1x16AX 1W S.P. SWITCH	2x13A BRITISH SOCKET	<b>136.5124-413</b> 1/24
						2x16A FRENCH SOCKET	<b>136.5124-411</b> 1/24
						2x16A GERMAN SOCKET	<b>136.5124-412</b> 1/24
						2x16A GERMAN SHUTTERED SOCKET	<b>136.5124-407</b> 24
						4x16AX 1W S.P. SWITCH	<b>136.5124-303</b> 1/24
					4x16AX 2W S.P. SWITCH	<b>136.5124-323</b> 1/24	

#### UNIBOX Series

136.



#### IP55 - 3+3 MOD

IP	Dimension	No. Modules	Colour	Volt	Switches	Sockets	COVER FLANGE FOR MODULAR DEV.
IP55	198x82x66mm	3+3 MOD.	■	250V	1x16AX 1W S.P. SWITCH	2x13A BRITISH SOCKET	<b>136.5126-413</b> 1/16
						2x16A FRENCH SOCKET	<b>136.5126-411</b> 1/16
						2x16A GERMAN SOCKET	<b>136.5126-412</b> 1/16
						2x16A GERMAN SHUTTERED SOCKET	<b>136.5126-407</b> 16
						6x16AX 1W S.P. SWITCH	<b>136.5126-303</b> 1/16
					6x16AX 2W S.P. SWITCH	<b>136.5126-323</b> 1/16	

4.7



## Wiring accessories

### UNIBOX Series [+EVOLUTION]

#### ■ Empty box (panel mounting)

UNIBOX Series

136.



[UNIBOX]

FLUSH MOUNTING FRAME

IP55

Dimension	No. Modules	Colour		
120x98x28mm	3 MOD.		 <b>136.5023</b>	85
			 <b>136.5023.AT</b>	85

- The IP55 protection degree becomes IP20 when the cover is open.

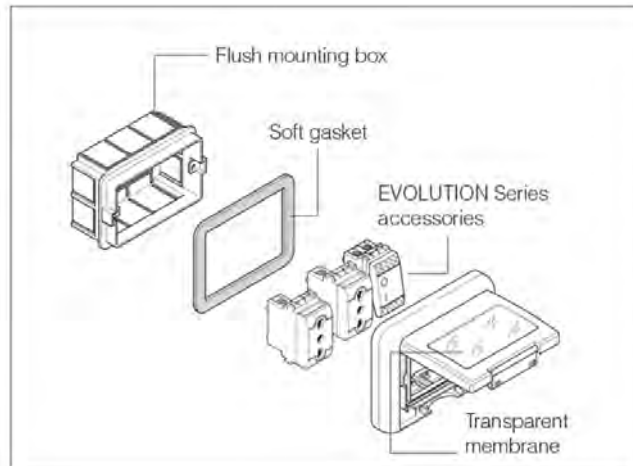

#### UNIBOX Series

Examples of installation (wall housing - IP55)

1

2

3

4

DOMESTIC

# Wiring accessories

## UNIBOX Series [+EVOLUTION]



### ■ Empty box (panel mounting)

#### ENCLOSURES ACCESSORIES

654.



**[OMNIA]**

Suitable for	Colour	IP	COVER WITH INSERT	
EVOLUTION	■	IP55	136x125mm	
BTICINO			<b>654.0122</b>	6
			<b>654.0121</b> <sup>1</sup>	6

<sup>1</sup> Manufactured with the authorization from Bticino spa company and is suitable to house "Living International", "Luna", "Light" and "Light Tech" modules which are registered trademarks owned by Bticino.

- Modules snap into place.

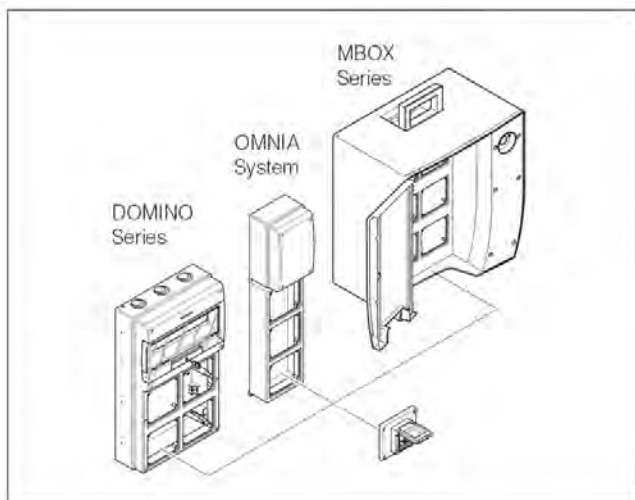

**OMNIA Series**  
Examples of installation (flange 136x125mm)

4.7



## Wiring accessories UNIBOX Series [+EVOLUTION]

### ■ Empty box (panel mounting)

#### DOMO Series

570.



#### [DOMO]

#### FLUSH MOUNTING FRAME

70x87mm

IP	Suitable for	Colour		
IP55	EVOLUTION	■	<b>570.5052</b>	10/100
	BTICINO		<b>570.5012</b> <sup>[1]</sup>	10/100

[1] Manufactured with the authorization from Bticino spa company and is suitable to house "Living International", "Luna", "Light" and "Light Tech" modules which are registered trademarks owned by Bticino.

- Modules snap into place.

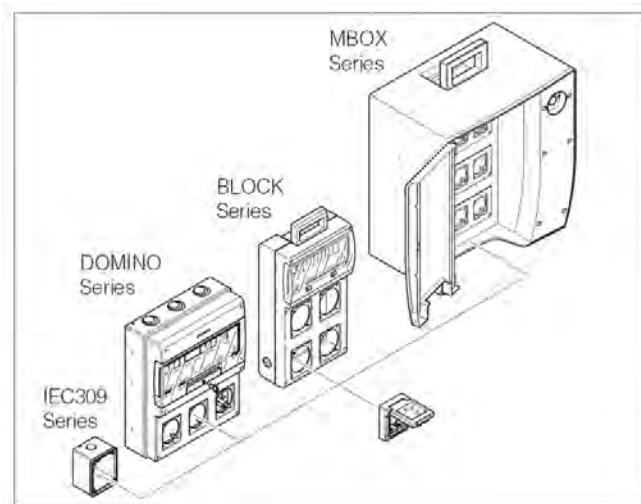

**DOMO Series**  
Examples of installation (flange 70x87mm)

# Wiring accessories

## UNIBOX Series [+EVOLUTION]



### Enclosures for wiring accessories

UNION Series	ENCLOSURES ACCESSORIES	UNIBOX Series
805.	654.	136.



#### Accessories For wall version

Colour	IP	Version	COUPLER	SEALING CAPS (12 pz.)	EARTH TERMINAL	WALL MOUNTING BRACKETS KIT
■	IP66	LIGHT	<b>805.3334</b> 10/50			
				<b>654.0080</b> <sup>1</sup> 10/100		<b>136.001</b> 10
					<b>654.0376</b> 20/200	

<sup>1</sup> For providing total insulation e according to EN 60439-1.  
- Only for surface mounting enclosure.

4.7



## Wiring accessories

### EVOLUTION Series

#### ■ Devices >> Covers and plates for push button

EVOLUTION Series

101.



Description	Colour	Blank cover	Cable outlet
BLANK COVER 1 GANG		<b>101.6201.G</b> 100/800	
CABLE OUTLET 1 GANG			<b>101.6203.G</b> 100

DOMESTIC

1  
2  
3  
4

#### ■ Devices >> Control devices

EVOLUTION Series

101.



Description	Version	Current	Volt	Colour	Switches
ONE WAY SWITCH	DOUBLE POLE	16AX	250V		<b>101.6302.G</b> 12/480
		20AX			<b>101.6304.G</b> 12/480
	SINGLE POLE	16AX			<b>101.6302.20G</b> 12/480
		20AX			<b>101.6304.20G</b> 12/480
	SINGLE POLE WITH KEY	16AX			<b>101.6303.G</b> 12/480
		16A			<b>101.6303.20G</b> 12/480
				<b>101.6301K.G</b> 6/240	

Neon available as accessory.

Neon included

EVOLUTION Series

101.



Description	Version	Current	Volt	Colour	Reversing switch
REVERSING SWITCH	SINGLE POLE	16AX	250V		<b>101.6311.G</b> 12/480

Neon available as accessory.

## Wiring accessories EVOLUTION Series

**SCAME**

### ■ Devices >> Control devices

#### EVOLUTION Series

101.



Description	Version	Current	Volt	Colour	Two way switch
TWO WAY SWITCH	SINGLE POLE	16AX	250V	■	<b>101.6323.G</b> 12/480

Neon available as accessory.

#### EVOLUTION Series

101.



Description	Version	Current	Volt	Colour	Push button (NO)
PUSH BUTTON	DOUBLE POLE	16A	250V	■	<b>101.6332.G</b> 12/480
	SINGLE POLE				<b>101.6334.G</b> 12/480
	FOR SHUTTERS - SINGLE POLE	10A			<b>101.6333.G</b> 12/480
	CORD OPERATED	10A			<b>101.63312.G</b> 12/480
		16A			<b>101.6331T.G</b> 6/240

Neon available as accessory.

Neon included

#### EVOLUTION Series

101.



Description	Poles	Current	Volt	Colour	Miniature circuit breakers (MCB) 3kA
MCB	1P+N	6A	250V	■	<b>101.6340.06G</b> 12/480
		10A			<b>101.6340.10G</b> 12/480
		16A			<b>101.6340.G</b> 12/480

4.7



# Wiring accessories

## EVOLUTION Series

### Devices >> Control devices

#### EVOLUTION Series

101.



Miniature circuit breakers and residual current (RCBO) 3kA-10mA

Description	Poles	Current	Volt	Colour		
RCBO	1P+N	6A	250V		<b>101.6341.06G</b>	6/240
		10A			<b>101.6341.10G</b>	6/240
		16A			<b>101.6341.G</b>	6/240

#### EVOLUTION Series

101.



Description	Volt	Colour	Fuse holder	
FUSE HOLDER	250V		<b>101.6345.G</b>	12/480

- Fuse 6,3x32



**ITALIAN STANDARD P17/11 16A (bivalente)**  
Shuttered socket CEI 23-50



**FRENCH STANDARD 16A**  
Shuttered socket



**BRITISH STANDARD 15A**  
Shuttered socket BS 546



**FRENCH-GERMAN STANDARD 16A**  
Shuttered socket



**ITALIAN STANDARD P30 - 16A**  
Shuttered socket CEI 23-50



**PLURISTANDARD P40 16A**  
Shuttered socket



**BRITISH STANDARD 13A**  
Shuttered socket BS 1363-2



**SWISS STANDARD 10A**  
Unshuttered socket SEV 1011:1998



# Wiring accessories

## EVOLUTION Series



### ■ Devices >> Socket-outlets

EVOLUTION Series

101.



Description	Version	Poles	Current	Volt	Colour	For energy (european standard)
SOCKET	ITALIAN P17/11 (DUAL USE)	2P+E	16A	250V	Red	101.6403.R 12/480
	FRENCH				Grey	101.6403.G 12/480
	BRITISH BS546				Grey	101.6411.G 6/240
	GERMAN		Red		101.6414.G 6/240	
	GERMAN		Grey		101.6407.R 6/240	
	GERMAN		Grey		101.6407.G 6/240	
	ITALIAN P30		Red		101.6404.R 6/240	
	ITALIAN P30		Grey		101.6404.G 6/240	
	ITALIAN P40		Red		101.6405.R 6/240	
	ITALIAN P40		Grey		101.6405.G 6/240	
	BRITISH BS1363		Grey		101.6413.G 6/240	
	SWISS		Grey		101.6417.G 12/480	
	ITALIAN P11		Green		101.6401.G 12/480	
	ITALIAN P17		Green		101.6402.G 12/480	
	GERMAN UNSHUTTER		Red		101.6412.R <sup>1</sup> 6/240	
GERMAN UNSHUTTER	Grey	101.6412.G <sup>1</sup> 6/240				

<sup>1</sup> Shutterless socket, subject to normative restrictions or prohibitions in Europe or in other geographical areas. Check the national laws prior to using or installing it.

4.7



**ITALIAN STANDARD  
P11 - 10A**  
Shuttered socket CEI 23-50



**ITALIAN STANDARD  
P17 - 16A**  
Shuttered socket CEI 23-50



**GERMAN STANDARD  
16A**  
Unshuttered socket

# Wiring accessories

## EVOLUTION Series

### Devices >> Socket-outlets

EVOLUTION Series

101.



1  
2  
3  
4

DOMESTIC

Description	Version	Poles	Current	Volt	No. Modules	Colour	For energy (international standard)
SOCKET	EUROAMERICAN	2P	15A		1 MOD.		<b>101.6423.G</b> 12/480
ARGENTINIAN STANDARD SOCKET	ARGENTINE		10A				<b>101.6425.G</b> 12/480
			20A				<b>101.6424.G</b> 6/240
NEOZELANDER STANDARD SOCKET	NEW ZELAND	2P+E	10A	250V	2 MOD.		<b>101.6426.G</b> 6/240
SOUTH AFRICAN STANDARD SOCKET	SOUTH AFRICAN		16A				<b>101.6427.G</b> 6/240
INDIAN STANDARD SOCKET	INDIAN		6A 16A				<b>101.6428.G</b> 6/240
BRAZILIAN STANDARD SOCKET	BRAZILIAN		10A		1 MOD.		<b>101.6429.G</b> 6/240
							<b>101.6421.R</b> 12/480
							<b>101.6421.G</b> 12/480

EVOLUTION Series

101.



Description	Version	Current	Volt	No. Modules	Colour	DIN rail
INDICATOR UNIT				1 MOD.		<b>101.6541.2GD</b> 6
RJ45 OUTLET						<b>101.6481.50GD</b> 6
GERMAN STANDARD SOCKET		16A		2 MOD.		<b>101.6407.GD</b> 6
ITALIAN P40 STANDARD SOCKET						<b>101.6405.GD</b> 6
SINGLE UNSWITCHED SOCKET	DIN	13A				<b>101.6413.GD</b> 6
ITALIAN P17/11 STANDARD SOCKET		16A	250V	1 MOD.		<b>101.6403.GD</b> 6
FRENCH STANDARD SOCKET						<b>101.6411.GD</b> 6
ARGENTINIAN STANDARD SOCKET		10A		2 MOD.		<b>101.6424.GD</b> 6
SOUTH AFRICAN STANDARD SOCKET		16A				<b>101.6428.GD</b> 6
SWISS STANDARD SOCKET		10A		1 MOD.		<b>101.6417.GD</b> 6

Neon available as accessory.

- Insert mounted on DIN support.



**EURO-AMERICAN STANDARD 15A**  
Shuttered socket



**ARGENTINIAN STANDARD 10A**  
Unshuttered socket



**BRAZILIAN STANDARD 10A**  
Unshuttered socket ABNT NBR 14136:2002



**NEW ZEALAND STANDARD 10A**  
Unshuttered socket AS/NZS 3112



**SOUTH AFRICAN STANDARD 16A**  
Shuttered socket SANS 164-1 (2006)



**INDIAN STANDARD 6/16A**  
Shuttered socket IS 1293:1988

# Wiring accessories

## EVOLUTION Series



### ■ Devices >> Socket-outlets

EVOLUTION Series

101.



Description	Version	Colour	TV/SAT outlets
TV OUTLET	MALE		<b>101.6431.01G</b> <sup>[1]</sup> 12/480
			<b>101.6431.10G</b> <sup>[2]</sup> 12/480
			<b>101.6431.G</b> <sup>[3]</sup> 12/480
FM OUTLET	FEMALE		<b>101.6431.10</b> <sup>[2]</sup> 12/480
			<b>101.6432.01G</b> 12/480
			<b>101.6432.10G</b> 12/480
SAT OUTLET			<b>101.6432.G</b> 12/480
TV-SAT OUTLET			<b>101.6433.G</b> 12/480
			<b>101.6434.G</b> 6/240

[1] Terminal 75Ω

[2] Attenuation 10dB

[3] Direct

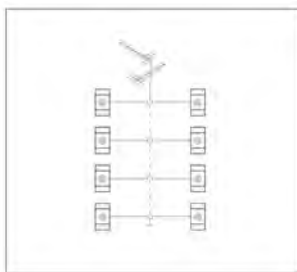

EVOLUTION Series  
Terminal

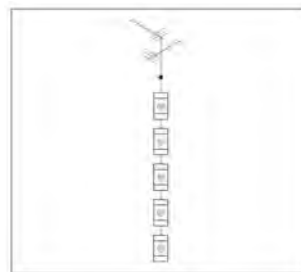

EVOLUTION Series  
Attenuation



EVOLUTION Series  
Direct

4.7



## Wiring accessories

### EVOLUTION Series

#### ■ Devices >> Socket-outlets

EVOLUTION Series

101.



1  
2  
3  
4

DOMESTIC

Description	Version	Poles	Volt	Colour	Telephone outlets
RJ11 OUTLET	TWIN				<b>101.6462.64G</b> 12/480
	6/4 PLUG				<b>101.6461.64G</b> 12/480
TELEPHONE OUTLET		2P	48V		<b>101.6464.G</b> 12/480

EVOLUTION Series

101.



Description	Version	Colour	Data communication outlets (RJ45 - plug 8/8)
RJ45 OUTLET	CAT.5 UNSHIELDED (UTP)		<b>101.6481.50G</b> 6/240
	CAT.5 SHIELDED (FTP)		<b>101.6481.51G</b> 6/240
	CAT.6 UNSHIELDED (UTP)		<b>101.6481.60G</b> 6/240
	CAT.6 SHIELDED (FTP)		<b>101.6481.61G</b> 6/240

#### ■ Devices >> Signal devices

EVOLUTION Series

101.



Description	Colour	Indicator units
INDICATOR UNIT		<b>101.6541.1G</b> 12/480
		<b>101.6541.2G</b> 12/480
		<b>101.6541.3G</b> 12/480
		<b>101.6542.G</b> 12/480

✍ Neon included

# Wiring accessories

## EVOLUTION Series



### ■ Support and accessories

EVOLUTION Series

101.



Description	Volt	Colour	Neon lamps	
NEON LAMPS	12V	NEUTRAL	<b>101.6200.12</b>	100
	24V		<b>101.6200.24</b>	100
	110V		<b>101.6200.11</b>	100
	230V		<b>101.6200</b>	100

4.7



# Wiring accessories

## EVOLUTION Series

### Support and accessories

#### ENCLOSURES ACCESSORIES

654.



- 1
- 2
- 3
- 4

DOMESTIC

Description	Suitable for	Support DIN	
DIN RAIL BRACKET	1 x EVOLUTION	<b>654.0091</b>	12/120
	2 x EVOLUTION	<b>654.0092</b>	12/120



**EVOLUTION Series**  
EVOLUTION Series module mounted on DIN rail support

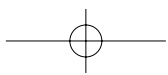
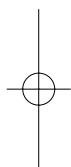
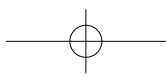







**GENERAL  
CATALOGUE  
2016-2018**  
technical sheets

# Index

## General technical informations

(in alphabetical order)

### A



**ADAPTO Series**  
Industrial adaptors



**ADVANCE 2 Series**  
Interlocked switch  
socket outlets



**ADVANCE 2 System**  
Modular system



**ADVANCE-GRP System**  
Switched interlocked  
socket outlets



**ADVANCE-GRP[AMR] System**  
Automated meter reading



**ADVANCE-GRP[EX] Series**



**ADVANCE-GRP[GD] Series**



**ALUBOX Series**  
Junction boxes  
for electrical installations



**ALUBOX-EX Series**



**AUTOROLLER Series**  
Cable reels  
with automatic rewind



**AZZURRA Series**  
Domestic plugs, sockets,  
adaptors and multi-outlet  
sockets

### B



**BEEBOX Series**  
Empty distribution  
assemblies



**BLOCK Series**  
Distribution assemblies



**BLUELINE Series**  
Domestic plugs, sockets,  
adaptors and multi-outlet  
sockets

### C



**CABLO Series**  
Only available on the internet  
web site [www.scame.com](http://www.scame.com)



**COMMAND Series**  
Rotary switches



**CONNECTO Series**  
Connecting accessories



**CUBIK Series**  
Junction boxes  
forelectrical installations



**CUBOX Series**  
Junction boxes for electrical  
installations

### D



**DATATEL Series**  
Components for TV/SAT,  
telephone installations  
and category 5E



**DOMINO Series**  
Consumer units  
and enclosures



**DOMO Series**  
Sockets for  
domestic applications



**DOMOPLUS Series**  
Domestic standard sockets  
for industrial applications

**E**

**EASYBOX Series**  
Weather-proof enclosures



**EMERGENCY Series**  
Emergency call points



**ENERBOX Series**  
Distribution assemblies



**EUREKA Series**  
Industrial plugs and sockets



**EUREKA [PIN&SLEEVE] Series**  
Heavy duty industrial  
plugs and sockets



**EVOLUTION Series**  
Plates and devices



**EVOLVE Series**

**F**

**FASTY Series**  
Only available on the internet  
web site [www.scame.com](http://www.scame.com)



**FIXER Series**  
Conduit fixing accessories



**FIXO Series**  
Only available on the internet  
web site [www.scame.com](http://www.scame.com)



**FLAT Series**  
Flush mounting  
consumer units

**G**

**GEA Series**



**GOMMA Series**  
Distribution assemblies

**H**

**HALE Series**  
Light fittings



**HYDRA Series**  
Light fittings

**I**

**IEC309 Series**  
Only available on the internet  
web site [www.scame.com](http://www.scame.com)



**INNOVA Series**



**ISOLATORS-AL Series**  
Aluminium enclosure  
16A-160A



**ISOLATORS-EX Series**



**ISOLATORS-EX [GD] Series**



**ISOLATORS-HD Series**  
Heavy duty engineering  
plastic insulated enclosure  
20A-40A



**ISOLATORS-HR Series**  
High rating hinged sheet steel  
enclosure - 200A-1600A



**ISOLATORS-INOX Series**  
Stainless steel enclosure  
16A-160A



**ISOLATORS-PH Series**  
Photovoltaic/dc switch  
disconnectors thermoplastic  
insulated enclosure  
10A-40A (800V DC)



See specific catalogue

# Index



**ISOLATORS-SWITCH Series**  
Enclosed change-over switches I/O/II - 16A-160A



**ISOLATORS-TP Series**  
Thermoplastic insulated enclosure - 16A-160A

## K



**KIOSK Series**  
Distribution pedestals terminals



**KOMPAS Series**



## L



**LIBERA Series**



**LUX Series**  
Lampholder



**LUXURY Series**



**LV-LUX Series**  
Only available on the internet web site [www.scame.com](http://www.scame.com)

## M



**MBOX Series**  
Distribution assemblies



**MEGA Series**  
Distribution assemblies



**METALCLAD Series**



**MIZAR Series**  
Light fittings

## N



**NEXTA Series**



## O



**OMNIA Series**  
Interlocked switch socket outlets



**OMNIA System**  
Flush and surface mounting modular system



**OMNIPLUS Series**  
Domestic interlocked socket



**OPTIMA Series**  
Industrial plugs and sockets



**OPTIMA-BASE-TOP-COMBI Series**  
Industrial surface mounting socket outlets



**OPTIMA-EX Series**



**OPTIMA-EX[GD] Series**



**OPTIMA-HD Series**  
Plugs and connectors for demanding applications



**OPTIMA-METAL Series**  
Screened, dust and watertight metallic connectors



**OPTIMA-REVERSE Series**  
Plugs with phase inverters



**OPTIMA-SEVEN Series**  
Industrial plugs and sockets

P



**PROTECTA Series**  
Weatherproof switches and sockets

R

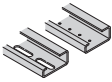

**RAILDIN Series**  
Only available on the internet web site [www.scame.com](http://www.scame.com)



**ROLLER Series**  
Industrial cable reels

S



**SALVAMOTORE Series**  
Only available on the internet web site [www.scame.com](http://www.scame.com)



**SCABOX Series**  
Junction boxes for electrical installations



**SICURA Series**  
Multi-outlet sockets



**SMART Series**  
Conduit installation accessories



**SPYROS Series**  
Only available on the internet web site [www.scame.com](http://www.scame.com)

T



**TIES Series**  
Cable ties



**TOP22 Series**  
Control and signalling accessories



**TRANSFORMER Series**  
Only available on the internet web site [www.scame.com](http://www.scame.com)



**TREND Series**  
Multi-outlet sockets



**TRIS Series**  
Domestic cable reels



**TUBE Series**  
Conduit installation accessories

U



**UNEL Series**  
Domestic plugs and sockets



**UNIBOX Series**  
Enclosure for wiring accessories



**UNION Series**  
Cable glands



**UNION-EX Series**



W



**WADO Series**  
Trunking Systems



**WBOX Series**  
Flush mounting boxes

X



**XENIA Series**  
Industrial plugs and sockets

Z



**ZENITH-P Series**



**Note:** all technical sheets are also available on the internet web-site [www.scame.com](http://www.scame.com) in the section "InfoTECH".

# General technical informations

## DEGREES OF PROTECTION FOR ENCLOSURES (IP CODE) EN 60529

These standards apply to enclosures for electrical material with a rated voltage not exceeding 72.5 KV.

The second edition of these standards does generally change the IP degrees, but clarifies some aspects that were not completely clear in the previous edition.

According to these standards, the IP degree of protection should be used exclusively with the 2 defining numbers and the additional letters provided for by the standards.

These are defined as follows:

### 1ST NUMBER

Protection for people from contact with hazardous parts (see also ADDITIONAL LETTER) and protection of equipment from the entry of solid foreign bodies.

### 2ND NUMBER

Protection of equipment from water entry.

IP	Solid foreign objects	Access to hazardous parts	
0			No protection
1			Protection from solid objects larger than 50 mm (eg accidental contact of the hand)
2			Protection from solid objects larger than 12 mm (eg the finger of a hand)
3			Protection from solid objects larger than 2.5 mm (eg tools, wires)
4			Protection from solid objects larger than 1 mm (eg fine tools and small wires)
5			Protection from dust (no harmful deposits)
6			Completely protected from dust

IP	Test	
0		No protection
1		Protected from vertically falling water drops
2		Protected from vertically falling water drops at up to 15° from the vertical
3		Protected from vertically falling water drops at up to 60° from the vertical (rain)
4		Protected from splashing water in all directions
5		Protected from jets of water in all directions
6		Protected from jets of water similar to heavy seas
7		Protected from the effects of immersion
8		Protected from the effects of submersion
9		Protected from high pressure or high temperature jets of water

## ■ ADDITIONAL LETTER

To be used when the protection of people from hazardous parts is higher than that demanded by the first number for protection from the entry of solid objects.

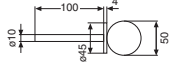
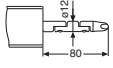
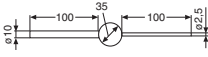
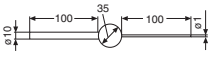
Letter		Definition
<b>A</b>		Protected from access with the back of the <b>hand</b> . The access probe, spherical 50 mm Ø, should have adequate clearance from hazardous parts.
<b>B</b>		Protected from access with a <b>finger</b> . The joined test finger of 12 mm Ø and 80 mm long should have adequate clearance from hazardous parts.
<b>C</b>		Protected from access with a <b>tool</b> . The access probe of 2.5 mm Ø, 100 mm length should have adequate clearance from hazardous parts.
<b>D</b>		Protected from access with a <b>wire</b> . The access probe of 1.0 mm Ø, 100 mm length should have adequate clearance from hazardous parts.

## ■ SUPPLEMENTARY LETTER

Used to supply additional information about the material.

Letter	Definition
<b>H</b>	High-voltage apparatus
<b>M</b>	Tested for harmful effects due to water entry when the movable parts (eg the rotor of a rotating machine) are in motion.
<b>S</b>	Tested for harmful effects due to water entry when the movable parts (eg the rotor of a rotating machine) are stationary.
<b>W</b>	Suitable for use under specified weather conditions and provided with additional protective features or processes.

# General technical informations

## INDUSTRIAL PLUGS AND SOCKETS TO IEC 60309 RATED OPERATING VOLTAGE >50 V

### Clock face position

Viewing the socket from the front, the clock face position **h** is established by observing the position of the earth contact with respect to the major keyway, which is always situated at 6 o'clock.

The different voltages are identified by conventional colour codes.

### Clock reference:

All the versions required by the IEC 60309 standard are available, including the more specific:

### Examples:

- standard use ..... **h 6**
- refrigerated container ..... **h 3**
- marine, port or ship installation ..... **h 11**
- direct current (2P + E) ..... **h 3 and 8**
- supply by isolation transformer (TST) ..... **h 12**
- high frequency, from 100 to 300 Hz ..... **h 10**
- high frequency, from 300 to 500 Hz ..... **h 2**
- specific voltages 100 - 130V ..... **h 4**
- 480 - 500V ..... **h 7**
- 600 - 690V ..... **h 5**

### Clock position - IEC ratings - Series I

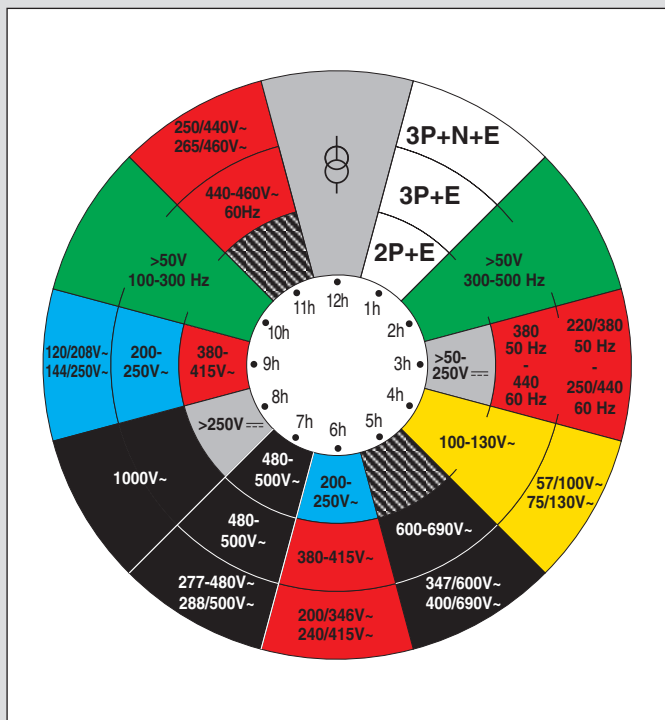

### CLOCK DIAGRAM

Clock face position (**h**) of the earth pole of low voltage (>50 V) industrial plugs and sockets to IEC 60309-2 for different applications (polarity, voltage, frequency, current).

= Supply from isolation transformer

## COLOUR CODE

The operating voltages are identified by conventional colours as shown in the table:

Rated operating voltage V	Colour 1)
from 20 to 25	Violet
from 40 to 50	White
from 100 to 130	Yellow
from 200 to 250	Blue
from 380 to 480	Red
from 500 to 1000	Black

1) Combinations of green with the colour of the rated operating voltage can be used to identify frequencies between 60 Hz and 500 Hz inclusive.

### SOCKET (front view)

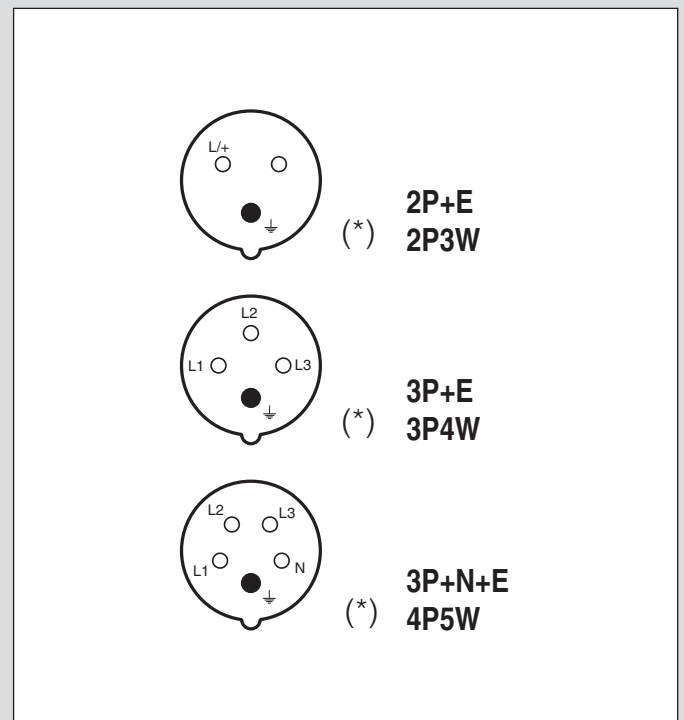































(\*) Major keyway



## ■ SYNOPTIC TABLE OF STANDARD INDUSTRIAL PLUGS AND SOCKETS TO IEC 60309-2

Rated operating voltage > 50 V (LV)

Number of contact	Poles	Frequency Hz	Rated operating voltage V	Clock face pos. (h) Earth contact (1)		Colour code
				16/20A 32/30A	63/60A 125/100A	
3 Contact 2P3W	1P+N+E II Series	50 and 60	100÷130	4	4	
		60	277	5	5	
	2P+E I and II Series	50 and 60	100÷130	4	4	
			200÷250	6	6	
			380÷415	9	9	
			480÷500	7	7	
			suppl. by isol. transf.	12	12	- (5)
		100÷300	> 50	10	10	 (4)
	>300÷500	> 50	2	2	 (4)	
	d.c.	>50÷250	3	3	- (5)	
> 250		8	8	- (5)		
4 Contact 3P4W	2P+N+E II Series	50 and 60	125/250	12	12	
		50 and 60	100÷130	4	4	
	200÷250		9	9		
	380÷415		6	6		
	3P+E I and II Series	60	440÷460 (4)	11	11	
		50 and 60	480÷500	7	7	
			600÷690	5	5	
		50	380	3	3	
		60	440 (3)			
		50 and 60	1000	8	8	
100÷300	> 50	10	-	 (4)		
>300÷500	> 50	2	-	 (4)		
5 Contact 4P5W	3P+N+E I and II Series	50 and 60	57/100÷75/130	4	4	
			120/208÷144/250	9	9	
			200/346÷240/415	6	6	
			277/480÷288/500	7	7	
			347/600÷400/690	5	5	
		60	250/440÷265/460 (4)	11	11	
		50	220/380	3	3	
		60	250/440 (3)			
		50 and 60	1000	8	8	
		50 and 60	suppl. by isol. transf.	12	12	
100÷300	> 50	10	10	 (4)		
>300÷500	> 50	2	2	 (4)		
ALL TYPES	All types of voltage and/or frequency not within these standardised configurations		1	1	-	

(1) The positions shown by a dash (-) are not standardised

(2) For ISO standard refrigerated containers

(3) Mainly for shipboard installations

(4) Combinations of green with the colour of the rated operating voltage can be used to identify frequencies between 60 Hz and 500 Hz inclusive.

(5) Plugs and sockets for which the IEC 60309-2 standard sets only the clock face position (h) of the earth contact and not the colour, are supplied by SCAME in RAL 7035 grey

### SERIES I AND SERIES II

Series I and Series II have more or less the same dimensions, but are classified according to different rated currents. For Series I, currents are 16A, 32A, 63A, and 125A and for Series II, rated currents are 20A, 30A, 60A and 100A.

Series I products are used in all European countries and some countries in South America, Asia, Australia and Africa. On the contrary, Series II products are mainly marketed in North America (USA, Mexico and Canada) and some countries in South America.















### NOTE

• SCAME plugs and sockets for specific uses other than 4 - 6 - 9 h are available only on demand and are therefore not kept in stock. Minimum order quantities: 50 pieces.

# General technical informations

## SYNOPTIC TABLE OF STANDARD INDUSTRIAL PLUGS AND SOCKETS TO IEC 60309-2

### Rated operating voltage <50V~ (ELV)

Poles	Frequency Hz	Rated operating voltage V	Minor keyway (1) clock face position (h) 16A and 32A without reference	Colour code
2P	50 and 60	20÷25	without ref.	
	50 and 60	40÷50	12	
	100÷200	20÷25 e	4	 (2)
	300		2	 (2)
	400		3	 (2)
	>400÷500		11	 (2)
	c.c.		10	
3P	50 and 60	20÷25	without ref.	
	50 and 60	40÷50	12	
	100÷200	20÷25 e	4	 (2)
	300		2	 (2)
	400		3	 (2)
	>400÷500		11	 (2)
	c.c.		8	 (3)

- (1) 1, 8 and 9 h positions are reserved for future standards; 5, 6 and 7 h positions cannot be used for reasons connected with the design.  
 (2) Combinations of green with the colour of the rated operating voltage can be used to identify frequencies between 60 Hz and 500 Hz inclusive.  
 (3) Portable electric incubators - use at 12 Vd.c. or 24 Vd.c. on ambulances or helicopters.

### SOCKET (front view)

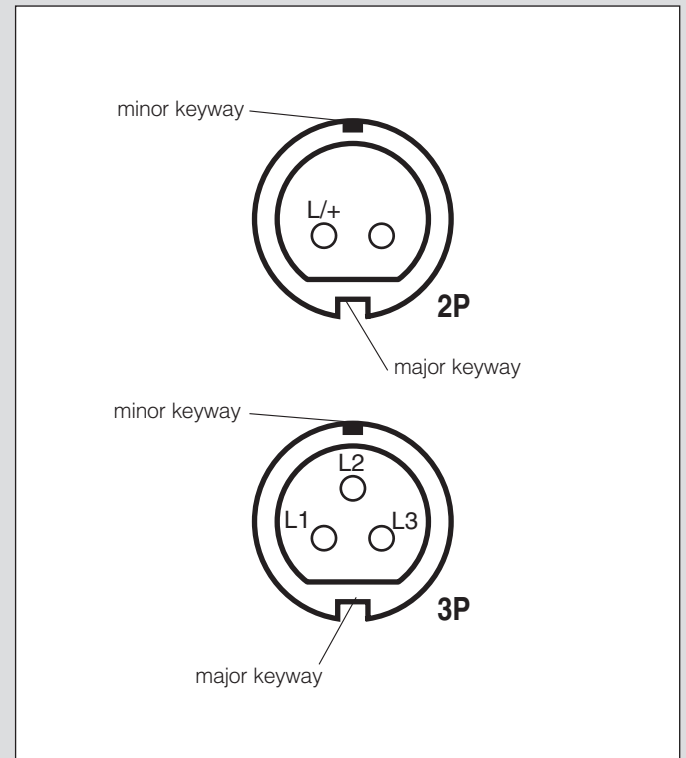

### Clock face position

Viewing the socket from the front, the clock face position h is established by observing the position of the minor keyway with respect to the major keyway, which is always situated at 6 o'clock. The different voltages are identified by conventional colour codes.

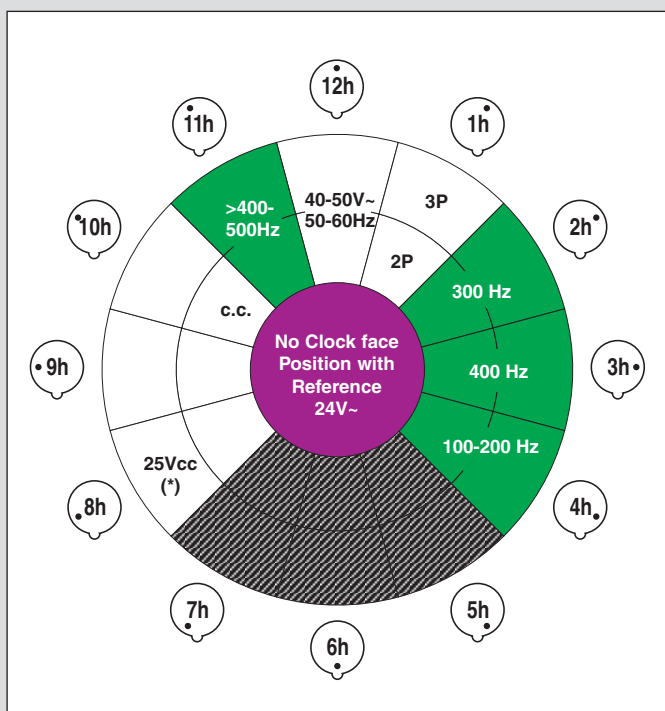

### Clock diagram

Clock face position (h) of the minor keyway of extra-low voltage (<50 V) industrial plugs and sockets to IEC 309-2 for different applications (polarity, voltage, frequency, current).

(\*)

Portable electric incubators - use at 12 Vd.c. or 24 Vd.c. on ambulances or helicopters.

## ■ APPLICATIONS OF INDUSTRIAL PLUGS AND SOCKETS

	IP44	IP67
<b>Agriculture</b>	Mobile or portable equipment or appliances used or stored on sheltered premises.	Outdoor installation of pumping, ventilation, drying equipment.
<b>Chemical industry</b>	Indoors on premises for storage and maintenance purposes where connections are not exposed to the risk of immersion or chemicals.	On premises without risk of explosions but where the connections are exposed to chemicals and subject to possible immersion.
<b>Construction sites and shipyards</b>	On covered construction sites sheltered against weathering but exposed to splashing with water.	On outdoor construction sites where the connections are left on damp ground exposed to freezing, dust and weathering.
<b>Sports complexes and other places of public entertainment, TV and film studios</b>	On sheltered premises protected against the weather, though exposed to splashing, without high connected loads.	Outdoor connections exposed to rain, snow, mud, freezing and other critical weather conditions. Where mated safety is required. Where high voltage for lighting installations, T.V. and audio are foreseen.
<b>Food industry</b>	In sheltered locations, on indoor premises used for storage and maintenance.	In locations subject to washing by hosing down and where connections are subject to heavy duty.
<b>Heavy industry</b>	In sheltered warehouses, maintenance workshops, assembly and moulding areas.	In rolling mills, foundries, blast furnaces, etc., where the connections are exposed to dust, metallic shavings, coolants and are subject to vibrations and impact.
<b>Light industry</b>	Locations without high humidity or ambient pollution serving for assembly, moulding, maintenance and storage	On premises subject to cleaning by means of chemical solvents. Also where heavy loads require high safety in connections.
<b>Installations for IT centres</b>	For electrical connections executed above floor level.	For electrical connections under raised floors with risk of immersion. Where heavy loads require high safety in connections.
<b>Ports</b>	In sheltered locations such as docks, repair shops, offices, etc.	Quays, docks, piers, etc. where there is risk of high waves and partial flooding.
<b>Airports</b>	In sheltered locations, hangars, repair shops, warehouses.	Outdoors for connection between mobile or portable appliances and aircraft.
<b>Water treatment plants</b>	Indoor use in repair shops, etc.	In all locations with risk of flooding and for outdoor use with pumps, aeration and ventilation systems.

# Integrated systems

## ■ INTEGRATED SYSTEMS FOR ELECTRICAL INSTALLATIONS

Scame produces three integrated systems for assembling weatherproof electrical distribution and connection installations:

- **DOMINO System** a modular system of enclosures for distribution assemblies and consumer units
- **ADVANCE 2 System** a modular system for combination units
- **OMNIA System** a modular flush and surface mounting system

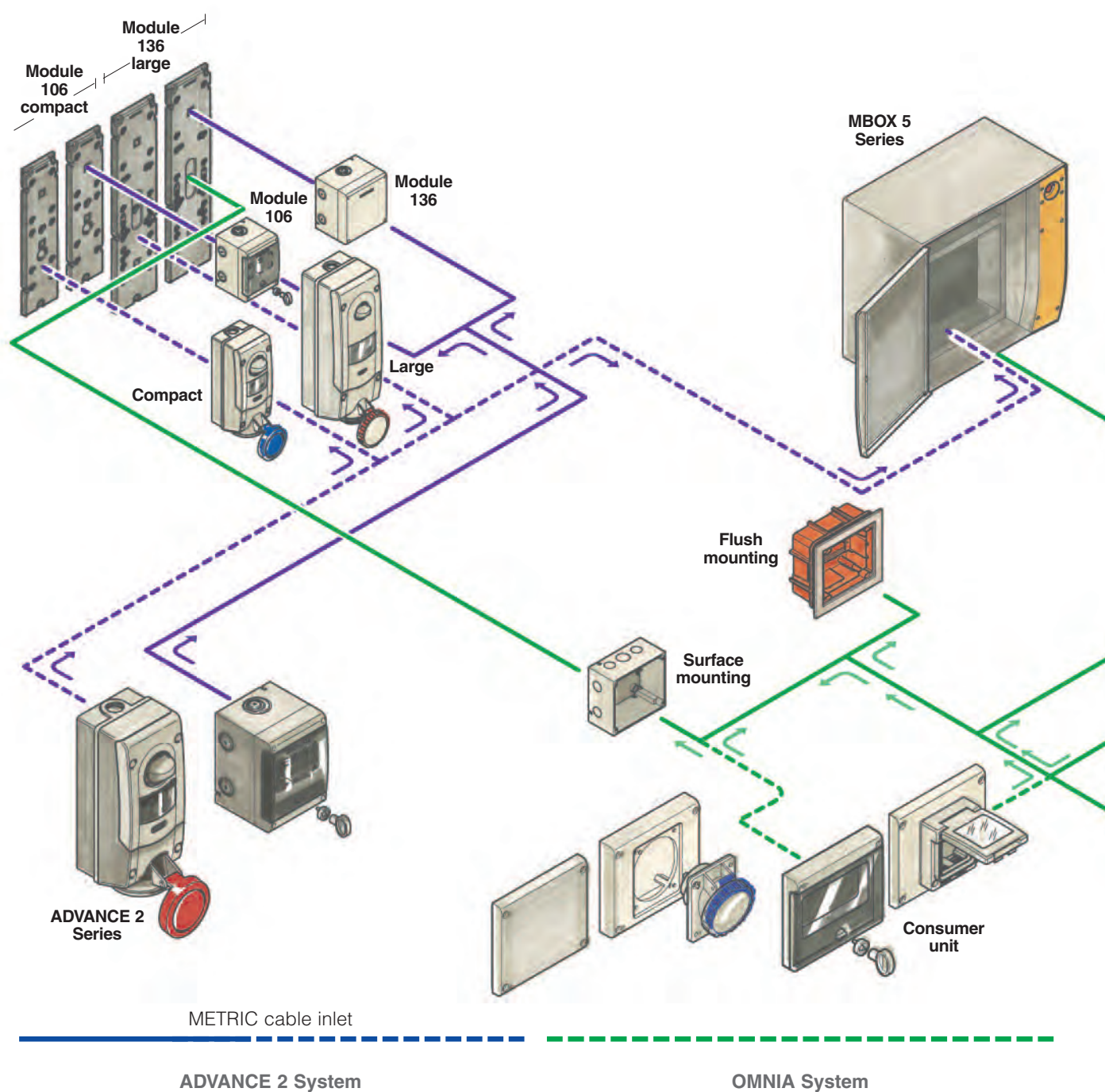



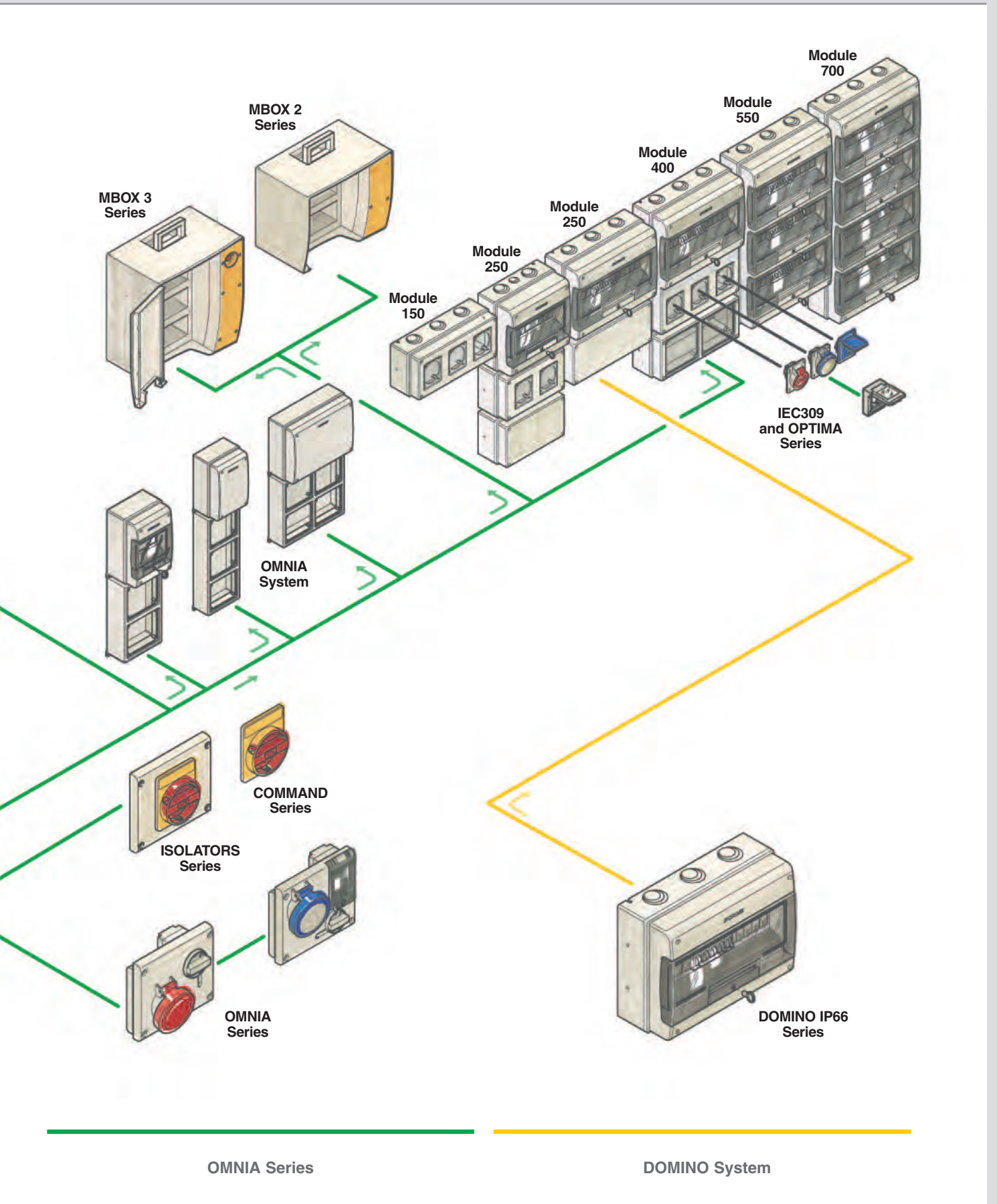

# Integrated systems

## MBOX Series

MBOX2



656.0024-000

MBOX3



657.0035-000  
657.0036-000  
657.0037-000

MBOX5



658.0050-000  
658.0051-000

## DOMINO Series

8 DIN

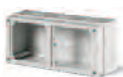

672.1200

12 DIN



672.2200



672.3200

16 DIN



672.4216

16 DIN



672.5316

16 DIN



672.5416

24 DIN



672.5522

24 DIN



672.5622

## OMNIA Series

6 DIN



572.0311



572.0312



572.0313



572.0200

14 DIN



572.0314



572.0315



572.0316



572.0220



572.0310  
572.M0310



572.M0308



572.0322

## ADVANCE 2 Series



Module 106  
(compact)



Module 136 (large)  
HD Version

## OMNIA Series



## ADVANCE 2 System

### STANDARD VERSION



Flange 70x87

Module 106 (compact)	12	576.4300	12	⊕ 576.4303	12	⊕ 576.4301	6	⊕ 576.4304	6	⊕ 576.4302	6	⊕ 576.4305
Module 136 (large)	6	576.4340	12	⊕ 576.4323	12	⊕ 576.4321	6	⊕ 576.4324	6	⊕ 576.4322	6	⊕ 576.4325

### HEAVY DUTY VERSION



Module 106 (compact)	12	578.4300			12	⊕ 578.4301	6	⊕ 578.4304	6	⊕ 578.4302	6	⊕ 578.4305
Module 136 (large)	6	578.4340			12	⊕ 578.4321	6	⊕ 578.4324	6	⊕ 578.4322	6	⊕ 578.4325

### MBOX Series



656.0026-000

657.0038-000  
657.0039-000

### DOMINO Series



672.1301

672.1300

672.2300

672.2301

672.3300

672.3302

672.4316

672.5616

672.5622

672.5822

### OPTIMA Series



### BLOCK Series



632.1500-000

632.3500-000

632.3520-000

632.3530-000

632.3501-000

632.4500-000

632.4520-000

632.4530-000

632.5520-000

632.5500-000



## INDUSTRIAL ADAPTORS



## TECHNICAL CHARACTERISTICS

Rated current:	16A-32A
Frequency:	50Hz
Insulating voltage:	500/690V~
Protection degree:	IP20-IP44-IP66-IP67
Operating ambient temperature according to the reference standard:	-25°C +40°C
Max. operating ambient temperature:	60°C
Glow Wire test:	650°C/750°C/850°C
Material:	Engineering plastic
IK degree at 20°C:	IK06 - IK09

## BEHAVIOUR WITH CHEMICAL AND ATMOSPHERIC AGENTS

Saline solution	Acids		Bases			Solvents			Mineral oil	UV rays
	Concentrated	Diluted	Concentrated	Diluted	Hexane	Benzol	Acetone	Alcohol		
Resistant	Not Resistant	Not Resistant	Limited Resistance	Resistant	Not Resistant	Not Resistant	Not Resistant	Limited Resistance	Resistant	Resistant

## AVAILABLE STANDARDS

	<b>ITALIAN STANDARD P17/11 - 16A</b> Shuttered socket CEI 23-50		<b>ITALIAN STANDARD P30 - 16A</b> Shuttered socket CEI 23-50		<b>PLURISTANDARD P40 - 16A</b> Shuttered socket CEI 23-50		<b>BRITISH STANDARD - 13A</b> Shuttered socket BS 1363-2		<b>FRENCH STANDARD - 16A</b> Shuttered socket NFC 61-314
	<b>BRITISH STANDARD - 15A</b> Shuttered socket BS 546		<b>ARGENTINIAN STANDARD - 10A</b> Unshuttered socket IRAM 2071		<b>NEW ZEALAND STANDARD - 10A</b> Unshuttered socket AS/NZS 3112		<b>SOUTH AFRICAN STANDARD - 16A</b> Shuttered socket SANS 164-1 (2006)		

## APPLICATION EXAMPLES



## VERSIONS

	One-way adaptors
	2-way adaptors with interlocked-switch socket outlets
	2-way adaptors
	3/5-way adaptors
	3-way adaptors with protection devices
	4-way adaptors



## ■ INTERLOCKED SWITCH SOCKET OUTLETS



## ■ REFERENCE STANDARDS

### EN 60309-1

Plugs, socket outlets and couplers for industrial purposes.  
*Part 1: general requirements.*

### EN 60309-2

Plugs, socket outlets and couplers for industrial purposes.  
*Part 2: dimensional interchangeability requirements for pin and contact-tube accessories of harmonised configurations.*

### EN 60309-4

Plugs, socket-outlets and couplers for industrial purposes.  
*Part 4: switched socket-outlets and connectors with or without interlock.*

## ■ VERSIONS

	Without fuse carrier
	With fuse carrier
	With fuse carrier - HD
	With DIN rail (6 modules)
	With DIN rail (6 modules) - HD

## ■ QUALITY MARKS



## ■ TECHNICAL CHARACTERISTICS

Rated current:	16A-32A-63A
Rated voltage:	100+690V~
Frequency:	c.c. - 50+500Hz
Insulating voltage:	500/690V~
Protection degree:	IP44-IP66/IP67
Operating ambient temperature according to the reference standard:	-25°C +40°C
Max. operating ambient temperature:	60°C
Glow Wire test:	650°C/850°C
Material:	Engineering plastic
IK degree at 20°C:	IK07 (Advance2) IK08 (Advance2-HD)
Cable inlets:	Metric
Fuse-carriers:	gG 10,3x38mm (16-32A) Neozed type D02 (63A)
Colour:	<b>Standard socket</b> Grey RAL 7035 front side and smoke-grey plate <b>Heavy Duty socket</b> Blue RAL 5015 front side and dark-grey RAL 7004 body
Insulation class:	<b>Class II (double insulation)</b> 

## ■ BEHAVIOUR WITH CHEMICAL AND ATMOSPHERIC AGENTS - STANDARD SOCKET

Saline solution	Acids		Bases			Solvents			Mineral oil	UV rays
	Concentrated	Diluted	Concentrated	Diluted	Hexane	Benzol	Acetone	Alcohol		
Resistant	Limited Resistance	Resistant	Limited Resistance	Resistant	Non Resiste	Non Resiste	Non Resiste	Limited Resistance	Limited Resistance	Resistant

## ■ BEHAVIOUR WITH CHEMICAL AND ATMOSPHERIC AGENTS - HD SOCKET

Saline solution	Acids		Bases			Solvents			Mineral oil	UV rays
	Concentrated	Diluted	Concentrated	Diluted	Hexane	Benzol	Acetone	Alcohol		
Resistant	Limited Resistance	Resistant	Limited Resistance	Resistant	Resistant	Limited Resistance	Non Resiste	Resistant	Resistant	Resistant

## ■ WIRING AND INSTALLATION

Wiring capacity of the terminals

Cross-section of the connectable conductors (mm²)

Rated current (A)	Socket outlets	
	Min	Max
16A	1,5	4
32A	2,5	10
63A	6	25

## ■ APPLICATION EXAMPLES



## CABLE INLETS



**Compact version 16A and 32A**  
 1 M25 threaded on upper side  
 2 marks for M20 on lower side  
 1 mark on the back  
 Provided with cable gland M25



**Large version 16A and 32A**  
 1 M25 threaded on upper side  
 3 marks for M20-M32 on lower side  
 1 mark on the back  
 Provided with cable gland M25



**Large version 63A**  
 1 M40 threaded on upper side  
 3 marks for M20-M32 on lower side  
 1 mark on the back  
 Provided with cable gland M40

## TECHNICAL DATA SWITCH DISCONNECTORS

	With fuse			Without fuse		
	16A	32A	63A	16A	32A	63A
Rated insulation voltage <b>Ui</b>	Vac	690	690	690	690	690
	Vdc	600	600	600	600	-
Rated impulse withstand voltage <b>Uimp</b>	kV	4	4	4	4	8
Thermal current <b>Ith</b>	A	25	32	30	40	63
Thermal current <b>Ithe</b>	A	25	32	30	40	63
<b>AC21A</b> Resistive loads, including moderate overloads	400V A	-	-	-	-	-
	500V A	-	-	-	-	-
	690V A	25	32	30	32	63
<b>AC22A</b> Mixed resistive and inductive loads, including moderate overloads	400V A	-	-	-	-	-
	500V A	-	-	-	-	-
	690V A	30	32	20	32	63
<b>AC23A</b> Switching off motor loads or other highly inductive loads (3 phase/3 pole)	400V A	-	-	20	32	50
	500V A	-	-	-	-	40
	690V A	16	25	16	25	30
<b>AC3</b> Squirrel-cage motor: starting, switching off motor during running (3 phase/3 pole)	400V A	-	28.5	-	28.5	40
	500V A	-	-	-	-	-
	690V A	12	20	12	20	25
<b>DC21A</b> Resistive loads, including Moderate overloads	300V A	25	32	25	32	-
	250V A	20	32	20	32	-
	600V A	-	-	10(*)	10(*)	-
<b>DC22A</b> Mixed resistive and inductive loads, including moderate overloads	250V A	400	400	400	400	1500
	600V A	-	-	-	-	-
	Rated short-time withstand current <b>Isw</b> (1s)	kA	10	10	10	10
<b>Short-circuit protection:</b>	Conditional short-circuit current	kA	16	16	16	63
	Associate fuse size for conditional short-circuit current - Type gg	kA	10	10	10	10
	Rated short-circuit making capacity <b>Icm</b>	kA	1500	1500	1500	2850
<b>UL rating</b>	General use single phase and 3 phase	600V A	20	30	32	40
	AC motor starting break all line single phase	120V Hp	1.5	2	1.5	2
		240V Hp	3	5	3	5
		240V Hp	7.5	10	7.5	10
	AC motor B, C, D starting break all lines three phase	480V Hp	10	15	10	15
		600V Hp	15	20	15	20
<b>Permissible wire range</b>	Flexible wire	mm <sup>2</sup>	1.5-10	1.5-10	1.5-10	10-35
		AWG	16-8	16-8	16-8	10-2
	Rigid wire	mm <sup>2</sup>	1.5-16	1.5-16	1.5-16	10-35
	AWG	16-8	16-8	16-8	10-2	

(\*) 2+2 poles in series

IMC approved

UL approved

## ■ INTERLOCKED SWITCH SOCKET OUTLETS



## ■ REFERENCE STANDARDS

### EN 60309-1

Plugs, socket outlets and couplers for industrial purposes.  
*Part 1: general requirements.*

### EN 60309-2

Plugs, socket outlets and couplers for industrial purposes.  
*Part 2: dimensional interchangeability requirements for pin and contact-tube accessories of harmonised configurations.*

## ■ QUALITY MARKS



## ■ VERSIONS

	Version with safety transformer compact (module 106) SELV transformer 230/24V
	Version with safety transformer large (module 136) SELV transformer 230/24V
	Version with RAIL DIN 6 modules compact (module 106)

## ■ TECHNICAL CHARACTERISTICS

Rated current:	16A-32A
Rated voltage:	20+50V ~
Frequency:	c. c. - 50+60Hz
SELV transformer 220/24V:	150VA
Insulating voltage:	500/690V ~
Protection degree:	IP44-IP66/IP67
Operating ambient temperature according to the reference standard:	-25°C +40°C
Max operating ambient temperature:	60°C
Glow Wire test:	650°C/850°C
Material:	Engineering plastic
IK degree at 20°C:	IK07 (Advance2) IK08 (Advance2-HD)
Cable inlets:	Metric
Fuse-carriers:	gG 10:3x38mm
Colour:	<b>Standard socket</b> Grey RAL 7035 front side and smoke-grey plate <b>Heavy duty socket</b> Blue RAL 5015 front side and dark Grey RAL 7004 body
Insulation class:	<b>Class III</b>

## ■ BEHAVIOUR WITH CHEMICAL AND ATMOSPHERIC AGENTS - STANDARD SOCKET

Saline solution	Acids		Bases			Solvents			Mineral oil	UV rays
	Concentrated	Diluted	Concentrated	Diluted	Diluted	Hexane	Benzol	Acetone		
Resistant	Limited Resistance	Resistant	Limited Resistance	Resistant	Resistant	Resistant	Not Resistant	Not Resistant	Limited Resistance	Resistant

## ■ BEHAVIOUR WITH CHEMICAL AND ATMOSPHERIC AGENTS - HD SOCKET

Saline solution	Acids		Bases			Solvents			Mineral oil	UV rays
	Concentrated	Diluted	Concentrated	Diluted	Diluted	Hexane	Benzol	Acetone		
Resistant	Limited Resistance	Resistant	Limited Resistance	Resistant	Resistant	Resistant	Limited Resistance	Not Resistant	Resistant	Resistant

## ■ WIRING AND INSTALLATION

Wiring capacity of the terminals  
Cross-section of the connectable conductors (mm²)

Rated current (A)	Socket outlets	
	Min	Max
16A	4	4
32A	4	10

## ■ PROTECTIONS FOR THE VERSION WITH TRANSFORMER

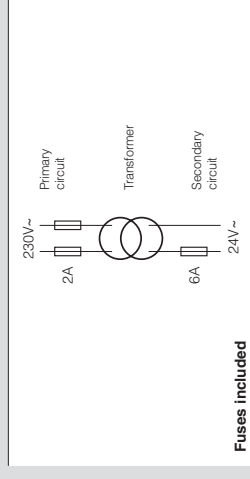

## ■ APPLICATION EXAMPLES





## MODULAR SYSTEM



## REFERENCE STANDARDS

### EN 60670-1

Boxes and enclosures for electrical accessories for household and similar fixed electrical installations. Part 1: general requirements.





### CEI 23-49

Enclosure for accessories for household and similar fixed electrical installations. Part 2: particular requirements for enclosures for protection devices and accessories dissipating a considerable power in normal use.

## QUALITY MARKS



## VERSIONS

	Modular bases - Standard - Heavy duty
	One module enclosure with cut-out - Standard
	Enclosure with plain lid - Standard - Heavy duty
	Consumer unit - Standard - Heavy duty

## TECHNICAL CHARACTERISTICS

Protection degree:	IP66
Operating ambient temperature according to the reference standard:	-25°C +35°C
Max operating ambient temperature:	60°C
Dissipable power according to the reference standard:	8-17W
Glow wire test:	650°C/850°C
Cable inlets:	Metric
Material:	Engineering plastic
IK degree at 20°C:	IK07 (Advance2) IK08 (Advance2-HD)
Colour:	Grey RAL 7035 (standard) Grey RAL 7004 (Heavy duty)
Insulation class:	Class II (double insulation) <input type="checkbox"/>

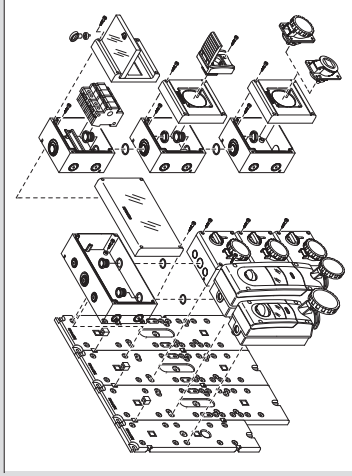

## BEHAVIOUR WITH CHEMICAL AND ATMOSPHERIC AGENTS - STANDARD SYSTEM

Saline solution	Acids		Bases			Solvents			Mineral oil	UV rays
	Concentrated	Diluted	Concentrated	Diluted	Hexane	Benzol	Acetone	Alcohol		
Resistant	Limited Resistance	Resistant	Limited Resistance	Resistant	Not Resistant	Not Resistant	Not Resistant	Limited Resistance	Limited Resistance	Resistant

## BEHAVIOUR WITH CHEMICAL AND ATMOSPHERIC AGENTS - HD SYSTEM

Saline solution	Acids		Bases			Solvents			Mineral oil	UV rays
	Concentrated	Diluted	Concentrated	Diluted	Hexane	Benzol	Acetone	Alcohol		
Resistant	Limited Resistance	Resistant	Limited Resistance	Resistant	Resistant	Limited Resistance	Not Resistant	Resistant	Resistant	Resistant

## APPLICATION EXAMPLES

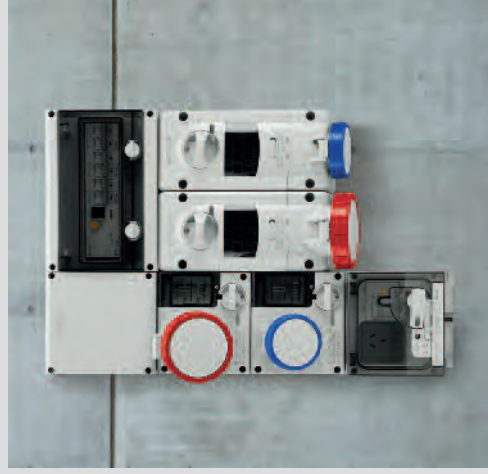



## SWITCHED INTERLOCKED SOCKET OUTLETS 16-32-63A



## REFERENCE STANDARDS

- EN 60309-1**  
Plugs, socket outlets and couplers for industrial purposes.  
*Part 1: general requirements.*
- EN 60309-2**  
Plugs, socket outlets and couplers for industrial purposes.  
*Part 2: dimensional interchangeability requirements for pin and contact-tube accessories of harmonised configurations.*
- EN 60309-4**  
Plugs, socket-outlets and couplers for industrial purposes.  
*Part 4: switched socket-outlets and connectors with or without interlock.*

## VERSIONS WITH MECHANICAL INTERLOCK

- With switch-disconnector
- With switch-disconnector and fuse
- Molded case circuit breaker with thermal magnetic trip unit

## TECHNICAL CHARACTERISTICS

Rated current:	16A-32A-63A
Rated voltage:	100-690V~
Frequency:	50-60Hz
Insulating voltage:	500/690V~
Protection degree:	IP66/IP67/IP69
Operating ambient temperature according to the reference standard:	-25°C +40°C
Minimum operating ambient temperature:	-40°C
Max. operating ambient temperature:	+60°C
Self-extinguishing GW test:	960°C
Self-extinguishing UL94:	V0
Material:	Thermosetting
IK degree at 20°C:	IK10 (20J)
Switch-disconnectors 16A-32A-63A:	COMMAND Series
Fuse:	gG 10,3x38mm gG 22x58mm
Colour:	Grey RAL7037
Insulation class:	Class II (double insulation)

## BEHAVIOUR WITH CHEMICAL AND ATMOSPHERIC AGENTS

Saline solution	Acids		Bases			Solvents			Mineral oil	UV rays
	Concentrated	Diluted	Concentrated	Diluted	Hexane	Benzol	Acetone	Alcohol		
Resistant	Limited Resistance	Resistant	Limited Resistance	Resistant	Resistant	Resistant	Resistant	Resistant	Resistant	Resistant

## CABLE ENTRY

Maximum entry with cable glands

Rated current (A)	Single socket		Socket with switchboard		
	Upper	Lower	Upper	Lower	Side
16A/32A	M32	M32	M32	M32	M32
63A	M40	M40	M40	M40	M32

## WIRING OPERATIONS

Wiring capacity of the terminals (mm²)

Rated current (A)	Socket outlets		
	Min	Max	Max
16A	1,5	4	4
32A	2,5	10	10
63A	6	25	25

## PADLOCK TO BE USED

Choice of padlock for socket knob, fuse door and switchboard door

Rated current (A)	Padlock arc diameter (mm)
16A-32A	5
63A	6,3

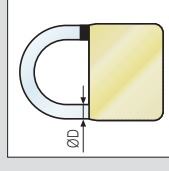

## ■ SPECIAL CHARACTERISTICS

### ADVANCE-GRP CHARACTERISTICS

The **ADVANCE-GRP** product line includes a series of 16A, 32A, 63A, 125A interlocked sockets (compliant with EN60309-4 standards) and the casings to contain them. It's the most complete range of interlocked sockets produced in GRP (*Glass Reinforced Polyester*) thermosetting material.

A unique feature which enhances the exceptional mechanical strength of **ADVANCE-GRP** products is the **SMC** (*Sheet Moulding Compound*) production process used for the casings.

**SMC** is a technology which uses exclusively non-woven sheets, pre-impregnated with polyester resin. This method consists in preparing the sheet material inside a mould which, equipped with a negative mould, presses the composite so as to allow compaction.

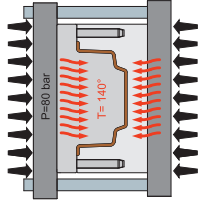
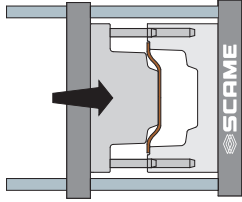
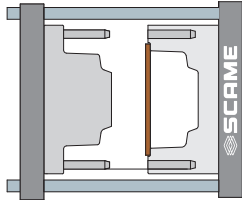

**SMC** is an advanced technology which enhances the quality of the raw material without reducing the high-strength characteristics during transformation; it's a high-performing technology in terms of the mechanical performance of the resultant product (glass fibre length, homogeneity of the material, integrity of the fibres).

On the contrary, the **BMC** (*Bulk Moulding Compound*) technology is a technology for moulding composite materials which uses a raw material available in "blocks" (short, charged fibres) which are subjected to high thermomechanical stress during the transformation process, consequently diminishing the mechanical properties of the details, thereby reducing the impact strength and flexural strength.

The glass-fibre reinforced polyester used in **ADVANCE-GRP** guarantees excellent mechanical strength and a long lifetime: this material is highly resistant to contamination, completely corrosion resistant and suited for applications requiring the use of components with low smoke emission and no halogens, **LSOH** (*Low Smoke Zero Halogen*) components. The outstanding properties of the material are also guaranteed over time, thanks to the high **RTI** value (*Relative Temperature Index*), measured to be 20,000h. Numerous verifications and tests have been carried out, even UV resistance tests, in order to guarantee the long duration of the material's initial performance.

The thickness of the walls is sufficient to offer an excellent alternative to aluminium, stainless steel or cast iron.



### OUTSTANDING HEAT AND FIRE RESISTANCE

The glass-fibre reinforced polyester used in **ADVANCE-GRP** guarantees excellent heat and fire resistance: it does not propagate flames, emit halogens or smoke.

This material has outstanding flame retardancy: Glow Wire 960°C according to EN 60695-2-1; V0 according to UL94. It's suited for applications requiring the use of components with low smoke emission and no halogens, **LSOH** (*Low Smoke Zero Halogen*).

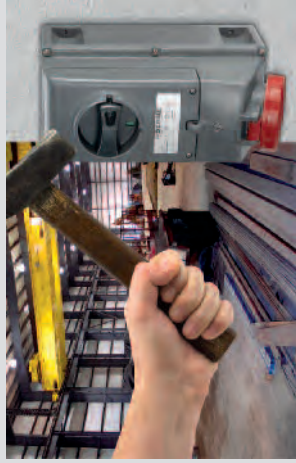

### OUTSTANDING IMPACT RESISTANCE

The glass-fibre reinforced polyester used in **ADVANCE GRP** and the high thickness of the casing walls guarantee an excellent mechanical resistance to impacts.

The **SMC** technology used to produce the casings makes **ADVANCE-GRP** an indestructible product.

The impact resistance of the casings is higher than 20J (IK10) according to EN50102, even under limit temperature conditions (-40°C +60°C).



### RESISTANCE TO CHEMICAL AGENTS

The **ADVANCE-GRP** interlocked sockets and casings, thanks to the glass-fibre reinforced polyester with which they are produced, have excellent resistance to aggressive chemical substances, saline solutions, diluted acids, hydrocarbons, mineral oils, alcoholic substances. They are ideal for use in highly corrosive atmospheres.



### RESISTANCE TO ATMOSPHERIC AGENTS

The structure and materials used also make **ADVANCE-GRP** a product suited for the most extreme environmental conditions. The double degree of protection IP66 and IP67 (IP66 for 125A), guarantees an excellent seal against the entry of solid objects or liquids into the casings.

Outstanding resistance to UV radiation, exceptional reliability under environmental stress and use at both low and high ambient temperatures (-40°C +60°C).





## APPLICATION EXAMPLES

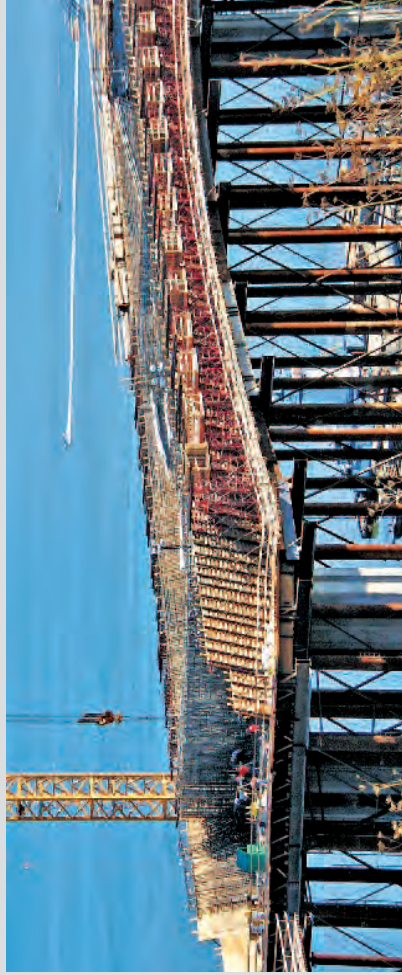

## TECHNICAL DATA SWITCH DISCONNECTORS

	without fuse			with and without fuse	
	16A	32A	63A	125A	125A
Rated insulation voltage <b>Ui</b>	Vac 690 690 690		750	750	
Rated impulse withstand voltage <b>Uimp</b>	Voc 400 400 -		750	750	
Thermal current <b>Ith</b>	kV 4 4 8		12	12	
Thermal current <b>Ithe</b>	A 30 40 63		200	200	
<b>Nominal current rating Ie</b>	Resistive loads, including moderate overloads	415V A	16 32 63	200	
		500V A	16 32 63	-	
		690V A	16 32 63	160	
<b>AC22A</b>	Mixed resistive and inductive loads, including moderate overloads	415V A	16 32 63	200	
		500V A	16 32 63	-	
<b>AC23A</b>	Switching off motor loads or other highly inductive loads (3 phase/3 pole)	415V A	16 32 40	125	
		500V A	16 32 40	-	
<b>AC3</b>	Squirrel-cage motor: starting, switching off motor during running (3 phase/3 pole)	400V A	12 20 25	-	
		690V A	12 20 25	-	
<b>DC21A</b>	Resistive loads, including Moderate overloads	300V A	20(*) 32(*) -	160(*)	
		250V A	25(*) 32(*) -	160(*)	
<b>DC22A</b>	Mixed resistive and inductive loads, including moderate overloads	600V A	10(*) 10(*) -	-	
		400V A	400 400 1500	4000	
Rated short-time withstand current <b>Icw</b> (s)	kAeff 10 10 10		24	24	
Short-circuit protection	Conditional short-circuit current				
	Associate fuse size for conditional short-circuit current - type gG				
Rated current <b>UL</b> without fuse	Rated short-circuit making capacity <b>Icm</b>				
	General applications - Single-phase and Three-phase				
Permissible wire range	AC motor, all-pole interruption - Single-phase				
	AC motor, B, C, D, all-pole interruption - Three-phase				
Flexible wire	mm² 1,5-10 1,5-10 10-35		10-70	10-70	
	AWG 16-8 16-8 10-2		8-1/10	8-1/10	
Rigid wire	mm² 1,5-16 1,5-16 10-35		10-70	10-70	
	AWG 16-8 16-8 10-2		8-1/10	8-1/10	

(\*) 2+2 poles in series

## ■ TECHNICAL CHARACTERISTICS 16A-32A-63A VERSIONS

### WITH FUSES

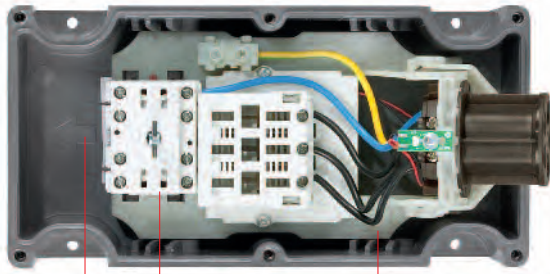

Ample space for easy wiring

Switch-disconnector with mechanical lock that can be accessorized with auxiliary contacts

Easily extractable support



### WITH MCB

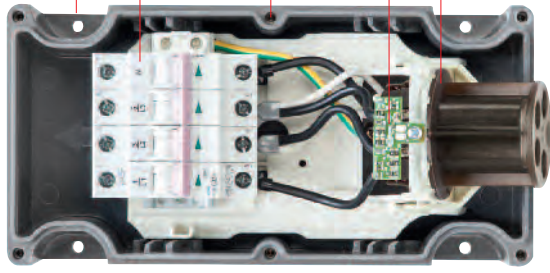

Outdoor wall fastening

Under-plate cable runway

Threaded metal inserts

Indicator light

Possibility for plug-inserted control microswitch assembly

### BOTTOM VIEW

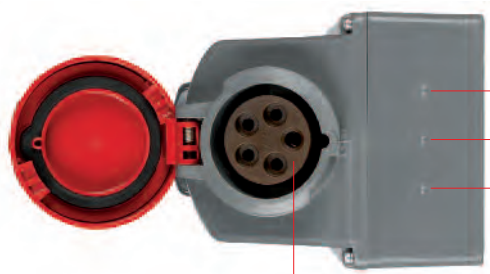

Module in high-temperature resistant engineering polymer

Possible entry from bottom side (input-output also)

### TOP VIEW

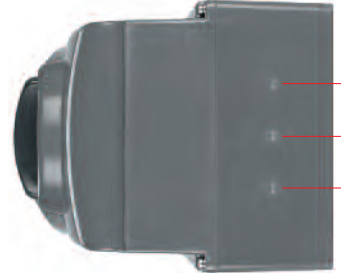

Self-centering punch marks to facilitate drilling

Single-piece waterproof gasket



Dual mechanical lock

High-strength material with superior UV and chemical resistance

Ergonomic knob which can be padlocked in position 0 and 1, manoeuvrable even with gloves

Fuse inspection door, tamper-proof, lockable, with assisted opening

Cover entirely separate from the base for easy installation

Captive stainless steel closing screws

### I-Device

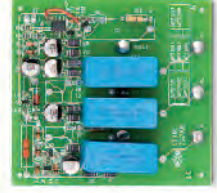

An electronic device controls (Intelligence Device) the status of the interlocked socket, monitoring the electrical functionality:

- operation of the signalling and control card is guaranteed even when the load is not connected;

#### ● INDICATOR LIGHT ON

- indicates that the fuses are not open and all the phases are present;
- indicates that the socket outlet is powered correctly;

#### ☀ INDICATOR LIGHT FLASHING

- signals the interruption of one or more fuses;
- signals the absence of a phase\*;

#### ○ INDICATOR LIGHT OFF

- indicates that the socket outlet is not powered;

\* for single-phase products in the event of phase/neutral loss led signaling appears off.





## ■ SWITCHED INTERLOCKED SOCKET OUTLETS



## ■ REFERENCE STANDARDS

### EN 60309-1

Plugs, socket outlets and couplers for industrial purposes.  
*Part 1: general requirements.*

### EN 60309-2

Plugs, socket outlets and couplers for industrial purposes.  
*Part 2: dimensional interchangeability requirements for pin and contact-tube accessories of harmonised configurations.*

## ■ VERSIONS



Version with transformer.  
SELV transformer 230/24V ~ 150VA



Version without transformer.

## ■ TECHNICAL CHARACTERISTICS

Rated current:	16A-32A
Rated voltage:	20-50V~
Frequency:	50-60Hz
SELV transformer 220/24V:	150VA
Insulating voltage:	500/690V~
Protection degree:	IP66/IP67/IP69
Operating ambient temperature according to the reference standard:	-25°C +40°C
Minimum operating ambient temperature:	-40°C
Max. operating ambient temperature:	+60°C
Self-extinguishing GW test:	850°C (socket housing) 960°C (enclosure)
Material:	Thermosetting
IK degree at 20°C:	IK10
Colour:	Grey RAL7037
Insulation class:	Class III

## ■ BEHAVIOUR WITH CHEMICAL AND ATMOSPHERIC AGENTS

Saline solution	Acids		Bases			Solvents			Mineral oil	UV rays
	Concentrated	Diluted	Concentrated	Diluted	Hexane	Benzol	Acetone	Alcohol		
Resistant	Limited Resistance	Resistant	Limited Resistance	Resistant	Resistant	Resistant	Resistant	Resistant	Resistant	Resistant

## ■ APPLICATION EXAMPLES

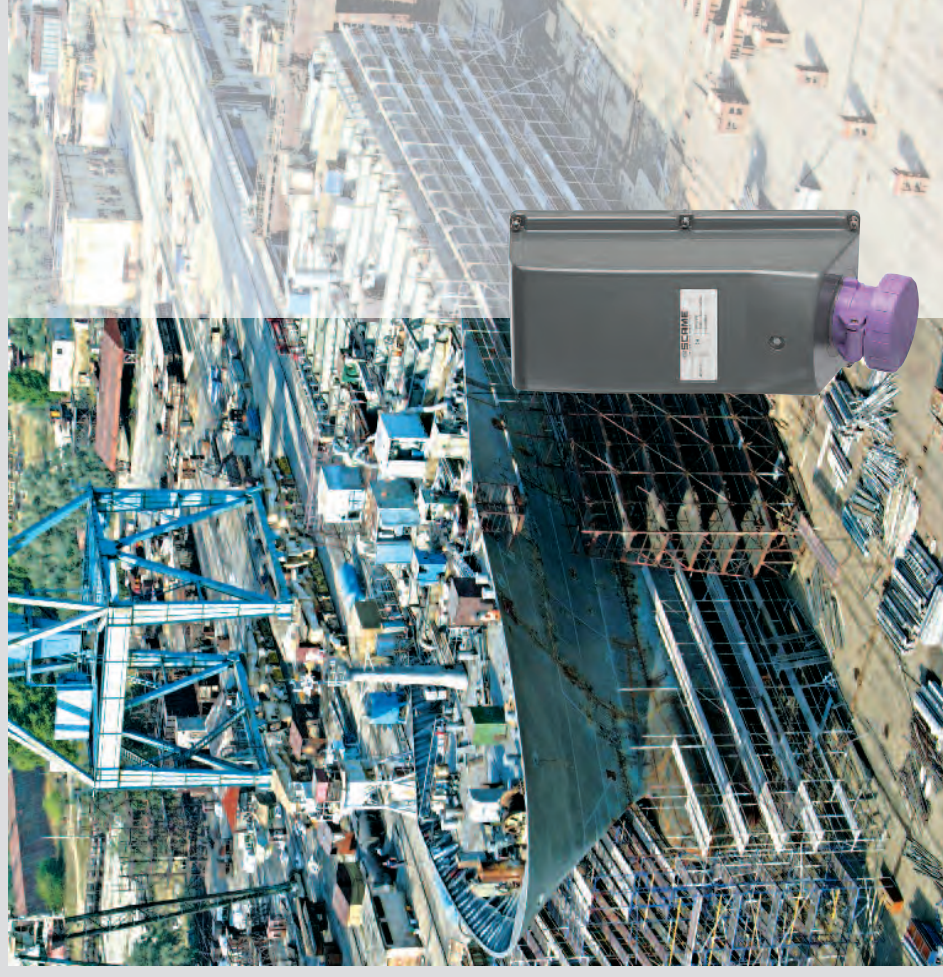

## SWITCHED INTERLOCKED SOCKET OUTLETS 125A



## REFERENCE STANDARDS

### EN 60309-1

Plugs, socket outlets and couplers for industrial purposes.  
*Part 1: general requirements.*

### EN 60309-2

Plugs, socket outlets and couplers for industrial purposes.  
*Part 2: dimensional interchangeability requirements for pin and contact-tube accessories of harmonised configurations.*

### EN 60309-4

Plugs, socket-outlets and couplers for industrial purposes.  
*Part 4: Switched socket-outlets and connectors with or without interlock.*

## VERSIONS WITH MECHANICAL INTERLOCK

	With switch-disconnector
	With switch-disconnector and fuse
	With fuse and switch-disconnector
	With molded case circuit breaker with thermal magnetic trip unit
	With molded case circuit breaker with thermal magnetic and residual current release trip units
	With contactor

## TECHNICAL CHARACTERISTICS

Rated current:	125A
Rated voltage:	100-690V~
Frequency:	50-60Hz
Insulating voltage:	500/690V~
Switched socket outlets with interlock degree of Protection:	IP66
Minimum operating ambient temperature:	-40°C
Maximum operating ambient temperature:	+60°C
Self-extinguishing GW test:	960°C
Self-extinguishing UL94:	V0
Switched socket outlets with interlock material:	Thermosetting
Impact Resistance:	IK10 (20J)
Switch-disconnectors:	Switch ABB OT 160 125A
MCCB:	ABB T-MAX
Fuse:	9G 10.3x38mm 9G 22x58mm 63A 125A
Sockets colour:	Grey RAL7037
Insulation class:	Class II (double insulation)

## BEHAVIOUR WITH CHEMICAL AND ATMOSPHERIC AGENTS

Saline solution	Acids		Bases			Solvents			Mineral oil	UV rays
	Concentrated	Diluted	Concentrated	Diluted	Hexane	Benzol	Acetone	Alcohol		
Resistant	Limited Resistance	Resistant	Limited Resistance	Resistant	Resistant	Resistant	Resistant	Resistant	Resistant	Resistant

## CABLE ENTRY

Maximum entry with cable glands

Rated current (A)	Single socket	
	Upper	Lower
125A	M63	M63

## WIRING OPERATIONS

Wiring capacity of the terminals (mm<sup>2</sup>)

Rated current (A)	Socket outlets		Plugs	
	Min	Max	Min	Max
125A	50	95 (*)	25	50

(\*) In case of flexible cable max 70 mm<sup>2</sup>.

## PADLOCK TO BE USED

Choice of padlock for socket knob, fuse door and switchboard door

Rated current (A)	Padlock are diameter (mm)
125A	6.3

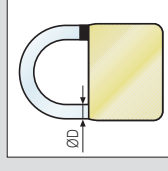

ADVANCE-GRP Series



TECHNICAL CHARACTERISTICS VERSION 425A

WITH FUSES

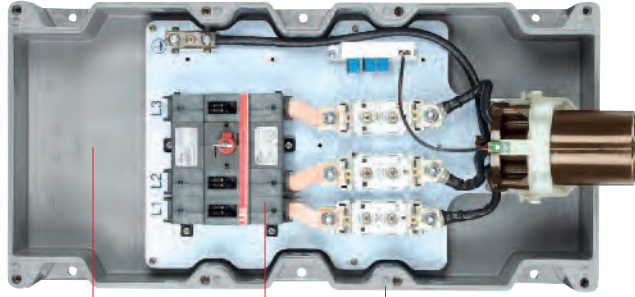

Ample space for easy wiring

Switch-disconnector with mechanical lock that can be accessorized with auxiliary contacts

Punched marks for easy closure of the cover

WITH MCCB + RCD

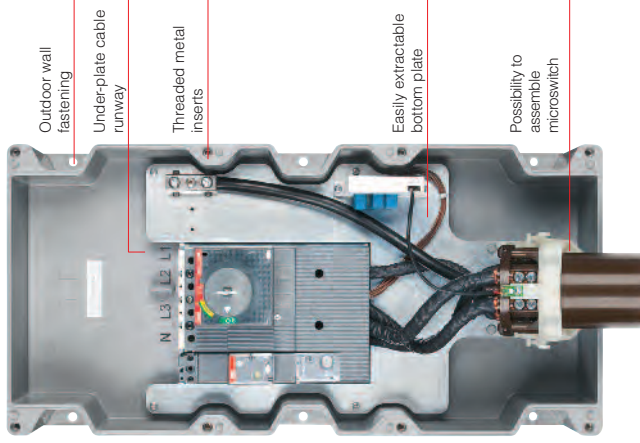

Outdoor wall fastening

Under-plate cable runway

Threaded metal inserts

Easily extractable bottom plate

Possibility to assemble microswitch

BOTTOM VIEW

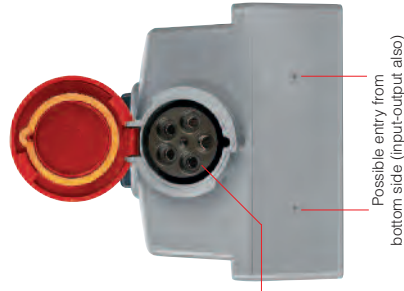

Module in high-temperature resistant engineering polymer

Possible entry from bottom side (input-output also)

TOP VIEW

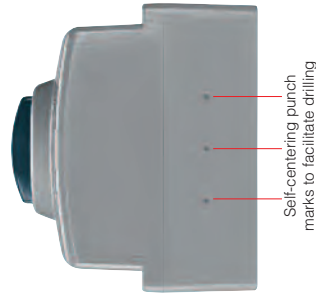

Self-centering punch marks to facilitate drilling

Single-piece waterproof gasket

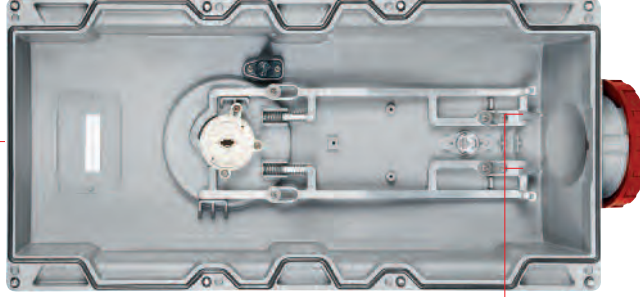

Dual mechanical lock

Rating on metal plate

Captive stainless steel closing screws

Ergonomic knob which can be padlocked in position 0 and 1, manoeuvrable even with gloves

High-strength material with superior UV and chemical resistance

Residual current release trip units test push button

Cover entirely separate from the base for easy installation

Thermal magnetic protection:

**Molded case circuit breaker**  
**ABB Tmax T1B (16kA) with thermal magnetic trip unit TMD (adjustable thermal threshold 0,7...1 x In fixed magnetic threshold 10 x In)**

Thermal-magnetic and residual current protection:  
**Molded case circuit breaker ABB Tmax T1B (16kA) with thermal magnetic trip unit TMD (adjustable thermal threshold 0,7...1 x In fixed magnetic threshold 10 x In) + residual current release trip units RC221/1 (adjustable residual current trip 0,03 - 0,1 - 3A and time limit for non-trip instantaneous)**

Version with contactor:  
**Contactors CL09 GE POWER CONTROL**

I-Device

An electronic device controls (Intelligence Device) the status of the interlocked socket, monitoring the electrical functionality:  
 - operation of the signalling and control card is guaranteed even when the load is not connected;

INDICATOR LIGHT ON

- indicates that the fuses are not open and all the phases are present;
- indicates that the socket outlet is powered correctly;

INDICATOR LIGHT FLASHING

- signals the interruption of one or more fuses;
- signals the absence of a phase\*;

INDICATOR LIGHT OFF

- indicates that the socket outlet is not powered.

\* for single-phase products in the event of phase/neutral loss led signalling appears off.



# ADVANCE-GRP[AMR] System

## ■ AMR SYSTEM

SCAME, always focused on innovation and techno-logical research, has developed a smart system called **AMR SYSTEM** (Automated Meter Reading), to apply to its products. The SCAME products equipped with this smart system are the ADV GRP interlocked sockets and the DOMINO switch panels with two and four sockets.

A smart system features technology through which it is able to control and manage, on its own and in remote, industrial electrical systems aimed at improving the user's service.

In addition to being an effective solution for preventing failures and quickly resolving them, remote management systems are also a valid instrument for cost containment and for system monitoring and control.

This system is equipped with an extremely versatile and accurate energy analyser with microprocessor, designed to meet the needs of the most advanced applications for the monitoring of electrical parameters and for the management of energy consumption, allowing real-time reading via the Internet of all acquisition data and threshold management in automatic mode; moreover, it is possible to send, by e-mail, local alarms pertaining to anomalies or control of the status of manoeuvring switch and inserted plug.

The system is preset for load management. Preventing overload risks is important in order to avoid the tripping of circuit breakers and consequently the resulting malfunction (partial or total power failure), and to significantly reducing energy costs.

In fact, as everyone knows, exceeding certain limits and parameters pertaining to the supply of electricity agreed upon with the grid operator results in the application of penalties or higher rates.

Therefore, it will be possible to automatically disable or reinstate devices or loads connected to the ADV GRP AMR socket.

The various functions include the sending of commands. Commands can be sent to a single socket or to a group of sockets, in both local or remote mode. In the latter case, an Internet connection is required.

Lastly, it allows the Energy Manager to be informed in real time on the condition of the system through any device capable of displaying a web page.

Therefore, the product can be used to diagnose, command, control and manage remote units towards a central server through specific communication protocols. The system consists of one or more sockets and management software.

In order for the two parts to communicate one with the other, a basic communication infrastructure needs to be set up. The communication channels can be RS485, Canbus and wireless. The main carrier is the Wi-Fi.

In case the Wi-Fi connection is not working, the **AMR SYSTEM** can store processing reports in a circular buffer for over a month. Once communication is restored, it sends the stored data to the management software.

The system fitted to the GRP and DOMINO sockets is suited for applications on all kinds of electric grids, 3 and 4-wire three-phase, single-phase, low and medium voltage.

All operating parameters can be set through the software, including the input and output, the alarms, the Canbus/RS485 port.

The digital input is typically used as a status indicator for inserted plug and as an ON/OFF manoeuvre selector, as well as for earth presence signalling purposes.

## ■ DATA ACQUISITION AND MONITORING FROM A SINGLE POINT

The AMR system allows the management and monitoring of loads from a single "socket" point, ensuring the highest functionality, reliability and operating potential, in addition to simplifying installation.

In this case, the interlocked socket carries out a "multi-service", supplying electricity for proper operation to the connected load, at the same time performing monitoring and management functions.

This is a huge advantage in terms of installation costs and times. All energy-related data can be detected using a single card

- The card is located inside the socket
- No wiring required. Significant savings as far as time and materials are concerned.
- Accuracy class: 1% current/voltage, 1.5% power/energy
- Local and remote control with alarm and/or signalling of manoeuvre status and inserted plug

- Control with the signalling of anomalies and system status on the socket through a warning light
- Warning light on the socket for no earth
- Through the socket, the SCAME system can monitor refrigerated containers; however it is not designed for controlling the temperature inside the containers
- The SCAME system does not carry out checks other than electricity-related ones.

The products fitted with the AMR system (from the acronym **AMR "automated meter reading"**) feature advanced technology.

Through the AMR system, you can analyse the power grid for current and power consumption, as well as read all acquisition data in real time via the Internet;

## ■ PRODUCT RANGE – AMR SYSTEM



**ADVANCE-GRP Series**



**DOMINO Series**



**OMNIA Series**

### Available functions

- Socket monitoring
- Monitoring of consumption
- Fuse check
- Internal temperature
- Plug presence
- Earth presence
- Energy management
- Data collection
- Graphs
- Alarms
- Reports
- Remote control
- Load management
- Notifications by e-mail
- Text messages (optional)



- ALARM
- E-MAIL
- ENERGY MANAGER

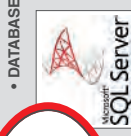

- ENERGY METER



## ■ SHIPYARD

Application	Decision maker	Product type	Problems	Suggested solution	Benefits
Worksite driving force units	Maintenance Manager	Groups of interlocked sockets	Long maintenance jobs and downtimes	I/O AMR system	Targeted management and scheduling of maintenance jobs, with consequent reduction of maintenance times and costs
External companies' equipment	Energy Manager	Groups of interlocked sockets	Waste due to improper use and management of the power supply	EM AMR system with relay outputs	Possibility for exact control of the consumptions of the individual sockets matched to the container or to external companies' equipment and possibility to manage and turn off unnecessary power supplies
Suction and lighting system in a water basin	Systems Manager	Power supply sockets or plugs to the equipment	Both suction and temporary lighting systems stay turned on even when no one is operating on board	I/O AMR system with relay output	The Manager is guaranteed that this type of equipment with high consumption work only when truly necessary, so as to be able to manage their proper operation in remote as well.

## ■ SHIPYARD APPLICATION

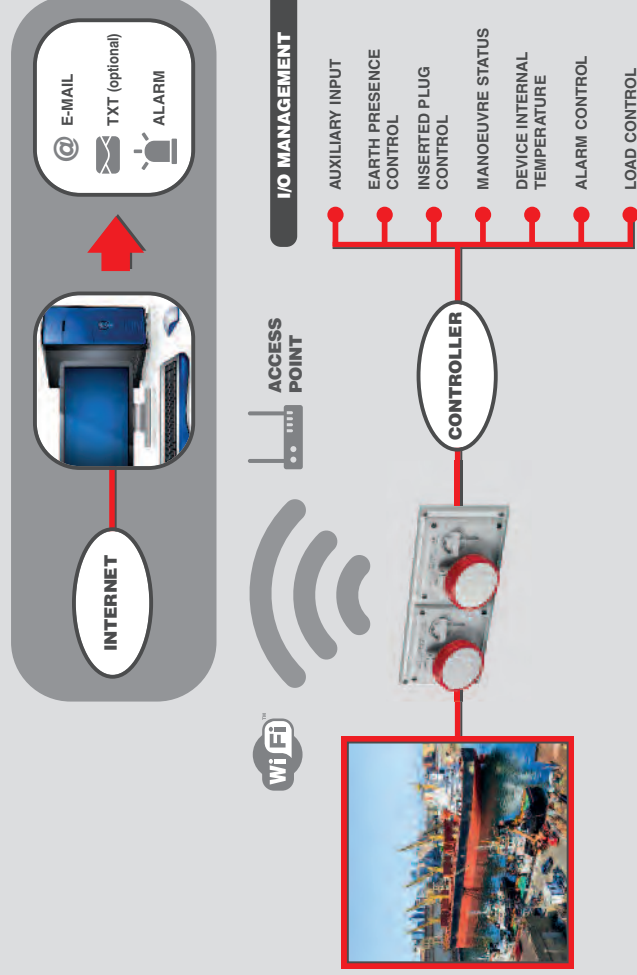

## ■ INDUSTRY

Application	Decision maker	Product type	Problems	Suggested solution	Benefits
Worksite driving force units	Maintenance Manager	Groups of interlocked sockets	Long maintenance jobs and downtimes	AMR system I/O	Targeted management and scheduling of maintenance jobs, with consequent reduction of maintenance times and costs
Large machinery and production plants	Energy Manager	Interlocked sockets	Uncontrolled machinery consumption and failure to check for proper operation of the loads (machinery) connected to the interlocked sockets	AMR system EM	Possibility for exact control over energy consumption and Efficiency, as well as checking the consumption log
Process management	Methods Manager	Interlocked sockets	Poor machinery utilisation management and poor work distribution	AMR system EM	The Methods Manager can check the absorption/ utilisation of the machinery in order to make the production processes more efficient

## ■ INDUSTRY APPLICATION

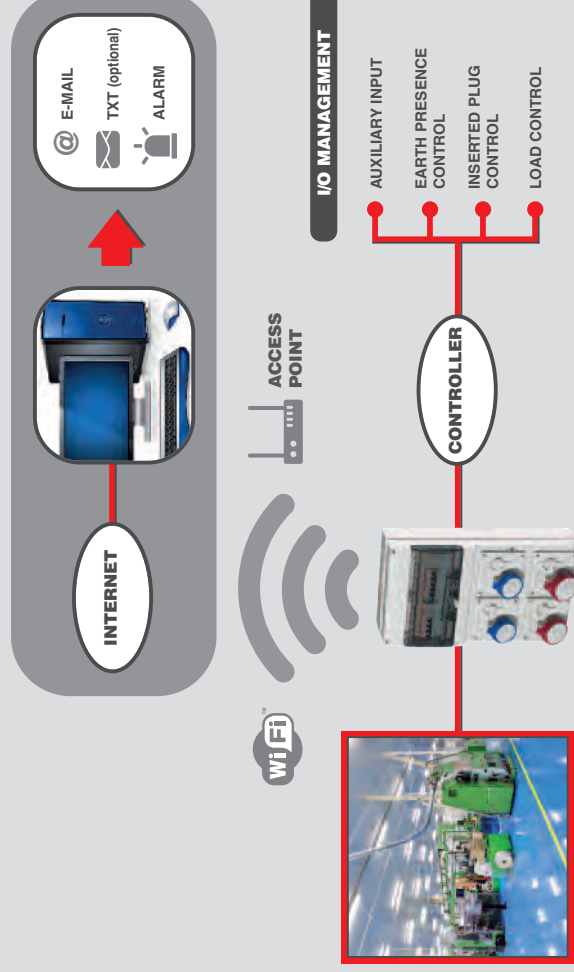

## LOAD MANAGEMENT AND REMOTE CONTROLS

The system is pre-set for load management. Preventing overload risks is important in order to avoid the tripping of circuit breakers and consequently the resulting malfunction (partial or total power failure), and to significantly reduce energy costs.

In fact, as everyone knows, exceeding certain limits and parameters pertaining to the supply of electricity agreed upon with the grid operator results in the application of penalties or higher rates.

Therefore, it will be possible to automatically disable or reinstate devices or loads connected to the ADV GRP AMR socket. The various functions include the sending of commands. Commands can be sent to a single socket or to a group of sockets, in local or remote mode. In the latter case, an Internet connection is required.



## CALENDAR FUNCTION

Through the calendar function, the user can program certain rules to activate/deactivate at an established date and time.

For example, deactivating the load connected to the socket, setting the day and time.

## EXAMPLE

The example below shows an application in which the load applied to the socket is a motor. In case the AMR control and monitoring system detects a malfunction of the motor or the

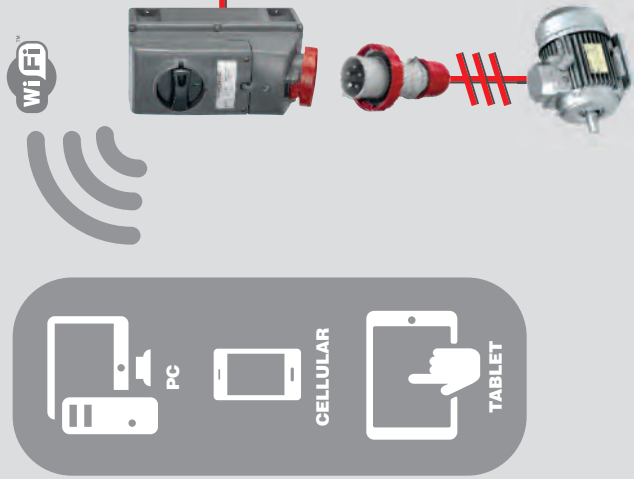

### AUXILIARIES

- LIGHTS
- MOTOR
- SIREN

## EXAMPLE: CONTROL OF LOAD CONNECTED TO THE SOCKET

With this installation, the motor can be piloted by the socket through the contact output (NO/NC) of the AMR system which, in turn, pilots an external relay to which the motor is connected.

This way, the motor can be deactivated/activated depending on special events that have occurred, such as alarms, failures or simply to cut down on electricity consumption.

Moreover, this configuration allows the user to interact with the socket, activating/deactivating the motor in local or remote mode (through the web).

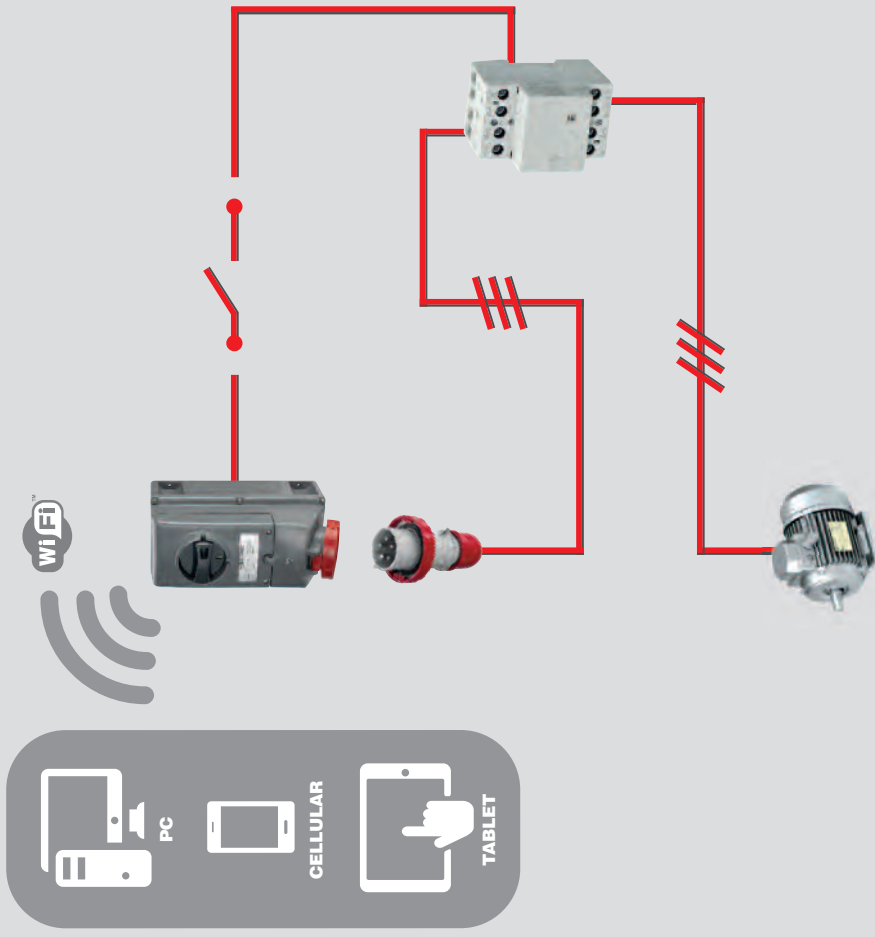



## ■ JUNCTION BOXES FOR ELECTRICAL INSTALLATIONS

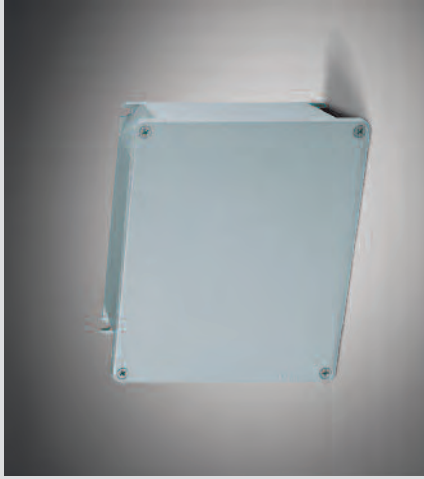

## ■ REFERENCE STANDARDS

### EN 60670-22

Boxes and enclosures for electrical accessories for household and similar fixed electrical installations. Part 22: particular requirements for connecting boxes and enclosures.

## ■ QUALITY MARKS



## ■ VERSIONS

	Enclosure IP66
	Mounting plates
	DIN rail kit (horizontal and diagonal fixing)

## ■ TECHNICAL CHARACTERISTICS

Protection degree:	<b>IP66/67</b>
Operating ambient temperature according to the reference standard:	<b>-25°C +60°C</b>
Max. operating ambient temperature (Short period):	<b>-40°C +90°C</b>
Material:	<b>Aluminium alloy</b>
IK degree at 20°C:	<b>IK08</b>
Cable inlets:	<b>Blank sides</b>
DIN rail fixing	<b>Yes</b>
Colour:	<b>Grey RAL 9006 with metallic pigments</b>
Heavy duty appliance for internal industrial applications.	

## ■ BEHAVIOUR WITH CHEMICAL AND ATMOSPHERIC AGENTS

Saline solution	Acids		Bases			Solvents			Mineral oil	UV rays
	Concentrated	Diluted	Concentrated	Diluted	Hexane	Benzol	Acetone	Alcohol		
Resistant	Limited Resistance	Resistant	Limited Resistance	Resistant	Limited Resistance	Limited Resistance	Limited Resistance	Resistant	Resistant	Resistant



## ■ APPLICATION EXAMPLES





## ■ CABLE REELS WITH AUTOMATIC REWIND



## ■ REFERENCE STANDARDS

**EN 61242**  
Electrical accessories.  
Cable reels for household  
and similar purposes.

## ■ BEHAVIOUR WITH CHEMICAL AND ATMOSPHERIC AGENTS

Saline solution	Acids		Bases			Solvents			Mineral oil	UV rays
	Concentrated	Diluted	Concentrated	Diluted	Hexane	Benzol	Acetone	Alcohol		
Resistant	Not Resistant	Not Resistant	Limited Resistance	Resistant	Not Resistant	Not Resistant	Not Resistant	Limited Resistance	Resistant	Resistant

## ■ VERSIONS

	Cable reel without plug and connector - IP41
	Cable reel with domestic plug and trailing socket for domestic application - IP40
	Cable reel with plug and portable lamp - IP20
	Cable reel with plug and portable lamp - IP40

## ■ TECHNICAL CHARACTERISTICS

Rated current:	2,5A-4A-6A-10A
Rated voltage:	12±24V ~ - 230V ~
Frequency:	50Hz
Insulating voltage:	250V ~
SELV transformer 220/24V:	60W
Protection degree:	IP20-IP40-IP41
Operating ambient temperature according to the reference standard:	-25°C +40°C
Max operating ambient temperature:	60°C
Glow wire test:	650°C/850°C
Material:	Tecnopolimero
IK degree at 20°C:	IK08
Max load wound:	2300W
Cable:	H07RN-F (cable reel with plug and portable lamp) H05VV-F

## ■ APPLICATION EXAMPLES



**Portable lamp:** handle made of non-hygroscopic insulating material, conforms to EN 60598-2-8 and all live parts are completely insulated. There is a hooking eye on the AUTOROLLER for hanging up the lamp when it is not in use.



**Wall mounting bracket:** allows the Autoroller to be secured onto any vertical surface. There is housing for the safety transformer and two cable clamps are fitted onto the rear of the bracket. When correctly installed, the bracket allows the unit to swivel 310° in the direction of the cable pull.

## AUTOROLLER Series

### ■ STRUCTURAL CHARACTERISTICS

- 1 - Wall mounting bracket**  
Made of an engineering plastic, it is designed to hold the cable reel and allow it to swivel through 310°.
- 2 - Automatic rewind unit**  
A sturdy casing made of engineering plastic contains the automatic cable rewind device, which is made up of a high-strength spring.
- Electrical continuity is maintained at all times by means of an integral slip-ring configuration (rated at 10 A). Two rollers located at the cable outlet ensure kink-free rewinding.
- 3 - Transformer (SELV)**  
An isolating transformer can be fitted on the wall bracket.

A luminous two-pole switch connected to the primary winding indicates ON/OFF status, while a fuse on the secondary winding protects the transformer against overcurrents.

**4 - Cable**  
Cable lengths up to 16 m can be wound onto the drum. Problem-free winding of both PVC and rubber cables is assured.

**5 - Power supply**  
Power can be supplied either through the rewind unit or through the reeling cable. Factory-wired units supplied by Scame come equipped with a plug connected to the drum casing by a cable, and with a connector or a portable lamp connected to the reeling cable.

### ■ INSTRUCTIONS FOR USE

The cable coiler is equipped with a spring for cable winding. This mechanical device is constantly in operation; therefore make sure that both during winding and unwinding the cable is accompanied during its movement and NEVER left free.

If used on an automatic machine, appropriate guards shall be installed in order to prevent any damage to persons or things in the event of any cable or spring breakage.

The cable coiler is provided with cable blocking device at every turn of the coil.

When working with cable unwound and ratchet stop on, make sure that the cable is not accidentally touched (the catch may be released and the cable may wind up uncontrolledly).

### ■ CABLE REEL WITH TRANSFORMER

The transformer has a power of 60 Watt, protected through circuit breakers against short circuits and overloads due to the use of bulbs with power above 60 Watt.

In case of overload, the circuit breaker breaks the circuit; before connecting it again wait a moment to allow the cooling of the circuit breaker and then press the button A for 12 Volt running and the button B for 24 Volt.

For changing power it is necessary to disconnect the current supply unscrewing the screw F and then connecting the G wire to the junction-box of requested power.

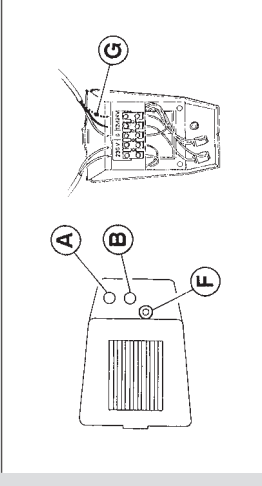

### CABLING NOTES

The versions supplied without connector and plug may be cabled directly to the appliances: correct installation requires a cable clamp capable of withstanding the pull forces and a cable sleeve to protect the cable from abrasion.

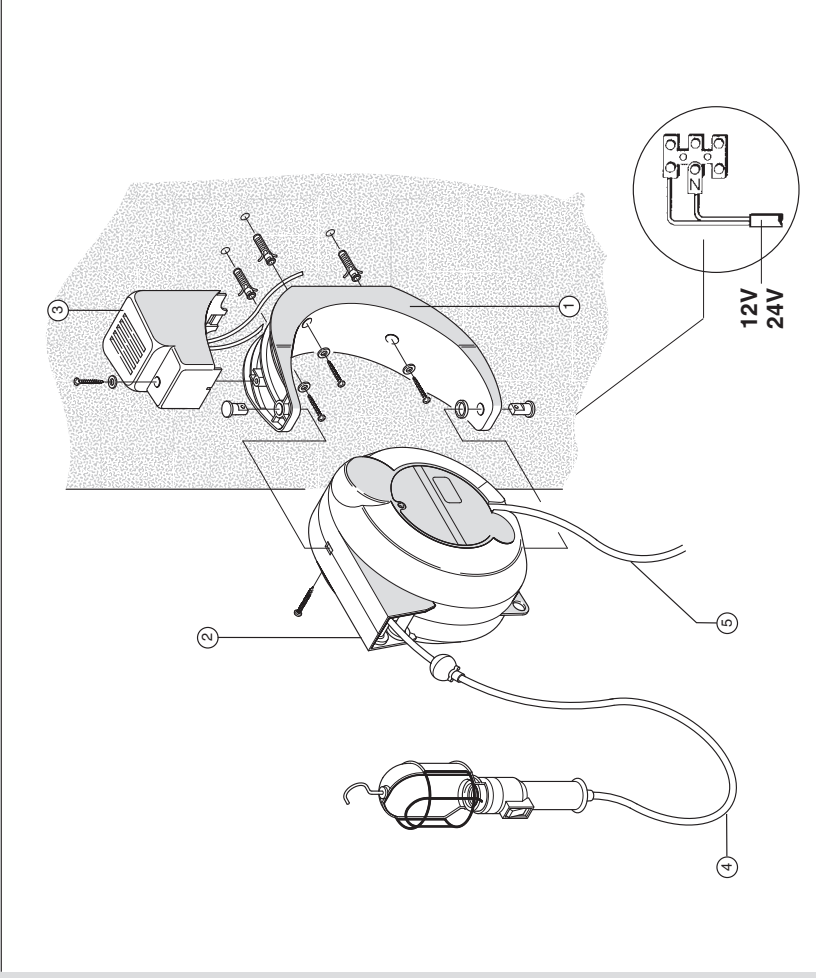

## ■ DOMESTIC PLUGS, SOCKETS AND MULTI-OUTLET SOCKETS



## ■ REFERENCE STANDARDS

### CEI 23-50

Socket-outlets for household and similar purposes.  
Part 1: general requirements.

## ■ QUALITY MARKS



## ■ VERSIONS



Plugs with straight outlet



Flat plugs with angled outlet



Trailing socket with straight outlet

## ■ TECHNICAL CHARACTERISTICS

Rated current:	10A-16A
Rated voltage:	250V ~
Frequency:	50Hz
Insulating voltage:	250V ~
Protection degree:	IP20D
Operating ambient temperature according to the reference standard:	-15°C +35°C
Max operating ambient temperature:	60°C
Cabling capacity of the terminals:	10A: 0,75 - 1,5mm <sup>2</sup> 16A: 0,75 - 2,5mm <sup>2</sup>
Glow wire test:	750°C
Halogen free:	Yes
Material:	Engineering plastic
Colour:	White RAL 9010 Black RAL 9011

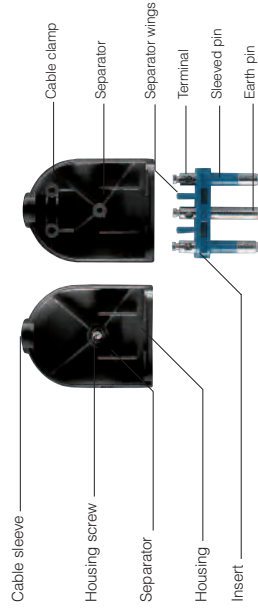

Cable sleeve  
Housing screw  
Separator  
Housing  
Insert  
Cable clamp  
Separator  
Separator wings  
Terminal  
Sleeved pin  
Earth pin

## ■ BEHAVIOUR WITH CHEMICAL AND ATMOSPHERIC AGENTS

Saline solution	Acids		Bases			Solvents			Mineral oil	UV rays
	Concentrated	Diluted	Concentrated	Diluted	Hexane	Benzol	Acetone	Alcohol		
Resistant	Limited Resistance	Resistant	Limited Resistance	Limited Resistance	Resistant	Not Resistant	Not Resistant	Resistant	Limited Resistance	Resistant

## ■ APPLICATION EXAMPLES





■ DOMESTIC ADAPTORS



■ REFERENCE STANDARDS

**CEI 23-57**  
Plugs and sockets for domestic and similar applications.  
*Part 2: specific requirements for adaptors.*



■ QUALITY MARKS



■ VERSIONS



One-way adaptors



Multi-way adaptors

■ TECHNICAL CHARACTERISTICS

Rated current:	10A-16A
Rated voltage:	250V~
Frequency:	50Hz
Insulating voltage:	250V~
Protection degree:	IP20D
Operating ambient temperature according to the reference standard:	-15°C +35°C
Max operating ambient temperature:	60°C
Glow wire test:	750°C
Halogen free:	Yes
Material:	Engineering plastic
Colour:	White RAL 9010 Black RAL 9011

■ BEHAVIOUR WITH CHEMICAL AND ATMOSPHERIC AGENTS

Saline solution	Acids		Bases		Solvents			Mineral oil	UV rays
	Concentrated	Diluted	Concentrated	Diluted	Hexane	Benzol	Acetone		
Resistant	Limited Resistance	Resistant	Limited Resistance	Limited Resistance	Resistant	Not Resistant	Not Resistant	Limited Resistance	Resistant

■ APPLICATION EXAMPLES



## ■ EMPTY DISTRIBUTION ASSEMBLIES

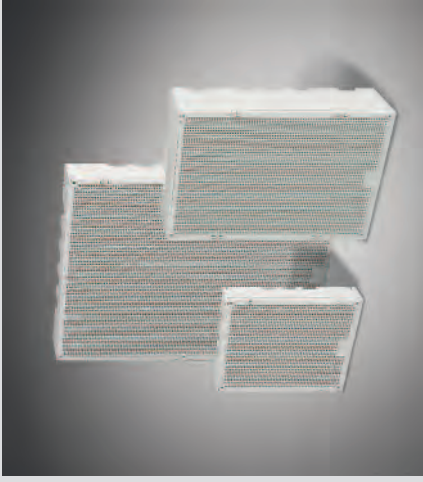

## ■ REFERENCE STANDARDS

### EN 60670-1

Boxes and enclosures for electrical accessories for household and similar fixed electrical installations.  
*Part 1: general requirements.*

## ■ BEHAVIOUR WITH CHEMICAL AND ATMOSPHERIC AGENTS

Saline solution	Acids		Bases		Solvents			Mineral oil	UV rays
	Concentrated	Diluted	Concentrated	Diluted	Hexane	Benzol	Acetone		
Resistant	Limited Resistance	Resistant	Resistant	Resistant	Resistant	Not Resistant	Not Resistant	Limited Resistance	Resistant

## ■ QUALITY MARKS



## ■ APPLICATION EXAMPLES



## ■ VERSIONS

	1 module
	2 module
	4 module

## ■ TECHNICAL CHARACTERISTICS

Protection degree:	IP41
Operating ambient temperature according to the reference standard:	-15°C +35°C
Max. operating ambient temperature	60°C
Glow Wire test:	650°C
Material:	Engineering plastic
IK degree at 20°C:	IK08
Insulation class:	Class II (double insulation) <input type="checkbox"/>
Halogen free:	Yes
Colour:	Grey RAL 7035

## ■ DISTRIBUTION ASSEMBLIES



## ■ REFERENCE STANDARDS

### EN 62208

Empty enclosure for low-voltage switchgear and controlgear assemblies.  
*Part 1: general requirements.*

### EN 60670-24

Boxes and enclosures for electrical accessories for household and similar fixed electrical installations.  
*Part 24: particular requirements for enclosures for housing protective devices and other power dissipating electrical equipment.*

### EN 61439-3

Low-voltage switchgear and controlgear assemblies.  
*Part 3: distribution boards intended to be operated by ordinary persons (DBO).*

### EN 61439-4

Low-voltage switchgear and controlgear assemblies.  
*Part 4: particular requirements for assemblies for construction sites (ACS)*

### EN 60670-1

Boxes and enclosures for electrical accessories for household and similar fixed electrical installations.  
*Part 1: general requirements.*

### CEI 23-49

Enclosure for accessories for household and similar fixed electrical installations.  
*Part 2: particular requirements for enclosures for protection devices and accessories dissipating a considerable power in normal use.*

## ■ VERSIONS



BLOCK1 (110x280x95mm)  
- Portable or surface mounting empty units.



BLOCK3 (136x440x114mm)  
- Surface mounting  
- Panel mounting  
- Mobile on appropriate stand  
- Portable with cable and plug



BLOCK4 (212x415x114mm)  
- Surface mounting  
- Panel mounting  
- Mobile on appropriate stand  
- Portable with cable and plug



BLOCK5 (272x414x110mm)  
- Portable or surface mounting empty units.

## ■ BEHAVIOUR WITH CHEMICAL AND ATMOSPHERIC AGENTS

Saline solution	Acids		Bases			Solvents			Mineral oil	UV rays
	Concentrated	Diluted	Concentrated	Diluted	Hexane	Benzol	Acetone	Alcohol		
Resistant	Limited Resistance	Resistant	Limited Resistance	Resistant	Not Resistant	Not Resistant	Not Resistant	Limited Resistance	Resistant	Resistant



BLOCK3 Series



BLOCK4: built-in foldaway handle.



BLOCK4: Metal stand.

## ■ TECHNICAL CHARACTERISTICS

Rated current:	IP44-IP66
Operating ambient temperature according to the reference standard:	-25 °C +35 °C
Max. operating ambient temperature:	60 °C
Glow Wire test:	650 °C
Material:	Engineering plastic
IK degree at 20 °C:	IK08
Cable inlet:	PG13,5 - PG21
Insulation class:	Class II (double insulation) <input type="checkbox"/>
Dissipable power according to CEI 23-49 standard:	8-15W
Colour:	Grey RAL 7035

## ■ QUALITY MARKS





## ■ DOMESTIC PLUGS, SOCKET AND MULTI-OUTLET SOCKETS



## ■ REFERENCE STANDARDS

### CEI 23-50

Plugs and socket outlets for household and similar purposes.  
*Part 1: general requirements.*

### CEI 23-124

Plugs and socket outlets for household and similar purposes.  
*Part 2-7: particular requirements for cord extension set.*

## ■ QUALITY MARKS



## ■ VERSIONS

	Plugs with straight outlet
	Flat plugs with angle outlet
	Trailing socket with straight outlet
	Multi-outlet sockets

## ■ TECHNICAL CHARACTERISTICS

Rated current:	10A-16A
Rated voltage:	250V~
Frequency:	50Hz
Insulating voltage:	250V~
Protection degree:	IP20D
Operating ambient temperature according to the reference standard:	-15°C +35°C
Max operating ambient temperature:	60°C
Cabling capacity of the terminals:	10A: 0,75 - 1,5mm <sup>2</sup> 16A: 0,75 - 2,5mm <sup>2</sup>
Glow wire test:	750°C
Material:	Engineering plastic
Colour:	White RAL 9010 Black RAL 9011 Anthracite RAL 7021 Tinted (transparent) Turquoise (transparent)

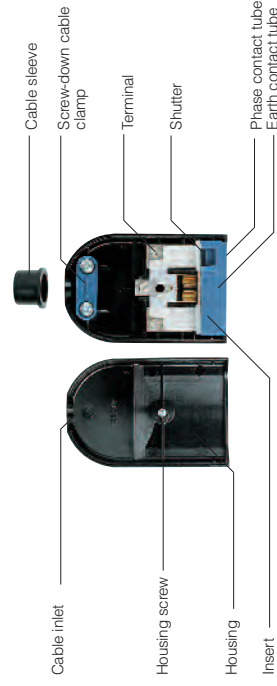

## ■ BEHAVIOUR WITH CHEMICAL AND ATMOSPHERIC AGENTS

Saline solution	Acids		Bases			Solvents			Mineral oil	UV rays
	Concentrated	Diluted	Concentrated	Diluted	Hexane	Benzol	Acetone	Alcohol		
Resistant	Limited Resistance	Resistant	Limited Resistance	Limited Resistance	Resistant	Not Resistant	Not Resistant	Resistant	Limited Resistance	Resistant

## ■ APPLICATION EXAMPLES

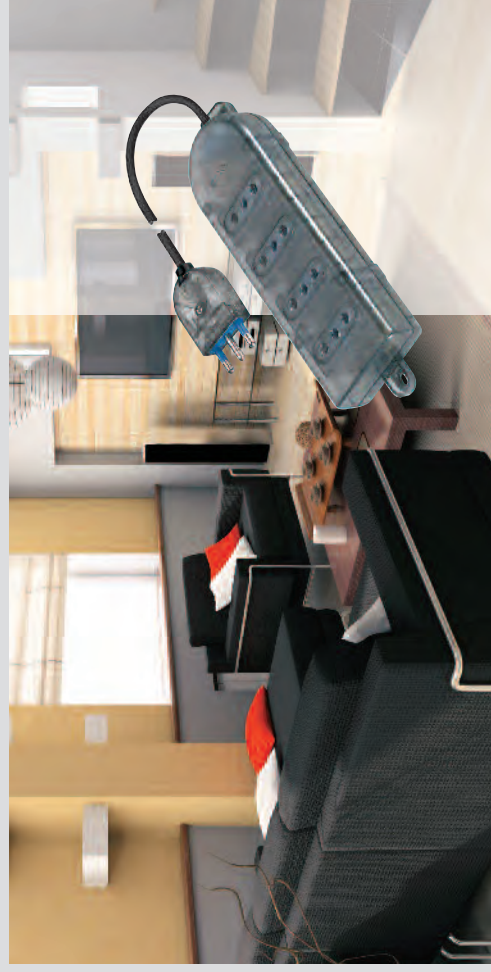

■ DOMESTIC ADAPTORS



■ REFERENCE STANDARDS

**CEI 23-57**  
Plugs and sockets for domestic and similar applications.  
*Part 2: specific requirements for adaptors.*

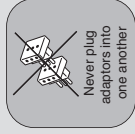

■ QUALITY MARKS

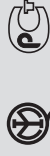

■ BEHAVIOUR WITH CHEMICAL AND ATMOSPHERIC AGENTS

Saline solution	Acids		Bases		Solvents			Mineral oil	UV rays
	Concentrated	Diluted	Concentrated	Diluted	Hexane	Benzol	Acetone		
Resistant	Limited Resistance	Resistant	Limited Resistance	Limited Resistance	Resistant	Not Resistant	Not Resistant	Limited Resistance	Resistant

■ APPLICATION EXAMPLES



■ VERSIONS

	One-way adaptors
	Multi-way adaptors
	With USB

■ TECHNICAL CHARACTERISTICS

Rated current:	10A-16A
Rated voltage:	250V~
Frequency:	50Hz
Insulating voltage:	250V~
Protection degree:	IP20D
Operating ambient temperature according to the reference standard:	-15°C +35°C
Max operating ambient temperature:	60°C
Glow wire test:	750°C
Halogen free:	Yes
Material:	Engineering plastic
Colour:	White RAL 9010 Black RAL 9011

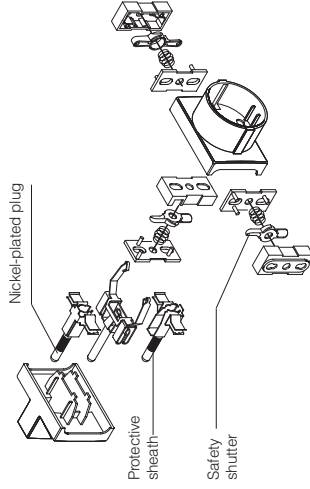



## ■ DOMESTIC ADAPTORS AND MULTI-OUTLET SOCKETS WITH OVERVOLTAGE PROTECTION



### ■ VERSIONS



Single adaptor socket with special device to protect against voltage overload in the electrical supply



Multi-outlet sockets with lighting protection

Lightning protection devices are fitted with an overload dissipater, a special electric circuit protected by a phase and neutral fast fuse protection having nominal tension of 250V~. Maximum dissipation of overload energy: 21J. Minimum overload tension at which dissipation is triggered off: 300V.

Discharge current: 1,2 kA (8/20µs).  
When the pilot light is on it means that the overload dissipater is working efficiently.

### ■ REFERENCE STANDARDS

#### CEI 23-50

Plugs and sockets-outlets for household and similar purposes.  
*Part 1: general requirements*

#### CEI 23-57

Plugs and sockets for domestic and similar applications.  
*Part 2: specific requirements for adaptors.*



### ■ QUALITY MARKS



### ■ TECHNICAL CHARACTERISTICS

Rated current:	10A-16A
Rated voltage:	250V~
Frequency:	50Hz
Insulating voltage:	250V~
Protection degree:	IP20D
Operating ambient temperature according to the reference standard:	-15°C +35°C
Max. operating ambient temperature:	60°C
Glow Wire test:	750°C
Material:	Engineering plastic
Colour:	White RAL 9010 Tinted (transparent) Turquoise blue (transparent)

### ■ BEHAVIOUR WITH CHEMICAL AND ATMOSPHERIC AGENTS

Saline solution	Acids		Bases			Solvents			Mineral oil	UV rays
	Concentrated	Diluted	Concentrated	Diluted	Hexane	Benzol	Acetone	Alcohol		
Resistant	Limited Resistance	Resistant	Limited Resistance	Limited Resistance	Resistant	Not Resistant	Not Resistant	Resistant	Limited Resistance	Resistant

### ■ APPLICATION EXAMPLES



## SWITCH DISCONNECTORS - 16A-160A



## REFERENCE STANDARDS

### EN 60947-3

Low voltage switchgear and controlgear.  
Part 3: switches, disconnectors, switch-disconnectors and fuse-combination unit.

### UL 508







Industrial control equipment.

## QUALITY MARKS



For specific quality marks please contact our technical service.

## VERSIONS

	Switch size Y1 Rear panel version (R) Rear panel mounting screws fixing
	Switch size Y2 Rear panel version (R) Rear panel mounting screws fixing
	Switch size Y1 Box version (B) Base mounting DIN rail fixing
	Switch size Y2 Box version (B) Base mounting DIN rail fixing
	Switch size Y3 Box version (B) Base mounting DIN rail fixing or screws fixing
	Switch size Y4 Box version (B) Base mounting DIN rail fixing or screws fixing
	Switch size Y5 Box version (B) Base mounting DIN rail fixing or screws fixing

## TECHNICAL CHARACTERISTICS 2P, 3P, 3P+N, 4P

Switch size	Y1					Y2					Y4					Y5									
	16A	20A	32A	40A	63A	80A	100A	125A	160A	160A	160A	160A	160A	160A	160A	160A	160A	160A	160A	160A	160A	160A	160A	160A	
Rated current In																									
Rated insulation voltage	Ui																								
Rated impulse withstand voltage	Uimp																								
Thermal current	Ith/Ithe																								
Resistive loads, including moderate overloads	AC21A																								
	415V																								
	A 30 30 40 40 63 86 100 125 160																								
	500V																								
	A 16 20 32 32 63 80 100 125 160																								
Mixed resistive and inductive loads, including moderate overloads	AC22A																								
	415V																								
	A 16 20 32 40 63 80 100 125 160																								
	500V																								
	A 16 20 32 32 63 80 100 125 160																								
Switching of motor loads or other highly inductive loads (3 phase / 3 pole)	AC23A																								
	415V																								
	A 16 20 32 35 63 67 100 125 160																								
	500V																								
	A 16 20 25 25 40 67 - 125 125																								
Rated operational power (*)	AC23																								
	415V																								
	Kw 7.5 9 15 18.5 33 37 46 55 69																								
	690V																								
	A 18 18 25 28.5 40 55 - -																								
Mixed resistive and inductive loads, including moderate overloads	DC22A																								
	250V																								
	A - 25(*) 32(*) 32(*)																								
	600V																								
	A - 10(*) 10(*) 10(*)																								
Rated short time withstand current	low (1s)																								
Conditional short circuit current	kAeff 10 10 10 10 10 10 30 50 50																								
Associate fuse size for conditional short circuit current - Type gG	A 16 20 32 40 63 80 100 125 125																								
Flexible wire	mm² 1.5-10 1.5-10 1.5-10 1.5-10 1.5-10 1.5-10 10-35 10-50 10-70 10-70																								
Rigid wire	mm² 1.5-16 1.5-16 1.5-16 1.5-16 1.5-16 1.5-16 10-35 10-50 10-70 10-70																								

(\*) Only 4P with 2+2 poles in series.

(\*) This values are given for guidance and may vary according to the specifics provided by the motor manufacturer.

## TECHNICAL CHARACTERISTICS 6P, 8P

Switch size	Y3					Y4					Y5														
	16A	25A	32A	40A	63A	80A	100A	125A	160A	160A	160A	160A	160A	160A	160A	160A	160A	160A	160A	160A	160A	160A			
Rated current In																									
Rated insulation voltage	Ui																								
Rated impulse withstand voltage	Uimp																								
Thermal current	Ith/Ithe																								
Resistive loads, including moderate overloads	AC21A																								
	415V																								
	A 16 25 32 40 63 80 100 125 160																								
	500V																								
	A 16 25 32 40 63 160 80 125 160																								
Mixed resistive and inductive loads, including moderate overloads	AC22A																								
	415V																								
	A 16 25 32 40 63 160 80 125 160																								
	500V																								
	A 16 25 32 40 63 160 80 125 160																								
Switching of motor loads or other highly inductive loads (3 phase / 3 pole)	AC23A																								
	415V																								
	A 16 25 32 40 63 63 63 125 125																								
	500V																								
	A 16 25 32 40 63 63 63 125 125																								
Rated operational power (*)	AC23																								
	415V																								
	kW 7.5 11 15 18.5 35 37 46 55 69																								
	600V																								
	A 16 25 25 25 32 32 32 32 100 100																								
Rated short time withstand current	low (1s)																								
Conditional short circuit current	kAeff 50 50 50 50 50 50 30 50 50																								
Associate fuse size for conditional short circuit current - Type gG	A 16 25 32 40 63 80 100 125 125																								
Flexible wire	mm² 4-25 4-25 4-25 4-25 4-25 4-25 10-50 10-50 10-70 10-70																								
Rigid wire	mm² 4-25 4-25 4-25 4-25 4-25 4-25 10-50 10-50 10-70 10-70																								

(\*) This values are given for guidance and may vary according to the specifics provided by the motor manufacturer.

## 4P SWITCH LINKING FOR DC APPLICATION

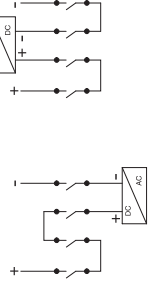

3P+N with late break: early make neutral pole.  
Front operators box version equipped with door locking in ON position.  
Padlockable handle.  
\* Only for 6 and 8 poles.

## ■ HIGH RATING SWITCH DISCONNECTORS - 160A-1600A



## ■ REFERENCE STANDARDS

### EN 60947-3

Low voltage switchgear and controlgear.  
Part 3: switches, disconnectors, switch-disconnectors and fuse-combination unit.

## ■ TECHNICAL CHARACTERISTICS 3P, 3P+N

Switch size	K2		K3		K4		K5		K6	
	160	200	400	500	630	800	1000	1250	1500	1600 (*)
Rated current In	(V)	1000	1000	1000	1000	1000	1000	1000	1000	1000
Rated insulation voltage	(kV)	12	12	12	12	12	12	12	12	12
Impulse withstand voltage	(kV)	12	12	12	12	12	12	12	12	12
Rated thermal current	(A)	160	200	250	315	400	500	630	800	1000
Rated operational current - Ie	AC21A	160	200	250	315	400	500	630	800	1000
	Resistive loads, including moderate overloads	160	200	250	315	400	500	630	800	1000
	AC22A	160	200	250	315	400	500	630	800	1000
Mixed resistive and inductive loads, including moderate overloads	160	200	250	315	400	500	630	800	1000	1250
	AC23A	160	200	250	315	400	500	630	800	1000
	Switching of motor loads or other highly inductive loads (3 phase / 3 pole)	125	160	200	250	315	315	500	800	800
Rated operational power (*)	160	100	125	160	200	250	250	400	400	400
	AC23A	85	105	130	165	200	210	330	420	525
	Rated making capacity	1600	2000	2500	3150	4000	4000	6300	6300	6300
Rated breaking capacity	1280	1600	2000	2520	3200	5040	5040	5040	5040	
Short circuit withstand current 1sec	(kA)	8	8	8	13	13	13	26.5	35	35
	(kA)	16	16	16	26	26	26	53	70	70
	(kA)	13.5	13.5	13.5	26	26	26	30	73.5	73.5
Short circuit making capacity	(A)	160	200	250	315	400	400	630	800	1000
	Back up fuse	(kA)	100	50	50	50	50	50	100	100
	R.M.S value	(kA)	16	20	25	25	30	40	70	90
Peak value	mm²	120	120	185	2x150	2x185	2x240	-	-	-
	Bars dimension	mm	20x5	20x5	2x (25x4) / 2x (25x4) / 2x (25x4) / 2x (25x4)	2x (25x4) / 2x (25x4) / 2x (25x4) / 2x (25x4)	2x (25x4) / 2x (25x4) / 2x (25x4) / 2x (25x4)	2x (25x4) / 2x (25x4) / 2x (25x4) / 2x (25x4)	2x (25x4) / 2x (25x4) / 2x (25x4) / 2x (25x4)	2x (25x4) / 2x (25x4) / 2x (25x4) / 2x (25x4)

(\*) Neutral pole 1250A

Full current neutral pole available on request.

(\*) Values are given for guidance and may vary according to the specifics provided by the motor manufacturer.

## ■ VERSIONS



Switch size K2  
Box version (B)  
Base mounting screws fixing



Switch size K3  
Box version (B)  
Base mounting screws fixing



Switch size K4  
Box version (B)  
Base mounting screws fixing



Switch size K5  
Box version (B)  
Base mounting screws fixing



Switch size K6  
Box version (B)  
Base mounting screws fixing

## ■ TECHNICAL CHARACTERISTICS

Polarity: **3P-3P+N**  
Rated current: **160A-200A-250A-315A-400A-500A-630A-800A-1000A-1250A-1600A (\*)**

Protection degree: **IP65 (front operator)**  
Operating ambient temperature according to the reference standard: **-25°C +40°C**

Max operating ambient temperature: **+60°C**  
3P+N with late break early make neutral pole  
Front operators box version equipped with door locking in ON position.  
Padlockable handle.

Full current neutral pole up to 1250A.  
(\*) Neutral pole 1250A.  
Full current neutral pole available on request.

## ■ CHANGE-OVER SWITCHES I/O/II - 16A-160A



## ■ REFERENCE STANDARDS

### EN 60947-3

Low voltage switchgear and controlgear.  
Part 3: switches, disconnectors, switch-disconnectors  
and fuse-combination unit.

## ■ TECHNICAL CHARACTERISTICS 3P, 3P+N

Switch size	Y3					Y4			Y5			
	16A	25A	32A	40A	63A	80A	100A	125A	160A	800	800	800
Rated current In	800	800	800	800	800	800	800	800	800	800	800	800
Rated insulation voltage	Ui											
Rated impulse withstand voltage	Uimp											
Thermal current	Ith/Ithe											
Rated operational current - Ie	AC21A											
	415V											
	Resistive loads, including moderate overloads											
	500V											
	690V											
Rated operational current - Ie	AC22A											
	415V											
	Mixed resistive and inductive loads, including moderate overloads											
	500V											
Rated operational current - Ie	AC23A											
	415V											
	Switching of motor loads or other highly inductive loads (3 phase / 3 pole)											
	500V											
Rated short time withstand current	low (1 s)											
Conditional short circuit current	kA <sub>eff</sub>											
Associate fuse size for conditional short circuit current - Type gG	A											
Flexible wire	mm <sup>2</sup>											
Rigid wire	mm <sup>2</sup>											

## ■ VERSIONS



Switch size Y3  
Box version (B)  
Base mounting DIN rail fixing or screws fixing



Switch size Y4  
Box version (B)  
Base mounting DIN rail fixing or screws fixing



Switch size Y5  
Box version (B)  
Base mounting DIN rail fixing or screws fixing

## ■ TECHNICAL CHARACTERISTICS

Polarity: **3P-3P+N**

Rated current: **16A-25A-32A-40A-63A**  
**80A-100A-125A-160A**

Protection degree: **IP65**

Operating ambient temperature according to the reference standard: **-25°C +40°C**

Max operating ambient temperature: **+60°C**

3P+N with late break early make neutral pole.  
Front operators box version equipped with door locking in ON position.  
Padlockable handle.

## ■ APPLICATION EXAMPLES

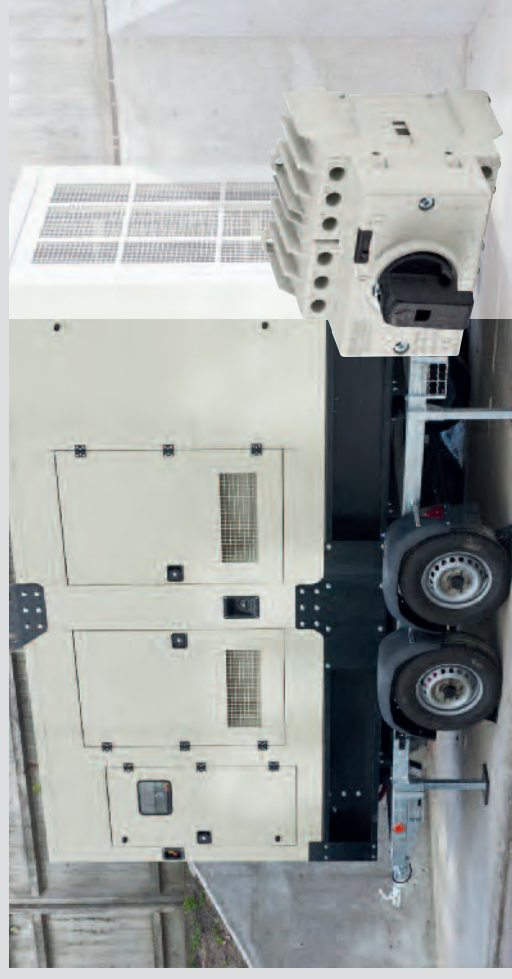



## PHOTOVOLTAIC/DC SWITCH DISCONNECTORS - 450-800 DC



## REFERENCE STANDARDS

### EN 60947-3

Low voltage switchgear and controlgear.  
Part 3: switches, disconnectors, switch-disconnectors and fuse-combination unit.

### IEC 60364-7-712

Requirements for special installations or locations  
Solar photovoltaic (RV) power supply systems.

## TECHNICAL CHARACTERISTICS 4P-5P-6P-8P

Switch size	Y1				Y3				Y5	
	16A	15A	20A	25A	30A	40A	1500	1500	1500	1500
Rated current In	VAC	1500	1500	1500	1500	1500	1500	1500	1500	1500
Rated insulation voltage	Ui	8	8	8	8	8	8	8	8	8
Rated impulse withstand voltage	Uimp	4	8	8	8	8	8	8	8	8
Thermal current	Ith/Ithe	A	63	63	63	63	63	63	63	125
Number of poles in series		4	4	5	6	8	8	8	8	8
Rated operational current - Ie	300V	A	32	-	-	-	-	-	-	-
	400V	A	-	30	35	40	60	80	80	80
	450V	A	16	-	-	-	-	-	-	-
	500V	A	-	30	35	40	45	65	65	65
	600V	A	-	20	25	40	40	60	60	60
	750V	A	-	15	20	25	30	40	40	40
800V	A	-	15	20	25	30	40	40	40	
Rated short time withstand current	Icw (1s)	A	400	1100	1100	1100	1100	1100	1100	3000
Flexible wire		mm <sup>2</sup>	1.5-10	16	16	16	16	16	16	70
Rigid wire		mm <sup>2</sup>	1.5-10	16	16	16	35	16	16	70

DC21A  
Resistive loads, including moderate overloads

## VERSIONS

	Switch size Y1 Box version (B) Base mounting DIN rail fixing
	Switch size Y3 Box version (B) Base mounting DIN rail fixing or screws fixing
	Switch size Y5 Box version (B) Base mounting DIN rail fixing or screws fixing

Scame embraces completely the renewable energy sources philosophy and the respect for the environment. In our production plant and office building we have installed 250kWp of photovoltaic system. We follow up this field in several countries with a wide range of products. From our experience is born the new range of DC isolators specific for photovoltaic systems. In accordance with the IEC 60364-7-712, in every photovoltaic installation it is necessary to isolate the photovoltaic panel from the rest of the system, DC isolators must have a higher performance than the traditional AC isolators because breaking direct current is more difficult than breaking alternating current, and furthermore in a photovoltaic system the voltage can reach even 800V.

## TECHNICAL CHARACTERISTICS

Poles in series:	4P-5P-6P-8P
Rated current (800V):	10A-15A-16A-20A-25A-30A-40A
Protection degree:	IP65 (front operator)
Operating ambient temperature according to the reference standard:	-25°C +40°C
Max operating ambient temperature:	+60°C
Front operators box version equipped with door locking in ON position. Padlockable handle.	

The current and voltage values changes depending on the combination of the photovoltaic cells. DC Isolator range has been set up focusing on all of the main photovoltaic installations in order to get a range as essential as possible, simplify the choice of the customer and for have the maximum quality and technical characteristics. In the meantime we are improving and up grading constantly our products, following and anticipating the change that the market requires due to the incentives available. Scame ISOLATORS Series includes also a complete range of AC isolators, essential to make a photovoltaic system in compliance with IEC 60364-7-712. Finally in the photovoltaic range it is available a huge range of water tight cabinets and consumer unit suitable for make distribution board & export control.

## POSSIBLE CONTACT WIRINGS

### SWITCH LINKING

In order to make easier the work of the installer, it is possible to choose the manner of wiring of the poles in series. In this way the incoming and the outgoing can be varied both on the top side and on the bottom side. In the packaging, jumpers are supplied to cover the chosen configuration.

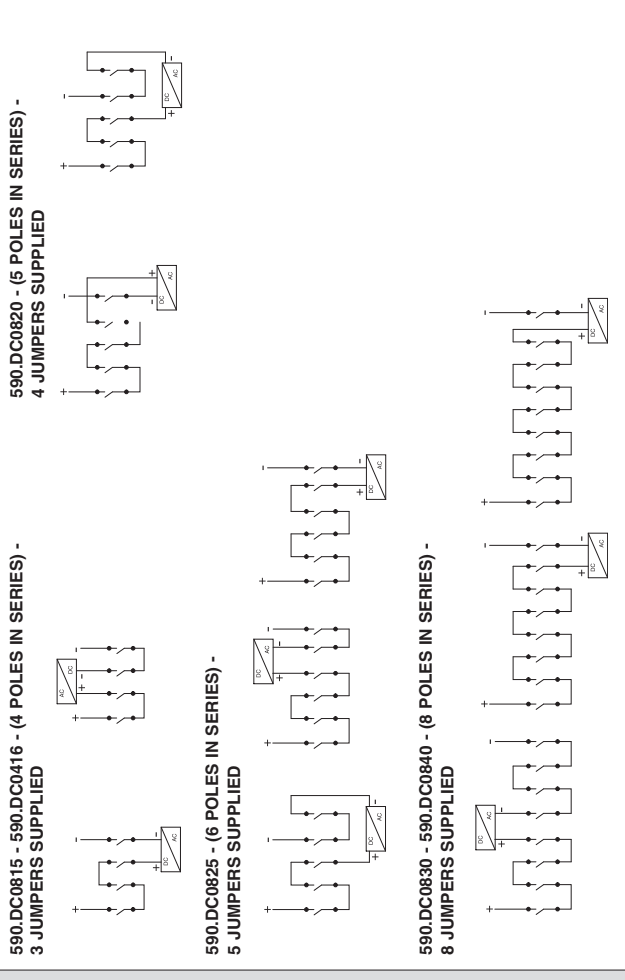



## CONNECTING ACCESSORIES



## REFERENCE STANDARDS

### IEC 60998-1

Connecting devices for low voltage circuits for household and similar purposes.  
Part 1: general requirements.

### IEC 60998-2-1

Connecting devices for low voltage circuits for household and similar purposes.  
Part 2-1: particular requirements for connecting devices as separate entities with screw-type clamping units.

## QUALITY MARKS



## VERSIONS

Insulated wire connectors



Multi-way wire connectors



Terminal strips



## APPLICATION EXAMPLES



## CONNECTION CAPACITY

Connec. capacity mm <sup>2</sup>	Rated current A	Type of conductor	T85 DOMINO CONNECTORS Conductors size (mm <sup>2</sup> ) and number													
			0,75	1	1,5	2,5	4	6	10	16	25	35	50			
10	57	rigid	-	-	1-4	1-3	1-2	1	1	-	-	-	-	-	-	-
16	76	flexible	-	-	1-4	1-3	1-2	1	1	-	-	-	-	-	-	-



Connec. capacity mm <sup>2</sup>	Fixing hole Ø mm (Φ)	Rated current A	Type of conductor	INSULATED WIRE CONNECTORS - SINGLE AND IN STRIPS Conductors size (mm <sup>2</sup> ) and number												
				0,75	1	1,5	2,5	4	6	10	16	25	35	50		
1,5	3	17,5	rigid	2-4	1-3	1-2	1									
2,5	4	24	flexible	2-4	1-3	1-2	1									
4	4,6	32	rigid					3-5	2-3	1-2	1					
6	6	41	flexible					2-4	2-3	1-2	1					
10	8	57	rigid					3-4	2-3	1-2	1					
16	10	76	flexible					3-5	2-3	1-2	1					
25	12	101	rigid									2-3	2-3	2	1	
35	14	125	flexible									3-5	2-3	2	1	
												2-4	1-3	1-2	1	
												3-4	2-3	1-2	1	



Connec. capacity mm <sup>2</sup>	Fixing hole Ø mm (Φ)	Rated current A	Type of conductor	T140 AND T85 TERMINAL STRIPS Conductors size (mm <sup>2</sup> ) and number												
				0,75	1	1,5	2,5	4	6	10	16	25	35			
2,5	2,7	24	rigid	1-3	1-2	1	1									
4	3	32	flexible	1-2	1-2	1	1									
6	3,5	41	rigid	2-4	1-3	1-2	1	1								
10	4,4	57	flexible	1-2	1-2	1	1									
16	5,5	76	rigid					1-3	1-2	1	1					
25	7,4	101	flexible					1-3	1-2	1	1					
35	9	125	rigid					1-2	1-2	1	1					
								2	1-2	1	1					
												2-4	2-3	1	1	
												2-3	1-2	1	1	
												2-4	1-2	1	1	
												2-3	1-2	1	1	



The table refers to a single terminal and to connections from one side only.

Connec. capacity mm <sup>2</sup>	Rated current A	Type of conductor	MULTI-WAY WIRE CONNECTORS - T85 Conductors size (mm <sup>2</sup> ) and number													
			1	1,5	2,5	4	6	10	16	25	35	50				
6	41	rigid					1-6	1-4	1-3	1-2						
16	76	flexible					1-7	1-5	1-4	1-3	1-2					
35	125	rigid									1	1				
											1-4	1-2				
													1	1		
													1-2	1	1	

## ■ JUNCTION BOXES FOR ELECTRICAL INSTALLATIONS



## ■ REFERENCE STANDARDS

### EN 60670-1

Boxes and enclosures for electrical accessories for household and similar fixed electrical installations. *Part 1: general requirements.*

### EN 60670-22

Boxes and enclosures for electrical accessories for household and similar fixed electrical installations. *Part 22: particular requirements for connecting boxes and enclosures.*

## ■ QUALITY MARKS



## ■ VERSIONS



**CUBIK 650 Series**  
Glow wire 650°C halogen free:  
- With cable sleeve and release cover  
- With cable sleeve and 1/4 turn screw cover  
- With blank sides and 1/4 turn screw cover



**CUBIK 960 Series**  
Glow wire 960°C:  
- With cable sleeve and release cover  
- With cable sleeve and 1/4 turn screw cover  
- With blank sides and 1/4 turn screw cover



**CUBIK 960 Series**  
Glow wire 960°C (red versions):  
- With cable sleeve and release cover  
- With cable sleeve and 1/4 turn screw cover  
- With blank sides and 1/4 turn screw cover

## ■ BEHAVIOUR WITH CHEMICAL AND ATMOSPHERIC AGENTS

Saline solution	Acids		Bases			Solvents			Mineral oil	UV rays
	Concentrated	Diluted	Concentrated	Diluted	Hexane	Benzol	Acetone	Alcohol		
Resistant	Limited Resistance	Resistant	Resistant	Resistant	Not Resistant	Not Resistant	Not Resistant	Limited Resistance	Resistant	Resistant



Glow wire 960°C versions (also in red) are identifiable by the symbol marked on the external side.



## ■ APPLICATION EXAMPLES



## ■ TECHNICAL CHARACTERISTICS

Protection degree:	IP55
Operating ambient temperature according to the reference standard:	-25°C +35°C
Max. operating ambient temperature:	60°C
Glow Wire test:	650°C/960°C
Material:	Engineering plastic
IK degree at 20°C:	IK07
Cable inlets:	Cable sleeve / Blank sides
Halogen free:	Yes (CUBIK 650 Series)
DIN rail fixing:	Yes
Colour:	Grey RAL 7035 - Red
Insulation class:	Class II (double insulation)





### Internal fixing system

Connecting boxes up to 80x80x40mm dimensions feature two internal knock out fixing slots.  
Connecting boxes over 100x100x50mm dimensions feature four internal knock out fixing slots.



### Back fixing system

Versions up to 80x80x40mm dimensions can also be screwed to existing fixings on the wall. The fixings feature has to be an external M7 threaded pin, which is designed to fit with the base of boxes.  
In addition, specific reeding is on the backside so to avoid any accidental rotational movement of the box.



### External fixing system

Connecting boxes above 100x100x50mm dimensions can also be wall mounted by four fixing slots featured outside the cabling area to avoid piercing the box.



### Closing

The cover is available either as a pressure-type for the small boxes or closed with four 1/4 - turn screws for the larger boxes.  
The 1/4 - turn screw versions feature 0-1 markings indicating Open-close.



### Capacity

Series CUBIK connector blocks are very spacious; raised walls increase the internal room, making any cabling operation easier.



### Cables sleeves

Cable sleeve provided with the kit consist of 5 different levels allowing the identification of pipe and wire diameters, making precise cut for cable easier and cable positioning quicker.  
Versions up to 80x80x40mm dimensions are equipped with 23mm-diameter cable sleeve that fit 5, 8, 12, 16 or 20mm-diameter wires or pipes; on the contrary, versions up to 100x100x50mm dimensions are provided with 29mm-diameter cable sleeve that fit 5, 12, 16, 20 and 25mm diameters. The cable sleeve completely fit the pipe/wire in a reliable way.

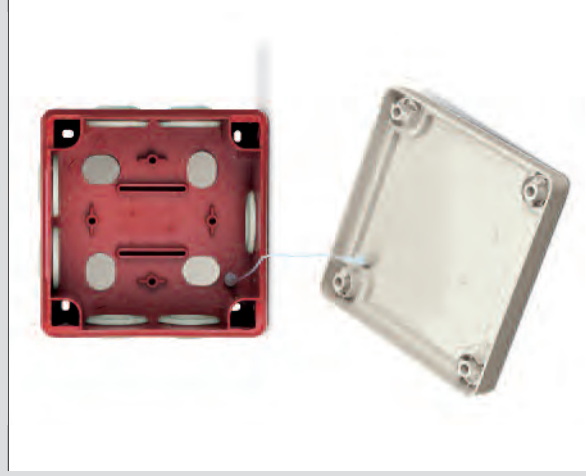

### Captive cover

This cover has been designed for all versions with a support cable to retain the cover.



### Wall fixing system.

### Insulating caps

All versions are provided with caps to provide total insulation.

## ■ JUNCTION BOXES FOR ELECTRICAL INSTALLATIONS



## ■ REFERENCE STANDARDS

### EN 60670-1

Boxes and enclosures for electrical accessories for household and similar fixed electrical installations. *Part 1: general requirements.*

### EN 60670-22

Boxes and enclosures for electrical accessories for household and similar fixed electrical installations. *Part 22: particular requirements for connecting boxes and enclosures.*



## ■ BEHAVIOUR WITH CHEMICAL AND ATMOSPHERIC AGENTS

Saline solution	Acids		Bases		Solvents			Mineral oil	UV rays
	Concentrated	Diluted	Concentrated	Diluted	Hexane	Benzol	Acetone		
Resistant	Limited Resistance	Resistant	Resistant	Resistant	Not Resistant	Not Resistant	Not Resistant	Limited Resistance	Resistant

## ■ APPLICATION EXAMPLES



## ■ VERSIONS

	- With cable sleeve and release cover
	- With cable sleeve and 1/4 turn screw cover
	- With blank sides and 1/4 turn screw cover

## ■ TECHNICAL CHARACTERISTICS

Protection degree:	<b>IP55</b>
Operating ambient temperature according to the reference standard:	<b>-25 °C +35 °C</b>
Max. operating ambient temperature:	<b>60 °C</b>
Glow Wire test:	<b>650 °C</b>
Material:	<b>Engineering plastic</b>
IK degree at 20 °C:	<b>IK07</b>
Cable inlets:	<b>Cable sleeve / Blank sides</b>
Halogen free:	<b>No</b>
DIN rail fixing:	<b>Yes</b>
Colour:	<b>Grey RAL 7035</b>
Insulation class:	<b>Class II (double insulation)</b> 

COMPONENTS FOR TELEPHONE INSTALLATIONS



The telephone network is gradually evolving - it's not only voices and sounds that travel along the telephone cable but also digital signals. This important expansion demands new skills from the qualified installer, who is in the position of having to wire "intelligent" buildings, or to transform and adapt traditional telephone installations to conform to the new requirements.

A simple on-off sequence, the presence or absence of agreed tones and signals can make high technology appliances communicate, both in domestic use and in the service industry. The number of appliances connected to the network is multiplying: internet and digital TV, alarms or help alerts, user and appliance controls and commands - and so, at home and in the office, it all has to be inter-connected within the same installation.

For the qualified installer, Scame is offering a series of products that will satisfy most of the common needs both for wiring up and for expanding a telephone installation.

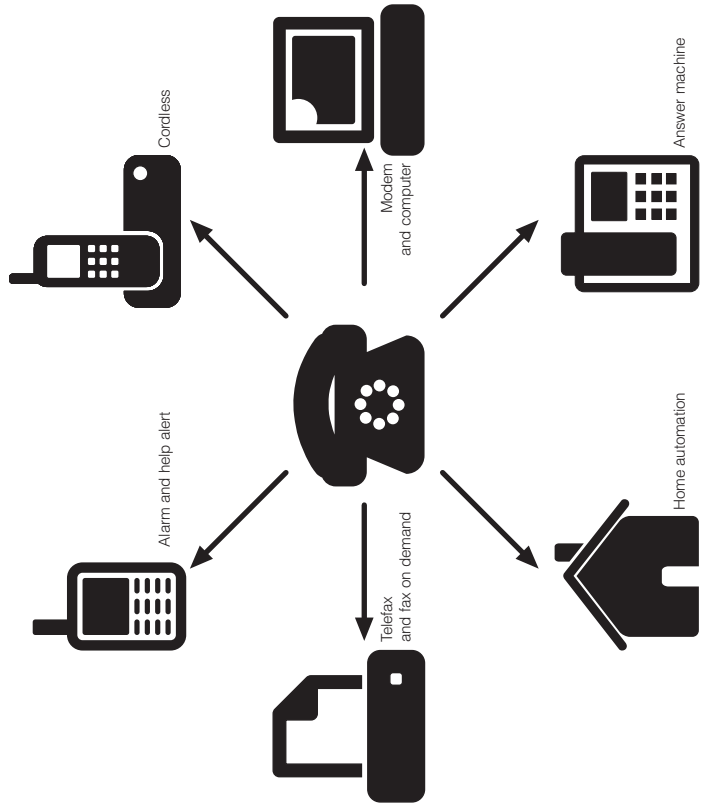

Surface and flush mounting RJ socket 6/4



Surface mounting RJ Socket 6/4

APPLICATION EXAMPLES





**DATEL-DATA Series**

**COMPONENTS FOR CLASS 5E TRANSMISSION SYSTEMS**

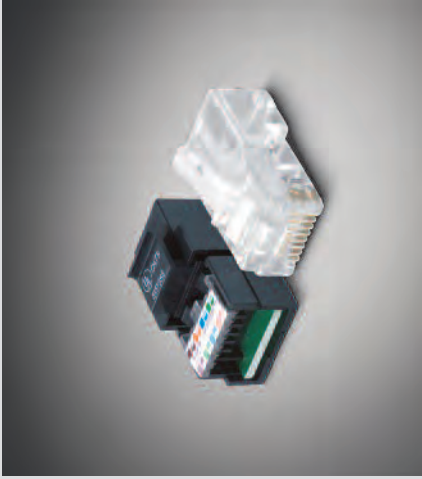

**REFERENCE STANDARDS**

<p><b>ANSI/TIA/EIA-568</b> Commercial Building Telecommunications Cabling Standard.</p>
<p><b>ISO/IEC 11801</b> Information Technology-Generic Cabling for Customer Premises.</p>
<p><b>EN 50173</b> Information technology Generic cabling systems.</p>

**EIA TIA 565/A or /B** Standards (the extensions A or B refer to different cabling); this US Standard first introduced the term "CAT. 5" to classify the cabling transmission features and application fields. CAT. 5 equipments are suitable for 100 Mbs up to 100 MHz.

**IEC 11801**, International Standard for generic cabling. The transmission features are classified according to different.

**EN 50173** is similar to U.S. and international standards.

**EXAMPLE OF A "CAT. 5E" DATA TRANSMISSION SYSTEM**

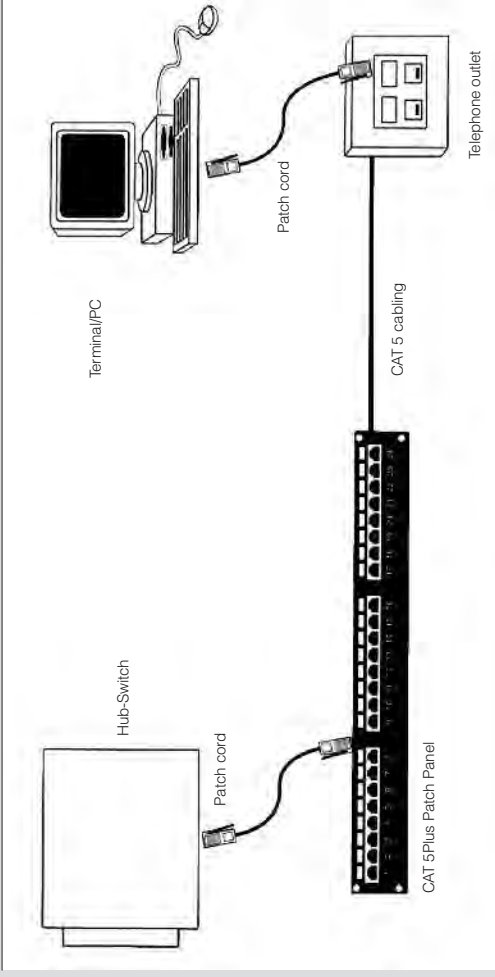

**APPLICATION EXAMPLES**



**EIA/TIA 568A**

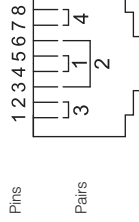

**Pin Colours**

- 1- White and green
- 2- Green
- 3- White and orange
- 4- Blue
- 5- White and blue
- 6- Orange
- 7- White and brown
- 8- Brown

**EIA/TIA 568B**

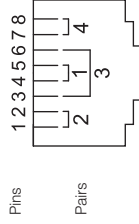

**Pin Colours**

- 1- White and orange
- 2- Orange
- 3- White and green
- 4- Blue
- 5- White and blue
- 6- Green
- 7- White and brown
- 8- Brown

## COMPONENTS FOR TV INSTALLATIONS



### AERIAL INSTALLATION IS MADE UP OF:

- 1) The aerial that receives the audio/video signal.
- 2) The aerial unit for amplifying and mixing the received signal.
- 3) The distribution network that sends the signal to the user's socket.

### In addition, an aerial installation can also be:

- a single aerial installation
  - a communal aerial installation.
- The aerial installation can be set up to receive radio signals as well as television signals.
- Scame offers a series of accessories for completing the distribution network:
- coaxial plugs and sockets for both surface and flush mounting;
  - cable dividers and junction boxes.

## REFERENCE STANDARDS

### CEI EN 50083

Communal aerial installations.

### IEC 60169

Radio-frequency connectors.

## APPLICATION EXAMPLES



## TECHNICAL CHARACTERISTICS OF TV PLUGS

- Direct type (of derivation).
- No attenuation (without devices for splitting the signal).
- Not technical with terminal resistance.
- Not to be connected to other sockets in cascade connection.

## COAXIAL USER SOCKETS

In order to guarantee the appropriate use of the installations, the plugs, sockets and TV outlets should insure the CEI EN 50083 standards.

- Efficient shunting, which makes T.V. signals immune to electromagnetic emissions present in the environment.
- Avoid undesirable reflections of signals (impedance adaptation)
- Coupling among various outlets or among various connections of plugs.

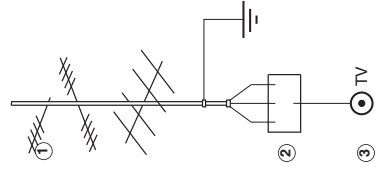

## CONSUMER UNITS AND ENCLOSURES



## VERSIONS

	Surface mounting - IP66
	Surface mounting - IP40 With window
	Surface mounting - IP40 Without window
	Flush mounting - IP40 With window

## QUALITY MARKS



## REFERENCE STANDARDS

<b>EN 62208</b> Empty enclosure for low-voltage switchgear and controlgear assemblies. <i>Part 1: general requirements.</i>
<b>EN 60670-24</b> Boxes and enclosures for electrical accessories for household and similar fixed electrical installations. <i>Part 24: particular requirements for enclosures for housing protective devices and other power dissipating electrical equipment.</i>
<b>EN 61439-3</b> Low-voltage switchgear and controlgear assemblies. <i>Part 3: distribution boards intended to be operated by ordinary persons (DBO).</i>
<b>EN 61439-4</b> Low-voltage switchgear and controlgear assemblies. <i>Part 4: particular requirements for assemblies for construction sites (ACS)</i>
<b>EN 60670-1</b> Boxes and enclosures for electrical accessories for household and similar fixed electrical installations. <i>Part 1: general requirements.</i>
<b>CEI 23-49</b> Enclosure for accessories for household and similar fixed electrical installations. <i>Part 2: particular requirements for enclosures for protection devices and accessories dissipating a considerable power in normal use.</i>

## TECHNICAL CHARACTERISTICS

Protection degree:	IP40-IP66
Operating ambient temperature according to the reference standard:	-25°C +35°C
Max. operating ambient temperature:	60°C
Glow Wire test:	650°C
Material:	Engineering plastic
IK degree at 20°C:	IP40: IK06 IP66: IK07
Cable inlets:	PG/METRIC
Dissipable power according to CEI 23-49 standard:	9+140W
Colour:	Grey RAL 7035 White RAL 9003
Terminal blocks fixing possibility:	Yes
Insulation class:	Class II (double insulation) 

## BEHAVIOUR WITH CHEMICAL AND ATMOSPHERIC AGENTS

Saline solution	Acids		Bases			Solvents			Mineral oil	UV rays
	Concentrated	Diluted	Concentrated	Diluted	Hexane	Benzol	Acetone	Alcohol		
Resistant	Limited Resistance	Resistant	Limited Resistance	Resistant	Resistant	Not Resistant	Not Resistant	Resistant	Not Resistant	Resistant

## APPLICATION EXAMPLES





DOMINO Series

■ SURFACE MOUNTING IP66

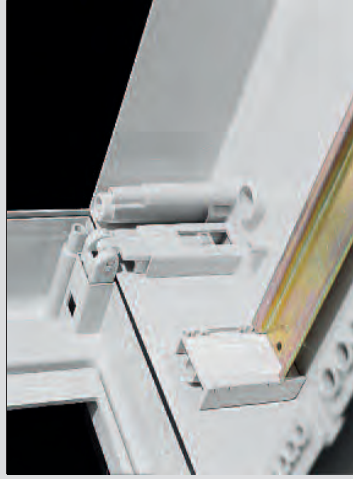

Hinges, should be snap-fitted into their guides, can be mounted on the left or the right side, in the series versions 12 to 64 DIN modules.

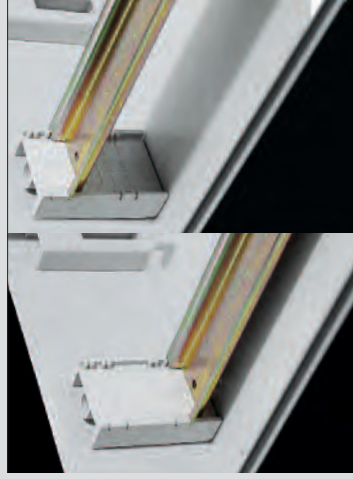

DIN rail (EN 60715): can be placed on different levels.

■ SURFACE MOUNTING IP40



1/4 turn locking device.



Vertical connection.



The semi-transparent tinted window, lockable and sealable. To open it, just lower the handle provided, snap-closing.

## SOCKETS FOR DOMESTIC APPLICATIONS



## REFERENCE STANDARDS

**CEI 23-50**  
Plugs and socket-outlets for household and similar purposes.  
*Part 1: general requirements.*

**IEC 60884-1**  
Plugs and socket-outlets for household and similar purposes.  
*Part 1: general requirements.*

## QUALITY MARKS



## BEHAVIOUR WITH CHEMICAL AND ATMOSPHERIC AGENTS

Saline solution	Acids		Bases			Solvents			Mineral oil	UV rays
	Concentrated	Diluted	Concentrated	Diluted	Hexane	Benzol	Acetone	Alcohol		
Resistant	Not Resistant	Not Resistant	Not Resistant	Limited Resistance	Resistant	Not Resistant	Not Resistant	Limited Resistance	Resistant	Resistant

## AVAILABLE STANDARDS

	<b>ITALIAN STANDARD P17/11 - 16A</b> Shuttered socket CEI 23-50		<b>ITALIAN STANDARD P30 - 16A</b> Shuttered socket CEI 23-50		<b>PLURISTANDARD P40 - 16A</b> Shuttered socket CEI 23-50		<b>FRENCH STANDARD - 16A</b> Shuttered socket NFC 61-314		<b>ARGENTINIAN STANDARD - 10A</b> Unshuttered socket IIRAM 2071		<b>BRAZILIAN STANDARD - 10A</b> Unshuttered socket ABNT NBR 14136:2002
--	---	--	--	--	---	--	--	--	---	--	--

## VERSIONS



Panel mounting flange 50x60mm IP54.



Panel mounting flange 70x87mm IP54.



Surface mounting flange 70x87mm IP54.

## TECHNICAL CHARACTERISTICS

Rated current:	<b>16A</b>
Rated voltage:	<b>250V~</b>
Frequency:	<b>50Hz</b>
Insulating voltage:	<b>690V~</b>
Protection degree:	<b>IP44 closed cover/IP54</b>
Operating ambient temperature according to the reference standard:	<b>-25°C +35°C</b>
Max. operating ambient temperature:	<b>60°C</b>
Glow Wire test:	<b>650°C/750°C</b>
Material:	<b>Engineering plastic</b>
Cabling capacity of the terminals:	<b>1,5mm<sup>2</sup>+2x2,5 mm<sup>2</sup></b>



## DOMESTIC STANDARD SOCKETS FOR INDUSTRIAL APPLICATIONS



### VERSIONS



Flush mounting flange 70x87mm IP66

### CABLING CAPACITY OF THE TERMINAL

Rated voltage	Rated current (A)	Sockets	
		Min	Max
250V~	10A	0,75	2,5
	13A	2,5	6
	15A	2,5	6
	16A	1	2,5

(mm)

## REFERENCE STANDARDS

### EN 60670-1 (2005-10)

Boxes and enclosures for electrical accessories for household and similar fixed electrical installations. Part 1: general requirements.

### IEC 60884-1

Plugs and socket-outlets for household and similar purposes. Part 1: general requirements.

## TECHNICAL CHARACTERISTICS

Rated current:	6A-10A-13A-15A-16A
Rated voltage:	250V~
Frequency:	50Hz
Insulating voltage:	250V~
Protection degree:	IP66 (also with plug inserted)
Operating ambient temperature:	-5°C +60°C
Installation temperature:	-20°C +60°C
Glow Wire test:	650°C / 850°C (Contact-holder base)
Halogen free:	Yes
Material:	Engineering plastic
IK degree at 20°C:	IK08
Colour:	Base: Gray RAL 7035 Cover: tinted polycarbonate

Tinted polycarbonate cover to see inside

Tilting device holder (Fixed with additional terminal strip for English version)

Fixing screws within the insulating gasket

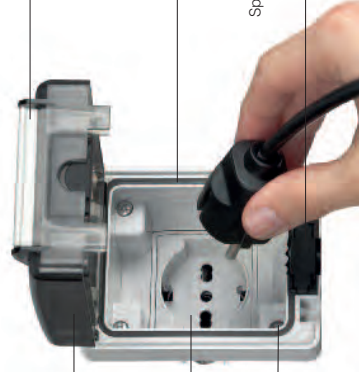

A wing on the lid assists one-handed opening

Co injected gasket to guarantee total insulation

Specifically high formulated gel seal to maintain protection degree when the plug is inserted

## BEHAVIOUR WITH CHEMICAL AND ATMOSPHERIC AGENTS

Saline solution	Acids		Bases			Solvents			Mineral oil	UV rays
	Concentrated	Diluted	Concentrated	Diluted	Hexane	Benzol	Acetone	Alcohol		
Resistant	Limited Resistance	Resistant	Limited Resistance	Resistant	Resistant	Not Resistant	Not Resistant	Resistant	Limited Resistance	Resistant

## AVAILABLE STANDARDS

**ITALIAN STANDARD**  
PI7/11 - 16A  
Shielded socket  
CEI 29-50

**ITALIAN STANDARD**  
P30 - 16A  
Shielded socket  
CEI 29-50

**PLURISTANDARD**  
P40 - 16A  
Shielded socket  
CEI 29-50

**GERMAN STANDARD - 16A**  
Shielded socket  
DIN VDE 0620

**FRENCH STANDARD - 16A**  
Shielded socket  
NFC 61-314

**BRITISH STANDARD - 13A**  
Shielded socket  
BS 1363-2

**BRITISH STANDARD - 15A**  
Shielded socket  
BS 546

**ARGENTINIAN STANDARD - 10A**  
Unshielded socket  
IRAM 2071

**NEW ZEALAND STANDARD - 10A**  
Unshielded socket  
ASN25 3112

**SWISS STANDARD - 10A**  
Unshielded socket  
SEV 1011:1998

**SOUTH AFRICAN STANDARD - 16A**  
Shielded socket  
SANS 164-1 (2006)

**BRAZILIAN STANDARD - 10A**  
Unshielded socket  
ABNT NBR 14136:2002

**INDIAN STANDARD - 6/16A**  
Shielded socket  
IS 1283:1988

## APPLICATION EXAMPLES



## WEATHER-PROOF ENCLOSURES



## REFERENCE STANDARDS

### EN 60670-1

Boxes and enclosures for electrical accessories for household and similar fixed electrical installations.  
*Part 1: general requirements.*

### CEI 23-49

Enclosure for accessories for household and similar fixed electrical installations.  
*Part 2: particular requirements for enclosures for protection devices and accessories dissipating a considerable power in normal use.*

### EN 62208

Empty enclosure for low-voltage switchgear and controlgear assemblies.  
*Part 1: general requirements.*

## VERSIONS



**LT enclosure**  
Special high resistance thermoplastic compound.

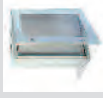

**MV enclosure**  
Metal 15/10 painted with an epoxy resin suitable for inside use.

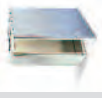

**AI enclosure**  
Stainless steel.

## BEHAVIOUR WITH CHEMICAL AND ATMOSPHERIC AGENTS

Saline solution	Acids		Bases		Solvents			Mineral oil	UV rays
	Concentrated	Diluted	Concentrated	Diluted	Hexane	Benzol	Acetone		
Resistant	Limited Resistance	Resistant	Limited Resistance	Resistant	Resistant	Not Resistant	Not Resistant	Resistant	Resistant

## TYPES

Dimensions (mm)	rows of	max	
Type 1	320x370x210	12 DIN	24 DIN
Type 2	460x370x245	20 DIN	40 DIN
Type 3	460x320x245	20 DIN	60 DIN
Type 4	460x670x245	20 DIN	80 DIN
Type 5	775x715x345	35 DIN	140 DIN

There are 5 cabinets available in the EASYBOX Series, each with three different variations (LT, MV and AI):

## DISSIPABLE POWER

Cabinet	DIN Modules			Set-up with chassis and DIN rail (W)			Set-up with base plate in L3 position (W)			
	LT	MV	AI	LT	AI	LT	MV	AI	MV	AI
Type 1	24 DIN	35	45	30	40	65	40	40	65	40
Type 2	40 DIN	50	60	42	84	105	62	62	105	62
Type 3	60 DIN	58	73	47	100	125	78	78	125	78
Type 4	80 DIN	85	98	63	125	150	94	94	150	94
Type 5	140 DIN	138	155	-	235	280	-	-	280	-

Dissipable power according to Italian standard CEI 23-49

## APPLICATION EXAMPLES



## QUALITY MARKS



## TECHNICAL CHARACTERISTICS

Protection degree:	<b>IP65</b>
Operating ambient temperature according to the reference standard:	<b>-25°C +35°C</b>
Max. operating ambient temperature:	<b>60°C</b>
Glow Wire test:	<b>650°C</b>
Material:	<b>Engineering plastic/Metal</b>
IK degree at 20°C:	<b>IK08 (door with window) IK10 (plain door)</b>
Cable inlets:	<b>Blank sides (Engineering plastic) Plate (Metal)</b>
Insulation class:	<b>Class II (double insulation) <input type="checkbox"/></b>
Colour:	<b>Grey RAL 7035</b>





Metal enclosures: stainless steel (AI) and metal 15/10 varnished with epoxy resin (MV) take the same accessories as the (LT) cabinets.

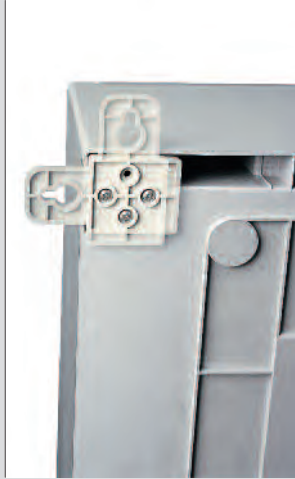

LT cabinet fixing brackets, positioned either horizontally or vertically for MV and AI enclosures.



Setting up with vertical mrcbb.



## MODULARITY

The Easy-Box series offers a range of components that are modular and inter-changeable among the different enclosures. Enclosures with the same height or width can be placed above or beside each other, while enclosures of the same width have various components in common - DIN rails, modular plates, panels and accessories.



LT cabinet type 3: set up with 2 DIN rows and half module (blank panel 1/2 module).



## EMERGENCY CALL POINTS



### VERSIONS

	Flush mounting version IP55 with illuminated push button.
	Surface mounting version IP55 with illuminated push button.
	Surface mounting version IP65 with DIN Rail or mounting plate.

## REFERENCE STANDARDS

<p><b>EN 60947-5-1</b> Low-voltage switchgear and controlgear. Part 5-1: control circuit devices and switching elements. <i>Electromechanical control circuit devices.</i></p>
<p><b>EN 60670-1</b> Boxes and enclosures for electrical accessories for household and similar fixed electrical installations. <i>Part 1: general requirements.</i></p>

## TECHNICAL CHARACTERISTICS

Protection degree:	IP55-IP65
Operating ambient temperature according to the reference standard:	-25°C +35°C
Max. operating ambient temperature:	60°C
Glow wire test:	650°C
Material:	Engineering plastic and glass
Insulation class:	Class II (double insulation) <input type="checkbox"/>
Halogen free:	Yes
Colour:	Red RAL 3000

## TECHNICAL CHARACTERISTICS FOR EMERGENCY SWITCHING DEVICES

Rated voltage U <sub>e</sub> :	250V
Category of use:	AC12
Rated current I <sub>e</sub> :	2A
Rated insulation voltage U <sub>i</sub> :	250V

## BEHAVIOUR WITH CHEMICAL AND ATMOSPHERIC AGENTS

Saline solution	Acids		Bases			Solvents			Mineral oil	UV rays
	Concentrated	Diluted	Concentrated	Diluted	Hexane	Benzol	Acetone	Alcohol		
Resistant	Resistant	Resistant	Resistant	Resistant	Resistant	Not resistant	Not resistant	Resistant	Resistant	Resistant

## APPLICATION EXAMPLES





## ■ DISTRIBUTION ASSEMBLIES



## ■ VERSIONS

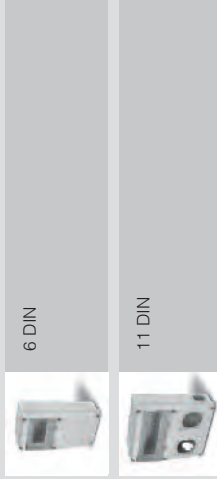

Left and right side knockouts for DOMO Series (flange 50x60mm).

## ■ REFERENCE STANDARDS

<p><b>EN 60670-1</b> Boxes and enclosures for electrical accessories for household and similar fixed electrical installations. <i>Part 1: general requirements.</i></p>
<p><b>EN 60670-24</b> Boxes and enclosures for electrical accessories for household and similar fixed electrical installations. <i>Part 24: particular requirements for enclosures for housing protective devices and other power dissipating electrical equipment.</i></p>

## ■ TECHNICAL CHARACTERISTICS

Rated current:	<b>IP55</b>
Operating ambient temperature according to the reference standard:	<b>-25°C +35°C</b>
Max. operating ambient temperature:	<b>60°C</b>
Glow Wire test:	<b>650°C</b>
Material:	<b>Engineering plastic</b>
IK degree at 20°C:	<b>IK08</b>
Cable inlet:	<b>PG16-PG21-PG29</b>
Insulation class:	<b>Class II (double insulation) <input type="checkbox"/></b>
Dissipable power according to CEI 23-49 standard:	<b>9-15W</b>
Colour:	<b>Grey RAL7035</b>

## ■ BEHAVIOUR WITH CHEMICAL AND ATMOSPHERIC AGENTS

Saline solution	Acids		Bases			Solvents			Mineral oil	UV rays
	Concentrated	Diluted	Concentrated	Diluted	Hexane	Benzol	Acetone	Alcohol		
Resistant	Limited Resistance	Resistant	Limited Resistance	Resistant	Resistant	Not Resistant	Not Resistant	Resistant	Not Resistant	Limited Resistance

## ■ APPLICATION EXAMPLES



## INDUSTRIAL PLUGS AND SOCKETS



## REFERENCE STANDARDS

### EN 60309-1

Plugs, socket outlets and couplers for industrial purposes.  
Part 1: general requirements.

### EN 60309-2

Plugs, socket outlets and couplers for industrial purposes.  
Part 2: dimensional interchangeability requirements for pin and contact-tube accessories of harmonised configurations.

## QUALITY MARKS



## VERSIONS



Plugs and connectors  
90° angled



Panel mounting socket outlets  
90° angled outlet

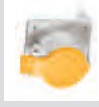

Panel mounting socket outlets  
Straight (reduced flange)

## TECHNICAL CHARACTERISTICS

Rated current:	16A-32A
Rated voltage:	100/690V~
Frequency:	c.c. - 50/500Hz
Insulating voltage:	500/690V~
Protection degree:	IP44/IP54-IP66/IP67
Operating ambient temperature according to the reference standard:	-25°C +40°C
Max. operating ambient temperature:	60°C
Glow Wire test:	650°C/850°C
Material:	Engineering plastic
IK degree at 20°C:	IK07 (plugs and connectors 90° angled) IK09 (panel mounting socket outlets 90° angled outlet)
Cable inlets:	Cable sleeve IP44/IP54 Cable gland IP66/IP67

## NO. OF CYCLES

Rated current (A)	Under load	Without load
16A	5.000	-
32A	1.000	1.000

## BEHAVIOUR WITH CHEMICAL AND ATMOSPHERIC AGENTS

Saline solution	Acids		Bases			Solvents			Mineral oil	UV rays
	Concentrated	Diluted	Concentrated	Diluted	Hexane	Benzol	Acetone	Alcohol		
Resistant	Limited Resistance	Resistant	Limited Resistance	Resistant	Not Resistant	Not Resistant	Not Resistant	Limited Resistance	Limited Resistance	Resistant

## WIRING AND INSTALLATION

Wiring capacity of the terminals

Cross-section of connectable conductors (mm²)

Rated voltage	Rated current (A)		Plugs, connectors and appliance inlets		Socket outlets		Rated current (A)		Outside Ø mm	
	16A	32A	Min	Max	Min	Max	Min	Max	Min	Max
>50V	16A	32A	1,5	2,5	1,5	4	16A	32A	8	15
			2,5	6	2,5	10			11,5	21

Max. cable size accepted by the cable clamp

## APPLICATION EXAMPLES



## ■ PIN AND SLEEVE DEVICES



## ■ VERSIONS

	Plugs and connectors
	Appliance inlets
	Receptacle
	Accessories Back Box and closure caps
	Liquid tight adapter

## ■ REFERENCE STANDARDS

### IEC 60309-1

Plugs, socket-outlets and couplers for industrial purposes.  
*Part 1: general requirements.*

### IEC 60309-2

Plugs, socket-outlets and couplers for industrial purposes.  
*Part 2: dimensional interchangeability requirements for pin and contact-tube accessories.*

### UL 1682

Plugs, receptacles and cable connectors of the pin and sleeve type.

### UL 1686

Standard for pin and sleeve configuration.

## ■ QUALITY MARKS

UL LISTED:  
E238171, E238172



UL CLASSIFIED:  
E238170



## ■ BEHAVIOUR WITH CHEMICAL AND ATMOSPHERIC AGENTS

Saline solution	Acids		Bases		Solvents			Mineral oil	UV rays
	Concentrated	Diluted	Concentrated	Diluted	Hexane	Benzol	Acetone		
Resistant	Limited Resistance	Resistant	Limited Resistance	Resistant	Not Resistant	Not Resistant	Not Resistant	Limited Resistance	Resistant

## ■ WIRING AND INSTALLATION

### Cross-section of connectable conductors (awg/mm²)

Rated current	Plugs, connectors and appliance inlets			Receptacle				
	Series I	Series II	Max awg mm²	Min awg mm²	Max awg mm²	Max mm²		
16A	20A	16	12	2,5	16	1,5	12	4
32A	30A	14	2,5	10	6	14	2,5	8
63A	60A	10	6	16	10	6	4	25
125A	100A	6	16	2	50	4	25	0

### Cord grip range (Plugs and connectors)

Rated current	Outside Ø mm				
	Series I	Series II	Max mm²		
16A	20A	,570	14	,710	18
32A	30A	,675	17	,910	23
63A	60A	,937	24	1,375	35
125A	100A	1,265	32	1,790	45

## ■ TECHNICAL CHARACTERISTICS FOR BACK BOX

Protection degree (IEC 60529):	IP66/IP67
Operating ambient temperature:	-25°C +40°C
Max. operating ambient temperature:	+70°C
Self-extinguishing (IEC 60695-2-1):	GW test 850°C
Self-extinguishing (UL94):	5VA (3mm)
Material:	PC siloxane
IK degree at 20°C (EN 50102):	IK10 (20J)

## ■ TECHNICAL CHARACTERISTICS FOR PIN & SLEEVE

Rated current:	16A - 32A - 63A - 125A (SERIES I) 20A - 30A - 60A - 100A (SERIES II)
Rated voltage:	100-690V~
Frequency:	D.C. - 50-500Hz
Insulating voltage:	500/690V~
Protection degree (IEC 60529):	IP44 - IP67
Operating ambient temperature according to the reference standard:	-25°C + 40°C
Max. operating ambient temperature:	+70°C
Self-extinguishing (IEC 60695-2-1):	GW test 650°C / 850°C
Self-extinguishing (UL94):	V1 (3mm)
Material:	VALOX®
IK degree at 20°C (EN 50102):	IK10 (20J)

## ■ PERFORMANCE - ELECTRICAL (SERIES I)

Dielectric Voltage withstand:	3000 Volts for 1 minute per IEC 60309-1, Clause 19
Maximum Working Voltage:	690VAC/250 VDC (minimum creepage and clearances per IEC)
Current Interrupting/Load Breaking:	Tested to 125% rated current at 110% rated voltage per IEC309-1 clause 20
Temperature Rise:	Maximum 50°C rise at rated current per IEC309-1 Clause 22, Table 8
Endurance with Load per IEC 60309-1 Clause 21:	16 Amp: 5000 cycles; Load only 32 Amp: 1000 cycles - Alternating load 63 Amp: 1000 cycles - Alternating load 125 Amp: 250 cycles - Alternating load

## ■ PERFORMANCE - ELECTRICAL (SERIES II)

Dielectric Voltage Withstand:	3000 Volts for 1 minute (fixed devices) 2200 Volts for 1 minute (portable devices)
Maximum Working Voltage:	600VAC/250 VDC (minimum creepage and clearances per UL 840)
Current Interrupting/Load Breaking:	Tested to 150% of full rated current for circuit interrupting
Temperature Rise:	Maximum 30°C rise at full rated current after 50 cycles overload at 150% rated load at 0.75-pf
Horsepower Ratings:	Per Nec 430-151b reference for non-interrupting ratings
Endurance with Load per IEC 60309-1 Clause 21:	20 Amp: 5000 cycles; Load only 30 Amp: 1000 cycles - Alternating load 60 Amp: 1000 cycles - Alternating load 100 Amp: 250 cycles - Alternating load

## ■ MATERIALS FOR PIN & SLEEVE (SERIES I & II)

Housing:	Valox®
Contact Carriers:	Valox®
Cable Gland Nut:	Valox®
Cable Bushing:	Solid neoprene, onion ring type
O-Ring, Seals & Gaskets:	Solid neoprene
Plugs:	Nickel plated brass
Sleeve Force Ring:	Zinc plated steel
Terminal Screws:	Nickel plated steel
Flap/Screw Cover Springs:	Stainless steel
SNAP-ON Spring:	Stainless steel
Mounting Flanges:	Valox®

### Standard Interface / World Ready Full International Compliances

EN 60309  
UL Classification to IEC 60309-1 and IEC 60309-2.  
cULus Listing: UL 1682/1686 and CSA C22.2 No. 182.1

CE conforms to EC Low Voltage Directive.

North American and Global Voltage Polarization "clock positions" available in all standard ratings.

### Solid, Safe Voltage Selections

One-Piece contact carriers with Full-Color IEC standard voltage-phasing Coding ensures correct product application every time.

## ■ PERFORMANCE - MECHANICAL (SERIES I)

Cold (-25°C) Impact Resistance:	Per IEC 60309-1 Clause 24; (-25°C) with 75cm drop
Cable O.D. Accommodation:	Round portable service cords from 14.5mm O.D. through 50mm O.D.
Terminal Identification:	In accordance with IEC 60309-1 standards; as L1-L2-L3-N-G
Cable Pull-Out Force:	In accordance with IEC 60309-1, Clause 23

## ■ PERFORMANCE - MECHANICAL (SERIES II)

Cold (-25°C) Impact Resistance:	Per UL 1682 Section 34 and IEC 60309-1 Clause 24
Cable O.D. Accommodation:	Round portable service cord from 0.57" O.D. through 1.79" O.D.
Terminal Identification:	In accordance with UL 1682 standards and IEC 60390-1; as L1-L2-L3-N-G
Cable Pull-Out Force:	Per UL 1682 Section 33 and IEC 60309-1 Clause 23

## ■ PERFORMANCE - ENVIRONMENTAL (SERIES I & II)

Corrosion Resistance:	All metallic components stainless steel or nickel plated brass Sleeve pressure rings of zinc plated steel
-----------------------	--

## ■ MATERIALS FOR BACK BOX (SERIES I & II)

Housing:	PC siloxane
Gasket:	Solid neoprene
Screws:	Stainless steel
Grounding plate:	zinc-coated steel

# Industrial Pin&Sleeve for North American configurations (Series II)

## ■ COLOUR CODE CLOCK POSITION

The operating voltage is identified by conventional colours as shown in the table:

RATED VOLTAGE	COLOUR
110-130V	Yellow
208-250V	Blue
380-480V	Red
500-690V	Black
277V	Grey
125/250V	Orange

## ■ CONNECTOR AND RECEPTACLE (FRONT VIEW)

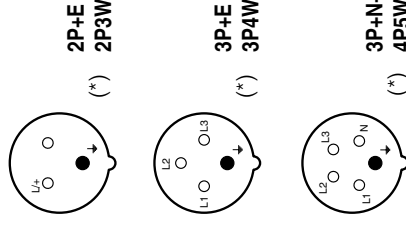

(\*) Major keyway

## ■ CATALOGUE NUMBERING SYSTEM

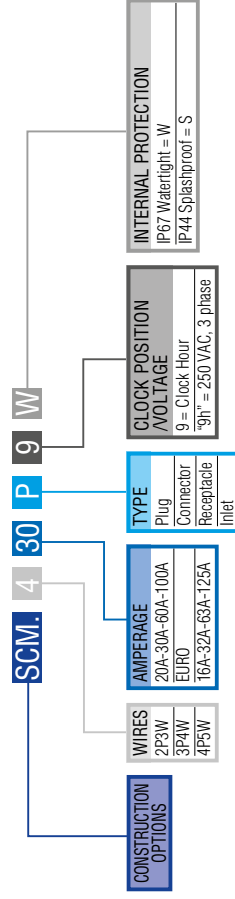

## ■ CLOCK FACE POSITION

North American ratings viewing connector and receptacle from the front, clock hour position (h) is established by the position of the earth contact respect the major keyway which is always situated at 6h clock position.

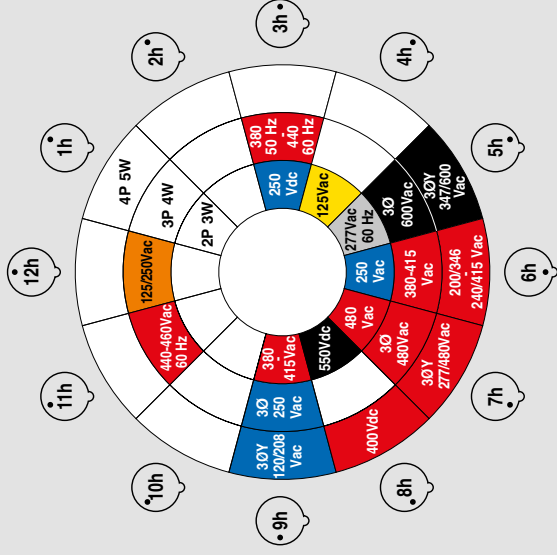



# EUREKA[PIN&SLEEVE] Series

## ■ WATERTIGHT - IP67



IP67

Watertight design and construction meet stringent IP67 internal protection standards. Rugged thermoplastic housings resist impact or abuse and provide excellent corrosion resistance. Unique Scame strain relief grip and sealing system assure superior cable retention and watertight conductor termination. Ideal for outdoor, wet marine and washdown applications. Unique 75% faster assembly with Snap-on handle locking, and cable grip system.

## ■ SPLASHPROOF - IP44



IP44

Suitable for indoor use where splashing liquids and other contaminants may interfere with electrical connections. Ideal for most heavy commercial applications and light industrial applications. Available 16A, 20A, 30A and 32A Amp ratings.



**No Tools, No Screws Necessary**  
Snap-on locking handle saves 75% on assembly time. Unique Snap-on assembly feature on 16A, 20A, 30A and 32A Amp plugs and connectors makes installation and inspection fast and reliable. Captive gaskets in handles seal out water, chemicals and dust.

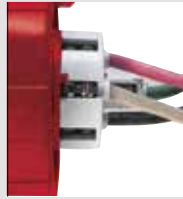

**Easy Action Single-Wiring Point Access Saves Time Wiring**  
All terminal screws face in same direction allowing installer to make safe and secure conductor terminations in 30% less time than other devices. Rugged, corrosion free thermoplastic housings are color-coded for safe reliable connections to all other mating type/polarizations, with raised earth terminal standard.



**Simple Cable Clamping**  
Threaded cable gland on 16/32A and 20/30A devices makes assembly fast and easy. One-piece lock screw verifies clamp locking hold, with no external metal contact possible (16/32A and 20/30A devices).



**Unique and Quick**  
One-piece cable gland with locking screw loads to cable followed by cable grip 6-Finger cable clamp/grip piece. Watertight onion ring bushing fits a wide variety of outside diameters.



**Watertight and cable Grip Safety**  
Grip cable flexible 6-Finger clamp teeth holds well beyond all agency test pullout forces. No internal clamps required. Available in all amperages.



**The Performance Connection**  
Watertight spring-loaded covers with high-strength flex-hinge screw covers on IP67 devices. Flap covers on IP44 splashproof styles. Safety, performance and durability for all EN 60309 applications worldwide.

## ■ WATERTIGHT - IP67

### PLUG

**Safe Connections Standard**  
- Earth contacts make first, break last for safe connections even under load



**75% Faster Cable builds**

- Nylon lock screw System
- One-piece cable gland
- Nylon locking screw prevents loosening
- Hand assembly of cable gland, cable grip
- 6 Finger clamp and onion-ring bushing

**The Easy Way**  
- Snap-on locking feature on all 16/32A and 20/30A plugs and connectors

**Screw Collars Stay Put**  
- Turreted grip allows for easy handling

### CONNECTOR

**Combination Flap/Screw Cover**  
- Integral neoprene gasket for IP67 (Watertight protection)  
- Unique flex hinge design

**Solid Neoprene Gasket In Handle**

**Neoprene Cable Bushing**  
- Onion ring design  
- Universal fit capability

**Secure Grip Handle**  
- Tapered shoulder (16/32A and 20/30A)  
- Ribbed (60/100A and 63/125A)

**Double Secure Wiring**  
- Dual, combination point terminal screw for failsafe connections

**Fast and Easy Wiring**  
- Unique, one-way terminal access  
- Clearly marked terminal connections

**Safe Connections Standard**  
- Earth contacts make first, break last for safe connections even under load

### LIQUID TIGHT ADAPTER



### BACK BOX



Grounding terminals  
Ground plate

## ■ CONTROL DEVICE



## ■ REFERENCE STANDARDS



### EN 60669-1

Switches for household and similar fixed-electrical installations.  
Part 1: general requirements.

## ■ QUALITY MARKS



## ■ VERSIONS

	Single pole switches
	Double pole switches
	Reversing switches
	Two-way switches
	Single pole push button
	Double pole push button

## ■ TECHNICAL CHARACTERISTICS

Rated current:	2A-10A-16A-16AX-20AX
Rated voltage:	250V~
Frequency:	50Hz
Insulating voltage:	250V~
Protection degree:	IP20D
Operating ambient temperature according to the reference standard:	-15°C +35°C
Max operating ambient temperature:	60°C
Glow Wire test:	650°C/750°C
Material:	Engineering plastic
Cabling capacity of the terminals:	2A: 0,5mm <sup>2</sup> -1mm <sup>2</sup> 10A: 1mm <sup>2</sup> -2,5mm <sup>2</sup> 16A: 1mm <sup>2</sup> -4mm <sup>2</sup> 20A: 1mm <sup>2</sup> -6mm <sup>2</sup>
Glow Wire test:	650°C/850°C
Halogen free:	Yes
Material:	Engineering plastic
Colour:	Grey RAL 7035

## ■ BEHAVIOUR WITH CHEMICAL AND ATMOSPHERIC AGENTS

Saline solution	Acids		Bases			Solvents			Mineral oil	UV rays
	Concentrated	Diluted	Concentrated	Diluted	Hexane	Benzol	Acetone	Alcohol		
Resistant	Limited Resistance	Not Resistant	Limited Resistance	Limited Resistance	Not Resistant	Not Resistant	Not Resistant	Limited Resistance	Limited Resistance	Resistant

## ■ APPLICATION EXAMPLES



## DOMESTIC SOCKET-OUTLETS



## REFERENCE STANDARDS

<p><b>CEI 23-50</b></p> <p>Plugs and sockets for domestic and similar applications. <i>Part 1: general requirements.</i></p>
<p><b>IEC 60884-1</b></p> <p>Plugs and socket-outlets for household and similar purposes. <i>Part 1: general requirements.</i></p>

## QUALITY MARKS



## VERSIONS

	Socket-outlet - European Standard
	Socket-outlet - International Standard

## TECHNICAL CHARACTERISTICS

Rated current:	10A-13A-15A-16A-20A
Rated voltage:	250V~
Frequency:	50Hz
Insulating voltage:	250V~
Protection degree:	IP20D
Operating ambient temperature according to the reference standard:	-155°C +35°C
Max. operating ambient temperature:	60°C
Glow Wire test:	650°C/750°C
Material:	Engineering plastic
Cabling capacity of the terminal:	10A: 1mm <sup>2</sup> ±2.5mm <sup>2</sup> 13A: 1.5mm <sup>2</sup> ±4mm <sup>2</sup> 15A: 1.5mm <sup>2</sup> ±4mm <sup>2</sup> 16A: 1mm <sup>2</sup> ±4mm <sup>2</sup> 20A: 1mm <sup>2</sup> ±6mm <sup>2</sup>
Glow Wire test:	650°C/850°C
Halogen free:	Yes
Colour:	Grey RAL 7035 Red

## BEHAVIOUR WITH CHEMICAL AND ATMOSPHERIC AGENTS

Saline solution	Acids		Bases			Solvents			Mineral oil	UV rays
	Concentrated	Diluted	Concentrated	Diluted	Hexane	Benzol	Acetone	Alcohol		
Resistant	Limited Resistance	Not Resistant	Limited Resistance	Limited Resistance	Not Resistant	Not Resistant	Not Resistant	Limited Resistance	Limited Resistance	Resistant

## AVAILABLE STANDARDS

	ITALIAN STANDARD P10- 10A Shuttered socket CEI 23-50		ITALIAN STANDARD P11- 16A Shuttered socket CEI 23-50		ITALIAN STANDARD P17/11- 16A Shuttered socket Bivalente CEI 23-50		ITALIAN STANDARD P30- 16A Shuttered socket CEI 23-50		PLURISTANDARD P40- 16A Shuttered socket CEI 23-50		GERMAN STANDARD - 16A Shuttered socket DIN VDE 0620
	FRENCH STANDARD - 16A Shuttered socket NFC 61-314		BRITISH STANDARD - 13A Shuttered socket BS 1363-2		BRITISH STANDARD - 15A Shuttered socket BS 546		ARGENTINIAN STANDARD - 10A Unshuttered IRAM 2071		ARGENTINIAN STANDARD - 20A Unshuttered IRAM 2071		EURO-AMERICAN STANDARD - 15A Shuttered socket
	NEW ZEALAND STANDARD - 10A Unshuttered socket AS/NZS 3112		SOUTH AFRICAN STANDARD - 16A Shuttered socket SANS 164-1 (2006)		BRAZILIAN STANDARD - 10A Unshuttered socket ABNT NBR 14136:2002		INDIAN STANDARD - 6/16A Shuttered socket IS 1293:1988				

## APPLICATION EXAMPLES







## TV/SAT OUTLETS (Ø 9,5mm)



### VERSIONS

	TV outlets Male - Direct - Terminal - Attenuation 12 dB
	Coax/sat. F outlets - Direct
	TV/SAT outlets

### REFERENCE STANDARDS

<b>CEI EN 50083</b> Communal aerial installations.
<b>IEC 60169</b> Radio-frequency connectors.

### QUALITY MARKS



### TECHNICAL CHARACTERISTICS

Frequency:	TV: 5-862 Mhz SAT: 950-2400 Mhz
Protection degree:	IP20D
Operating ambient temperature according to the reference standard:	-15°C +35°C
Max. operating ambient temperature:	60°C
Material:	Engineering plastic
Halogen free:	Yes
Colour:	Grey RAL 7035

### BEHAVIOUR WITH CHEMICAL AND ATMOSPHERIC AGENTS

Saline solution	Acids		Bases			Solvents			Mineral oil	UV rays
	Concentrated	Diluted	Concentrated	Diluted	Hexane	Benzol	Acetone	Alcohol		
Resistant	Limited Resistance	Not Resistant	Limited Resistance	Limited Resistance	Not Resistant	Not Resistant	Not Resistant	Limited Resistance	Limited Resistance	Resistant

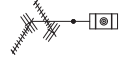
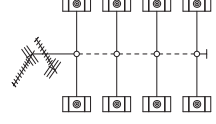
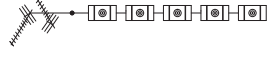
Direct	Terminal	Attenuation 12dB
		

### APPLICATION EXAMPLES



# FIXER Series

## CONDUIT FIXING ACCESSORIES



## TECHNICAL CHARACTERISTICS (Engineering plastic versions)

For tube Ø (mm):	16 - 20 - 25 - 32 - 40 - 50
Operating ambient temperature:	-15°C +60°C
Max. operating ambient temperature:	60°C
Halogen free:	Yes
Material:	Engineering plastic
Colour:	Grey RAL 7035

## ENGINEERING PLASTIC VERSIONS

	Snap clip
	Snap clip with plug and screw
	Collar clip
	Collar clip
	Pressure clip

## METAL VERSIONS

	Spacer bracket with M6 threaded base
	Half-saddle standard type
	Half-saddle heavy duty type
	Saddle

## BEHAVIOUR WITH CHEMICAL AND ATMOSPHERIC AGENTS (ENGINEERING PLASTIC VERSIONS)

Saline solution	Acids		Bases			Solvents			Mineral oil	UV rays
	Concentrated	Diluted	Concentrated	Diluted	Hexane	Benzol	Acetone	Alcohol		
Resistant	Limited Resistance	Resistant	Resistant	Resistant	Not Resistant	Not Resistant	Not Resistant	Limited Resistance	Resistant	Resistant

## ACCESSORIES FOR RIGID CONDUITS

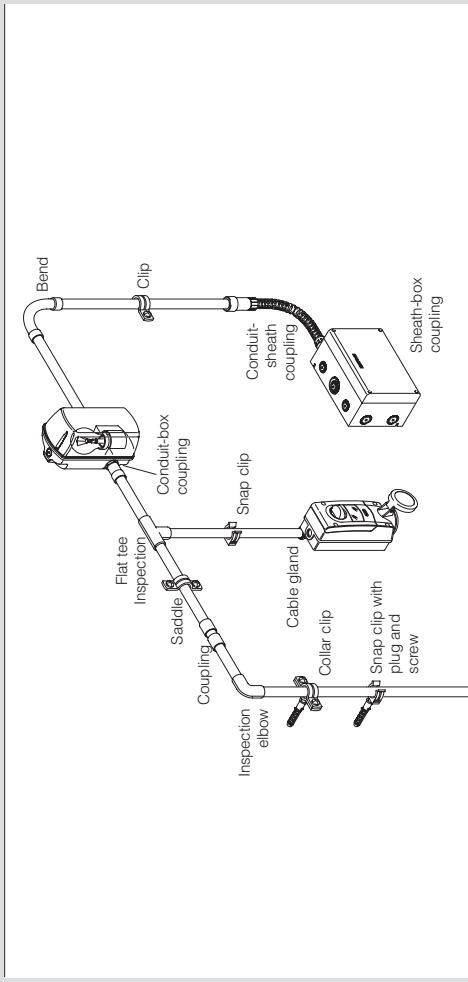

## APPLICATION EXAMPLES



## FLUSH MOUNTING CONSUMER UNITS



## REFERENCE STANDARDS

### EN 60670-1

Boxes and enclosures for electrical accessories for household and similar fixed electrical installations. Part 1: General requirements.

### EN 60670-24

Boxes and enclosures for electrical accessories for household and similar fixed electrical installations. Part 24: Particular requirements for enclosures for housing protective devices and other power dissipating electrical equipment.

## BEHAVIOUR WITH CHEMICAL AND ATMOSPHERIC AGENTS

Saline solution	Acids		Bases			Solvents			Mineral oil	UV rays
	Concentrated	Diluted	Concentrated	Diluted	Hexane	Benzol	Acetone	Alcohol		
Resistant	Limited Resistance	Resistant	Limited Resistance	Resistant	Limited Resistance	Limited Resistance	Limited Resistance	Resistant	Resistant	Resistant

## VERSIONS



Flush and hollow mounting

## TECHNICAL CHARACTERISTICS

Rated voltage:	400V~
Protection degree:	IP40
Operating ambient temperature according to the reference standard:	-15°C +60°C
Max. operating ambient temperature:	+60°C
Glow wire test:	650°C (enclosure) 850°C (enclosure) 960°C (terminal boards)
Material:	Engineering plastic (enclosure and terminal boards) Painted steel (door)
Insulation class:	Class II (double insulation) <input type="checkbox"/>
Halogen free:	Yes
Power dissipation:	25W (12 mod.) - 40W (24 mod.) 55W (36 mod.) - 75W (48 mod.)
Colour:	White
Terminal blocks:	Yes

## ACCESSORIES



Accessories for flush mounting included.



Accessories for hollow mounting.



Terminal blocks (2x16mm<sup>2</sup> + 14x10mm<sup>2</sup>) included.

## APPLICATION EXAMPLES





## ■ DISTRIBUTION ASSEMBLIES



## ■ REFERENCE STANDARDS

### EN 60670-1

Boxes and enclosures for electrical accessories for household and similar fixed electrical installation.  
*Part 1: general requirements.*

### EN 61439-3

Low-voltage switchgear and controlgear assemblies.  
*Part 3: distribution boards intended to be operated by ordinary persons (DBO).*

### EN 61439-4

Low-voltage switchgear and controlgear assemblies.  
*Part 4: particular requirements for assemblies for construction sites (ACS)*

## ■ BEHAVIOUR WITH CHEMICAL AND ATMOSPHERIC AGENTS (DISTRIBUTION ASSEMBLIES)

Saline solution	Acids		Bases		Solvents			Mineral oil	UV rays
	Concentrated	Diluted	Concentrated	Diluted	Hexane	Benzol	Acetone		
Resistant	Limited Resistance	Resistant	Limited Resistance	Resistant	Not Resistant	Not Resistant	Not Resistant	Limited Resistance	Resistant

## ■ BEHAVIOUR WITH CHEMICAL AND ATMOSPHERIC AGENTS (EMPTY UNITS)

Saline solution	Acids		Bases		Solvents			Mineral oil	UV rays
	Concentrated	Diluted	Concentrated	Diluted	Hexane	Benzol	Acetone		
Resistant	Resistant	Resistant	Resistant	Resistant	Resistant	Resistant	Resistant	Resistant	Resistant

## ■ VERSIONS



Distribution assemblies  
- Portable with cable and plug



Two-front units distribution assemblies  
- 3+3 socket outlets  
- 4+4 socket outlets

## ■ TECHNICAL CHARACTERISTICS

Protection degree:	IP44
Operating ambient temperature according to the reference standard:	-25°C +40°C
Max operating ambient temperature:	60°C
Glow Wire test:	960°C
IK degree at 20°C:	IK09 (distribution assemblies) IK10 (empty units)
Terminal blocks fixing possibility:	Yes
DIN rail fixing:	Yes
Power output:	max. 18KW
Material:	Rubber
Colour:	Black

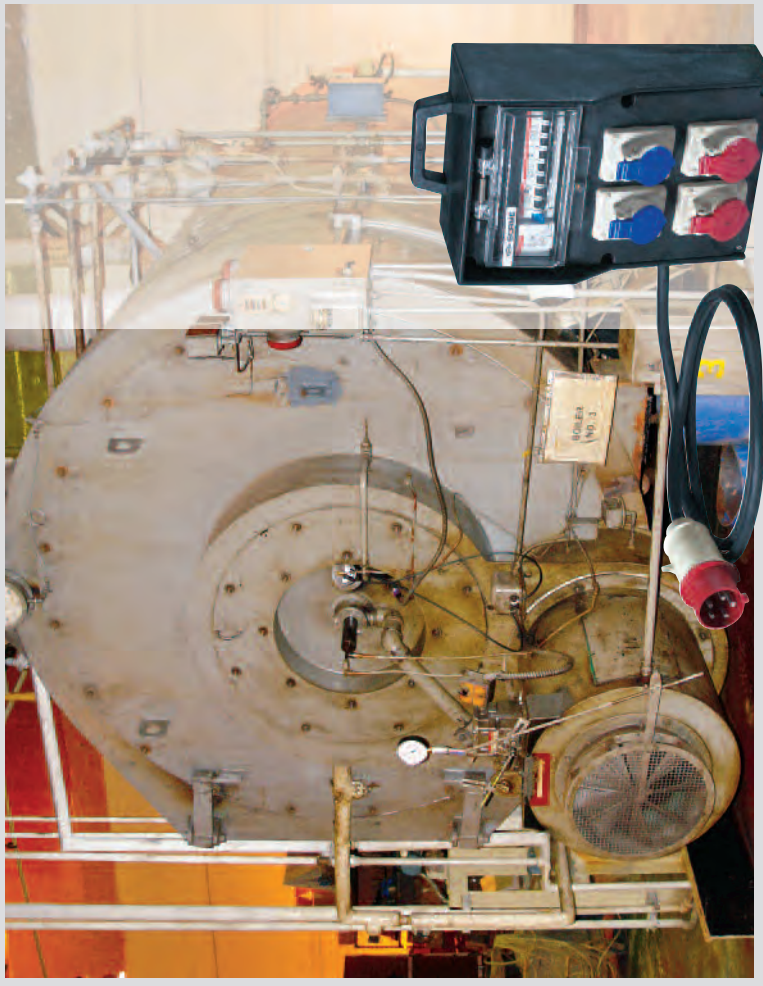

## ■ APPLICATION EXAMPLES



## ■ LIGHT FITTINGS



## ■ VERSIONS

 HALE Series - IP20 - Standard version - Heavy duty version	 HALE Series - IP65
---	---

## ■ REFERENCE STANDARDS

<b>EN 60598-1</b> Luminaires. <i>Part 1: general requirements and tests.</i>
<b>EN 60598-2-8</b> Luminaires. <i>Part 2: particular requirements.</i>

## ■ QUALITY MARKS



## ■ TECHNICAL CHARACTERISTICS

Protection degree:	IP20-IP65
Operating ambient temperature according to the reference standard:	-5°C +35°C
Rated wattage:	60W
Glow Wire test:	650°C
IK degree at 20°C:	IK08 (IP65 version) IK09 (IP20 version)
Cable inlet:	8-13mm (version without cable)
Insulation class:	Class II (double insulation) □
Lampholder type:	E27
Material:	Engineering plastic

## ■ BEHAVIOUR WITH CHEMICAL AND ATMOSPHERIC AGENTS

Saline solution	Acids		Bases			Solvents			Mineral oil	UV rays
	Concentrated	Diluted	Concentrated	Diluted	Hexane	Benzol	Acetone	Alcohol		
Resistant	Limited Resistance	Resistant	Limited Resistance	Limited Resistance	Limited Resistance	Not Resistant	Not Resistant	Resistant	Limited Resistance	Resistant

## ■ INSTALLATION

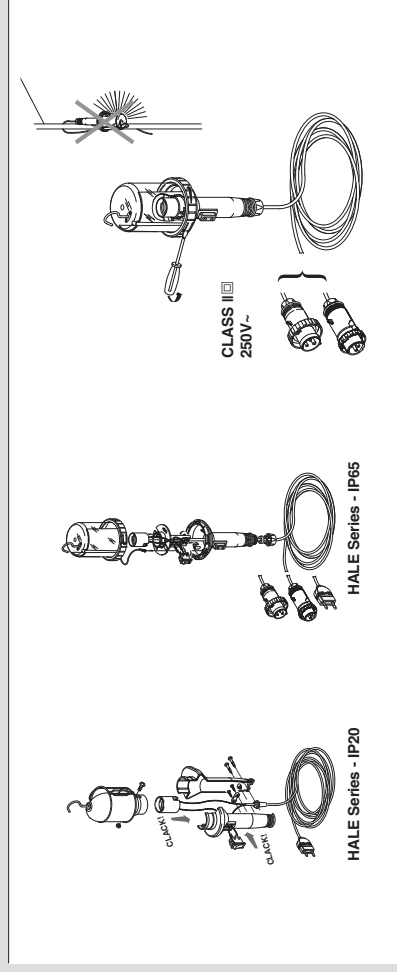

## ■ APPLICATION EXAMPLES





## ■ LIGHT FITTINGS





## ■ REFERENCE STANDARDS

<p><b>EN 60598-1</b> Luminaires. <i>Part 1: general requirements and tests.</i></p>
<p><b>EN 60598-2-1</b> Luminaires. <i>Part 2: particular requirements. Section 1: fixed general purpose luminaires.</i></p>

## ■ QUALITY MARKS



## ■ VERSIONS

	Bulkhead light oval
	Bulkhead light round
	Bulkhead light square

## ■ TECHNICAL CHARACTERISTICS

Protection degree:	<b>IP44 - IP65</b>
Operating ambient temperature according to the reference standard:	<b>-25°C +35°C</b>
Rated wattage:	<b>Max. 100W</b>
Glow Wire test:	<b>850°C</b>
Grado IK a 20°C:	<b>IK08 - IK10</b>
Cable inlet:	<b>PG9 - PG13,5</b>
Insulation class:	<b>Class II (double insulation)</b> <input type="checkbox"/>
Lampholder type:	<b>E27 - B22</b>
Installation on inflammable surface:	<b>Yes</b>
Material:	<b>Engineering plastic</b>

## ■ BEHAVIOUR WITH CHEMICAL AND ATMOSPHERIC AGENTS

Saline solution	Acids		Bases				Solvents				Mineral oil	UV rays	
	Concentrated	Diluted	Concentrated	Diluted	Hexane	Benzol	Acetone	Alcohol	Not Resistant	Resistant			Resistant
Resistant	Limited Resistance	Resistant	Limited Resistance	Limited Resistance	Limited Resistance	Not Resistant	Not Resistant	Resistant	Resistant	Limited Resistance	Resistant	Limited Resistance	Resistant

## ■ POLE DIAGRAM

**E27**  
- Incandescent bulb: 100W E27  
- Total flux: 1350 lm

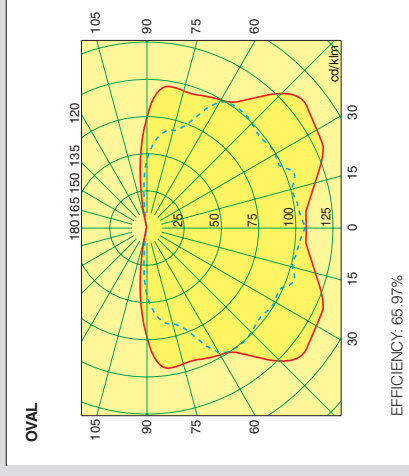
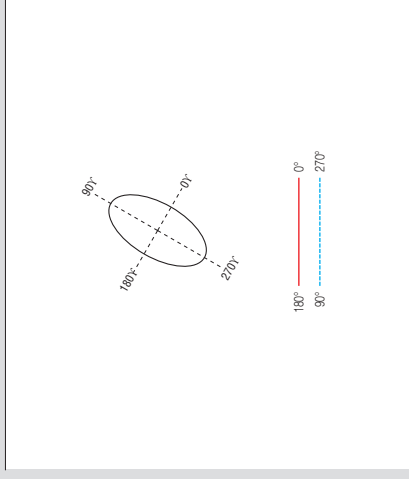

## ■ SQUARE

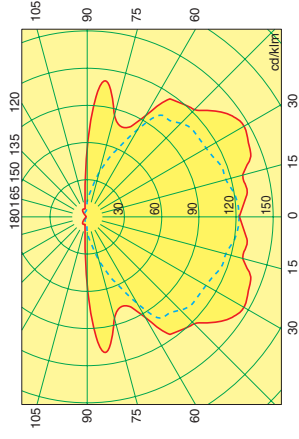

EFFICIENCY: 66.17%

Co-ordinates system: c-gamma

## ■ ROUND

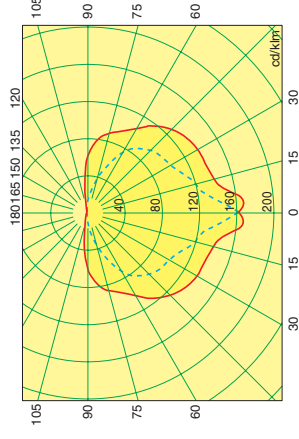

EFFICIENCY: 63.97%

## ■ ALUMINIUM ENCLOSURE - 16A-160A



### EN 60947-3

Low voltage switchgear and controlgear.  
Part 3: switches, disconnectors, switch-disconnectors  
and fuse-combination unit.

### EN 60529

Degrees of protection provided by enclosure.

## ■ REFERENCE STANDARDS

## ■ CABLE INLETS Aluminium enclosure 2, 3, 4 poles

Size	Rated current (A)	Nr of poles	Enclosure dimensions	Cable entries	
1	20-32-40	2-3-4	150x105x82	Top	1xM20+1xM25
				Bottom	1xM20+1xM25
2	63-80-100	2-3-4	210x155x107	Top	2xM32
				Bottom	2xM32
3	125	3-4	315x264x122	Top	Threaded entries
				Bottom	Threaded entries
4	160	3-4	410x315x128	Top	Blank side (*)
				Bottom	Blank side (*)

(\*) Perforated or threaded entries on request.

## ■ CABLE INLETS Aluminium enclosure 6 and 8 poles

Size	Rated current (A)	Nr of poles	Enclosure dimensions	Cable entries	
2	16-25-32-40	6-8	210x155x107	Top	2xM32
				Bottom	2xM32
3	63-80-100	6-8	315x264x122	Top	Threaded entries
				Bottom	Threaded entries
4	125-160	6-8	410x315x128	Top	Blank side (*)
				Bottom	Blank side (*)

(\*) Perforated or threaded entries on request.

## ■ APPLICATION EXAMPLES



## ■ TECHNICAL CHARACTERISTICS

Polarity:	<b>2P-3P-3P-N-4P-6P-8P</b>
Rated current:	<b>16A-20A-25A*-32A-40A-63A 80A-100A-125A-160A</b>
Protection degree:	<b>IP65</b>
Operating ambient temperature according to the reference standard:	<b>-5°C +40°C</b>
Min-Max. operating ambient temperature:	<b>-25°C +60°C</b>
Material:	<b>Die-cast aluminium</b>
IK degree:	<b>IK10</b>
Colour:	<b>Grey RAL7015</b>

3P-4N with late break early make neutral pole.

Equipped with door locking.

Padlockable handle.

\* Only for 6 and 8 poles.

## ■ VERSIONS

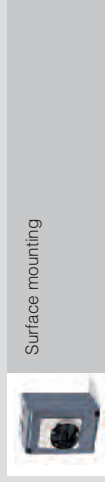

Surface mounting

## ■ BEHAVIOUR WITH CHEMICAL AND ATMOSPHERIC AGENTS

Saline solution	Acids		Bases			Solvents			Mineral oil	Rayons UV
	Concentrated	Diluted	Concentrated	Diluted	Diluted	Hexane	Benzol	Acetone	Alcohol	Resistant
Resistant	Limited Resistance	Resistant	Limited Resistance	Limited Resistance	Limited Resistance	Resistant	Limited Resistance	Limited Resistance	Resistant	Resistant

## ■ TECHNICAL DATA SWITCH DISCONNECTORS 2P, 3P, 3P+N, 4P

Rated insulation voltage	UI	20A	32A	40A	63A	80A	100A	125A	160A
		VAC	690	690	690	690	690	800	800
Rated impulse withstand voltage	Uimp	kV	4	4	4	4	4	8	8
Thermal current	Ith/Ithe	A	30	40	40	63	86	100	125
AC21A Resistive loads, including moderate overloads	415V	A	20	32	40	63	80	100	125
	500V	A	20	32	32	63	80	100	125
	690V	A	20	32	32	63	80	100	125
AC22A Mixed resistive and inductive loads, including moderate overloads	415V	A	20	32	40	63	80	100	125
	500V	A	20	32	32	63	80	100	125
	690V	A	20	32	32	63	80	100	125
AC23A Switching of motor loads or other highly inductive loads (3 phase / 3 pole)	415V	A	20	32	35	63	67	100	125
	500V	A	20	25	25	40	67	-	125
	690V	A	20	25	25	30	38	-	100
AC23A Rated operational power		kW	9	15	18.5	33	37	46	55
AC3		A	-	28.5	28.5	40	55	-	-
DC22A		A	12	20	20	25	32	-	-
Rated short time withstand current - low (1s)		A	25(*)	32(*)	32(*)	-	-	-	-
		A	10(*)	10(*)	10(*)	-	-	-	-
Rated short time withstand current - Ip		A	400	400	400	1500	1500	3000	3000
Conditionnal short circuit current		kAeff	10	10	10	10	10	30	50
Associate fuse size for conditional short circuit current - Type gG		A	20	32	40	63	80	100	125
Flexible wire		mm²	1.5-10	1.5-10	1.5-10	10-35	10-35	10-70	10-70
Rigid wire		mm²	1.5-16	1.5-16	1.5-16	10-35	10-35	10-50	10-70

(\*) Only 4P with 2+2 poles in series.

## 4P SWITCH LINKING FOR DC APPLICATION



## ■ TECHNICAL DATA SWITCH DISCONNECTORS 6 AND 8 POLES

Rated insulation voltage	UI	16A	25A	32A	40A	63A	80A	100A	125A	160A
		VAC	800	800	800	800	800	800	800	800
Rated impulse withstand voltage	Uimp	kV	8	8	8	8	8	8	8	8
Thermal current	Ith/Ithe	A	16	25	32	40	63	80	100	125
AC21A Resistive loads, including moderate overloads	415V	A	16	25	32	40	63	80	100	125
	500V	A	16	25	32	40	63	80	100	125
	690V	A	16	25	32	40	63	80	100	125
AC22A Mixed resistive and inductive loads, including moderate overloads	415V	A	16	25	32	40	63	80	100	125
	500V	A	16	25	32	40	63	80	100	125
	690V	A	16	25	32	40	63	80	100	125
AC23A Switching of motor loads or other highly inductive loads (3 phase / 3 pole)	415V	A	16	25	32	40	63	80	100	125
	500V	A	16	25	32	40	63	80	100	125
	690V	A	16	25	32	40	63	80	100	125
AC23A Rated operational power		kW	7.5	11	15	18.5	35	37	46	
Rated short time withstand current - low (1s)		A	1100	1100	1100	1500	1500	3000	3000	
Conditionnal short circuit current		kAeff	50	50	50	50	50	30	50	
Associate fuse size for conditional short circuit current - Type gG		A	16	25	32	40	63	80	100	
Flexible wire		mm²	4-25	4-25	4-25	4-25	10-50	10-50	10-70	
Rigid wire		mm²	4-25	4-25	4-25	4-25	10-50	10-50	10-70	





## ■ HIGH RATING HINGED SHEET STEEL ENCLOSURE - 200A-1600A



## ■ REFERENCE STANDARDS

### EN 60947-3

Low voltage switchgear and controlgear.  
Part 3: switches, disconnectors, switch-disconnectors  
and fuse-combination unit.

### EN 60529

Degrees of protection provided by enclosure.

## ■ VERSIONS



Surface mounting

## ■ TECHNICAL CHARACTERISTICS

Polarity:	<b>3P-3P+N</b>
Rated current:	<b>160A-200A-250A-315A-400A 500A-630A-800A-1000A 1250A-1600A (*)</b>
Protection degree:	<b>IP65</b>
Operating ambient temperature according to the reference standard:	<b>-5°C +40°C</b>
Min-Max. operating ambient temperature:	<b>-25°C +60°C</b>
Material:	<b>Sheet steel</b>
IK degree:	<b>IK10</b>
Finishing/colour:	<b>Polyester powder grey RAL7032</b>

3P+N with late break early make neutral pole.  
Padlockable handle.  
Equipped with door locking.  
Full current neutral pole up to 1250A.  
(\*) Neutral pole 1250A  
Full current neutral pole available on request.

## ■ BEHAVIOUR WITH CHEMICAL AND ATMOSPHERIC AGENTS

Saline solution	Acids		Bases		Solvents			Mineral oil	Rayons UV
	Concentrated	Diluted	Concentrated	Diluted	Hexane	Benzol	Acetone		
Resistant	Limited Resistance	Resistant	Resistant	Resistant	Resistant	Resistant	Resistant	Resistant	Resistant

## ■ CABLE INLETS

Hinged sheet steel enclosure  
3P, 3P+N top/bottom entries

Size	Rated current (A)	Nr of poles	Enclosure dimensions	Cable entries	
1	200-250	3-3P+N	500x300x150	Top Bottom	Gland plate Gland plate
2	315-400-500-630	3-3P+N	600x400x200	Top Bottom	Gland plate Gland plate
3	800-1000-1250	3-3P+N	700x500x250	Top Bottom	Gland plate Gland plate
4	1600	3-3P+N	1000x600x300	Top Bottom	Gland plate Gland plate

Perforated or threaded entries on request.

Hinged sheet steel enclosure  
3P, 3P+N bottom/bottom entries

Size	Rated current (A)	Nr of poles	Enclosure dimensions	Cable entries	
1	200-250	3-3P+N	500x300x150	Top Bottom	Gland plate Gland plate
2	315-400	3-3P+N	600x400x200	Top Bottom	Gland plate Gland plate
3	500	3-3P+N	700x500x250	Top Bottom	Gland plate Gland plate
4	630-800	3-3P+N	800x600x300	Top Bottom	Gland plate Gland plate
5	1000-1250-1600	3-3P+N	1000x1000x600	Top Bottom	Gland plate Gland plate

## ■ CONNECTIONS

### BOTTOM/BOTTOM ENTRIES

Equipped with an insulated bar system which allows the wiring both incoming and outgoing cables from the bottom side without cable bending.

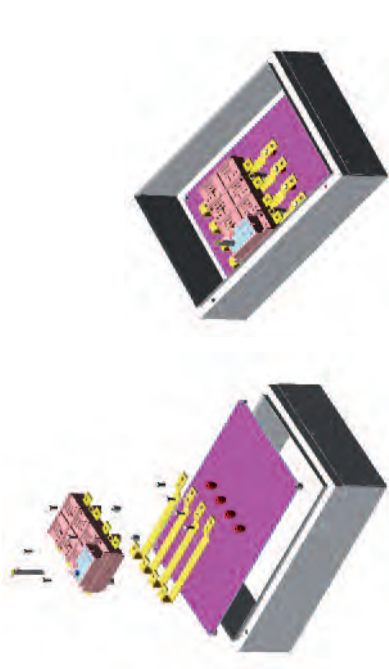

## ■ APPLICATION EXAMPLES



## ■ TECHNICAL DATA HIGH RATING SWITCH DISCONNECTORS 3P AND 3P+N

	160A	200A	250A	315A	400A	500A	630A	800A	1000A	1250A	1600A(*)
Rated insulation voltage	(V) 1000	1000	1000	1000	1000	1000	1000	1000	1000	1000	1000
Rated impulse withstand voltage	(kV) 12	12	12	12	12	12	12	12	12	12	12
Thermal current	(A) 160	200	250	315	400	500	630	800	1000	1250	1600
<b>AC21A</b> Resistive loads, including moderate overloads	415V	160	200	250	315	400	500	630	800	1000	1250
	500V	160	200	250	315	400	500	630	800	1000	1250
	690V	160	200	250	315	400	500	630	800	1000	1250
<b>AC22A</b> Mixed resistive and inductive loads, including moderate overloads	415V	160	200	250	315	400	500	630	800	1000	1250
	500V	160	200	250	315	400	400	630	800	1000	1250
<b>AC23A</b> Switching of motor loads or other highly inductive loads (3 phase / 3 pole)	415V	160	200	250	315	400	500	630	800	1000	1250
	500V	125	125	200	250	315	315	500	800	800	800
<b>AC23A</b> Rated operational power	690V	100	160	160	200	250	250	400	400	400	400
	415V	85	105	130	165	200	210	330	420	525	630
Rated making capacity	(A) 1600	2000	2500	3150	4000	4000	6300	6300	6300	6300	6300
Rated breaking capacity	(A) 1280	1600	2000	2520	3200	3200	5040	5040	5040	5040	5040
Short circuit withstand current 1sec	(kA) 8	8	8	13	13	13	26.5	26.5	26.5	26.5	26.5
Short circuit withstand current 0.25 sec	(kA) 16	16	16	26	26	26	53	53	53	53	53
Short circuit making capacity	(kA) 13.5	13.5	13.5	26	26	26	30	30	30	30	30
Back up fuse	(A) 160	200	250	315	400	400	630	800	1000	1000	-
R.M.S value	(kA) 100	50	50	50	50	50	50	100	100	100	-
Peak value	(kA) 16	20	25	25	30	30	40	70	90	100	-
Cable section	mm <sup>2</sup> 120	120	120	185	2x150	2x150	2x185	2x240	-	-	-
Bars dimension	mm 20x5	20x5	20x5	2x (25x4)	2x (25x4)	2x (25x4)	2x (32x6)	2x (50x5)	2x (50x6)	2x (50x8)	2x (80x102)

(\*) Neutral pole 1250A.  
Full current neutral pole available on request.

## ■ AUXILIARY CONTACTS

	590.PL00400x	590.PL005	590.PL0060x
Rated thermal current	400V	10A	10A
Rated operational current AC15	250V	16A	16A
	400V	-	-
Break before main contacts switches.	250V	1A	1A
	400V	6A	6A

### ■ STAINLESS STEEL ENCLOSURE - 16A-160A



### ■ VERSIONS



Surface mounting

### ■ REFERENCE STANDARDS

#### EN 60947-3

Low voltage switchgear and controlgear.  
Part 3: switches, disconnectors, switch-disconnectors  
and fuse-combination unit.

#### EN 60529

Degrees of protection provided by enclosure.

### ■ CABLE INLETS

Stainless steel enclosure 3 and 4 poles

Size	Rated current (A)	Nr of poles	Enclosure dimensions	Cable entries
1	20-32-40	3-4	176x136x65	Top
				Bottom
				Rear
2	63-80-100	3-4	226x176x90	Top
				Bottom
				Rear
3	125-160	3-4	306x226x115	Top
				Bottom
				Rear

Perforated or threaded entries on request.

### ■ CABLE INLETS

Stainless steel enclosure 6 and 8 poles

Size	Rated current (A)	Nr of poles	Enclosure dimensions	Cable entries
3	16-25-32-40-63-80-100-125-160	6-8	306x226x115	Top
				Bottom
				Rear

Perforated or threaded entries on request.

### ■ TECHNICAL CHARACTERISTICS

Polarity:	2P-3P-3P+N-6P-8P
Rated current:	16A*-20A-25A*-32A-40A-63A 80A-100A-125A-160A
Protection degree:	IP65
Operating ambient temperature according to the reference standard:	-5°C +40°C
Min-Max. operating ambient temperature:	-25°C +60°C
IK degree:	IK10
Material:	Stainless steel 304L (316L stainless steel on request)

3P+N with late break early make neutral pole.  
Equipped with door locking.  
Padlockable handle.  
\* Only for 6 and 8 poles.

### ■ BEHAVIOUR WITH CHEMICAL AND ATMOSPHERIC AGENTS

Saline solution	Acids		Bases			Solvents			Mineral oil	Rayons UV
	Concentrated	Diluted	Concentrated	Diluted		Hexane	Benzol	Acetone	Alcohol	
Resistant	Resistant	Resistant	Resistant	Resistant		Resistant	Resistant	Resistant	Resistant	Resistant
Limited Resistance	Resistant	Resistant	Resistant	Resistant		Resistant	Resistant	Resistant	Resistant	Resistant

### ■ APPLICATION EXAMPLES



## ■ TECHNICAL DATA SWITCH DISCONNECTORS 2P,3P, 3P+N

		20A	32A	40A	63A	80A	100A	125A	160A
Rated insulation voltage	Ui	VAC	690	690	800	800	800	800	800
Rated impulse withstand voltage	Uimp	kV	4	4	4	4	4	4	4
Thermal current	Ith/Ithe	A	30	40	40	63	80	100	125
Rated operational current - Ie	<b>AC21A</b>	415V	A	20	32	40	63	80	100
	Resistive loads, including moderate overloads	500V	A	20	32	32	63	80	100
		690V	A	20	32	32	63	80	100
Rated operational current - Ie	<b>AC22A</b>	415V	A	20	32	40	63	80	100
	Mixed resistive and inductive loads, including moderate overloads	500V	A	20	32	32	63	80	100
		690V	A	20	32	32	40	40	-
Rated operational current - Ie	<b>AC23A</b>	415V	A	20	32	35	63	80	100
	Switching of motor loads or other highly inductive loads (3 phase / 3 pole)	500V	A	20	25	25	63	63	-
		690V	A	20	25	25	32	32	-
Rated operational current - Ie	<b>AC23A</b> Rated operational power	415V	kW	9	15	18.5	35	37	46
	<b>AC3</b>	400V	A	-	28.5	28.5	-	-	-
Squirrel-cage motor: starting, switching off motor during running (3 phase / 3 pole)		690V	A	12	20	20	25	32	-
Rated short time withstand current <b>Iow</b> (1s)									
Conditional short circuit current <b>Ib</b>									
Associate fuse size for conditional short circuit current - Type gG									
Flexible wire									
Rigid wire									

## ■ TECHNICAL DATA SWITCH DISCONNECTORS 6 AND 8 POLES

		16A	25A	32A	40A	63A	80A	100A	125A	160A
Rated insulation voltage	Ui	VAC	800	800	800	800	800	800	800	800
Rated impulse withstand voltage	Uimp	kV	8	8	8	8	8	8	8	8
Thermal current	Ith/Ithe	A	16	25	32	40	63	80	100	125
Rated operational current - Ie	<b>AC21A</b>	415V	A	16	25	32	40	63	80	100
	Resistive loads, including moderate overloads	500V	A	16	25	32	40	63	80	100
		690V	A	16	25	32	40	63	80	100
Rated operational current - Ie	<b>AC22A</b>	415V	A	16	25	32	40	63	80	100
	Mixed resistive and inductive loads, including moderate overloads	500V	A	16	25	32	40	63	80	100
		690V	A	16	25	32	40	40	40	
Rated operational current - Ie	<b>AC23A</b>	415V	A	16	25	32	40	63	80	100
	Switching of motor loads or other highly inductive loads (3 phase / 3 pole)	500V	A	16	25	32	40	63	63	
		690V	A	16	25	25	32	32	32	
Rated operational current - Ie	<b>AC23A</b> Rated operational power	415V	kW	7.5	11	15	18.5	35	37	
	<b>AC3</b>	400V	A	1100	1100	1100	1500	1500	3000	
Squirrel-cage motor: starting, switching off motor during running (3 phase / 3 pole)										
Rated short time withstand current <b>Iow</b> (1s)										
Conditional short circuit current <b>Ib</b>										
Associate fuse size for conditional short circuit current - Type gG										
Flexible wire										
Rigid wire										



## ■ PHOTOVOLTAIC/DC SWITCH DISCONNECTORS THERMOPLASTIC INSULATED ENCLOSURE 10A-40A (800V DC)



### ■ VERSIONS



Surface mounting

Scame embraces completely the renewable energy sources philosophy and the respect for the environment. In our production plant and office building we have installed 250kWp of photovoltaic system. We follow up this field in several countries with a wide range of products.

From our experience is born the new range of DC Isolators specific for photovoltaic systems.

In accordance to the IEC 60364-7-712, in every photovoltaic installation it is necessary to isolate the photovoltaic panel from the rest of the system, DC Isolators must have a higher performance than the traditional AC Isolators because breaking direct current is more difficult than breaking alternating current, and furthermore in a photovoltaic system the voltage can reach even 800V.

The current and voltage values changes depending on the combination of the photovoltaic cells. DC Isolator range has been set up focusing on all of the main photovoltaic installations in order to get a range as essential as possible, simplify the choice of the customer and for have the maximum quality and technical characteristics. In the meantime we are improving and

## ■ REFERENCE STANDARDS

### EN 60947-3

Low voltage switchgear and controlgear.  
*Part 3: switches, disconnectors, switch-disconnectors and fuse-combination unit.*

### IEC 60364-7-712

Requirements for special installations or locations  
Solar photovoltaic (PV) power supply systems.

### EN 60529

Degrees of protection provided by enclosure.

## ■ CABLE INLETS

Photovoltaic/DC switch disconnectors thermoplastic insulated enclosure 3 and 4 poles

Size	Rated current (A)	Rated voltage (V)	Nr of poles in series	Enclosure dimensions	Cable entries	
1	16	450V	4	150x105x82	Top	1xM20+1xM25
					Bottom	1xM20+1xM25
					Rear	1xM20+1xM25
2	15-20	800V	3-4-5	150x105x100	Top	-
					Bottom	Blank side (*)
					Rear	Blank side (*)
					Right	Blank side (*)
					Left	M25
					Knock-out	M25
3	25-30	800V	6-8	210x155x107	Top	2xM32
					Bottom	2xM32
					Rear	-
					Left	-
					Right	-
					Knock-out	-
4	40	800V	8	308x228x128	Top	-
					Bottom	-
					Knock-out	Blank side (*)

(\*) Perforated or threaded entries on request.

## ■ TECHNICAL CHARACTERISTICS

Poles in series:	3P-4P-5P-6P-8P
Rated current (800V):	10A-15A-20A-25A-30A-40A
Protection degree:	IP65
Operating ambient temperature according to the reference standard:	-5 °C +40 °C
Min-Max. operating ambient temperature:	-25°C +60°C
IK degree:	IK08
Material:	Thermoplastic
Insulation class:	Class II (double insulation) <input checked="" type="checkbox"/>
Glow wire test:	650°C (enclosure) 850°C (switch)

up grading constantly our products, following and anticipating the change that the market requires due to the incentives available. Scame ISOLATORS Series includes also a complete range of AC Isolators, essential to make a photovoltaic system in compliance with IEC 60364-7-712.

Finally in the photovoltaic range it is available a huge range of water tight cabinets and consumer unit suitable for make distribution board & export control.

## ■ BEHAVIOUR WITH CHEMICAL AND ATMOSPHERIC AGENTS

Saline solution	Acids		Bases			Solvents			Mineral oil	Rayons UV
	Concentrated	Diluted	Concentrated	Diluted	Diluted	Hexane	Benzol	Acetone	Alcohol	Resistant
Resistant	Limited Resistance	Resistant	Resistant	Resistant	Resistant	Not Resistant	Not Resistant	Not Resistant	Limited Resistance	Limited Resistance
Resistant	Resistant	Resistant	Resistant	Resistant	Resistant	Resistant	Resistant	Resistant	Resistant	Resistant

## ■ APPLICATION EXAMPLES



## ■ TECHNICAL DATA DC SWITCH DISCONNECTORS FOR PHOTOVOLTAIC DC APPLICATION

Rated insulation voltage	16A		15A		20A		25A		30A		40A	
	UI	Uimp	8	4	8	8	8	8	8	8	8	8
Rated impulse withstand voltage			8	4	8	8	8	8	8	8	8	8
Thermal current			63	30	63	63	63	63	63	63	125	125
<b>DC21A</b> Resistive loads, including moderate overloads	300V	A	32	-	-	-	-	-	-	-	-	-
	400V	A	-	30	35	40	60	60	80	80	80	80
	450V	A	16	-	-	-	-	-	-	-	-	-
	500V	A	-	30	35	40	45	45	65	65	65	65
	600V	A	-	20	25	40	40	40	60	60	60	60
	750V	A	-	15	20	25	30	30	40	40	40	40
800V	A	-	15	20	25	30	30	40	40	40	40	
Rated operational current - Ie			1100	400	1100	1100	1100	1100	1100	1100	3000	3000
Rated short time withstand current			low (1s)									
Flexible wire			16	1.5-10	16	16	16	16	16	16	70	70
Rigid wire			16	1.5-10	16	16	35	16	16	16	70	70

## ■ POSSIBLE CONTACT WIRINGS

### SWITCH LINKING

In order to make easier the work of the installer, it is possible to choose the manner of wiring of the poles in series. In this way the incoming and the outgoing can be varied both on the top side and on the bottom side. In the packaging jumpers are supplied to cover the chosen configuration.

**590.DCGE0815 - (4 POLES IN SERIES) - 3 JUMPERS SUPPLIED**



**590.DCGE0820 - (5 POLES IN SERIES) - 4 JUMPERS SUPPLIED**

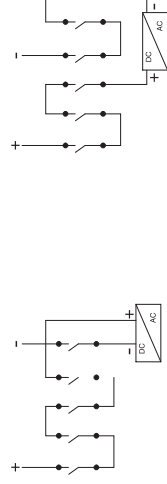

**590.DCGE0825 - (6 POLES IN SERIES) - 5 JUMPERS SUPPLIED**

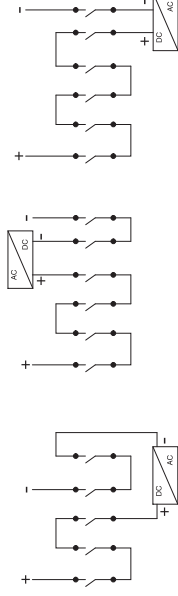

**590.DCGE0830 - (8 POLES IN SERIES) - 8 JUMPERS SUPPLIED**

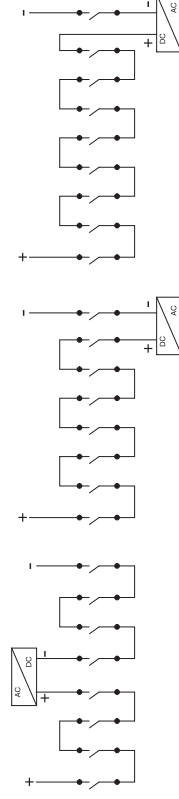



# ISOLATORS-SWITCH Series

## ENCLOSED CHANGE-OVER SWITCHES I/O/II 16A-160A



### VERSIONS

	Thermoplastic version
	Aluminium version
	Stainless steel version

### REFERENCE STANDARDS

#### EN 60947-3

Low voltage switchgear and controlgear.  
Part 3: switches, disconnectors, switch-disconnectors  
and fuse-combination unit.

#### EN 60529

Degrees of protection provided by enclosure.

## ISOLATORS-TP Series (Thermoplastic)

### BEHAVIOUR WITH CHEMICAL AND ATMOSPHERIC AGENTS

Saline solution	Acids		Bases		Solvents			Mineral oil	Rayons UV
	Concentrated	Diluted	Concentrated	Diluted	Hexane	Benzol	Acetone		
Resistant	Limited Resistance	Resistant	Resistant	Resistant	Not Resistant	Not Resistant	Not Resistant	Limited Resistance	Resistant

### CABLE INLETS

#### Thermoplastic insulated enclosure 3P - 3P+N

Size	Rated current (A)	Nr of poles	Enclosure dimensions	Cable entries
4	16-25-32-40	3P - 3P+N	210x155x107	Top
				Bottom
				Rear
5	63-80-100	3P - 3P+N	308x228x128	Top
				Bottom
				Rear
6	125-160	3P - 3P+N	338x308x128	Top
				Bottom
				Rear

(\*) Perforated or threaded entries on request.

## ISOLATORS-AL Series (Aluminium)

### BEHAVIOUR WITH CHEMICAL AND ATMOSPHERIC AGENTS

Saline solution	Acids		Bases		Solvents			Mineral oil	Rayons UV
	Concentrated	Diluted	Concentrated	Diluted	Hexane	Benzol	Acetone		
Resistant	Limited Resistance	Resistant	Limited Resistance	Limited Resistance	Resistant	Limited Resistance	Limited Resistance	Resistant	Resistant

### CABLE INLETS

#### Aluminium enclosure 3P - 3P+N

Size	Rated current (A)	Nr of poles	Enclosure dimensions	Cable entries
2	16-25-32-40	3P - 3P+N	210x155x107	Top
				Bottom
				Rear
3	63-80-100	3P - 3P+N	315x264x122	Top
				Bottom
				Rear
4	125-160	3P - 3P+N	410x315x128	Top
				Bottom
				Rear

(\*) Perforated or threaded entries on request.

## ISOLATORS-INOX Series (Stainless steel)

### BEHAVIOUR WITH CHEMICAL AND ATMOSPHERIC AGENTS

Saline solution	Acids		Bases		Solvents			Mineral oil	Rayons UV
	Concentrated	Diluted	Concentrated	Diluted	Hexane	Benzol	Acetone		
Resistant	Limited Resistance	Resistant	Resistant	Resistant	Resistant	Resistant	Resistant	Resistant	Resistant

### CABLE INLETS

Stainless steel enclosure 3P - 3P+N

Size	Rated current (A)	Nr of poles	Enclosure dimensions	Cable entries
3	16-25-32-40 63-80-100	3P - 3P+N	306x226x115	Top
				Bottom
				Rear
4	125-160	3P - 3P+N	412x312x115	Top
				Bottom
				Rear

Perforated or threaded entries on request.

### TECHNICAL DATA SWITCH DISCONNECTORS 3P - 3P+N

Rated insulation voltage	Ui	16A	25A	32A	40A	63A	80A	100A	125A	160A
Rated impulse withstand voltage	Uimp	8	8	8	8	8	8	8	8	8
Thermal current	Ith/Ihe	A	16	25	32	40	63	80	100	125
AC21A	Resistive loads, including moderate overloads	415V	A	16	25	32	40	63	80	100
		500V	A	16	25	32	40	63	80	100
		690V	A	16	25	32	40	63	80	100
AC22A	Mixed resistive and inductive loads, including moderate overloads	415V	A	16	25	32	40	63	80	125
		500V	A	16	25	32	40	63	80	125
		690V	A	16	25	32	40	40	40	125
AC23A	Switching of motor loads or other highly inductive loads (3 phase / 3 pole)	415V	A	16	25	32	40	63	80	125
		500V	A	16	25	32	40	63	63	125
		690V	A	16	25	25	25	32	32	100
Rated short time withstand current - low (1s)		A	1100	1100	1100	1100	1500	1500	1500	3000
Conditional short circuit current		kAeff	50	50	50	50	50	30	50	50
Associate fuse size for conditional short circuit current - Type gG		A	16	25	32	40	63	80	100	125
Flexible wire		mm²	4-25	4-25	4-25	4-25	10-50	10-50	10-70	10-70
Rigid wire		mm²	4-25	4-25	4-25	4-25	10-50	10-50	10-70	10-70

### APPLICATION EXAMPLES





**ISOLATORS-TP Series**
**■ THERMOPLASTIC INSULATED ENCLOSURE 16A-160A**

**■ REFERENCE STANDARDS**
**EN 60947-3**

Low voltage switchgear and controlgear.  
Part 3: switches, disconnectors, switch-disconnectors and fuse-combination unit.

**EN 60529**

Degrees of protection provided by enclosure.

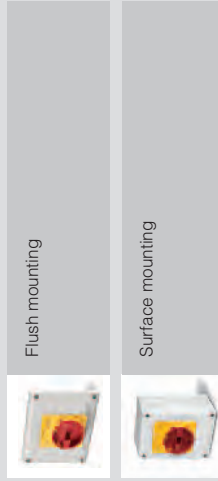
**■ VERSIONS**

**■ TECHNICAL CHARACTERISTICS**

Polarity:	<b>1P-2P-3P-3P+N-4P-6P-8P</b>
Rated current:	<b>16A* -20A-25A*-32A-40A-63A 80A-100A-125A-160A</b>
Protection degree:	<b>IP55 flush mounting version IP65 surface mounting version</b>
Operating ambient temperature according to the reference standard:	<b>-5°C +40°C</b>
Min-Max. operating ambient temperature:	<b>-25°C +60°C</b>
Material:	<b>Engineering plastic</b>
IK degree:	<b>IK08</b>
Glow wire test:	<b>650°C</b>
Colour:	<b>Grey RAL7035</b>
Insulation class:	<b>Class II (double insulation) <input type="checkbox"/></b>

3P+N with late break early make neutral pole.  
Equipped with door locking.  
Padlockable handle.  
\* Only for 6 and 8 poles.

**■ BEHAVIOUR WITH CHEMICAL AND ATMOSPHERIC AGENTS**

Saline solution	Acids		Bases			Solvents			Mineral oil	Rayons UV
	Concentrated	Diluted	Concentrated	Diluted		Benzol	Acetone	Alcohol		
Resistant	Limited Resistance	Resistant	Resistant	Resistant		Not Resistant	Not Resistant	Limited Resistance	Limited Resistance	Resistant

**■ CABLE INLETS**

Thermoplastic insulated enclosure 1, 2, 3, 4 poles

Size	Rated current (A)	Nr of poles	Enclosure dimensions	Cable entries	
1	20-32-40	1	120x82x69	Top	1xM20+1xM25
				Bottom	1xM20+1xM25
				Rear	2xM20
2	20-32-40	2-3-4	125x136x84(*)	Top	3xM20/M25
				Bottom	3xM20/M25
				Right	2xM20
				Left	2xM20
				Rear	2xM20/M25
				Top	1xM20+1xM25
3	20-32-40	2-3-4	150x105x82	Bottom	1xM20+1xM25
				Rear	1xM20+1xM25
				Top	2xM32
4	63-80-100	2-3-4	210x155x107	Bottom	2xM32
				Rear	-
				Top	Blank side (*)
5	125	3-4	308x228x128	Bottom	Blank side (*)
				Rear	Blank side (*)
				Top	Blank side (*)
6	160	3-4	338x308x128	Bottom	Blank side (*)
				Rear	Blank side (*)
				Top	Blank side (*)

(\*) Omnia enclosure.

(\*) Perforated or threaded entries on request.

**■ CABLE INLETS**

Thermoplastic insulated enclosure 6 and 8 poles

Size	Rated current (A)	Nr of poles	Enclosure dimensions	Cable entries	
4	16-25-32-40	6-8	210x155x107	Top	2xM32
				Bottom	2xM32
				Rear	Knock-outs
5	63-80-100	6-8	308x228x128	Top	Blank side (*)
				Bottom	Blank side (*)
				Rear	Blank side (*)
				Right	Blank side (*)
				Left	Blank side (*)
				Top	Blank side (*)
6	125-160	6-8	338x308x128	Bottom	Blank side (*)
				Rear	Blank side (*)
				Top	Blank side (*)

(\*) Perforated or threaded entries on request.

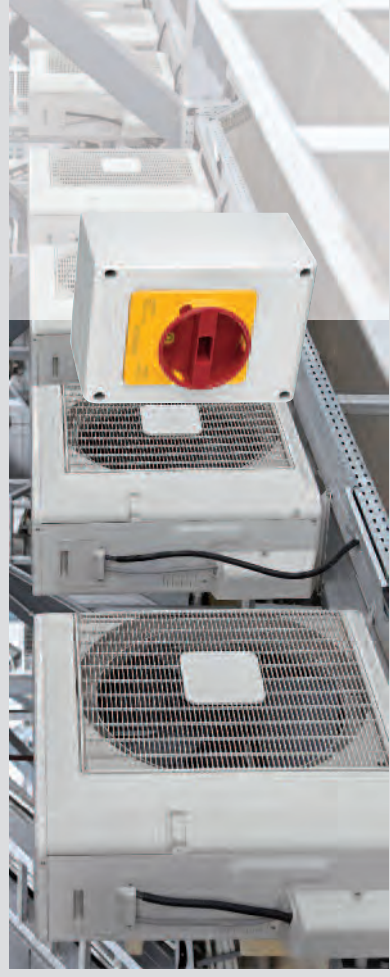
**■ APPLICATION EXAMPLES**

## ■ TECHNICAL DATA SWITCH DISCONNECTORS 1 POLES

Rated insulation voltage	UI		VAC	20A	32A	40A
	UI	Uimp				
Rated impulse withstand voltage	kV	Uimp	kV	4	4	4
Thermal current	A	Ith/Ithe	A	20	32	40
Rated operational current - Ie	AC22A Mixed resistive and inductive loads, including moderate overloads	250V	250V	20	32	40
		AC23A Switching of motor loads or other highly inductive loads (3 phase / 3 pole)	250V	16	20	25
Rated short time withstand current - Iow (1s)	A	Iow (1s)	A	480	480	480
Conditional short circuit current - Ipc	kAeff	Ipc	kAeff	10	10	10
Associate fuse size for conditional short circuit current - Type gG	A	Ipc	A	20	32	40
Flexible wire	mm <sup>2</sup>	Ipc	mm <sup>2</sup>	6	6	6
Rigid wire	mm <sup>2</sup>	Ipc	mm <sup>2</sup>	6	6	6

## ■ TECHNICAL DATA SWITCH DISCONNECTORS 2P, 3P, 3P+N, 4P

Rated insulation voltage	UI		VAC	20A	32A	40A	63A	80A	100A	125A	160A
	UI	Uimp									
Rated impulse withstand voltage	kV	Uimp	kV	4	4	4	4	4	4	4	4
Thermal current	A	Ith/Ithe	A	30	40	40	63	86	100	125	160
Rated operational current - Ie	AC21A Resistive loads, including moderate overloads	415V	415V	20	32	40	63	80	100	125	160
		500V	500V	20	32	32	63	80	100	125	160
		690V	690V	20	32	32	63	80	100	125	160
AC22A Mixed resistive and inductive loads, including moderate overloads	415V	415V	20	32	40	63	80	100	125	160	
	500V	500V	20	32	32	63	80	100	125	160	
	690V	690V	20	32	32	63	80	100	125	160	
AC23A Switching of motor loads or other highly inductive loads (3 phase / 3 pole)	415V	415V	20	25	25	40	67	-	125	125	
	500V	500V	20	25	25	30	38	-	100	100	
	690V	690V	20	25	25	30	38	-	100	100	
AC23A Rated operational power	kW	Ith/Ithe	kW	9	15	18.5	33	37	46	55	69
AC3 Squirrel-cage motor: starting, switching off motor during running (3 phase / 3 pole)	A	Ith/Ithe	A	-	28.5	28.5	40	55	-	-	-
DC22A Mixed resistive and inductive loads, including moderate overloads	250V	250V	A	25(*)	32(*)	32(*)	-	-	-	-	-
	600V	600V	A	10(*)	10(*)	10(*)	-	-	-	-	-
Rated short time withstand current - Iow (1s)	A	Iow (1s)	A	400	400	400	1500	1500	1500	3000	3000
Conditional short circuit current - Ipc	kAeff	Ipc	kAeff	10	10	10	10	10	30	50	50
Associate fuse size for conditional short circuit current - Type gG	A	Ipc	A	20	32	40	63	80	100	125	125
Flexible wire	mm <sup>2</sup>	Ipc	mm <sup>2</sup>	1.5-10	1.5-10	1.5-10	10-35	10-35	10-50	10-70	10-70
Rigid wire	mm <sup>2</sup>	Ipc	mm <sup>2</sup>	1.5-16	1.5-16	1.5-16	10-35	10-35	10-50	10-70	10-70

(\*) Only 4P with 2+2 poles in series

## ■ TECHNICAL DATA SWITCH DISCONNECTORS 6 AND 8 POLES

Rated insulation voltage	UI		VAC	16A	25A	32A	40A	63A	80A	100A	125A	160A
	UI	Uimp										
Rated impulse withstand voltage	kV	Uimp	kV	8	8	8	8	8	8	8	8	8
Thermal current	A	Ith/Ithe	A	16	25	32	40	63	80	100	125	160
Rated operational current - Ie	AC21A Resistive loads, including moderate overloads	415V	415V	16	25	32	40	63	80	100	125	160
		500V	500V	16	25	32	40	63	80	100	125	160
		690V	690V	16	25	32	40	63	80	100	125	160
AC22A Mixed resistive and inductive loads, including moderate overloads	415V	415V	16	25	32	40	63	80	100	125	160	
	500V	500V	16	25	32	40	63	80	100	125	160	
	690V	690V	16	25	32	40	63	80	100	125	160	
AC23A Switching of motor loads or other highly inductive loads (3 phase / 3 pole)	415V	415V	16	25	32	40	63	80	100	125	160	
	500V	500V	16	25	32	40	63	63	63	63	125	
	690V	690V	16	25	25	25	32	32	32	32	100	100
AC23A Rated operational power	kW	Ith/Ithe	kW	7.5	11	15	18.5	35	37	46	55	69
Rated short time withstand current - Iow (1s)	A	Iow (1s)	A	1100	1100	1100	1100	1500	1500	1500	3000	3000
Conditional short circuit current - Ipc	kAeff	Ipc	kAeff	50	50	50	50	50	50	50	50	50
Associate fuse size for conditional short circuit current - Type gG	A	Ipc	A	16	25	32	40	63	80	100	125	125
Flexible wire	mm <sup>2</sup>	Ipc	mm <sup>2</sup>	4-25	4-25	4-25	4-25	10-50	10-50	10-50	10-70	10-70
Rigid wire	mm <sup>2</sup>	Ipc	mm <sup>2</sup>	4-25	4-25	4-25	4-25	10-50	10-50	10-50	10-70	10-70

### 4P SWITCH LINKING FOR DC APPLICATION



# KIOSK Series

## ■ DISTRIBUTION PEDESTALS TERMINALS



## ■ REFERENCE STANDARDS

<p>CEI 64-8/7 section 708/711 IEC 60364-7-709 IEC 60364-7-711 IEC 60364-7-740 Electrical installations.</p>
<p>CEI EN 61439-1 CEI EN 61439-7 Assembled equipment.</p>

## ■ CHARACTERISTICS OF THE "SAFE-IN" OPTIMA SERIES PLUGS



## ■ VERSIONS

	Distribution pedestals terminals with DOMINO in painted metal sheet / stainless steel
	Distribution pedestals terminals with MBOX in painted metal sheet / stainless steel
	Distribution pedestals terminals in thermoplastic material SMART-K - SMART-C - SMART-X
	Distribution pedestals terminals in thermoplastic material (fire-proof versions) SMART-K - SMART-C
	Distribution pedestals terminals with BLOCK in painted metal sheet

## ■ TECHNICAL CHARACTERISTICS

Operating temperature:	-25°C +40°C
Protection degree:	Plastic: IP56 Metal: IP66
Max. operating ambient temperature according to the reference standard:	+60°C
Insulation class:	Class II (double insulation) □
Material:	Zinc-plated metal sheet/ Thermoplastic/Stainless steel
IK degree at 20°C:	IK10
Plastic colour:	Blue - Green - Yellow - Red - White (No RAL reference)
Power supply terminal board:	Upon request
Water service:	Upon request
Circuit breakers:	Supplied 6A other sizes upon request
<b>POSSIBILITY TO CONFIGURE OTHER VERSIONS (UPON REQUEST)</b>	

## ■ BEHAVIOUR WITH CHEMICAL AND ATMOSPHERIC AGENTS

Saline solution	Acids		Bases		Solvents		Mineral oil	UV rays	
	Concentrated	Diluted	Concentrated	Diluted	Hexane	Benzol			Acetone
Resistant	Limited Resistance	Resistant	Resistant	Resistant	Not Resistant	Not Resistant	Not Resistant	Limited Resistance	Resistant

## ■ THE "SAFE-IN" SAFETY DEVICE

The "SAFE-IN" safety device assembled on the 16A industrial sockets is the most innovative element of the new OPTIMA Series.

The "SAFE-IN" device works like the protection installed on household sockets, i.e., by means of an appropriate shutter, it closes the input of the socket contact tubes and prevents accidental and voluntary contact of live parts of the socket with slim objects, such as screwdrivers or wires.

This protection offers an additional safety guarantee, in addition to that already provided by the spring-loaded cover assembled on the mobile sockets.

## ■ SAFETY LEVEL

The OPTIMA Series sockets with the "SAFE-IN" safety device guarantee a higher level of safety in comparison with ordinary industrial sockets, especially in environments where there may be children present or people who have not been trained about electrical dangers (public areas, amusement parks, campgrounds, open markets, etc.).

Dangerous situations, such as the important examples illustrated in the figure to the side, can be resolved thanks to the new OPTIMA Series sockets equipped with the "SAFE-IN" safety device.



## ■ THE ONLY DISTRIBUTION PEDESTALS TERMINALS WITH INCREASED DEGREE OF SAFETY

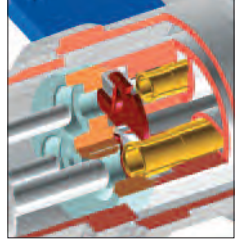

Connector tube protective shutter for greater safety against direct contacts. (The SAFE-IN safety device).



# KIOSK Series

## ■ STAND ALONE

The charging stations are not connected one to the other and work independently. The charging stations administrator can leave them in free charging mode (FREE) or limited to authorized users (PERSONAL). Through the card programmer, the administration can nevertheless influence the charging operation depending on a specific time or number of accesses.

Programmer and User Card in HF technology

PC

PROG

SLActive Software

Code: 8CA2C76E

Plug Code: 020000000

Number of accesses: 00

Expiration: 31/12/2011

WRITE CARD

SCAME

**ACTIVE CARD**  
Each User Card can be programmed by assigning it an expiry date and/or a limited number of accesses through the 208.PROG programmer, to be connected to one's computer, and the SLActive software supplied with the User Card.

## ■ NET

The stations are connected one to the other to a local server whose access is assigned exclusively to the stations administrator. In addition to being a data concentrator, the server also contains the standard software developed in cooperation with our standard partner GENERALE SYSTEMI; this software makes it possible to manage users, monitor and configure the stations, calculate the consumptions, etc. Through the card programmer, the administration can nevertheless influence the charging operation depending on a specific time or number of accesses.  
The services are managed through a local server positioned near the columns.

Local server with standard management software

SCAME

STATION	PLC Address	PLC Number	Card	Access	Access	Access	Access
001	100	100	100	100	100	100	100
002	101	101	101	101	101	101	101
003	102	102	102	102	102	102	102
004	103	103	103	103	103	103	103
005	104	104	104	104	104	104	104
006	105	105	105	105	105	105	105
007	106	106	106	106	106	106	106
008	107	107	107	107	107	107	107
009	108	108	108	108	108	108	108
010	109	109	109	109	109	109	109

SCAME



UPON REQUEST, SCAME SUPPLIES REMOTE READING AND REMOTE MANAGEMENT SYSTEMS FOR ENERGY DISPENSERS



## ■ LAMPHOLDER

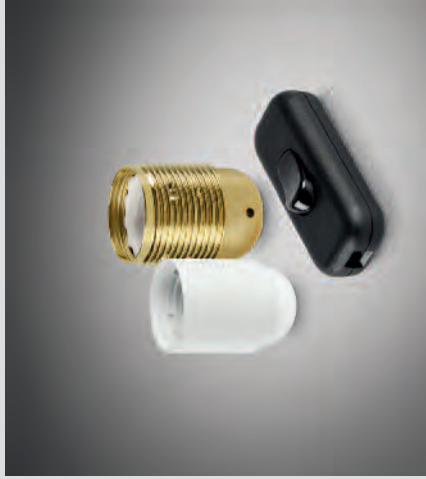

## ■ REFERENCE STANDARDS

<p><b>EN 60238</b> Edison screw lampholders.</p>
<p><b>EN 60838-1</b> Miscellaneous lampholders. <i>Part 1: general requirements and tests.</i></p>
<p><b>EN 61058-1</b> Switches for appliances. <i>Part 1: general requirements.</i></p>

## ■ VERSIONS

 <p>Lampholders - For incandescent lamps (E14-E27) - For fluorescent lamps (G5-G23) - For halogen lamps (G4-GX53-GY6.35-R75)</p>	 <p>Switches - press switches - pull switches - slide in-line switches - foot switches</p>	 <p>Ceiling accessories</p>
---	---	---

## ■ QUALITY MARKS



Thermostat lampholders:  
left, with E27 coupling, partly threaded skirt and metal nipple; right, with E14 coupling, fully threaded skirt and moulded thread.

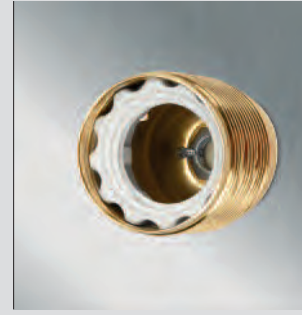

Metal lampholder.  
Detail of locking screw and earth terminal.



Slide in-line switch, with neutral connection for flat cable.

## ■ TYPE OF COUPLING

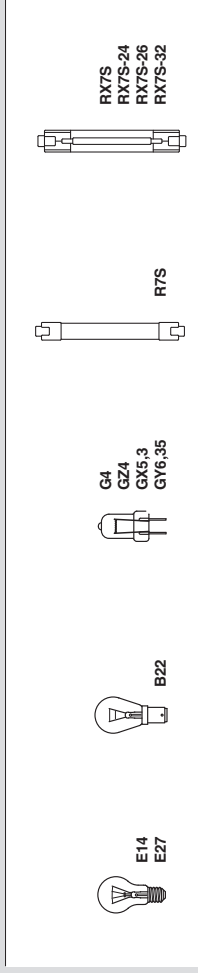

## ■ APPLICATION EXAMPLES



## ■ DISTRIBUTION ASSEMBLIES - IP66



## ■ REFERENCE STANDARDS

### EN 60670-1

Boxes and enclosure for electrical accessories for household and similar fixed electrical installation.  
*Part 1: general requirements.*

### EN 61439-3

Low-voltage switchgear and controlgear assemblies.  
*Part 3: distribution boards intended to be operated by ordinary persons (DBO).*

### EN 61439-4

Low-voltage switchgear and controlgear assemblies.  
*Part 4: particular requirements for assemblies for construction sites (ACS)*

## ■ VERSIONS



**MBOX2**  
- Portable  
- Wall installation  
- Trestle installation  
- Turret installation  
- Pole fastening



**MBOX3**  
- Portable  
- Wall installation  
- Trestle installation  
- Pole fastening



**MBOX5**  
- Wall installation  
- Trestle installation  
- Pole fastening  
- Portable with two folding handles

## ■ QUALITY MARKS



## ■ TECHNICAL CHARACTERISTICS COMMON TO THE ENTIRE PRODUCT LINE

Protection degree: **IP66-IP65 (version with emergency button)**

Operating ambient temperature according to the reference standard: **-25°C +40°C**

Max. operating ambient temperature: **60°C**

Glow Wire test: **650°C**

IK degree at 20°C: **IK08-IK09**

Material: **Engineering plastic**

Insulation class: **Class II (double insulation)**

Dissipable power according to CEI 23-49 standard: **-**

The Logotype featuring SCAME MBOX2 series.



**"REGISTERED DESIGN"**

## ■ BEHAVIOUR WITH CHEMICAL AND ATMOSPHERIC AGENTS

Saline solution	Acids		Bases			Solvents			Mineral oil	UV rays
	Concentrated	Diluted	Concentrated	Diluted	Diluted	Acetone	Benzol	Alcohol		
Resistant	Limited Resistance	Resistant	Limited Resistance	Resistant	Resistant	Not Resistant	Not Resistant	Limited Resistance	Limited Resistance	Resistant

## ■ MBOX2 TECHNICAL CHARACTERISTICS

Dimensions: **432x365x290 mm**

Power supply: **With 16mm<sup>2</sup> terminal box (5 poles) or with mobile (16/32A)**

Cable length: **2m**

Cable entry: **M32 or M25 break-through input and cable for power supply and M16 break-through for earthing cable**

- Switchboard for 16 DIN modules (2 rows of 8 modules) with tinted door and YALE key or triangular lock.

- Possibility to install up to 4 interlocked OMNIA Series 16/32A socket with or without fuses or up to 6 flush mounting EUREKA Series 16/32A sockets  
- Possibility to install the panel on turret or trestle  
- Possibility to install the emergency push button  
- Fuses-testing device housed in the switchboard compartment (only in the versions with fuses)  
- Possibility to house three spare fuses

## ■ MBOX3 TECHNICAL CHARACTERISTICS

Dimensions: **465x380x520mm**

Average weight: **15 Kg**

Power supply: **Cable input through hole for M40 cable gland.**

- M8 brass pin for earthing connection.

- 16 mm<sup>2</sup> power supply terminal box (5 poles) for currents up to 32A and 35 mm<sup>2</sup> terminal box (5 poles) for currents up to 125A.

- Possibility to equip the panel with a 63A or 125A fixed plug.

- Switchboard for 39 DIN modules (3 rows of 13 modules) with tinted door and YALE key or triangular lock.

Key or triangular lock.

- Possibility to install up to 6 interlocked OMNIA Series 16/32A sockets with or without fuses or up to 9 flush mounting EUREKA Series 16/32A sockets.  
- In the version without door it is possible to install up to 4 interlocked OMNIA Series 16/32A sockets and an interlocked OMNIA Series 63A socket.  
- Fuses-testing device inserted in the switchboard compartment  
- Possibility to install the emergency push button or a disconnecter with functional control and emergency functions.

## ■ MBOX5 TECHNICAL CHARACTERISTICS

Dimensions: **775x400x670mm**

Average weight: **27 Kg**

Power supply: **Cable input through hole for M40 cable gland.**

- M8 brass pin for earthing connection.

- 16 mm<sup>2</sup> power supply terminal box (5 poles) for currents up to 32A and 35 mm<sup>2</sup> terminal box (5 poles) for currents up to 125A.

- Possibility of 70 mm<sup>2</sup> input/output terminal box (5 poles).

- Possibility to equip the panel with a 63A or 125A fixed plug.

- Switchboard for 52 DIN modules (4 rows of 13 modules) with tinted door and YALE key or triangular lock.

- Possibility to install up to 12 interlocked OMNIA Series sockets and 4 interlocked ADVANCEZ Series compact or large 16/32/63A sockets.  
- Output terminal box: it is possible to install the OMNIA Series containers n. 572.0321 and n. 572.0322 respectively for terminal box output with or without protection (6 DIN modules).  
- Fuses-testing device inserted in the switchboard compartment.  
- Possibility to house live spare fuses.  
- Possibility to install the emergency push button or a disconnecter with functional control and emergency functions.

## ■ APPLICATION EXAMPLES

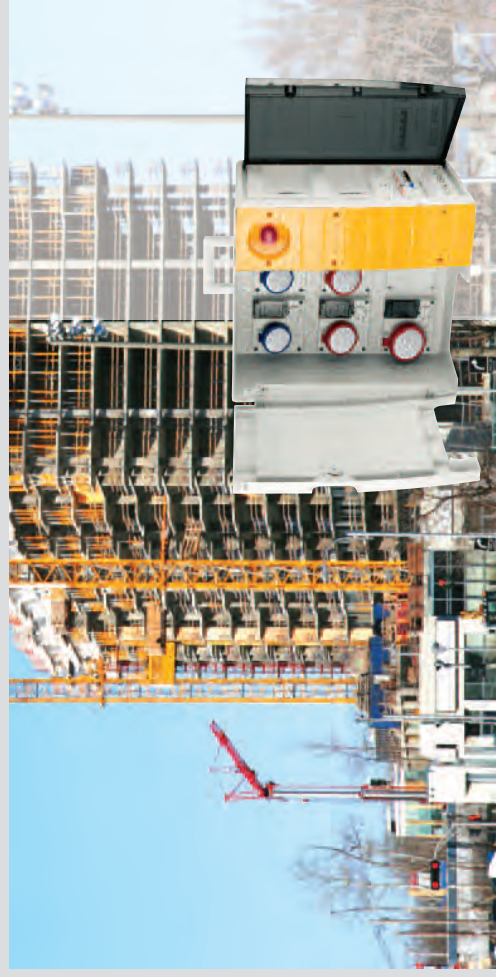



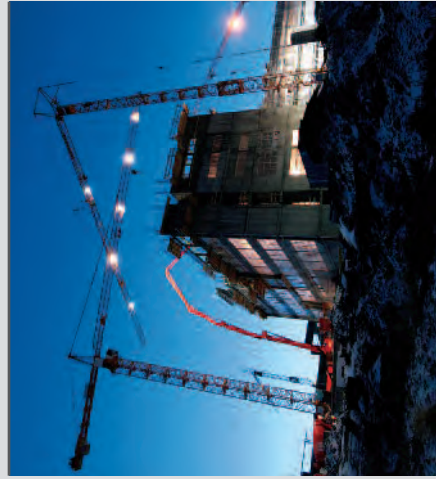
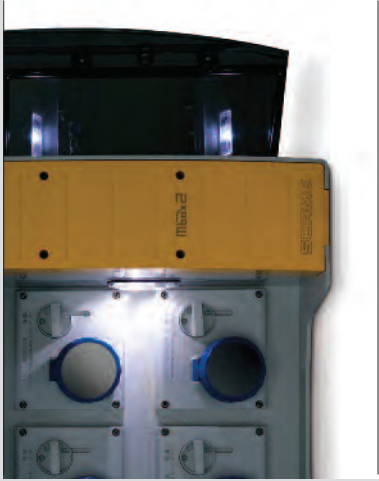

## NIGHT & DAY

MBOX turns on a new era with a box that is even more functional and complete. The addition of an automatic device (LED with extremely low consumption hooked up to a sensor) ensures proper lighting of the compartment containing outlets and switch gear and protection devices when the outdoor light intensity diminishes. This allows the product to be identified and used under conditions of poor lighting; ideal for the worksite, MBOX is also perfect for campsites and parking areas.

Extremely compact and totally safe, MBOX features an innovative design and it is made in collision-proof and self-extinguishing technopolymer, to withstand collisions and atmospheric agents. In compliance with the highest safety standards, the MBOX series includes a complete product range and comes in many customized versions, with fast delivery.

### MBOX2

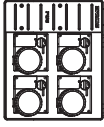

Version with 4 interlocked OMNIA Series sockets with fuses without emergency push button.

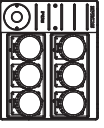

Version with 6 EUREKA Series flush mounting industrial sockets and emergency push button.

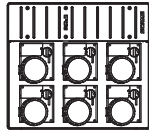

Version with 6 interlocked OMNIA Series sockets with fuses without emergency push button.

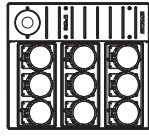

Version with 9 EUREKA Series flush mounting industrial sockets and emergency push button.

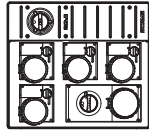

Version with 4 interlocked OMNIA Series sockets with fuses and 1 interlocked OMNIA Series 64A socket and disconnecter.

### MBOX5

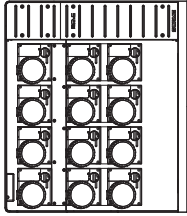

Version with 12 interlocked OMNIA Series sockets with fuses without emergency push button.

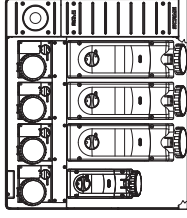

Version with 4 interlocked OMNIA Series sockets with fuses and 4 interlocked ADVANCEZ Series LARGE sockets and emergency push button.

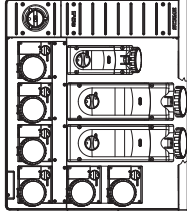

Version with 6 interlocked OMNIA Series sockets with fuses and 3 interlocked ADVANCEZ Series COMPACT and LARGE sockets with disconnecter.

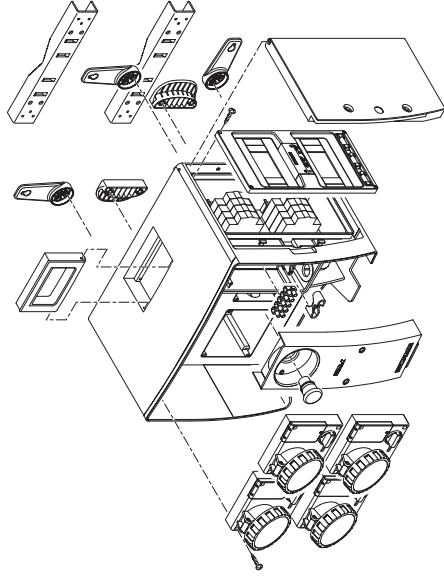

## ■ DISTRIBUTION ASSEMBLIES



## ■ VERSIONS



Distribution assemblies IP55  
- transportable  
- with SELV safety transformer 220/24V

## ■ REFERENCE STANDARDS

### EN 61439-1

Low-voltage switchgear and controlgear assemblies (BT panels).  
*Part 1: general requirements.*

### EN 61439-4

Low-voltage switchgear and controlgear assemblies (BT panels).  
*Part 4: particular requirements for assemblies for construction sites.*

### EN 61439-2

Low-voltage switchgear and controlgear assemblies (BT panels).  
*Part 2: power switchgear and controlgear assemblies*

### EN 61439-3

Low-voltage switchgear and controlgear assemblies.  
*Part 3: distribution boards intended to be operated by ordinary persons (DBO).*

## ■ TECHNICAL CHARACTERISTICS

Rated current:	125A+630A
Rated voltage:	400V~
Frequency:	50Hz
Insulating voltage:	400V~
Protection degree:	IP55
SELV transformer 220/24V:	Yes
Operating ambient temperature according to the reference standard:	-25°C +40°C
Max operating ambient temperature:	60°C
Glow Wire test:	650°C
Power output:	70KW±375KW
Material:	Engineering plastic
Colour:	Grey RAL 9007

- Sturdy galvanized fire painted sheet iron.
- Fitted with a lifting device, handles on the side and a roof to protect it from rain or falling objects.
- The structure can be fastened to the ground (purposely fitted feet).

## ■ BEHAVIOUR WITH CHEMICAL AND ATMOSPHERIC AGENTS

Saline solution	Acids		Bases			Solvents			Mineral oil	UV rays
	Concentrated	Diluted	Concentrated	Diluted	Hexane	Benzol	Acetone	Alcohol		
Resistant	Not Resistant	Not Resistant	Limited Resistance	Resistant	Not Resistant	Not Resistant	Not Resistant	Limited Resistance	Resistant	Resistant

## ■ APPLICATION EXAMPLES



## ■ LIGHT FITTINGS



## ■ REFERENCE STANDARDS

<p><b>EN 60598-1</b> Luminaires. <i>Part 1: general requirements and tests.</i></p>
<p><b>EN 60598-2-1</b> Luminaires. <i>Part 2: specific requirements</i> <i>Section 1: fixed general purpose luminaires.</i></p>

## ■ QUALITY MARKS



## ■ VERSIONS

	For incandescent lamps - 60W 250V~ - Thermoplastic diffuser - IP44 - Polycarbonate diffuser - IP44 or IP55
	For indicating working areas - Polycarbonate diffuser - IP44
	Automatic twilight turn-on - Two operation modes

## ■ TECHNICAL CHARACTERISTICS

Protection degree:	<b>IP44-IP55</b>
Operating ambient temperature according to the reference standard:	<b>Thermoplastic diffuser:</b> -5°C +35°C <b>Polycarbonate diffuser:</b> -15°C +35°C
Glow Wire test:	<b>650°C</b>
Material:	<b>Engineering plastic</b>
IK degree at 20°C:	<b>IK04 - IK07</b>
Cable inlets:	<b>PG11-PG13</b>
Insulation class:	<b>Class II</b> <b>(double insulation)</b> <input type="checkbox"/>
Lamp/holder type:	<b>E27 - B22</b>
Installation on inflammable surface:	<b>Yes</b>

## ■ BEHAVIOUR WITH CHEMICAL AND ATMOSPHERIC AGENTS

Saline solution	Acids		Bases			Solvents			Mineral oil	UV rays
	Concentrated	Diluted	Concentrated	Diluted	Hexane	Benzol	Acetone	Alcohol		
Resistant	Limited Resistance	Resistant	Limited Resistance	Limited Resistance	Limited Resistance	Not Resistance	Not Resistance	Resistant	Limited Resistance	Resistant

## ■ APPLICATION EXAMPLES

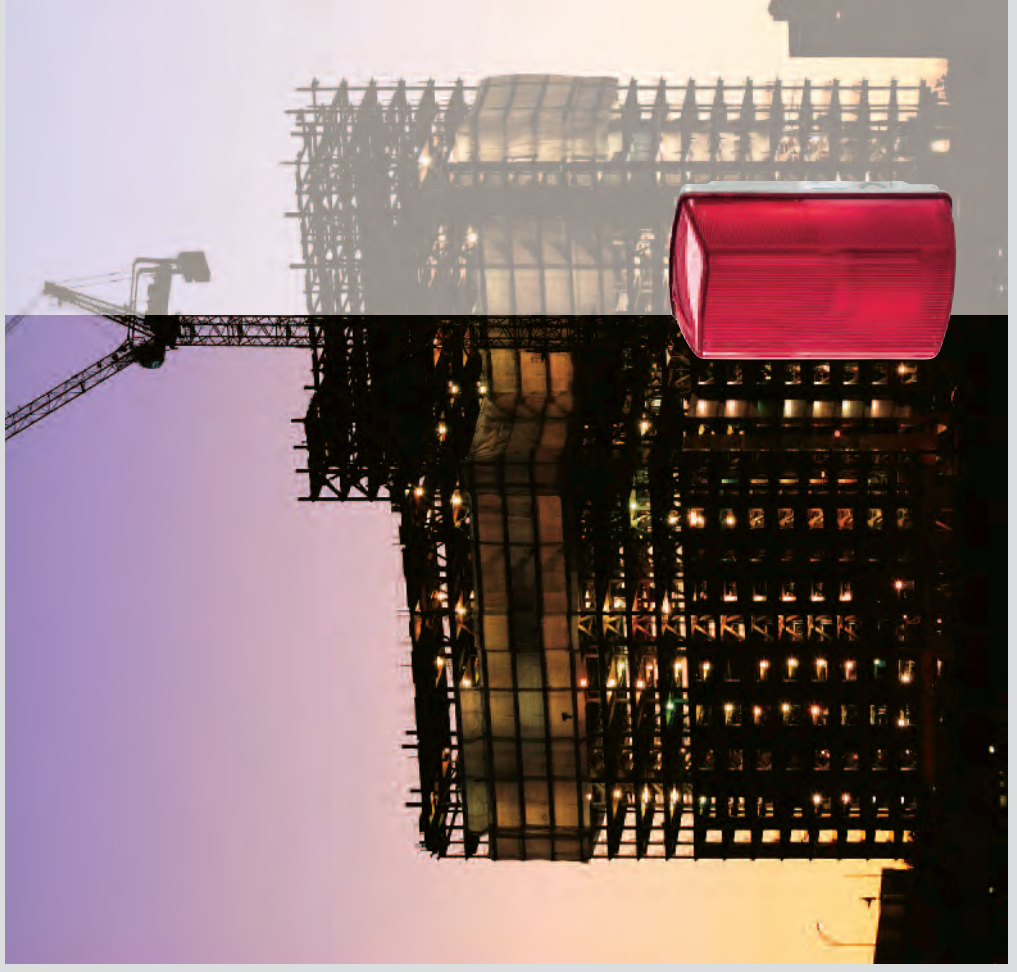



**MIZAR Series**

■ **CABLE INLET**



Five knockouts for PG11/PG13.5 cable inlets, located around the four sides and on the base provide a wide range of installation options: with cable sleeve, with cable gland or with couplings between Ø 16 mm rigid

or flexible conduit and box. A flexible conduit for flush mounting and power supply from the rear of the base can also be installed.



This layout of knockout cable inlets allows a number of different installation possibilities: with power supply to the fixture from any side or through

cabling in and out when several fixtures need to be supplied in parallel.

■ **CORRECT INSTALLATION**

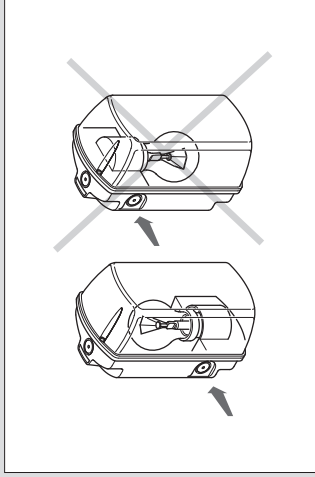

Overheating may affect the life of the lamp-holder and of the cables. To avoid this the lamp must be upright when mounting the fixture vertically, i.e. the lampholder must be in the lower part of the fixture. This also guarantees the protection degree.



An isolating screen provides total insulation, and by segregating the cabling protects the operator against contact with live parts when replacing the lamp.

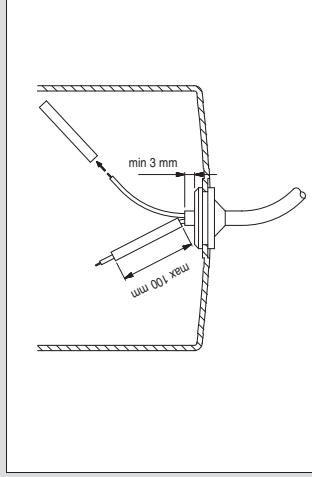

The mounting kit included in the supply comes with heat resistant sleeving for protecting the power supply cables from the heat generated by the lamp when in use.



A fast mounting plate for maintaining the protection degree is provided with the IP55 version.

■ **FIXING**

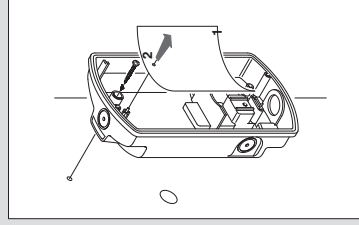

MIZAR Series light-fittings are fitted with a slot on the rear of the base for hooking onto a nail, screw or hook, or for fastening to poles, pipes, bars or scaffolding using one or two cable ties. For permanent installation, the fixtures can be wall or ceiling mounted using screw anchors.

## ■ INTERLOCKED SWITCH SOCKET OUTLETS



## ■ REFERENCE STANDARDS

### EN 60309-1

Plugs, socket outlets and couplers for industrial purposes.  
*Part 1: general requirements.*

### EN 60309-2

Plugs, socket outlets and couplers for industrial purposes.  
*Part 2: dimensional interchangeability requirements for pin and contact/tube accessories of harmonised configurations.*

### EN 60309-4

Plugs, socket-outlets and couplers for industrial purposes.  
*Part 4: switched socket-outlets and connectors with or without interlock.*

## ■ VERSIONS



Surface mounting  
Without fuse carrier



Surface mounting  
With fuse carrier



Flush mounting  
Without fuse carrier



Flush mounting  
With fuse carrier

## ■ QUALITY MARKS



## ■ TECHNICAL CHARACTERISTICS

Rated current:	16A-32A-63A
Rated voltage:	100±690V~
Frequency:	c.c. - 50-500Hz
Insulating voltage:	500/690V~
Protection degree:	IP44-IP66/IP67
Operating ambient temperature according to the reference standard:	-25°C +40°C
Max. operating ambient temperature:	60°C
Glow Wire test:	650°C/850°C
Material:	Engineering plastic
IK degree at 20°C:	IK08
Cable inlet:	PG/METRIC
Fuse-carriers:	gG 10,3x38 mm
Colour:	Grey RAL 7035
Insulation class:	Class II (double insulation) <input type="checkbox"/>

## ■ BEHAVIOUR WITH CHEMICAL AND ATMOSPHERIC AGENTS

Saline solution	Acids		Bases			Solvents			Mineral oil	UV rays
	Concentrated	Diluted	Concentrated	Diluted	Diluted	Hexane	Benzol	Acetone		
Resistant	Limited Resistance	Resistant	Resistant	Resistant	Resistant	Not Resistant	Not Resistant	Not Resistant	Limited Resistance	Resistant

## ■ WIRING AND INSTALLATION

Wiring capacity of the terminals

Cross-section of the connectable conductors (mm²)

Rated voltage	Rated current (A)	Socket outlets	
		Min	Max
>50V	16A	1,5	4
	32A	2,5	10
	63A	6	25

## ■ APPLICATION EXAMPLES





■ TECHNICAL DATA SWITCH DISCONNECTORS

	with fuse			without fuse			
	16A	32A	63A	16A	32A	63A	
Rated insulation voltage <b>Ui</b>	Vac	690	690	690	690	690	
	Vdc	600	600	600	600	-	
Rated impulse withstand voltage <b>Uimp</b>	kV	4	4	4	4	8	
Thermal current <b>Ith</b>	A	25	32	30	40	63	
Thermal current <b>Ithe</b>	A	25	32	30	40	63	
<b>AC21A</b> Resistive loads, including moderate overloads	400V	-	-	-	-	-	
	500V	-	-	-	-	-	
	690V	A 25	32	30	32	63	
<b>AC22A</b> Mixed resistive and inductive loads, including moderate overloads	400V	A -	-	-	-	-	
	500V	A -	-	-	-	-	
	690V	A 30	32	20	32	63	
<b>AC23A</b> Switching off motor loads or other highly inductive loads (3 phase / 3 pole)	400V	A -	-	20	32	50	
	500V	A -	-	-	-	40	
	690V	A 16	25	16	25	30	
<b>AC3</b> Squirrel-cage motor: starting, switching off motor during running (3 phase / 3 pole)	400V	A -	28.5	-	28.5	40	
	690V	A 12	20	12	20	25	
<b>DC21A</b> Resistive loads, including moderate overloads	300V	A 25	32	25	32	-	
<b>DC22A</b> Mixed resistive and inductive loads, including moderate overloads	250V	A 20	32	20	32	-	
	600V	A -	-	10(*)	10(*)	-	
Rated short-time withstand current, <b>Ist</b> (1s)	A	400	400	400	400	1500	
Conditional short-circuit current	kA	10	10	10	10	10	
Associate fuse size for conditional short-circuit current - type GG	500V	kA 16	32	16	32	63	
Rated short-circuit making capacity, <b>Icm</b>	kA	1500	1500	1500	1500	2850	
<b>UL rating</b>	General use single phase and 3 phase	600V	A 20	30	32	40	63
	AC motor starting break all line single phase	120V	Hp 1.5	2	1.5	2	3
		240V	Hp 3	5	3	5	7.5
	AC motor B, C, D starting break all lines three phase	240V	Hp 7.5	10	7.5	10	10
		480V	Hp 10	15	10	15	20
		600V	Hp 15	20	15	20	25
Flexible wire	mm <sup>2</sup>	1.5-10	1.5-10	1.5-10	1.5-10	10-35	
Rigid wire	AWG	16-8	16-8	16-8	16-8	10-2	
<b>Permissible wire gauge</b>	mm <sup>2</sup>	1.5-16	1.5-16	1.5-16	1.5-16	10-35	
	AWG	16-8	16-8	16-8	16-8	10-2	

(\*) 2+2 poles in series

■ IMO approved ■ UL approved

■ APPLICATION EXAMPLES





## ■ INTERLOCKED SWITCH SOCKET OUTLETS



## ■ REFERENCE STANDARDS

### EN 60309-1

Plugs, socket outlets and couplers for industrial purposes.  
*Part 1: general requirements.*

### EN 60309-2

Plugs, socket outlets and couplers for industrial purposes.  
*Part 2: dimensional interchangeability requirements for pin and contact-tube accessories of harmonised configurations.*

## ■ QUALITY MARKS



## ■ VERSIONS



Flush mounting  
- with transformer  
- without transformer



Surface mounting  
- without transformer

## ■ BEHAVIOUR WITH CHEMICAL AND ATMOSPHERIC AGENTS

Saline solution	Acids		Bases		Solvents			Mineral oil	UV rays
	Concentrated	Diluted	Concentrated	Diluted	Hexane	Benzol	Acetone		
Resistant	Limited Resistance	Resistant	Resistant	Resistant	Not Resistant	Not Resistant	Not Resistant	Limited Resistance	Resistant

## ■ WIRING AND INSTALLATION

Wiring capacity of the terminals  
Cross-section of the connectable conductors (mm<sup>2</sup>)

Rated current (A)	Socket outlets	
	Min	Max
16A	4	10
32A	4	10

## ■ APPLICATION EXAMPLES



## ■ TECHNICAL CHARACTERISTICS

Rated current:	16A-32A
Rated voltage:	20+50V ~
Frequency:	c.c. - 50+60Hz
SELV transformer 220/24V:	150VA
Insulating voltage:	500/690V ~
Protection degree:	IP44-IP66/IP67
Operating ambient temperature according to the reference standard:	-25°C +40°C
Max. operating ambient temperature:	60°C
Glow Wire test:	650°C (housing) 850°C (contact carrier)
Material:	Engineering plastic
IK degree at 20°C:	IK07 - IK08
Cable inlet:	PG/METRIC
Fuse-carriers:	gG 10.3x38 mm
Colour:	Grey RAL 7035
Insulation class:	Class III

## FLUSH AND SURFACE MOUNTING MODULAR SYSTEM



### VERSIONS

	Consumer unit assembly kit - IP55
	Plates - IP55
	Protection cover - IP20
	Flush mounting box
	Frame - IP55
	Coupling insert
	Surface mounting box - IP67
	Surface mounting system

### REFERENCE STANDARDS

#### EN 60670-1

General requirements for enclosures for accessories for household and similar fixed electrical installations.  
*Part 2: general requirements.*

#### CEI 23-49

Enclosures for accessories for household and similar fixed electrical installations.  
*Part 2: detailed requirements for enclosures for containing protective devices and appliances that under ordinary use dissipate significant energy.*

### QUALITY MARKS



### TECHNICAL CHARACTERISTICS

Protection degree:	IP44-IP55-IP66
Operating ambient temperature according to the reference standard:	-25°C +35°C
Max. operating ambient temperature:	60°C
Glow Wire test:	650°C/850°C
Material:	Engineering plastic
IK degree at 20°C:	IK08
Cable inlet:	PG/METRIC
Colour:	Grey RAL 7035
Insulation class:	Class II (double insulation) <input type="checkbox"/>

### BEHAVIOUR WITH CHEMICAL AND ATMOSPHERIC AGENTS

Saline solution	Acids		Bases				Solvents				Mineral oil	UV rays	
	Concentrated	Diluted	Concentrated	Diluted	Hexane	Benzol	Acetone	Alcohol	Limited Resistance	Not Resistant			Limited Resistance
Resistant	Limited Resistance	Resistant	Limited Resistance	Resistant	Not Resistant	Not Resistant	Not Resistant	Limited Resistance	Limited Resistance	Not Resistant	Not Resistant	Limited Resistance	Resistant

### APPLICATION EXAMPLES



Example of a flush mounting combination: consumer unit, junction box and OMNIA Series interlocked-switch socket outlet. IP55 weatherproof.



Example of a surface mounting combination: consumer unit and OMNIA Series interlocked-switch socket outlet. IP55 weatherproof.



Surface mounting system. Consumer unit 6 DIN system version with interlocked-switch socket outlet with fuse carrier.



Surface mounting system. Blank plate system with OMNIA Series interlocked-switch outlet without fuse carrier.

FLUSH MOUNTING INSTALLATIONS

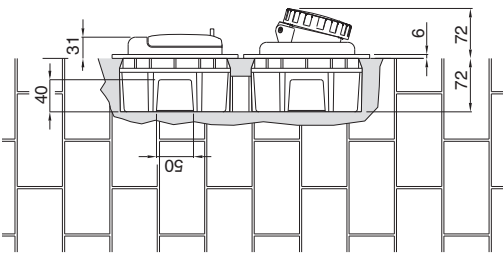
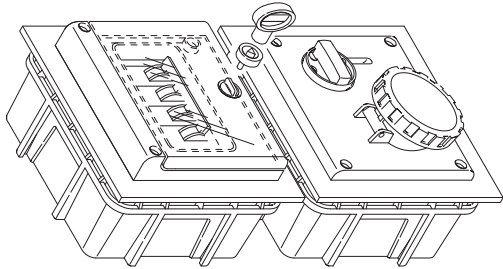

SURFACE MOUNTING INSTALLATIONS

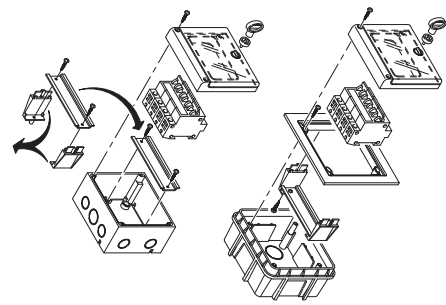
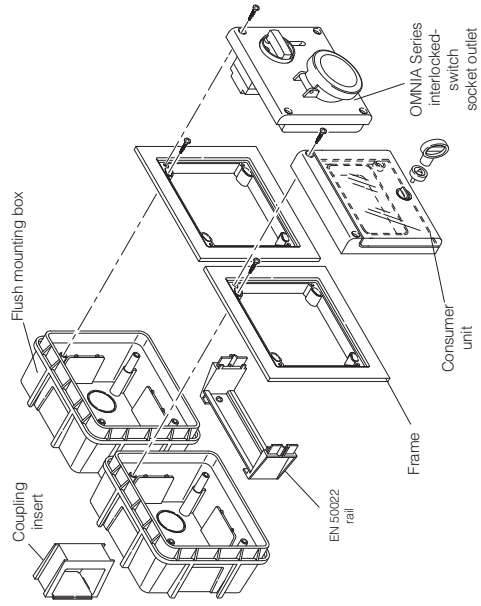
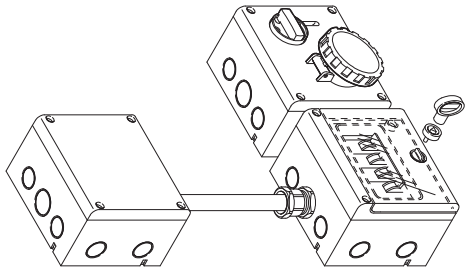

Consumer unit with DIN window.  
Flush or surface mounting installation.

## ■ DOMESTIC INTERLOCKED SOCKET



**IEC 60884-2-6**  
Plugs and socket-outlets for household and similar purposes.  
*Part 2-6: Particular requirements for switched socket-outlets with interlock for fixed electrical installations.*

## ■ REFERENCE STANDARDS

## ■ BEHAVIOUR WITH CHEMICAL AND ATMOSPHERIC AGENTS

Saline solution	Acids		Bases			Solvents			Mineral oil	UV rays
	Concentrated	Diluted	Concentrated	Diluted	Hexane	Benzol	Acetone	Alcohol		
Resistant	Limited Resistance	Resistant	Resistant	Resistant	Not Resistant	Not Resistant	Not Resistant	Limited Resistance	Resistant	Resistant

## ■ VERSIONS

	Without protection
	With fuse
	MCB
	RCBO
<b>Operating ambient temperature according to the reference standard:</b> -15°C +35°C	
<b>Maximum operating ambient temperature:</b> 60°C	
<b>Glow Wire test:</b> 650°C/850°C (Contact-holder base)	
<b>Material:</b> Engineering plastic	
<b>IK Degree at 20°C:</b> IK08	
<b>Colour:</b> BASE: Grey RAL 7035 COVER: tinted transparent	

## ■ TECHNICAL CHARACTERISTICS

Rated current:	10A-13A-16A
Rated voltage:	250 Vac
Frequency:	50 Hz
Insulating voltage:	250 Vac
Fuse:	10A - 250V~
MCB:	16A - 1P+N, C16, 3kA 10A - 1P+N, C10, 3kA
RCBO:	16A - 1P+N, C16, 10mA, 3kA 10A - 1P+N, C10, 10mA, 3kA
Protection degree:	IP56

## ■ AVAILABLE STANDARDS

	<b>ITALIAN STANDARD</b> P30 - 16A Shuttered socket CEI 23-50		<b>GERMAN STANDARD</b> 16A Shuttered socket DIN VDE 0620		<b>FRENCH STANDARD</b> 16A Shuttered socket NFC 61-314		<b>ITALIAN STANDARD</b> PT711 - 16A Shuttered socket CEI 23-50		<b>ARGENTINIAN STANDARD - 10A</b> Unshuttered socket IRAM 2071
	<b>BRITISH STANDARD - 13A</b> Shuttered socket BS 1363-2		<b>SWISS STANDARD - 10A</b> Unshuttered socket SEV 1011:1998		<b>SOUTH AFRICAN STANDARD - 16A</b> Shuttered socket SANS 164-1 (2006)		<b>INDIAN STANDARD - 6/16A</b> Shuttered socket IS 1293:1988		
	<b>NEW ZEALAND STANDARD - 10A</b> Unshuttered socket AS/NZS 3112								

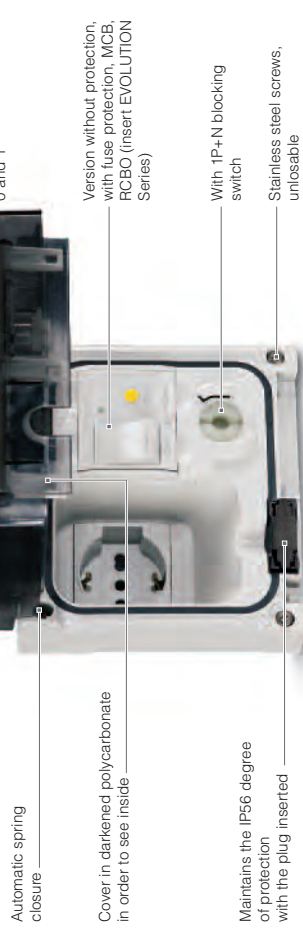



OMNIAPLUS Series

■ APPLICATION EXAMPLES

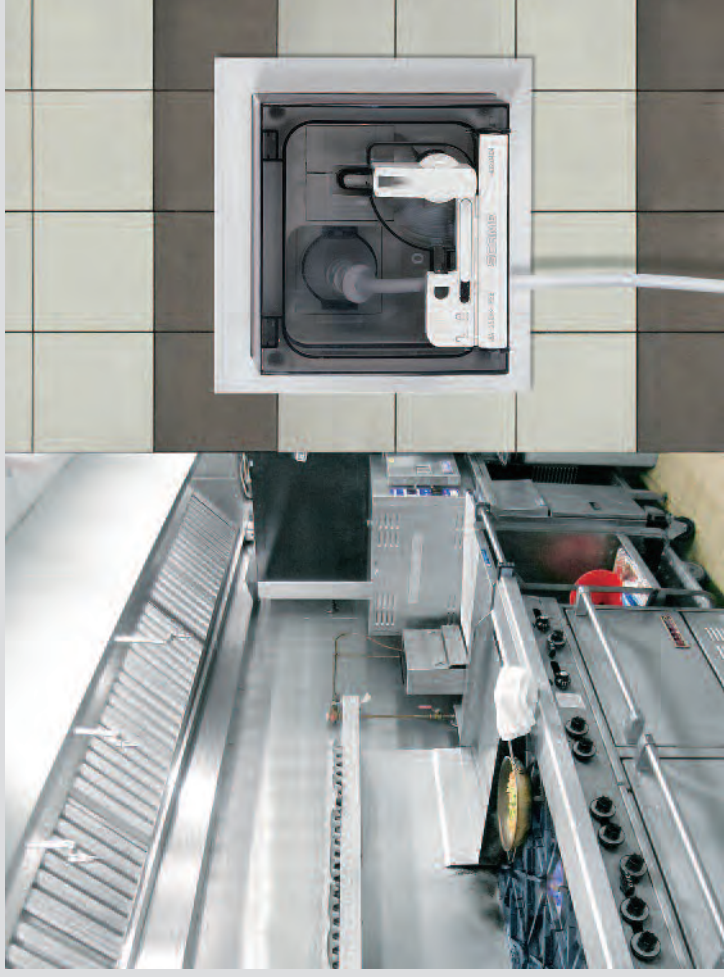

MBOX Series



OMNIA Series



ADVANCE Series



DOMINO Series

## INDUSTRIAL PLUGS AND SOCKETS



## VERSIONS

Plugs	
Connectors	
Appliance inlets	
Flush mounting socket outlets	
Surface mounting socket outlets	

Nickel-plated brass pins to guarantee long-lasting efficiency of the electrical contact.

## REFERENCE STANDARDS

### EN 60309-1

Plugs, socket-outlets and couplers for industrial purposes.  
Part 1: general requirements.

### EN 60309-2

Plugs, socket-outlets and couplers for industrial purposes.  
Part 2: dimensional interchangeability requirements for pin and contact-tube accessories.

## QUALITY MARKS



## TECHNICAL CHARACTERISTICS

Rated current:	16A-32A-63A-125A
Rated voltage:	100-690V~
Frequency:	d.c - 50±500HZ
Insulating voltage:	500/690V~
Protection degree:	IP44/IP54 - IP66/IP67/IP69
Operating ambient temperature according to the reference standard:	-25°C +40°C
Max operating ambient temperature:	60°C
Glow Wire test:	650°C/850°C
Material:	Engineering plastic
IK degree at 20°C:	IK08
Cable inlets:	Cable gland
Halogen free:	Yes
Terminals:	Screw (16A-32A-63A-125A) Insulation perforating (16A) Spring (32A mobile) Spring (16A-32A flush/surface mounting) Mantle (63A-125A)
Safe-in device:	16A
Snap-on device:	16A-32A
Nickel-plated pins:	16A-32A-63A-125A

## NICKEL-PLATED PINS



## BEHAVIOUR WITH CHEMICAL AND ATMOSPHERIC AGENTS

Saline solution	Acids		Bases			Solvents				Mineral oil	UV rays
	Concentrated	Diluted	Concentrated	Diluted	Hexane	Benzol	Acetone	Alcohol	Limited Resistance		
Resistant	Limited Resistance	Resistant	Resistant	Resistant	Not Resistant	Not Resistant	Not Resistant	Limited Resistance	Limited Resistance	Limited Resistance	Limited Resistance

## WIRING AND INSTALLATION

Wiring capacity of the terminals (mm<sup>2</sup>)

Max. cable size accepted by the cable clamp:

Rated voltage	Rated current (A)	Plugs connectors and appliance inlets		Socket outlets		Rated current (A)	Outside Ø mm	
		Min	Max	Min	Max		Min	Max
Over 50V	16A	1	2.5	1.5	4	16A	8	15
	32A	2.5	6	2.5	10	32A	11,5	21
	63A	6	16	6	25	63A	17	31
	125A	16	50	25	70	125A	26	48

## APPLICATION EXAMPLES







On the 16A and 32A "Snap-on" device with stainless steel spring to guarantee frequent opening/closing (possibility to inspect the terminals).



External cable stay with tulip clamping having IP66/IP67/IP69 cable gland functions (the device is used on both IP44/IP54 and IP66/IP67/IP69 products).

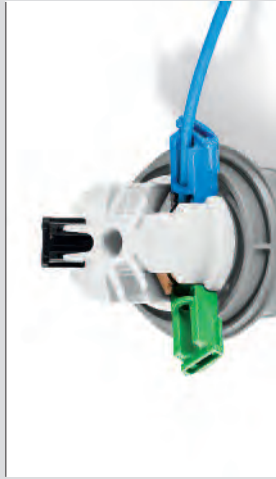

16A plugs and connectors with insulation perforating terminals which allow wiring without stripping the conductor.

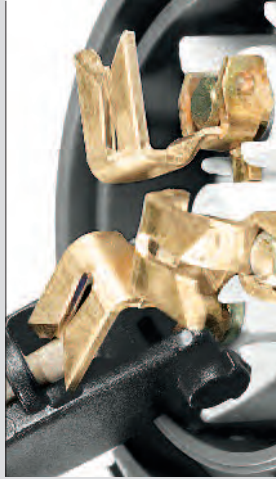

Insulation piercing terminal made in highly elastic phosphor bronze.



Internal profile of the handle which avoids the accidental opening of the contact.



Socket/plug module with screw terminals (16A - 32A - 63A - 125A).



16A and 32A plugs and connectors with screwless spring terminal. Requires cable stripping, but not the tightening of the screws.



16-32A plugs, flush mounting sockets and surface mounting sockets with spring terminals.

## EXTRACTION FORCES

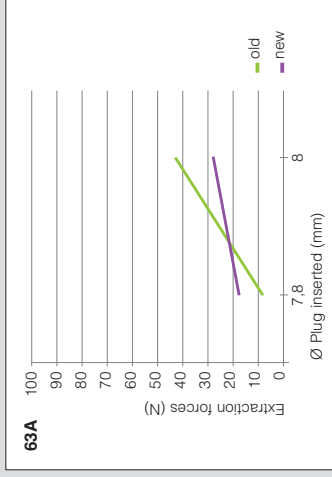

The reduction in plug-socket insertion and extraction forces was obtained thanks to the study of a new compression spring of the socket contact. As illustrated in this graph, the reduction in the force was an average of 30% compared to the previous versions, in any event guaranteeing low contact resistance.

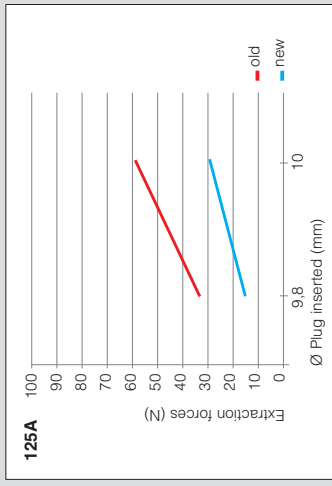

The materials of the pin and contact tube have different surface hardness so as to eliminate, during insertion and extraction operations, the layer of oxide that forms on the surface, thus improving contact smoothness and resistance while keeping them unchanged over time.



The axial incisions and the new compression spring of the socket contact with elasticity coefficient such as to keep insertion and extraction forces constant.



The nickel-plating of the socket contact combined with the special drawing and polishing process increase smoothness and ensure a higher number of contact points.

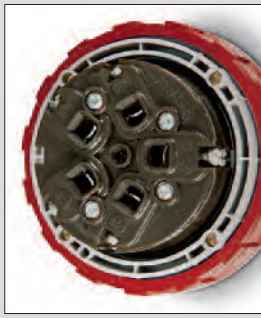

Thanks to their characteristic geometry, the new mantle terminals are suited to all types of conductors and terminals. They increase cable accessibility and contact surface, thus allowing higher tightening torques to benefit contact resistance and seal.



All gaskets are moulded directly on the cover and at the coupling point with the grip. Grip closing is by means of metric screws and metal inserts, making tightening easier and allowing for unlimited inspections and closings.

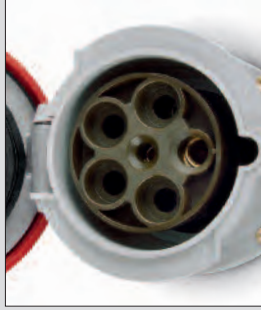

Contact holder in special technopolymer with fibreglass, featuring high heat resistance. Pilot contacts available as standard equipment on both plugs and sockets.



Entirely made with halogen-free materials, with excellent mechanical resistance to impacts, chemical substances and UV rays.



## ■ THE "SAFE-IN" SAFETY DEVICE

The "SAFE-IN" safety device assembled on the 16A industrial sockets is the most innovative element of the new OPTIMA Series. The "SAFE-IN" device works like the protection installed on household sockets, i.e., by means of an appropriate shutter, it closes the input of the socket contact tubes and prevents accidental and voluntary contact of live parts of the socket with slim objects, such as screwdrivers or wires. This protection offers an additional safety guarantee, in addition to that already provided by the spring-loaded cover assembled on the mobile sockets.

## ■ SAFETY LEVEL OF THE OPTIMA SERIES SOCKETS

The OPTIMA Series sockets with the "SAFE-IN" safety device guarantee a higher level of safety in comparison with ordinary industrial sockets, especially in environments where there may be children present or people who have not been trained about electrical dangers (public areas, amusement parks, campgrounds, open markets, etc.). Dangerous situations, such as the important examples illustrated in the figure to the side, can be resolved thanks to the new OPTIMA Series sockets equipped with the "SAFE-IN" safety device.



Connector tube protective shutter for greater safety against direct contacts. (The SAFE-IN safety device).

## ■ APPLICATION EXAMPLES

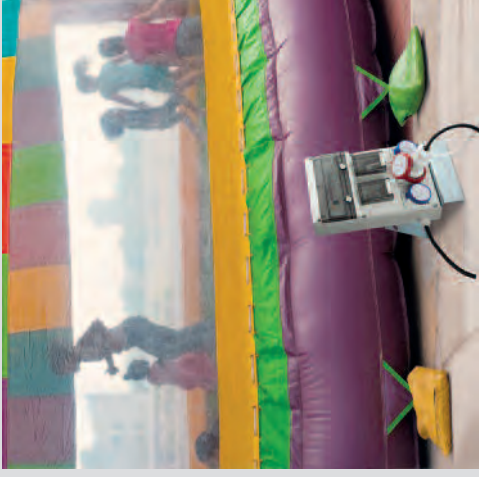

## ■ POTENTIALLY DANGEROUS SITUATIONS



## INDUSTRIAL SURFACE MOUNTING SOCKET OUTLETS



## REFERENCE STANDARDS

### EN 60309-1

Plugs, socket-outlets and couplers for industrial purposes. Part 1: general requirements.

### EN 60309-2

Plugs, socket-outlets and couplers for industrial purposes. Part 2: dimensional interchangeability requirements for pin and contact-tube accessories.

## QUALITY MARKS



## VERSIONS



BASE version



TOP version (with or without switch)



COMBI version (with or without switch)

## SURFACE MOUNTING INSTALLATION AXIS

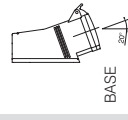

BASE

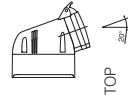

TOP

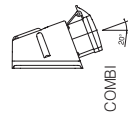

COMBI

## REFERENCE STANDARDS

### EN 60309-1

Plugs, socket-outlets and couplers for industrial purposes. Part 1: general requirements.

### EN 60309-2

Plugs, socket-outlets and couplers for industrial purposes. Part 2: dimensional interchangeability requirements for pin and contact-tube accessories.

## QUALITY MARKS



## TECHNICAL CHARACTERISTICS

Rated current:	16A-32A-63A-125A
Rated voltage:	100±690V ~
Frequency:	d.c - 50±500Hz
Insulating voltage:	500/690V~
Protection degree:	Base: IP44/IP54 Top: IP44 - IP66/IP67/IP69 COMBI: IP44/IP54 closed cover
Operating ambient temperature according to the reference standard:	-25°C +40°C
Max. operating ambient temperature:	60°C
Glow Wire test:	650°C (housing) 850°C (contact carrier)
Material:	Engineering plastic
IK degree at 20°C:	IK08
Cable inlets:	Cable sleeve IP44/IP54 Cable gland IP66/IP67/IP69
Halogen free:	Yes
Terminals:	Screw (16A-32A) Spring (32A) Mantle (16A-125A)
Safe-in device:	16A
Fuses:	Max 10A - 5x20mm (COMBI version)
	H: high power cutoff (1500A) T: delayed action

## BEHAVIOUR WITH CHEMICAL AND ATMOSPHERIC AGENTS

Saline solution	Acids		Bases			Solvents		Mineral oil	UV rays
	Concentrated	Diluted	Concentrated	Diluted	Hexane	Benzol	Acetone		
Resistant	Limited Resistance	Resistant	Resistant	Resistant	Not Resistant	Not Resistant	Not Resistant	Limited Resistance	Limited Resistance



Fastening to exterior wall.



TOP version: threaded knockout hole inlets, version IP66/IP67/IP69, for quick fastening of the cable entry device. IP44 versions supplied with cable gland.



TOP version: ability to create entry-exit.

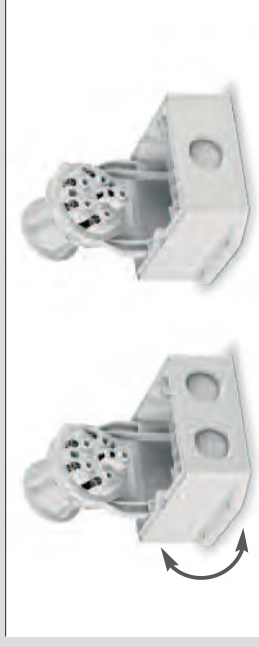

TOP version: reversible base and removable socket for easy wiring.

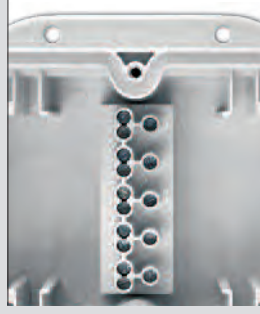

TOP IP66/IP67/IP69 version: integrated, one-piece gasket, fastening screws outside the gasket.



TOP version: entry-exit terminal board accessory.



TOP version: versions with SAFE-IN (16A) safety device available.



COMBI version: combined versions, industrial and household socket.

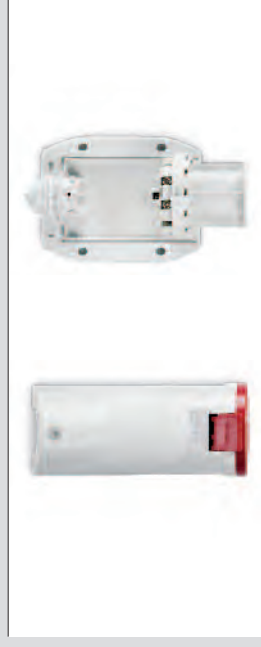

BASE version: simplified wiring. Socket fixed to the base, open terminals orientated in the same direction and easily accessible.





## ■ PLUGS AND CONNECTORS FOR DEMANDING APPLICATIONS



## ■ REFERENCE STANDARDS

### EN 60309-1

Plugs, socket-outlets and couplers for industrial purposes.  
*Part 1: general requirements.*

### EN 60309-2

Plugs, socket-outlets and couplers for industrial purposes.  
*Part 2: dimensional interchangeability requirements for pin and contact-tube accessories.*

## ■ APPLICATION EXAMPLES



## ■ TECHNICAL CHARACTERISTICS

Rated current:	16A-32A-63A-125A
Rated voltage:	48-440V~
Frequency:	50-60Hz
Insulating voltage:	500/690V~
Protection degree:	IP66/IP67/IP69
Operating ambient temperature according to the reference standard:	-25°C +40°C
Max operating ambient temperature:	-40°C +60°C
Glow Wire test:	960°C
Self extinguishing UL94:	5VA
Material:	Thermoplastic
IK degree:	IK10
Terminals:	Screw
Snap-on:	16A-32A
Nickel plated pins:	16A-32A-63A-125A

## OUTSTANDING HEAT AND FIRE RESISTANCE

The technopolymer used for OPTIMA-HD guarantees an excellent heat and fire resistance: Glow Wire 960°C according to EN 60695-2-1; 5VA according to UL94.

## OUTSTANDING IMPACT RESISTANCE

This material guarantees an excellent mechanical resistance to impacts. The impact resistance of the casings is higher than 20J (IK10) according to EN50102, even under limit temperature conditions (-40°C +60°C).

## RESISTANCE TO ATMOSPHERIC AGENTS

The structure and materials used also make OPTIMA-HD a product suited for the most extreme environmental conditions. The special silicon gasket and the IP67 degree guarantees an excellent seal against the entry of solid objects or liquids into the casings even after a long term installation, and an outstanding resistance against UV radiation.

## ■ BEHAVIOUR WITH CHEMICAL AND ATMOSPHERIC AGENTS

Saline solution	Acids		Bases		Solvents			Mineral oil	UV rays
	Concentrated	Diluted	Concentrated	Diluted	Hexane	Benzol	Acetone		
Limited Resistance	Resistant	Resistant	Resistant	Resistant	Not Resistant	Not Resistant	Not Resistant	Limited Resistance	Limited Resistance

# OPTIMA-METAL Series HDAL and HDAS Type

## ■ ASSISTED CONNECTORS



## ■ REFERENCE STANDARDS

### EN 60309-1

Plugs, socket outlets and couplers for industrial purposes.  
*Part 1: General requirements*

### EN 60529

Degrees of protection provided by enclosure.

## ■ CABLE CONNECTION

Back terminals dimensions

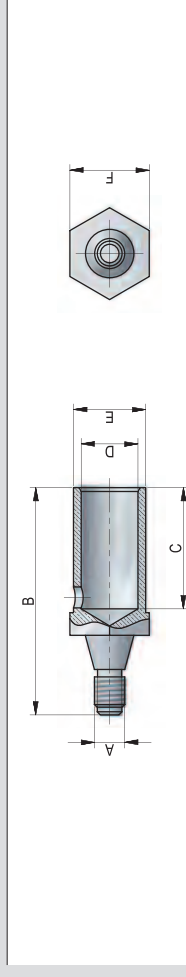

Section (mm²)	HDAL250 / HDAS250						HDAL500 / HDAS500						HDAL800 / HDAS800					
	A	B	C	D	E	F	A	B	C	D	E	F	A	B	C	D	E	F
50	3P+E M5	50	29	Ø10,8	Ø14	17	M8	52	24	Ø10,8	Ø14	21						
	4P+E M5	50	24	Ø10,8	Ø14	14												
70	3P+E M5	50	29	Ø13	Ø17	17	M8	56	29	Ø13	Ø17	21						
	4P+E M5	52	29	Ø13	Ø17	14												
95	3P+E 4P+E M5	55	30	Ø15	Ø19	17	M8	60	32	Ø15	Ø19	21						
120	3P+E 4P+E						M8	64	35	Ø16,5	Ø21	21						
150	3P+E 4P+E						M8	64	35	Ø18,5	Ø22,5	21						
185	3P+E 4P+E						M8	62	32	Ø21	Ø25	21						
240	3P+E 4P+E						M8	76	43	Ø23	Ø28	21	M10	74	43	Ø23	Ø28	28
300	3P+E 4P+E												M10	80	49	Ø27	Ø33	28

## ■ MAXIMUM CONDUCTOR AND CABLE SIZES

	Cable outside diameter (mm)		Sheathing stripping length (mm)		Insulation stripping length (mm)	
	min	max	Phases	$\pm$		
HDAL250 / HDAS250 (60°)	32	60	110	±150		
HDAL500 / HDAS500 (ANGLED HANDLE)	45	80	160	±220		(see table page 7, mark C)
HDAL500 / HDAS500 (STRAIGHT HANDLE)	45	80	200	±210		
HDAL800 / HDAS800	52	100	145	±145		

## ■ CRIMPING INSTRUCTIONS

Insert the cable into the cable terminal and crimp the cable using a hexagonal crimping tool with the jaw adapted to the cable section.

Thread the cable terminal into the male or female contacts and tighten by a wrench torque using the tightening torque (see table on the side)

OPTIMA-METAL HDAL250: 4Nm  
OPTIMA-METAL HDAL500: 20Nm  
OPTIMA-METAL HDAL800: 25Nm

## ■ LOCKINGS

HDAL type can be equipped with different type of lockings avoiding use of the connectors by people not allowed. Available an additional satty key.

## ■ MICROSWITCH

HDAL250, HDAL500 and HDAL800 sockets can be equipped with a microswitch for information transmission.

## ■ HDAS TYPE VERSIONS

	Socket
	Straight plug
	Appliance inlet
	Connector

## ■ HDAL TYPE VERSIONS

	Socket
	Plug
	Connector
	Reversed socket AVAILABLE ON REQUEST
	Reversed plug AVAILABLE ON REQUEST

## ■ LIST OF MATERIAL USED

Casings:	Corrosion proof tempered cast aluminium
Inserts:	Thermo-hardening moulded plastic
Contacts:	Silver plated copper alloy
Screws and fastenings:	Stainless steel
Seals:	Neoprene

## ■ MECHANICAL CHARACTERISTICS

Protection degree:	IP67
Casings:	Corrosion proof tempered cast aluminium
Fastenings:	Stainless steel
Ambient temperature range:	-30°C / +60°C
Mechanical shocks withstand:	IK10

# OPTIMA-METAL Series

## HDAL - HDIN - HDAS Type



# OPTIMA-METAL Series

### CONTACTS

Contacts are built in 2 parts:

- One front part, male or female used for the connection between plug and socket (contact)
- One back part, called the terminal, in which the cable is crimped, screwed or soldered. It is ended by a threaded cone to screw into the contact.

#### HDAL type

HDAL sockets are equipped with insertion-withdrawal lever system which provides simple and quick mating and unmating operations and IP67 coupling. It is recommended for application which require frequent coupling or in presence of strong vibrations. When plug is not inserted, insertion-withdrawal lever provide automatic closing of socket lid to seal socket and provide IP67 protection when it is not in use.

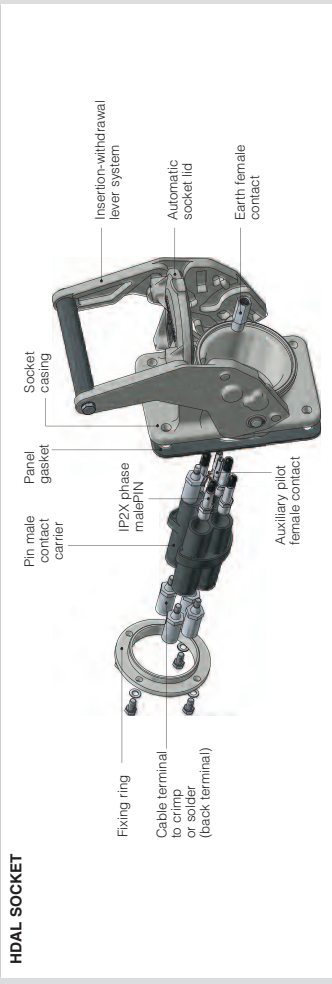
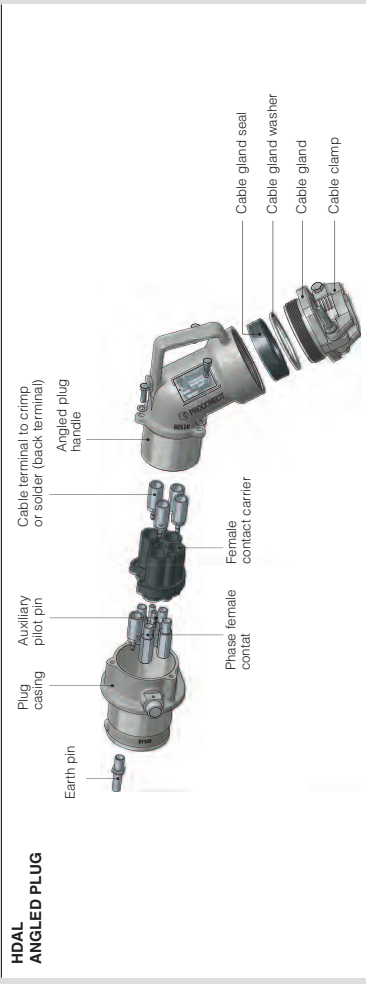

#### HDAS type

HDAS plugs and sockets are mated and unmated by means of screw collar on plugs and collar ring on sockets giving secure IP67 coupling. Screw socket lid is supplied as standard on sockets and connectors to provide IP67 protection when they are not in use.

#### HDAS PLUG

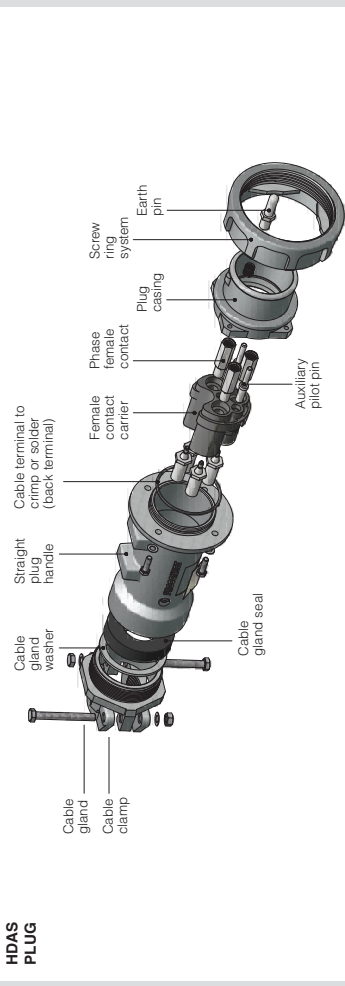

#### HDAS SOCKET

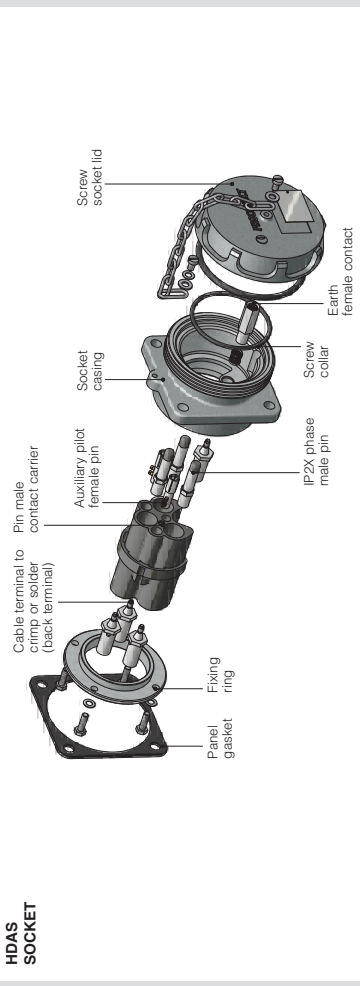

### IP2X CONTACTS FOR HDAL250 / HDAL500 / HDIN250 / HDAS250 / HDAS500

#### Male contacts

Supplying connectors (generally sockets and connectors) are intended the contacts that supply the voltage, they are fitted with insulated cap that guarantee IP2X (Finger protection), this protection is not available for HDAL800 and HDAS800. Male contact pins are supplied with cable terminal in which the cable is crimped or soldered.

#### Female contacts

Receiving connectors (generally plugs and appliance inlets), are intended the contacts that receive the voltage, they are fitted with the slotted sleeve of female contacts. They are supplied with cable terminal in which the cable is crimped or soldered.

#### Pilot pins

All standard products are equipped with 2 pilot pins. Their characteristics of connecting later and disconnecting earlier than phase pins is for making electrical interlock insuring that no connection and disconnection occur under load.

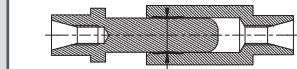
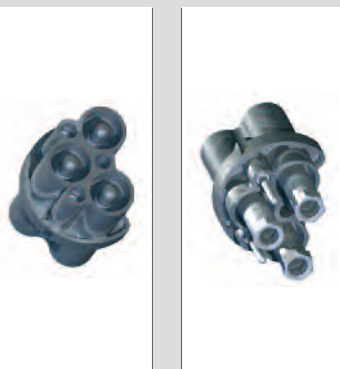

Diam. (mm)	Nb lamelles	Amp.
10	21	250
12	22	320
14	29	400
16	33	500
18	37	640
20	41	800

**Multipoint contacts**  
SCAME power connector contacts are silver-plated self cleaning and make use of a special technique using lamellar technology with multicontacts. This technology guarantees a great number of connections points (see table), excellent temperature resistance (up to 200 °C) and low insertion force.

	Amperage		Voltage		Nb contacts		Nb pilots		Section		Diam. Cable	
	Max.	up to	1,000V	1,000V	Max.	Max.	Max.	Max.	Max.	Max.	Max.	
HDAL250/HDAS250	250A	1,000V	5	2	95 mm <sup>2</sup>	60 mm						
HDAL500/HDAS500	570A	1,000V	5	2	240 mm <sup>2</sup>	80 mm						
HDAL800/HDAS800	800A	1,000V	5	2	300 mm <sup>2</sup>	100 mm						



# OPTIMA-METAL Series HDIN250 Interlocked socket

## ■ INTERLOCKED SOCKET



## ■ REFERENCE STANDARDS

### EN 60309-1

Plugs, socket outlets and couplers for industrial purposes.  
*Part 1: General requirements.*

### EN 60309-4

Plugs, socket outlets and couplers for industrial purposes.  
*Part 4: Switched socket-outlets and connectors with or without interlock.*

## ■ CONNECTOR CHARACTERISTICS

- OPTIMA-METAL Series HDIN250 Switch Sockets (mechanical interlock):  
3P+E 250 A 400-690 V  
3P+N+ E 250 A 400-690 V
- OPTIMA-METAL Series HDIN250 Fuse switch sockets (mechanical interlock):  
3P+E 250 A 400-690 V (Icv: 50 kA - 400V)  
3P+N+ E 250 A 400-690 V (Icv: 50 kA - 400V)
- OPTIMA-METAL Series HDIN250 With MCCB (electrical interlock):  
3P+E 250 A 400-690 V (Icv: 50 kA - 400V)  
3P+N+ E 250 A 400-690 V (Icv: 50 kA - 400V)
- OPTIMA-METAL Series HDIN250 With MCCB plus RCD (electrical interlock):  
3P+E 250 A 400-690 V (Icv: 50 kA - 400V)  
3P+N+ E 250 A 400-690 V (Icv: 50 kA - 400V)

SCAME OPTIMA-METAL Series can also be delivered with mechanical and electrical interlocked socket with housing of polyester powder coating metal sheet enclosure.

Mechanical interlocked socket are provided with a wide range of switches and protection devices as: switch disconnecter, fuse switch disconnecter, MCCB (Molded case Circuit Breaker) and MCCB with RCD (Residual Current Device).

The interlock mechanism prevents making and breaking of power under load.

"The switch cannot be actuated to the ON position until a compatible plug is fully inserted, and the plug cannot be removed until the switch is in the OFF position".

**Switched socket with interlock HDIN can be mated only with HDAL250 plugs.**

## ■ APPLICATION EXAMPLES

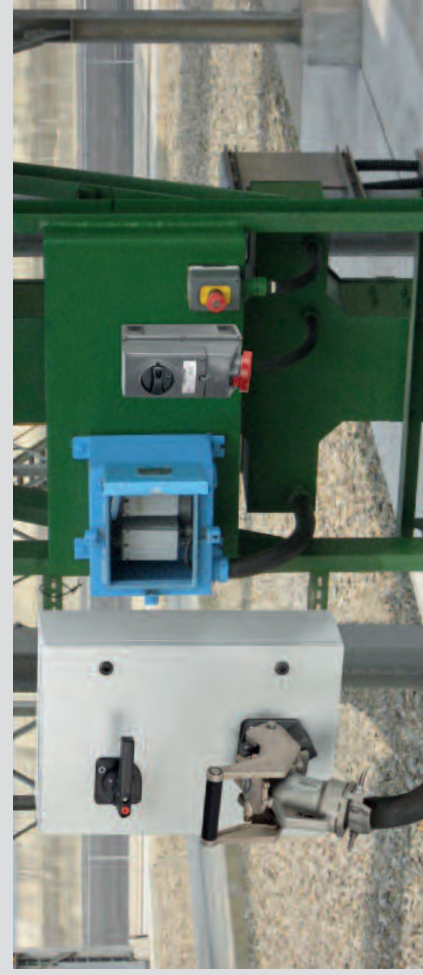

## ■ TECHNICAL DATA RATING SWITCH DISCONNECTORS 3P AND 3P+N 250A

Rated current	(A)	25	
Rated insulation voltage	(V)	1000	
Impulse withstand voltage	(kV)	12	
Rated thermal current	(A)	250	
Rated operational current	415V	(A) 250	
	500V	(A) 250	
	690V	(A) 250	
Rated making capacity	415V	(A) 250	
	500V	(A) 250	
	690V	(A) 250	
Rated breaking capacity	415V	(A) 250	
	500V	(A) 200	
	690V	(A) 160	
Short circuit withstand current 1 sec.	(kA)	8	
Short circuit withstand current 0.25 sec.	(kA)	16	
Rated operational power	(kW)	13.5	
Rated fuse short-circuit current	Back up fuse	(A)	250
	R.M.S. value	(kA)	50
	Peak value	(kA)	25
	Cable section	mm <sup>2</sup>	120
	Bars dimension	mm <sup>2</sup>	20x5

## ■ ENCLOSURE TECHNICAL CHARACTERISTICS

Polarity:	3P-3P+N
Rated current:	250A
Protection degree:	IP65
Operating ambient temperature according to the reference standard:	-5 °C / +40 °C
Mix-Max. operating ambient temperature:	-25 °C +60 °C
Material:	Sheet steel
IK degree:	IK10
Finishing/colour:	Polyester powder grey RAL7032
3P+N with late break early make neutral pole. Padlockable handle. Equipped with door locking.	

## ■ WIRING OPERATIONS

Wiring capacity of the terminals (mm<sup>2</sup>):

Type	min.	max
Switch	70	185
Fuses switch	90	120
MCCB	70	185
MCCB + RCD	70	185

### ■ SWITCHING CONNECTOR



### ■ REFERENCE STANDARDS

#### EN 60309-1

Plugs, socket outlets and couplers for industrial purposes.  
*Part 1: General requirements.*

#### EN 60947-3

Low voltage switchgear and controlgear.  
*Part 3: switches, disconnectors, switch-disconnectors and fuse combination unit.*

### ■ LIST OF MATERIAL USED

Size	Casing	Flat Seal	Lip seal	Insert	Latch	Contact	Handle	Wall box	Inclined sleeve	Screw	Plug cap
HDSD200	ASTG	Neopren	Nitrile	PAG	ASTG	Copper/Silver	EPDM	ASTG	ASTG	Stainless steel	PAG

### ■ MAXIMUM CONDUCTOR AND CABLE SIZES

	Cable outside diameter (mm)		Sheathing stripping length (mm)	Insulation stripping length (mm)
	Min.	Max.		
899.SD2G	22	50	155	38
899.SD2GM	25	62	155	38
899.SD2GMA	25	62	155	38

### ■ WATERTIGHT CONNECTORS WITH SWITCHING CAPACITY

Our **HDSD200** range of connectors is extremely robust and supercedes the requests of **EN 60309-1** standards in terms of safety, insulation, temperature resistance, heating, life duration, resistance to shocks and traction on the cables.

Besides, due to the special technology of the contacts and the materials chosen, the 3PS series can be used as **SWITCHED sockets**, according to the standard **EN60947-3, AC23**.

### ■ SAFETY DISC (IP4X)

This device protects the user preventing accidental and voluntary contact of live parts of the sockets and connectors even with small linear tool or wire with a diameter of 1 mm. Which corresponds to IP4X degree protection.

### ■ CONTACTS

**HDSD200** connectors are fitted with butt contacts which have a brazed silver alloy tip for low voltage drop and high arc resistance. These contacts warrant an excellent behaviour of the switching function.



Butt contacts with brazed silver alloy tip.

### ■ ELECTRICAL CHARACTERISTICS

Rated current:	150/250A
Max. Voltage:	1000 V AC / 250 V DC
Switching capacity:	150A AC23 (acc. IEC 60 947-3) *

\* up to 150A 500V

### ■ MECHANICAL CHARACTERISTICS

Protection degree:	IP4X when lid open IP66
Housings:	Corrosion proof cast aluminum
	Stainless steel fastenings
	Self-closing lid
Ambient temperature range:	- 30° C / + 60° C
Mechanical shocks withstand:	IK09 (metal)

HDSD200 plugs and sockets are equipped of an innovative system to disconnect the equipment on full load up to 200A by special contacts able to macking carrying and bracking current as a switch disconnector even in case of high inductive loads, like motor loads. So that connections and disconnections can be done under load in complete safety and reliability.

HDSD200 plugs and sockets have also a device to avoid wrong mating between plug and socket with different amperage, voltage and number of poles as for IEC60309 plugs and sockets.

Finally a very high level of safety is guaranteed by shatter (safety disc) on the sockets or connectors which are the supplier part normally live (IP4X when lid is open).

HDSD200 range is the complete answer for management who take industrial safety seriously and have many non-specialist personnel needing power for portable tools and equipment.

Our HDSD200 plug and sockets are moulded in high quality plastic materials which combine exceptional impact resistance, tolerance of most industrial chemicals, detergents and exposure to UV light.



## ■ PLUGS WITH PHASE INVERTER



## ■ REFERENCE STANDARDS

### EN 60309-1

Plugs, socket-outlets and couplers for industrial purposes.  
*Part 1: general requirements.*

### EN 60309-2

Plugs, socket-outlets and couplers for industrial purposes.  
*Part 2: dimensional interchangeability requirements for pin and contact-tube accessories.*

## ■ VERSIONS



Plugs



Appliance inlets

## ■ PHASE INVERTER



Fixed and movable plugs which rapidly invert two phases in order to return to the correct direction of rotation of three-phase motors for movable and fixed applications.

## ■ TECHNICAL CHARACTERISTICS

Rated current:	16A-32A
Rated voltage:	346+415V~
Frequency:	50+60Hz
Insulating voltage:	690V~
Protection degree:	IP44/IP54 - IP66/IP67/IP69
Operating ambient temperature according to the reference standard:	-25°C +40°C
Max. operating ambient temperature:	60°C
Glow Wire test:	650°C (housing) 850°C (contact carrier)
Material:	Engineering plastic
IK degree at 20°C:	IK08
Cable inlets:	Cable gland
Halogen free:	Yes
Terminals:	Screw
Snap-on device:	16A-32A
Polarity:	3P+E / 3P+N+E
Connectable cables:	Flexible class 5 or 6

## ■ BEHAVIOUR WITH CHEMICAL AND ATMOSPHERIC AGENTS

Saline solution	Acids		Bases			Solvents			Mineral oil	UV rays
	Concentrated	Diluted	Concentrated	Diluted	Hexane	Benzol	Acetone	Alcohol		
Resistant	Limited Resistance	Resistant	Resistant	Resistant	Not Resistant	Not Resistant	Not Resistant	Limited Resistance	Limited Resistance	Limited Resistance

## ■ WIRING AND INSTALLATION

Wiring capacity of the terminals (mm<sup>2</sup>)

Rated voltage	Rated current (A)	Plugs		Rated current (A)	Outside Ø mm	
		Appliance inlets	Max		Min	Max
Over 50V	16A	1	2,5	16A	8	15
	32A	2,5	6	32A	11,5	21

Max. cable size accepted by the cable clamp:

Rated voltage	Rated current (A)	Plugs		Rated current (A)	Outside Ø mm	
		Appliance inlets	Max		Min	Max
Over 50V	16A	1	2,5	16A	8	15
	32A	2,5	6	32A	11,5	21

## ■ OPERATING PRINCIPLE OF THE PHASE INVERTER



The phases are inverted by simply pushing and turning the phase pin support with a screwdriver.

## INDUSTRIAL PLUGS AND SOCKETS



## REFERENCE STANDARDS

### EN 60309-1

Plugs, socket-outlets and couplers for industrial purposes.  
Part 1: general requirements.

## QUALITY MARKS



## VERSIONS

Plugs	
Connectors	
Appliance inlets	
Flush mounting socket outlets	
Surface mounting socket outlets	

## TECHNICAL CHARACTERISTICS

Rated current:	16A-32A
Rated voltage:	100+690V~
Frequency:	50+500Hz
Insulating voltage:	500/690V~
Protection degree:	IP44 - IP66/IP67
Operating ambient temperature according to the reference standard:	-25°C +40°C
Max operating ambient temperature:	60°C
Glow Wire test:	650°C/850°C
Material:	Engineering plastic
IK degree at 20°C:	IK08
Cable inlets:	Cable gland
Halogen free:	Yes
Snap-on device:	16A-32A
Nicke-plated pins:	16A-32A

## APPLICATION

- Star delta connections
- Tapped winding connections
- Monitoring
- Controlling and actuation
- Electrical interlocks

## BEHAVIOUR WITH CHEMICAL AND ATMOSPHERIC AGENTS

Saline solution	Acids		Bases		Solvents			Mineral oil	UV rays
	Concentrated	Diluted	Concentrated	Diluted	Hexane	Benzol	Acetone		
Resistant	Limited Resistance	Resistant	Resistant	Resistant	Not Resistant	Not Resistant	Not Resistant	Limited Resistance	Limited Resistance

## WIRING AND INSTALLATION

Wiring capacity of the terminals (mm<sup>2</sup>)

Max. cable size accepted by the cable clamp:

Rated voltage	Rated current (A)	Plugs and connectors		Appliance inlets and socket outlets		Rated current (A)		Outside Ø mm	
		Min	Max	Min	Max	Min	Max	Min	Max
Over 50V	16A	1	2.5	1.5	4	16A		8	
	32A	2.5	6	2.5	10	32A		11.5	

## APPLICATION EXAMPLES



## ■ CONTROL DEVICE



## ■ REFERENCE STANDARDS

### EN 60669-1

Switches for household and similar fixed-electrical installation.  
*Part 1: general requirements.*

## ■ UNSWITCH SOCKET OUTLETS



## ■ REFERENCE STANDARDS

### CEI 23-50

Plugs and sockets for domestic and similar applications.  
*Part 1: general requirements.*

## ■ VERSIONS

One way switch single pole  
- flush mounting  
- surface mounting

Two way switch single pole  
- flush mounting  
- surface mounting

Intermediate switch  
- flush mounting  
- surface mounting

Bell push switch single pole  
- flush mounting  
- surface mounting

Double pole switch  
- flush mounting  
- surface mounting

## ■ TECHNICAL CHARACTERISTICS

Rated current:	10A-10AX-20A-20AX
Rated voltage:	250V~
Frequency:	50Hz
Insulating voltage:	250V~
Protection degree:	IP66
Operating ambient temperature:	-20°C +60°C
Cabling capacity of the terminal:	3x2,5mm <sup>2</sup> 2x4mm <sup>2</sup> 1x6mm <sup>2</sup>
Glow Wire test:	650°C/850°C
Halogen free:	Yes
Material:	Engineering plastic
Cable inlet:	M20
Colour:	Grey RAL 7035
LED colour:	Orange

## ■ TECHNICAL CHARACTERISTICS

Rated current:	10A-13A-15A-16A
Rated voltage:	250V~
Frequency:	50Hz
Insulating voltage:	250V~
Protection degree:	IP66
Operating ambient temperature:	-5°C +60°C
Installation ambient temperature:	-20°C +60°C
Cabling capacity of the terminal:	10A: 0,75 mmq - 2,5 mmq 13A: 2,5 mmq - 6 mmq 15A: 2,5 mmq - 6 mmq 16A: 1 mmq - 2,5 mmq (according to ref. standard)
Glow Wire test:	650°C / 850°C
Halogen Free:	Yes
Material:	Engineering plastic
Cable inlets:	M20
Colour:	Base: Grey RAL 7035 Cover: tinted transparent

The IP66 degree of protection with the plug inserted is guaranteed mainly with angled plugs which can be coupled with the respective Standard sockets. This is the breakdown for the main Italian and European standards (Europe mainland):

Plug 10A 2P+E extra flat SPA11	Wireable (body length up to 50 mm) Permanent (body length up to 50 mm)	Italian bivalent standard 16A P17/P11 137.4403 137.6403	Italian standard - 16A P30 137.4404 137.6404	German standard 16A 137.4412 137.6412 137.4407 137.6407	French standard - 16A P31 137.4411 137.6411
Plug 16A 2P+E extra flat SPA17	Wireable (body length up to 50 mm) Permanent (body length up to 50 mm)				
Plug 10A 2P straight S10 "Europlug"	Wireable (body length up to 41 mm) Permanent (body length up to 50 mm)				
Plug 10A 2P+E straight S11	Wireable (body length up to 41 mm) Permanent (body length up to 50 mm)				
Plug 16A 2P straight S30	Wireable (body length up to 41 mm) Permanent (body length up to 41 mm)				
Plug 16A 2P+E straight S30	Wireable (body length up to 45 mm) Permanent (body length up to 45 mm)				
Plug 16A angled S30	Wireable (body length up to 65 mm) Permanent (body length up to 65 mm)				
Plug 16A angled S31	Wireable (body length up to 60 mm) Permanent (body length up to 65 mm)				

## ■ BEHAVIOUR WITH CHEMICAL AND ATMOSPHERIC AGENTS

Saline solution	Acids		Bases		Solvents			UV rays
	Concentrated	Diluted	Concentrated	Diluted	Hexane	Benzol	Acetone	
Resistant	Limited Resistance	Resistant	Limited Resistance	Resistant	Resistant	Not Resistant	Not Resistant	Resistant
								Limited Resistance
								Resistant



**PROTECTA Series**
**ENCLOSURES**

**REFERENCE STANDARDS**

**EN 60670-1 (2005-10)**  
Boxes and enclosures for electrical accessories for household and similar fixed electrical installations. Part 1: general requirements.

**TECHNICAL CHARACTERISTICS**

Tinted polycarbonate cover to see inside

Polycarbonate box shockproof, chemical and UV resistant

Ø20 cable entries

Stainless steel screws

A wing on the lid assist one-handed opening

3 pin operated shutter on socket

Specifically high formulated gel seal to maintain protection degree when the plug is inserted

**VERSIONS**

Empty enclosure to be assembled as for specific needs

Stylish design of flush mounting box

Easy clip-on modular devices to suit individual requirements

**AVAILABLE STANDARDS**

	<b>ITALIAN STANDARD</b> PT711 - 16A Shuttered socket CEI 23-50		<b>GERMAN STANDARD - 16A</b> Shuttered socket DIN VDE 0620		<b>FRENCH STANDARD - 16A</b> Shuttered socket NFC 61-314		<b>BRITISH STANDARD - 13A</b> Shuttered socket BS 1363-2 BS 7288:1990
	<b>ARGENTINIAN STANDARD - 10A</b> Unshuttered socket IRAM 2071		<b>NEOZELANDER STANDARD - 10A</b> Unshuttered socket AS/NZS 3112		<b>SWISS STANDARD - 10A</b> Unshuttered socket SEV 1011:1998		<b>BRAZILIAN STANDARD - 10A</b> Unshuttered socket ABNT NBR 14136:2002

**TECHNICAL CHARACTERISTICS**

Protection degree:	<b>IP66 (*)</b>
Operating ambient temperature:	<b>-5°C +60°C</b>
Installation ambient temperature:	<b>-20°C +60°C</b>
Glow Wire test:	<b>650°C</b>
Halogen free:	<b>SI</b>
Material:	<b>Engineering plastic</b>
IK degree at 20°C:	<b>IK07</b>
Cable inlets:	<b>M20</b>
Colour:	<b>Base: grey RAL 7035 Cover: tinted transparent</b>

(\*) IP55 for 3-module flush-mounting box adapter flange.

	Empty 1-module enclosure - flush mounting - surface mounting
	Empty 2-module enclosure - flush mounting - surface mounting
	Pole side by side enclosure
	Pole-top enclosure
	3-module flush-mounting box adapter IP55

## ■ CABLE REELS FOR INDUSTRIAL, COMMERCIAL AND DOMESTIC APPLICATIONS



## ■ VERSIONS

	ROLLER330 Series - For domestic applications
	ROLLER330 Series - For industrial applications
	ROLLER450 Series - With portable stand
	ROLLER-BLOCK450 Series - With wheeled portable distribution assembly stand available

## ■ REFERENCE STANDARDS

<b>IEC 61242</b> Electrical accessories cable reels for household and similar purposes.
<b>IEC 61316</b> Industrial cable reels.

## ■ QUALITY MARKS



## ■ TECHNICAL CHARACTERISTICS

Rated voltage:	230+400V~
Frequency:	50Hz
Insulating voltage:	500/690V~
Protection degree:	IP20-IP44-IP55
Operating ambient temperature according to the reference standard:	-25°C +40°C
Max. operating ambient temperature:	60°C
Glow Wire test:	650°C/850°C
Material:	Engineering plastic
IK degree at 20°C:	Roller 300: IK07 Roller 450: IK08
Cable for industrial versions:	Type H07RN-F
Cable for domestic versions:	Type H05VV-F

## ■ BEHAVIOUR WITH CHEMICAL AND ATMOSPHERIC AGENTS

Saline solution	Acids		Bases			Solvents			Mineral oil	UV rays
	Concentrated	Diluted	Concentrated	Diluted	Hexane	Benzol	Acetone	Alcohol		
Resistant	Not Resistant	Not Resistant	Limited Resistance	Resistant	Not Resistant	Not Resistant	Not Resistant	Limited Resistance	Not Resistant	Resistant

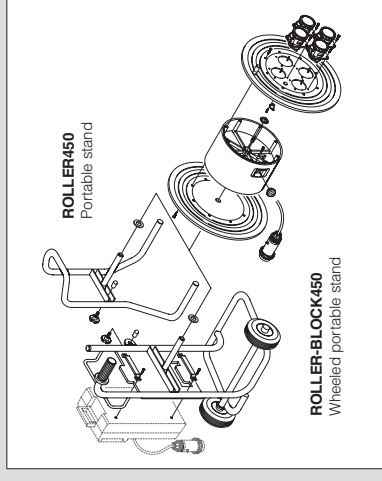
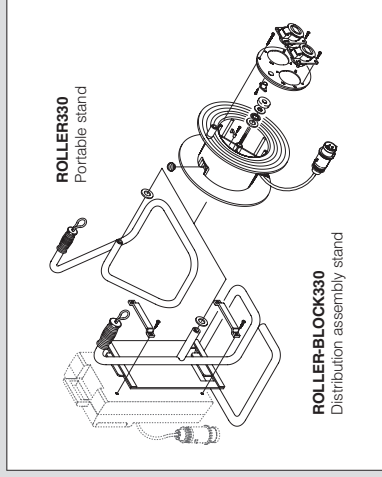

## ■ APPLICATION EXAMPLES



ROLLER Series

■ ROLLER330 SERIES



Shows: cable clamp, terminal strip, thermal overload switch, contactor, isolating protection pivot and elastic hook

■ ROLLER-BLOCK450 SERIES



The version with the interlocked switch socket outlet is well-suited for use in public entertainment venues.



**ROLLER-BLOCK450**  
Screwing a holding bracket onto the back of any BLOCK4 distribution assembly makes for a combined cable reel/assembly unit.



**ROLLER-BLOCK450**  
As well as the holding plate for attaching the distribution assembly, the cable reel comes with wheels for moving the combined unit, a cable-holding bracket, an ergonomic handle and a brake for the drum.

■ ROLLER450 SERIES



**Portable stand with integral brake.** The cable reel stand is made of corrosion-proof steel and has an adjustable thumbscrew brake to avoid unnecessary overrun.



## ■ JUNCTION BOXES FOR ELECTRICAL INSTALLATION



## ■ REFERENCE STANDARDS

### EN 60670-1

Boxes and enclosures for electrical accessories for household and similar fixed electrical installations. Part 1: general requirements.





### EN 60670-22

Boxes and enclosures for electrical accessories for household and similar fixed electrical installations. Part 22: particular requirements for connecting boxes and enclosures.

## ■ QUALITY MARKS



## ■ VERSIONS

	With cavie sleeves - IP55 - With press-fit cover
	With cavie sleeves - IP55 - With screw-down cover
	With blank sides - IP56 - With screw-down cover
	With blank sides - IP56 - Higer box with screw-down cover

## ■ BEHAVIOUR WITH CHEMICAL AND ATMOSPHERIC AGENTS

Saline solution	Acids		Bases		Solvents			Mineral oil	UV rays
	Concentrated	Diluted	Concentrated	Diluted	Hexane	Benzol	Acetone	Alcohol	
Resistant	Limited Resistance	Resistant	Limited Resistance	Resistant	Not Resistant	Not Resistant	Not Resistant	Limited Resistance	Resistant

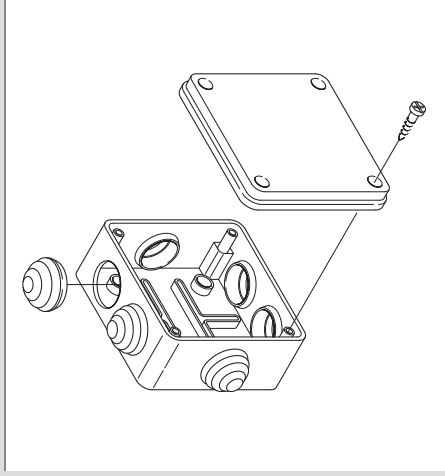

Surface mounting junction box 100x100 mm. 50 mm high box with IP55 cable sleeves. Screw-closed cover.



Wall fixing system.

## ■ HINGES KIT

An interesting novelty for the SCABOX Series, a practical hinge kit is available that permits the book-like opening of the cover while keeping it integral with the base.

The kit can be optionally applied inside the casing in a quick and simple manner; thus the SCABOX acquires greater functionality – perfect in the installation phase, during the wiring operations, and extremely practical for the subsequent phases of maintenance and inspection, since it keeps the cover supported and hinged to the base.

Pressing lightly on the small lever of the hinge, it is possible to remove the cover from the base and to thus separate the two elements.

With a simple locking manoeuvre it is possible to eventually replace the cover to the base.

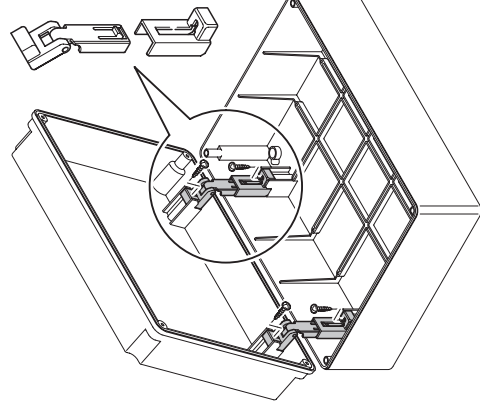

SCABOX Series  
Hinges kit (3 pieces) Item 654-0085.



## ■ MULTI-OUTLET SOCKETS



## ■ REFERENCE STANDARDS

### IEC 60884-1

Plugs and socket-outlets for household and similar purposes.  
*Part 1: general requirements.*



### CEI 23-124

Plugs and socket outlets for household and similar purposes.  
*Part 2.7: particular requirements for cord extension set.*

### CEI 23-50

Plugs and sockets for domestic and similar applications.  
*Part 1: general requirements.*

## ■ VERSIONS

	Multi-outlet sockets without luminous switch
	Multi-outlet sockets with luminous switch
	Multi-outlet sockets with lighting protection

## ■ TECHNICAL CHARACTERISTICS

Rated current:	16A
Rated voltage:	250V~
Frequency:	50Hz
Insulating voltage:	250V~
Protection degree:	IP20D
Operating ambient temperature according to the reference standard:	-15°C +35°C
Max. operating ambient temperature:	60°C
Glow Wire test:	750°C
Halogen free:	Yes
Cabling capacity of the terminal:	0,75+2,5mm <sup>2</sup>
Material:	Engineering plastic
Colour:	Random (*) Anthracite RAL 7021 Tinted (transparent) Turquoise blue (transparent)

(\*) Random colour means casual "white base – grey lid" or "grey base – white lid".

## ■ BEHAVIOUR WITH CHEMICAL AND ATMOSPHERIC AGENTS

Saline solution	Acids		Bases			Solvents			Mineral oil	UV rays
	Concentrated	Diluted	Concentrated	Diluted	Hexane	Benzol	Acetone	Alcohol		
Resistant	Limited Resistance	Resistant	Limited Resistance	Limited Resistance	Resistant	Not Resistant	Not Resistant	Resistant	Limited Resistance	Resistant

## ■ APPLICATION EXAMPLES



■ CONDUIT INSTALLATION ACCESSORIES



■ VERSIONS

	90° bend
	Conduit coupling
	Conduit to box coupling
	Conduit to box couplings (equal diameter)

■ REFERENCE STANDARDS

<p><b>EN 61386-1</b> Conduit systems for cable management. <i>Part 1: general requirements.</i></p>
<p><b>EN 61386-21</b> Conduit systems for cable management. <i>Part 2: particular requirements - rigid conduit systems.</i></p>

■ QUALITY MARKS



■ TECHNICAL CHARACTERISTICS

Protection degree:	IP66/IP67
Operating ambient temperature according to the reference standard:	-5°C +60°C
Max operating ambient temperature:	60°C
Glow wire test:	750°C
Halogen free:	Yes
IK degree at 20°C:	IK07-IK10
Material:	Engineering plastic
Colour:	Grey RAL 7035

■ BEHAVIOUR WITH CHEMICAL AND ATMOSPHERIC AGENTS

Saline solution	Acids		Bases			Solvents				Mineral oil	UV rays
	Concentrated	Diluted	Concentrated	Diluted	Hexane	Benzol	Acetone	Alcohol			
Resistant	Resistant	Resistant	Resistant	Resistant	Limited Resistance	Limited Resistance	Resistant	Resistant	Limited Resistance	Resistant	Resistant

■ CO-INJECTION MOULDED GASKET



The use of a co-injection moulding system makes it possible to turn the technopolymer gasket into an extension of the piece and disguise it as part of the pipe. It also provides a greater degree of sealing efficiency and makes it easier to insert pipe fittings without squashing or deforming the gasket.

■ APPLICATION EXAMPLES

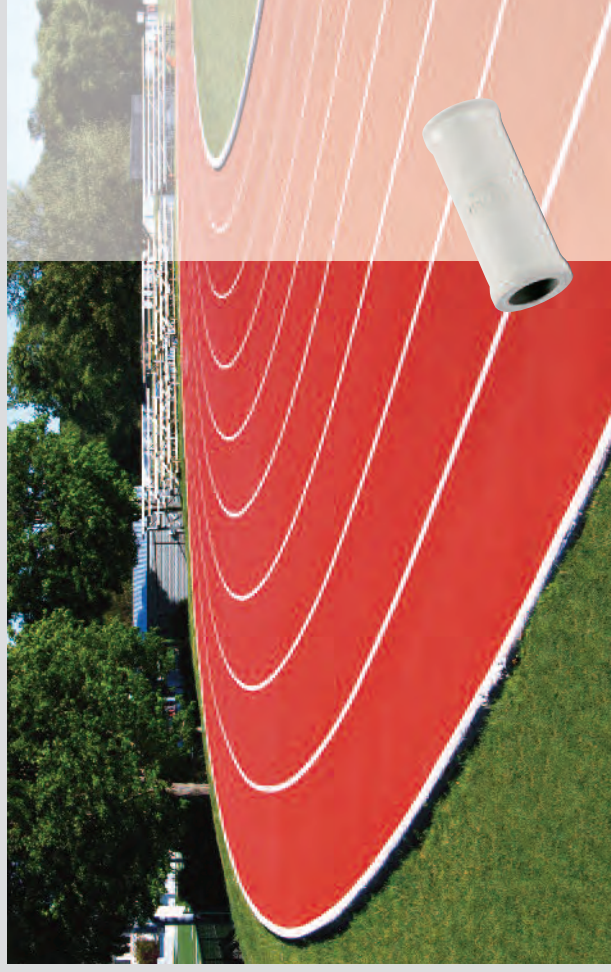

## ■ CABLE TIES



## ■ VERSIONS

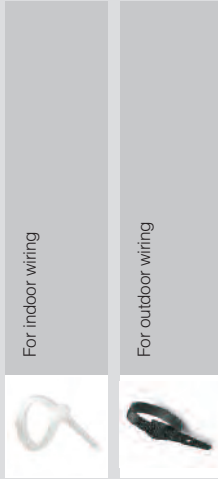

## ■ LOADING DIAGRAM

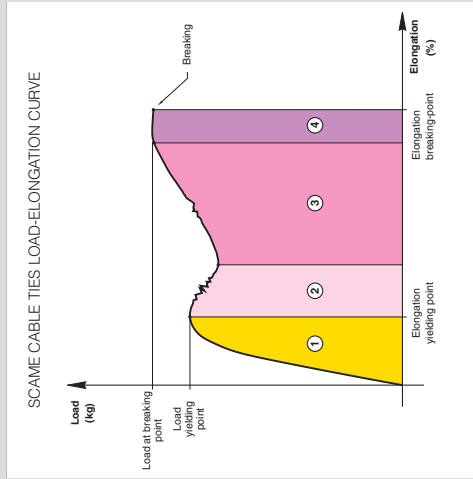

### Four areas with different characteristics can be clearly identified:

- 1) Elastic elongation (utilization area).  
The cable tie subject to traction strength undergoes elastic elongation. Once the strength stops, it goes back to the initial state without altering its physical characteristics.
- 2) Stretching of molecular bonds.  
The cable tie is subject to a load such as to undergo inter-molecular breaks. The elasticity characteristics are altered.
- 3) Permanent deformation.  
The cable tie undergoes the breaking of all intermolecular bonds.
- 4) Elongation to rupture.  
Range within which the cable tie breaks.

## ■ TECHNICAL CHARACTERISTICS

Operating ambient temperature:	-40°C +85°C for indoor wiring -45°C +85°C for outdoor wiring
Installation ambient temperature:	-10°C +60°C for indoor wiring -30°C +60°C for outdoor wiring
Glow Wire test:	650°C
Material:	PA 6.6 (Indoor wiring) Engineering plastic (outdoor wiring)
Colour:	Black Natural
IK degree at 20°C:	IK08-IK10

## ■ BEHAVIOUR WITH CHEMICAL AND ATMOSPHERIC AGENTS

Saline solution	Acids		Bases			Solvents			Mineral oil	UV rays
	Concentrated	Diluted	Concentrated	Diluted	Hexane	Benzol	Acetone	Alcohol		
Resistant	Not Resistant	Not Resistant	Limited Resistance	Resistant	Resistant	Resistant	Resistant	Resistant	Resistant	Resistant

## ■ DIMENSIONS

### Cable ties for indoor wiring

Dimensions (mm)	Grip capacity MIN ÷ MAX Ø (mm)	Tensile strength (kg)
2.2x75	1.5 ÷ 15	6
2.5x98	1.5 ÷ 18	8
2.5x135	1.5 ÷ 30	8
2.5x160	1.5 ÷ 40	8
2.5x200	1.5 ÷ 50	8
3.6x140	1.5 ÷ 35	13
3.6x200	1.5 ÷ 50	13
3.6x290	1.5 ÷ 80	13
3.6x365	1.5 ÷ 100	13
4.8x180	1.5 ÷ 45	22
4.8x200	1.5 ÷ 45	22
4.8x250	1.5 ÷ 60	22
4.8x290	1.5 ÷ 75	22
4.8x360	1.5 ÷ 100	22
4.8x130	1.5 ÷ 110	22
7.6x180	4.5 ÷ 45	55
7.6x300	4.5 ÷ 80	55
7.6x365	4.5 ÷ 100	55
9x780	4.5 ÷ 230	55

### Cable ties for outdoor wiring

Dimensions (mm)	Grip capacity MIN ÷ MAX Ø (mm)	Tensile strength (kg)
6x115	4 ÷ 25	25
6x175	10 ÷ 45	28
9x120	4 ÷ 22	48
9x180	10 ÷ 42	48
9x265	30 ÷ 60	51
9x360	30 ÷ 93	51

## ■ APPLICATION EXAMPLES







## ■ MULTI-OUTLET SOCKETS



## ■ REFERENCE STANDARDS

### CEI 23-124

Plugs and socket outlets for household and similar purposes.

*Part 2-7: particular requirements for cord extension set.*

## ■ BEHAVIOUR WITH CHEMICAL AND ATMOSPHERIC AGENTS

Saline solution	Acids		Bases		Solvents			Mineral oil	UV rays
	Concentrated	Diluted	Concentrated	Diluted	Hexane	Benzol	Acetone		
Resistant	Limited Resistance	Resistant	Limited Resistance	Limited Resistance	Resistant	Not Resistant	Not Resistant	Limited Resistance	Resistant

## ■ APPLICATION EXAMPLES



## ■ QUALITY MARKS



## ■ VERSIONS

	Without luminous switch
	With luminous switch
	With lighting protection
	With USB

## ■ TECHNICAL CHARACTERISTICS

Rated current:	16A
Rated voltage:	250V~
Frequency:	50Hz
Insulating voltage:	250V~
Protection degree:	IP20D
Operating ambient temperature according to the reference standard:	-15°C +35°C
Max. operating ambient temperature:	60°C
Glow Wire test:	750°C
Halogen free:	Yes
Material:	Engineering plastic
Colour:	Random (*) Anthracite RAL 7021 Turquoise blue (transparent)

(\*) Random colour means casual "white base – grey lid" or "grey base – white lid".

## ■ DOMESTIC CABLE REELS - ENERGY



## ■ REFERENCE STANDARDS

**EN 61242**  
Electrical accessories cable reels for household and similar purposes.

## ■ BEHAVIOUR WITH CHEMICAL AND ATMOSPHERIC AGENTS

Saline solution	Acids		Bases		Solvents			Mineral oil	UV rays
	Concentrated	Diluted	Concentrated	Diluted	Hexane	Benzol	Acetone		
Resistant	Limited Resistance	Not Resistant	Limited Resistance	Limited Resistance	Not Resistant	Not Resistant	Not Resistant	Limited Resistance	Resistant

## ■ POWER OUTPUT

Plug	Power supply		Cable		Max load (W)	
	Type	Meters	⊖	⊕	Volt (V~)	
10A	2X1	5	1200	2200	230	230
		10	110	2300	230	230
		15	110	2300	230	230
	3X1	20	110	2200	230	230
		5	1200	2300	230	230
		10	1100	2850	230	230
16A	4	1700	3200	230	230	
		1200	3200	230	230	
	5	1200	3200	230	230	
		10	1200	3200	230	230
3X1.5	15	1200	3200	230	230	
	20	1200	3200	230	230	

## ■ QUALITY MARKS



## ■ TECHNICAL CHARACTERISTICS

Rated current:	10A-16A
Rated voltage:	250V ~
Frequency:	50Hz
Insulating voltage:	250V ~
Protection degree:	IP20D
Operating ambient temperature according to the reference standard:	-5°C +40°C
Max. operating ambient temperature:	40°C
Glow Wire test:	650°C/850°C
Material:	Engineering plastic
Colour:	Petrol Blue/Orange

## ■ PRACTICAL ADVICE

- Do not use in places where there is danger of explosion or fire.
- When in use the cable should be extended on the ground or the floor avoiding wear and tear or damage (crushing caused by heavy loads or vehicles passing over the cable for example). If necessary suitable mechanical protection should be used.
- After use rewind the cable carefully back onto the reel.
- Periodically check the condition of the cable for example (there should be no signs of wear, compression or cracks) and test the phase and earth conductors for conductivity.

## ■ VERSIONS

	TRIS150 Series - Italian standard plugs
	TRIS190 Series - Italian standard plugs - French-German standard plugs
	TRIS230 Series - Italian standard plugs - French-German standard plugs

## ■ APPLICATION EXAMPLES

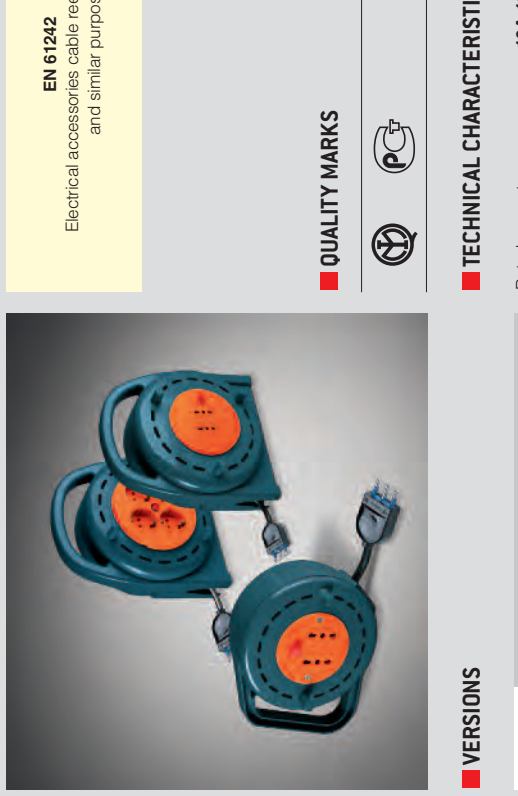





Handle and knob for rewinding the cable easily.



**Thermal overload switch:** a bimetallic device is put in close contact with the supply cable and protects it from excessive overheating resulting from the Joule effect. If activated, the device opens the circuit to the socket, interrupting the supply of electrical energy. Reactivation is only possible manually and if the temperature is below intervention threshold.

**WARNING:** The thermal overload switch is not an isolator switch, therefore maintenance operations are carried out after having disconnected the circuit. The thermal overload switch does not protect the load from overcurrents (overloading and short-circuiting).

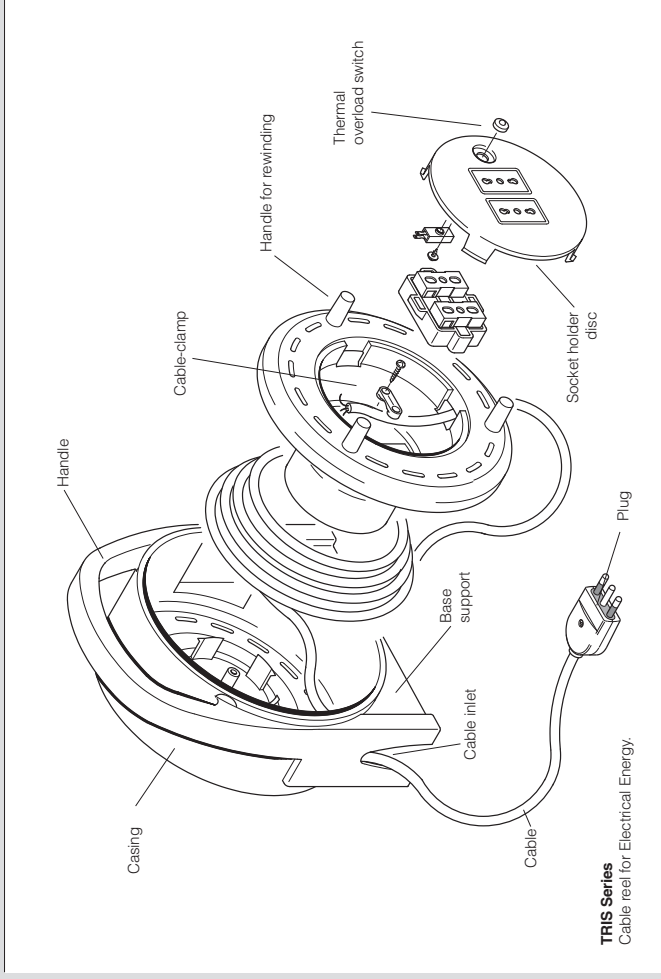

**TRIS Series**  
Cable reel for Electrical Energy.



## ■ DOMESTIC CABLE REELS - TV AND TELEPHONE



## ■ TECHNICAL CHARACTERISTICS

Operating ambient temperature:	-5°C +40°C
Glow Wire test:	650°C
Material:	Engineering plastic
Colour:	Petrol Blue/Water green Petrol Blue/Light blue

## ■ PRACTICAL ADVICE

- When in use the cable should be extended on the ground or the floor avoiding wear and tear or damage (crushing caused by heavy loads or vehicles passing over the cable for example). If necessary suitable mechanical protection should be used.
- After use rewind the cable carefully back onto the reel.
- Periodically check the condition of the cable for example (there should be no signs of wear, compression or cracks) and test the phase and earth conductors for conductivity.

## ■ VERSIONS

	TRIS130 Series - TV and telephone version
	TRIS150 Series - TV and telephone version

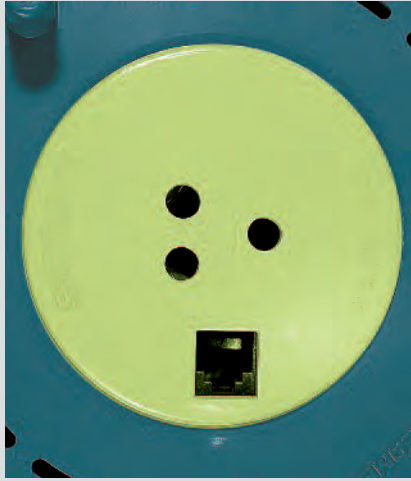

The double socket (RJ and 3 pole TELECOM Italia standard) means that 2 appliances can be connected in parallel, such as a telephone, answer machine, fax, modem. It also allows for the use of telephones with a 3 pole Telecom plug or with a RJ connector of the type 6/2 connected to two wires.



TV socket: IEC connector with a diameter of 9.5 mm for coaxial cable.

## ■ BEHAVIOUR WITH CHEMICAL AND ATMOSPHERIC AGENTS

Saline solution	Acids		Bases				Solvents				Mineral oil	UV rays
	Concentrated	Diluted	Concentrated	Diluted	Hexane	Benzol	Acetone	Alcohol				
Resistant	Limited Resistance	Not Resistant	Limited Resistance	Limited Resistance	Not Resistant	Not Resistant	Not Resistant	Limited Resistance	Limited Resistance	Limited Resistance	Resistant	

## ■ APPLICATION EXAMPLES



### CONDUIT INSTALLATION ACCESSORIES - IP40



### REFERENCE STANDARDS

- EN 61386-1**  
Conduit system for cable management.  
*Part 1: general requirements.*
- EN 61386-21**  
Conduit system for cable management.  
*Part 2: particular requirements-rigid conduit systems.*
- EN 60423**  
Conduits for electrical installation.  
External diameters of rigid.  
are flexible conduits for electrical installations.

### QUALITY MARKS



### VERSIONS

	Inspection elbow
	Flat tee inspection
	Bend with two couplings
	Conduit coupling

### TECHNICAL CHARACTERISTICS

Protection degree:	<b>IP40</b>
Operating ambient temperature according to the reference standard:	<b>-5°C +60°C</b>
Max. operating ambient temperature:	<b>60°C</b>
Glow Wire test:	<b>750°C</b>
IK degree at 20°C:	<b>IK06-IK10</b>
Material:	<b>Engineering plastic</b>
Colour:	<b>Grey RAL 7035</b>

### CONDUIT INSTALLATION ACCESSORIES - IP65



### REFERENCE STANDARD

- EN 61386-1**  
Conduit system for cable management.  
*Part 1: general requirements.*
- EN 61386-21**  
Conduit system for cable management.  
*Part 1: particular requirements-rigid conduit systems.*
- EN 60423**  
Conduits for electrical installation.  
External diameters of rigid.  
are flexible conduits for electrical installations.

### QUALITY MARKS



### VERSIONS

	Bend with two couplings
	90° flexible bend
	Conduit couplings
	Conduit to box couplings
	Flexible joint for rigid-box tube connections
	Conduit to sheath couplings
	Sheet to box couplings
	Sheet to EUREKA couplings

### TECHNICAL CHARACTERISTICS

Protection degree:	<b>IP65</b>
Operating ambient temperature according to the reference standard:	<b>-5°C +60°C</b>
Max. operating ambient temperature:	<b>60°C</b>
Glow Wire test:	<b>750°C</b>
IK degree at 20°C:	<b>IK06-IK10</b>
Material:	<b>Engineering plastic</b>
Colour:	<b>Grey RAL 7035</b>

### CABLING OPERATIONS



### BEHAVIOUR WITH CHEMICAL AND ATMOSPHERIC AGENTS

Saline solution	Acids		Bases			Solvents			Mineral oil	UV rays
	Concentrated	Diluted	Concentrated	Diluted	Hexane	Benzol	Acetone	Alcohol	Resistant	Resistant
Resistant	Resistant	Resistant	Resistant	Resistant	Limited Resistance	Limited Resistance	Resistant	Resistant	Resistant	Resistant

## ■ DOMESTIC PLUGS AND SOCKETS



## ■ REFERENCE STANDARDS

### CEI 23-50

Plugs and sockets for domestic and similar applications.  
*Part 1: general requirements.*

### IEC 60884-1

Plugs and socket-outlets for household and similar purposes.  
*Part 1: general requirements.*

## ■ QUALITY MARKS



## ■ VERSIONS



90° angled plugs.



Plugs with straight outlet.



Trailing sockets with straight outlet.

## ■ TECHNICAL CHARACTERISTICS

Rated current:	16A
Rated voltage:	250V~
Frequency:	50Hz
Insulating voltage:	250V~
Protection degree:	IP20D
Operating ambient temperature according to the reference standard:	-15°C +35°C
Max. operating ambient temperature:	60°C
Cabling capacity of the terminals:	10A: 0,75 - 1,5mm <sup>2</sup> 10A: 0,75 - 2,5mm <sup>2</sup>
Glow Wire test:	750°C
Material:	Engineering plastic
Colour:	White RAL 9010 Black RAL 9011

## ■ BEHAVIOUR WITH CHEMICAL AND ATMOSPHERIC AGENTS

Saline solution	Acids		Bases			Solvents			Mineral oil	UV rays
	Concentrated	Diluted	Concentrated	Diluted	Hexane	Benzol	Acetone	Alcohol		
Resistant	Not Resistant	Not Resistant	Limited Resistance	Resistant	Resistant	Resistant	Resistant	Resistant	Resistant	Resistant

## ■ APPLICATION EXAMPLES





## ENCLOSURE FOR WIRING ACCESSORIES



## REFERENCE STANDARDS

**EN 60670-1**  
Boxes and enclosures for electrical accessories for household and similar fixed electrical installations. Part 1: general requirements.

## QUALITY MARKS



## VERSIONS

	Surface mounting enclosure - IP40
	Surface mounting enclosure - IP55
	Flush mounting enclosure - IP55

## TECHNICAL CHARACTERISTICS

Protection degree:	<b>IP40-IP55</b>
Operating ambient temperature according to the reference standard:	<b>-5°C +35°C</b>
Max. operating ambient temperature:	<b>60°C</b>
Glow Wire test:	<b>650°C</b>
Material:	<b>Engineering plastic</b>
IK degree at 20°C:	<b>IK06</b>
Colour:	<b>Grey RAL 7035 Anthracite RAL 7021 (flush mounting version)</b>

## BEHAVIOUR WITH CHEMICAL AND ATMOSPHERIC AGENTS

Saline solution	Acids		Bases			Solvents			Mineral oil	UV rays
	Concentrated	Diluted	Concentrated	Diluted	Hexane	Benzol	Acetone	Alcohol		
Resistant	Limited Resistance	Resistant	Limited Resistance	Resistant	Not Resistant	Not Resistant	Not Resistant	Limited Resistance	Resistant	Resistant

## EXAMPLES OF INSTALLATION

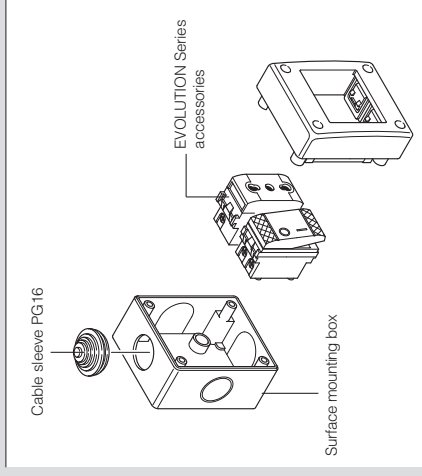

Surface mounting enclosure - IP40.

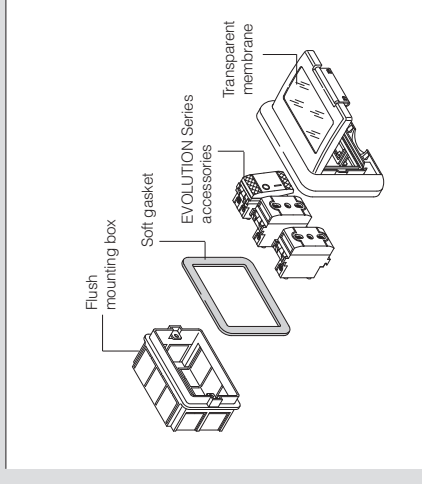

Flush mounting enclosure - IP55.

## APPLICATION EXAMPLES





## MINI-TRUNKING AND ACCESSORIES



## REFERENCE STANDARD

### EN 50085-1

Cable trunking systems and cable ducting systems for electrical installations.  
*Parte 1: general requirements.*

### EN 50085-2-1

Cable trunking systems and cable ducting systems for electrical installations.  
*Parte 2-1: cable trunking systems and cable ducting systems intended for mounting on walls and ceiling.*

## QUALITY MARKS



## VERSIONS

	Version with standard lid
	Version with enveloping lid
	Version with self adhesive bottom

## TECHNICAL CHARACTERISTICS

Protection degree:	<b>IP40</b>
Operating ambient temperature according to the reference standard:	<b>+5°C +60°C</b>
Max. operating ambient temperature:	<b>60°C</b>
Glow Wire test:	<b>650°C</b>
Material:	<b>Engineering plastic</b>
Colour:	<b>Grey RAL 7035 White RAL 9003</b>
Impact resistance according to the reference standard:	<b>1 Joule</b>

## BEHAVIOUR WITH CHEMICAL AND ATMOSPHERIC AGENTS

Saline solution	Acids		Bases			Solvents			Mineral oil	UV rays
	Concentrated	Diluted	Concentrated	Diluted	Hexane	Benzol	Acetone	Alcohol		
Resistant	Limited Resistance	Resistant	Limited Resistance	Resistant	Not Resistant	Not Resistant	Limited Resistance	Resistant	Resistant	Resistant

## APPLICATION EXAMPLES





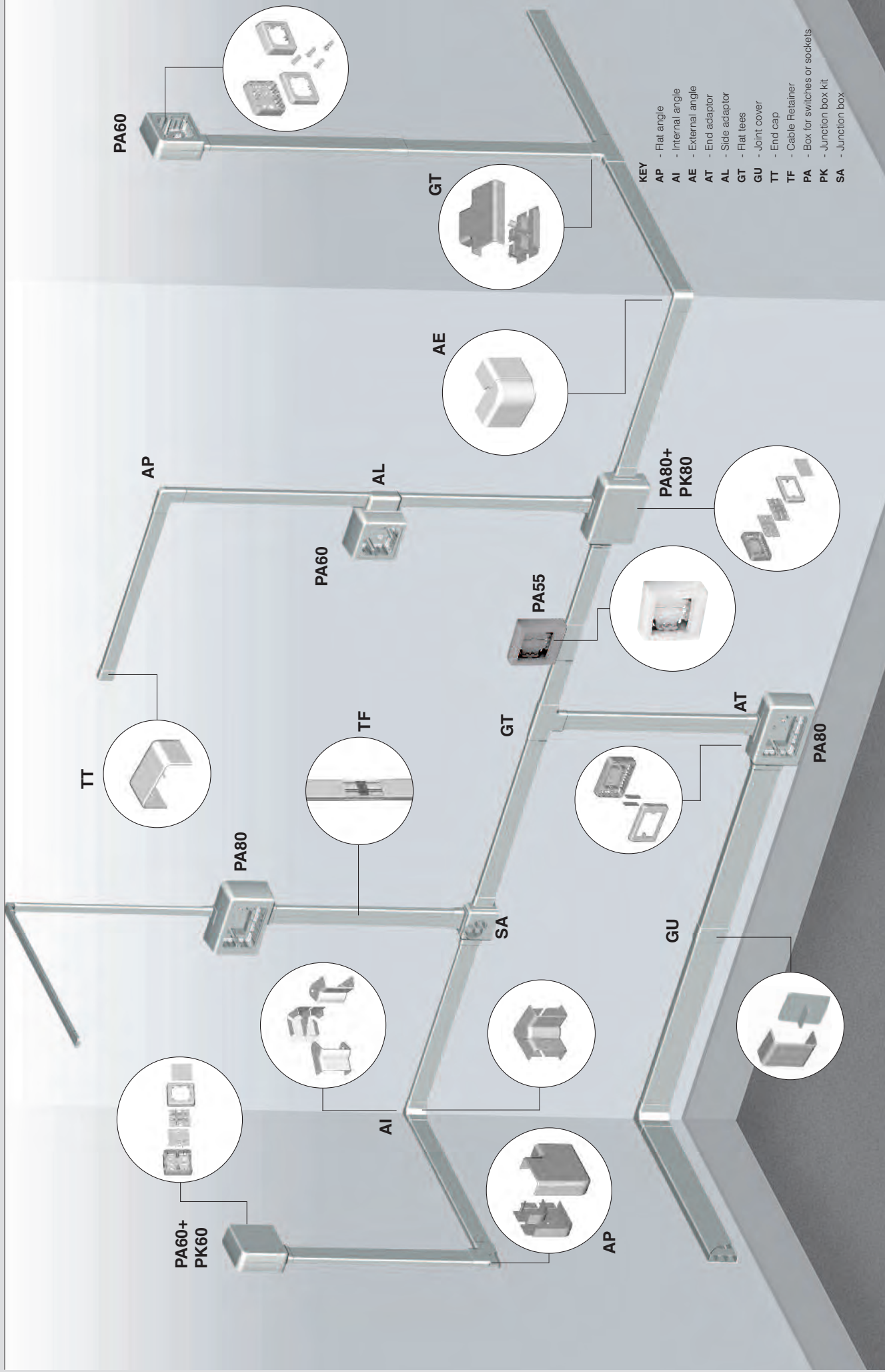

- KEY**
- AP - Flat angle
  - AI - Internal angle
  - AE - External angle
  - AT - End adaptor
  - AL - Side adaptor
  - GT - Flat tees
  - GU - Joint cover
  - TT - End cap
  - TF - Cable Retainer
  - PA - Box for switches or sockets
  - PK - Junction box kit
  - SA - Junction box







## HOW TO CHOOSE THE CORRECT WADO SERIES SCAME MINI-TRUNKING

Note: The maximum allowable number of cables complies with the specifications of IEC 64-8 standards, requiring a capacity factor equal to 50% for the compartments designed to accommodate power cables.

### STANDARD LID



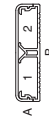
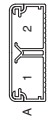



**Can be removed:** without any tool

	Size w x h (mm)	Number of compartments	A		B		Compartment section (mm <sup>2</sup> )	Total section (mm <sup>2</sup> )	CAPACITY						
			Number of compartments (mm)						Maximum allowable number of cables H07V-U/R/K Cable						
			1,5	2,5	4	6									
	20x10	1	10	20	1	129	129	5	4	3	2				
	20x15	1	15	20	1	170	170	7	5	4	3				
	30x15	1	15	30	1	288	288	12	9	7	5				
	40x10	2	10	40	2	126	252	5	3	3	2				
	40x15	2	15	40	2	173	346	8	5	4	3				
	40x20	2	20	40	2	259	518	11	8	6	5				
	60x20	3	20	60	3	254	774	11	8	6	5				

### ENVELOPING LID

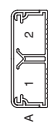
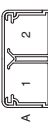

**Can be removed:** with the aid of a tool

	Size w x h (mm)	Number of compartments	A		B		Compartment section (mm <sup>2</sup> )	Total section (mm <sup>2</sup> )	CAPACITY						
			Number of compartments (mm)						Maximum allowable number of cables H07V-U/R/K Cable						
			1,5	2,5	4	6									
	20x15	1	15	20	1	160	160	8	5	4	3				
	30x15	1	15	30	1	278	278	13	9	7	5				
	40x15	2	15	40	2	168	336	7	5	4	3				
	40x20	2	20	40	2	248	496	11	8	6	5				
	60x20	2	20	60	3	242	750	12	7	6	5				

## SKIRTING TRUNKING AND ACCESSORIES



## REFERENCE STANDARDS

### EN 50085-1

Cable trunking systems and cable ducting systems for electrical installations.  
*Parte 1: general requirements.*

### EN 50085-2-1

Cable trunking systems and cable ducting systems for electrical installations.  
*Parte 2-1: cable trunking systems and cable ducting systems intended for mounting on walls and ceiling.*

## QUALITY MARKS



## VERSIONS

80mm skirting trunking

120mm skirting trunking

Floor trunking

## BEHAVIOUR WITH CHEMICAL AND ATMOSPHERIC AGENTS

Saline solution	Acids		Bases		Solvents			Mineral oil	UV rays
	Concentrated	Diluted	Concentrated	Diluted	Hexane	Benzol	Acetone		
Resistant	Limited Resistance	Resistant	Limited Resistance	Resistant	Not Resistant	Not Resistant	Limited Resistance	Resistant	Resistant

## TRUNKING SECTIONS (mm<sup>2</sup>)

	1	2	3	4	5
80-mm skirting trunking 	Trunking sections mm <sup>2</sup>	274	300	274	
	1.5mm <sup>2</sup>	13	14	13	
	2.5mm <sup>2</sup>	9	10	9	
	4mm <sup>2</sup>	7	8	7	
120-mm skirting trunking 	Trunking sections mm <sup>2</sup>	327	391	409	391
	1.5mm <sup>2</sup>	14	18	18	14
	2.5mm <sup>2</sup>	10	12	12	10
	4mm <sup>2</sup>	8	9	9	8
Floor trunking 	Trunking sections mm <sup>2</sup>	152	194	152	
	1.5mm <sup>2</sup>	7	8	7	
	2.5mm <sup>2</sup>	5	5	5	
	4mm <sup>2</sup>	4	4	4	

## APPLICATION EXAMPLES



## SKIRTING TRUNKING AND ACCESSORIES

### EN 50085-1

Cable trunking systems and cable ducting systems for electrical installations.  
*Parte 1: general requirements.*

### EN 50085-2-1

Cable trunking systems and cable ducting systems for electrical installations.  
*Parte 2-1: cable trunking systems and cable ducting systems intended for mounting on walls and ceiling.*

## QUALITY MARKS



## TECHNICAL CHARACTERISTICS

Protection degree: **IP40**

Operating ambient temperature according to the reference standard: **+5°C +60°C**

Max. operating ambient temperature: **60°C**

Glow Wire test: **650°C**

Material: **Engineering plastic**

Colour: **Grey RAL 7035**

**White RAL 9003**

**Anthracite**

**Brown**

Impact resistance according to the reference standard: **1 Joule**

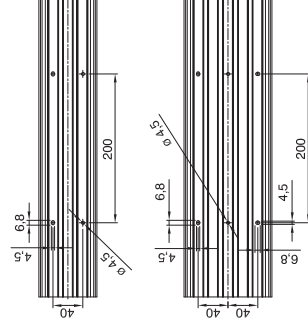

The trunking back is provided with  $\varnothing$  4.5-mm holes and 6.8x4.5-mm slots with 40-mm distance between centres and 200-mm pitch.

# WADO Series - Skirting trunking

## ■ SKIRTING, FLOOR TRUNKING AND ACCESSORIES

### 80MM VERSION

Offering excellent aesthetic and functional integration with skirting version: 120 mm and with mini-trunking by Scame, WADO Series.

- KEY**
- AP - Flat angle
  - AI - Variable internal angle
  - AE - Variable external angle
  - CC - Closing cap
  - GT - Flat tees
  - GU - Joint cover
  - GM - Flat tees for mini-trunking
  - GT - Flat tees
  - GS - Floor trunking joint
  - TT - End cap
  - TF - Cable retainer
  - TM - Wall passage terminal
  - PA - Box for switches or sockets
  - PB - Box for switches or sockets
  - SA - Junction box
  - AT - End adaptor (mini-trunking)

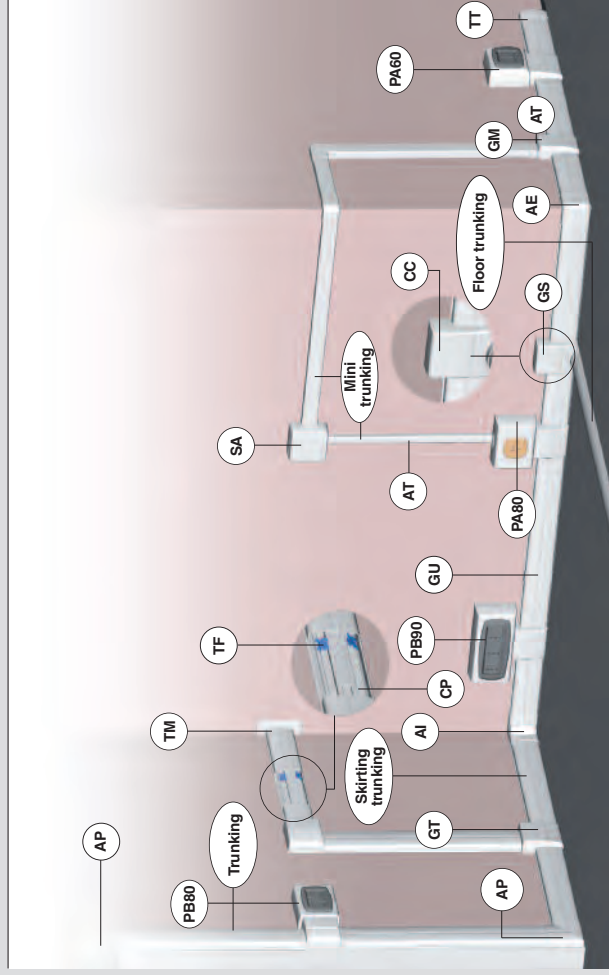

### 120mm VERSION

Offering excellent aesthetic and functional integration with skirting version: 120 mm and with mini-trunking by Scame, WADO series.

- KEY**
- AP - Flat angle
  - AI - Variable internal angle
  - AE - Variable external angle
  - CC - Closing cap
  - GT - Flat tees
  - GU - Joint cover
  - GM - Flat tees for mini-trunking
  - GT - Flat tees
  - GS - Floor trunking joint
  - TT - End cap
  - TF - Cable retainer
  - TM - Wall passage terminal
  - PA - Box for switches or sockets
  - PB - Box for switches or sockets
  - AT - End adaptor (mini-trunking)

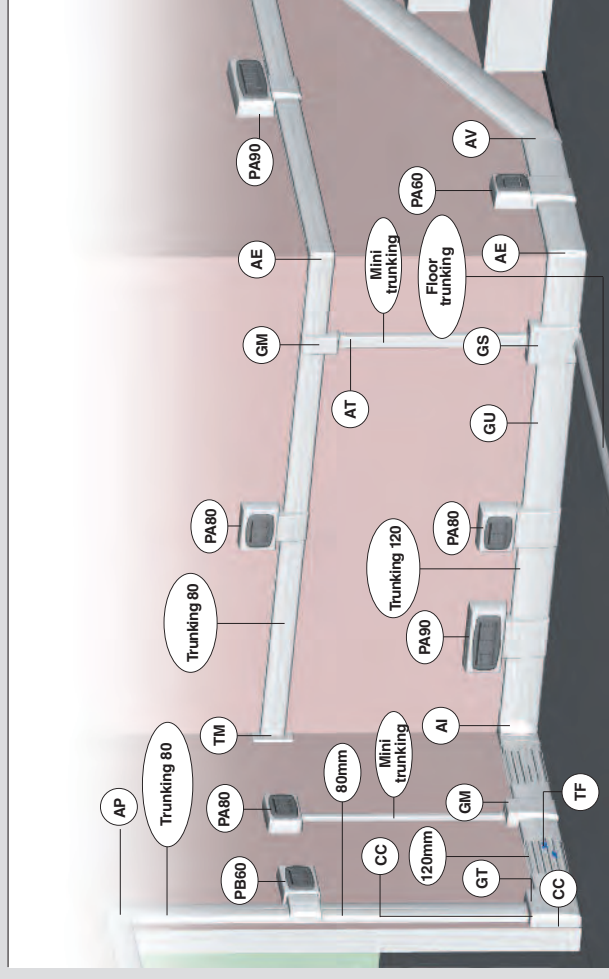

## ■ CABLE AND SET HOUSING TRUNKING



## ■ VERSIONS



Cable trunking



Cable and set housing trunking

## ■ REFERENCE STANDARD

### CEI 23-32

Trunking insulating plastic material and related accessories for cable trunking and carrying electrical appliances, for ceiling and wall-mounting.

## ■ QUALITY MARKS



## ■ TECHNICAL CHARACTERISTICS

Protection degree:	IP40
Operating ambient temperature according to the reference standard:	-25°C +60°C
Max. operating ambient temperature:	60°C
Glow Wire test:	960°C
Material:	Engineering plastic
Colour:	White RAL 9016
Impact resistance according to the reference standard:	6 Joule

## ■ BEHAVIOUR WITH CHEMICAL AND ATMOSPHERIC AGENTS

Saline solution	Acids		Bases		Solvents			Mineral oil	UV rays
	Concentrated	Diluted	Concentrated	Diluted	Hexane	Benzol	Acetone		
Resistant	Limited Resistance	Resistant	Limited Resistance	Resistant	Not Resistant	Not Resistant	Limited Resistance	Resistant	Resistant

## ■ TRUNKING SECTIONS AND NUMBER OF CABLES TO INSTALL

Type of trunking A	Type of trunking B	Trunking geometry separating cm²	SEZ.						
			1,5mm²	2,5mm²	4mm²	6mm²	10mm²	16mm²	25mm²
40	40	14,2	74	51	39	23	16	12	7
60	40	20,4	105	74	56	33	23	17	11
60	60	32	166	115	88	51	35	26	17
80	60	42,4	220	153	117	68	47	35	22
100	60	53,6	279	194	148	86	59	44	28
150	60	79,5	413	287	220	128	88	65	42
100	80	72,8	379	263	201	117	80	60	38
150	80	108,8	566	393	301	175	120	89	57
200	80	149,7	738	526	403	234	161	120	77

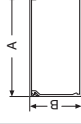

## ■ WORKING GEOMETRIC SECTION OF TRUNKING IN cm² WITH INSTALLED SWITCH HOLDERS

Type of trunking A	Trunking section B	Holder centre distance cm²	Holder centre distance 83,5cm²	Jack holder 60cm²	Socket, holder cm²	cm²
80	60	42,6	8	7	0,3	-
100	60	53,6	19	18	11	-
120	60	62,9	28	27	21	-
150	60	79,5	45	44	37	-
100	80	72,8	38	37	31	-
150	80	108,8	74	73	66	27
200	80	149,7	111	110	103	64



# WADO Series - Slotted cable trunking

## ■ SLOTTED CABLE TRUNKING



## ■ VERSIONS



Slotted cable trunking  
- standard pitch  
- short pitch

## ■ REFERENCE STANDARDS

### EN 50085-1

Cable trunking systems and cable ducting systems for electrical installations.  
*Part 1: general requirements.*

### EN 50085-2-3

Cable trunking systems and cable ducting systems for electrical installations.  
*Part 2-3: particular requirements for slotted cable trunking systems intended for installation in cabinets.*

## ■ QUALITY MARKS



## ■ TECHNICAL CHARACTERISTICS

Operating ambient temperature according to the reference standard: **-5°C +60°C**

Max. operating ambient temperature: **60°C**

Glow Wire test:

Material: **Engineering plastic**

Colour: **Grey RAL 7030**

Impact resistance according to the reference standard: **1 Joule**

## ■ BEHAVIOUR WITH CHEMICAL AND ATMOSPHERIC AGENTS

Saline solution	Acids		Bases		Solvents			Mineral oil	UV rays
	Concentrated	Diluted	Concentrated	Diluted	Hexane	Benzol	Acetone		
Resistant	Limited Resistance	Resistant	Limited Resistance	Resistant	Not Resistant	Not Resistant	Limited Resistance	Resistant	Resistant

## ■ APPLICATION EXAMPLES



# WADO Series - Trunking for air conditioning systems

## TRUNKING FOR AIR CONDITIONING SYSTEMS



### VERSIONS

	Dimension: 60x45mm
	Dimension: 80x60mm
	Dimension: 110x75mm

## TECHNICAL CHARACTERISTICS

Operating ambient temperature according to the reference standard: **-25°C +60°C**

Material:	Engineering plastic
Colour:	White RAL 9001

## TECHNICAL CHARACTERISTICS OF THE MATERIAL

Resistance to tensile stress:	40N/mm <sup>2</sup>
Resistance to breaking:	38N/mm <sup>2</sup>
Elongation to pulling stress:	109%
Elastic module:	2810N/mm <sup>2</sup>
Resistance to impacts 23°C c.i.:	745/m
Vic at softening temperature 50N (thermal increment 50°C/h):	81°C
Inflammability on 1,36 mm thickness (flame is not propagated):	UL 94 V-0

## BEHAVIOUR WITH CHEMICAL AND ATMOSPHERIC AGENTS

Saline solution	Acids		Bases			Solvents			Mineral oil	UV rays
	Concentrated	Diluted	Concentrated	Diluted	Hexane	Benzol	Acetone	Alcohol		
Resistant	Limited Resistance	Resistant	Limited Resistance	Resistant	Not Resistant	Not Resistant	Limited Resistance	Resistant	Resistant	Resistant

## FIXING HOLES

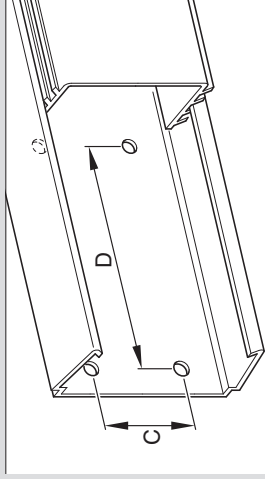

## METHOD OF INSTALLATION

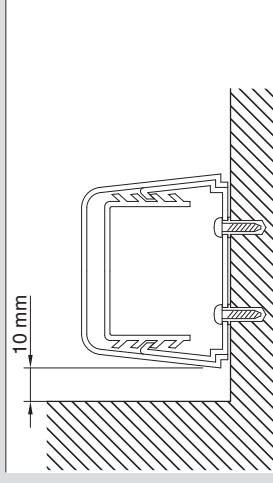

Code	C	D
871.060	35	200
871.080	50	200
871.110	80	200

The trunking base is pre-drilled at 600mm centres for wall fixing. The bracket has to be installed just on blocks. The bend and wall passage are ready for fixing by blocks.

## APPLICATION EXAMPLES



## FLUSH MOUNTING BOXES





## REFERENCE STANDARDS

**EN 60670-1**  
Boxes and enclosure for electrical accessories for household and similar fixed electrical installation.  
*Part 1: general requirements.*

## QUALITY MARKS



## VERSIONS

	Round flush mounting box
	Rectangular flush mounting box
	Flush junction box

## TECHNICAL CHARACTERISTICS

Protection degree:	<b>IP40</b>
Operating ambient temperature according to the reference standard:	<b>-25°C +60°C</b>
Max. operating ambient temperature:	<b>60°C</b>
Glow Wire test:	<b>650°C</b>
Material:	<b>Engineering plastic</b>
Halogen free:	<b>Yes</b>
DIN rail fixing:	<b>Yes</b>
IK degree at 20°C:	<b>IK04 - IK07 (cover)</b>

## BEHAVIOUR WITH CHEMICAL AND ATMOSPHERIC AGENTS

Saline solution	Acids		Bases			Solvents			Mineral oil	UV rays
	Concentrated	Diluted	Concentrated	Diluted	Hexane	Benzol	Acetone	Alcohol		
Resistant	Not Resistant	Not Resistant	Limited Resistance	Resistant	Not Resistant	Not Resistant	Not Resistant	Limited Resistance	Resistant	Resistant

## FLUSH MOUNTING INSTALLATION

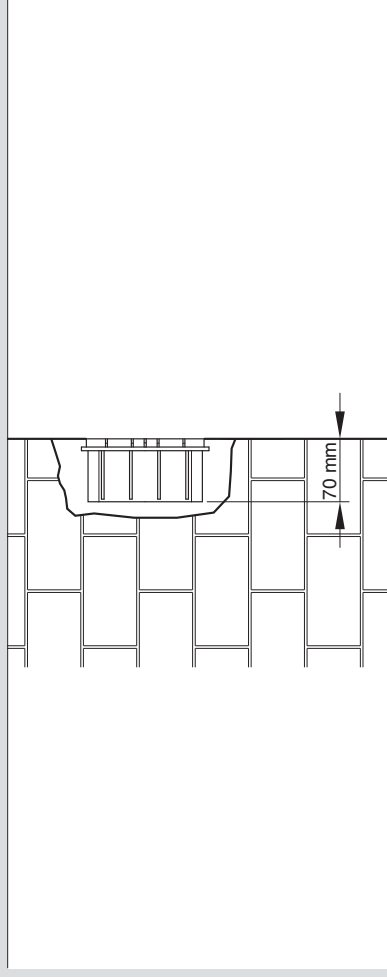

## APPLICATION EXAMPLES





## INDUSTRIAL PLUGS AND SOCKETS



## REFERENCE STANDARDS

### EN 60309-1

Plugs, socket-outlets and couples for industrial purposes.  
*Part 1: general requirements.*



### EN 60309-2

Plugs, socket-outlets and couples for industrial purposes.  
*Part 2: dimensional interchangeability requirements for pin and contact-tube accessories.*

## QUALITY MARKS



## VERSIONS

Plugs	Connectors
	

## TECHNICAL CHARACTERISTICS

Rated current:	16A-32A
Rated voltage:	110-130V 200-250V 380-415V
Frequency:	50/60Hz
Insulation voltage:	500V
Protection degree:	IP44
Operating ambient temperature according to the reference standard:	-25°C +40°C
Glow wire test:	850°C contacts carrier 650°C handle
IK degree:	IK08
Material:	Engineering plastic

## WIRING AND INSTALLATION

Wiring capacity of the terminals  
Cross-section of connectable conductors (mm<sup>2</sup>)

Rated voltage	Rated current (A)	Plugs and connectors		Sockets outlet	
		Min	Max	Min	Max
>50V	16A	1,5	2,5	1,5	4
	32A	2,5	6	2,5	10

## Max. cable size accepted by the cable clamp

Rated current (A)	Outside Ø mm	
	Min	Max
16A	8	15
32A	11,5	21

## BEHAVIOUR WITH CHEMICAL AND ATMOSPHERIC AGENTS

Saline solution	Acids		Bases			Solvents			Mineral oil	UV rays
	Concentrated	Diluted	Concentrated	Diluted	Hexane	Benzol	Acetone	Alcohol		
Resistant	Not Resistant	Limited Resistance	Limited Resistance	Resistant	Resistant	Resistant	Resistant	Resistant	Resistant	Resistant

## APPLICATION EXAMPLES







**GENERAL  
CATALOGUE  
2016-2018**

index by  
product number



# Index by product number

www.scame.com

For more informations, visit our website.

The screenshot shows the SCAME website interface. At the top, there is a navigation bar with links for Home, Company, Distribution, Products, INFOPORT, INTECH, and Documentation. The SCAME logo is prominently displayed. Below the navigation, a breadcrumb trail indicates the product's location: Catalogue: General Catalogue > Industry > Interlocked switch sockets outlets > OMNIA Series > Rated voltage > 50V > With fuse carrier > Surface mounting IP44/IP47 > 506.1686. The main content area features a product image of the 'INTERLOCKED SOCKET 3P+E IP67 16A 6H' and a table of technical specifications. The sidebar on the left provides a detailed product tree under the 'INDUSTRY' category, listing various series like ADVANCE-GRP, OMNIA, and OMNIAPLUS. A 'Product search' box is located at the bottom of the sidebar. The 'Standards and Laws' section on the right lists several European standards (EN 60309-1, EN 60309-2, EN 60309-1/A1, EN 60309-2/A1, EN 60309-4, EN 60309-1/A2, EN 60309-2/A2) with brief descriptions of their scope.

Master data	TechData
Minimum order: 1NR	Commercial series: OMNIA Series
Net Weight: 0.865KG	Rated current: 16A
EAN code: 800163611483	Pole: 3P+E
INTRASTAT code: 85366990	Hour position: 6h
	Rated voltage: 380-415V
	Working frequency: 50Hz
	Working frequency: 60Hz
	Colour: RED
	Synthetical description: INTERLOCKED SOCKET
	Protection degree: IP66/IP67
	Notes: CON BASE PORTAFUSIBILI





## Standard and approvals:

		IMQ - Istituto Italiano del Marchio di qualità
		CSV/IMQ - Certificato con sorveglianza
		AEE - Marca de conformidad a normas UNE
		DEMKO - Danmarks Elektriske Materiel Kontrol
		BSI - British Standard Institution
		VDE - Verband Deutscher Elektrotechniker
		ÖVE - Österreichischer Verband für Elektrotechnik
		FIMKO - Sähkötekniikan tutkimuskeskus / Elinspektion
		NEMKO - Norges Elektriske Materielkontroll
		SEMKO - Svenska Elektriska Materielkontrollanstalten
		CEBEC - Comité Electrotechnique Belge
		UTE - Union Technique de l'Electricité
		KEMA-KEUR - N.V. Tot Keuring Van Electrotechnische Materialen
		SEV - Schweizerischer Elektrotechnischer Verein
		SAA - Standard Association of Australia
		MEEI - Magyar elektrotechnikai ellenőrző intézet
		IRAM - Instituto Argentino de Normalización
		UL CLASSIFIED (USA)
		UL LISTED cUL
		GOST - Gosudarstvenno komitet Sandartov



# Index by product number

101		
Cat.numb.	Pack qty.	Page
● 101.6200	100	633
● + 101.6200.11	100	633
● + 101.6200.12	100	633
● + 101.6200.24	100	633
● 101.6201.G	100/800	626
● + 101.6203.G	100	626
● + 101.6301K.G	6/240	626
● + 101.6302.20G	12/480	626
● + 101.6302.G	12/480	626
● + 101.6303.20G	12/480	626
● 101.6303.G	12/480	626
● + 101.6304.20G	12/480	626
● + 101.6304.G	12/480	626
● 101.6311.G	12/480	626
● 101.6323.G	12/480	627
● + 101.63312.G	12/480	627
● + 101.6331T.G	6/240	627
● + 101.6332.G	12/480	627
● 101.6333.G	12/480	627
● + 101.6334.G	12/480	627
● + 101.6340.06G	12/480	627
● + 101.6340.10G	12/480	627
● + 101.6340.G	12/480	627
● + 101.6341.06G	6/240	628
● + 101.6341.10G	6/240	628
● + 101.6341.G	6/240	628
● + 101.6345.G	12/480	628
● + 101.6401.G	12/480	629
● + 101.6402.G	12/480	629
● 101.6403.G	12/480	629
● 101.6403.GD	6	630
● 101.6403.R	12/480	629
● + 101.6404.G	6/240	629
● + 101.6404.R	6/240	629
● 101.6405.G	6/240	629
● 101.6405.GD	6	630
● 101.6405.R	6/240	629
● 101.6407.G	6/240	629
● 101.6407.GD	6	630
● 101.6407.R	6/240	629
● 101.6411.G	6/240	629
● + 101.6411.GD	6	630
● 101.6412.G	6/240	629
● 101.6412.R	6/240	629
● + 101.6413.G	6/240	629
● + 101.6413.GD	6	630
● + 101.6414.G	6/240	629
● 101.6417.G	12/480	629
● + 101.6417.GD	6	630
● + 101.6421.G	12/480	630
● + 101.6421.R	12/480	630
● + 101.6423.G	12/480	630
● + 101.6424.G	6/240	630
● + 101.6424.GD	6	630
● + 101.6425.G	12/480	630
● + 101.6426.G	6/240	630
● + 101.6427.G	6/240	630
● 101.6428.G	6/240	630
● + 101.6428.GD	6	630
● + 101.6429.G	6/240	630
● + 101.6431.01G	12/480	631
● + 101.6431.10	12/480	631

101		
Cat.numb.	Pack qty.	Page
● + 101.6431.10G	12/480	631
● + 101.6431.G	12/480	631
● + 101.6432.01G	12/480	631
● + 101.6432.10G	12/480	631
● + 101.6432.G	12/480	631
● + 101.6433.G	12/480	631
● + 101.6434.G	6/240	631
● + 101.6461.64G	12/480	632
● + 101.6462.64G	12/480	632
● + 101.6464.G	12/480	632
● + 101.6466.G	12/480	0
● + 101.6481.50G	6/240	630
● 101.6481.50GD	6	630
● + 101.6481.51G	6/240	632
● 101.6481.60G	6/240	632
● 101.6481.61G	6/240	632
● + 101.6541.1G	12/480	632
● + 101.6541.2G	12/480	632
● 101.6541.2GD	6	630
● + 101.6541.3G	12/480	632
● + 101.6542.G	12/480	632

104		
Cat.numb.	Pack qty.	Page
● 104.4000	50/500	540
● 104.4000/N	50/500	540
● 104.4001	50/500	540
● 104.4001/N	50/500	540
● 104.4003	50/500	540
● 104.4003/N	50/500	540
● 104.4010	50/500	540
● 104.4010/N	50/500	540
● 104.4011	50/500	540
● 104.4011/N	50/500	540
● 104.4013	50/500	540
● 104.4013/N	50/500	540
● 104.4068	100	540
● 104.4068/N	100	540
● 104.4070	100	540
● 104.4070/N	100	540

106		
Cat.numb.	Pack qty.	Page
● 106.3000	50/500	541
● 106.3000/N	50/500	541
● 106.3001	50/500	541
● 106.3001/N	50/500	541
● 106.3003	50/500	541
● 106.3003/N	50/500	541
● 106.3010	50/500	541
● 106.3010/N	50/500	541
● 106.3011	50/500	541
● 106.3011/N	50/500	541
● 106.3013	50/500	541
● 106.3013/N	50/500	541

110		
Cat.numb.	Pack qty.	Page
● + 110.3000	20/400	542
● + 110.3010	20/400	542
● + 110.3100	10/150	542
● + 110.3150	10/150	542
● + 110.3160	10/150	542

116		
Cat.numb.	Pack qty.	Page
● 116.68	100	541
● 116.68/N	100	541
● 116.70	100	541
● 116.70/N	100	541

130		
Cat.numb.	Pack qty.	Page
● 130.2063	50/500	543
● 130.2063/N	50/500	543
● 130.2083	25/250	543
● 130.2083/N	25/250	543
● 130.2084	25/250	543
● 130.2084/N	25/250	543
● 130.2085	25/250	543
● 130.2085/N	25/250	543
● 130.83	50/500	543
● 130.83/N	50/500	543

136		
Cat.numb.	Pack qty.	Page
● + 136.001	10	625
● 136.0901	10/100	0
● 136.0902	10/100	0
● 136.0911	10/100	0
● 136.0912	10/100	0
● 136.4121	5/100	618
● 136.4122	5/100	618
● 136.4123	3/60	618
● + 136.4123-411	50	619
● 136.4123-412	50	619
● + 136.4123-413	50	619
● + 136.4123-414	50	619
● 136.4124	1/24	618
● 136.4126	1/16	618
● 136.5023	85	622
● 136.5023.AT	85	622
● 136.5121	5/80	618
● 136.5121-302	32/128	619
● 136.5121-303	32/128	619
● 136.5121-304	32/128	619
● 136.5121-323	32/128	619
● 136.5121-333	32/128	619
● + 136.5121-417	32/128	619
● 136.5122	5/80	618
● 136.5122-303	32/128	620
● 136.5122-323	32/128	620
● + 136.5122-407	32/128	620
● + 136.5122-411	32/128	620

136		
Cat.numb.	Pack qty.	Page
● 136.5122-412	32/128	620
● 136.5122-413	32/128	620
● 136.5122-414	32/128	620
● + 136.5122-427	32/128	620
● + 136.5122-429	32/128	620
● 136.5123	3/60	618
● 136.5123-303	24/96	620
● 136.5123-323	24/96	620
● + 136.5123-407	24/96	620
● + 136.5123-411	24/96	620
● 136.5123-412	24/96	620
● 136.5123-413	24/96	620
● + 136.5123-414	24/96	620
● + 136.5123-429	24/96	620
● 136.5124	1/24	618
● + 136.5124-303	1/24	621
● + 136.5124-323	1/24	621
● + 136.5124-407	24	621
● + 136.5124-411	1/24	621
● 136.5124-412	1/24	621
● + 136.5124-413	1/24	621
● 136.5126	1/16	618
● + 136.5126-303	1/16	621
● + 136.5126-323	1/16	621
● + 136.5126-407	16	621
● + 136.5126-411	1/16	621
● 136.5126-412	1/16	621
● + 136.5126-413	1/16	621
● + 136.6122	5/100	0
● + 136.6123	3/60	0
● + 136.6124	24	0
● + 136.7023	85	0
● + 136.7122	5/80	0
● + 136.7123	3/60	0
● + 136.7124	24	0

137		
Cat.numb.	Pack qty.	Page
● + 137.001	1/12	617
● + 137.002	1/12	617
● + 137.101	1/12	609
● + 137.102	1/12	609
● + 137.103	1/12	609
● + 137.104	1/12	609
● + 137.121	1/12	613
● + 137.122	1/12	613
● + 137.123	1/12	613
● + 137.124	1/12	613
● 137.125	12/120	614
● 137.131	1/12	615
● 137.141	1/12	615
● 137.151	1/12	616
● + 137.200	10/100	617
● + 137.201	10/100	617
● + 137.202	10/100	617
● + 137.3011	1/12	609
● + 137.3012	1/12	609
● + 137.3021	1/12	609
● + 137.3022	1/12	609
● 137.3111	1/12	609



137		
Cat.numb.	Pack qty.	Page
● 137.3112	1/2	609
● + 137.3211	1/2	609
● + 137.3212	1/2	609
● + 137.3221	1/2	609
● + 137.3222	1/2	609
● + 137.3311B	1/2	609
● + 137.3311P	1/2	609
● 137.3312P	1/2	609
● 137.3321	1/2	609
✓ 137.3410	1/2	610
● + 137.3462	1/2	609
● + 137.4001	1/2	612
● + 137.4002	1/2	612
● + 137.4003	1/2	612
● + 137.4022	1/2	612
● + 137.4042	1/2	612
● 137.4043	1/2	612
● + 137.4111	1/2	612
● + 137.4403	1/2	611
● + 137.4404	1/2	611
● + 137.4407	1/2	611
● + 137.4411	1/2	611
● + 137.4412	1/2	611
● 137.4417	1/2	611
● 137.4421	1/2	611
● + 137.4424	1/2	611
● + 137.4427	1/2	611
● + 137.4481.50	1/2	611
● + 137.5011	1/2	606
● + 137.5012	1/2	606
● + 137.5021	1/2	606
● + 137.5022	1/2	606
● 137.5111	1/2	606
● 137.5112	1/2	606
● + 137.5211	1/2	606
● + 137.5212	1/2	606
● + 137.5221	1/2	606
● + 137.5222	1/2	606
● + 137.5311B	1/2	606
● + 137.5311P	1/2	606
● 137.5312P	1/2	606
● 137.5321	1/2	606
✓ 137.5410	1/2	606
● + 137.5462	1/2	606
● + 137.6001	1/2	608
● + 137.6002	1/2	608
● + 137.6003	1/2	608
● + 137.6022	1/2	608
● + 137.6042	1/2	608
● 137.6043	1/2	608
● + 137.6111	1/2	608
● + 137.6403	1/2	607
● + 137.6404	1/2	607
● + 137.6407	1/2	607
● + 137.6411	1/2	607
● + 137.6412	1/2	607
● 137.6417	1/2	607
● 137.6421	1/2	607
● + 137.6424	1/2	607
● + 137.6427	1/2	607
● + 137.6481.50	1/2	607

144		
Cat.numb.	Pack qty.	Page
● 144.441	50	546
● 144.441/N	50	546
● 144.450	25/250	546
● 144.450/N	25/250	546
● 144.451	50	546
● 144.451/N	50	546
● 144.455	50	546
● 144.455/N	50	546
● 144.457	25	547
● 144.457/N	25	547
● 144.459	25	547
● 144.459/N	25	547
● ✓ 144.470	25	547
● ✓ 144.470/N	25	547

146		
Cat.numb.	Pack qty.	Page
● 146.351	50/500	549
● + 146.351/N	50/500	549
● 146.360	12/48	553
● 146.361	50	549
● 146.361/N	50	549
● + 146.500	25/250	552
● + 146.501	25/250	552
● 146.510	10	552
● 146.510/N	10	552
● 146.511	10	552
● 146.511/N	10	552
● 146.530	25/250	551
● + 146.530/N	25/250	551
● 146.534	25/250	551
● + 146.534/N	25/250	551
● 146.550/3	25/250	550
● 146.550/3-N	25/250	550
● 146.555/3	50	550
● 146.555/3-N	50	550
● 146.557	25	550
● 146.557/N	25	550
● 146.559	25	550
● 146.559/N	25	550
● 146.560	25	551
● 146.560/N	25	551
● 146.561	25	551
● 146.561/N	25	551
● ✓ 146.570	25	550
● ✓ 146.570/N	25	550
● 146.641	50	548
● 146.641/N	50	548
● 146.651	50	548
● 146.651/N	50	548
● 146.661	50	548
● 146.661/N	50	548

160		
Cat.numb.	Pack qty.	Page
160.001	10/100	566
● + 160.219	10/100	565
● 160.219/C	10	563

160		
Cat.numb.	Pack qty.	Page
● + 160.219/C-F	10	563
● 160.219/C-N	10	563
● + 160.219/C-T	10	563
● + 160.219/F	10/100	565
● + 160.219/N	10/100	565
● + 160.219/T	10/100	565
● 160.220	10/100	565
● 160.220/C	10	563
● + 160.220/C-F	10	563
● 160.220/C-N	10	563
● + 160.220/C-T	10	563
● + 160.220/F	10/100	565
● 160.220/N	10/100	565
● + 160.220/T	10/100	565
● 160.223	10/100	565
● 160.223/C	10	563
● + 160.223/C-F	10	563
● 160.223/C-N	10	563
● + 160.223/C-T	10	563
● + 160.223/F	10/100	565
● 160.223/N	10/100	565
● + 160.223/T	10/100	565
● 160.224	10/120	565
● 160.224/C	10	563
● + 160.224/C-F	10	563
● 160.224/C-N	10	563
● + 160.224/C-T	10	563
● + 160.224/F	10/120	565
● 160.224/N	10/120	565
● + 160.224/T	10/120	565
● 160.225	10/120	565
● 160.225/C	10	563
● + 160.225/C-F	10	563
● 160.225/C-N	10	563
● + 160.225/C-T	10	563
● + 160.225/F	10/120	565
● 160.225/N	10/120	565
● + 160.225/T	10/120	565
● 160.229	10/100	562
● 160.229/C	10	561
● 160.229/C-F	10	561
● 160.229/C-N	10	561
● 160.229/C-T	10	561
● + 160.229/F	10/100	562
● + 160.229/N	10/100	562
● + 160.229/T	10/100	562
● 160.230	10/40	562
● 160.230/C	10	561
● 160.230/C-F	10	561
● 160.230/C-N	10	561
● 160.230/C-T	10	561
● 160.230/D	10	561
● + 160.230/D-N	10	561
● 160.230/F	10/40	562
● 160.230/N	10/40	562
● 160.230/T	10/40	562
● 160.231	10/40	565
● 160.231/C	10	563
● + 160.231/C-F	10	563
● 160.231/C-N	10	563
● + 160.231/C-T	10	563
● + 160.231/F	10/40	565

160		
Cat.numb.	Pack qty.	Page
● 160.231/N	10/40	565
● + 160.231/T	10/40	565
● 160.232/C	10	560
● + 160.232/C-F	10	560
● 160.232/C-T	10	560
● 160.233/C	10	560
● + 160.233/C-F	10	560
● + 160.233/C-T	10	560
● + 160.233/D	10	560
● + 160.237/C	10	560
● + 160.237/C-F	10	560
● + 160.237/C-T	10	560
● + 160.238	10/50	565
● + 160.238/C	10	563
● + 160.238/C-F	10	563
● + 160.238/C-N	10	563
● + 160.238/C-T	10	563
● + 160.238/D	10	564
● + 160.238/D-F	10	564
● + 160.238/D-N	10	564
● + 160.238/D-T	10	564
● + 160.238/F	10/50	565
● 160.238/N	10/50	565
● + 160.238/T	10/50	565
● + 160.239	10/50	562
● 160.239/C	10	561
● + 160.239/C-F	10	561
● + 160.239/C-N	10	561
● + 160.239/C-T	10	561
● + 160.239/D	10	561
● + 160.239/D-F	10	561
● + 160.239/D-N	10	561
● + 160.239/D-T	10	561
● + 160.239/F	10/50	562
● + 160.239/N	10/50	562
● + 160.239/T	10/50	562
● + 160.240/C	10	560
● + 160.240/C-F	10	560
● + 160.240/C-T	10	560
● + 160.240/D	10	560
● + 160.240/D-F	10	560
● + 160.240/D-T	10	560
● 160.241	10/50	565
● 160.241/C	10	564
● + 160.241/C-F	10	564
● + 160.241/C-N	10	564
● + 160.241/C-T	10	564
● + 160.241/F	10/50	565
● + 160.241/N	10/50	565
● + 160.241/T	10/50	565
● + 160.242	10/50	562
● + 160.242/C	10	561
● + 160.242/C-F	10	561
● + 160.242/C-N	10	561
● + 160.242/C-T	10	561
● + 160.242/F	10/50	562
● + 160.242/N	10/50	562
● + 160.242/T	10/50	562
● + 160.243/D	10	560
● + 160.243/D-F	10	560
● + 160.243/D-T	10	560
● + 160.247	10/50	565



## Index by product number

160		
Cat.numb.	Pack qty.	Page
● + 160.247/C	10	564
● + 160.247/C-F	10	564
● + 160.247/C-N	10	564
● + 160.247/C-T	10	564
● + 160.247/F	10/50	565
● + 160.247/N	10/50	565
● + 160.247/T	10/50	565
● + 160.248	10/50	562
● + 160.248/C	10	561
● + 160.248/C-F	10	561
● + 160.248/C-N	10	561
● + 160.248/C-T	10	561
● + 160.248/F	10/50	562
● + 160.248/N	10/50	562
● + 160.248/T	10/50	562
● + 160.249/C	10	560
● + 160.249/C-F	10	560
● + 160.249/C-T	10	560
● 160.250/C	10	561
● 160.250/C-N	10	561
● 160.5013	6/24	566
● 160.5014	6/24	566

161		
Cat.numb.	Pack qty.	Page
● + 161.246/C-F	10	567
● + 161.246/C-T	10	567
● 161.40500.F	10	570
● 161.40500.N	10	570
● 161.40500.R	10	570
● 161.40500.T	10	570
● 161.40501.F	10	568
● 161.40501.N	10	568
● 161.40501.R	10	568
● 161.40501.T	10	568
● 161.40510.F	10	569
● 161.40510.N	10	569
● 161.40510.R	10	569
● 161.40510.T	10	569
● 161.40511.F	10	567
● 161.40511.N	10	567
● 161.40511.R	10	567
● 161.40511.T	10	567
● ✓ 161.60500.N	10	570
● ✓ 161.60500.R	10	570
● ✓ 161.60501.N	10	568
● ✓ 161.60501.R	10	568
● ✓ 161.60510.N	10	569
● ✓ 161.60510.R	10	569
● ✓ 161.60511.N	10	567
● ✓ 161.60511.R	10	567

165		
Cat.numb.	Pack qty.	Page
● 165.10401.N	10	556
● 165.10401.R	10	556
● 165.20401.N	10	556
● 165.20401.R	10	556

165		
Cat.numb.	Pack qty.	Page
● 165.20411.N	10	556
● 165.20411.R	10	556
● 165.20421.T	10	558
● 165.20431.N	10	559
● 165.20431.ND	10	559
● 165.20431.R	10	559
● 165.20431.RD	10	559
● ✓ 165.20441.N	10	557
● ✓ 165.20441.R	10	557
● 165.30401.N	10	556
● 165.30401.R	10	556
● 165.30411.N	10	556
● 165.30411.R	10	556
● 165.30421.T	10	558
● 165.40411.N	10	556
● 165.40411.R	10	556

168		
Cat.numb.	Pack qty.	Page
● 168.0072B-03	10	571
● 168.0072N-03	10	571
● 168.0073B-03	10	571
● 168.0073B-05	10	571
● + 168.0073N-03	10	571
● 168.0073N-05	10	571
● + 168.4272B-03	10	571
● + 168.4272N-03	10	571
● + 168.4273B-03	10	571
● + 168.4273B-05	10	571
● + 168.4273N-03	10	571
● + 168.4273N-05	10	571

180		
Cat.numb.	Pack qty.	Page
180.4520	10/100	600
180.4521	100/1600	600
180.4700	10/100	600
180.4701	100/1600	600
180.5510	50	599
180.5511	50	599
180.5520	50	599
180.5521	50	599
180.561	50/500	601
180.563	10/50	601
180.5640	10/100	600
180.5641	10/100	600
180.58/CEI	200/2000	601
✓ 180.5902	60	602
✓ 180.5902/N	60	602
✓ 180.5912	60	602
✓ 180.5913	50	602
✓ 180.5915	35	602
180.60/CEI	200/2000	601
180.60/CEI-P	200/2000	601
180.60/CEI-S	200/2000	601
● 180.690	12/72	594
● 180.691	12/72	594
● 180.692	12/72	357

180		
Cat.numb.	Pack qty.	Page
180.701	12/60	592
180.702	12/60	592
180.705	12/60	592
180.706	12/60	592
180.723	12/60	594
180.724	12/60	594
180.725	12/60	594
180.726	12/60	594
● + 180.727	12/60	594
180.728	12/60	594
180.729	12/60	594
180.741	12/60	594
180.742	12/60	594
180.743	12/60	594
180.744	12/60	594
180.745	12/60	594
180.746	12/60	594
180.790	100/1000	592
180.791	100/1000	592
180.792	100/1000	592
180.793	100/1000	592
180.794	12/60	593
180.795	12/60	593
✓ 180.7951	60	593
180.796	12/60	593
180.797	1/10	593
180.7971	10	593
180.798	10	593
180.799	12/60	593
180.800	100/1000	596
180.810	100/1000	596
180.811	100/1000	596
180.812	100/1000	596
180.813	100/1000	596
180.814	100/1000	596
180.815	100/1000	596
180.820	25/100	597
180.821	25/100	597
180.822	25/100	597
180.823	25/100	597
180.830	10/100	596
● + 180.831	10/100	596
● + 180.832	10/100	596
● + 180.833	10/100	596
180.840	50/1000	597
● + 180.841	12/60	597
180.842	12/60	597
● + 180.843	12/60	597
180.844	12/60	597
● + 180.846	12/60	597
180.850	12/60	598
● + 180.851	12/60	598
180.852	12/60	598
180.853	12/60	598
180.854	12/60	598
180.855	12/60	598
180.856	12/60	598
180.857	12/60	598
180.910	100/1000	595
● + 180.911	100/1000	595
180.920	100/800	595
180.921	100/800	595

180		
Cat.numb.	Pack qty.	Page
180.930	100/1000	595
180.931	100/1000	595
180.940	100/1000	595
180.950	100/500	598
180.960	100/500	598
● + 180.970	100/1000	595

190		
Cat.numb.	Pack qty.	Page
● 190.100	1/10	585
● 190.147B	50/500	583
● 190.2000FCG	100/600	582
● 190.2000FCGB	100/600	582
● 190.2000FCN	100/600	582
● 190.2000FCNB	100/600	582
● 190.2000FG	100/600	582
● 190.2000FGB	100/600	582
● + 190.2000FGO	100/600	582
● 190.2000FN	100/600	582
● 190.2000FNB	100/600	582
● 190.2000LG	100/600	581
● 190.2000LGB	100/600	581
● 190.2000LN	100/600	581
● 190.2000LNB	100/600	581
● + 190.2000LT	100/600	581
● + 190.2000LTB	100/600	581
● 190.31	50/500	583
● 190.31B	50/500	583
● + 190.31Z	50/500	583
● + 190.3570ES	50/500	580
● 190.3570S	50/500	580
● 190.3585ES	50/500	580
● 190.3585S	50/500	580
● + 190.363B	50/500	589
● + 190.363N	50/500	589
190.366B	50	589
190.366N	50	589
190.376B	50/250	589
190.376N	50/250	589
● + 190.378	500	589
● + 190.5501/15TB	100	585
● 190.5740B1	10	584
● + 190.5778/304T	20/200	583
● + 190.5778/306L	20/200	583
● 190.5778/311T	20/200	583
● 190.5778/313T	20/200	583
● + 190.5778/348	20/200	583
● + 190.5778B	20/200	583
● 190.6000FCG	50/300	582
● 190.6000FCGB	50/300	582
● 190.6000FCN	50/300	582
● + 190.6000FCNB	50/300	582
● + 190.6000FCT	50/300	582
● + 190.6000FCTB	50/300	582
● 190.6000FG	50/300	582
● 190.6000FGB	50/300	582
● + 190.6000FGO	50/300	582
● 190.6000FN	50/300	582
● 190.6000FNB	50/300	582
● + 190.6000FT	50/300	582

190		
Cat.num.	Pack qty.	Page
● + 190.6000FTB	50/300	582
● 190.6000LG	50/300	581
● 190.6000LGB	50/300	581
● 190.6000LN	50/300	581
● 190.6000LNB	50/300	581
● + 190.6000LT	50/300	581
● + 190.6000LTB	50/300	581
● 190.71	50/500	583
● 190.71B	50/500	583
● + 190.7350Z	50/300	582
● 190.73B	50/500	583
● 190.73N	50/500	583
● + 190.73Z	50/500	583
● 190.74B	50/500	583
● 190.74N	50/500	583
● 190.81	50/500	584
● 190.8200	50/300	584
● 190.8200T	50/300	584
● 190.CP70A	50/300	580
● 190.CP70B	50/300	580
● 190.CP85A	50/300	580
● 190.CP85B	50/300	580

191		
Cat.num.	Pack qty.	Page
● 191.5031	100/1000	585
● 191.5122	20/200	586
● 191.5124	50/500	586

195		
Cat.num.	Pack qty.	Page
● 195.115B	100/1000	587
● + 195.135B	3000	587
● 195.200B	20/200	587
● 195.450B	20/200	588
● 195.450N	20/200	588
● 195.450P	20/200	588
● 195.565B	20/160	588
● 195.565N	20/160	588
● 195.565P	20/160	588

213		
Cat.num.	Pack qty.	Page
● 213.1630	10/50	22
● + 213.1630.TR	10/50	25
● 213.1630P	10/50	23
● + 213.1630P.TR	10/50	25
● 213.1631	10/50	22
● 213.1632	10/50	22
● 213.1633	10/50	22
● 213.1633.K	10/50	162
● 213.1633.TR	10/50	25
● 213.16332	10/50	22
● 213.16333	10/50	22
● 213.16334	10/50	22
● 213.16336	10/50	22

213		
Cat.num.	Pack qty.	Page
● 213.16338	10/50	22
● 213.1633P	10/50	23
● 213.1633P.K	10/50	162
● 213.1633P.TR	10/50	25
● + 213.1634	10/50	22
● 213.1634P	10/50	23
● 213.1635	10/50	22
● + 213.1635.K	10/50	162
● 213.1636	10/50	22
● + 213.1636.K	10/50	162
● 213.16361	10/50	22
● 213.16362	10/50	22
● 213.16364	10/50	22
● 213.16365	10/50	22
● 213.16366	10/50	22
● 213.16367	10/50	22
● 213.1636P	10/50	23
● + 213.1636P.K	10/50	162
● + 213.1636P.TR	10/50	25
● 213.1636RV	10/50	26
● 213.1637	10/50	22
● + 213.1637-7	10	200
● 213.1637.K	10/50	162
● 213.16372	10/50	22
● 213.16374	10/50	22
● 213.16375	10/50	22
● 213.16376	10/50	22
● 213.16377	10/50	22
● 213.1637P	10/50	23
● + 213.1637P.K	10/50	162
● + 213.1637P.TR	10/50	25
● 213.1637RV	10/50	26
● + 213.1638	10/50	22
● + 213.1638P	10/50	23
● 213.3230	10/40	22
● 213.3230F	10/40	23
● 213.3231	10/40	22
● 213.3232	10/40	22
● 213.3233	10/40	22
● + 213.3233.K	10/40	162
● 213.32332	10/40	22
● 213.32333	10/40	22
● 213.32334	10/40	22
● 213.32336	10/40	22
● 213.32338	10/40	22
● 213.3233F	10/40	23
● 213.3233F.K	10/40	163
● + 213.3234	10/40	22
● 213.3234F	10/40	23
● 213.3235	10/40	22
● + 213.3235.K	10/40	162
● 213.3236	10/40	22
● + 213.3236.K	10/40	162
● 213.32361	10/40	22
● 213.32362	10/40	22
● 213.32364	10/40	22
● 213.32365	10/40	22
● 213.32366	10/40	22
● 213.32367	10/40	22
● 213.3236F	10/40	23
● 213.3236F.K	10/40	163
● 213.3236RV	10/40	26

213		
Cat.num.	Pack qty.	Page
● 213.3237	10/40	22
● + 213.3237-7	10	200
● 213.3237.K	10/40	162
● 213.32372	10/40	22
● 213.32374	10/40	22
● 213.32375	10/40	22
● 213.32376	10/40	22
● 213.32377	10/40	22
● 213.3237F	10/40	23
● 213.3237F.K	10/40	163
● 213.3237RV	10/40	26
● + 213.3238	10/40	22
● 213.3238F	10/40	23
● + 213.6330	6/24	24
● + 213.6331	6/24	24
● + 213.6332	6/24	24
● 213.6333	6/24	24
● + 213.63332	6/24	24
● + 213.63333	6/24	24
● + 213.63334	6/24	24
● + 213.63336	6/24	24
● + 213.63338	6/24	24
● + 213.6334	6/24	24
● + 213.6335	6/24	24
● 213.6336	6/24	24
● + 213.63361	6/24	24
● + 213.63362	6/24	24
● + 213.63364	6/24	24
● + 213.63365	6/24	24
● + 213.63366	6/24	24
● + 213.63367	6/24	24
● 213.6337	6/24	24
● + 213.63372	6/24	24
● + 213.63374	6/24	24
● + 213.63375	6/24	24
● + 213.63376	6/24	24
● + 213.63377	6/24	24
● + 213.63378	6/24	24

214		
Cat.num.	Pack qty.	Page
● + 214.1630	50	27
● 214.1633	50	27
● 214.1636	40	27
● 214.1637	30	27
● 214.3230	25	27
● 214.3233	25	27
● 214.3236	25	27
● 214.3237	20	27

215		
Cat.num.	Pack qty.	Page
● + 215.812533		178
● + 215.812536		178
● + 215.812537		178
● + 215.86333		178
● + 215.86336	1	178
● + 215.86337	1	178

216		
Cat.num.	Pack qty.	Page
● + 216.81633	1/5	178
● + 216.81636	1/5	178
● + 216.81637	1/5	178
● + 216.83233	1/5	178
● + 216.83236		178
● + 216.83237	1/5	178

218		
Cat.num.	Pack qty.	Page
● + 218.12530	1/8	30
● 218.12531	1/8	30
● 218.12532	1/8	30
● + 218.12533	1/8	30
● 218.12533.K	1/8	171
● + 218.12533.KX	1/8	32
● 218.125332	1/8	30
● 218.125333	1/8	30
● + 218.125334	1/8	30
● 218.125336	1/8	30
● + 218.125338	1/8	30
● + 218.12534	1/8	30
● 218.12535	1/8	30
● + 218.12535.KX	1/8	32
● 218.12536	1/8	30
● + 218.12536.K	1/8	171
● + 218.12536.KX	1/8	32
● 218.125361	1/8	30
● 218.125362	1/8	30
● 218.125364	1/8	30
● 218.125365	1/8	30
● 218.125366	1/8	30
● 218.125367	1/8	30
● 218.12537	1/8	30
● + 218.12537.K	1/8	171
● + 218.12537.KX	1/8	32
● 218.125372	1/8	30
● 218.125374	1/8	30
● 218.125375	1/8	30
● 218.125376	1/8	30
● 218.125377	1/8	30
● + 218.12538	1/8	30
● 218.1630	10/40	28
● + 218.1630.TR	10/40	31
● 218.1630P	10/40	29
● + 218.1630P.TR	10/40	31
● 218.1631	10/40	28
● 218.1632	10/40	28
● 218.1633	10/40	28
● 218.1633.K	10/40	169
● + 218.1633.KX	10/40	32
● 218.1633.TR	10/40	31
● 218.16332	10/40	28
● 218.16333	10/40	28
● 218.16334	10/40	28
● 218.16336	10/40	28
● 218.16338	10/40	28
● 218.1633P	10/40	29
● 218.1633P.K	10/40	170
● 218.1633P.TR	10/40	31
● + 218.1634	10/40	28

# Index by product number

218		
Cat.numb.	Pack qty.	Page
● + 218.1634P	10/40	29
● 218.1635	10/40	28
● + 218.1635.KX	10/40	32
● 218.1636	10/40	28
● + 218.1636.K	10/40	169
● + 218.1636.KX	10/40	32
● 218.16361	10/40	28
● 218.16362	10/40	28
● 218.16364	10/40	28
● 218.16365	10/40	28
● 218.16366	10/40	28
● 218.16367	10/40	28
● 218.1636P	10/40	29
● + 218.1636P.K	10/40	170
● 218.1636RV	10/40	31
● 218.1637	10/40	28
● ✓ 218.1637-7	10	200
● 218.1637.K	10/40	169
● + 218.1637.KX	10/40	32
● 218.16372	10/40	28
● 218.16374	10/40	28
● 218.16375	10/40	28
● 218.16376	10/40	28
● 218.16377	10/40	28
● 218.1637P	10/40	29
● + 218.1637P.K	10/40	170
● 218.1637RV	10/40	31
● + 218.1638	10/40	28
● + 218.1638P	10/40	29
● 218.3230	10/40	28
● 218.3230F	10/40	29
● 218.3231	10/40	28
● 218.3232	10/40	28
● 218.3233	10/40	28
● + 218.3233.K	10/40	169
● + 218.3233.KX	10/40	32
● 218.32332	10/40	28
● 218.32333	10/40	28
● 218.32334	10/40	28
● 218.32336	10/40	28
● 218.32338	10/40	28
● 218.3233F	10/40	29
● 218.3233F.K	10/40	170
● + 218.3234	10/40	28
● 218.3234F	10/40	29
● 218.3235	10/40	28
● + 218.3235.KX	10/40	32
● 218.3236	10/40	28
● + 218.3236.K	10/40	169
● + 218.3236.KX	10/40	32
● 218.32361	10/40	28
● 218.32362	10/40	28
● + 218.32364	10/40	28
● 218.32364.KX	1/12	32
● 218.32364F	10/40	29
● 218.32365	10/40	28
● 218.32366	10/40	28
● 218.32367	10/40	28
● 218.3236F	10/40	29
● 218.3236F.K	10/40	170
● 218.3236RV	10/40	31
● 218.3237	10/40	28

218		
Cat.numb.	Pack qty.	Page
● ✓ 218.3237-7	10	200
● 218.3237.K	10/40	169
● + 218.3237.KX	10/40	32
● 218.32372	10/40	28
● 218.32374	10/40	28
● 218.32375	10/40	28
● 218.32376	10/40	28
● 218.32377	10/40	28
● 218.3237F	10/40	29
● 218.3237F.K	10/40	170
● 218.3237RV	10/40	31
● + 218.3238	10/40	28
● 218.3238F	10/40	29
● + 218.6330	6/24	30
● 218.6331	6/24	30
● 218.6332	6/24	30
● 218.6333	6/24	30
● 218.6333.K	6/24	171
● + 218.6333.KX	6/24	32
● 218.63332	6/24	30
● 218.63333	6/24	30
● 218.63334	6/24	30
● 218.63336	6/24	30
● 218.63338	6/24	30
● 218.6334	6/24	30
● 218.6335	6/24	30
● + 218.6335.KX	6/24	32
● 218.6336	6/24	30
● 218.6336.K	6/24	171
● + 218.6336.KX	6/24	32
● 218.63361	6/24	30
● 218.63362	6/24	30
● 218.63364	6/24	30
● 218.63365	6/24	30
● ✓ 218.63365.KX	6/24	32
● 218.63366	6/24	30
● 218.63367	6/24	30
● 218.6337	6/24	30
● 218.6337.K	6/24	171
● + 218.6337.KX	6/24	32
● 218.63372	6/24	30
● 218.63374	6/24	30
● 218.63375	6/24	30
● 218.63377	6/24	30
● + 218.6338	6/24	30

221		
Cat.numb.	Pack qty.	Page
● + 221.1630	10/100	27
● 221.1633	10/100	27
● 221.1636	10/100	27
● 221.1637	10/100	27
● + 221.3230	10/60	27
● 221.3233	10/60	27
● 221.3236	10/60	27
● 221.3237	10/50	27

226		
Cat.numb.	Pack qty.	Page
● + 226.1630	10/100	33
● 226.1633	10/100	33
● 226.1636	10/100	33
● + 226.16367	10/100	33
● 226.1637	10/50	33
● + 226.3230	10/40	33
● 226.3233	10/40	33
● + 226.3236	10/40	33
● + 226.32364	10/40	33
● 226.3237	10/40	33

230		
Cat.numb.	Pack qty.	Page
● 230.1600	10/100	156
● 230.1601	10/100	156
● + 230.16010	10/100	156
● + 230.16012	10/100	156
● + 230.16014	10/100	156
● + 230.16015	10/100	156
● + 230.1602	10/100	156
● 230.1603	10/100	156
● 230.16030	10/100	156
● + 230.16032	10/100	156
● + 230.16034	10/100	156
● + 230.16035	10/100	156
● 230.1604	10/100	156
● 230.3200	10/100	156
● 230.3201	10/100	156
● + 230.32010	10/100	156
● + 230.32012	10/100	156
● + 230.32014	10/100	156
● + 230.32015	10/100	156
● + 230.3202	10/100	156
● 230.3203	10/100	156
● 230.32030	10/100	156
● + 230.32032	10/100	156
● + 230.32034	10/100	156
● + 230.32035	10/100	156
● 230.3204	10/100	156

235		
Cat.numb.	Pack qty.	Page
● 235.1600	10/100	156
● 235.1601	10/100	156
● + 235.16010	10/100	156
● + 235.16012	10/100	156
● + 235.16014	10/100	156
● + 235.16015	10/100	156
● + 235.1602	10/100	156
● + 235.1603	10/100	156
● + 235.16030	10/100	156
● + 235.16032	10/100	156
● + 235.16034	10/100	156
● + 235.16035	10/100	156
● 235.1604	10/100	156
● + 235.3200	10/100	156
● 235.3201	10/100	156
● + 235.32010	10/100	156

235		
Cat.numb.	Pack qty.	Page
● + 235.32012	10/100	156
● + 235.32014	10/100	156
● + 235.32015	10/100	156
● + 235.3202	10/100	156
● + 235.3203	10/100	156
● + 235.32030	10/100	156
● + 235.32032	10/100	156
● + 235.32034	10/100	156
● + 235.32035	10/100	156
● + 235.3204	10/100	156

240		
Cat.numb.	Pack qty.	Page
● ✓ 240.1697-7	10	200
● ✓ 240.3297-7	10	200
● ✓ 240.6390T	4	41
● ✓ 240.6391T	4	41
● ✓ 240.6392T	4	41
✓ 240.63932T		41
✓ 240.63933T		41
✓ 240.63934T		41
✓ 240.63936T		41
✓ 240.63938T		41
● ✓ 240.6393T	4	41
● ✓ 240.6394T	4	41
● ✓ 240.6395T	4	41
✓ 240.63961T		41
✓ 240.63962T		41
✓ 240.63964T		41
✓ 240.63965T		41
✓ 240.63966T		41
✓ 240.63967T		41
● ✓ 240.6396T	4	41
✓ 240.63972T		41
✓ 240.63974T		41
✓ 240.63975T		41
✓ 240.63976T		41
✓ 240.63977T		41
● ✓ 240.6397T	4	41
● ✓ 240.6398T	4	41

242		
Cat.numb.	Pack qty.	Page
● 242.1690	10/100	36
● + 242.1691	10/100	36
● + 242.1692	10/60	36
● 242.1693	10/100	36
● + 242.16932	10/100	36
● + 242.16933		36
● + 242.16934	10/100	36
● + 242.16936		36
● + 242.16938	10/100	36
● 242.1694	10/100	36
● + 242.1695	10/60	36
● 242.1696	10/100	36
● + 242.16961	10/100	36
● + 242.16962	10/100	36
● + 242.16964		36

242		
Cat.numb.	Pack qty.	Page
● + 242.16965	10/100	36
● + 242.16966	10/100	36
● + 242.16967	10/100	36
● 242.1697	10/60	36
● + 242.16972	10/60	36
● + 242.16974	10/60	36
● + 242.16975		36
● + 242.16976	10/60	36
● + 242.16977		36
● + 242.1698	10/100	36
● + 242.3290	10/60	36
● + 242.3291	10/60	36
● + 242.3292	10/40	36
● 242.3293	10/60	36
● + 242.32932		36
● + 242.32933		36
● + 242.32934	10/60	36
● + 242.32936	10/60	36
● + 242.32938	10/60	36
● + 242.3294	10/60	36
● + 242.3295	10/40	36
● 242.3296	10/60	36
● + 242.32961		36
● + 242.32962	10/60	36
● + 242.32964	10/60	36
● + 242.32965	10/60	36
● + 242.32966	10/60	36
● + 242.32967	10/60	36
● 242.3297	10/40	36
● + 242.32972	10/40	36
● + 242.32974	10	36
● + 242.32975	10	36
● + 242.32976	10	36
● + 242.32977	10	36
● + 242.3298	10/60	36

243		
Cat.numb.	Pack qty.	Page
● 243.1690	10/50	34
● + 243.1691	10/50	34
● + 243.1692	10/50	34
● 243.1693	10/50	34
● 243.1693.K	10/50	163
● + 243.1694	10/50	34
● + 243.1695	10/50	34
● 243.1696	10/50	34
● + 243.1696.K	10/50	163
● + 243.16964	10/50	34
● + 243.16965	10/50	34
● 243.1696RV	10/50	35
● 243.1697	10/50	34
● + 243.1697-7	10	201
● + 243.1697.K	10/50	163
● + 243.16974	10/50	34
● + 243.16975	10/50	34
● 243.1697RV	10/50	35
● + 243.1698	10/50	34
● + 243.3290	10/50	34
● + 243.3291	10/50	34
● + 243.3292	10/40	34

243		
Cat.numb.	Pack qty.	Page
● 243.3293	10/50	34
● + 243.3293.K	10/50	163
● + 243.3294	10/50	34
● + 243.3295	10/40	34
● 243.3296	10/50	34
● + 243.3296.K	10/50	163
● + 243.32964	10/50	34
● + 243.32965	10/50	34
● 243.3296RV	10/50	35
● 243.3297	10/40	34
● + 243.3297-7	10	201
● + 243.3297.K	10/40	163
● + 243.32974	10/40	34
● + 243.32975	10/40	34
● 243.3297RV	10/40	35
● + 243.3298	10/50	34
● + 243.6390		34
● + 243.6391		34
● + 243.6392		34
● 243.6393	10	34
● + 243.63932		34
● + 243.63933		34
● + 243.63934		34
● + 243.63936		34
● + 243.63938		34
● + 243.6394		34
● + 243.6395		34
● 243.6396	10	34
● + 243.63961		34
● + 243.63962		34
● + 243.63964		34
● + 243.63965		34
● + 243.63966		34
● + 243.63967		34
● 243.6397	10	34
● + 243.63972		34
● + 243.63974		34
● + 243.63975		34
● + 243.63976		34
● + 243.63977		34
● + 243.6398		34

245		
Cat.numb.	Pack qty.	Page
● + 245.12590T	1/4	42
● + 245.12591T	1/4	42
● + 245.12592T	1/4	42
● + 245.125932T		42
● + 245.125933T		42
● + 245.125934T		42
● + 245.125936T		42
● + 245.125938T		42
● + 245.12593T	1/4	42
● + 245.12594T	1/4	42
● + 245.12595T	1/4	42
● + 245.125961T		42
● + 245.125962T		42
● + 245.125964T		42
● + 245.125965T		42
● + 245.125966T		42

245		
Cat.numb.	Pack qty.	Page
● + 245.125967T		42
● + 245.12596T	1/4	42
● + 245.125972T		42
● + 245.125974T		42
● + 245.125975T		42
● + 245.125976T		42
● + 245.125977T		42
● + 245.12597T	1/4	42
● + 245.12598T	1/4	42
● + 245.1697-7	5	200
● + 245.3297-7	5	200
● + 245.6390T	4	42
● + 245.6391T	4	42
● + 245.6392T	4	42
● + 245.63932T		42
● + 245.63933T		42
● + 245.63934T		42
● + 245.63936T		42
● + 245.63938T		42
● + 245.6393T	4	42
● + 245.6394T	4	42
● + 245.6395T	4	42
● + 245.63961T		42
● + 245.63962T		42
● + 245.63964T		42
● + 245.63965T		42
● + 245.63966T		42
● + 245.63967T		42
● + 245.6396T	4	42
● + 245.63972T		42
● + 245.63974T		42
● + 245.63975T		42
● + 245.63976T	4	42
● + 245.63977T		42
● + 245.6397T	4	42
● + 245.6398T	4	42

246		
Cat.numb.	Pack qty.	Page
● + 246.125977	10	0

247		
Cat.numb.	Pack qty.	Page
● + 247.1690	10/100	40
● + 247.1691	10/60	40
● + 247.1692	10/50	40
● 247.1693	10/100	40
● + 247.16932	10/100	40
● + 247.16933		40
● + 247.16934	10/100	40
● + 247.16936	10/100	40
● + 247.16938		40
● + 247.1694	10/60	40
● + 247.1695	10/50	40
● 247.1696	10/60	40
● + 247.16961		40
● + 247.16962		40
● + 247.16964	10/60	40

247		
Cat.numb.	Pack qty.	Page
● + 247.16965	10/60	40
● + 247.16966	10/60	40
● + 247.16967	10/60	40
● 247.1697	10/50	40
● + 247.16972	10/50	40
● + 247.16974	10/50	40
● + 247.16975		40
● + 247.16976	10/50	40
● + 247.16977		40
● + 247.1698	10/100	40
● + 247.3290	10/40	40
● + 247.3291	10/40	40
● + 247.3292	10/40	40
● 247.3293	10/40	40
● + 247.32932		40
● + 247.32933		40
● + 247.32934	10/40	40
● + 247.32936	10/40	40
● + 247.32938		40
● + 247.3294	10/40	40
● + 247.3295	10/40	40
● 247.3296	10/40	40
● + 247.32961	10/40	40
● + 247.32962		40
● + 247.32964	10/40	40
● + 247.32965	10/40	40
● + 247.32966	10/40	40
● + 247.32967	10/40	40
● 247.3297	10/40	40
● + 247.32972	10/40	40
● + 247.32974	10/40	40
● + 247.32975	10/40	40
● + 247.32976	10	40
● + 247.32977	10/40	40
● + 247.3298	10/40	40
● + 247.812593		179
● + 247.812596		179
● + 247.812597		179
● + 247.81693	1/5	179
● + 247.81696		179
● + 247.81697	1/5	179
● + 247.83293	1/5	179
● + 247.83296		179
● + 247.83297	1/5	179
● + 247.86393		179
● + 247.86396		179
● + 247.86397	1	179

248		
Cat.numb.	Pack qty.	Page
● + 248.12590	10	38
● + 248.12591	10	38
● + 248.12592	10	38
● 248.12593	10	38
● + 248.125932	10	38
● + 248.125933	10	38
● + 248.125934	10	38
● + 248.125936	10	38
● + 248.125938	10	38
● + 248.12594	10	38





314		
Cat.num.	Pack qty.	Page
● 314.1647	25	51
● + 314.3240	20	51
● + 314.3243	20	51
● + 314.3246	20	51
● 314.3247	15	51

315		
Cat.num.	Pack qty.	Page
● + 315.812543		180
● + 315.812546	1	180
● + 315.812547		180
● + 315.86343	1	180
● + 315.86346		180
● + 315.86347	1	180

316		
Cat.num.	Pack qty.	Page
● + 316.81643	15	180
● + 316.81646		180
● + 316.81647	15	180
● + 316.83243	15	180
● + 316.83246		180
● + 316.83247	15	180

318		
Cat.num.	Pack qty.	Page
● + 318.12540	1/8	54
● 318.12541	1/8	54
● 318.12542	1/8	54
● + 318.12543	1/8	54
● + 318.12543.K	1/8	174
● + 318.12543.KX	1/8	57
● 318.125432	1/8	54
● 318.125433	1/8	54
● ✓ 318.125434	1/8	54
● 318.125436	1/8	54
● ✓ 318.125438	1/8	54
● + 318.12544	1/8	54
● 318.12545	1/8	54
● 318.12546	1/8	54
● + 318.12546.K	1/8	174
● + 318.12546.KX	1/8	57
● 318.125461	1/8	54
● 318.125462	1/8	54
● 318.125464	1/8	54
● 318.125465	1/8	54
● 318.125466	1/8	54
● 318.125467	1/8	54
● 318.12547	1/8	54
● + 318.12547.K	1/8	174
● + 318.12547.KX	1/8	57
● 318.125472	1/8	54
● 318.125474	1/8	54
● 318.125475	1/8	54
● 318.125476	1/8	54
● 318.125477	1/8	54

318		
Cat.num.	Pack qty.	Page
● + 318.12548	1/8	54
● 318.1640	10/40	52
● + 318.1640.TR	10/40	55
● + 318.1640H	10/40	56
● 318.1640P	10/40	53
● + 318.1640P.TR	10/40	55
● 318.1641	10/40	52
● 318.1642	10/40	52
● 318.1643	10/40	52
● 318.1643.K	10/40	172
● + 318.1643.KX	10/40	57
● 318.1643.TR	10/40	55
● 318.16432	10/40	52
● 318.16433	10/40	52
● 318.16434	10/40	52
● 318.16436	10/40	52
● 318.16438	10/40	52
● 318.1643H	10/40	56
● 318.1643H.K	10/40	174
● 318.1643P	10/40	53
● 318.1643P.K	10/40	173
● 318.1643P.TR	10/40	55
● + 318.1644	10/40	52
● + 318.1644H	10/40	56
● + 318.1644P	10/40	53
● 318.1645	10/40	52
● 318.1646	10/40	52
● + 318.1646.K	10/40	172
● + 318.1646.KX	10/40	57
● 318.16461	10/40	52
● 318.16462	10/40	52
● 318.16464	10/40	52
● 318.16465	10/40	52
● 318.16466	10/40	52
● 318.16467	10/40	52
● 318.1646H	10/40	56
● + 318.1646H.K	10/40	174
● 318.1646P	10/40	53
● + 318.1646P.K	10/40	173
● 318.1647	10/40	52
● ✓ 318.1647-7	10	201
● 318.1647.K	10/40	172
● + 318.1647.KX	10/40	57
● 318.16472	10/40	52
● 318.16474	10/40	52
● 318.16475	10/40	52
● 318.16476	10/40	52
● 318.16477	10/40	52
● 318.1647H	10/40	56
● + 318.1647H.K	10/40	174
● 318.1647P	10/40	53
● + 318.1647P.K	10/40	173
● + 318.1648	10/40	52
● + 318.1648H	10/40	56
● + 318.1648P	10/40	53
● 318.3240	10/40	52
● 318.3240F	10/40	53
● 318.3241	10/40	52
● 318.3242	10/40	52
● 318.3243	10/40	52
● + 318.3243.K	10/40	172
● + 318.3243.KX	10/40	57

318		
Cat.num.	Pack qty.	Page
● 318.32432	10/40	52
● 318.32433	10/40	52
● 318.32434	10/40	52
● 318.32436	10/40	52
● 318.32438	10/40	52
● 318.3243F	10/40	53
● 318.3243F.K	10/40	173
● + 318.3244	10/40	52
● 318.3244F	10/40	53
● 318.3245	10/40	52
● 318.3246	10/40	52
● + 318.3246.K	10/40	172
● + 318.3246.KX	10/40	57
● 318.32461	10/40	52
● 318.32462	10/40	52
● 318.32464	10/40	52
● 318.32464.KX	1/12	57
● 318.32464F	10/40	53
● 318.32465	10/40	52
● 318.32466	10/40	52
● 318.32467	10/40	52
● 318.3246F	10/40	53
● 318.3246F.K	10/40	173
● 318.3247	10/40	52
● ✓ 318.3247-7	10	201
● 318.3247.K	10/40	172
● + 318.3247.KX	10/40	57
● 318.32472	10/40	52
● 318.32474	10/40	52
● 318.32475	10/40	52
● 318.32476	10/40	52
● 318.32477	10/40	52
● 318.3247F	10/40	53
● 318.3247F.K	10/40	173
● + 318.3248	10/40	52
● 318.3248F	10/40	53
● + 318.6340	6/24	54
● 318.6341	6/24	54
● 318.6342	6/24	54
● 318.6343	6/24	54
● 318.6343.K	6/24	174
● + 318.6343.KX	6/24	57
● 318.63432	6/24	54
● 318.63433	6/24	54
● 318.63434	6/24	54
● 318.63436	6/24	54
● 318.63438	6/24	54
● + 318.6344	6/24	54
● 318.6346	6/24	54
● 318.6346.K	6/24	174
● + 318.6346.KX	6/24	57
● 318.63461	6/24	54
● 318.63462	6/24	54
● 318.63464	6/24	54
● 318.63465	6/24	54
● 318.63466	6/24	54
● 318.63467	6/24	54
● 318.6347	6/24	54
● 318.6347.K	6/24	174
● + 318.6347.KX	6/24	57
● 318.63472	6/24	54
● 318.63474	6/24	54

318		
Cat.num.	Pack qty.	Page
● 318.63475	6/24	54
● 318.63476	6/24	54
● 318.63477	6/24	54
● + 318.6348	6/24	54

321		
Cat.num.	Pack qty.	Page
● + 321.1640	10/100	51
● 321.1643	10/100	51
● + 321.1646	10/100	51
● + 321.1647	10/100	51
● + 321.3240	10/50	51
● + 321.3243	10/50	51
● + 321.3246	10/50	51
● + 321.3247	10/50	51

326		
Cat.num.	Pack qty.	Page
● + 326.1640	10/100	58
● 326.1643	10/100	58
● + 326.1646	10/100	58
● + 326.1647	10/50	58
● + 326.3240	10/40	58
● + 326.3243	10/40	58
● + 326.3246	10/40	58
● + 326.32464	10/40	58
● + 326.3247	10/40	58

330		
Cat.num.	Pack qty.	Page
● 330.1605	10/100	157
● 330.1606	10/100	157
● + 330.16060	10/100	157
● + 330.16062	10/100	157
● + 330.16064	10/100	157
● + 330.16065	10/100	157
● + 330.1607	10/100	157
● 330.1608	10/100	157
● + 330.16080	10/100	157
● + 330.16082	10/100	157
● + 330.16084	10/100	157
● + 330.16085	10/100	157
● 330.1609	10/100	157
● 330.3205	10/100	157
● 330.3206	10/100	157
● + 330.32060	10/100	157
● + 330.32062	10/100	157
● + 330.32064	10/100	157
● + 330.32065	10/100	157
● + 330.3207	10/100	157
● + 330.3208	10/100	157
● 330.32080	10/100	157
● + 330.32082	10/100	157
● + 330.32084	10/100	157
● + 330.32085	10/100	157
● + 330.3209	10/100	157

## Index by product number

335		
Cat.num.	Pack qty.	Page
● 335.1605	10/100	157
● 335.1606	10/100	157
● + 335.16060	10/100	157
● + 335.16062	10/100	157
● + 335.16064	10/100	157
● + 335.16065	10/100	157
● + 335.1607	10/100	157
● + 335.1608	10/100	157
● + 335.16080	10/100	157
● + 335.16082	10/100	157
● + 335.16084	10/100	157
● + 335.16085	10/100	157
● + 335.1609	10/100	157
● + 335.3205	10/50	157
● + 335.3206	10/50	157
● + 335.32060	10/50	157
● + 335.32062	10/50	157
● + 335.32064	10/50	157
● + 335.32065	10/50	157
● + 335.3207	10/50	157
● + 335.3208	10/50	157
● + 335.32080	10/50	157
● + 335.32082	10/50	157
● + 335.32084	10/50	157
● + 335.32085	10/50	157
● + 335.3209	10/50	157

400		
Cat.num.	Pack qty.	Page
● + 400.1670	6	98
● + 400.1672	6	98
● + 400.1674	6	98
● + 400.1675	6	98
● + 400.1678	6	98
● + 400.1679	6	98
● 400.1683	6	98
● + 400.16832	6	98
● + 400.16833	6	98
● + 400.16834	6	98
● + 400.16836	6	98
● + 400.16838	6	98
● 400.1686	6	98
● + 400.16861	6	98
● + 400.16862	6	98
● + 400.16864	6	98
● + 400.16865	6	98
● + 400.16866	6	98
● + 400.16867	6	98
● 400.1687	6	98
● + 400.16872	6	98
● + 400.16874	6	98
● + 400.16875	6	98
● + 400.16876	6	98
● + 400.16877	6	98
● 400.2416	6	106
● + 400.2420	6	106
● + 400.2421	6	106
● + 400.2620	6	106
● + 400.2621	6	106
● + 400.3270	6	98

400		
Cat.num.	Pack qty.	Page
● + 400.3272	6	98
● + 400.3274	6	98
● + 400.3275	6	98
● + 400.3278	6	98
● + 400.3279	6	98
● + 400.3283	6	98
● + 400.32832	6	98
● + 400.32833	6	98
● + 400.32834	6	98
● + 400.32836	6	98
● + 400.32838	6	98
● 400.3286	6	98
● + 400.32861	6	98
● + 400.32862	6	98
● + 400.32864	6	98
● + 400.32865	6	98
● + 400.32866	6	98
● + 400.32867	6	98
● 400.3287	6	98
● + 400.32872	6	98
● + 400.32874	6	98
● + 400.32875	6	98
● + 400.32876	6	98
● + 400.32877	6	98

401		
Cat.num.	Pack qty.	Page
● + 401.1670	6	102
● + 401.1672	6	102
● + 401.1674	6	102
● + 401.1675	6	102
● + 401.1678	6	102
● + 401.1679	6	102
● 401.1683	6	102
● + 401.16832	6	102
● + 401.16833	6	102
● + 401.16834	6	102
● + 401.16836	6	102
● + 401.16838	6	102
● 401.1686	6	102
● + 401.16861	6	102
● + 401.16862	6	102
● + 401.16864	6	102
● + 401.16865	6	102
● + 401.16866	6	102
● + 401.16867	6	102
● 401.1687	6	102
● + 401.16872	6	102
● + 401.16874	6	102
● + 401.16875	6	102
● + 401.16876	6	102
● + 401.16877	6	102
● + 401.3270	6	102
● + 401.3272	6	102
● + 401.3274	6	102
● + 401.3275	6	102
● + 401.3278	6	102
● + 401.3279	6	102
● + 401.3283	6	102
● + 401.3286	6	102

401		
Cat.num.	Pack qty.	Page
● + 401.3287	6	102

402		
Cat.num.	Pack qty.	Page
● + 402.1670	1/6	133
● + 402.1670-F	1/6	135
● + 402.1672	1	133
● + 402.1672-F	1	135
● + 402.1674	1/6	133
● + 402.1674-F	1/6	135
● + 402.1675	1	133
● + 402.1675-F	1/6	135
● + 402.1678	1	133
● + 402.1678-F	1	135
● + 402.1679	1	133
● + 402.1679-F	1	135
● 402.1683	1/6	133
● 402.1683-F	1/6	135
● + 402.16832	1	133
● + 402.16832-F	1	135
● + 402.16833	1/6	133
● + 402.16833-F	1	135
● + 402.16836	1	133
● + 402.16836-F	1	135
● 402.1686	1/6	133
● 402.1686-F	1/6	135
● + 402.16861	1	133
● + 402.16861-F	1	135
● + 402.16862	1	133
● + 402.16862-F	1	135
● + 402.16864	1/6	133
● + 402.16864-F	1/6	135
● + 402.16865	1/6	133
● + 402.16865-F	1/6	135
● + 402.16866	1/6	133
● + 402.16866-F	1	135
● + 402.16867	1	133
● + 402.16867-F	1	135
● 402.1687	1/6	133
● 402.1687-F	1/6	135
● + 402.16872	1	133
● + 402.16872-F	1	135
● + 402.16874	1/6	133
● + 402.16874-F	1/6	135
● + 402.16875	1	133
● + 402.16875-F	1/6	135
● + 402.16876	1	133
● + 402.16876-F	1	135
● + 402.16877	1	133
● + 402.16877-F	1	135
● + 402.6370	1	133
● + 402.6370-F	1	135
● + 402.6372	1	133
● + 402.6372-F	1	135
● + 402.6374	1	133
● + 402.6374-F	1	135
● + 402.6375	1	133
● + 402.6375-F	1	135
● + 402.6378	1	133
● + 402.6378-F	1	135
● + 402.6379	1	133
● + 402.6379-F	1	135
● + 402.6383	1	133
● + 402.6383-F	1	135
● + 402.63832	1	133
● + 402.63832-F	1	135
● + 402.63833	1	133
● + 402.63833-F	1	135
● + 402.63836	1	133
● + 402.63836-F	1	135
● 402.6386	1	133
● 402.6386-F	1	135
● + 402.63861	1	133
● + 402.63861-F	1	135
● + 402.63862	1	133
● + 402.63862-F	1	135



402		
Cat.numb.	Pack qty.	Page
● + 402.63864	1	133
● + 402.63864-F	1	135
● + 402.63865	1	133
● + 402.63865-F	1	135
● + 402.63866	1	133
● + 402.63866-F	1	135
● + 402.63867	1	133
● + 402.63867-F	1	135
● 402.6387	1	133
● 402.6387-F	1	135
● + 402.63872	1	133
● + 402.63872-F	1	135
● + 402.63874	1	133
● + 402.63874-F	1	135
● + 402.63875	1	133
● + 402.63875-F	1	135
● + 402.63876	1	133
● + 402.63876-F	1	135
● + 402.63877	1	133
● + 402.63877-F	1	135

403		
Cat.numb.	Pack qty.	Page
● + 403.1670	1/6	134
● + 403.1670-F	1	136
● + 403.1670-M	1/6	137
● + 403.1672	1	134
● + 403.1672-F	1	136
● + 403.1672-M	1/6	137
● + 403.1674	1/6	134
● + 403.1674-F	1	136
● + 403.1674-M	1/6	137
● + 403.1675	1	134
● + 403.1675-F	1	136
● + 403.1675-M	1/6	137
● + 403.1678	1	134
● + 403.1678-F	1/6	136
● + 403.1678-M	1/6	137
● + 403.1679	1	134
● + 403.1679-F	1	136
● + 403.1679-M	1/6	137
● 403.1683	1/6	134
● 403.1683-F	1/6	136
● 403.1683-M	1/6	137
● + 403.16832	1	134
● + 403.16832-F	1	136
● + 403.16833	1	134
● + 403.16833-F	1	136
● + 403.16836	1	134
● + 403.16836-F	1	136
● 403.1686	1/6	134
● 403.1686-F	1/6	136
● 403.1686-M	1/6	137
● + 403.16861	1	134
● + 403.16861-F	1	136
● + 403.16862	1	134
● + 403.16862-F	1	136
● + 403.16864	1	134
● + 403.16864-F	1	136
● + 403.16864-M	1	137

403		
Cat.numb.	Pack qty.	Page
● + 403.16865	1	134
● + 403.16865-F	1	136
● + 403.16865-M	1	137
● + 403.16866	1	134
● + 403.16866-F	1	136
● + 403.16867	1	134
● + 403.16867-F	1	136
● 403.1687	1/6	134
● 403.1687-F	1/6	136
● 403.1687-M	1/6	137
● + 403.16872	1	134
● + 403.16872-F	1	136
● + 403.16874	1	134
● + 403.16874-F	1	136
● + 403.16874-M	1	137
● + 403.16875	1	134
● + 403.16875-F	1	136
● + 403.16875-M	1	137
● + 403.16876	1	134
● + 403.16876-F	1	136
● + 403.16877	1	134
● + 403.16877-F	1	136
● + 403.2416	1/6	142
● + 403.2420	1/6	142
● + 403.2421	1/6	142
● + 403.2620	1/6	142
● + 403.2621	1/6	142
● + 403.3270	1/6	134
● + 403.3270-F	1/6	136
● + 403.3270-M	1/6	137
● + 403.3272	1	134
● + 403.3272-F	1	136
● + 403.3272-M	1/6	137
● + 403.3274	1	134
● + 403.3274-F	1	136
● + 403.3274-M	1/6	137
● + 403.3275	1	134
● + 403.3275-F	1	136
● + 403.3275-M	1/6	137
● + 403.3278	1	134
● + 403.3278-F	1	136
● + 403.3278-M	1/6	137
● + 403.3279	1	134
● + 403.3279-F	1	136
● + 403.3279-M	1/6	137
● 403.3283	1/6	134
● 403.3283-F	1/6	136
● + 403.3283-M	1/6	137
● + 403.32832	1	134
● + 403.32832-F	1	136
● + 403.32833	1	134
● + 403.32833-F	1	136
● + 403.32836	1	134
● + 403.32836-F	1	136
● 403.3286	1/6	134
● 403.3286-F	1/6	136
● + 403.3286-M	1/6	137
● + 403.32861	1	134
● + 403.32861-F	1	136
● + 403.32862	1	134
● + 403.32862-F	1	136
● + 403.32864	1/6	134

403		
Cat.numb.	Pack qty.	Page
● + 403.32864-F	1	136
● + 403.32864-M	1	137
● + 403.32865	1	134
● + 403.32865-F	1	136
● + 403.32865-M	1	137
● + 403.32866	1	134
● + 403.32866-F	1	136
● + 403.32867	1	134
● + 403.32867-F	1	136
● 403.3287	1/6	134
● 403.3287-F	1/6	136
● + 403.3287-M	1/6	137
● + 403.32872	1	134
● + 403.32872-F	1	136
● + 403.32874	1	134
● + 403.32874-F	1/6	136
● + 403.32874-M	1	137
● + 403.32875	1	134
● + 403.32875-F	1	136
● + 403.32875-M	1	137
● + 403.32876	1	134
● + 403.32876-F	1	136
● + 403.32877	1	134
● + 403.32877-F	1	136
● + 403.6370	1	134
● + 403.6370-F	1	136
● + 403.6370-M	1	137
● + 403.6372	1	134
● + 403.6372-F	1	136
● + 403.6372-M	1	137
● + 403.6374	1	134
● + 403.6374-F	1	136
● + 403.6374-M	1	137
● + 403.6375	1	134
● + 403.6375-F	1	136
● + 403.6375-M	1	137
● + 403.6378	1	134
● + 403.6378-F	1	136
● + 403.6378-M	1	137
● + 403.6379	1	134
● + 403.6379-F	1	136
● + 403.6379-M	1	137
● 403.6383	1	134
● 403.6383-F	1	136
● + 403.6383-M	1	137
● + 403.63832	1	134
● + 403.63832-F	1	136
● + 403.63833	1	134
● + 403.63833-F	1	136
● + 403.63836	1	134
● + 403.63836-F	1	136
● 403.6386	1	134
● 403.6386-F	1	136
● + 403.6386-M	1	137
● + 403.63861	1	134
● + 403.63861-F	1	136
● + 403.63862	1	136
● + 403.63862-F	1	136
● + 403.63864	1	134
● + 403.63864-F	1	136
● + 403.63864-M	1	137
● + 403.63865	1	134

403		
Cat.numb.	Pack qty.	Page
● + 403.63865-F	1	136
● + 403.63865-M	1	137
● + 403.63866	1	134
● + 403.63866-F	1	136
● + 403.63867	1	134
● + 403.63867-F	1	136
● 403.6387	1	134
● 403.6387-F	1	136
● + 403.6387-M	1	137
● + 403.63872	1	134
● + 403.63872-F	1	136
● + 403.63874	1	134
● + 403.63874-F	1	136
● + 403.63874-M	1	137
● + 403.63875	1	134
● + 403.63875-F	1	136
● + 403.63875-M	1	137
● + 403.63876	1	134
● + 403.63876-F	1	136
● + 403.63877	1	134
● + 403.63877-F	1	136
● + 403.63877-M	1	137
● + 403.AMR1683	1	150
● + 403.AMR1683-F	1	151
● + 403.AMR1683-M	1	152
● + 403.AMR1686	1	150
● + 403.AMR1686-F	1	151
● + 403.AMR1686-M	1	152
● + 403.AMR1687	1	150
● + 403.AMR1687-F	1	151
● + 403.AMR1687-M	1	152
● + 403.AMR3283	1	150
● + 403.AMR3283-F	1	151
● + 403.AMR3283-M	1	152
● + 403.AMR3286	1	150
● + 403.AMR3286-F	1	151
● + 403.AMR3286-M	1	152
● + 403.AMR32864	1	150
● + 403.AMR32864-F	1	151
● + 403.AMR32864-M	1	152
● + 403.AMR3287	1	150
● + 403.AMR3287-F	1	151
● + 403.AMR3287-M	1	152
● + 403.AMR6383	1	150
● + 403.AMR6383-F	1	151
● + 403.AMR6383-M	1	152
● + 403.AMR6386	1	150
● + 403.AMR6386-F	1	151
● + 403.AMR6386-M	1	152
● + 403.AMR6387	1	150
● + 403.AMR6387-F	1	151
● + 403.AMR6387-M	1	152

405		
Cat.numb.	Pack qty.	Page
● + 405.1670	6	99
● + 405.1672	6	99
● + 405.1674	6	99
● + 405.1675	6	99
● + 405.1678	6	99
● + 405.1679	6	99

# Index by product number

405		
Cat.numb.	Pack qty.	Page
● 405.1683	6	99
● + 405.16832	6	99
● + 405.16833	6	99
● + 405.16834	6	99
● + 405.16836	6	99
● + 405.16838	6	99
● 405.1686	6	99
● + 405.16861	6	99
● + 405.16862	6	99
● + 405.16864	6	99
● + 405.16865	6	99
● + 405.16866	6	99
● + 405.16867	6	99
● 405.1687	6	99
● + 405.16872	6	99
● + 405.16874	6	99
● + 405.16875	6	99
● + 405.16876	6	99
● + 405.16877	6	99
● 405.2416	6	106
● 405.2420	6	106
● + 405.2421	6	106
● + 405.2620	6	106
● + 405.2621	6	106
● + 405.3270	6	99
● + 405.3272	6	99
● + 405.3274	6	99
● + 405.3275	6	99
● + 405.3278	6	99
● + 405.3279	6	99
● 405.3283	6	99
● + 405.32832	6	99
● + 405.32833	6	99
● + 405.32834	6	99
● + 405.32836	6	99
● + 405.32838	6	99
● 405.3286	6	99
● + 405.32861	6	99
● + 405.32862	6	99
● + 405.32864	6	99
● + 405.32865	6	99
● + 405.32866	6	99
● + 405.32867	6	99
● 405.3287	6	99
● + 405.32872	6	99
● + 405.32874	6	99
● + 405.32875	6	99
● + 405.32876	6	99
● + 405.32877	6	99
● + 405.6370	1/6	99
● 405.6372	1/6	99
● + 405.6374	1/6	99
● + 405.6375	1/6	99
● + 405.6378	1/6	99
● + 405.6379	1/6	99
● 405.6383	1/6	99
● + 405.63833	1/6	99
● + 405.63836	1/6	99
● 405.6386	1/6	99
● + 405.63865	1/6	99
● + 405.63866	1/6	99
● + 405.63867	1/6	99

405		
Cat.numb.	Pack qty.	Page
● 405.6387	1/6	99
● + 405.63875	1/6	99
● + 405.63876	1/6	99
● + 405.63877	1/6	99

406		
Cat.numb.	Pack qty.	Page
● + 406.1670	6	103
● + 406.1672	6	103
● + 406.1674	6	103
● + 406.1675	6	103
● + 406.1678	6	103
● + 406.1679	6	103
● 406.1683	6	103
● + 406.16832	6	103
● + 406.16833	6	103
● + 406.16834	6	103
● + 406.16836	6	103
● + 406.16838	6	103
● 406.1686	6	103
● + 406.16861	6	103
● + 406.16862	6	103
● + 406.16864	6	103
● + 406.16865	6	103
● + 406.16866	6	103
● + 406.16867	6	103
● 406.1687	6	103
● + 406.16872	6	103
● + 406.16874	6	103
● + 406.16875	6	103
● + 406.16876	6	103
● + 406.16877	6	103
● + 406.3270	6	103
● + 406.3272	6	103
● + 406.3274	6	103
● + 406.3275	6	103
● + 406.3278	6	103
● + 406.3279	6	103
● 406.3283	6	103
● 406.3286	6	103
● 406.3287	6	103

409		
Cat.numb.	Pack qty.	Page
● 409.0400	1/6	109
● 409.0403	1/6	108
● 409.0404	1/6	108
● 409.0405	1/6	108
● 409.0407	1/6	108
● 409.0411	1/6	108
● 409.0412	1/6	108
● + 409.0413	1/6	108
● 409.0417	1/6	108
● 409.0421	1/6	108
● 409.0424	1/6	108
● + 409.0427	1/6	108
● + 409.0428	1/6	108
● + 409.0429	1/6	108

409		
Cat.numb.	Pack qty.	Page
● 409.1403	1/6	108
● 409.1404	1/6	108
● 409.1405	1/6	108
● 409.1407	1/6	108
● 409.1411	1/6	108
● 409.1412	1/6	108
● + 409.1413	1/6	108
● 409.1417	1/6	108
● 409.1421	1/6	108
● 409.1424	1/6	108
● + 409.1427	1/6	108
● + 409.1428	1/6	108
● + 409.1429	1/6	108
● 409.2403	1/6	108
● 409.2404	1/6	108
● 409.2405	1/6	108
● 409.2407	1/6	108
● 409.2411	1/6	108
● 409.2412	1/6	108
● + 409.2413	1/6	108
● 409.2417	1/6	108
● 409.2421	1/6	108
● 409.2424	1/6	108
● + 409.2427	1/6	108
● + 409.2428	1/6	108
● + 409.2429	1/6	108
● 409.3403	1/6	108
● 409.3404	1/6	108
● 409.3405	1/6	108
● 409.3407	1/6	108
● 409.3411	1/6	108
● 409.3412	1/6	108
● + 409.3413	1/6	108
● 409.3417	1/6	108
● 409.3421	1/6	108
● 409.3424	1/6	108
● + 409.3427	1/6	108
● + 409.3428	1/6	108
● + 409.3429	1/6	108

413		
Cat.numb.	Pack qty.	Page
● 413.1660	10/100	59
● 413.1660F	10/100	61
● 413.1660H	10/100	62
● 413.1661	10/100	59
● 413.1662	10/100	59
● 413.1663	10/100	59
● 413.1663.K	10/100	166
● 413.16632	10/100	59
● 413.16633	10/100	59
● 413.16634	10/100	59
● 413.16636	10/100	59
● 413.16638	10/100	59
● 413.1663F	10/100	61
● 413.1663F.K	10/100	168
● 413.1663H	10/100	62
● 413.1663H.K	10/100	167
● 413.1664	10/100	59
● 413.1664F	10/100	61

413		
Cat.numb.	Pack qty.	Page
● 413.1664H	10/100	62
● 413.1665	10/100	59
● 413.1666	10/100	59
● 413.1666.K	10/100	166
● 413.16661	10/100	59
● 413.16662	10/100	59
● 413.16664	10/100	59
● 413.16665	10/100	59
● 413.16666	10/100	59
● 413.16667	10/100	59
● 413.1666F	10/100	61
● 413.1666F.K	10/100	168
● 413.1666H	10/100	62
● 413.1666H.K	10/100	167
● 413.1667	10/100	59
● + 413.1667-7	10	201
● 413.1667.K	10/100	166
● 413.16672	10/100	59
● 413.16674	10/100	59
● 413.16675	10/100	59
● 413.16676	10/100	59
● 413.16677	10/100	59
● 413.1667F	10/100	61
● 413.1667F.K	10/100	168
● 413.1667H	10/100	62
● 413.1667H.K	10/100	167
● 413.1668	10/100	59
● 413.1668F	10/100	61
● 413.1668H	10/100	62
● 413.3260	10/50	59
● 413.3260F	10/50	61
● 413.3261	10/50	59
● 413.3262	10/50	59
● 413.3263	10/50	59
● 413.3263.K	10/50	166
● 413.32632	10/50	59
● 413.32633	10/50	59
● 413.32634	10/50	59
● 413.32636	10/50	59
● 413.32638	10/50	59
● 413.3263F	10/50	61
● 413.3263F.K	10/50	168
● 413.3264	10/50	59
● 413.3264F	10/50	61
● 413.3265	10/50	59
● 413.3266	10/50	59
● 413.3266.K	10/50	166
● 413.32661	10/50	59
● 413.32662	10/50	59
● 413.32664	10/50	59
● 413.32665	10/50	59
● 413.32666	10/50	59
● 413.32667	10/50	59
● 413.3266F	10/50	61
● 413.3266F.K	10/50	168
● 413.3267	10/50	59
● + 413.3267-7	10	201
● 413.3267.K	10/50	166
● 413.32672	10/50	59
● 413.32674	10/50	59
● 413.32675	10/50	59
● 413.32676	10/50	59

413		
Cat.num.	Pack qty.	Page
● 413.32677	10/50	59
● 413.3267F	10/50	61
● 413.3267F.K	10/50	168
● 413.3268	10/50	59
● 413.3268F	10/50	61
● + 413.6360		59
● + 413.6361		59
● + 413.6362	6/30	59
● + 413.6363	6/30	59
● + 413.63632		59
● + 413.63633		59
● + 413.63634		59
● + 413.63636		59
● + 413.63638		59
● + 413.6364	6/30	59
● + 413.6365		59
● + 413.6366	6/30	59
● + 413.63661		59
● + 413.63662		59
● + 413.63664		59
● + 413.63665		59
● + 413.63666		59
● + 413.63667		59
● + 413.6367	6/30	59
● + 413.63672		59
● + 413.63674		59
● + 413.63675		59
● + 413.63676		59
● + 413.63677		59
● + 413.6368		59

418		
Cat.num.	Pack qty.	Page
● + 418.12560	1/10	66
● + 418.12561	1/10	66
● + 418.12562	1/10	66
● 418.12563	1/10	66
● + 418.125632	1/10	66
● + 418.125633	1/10	66
● + 418.125634	1/10	66
● + 418.125636	1/10	66
● + 418.125638	1/10	66
● + 418.12564	1/10	66
● + 418.12565	1/10	66
● 418.12566	1/10	66
● + 418.125661	1/10	66
● + 418.125662	1/10	66
● + 418.125664	1/10	66
● + 418.125665	1/10	66
● + 418.125666	1/10	66
● + 418.125667	1/10	66
● 418.12567	1/10	66
● + 418.125672	1/10	66
● + 418.125674	1/10	66
● + 418.125675	1/10	66
● + 418.125676	1/10	66
● + 418.125677	1/10	66
● + 418.12568	1/10	66
● 418.1660	10/100	65
● 418.1660F	10/100	68

418		
Cat.num.	Pack qty.	Page
● 418.1660H	10/100	69
● 418.1661	10/100	65
● 418.1662	10/100	65
● 418.1663	10/100	65
● 418.1663.K	10/100	175
● 418.16632	10/100	65
● 418.16633	10/100	65
● 418.16634	10/100	65
● 418.16636	10/100	65
● 418.16638	10/100	65
● 418.1663F	10/100	68
● 418.1663F.K	10/100	176
● 418.1663H	10/100	69
● 418.1663H.K	10/100	176
● 418.1664	10/100	65
● 418.1664F	10/100	68
● 418.1664H	10/100	69
● 418.1665	10/100	65
● 418.1666	10/100	65
● 418.1666.K	10/100	175
● 418.16661	10/100	65
● 418.16662	10/100	65
● 418.16664	10/100	65
● 418.16665	10/100	65
● 418.16666	10/100	65
● 418.16667	10/100	65
● 418.1666F	10/100	68
● 418.1666F.K	10/100	176
● 418.1666H	10/100	69
● 418.1666H.K	10/100	176
● 418.1667	10/100	65
● + 418.1667-7	10	201
● + 418.1667.K	10/100	175
● 418.16672	10/100	65
● 418.16674	10/100	65
● 418.16675	10/100	65
● 418.16676	10/100	65
● 418.16677	10/100	65
● 418.1667F	10/100	68
● 418.1667F.K	10/100	176
● 418.1667H	10/100	69
● 418.1667H.K	10/100	176
● 418.1668	10/100	65
● 418.1668F	10/100	68
● 418.1668H	10/100	69
● 418.3260	10/50	65
● 418.3260F	10/50	68
● 418.3261	10/50	65
● 418.3263	10/50	65
● 418.3263.K	10/50	175
● 418.32632	10/50	65
● 418.32633	10/50	65
● 418.32634	10/50	65
● 418.32636	10/50	65
● 418.32638	10/50	65
● 418.3263F	10/50	68
● 418.3263F.K	10/50	176
● 418.3264	10/50	65
● 418.3264F	10/50	68
● 418.3265	10/50	65
● 418.3266	10/50	65
● 418.3266.K	10/50	175

418		
Cat.num.	Pack qty.	Page
● 418.32661	10/50	65
● 418.32662	10/50	65
● 418.32664	10/50	65
● 418.32665	10/50	65
● 418.32666	10/50	65
● 418.32667	10/50	65
● 418.3266F	10/50	68
● 418.3266F.K	10/50	176
● 418.3267	10/50	65
● + 418.3267-7	10	201
● + 418.3267.K	10/50	175
● 418.32672	10/50	65
● 418.32674	10/50	65
● 418.32675	10/50	65
● 418.32676	10/50	65
● 418.32677	10/50	65
● 418.3267F	10/50	68
● 418.3267F.K	10/50	176
● 418.3268	10/50	65
● 418.3268F	10/50	68
● + 418.6360	6/30	66
● + 418.6361	6/30	66
● + 418.6362	6/30	66
● 418.6363	6/30	66
● + 418.63632	6/30	66
● + 418.63633	6/30	66
● + 418.63634	6/30	66
● + 418.63636	6/30	66
● + 418.63638	6/30	66
● + 418.6364	6/30	66
● + 418.6365	6/30	66
● 418.6366	6/30	66
● + 418.63661	6/30	66
● + 418.63662	6/30	66
● + 418.63664	6/30	66
● + 418.63665	6/30	66
● + 418.63666	6/30	66
● + 418.63667	6/30	66
● 418.6367	6/30	66
● + 418.6367.K	6/30	175
● + 418.63672	6/30	66
● + 418.63674	6/30	66
● 418.63675	6/30	66
● + 418.63676	6/30	66
● + 418.63677	6/30	66
● + 418.6368	6/30	66

422		
Cat.num.	Pack qty.	Page
● 422.1660	10/100	64
● + 422.1660/R	10/100	64
● + 422.1661	10/100	64
● + 422.1662	10/100	64
● 422.1663	10/100	64
● + 422.1663.K	10/100	169
● 422.1663/R	10/100	64
● + 422.1663/R.K	10/100	168
● + 422.16632	10/100	64
● + 422.16633	10/100	64
● + 422.16634	10/100	64

422		
Cat.num.	Pack qty.	Page
● + 422.16636	10/100	64
● + 422.16638	10/100	64
● + 422.1664	10/100	64
● + 422.1665	10/100	64
● 422.1666	10/100	64
● + 422.16661	10/100	64
● + 422.16662	10/100	64
● + 422.16664	10/100	64
● + 422.16665	10/100	64
● + 422.16666	10/100	64
● + 422.16667	10/100	64
● 422.1667	10/100	64
● + 422.16672	10/100	64
● + 422.16674	10/100	64
● + 422.16675	10/100	64
● + 422.16676	10/100	64
● + 422.16677	10/100	64
● + 422.1668	10/100	64
● + 422.1668/R	10/100	64
● 422.3260	10/50	64
● + 422.3261	10/50	64
● + 422.3262	10/50	64
● 422.3263	10/50	64
● + 422.32632	10/50	64
● + 422.32633	10/50	64
● + 422.32634	10/50	64
● + 422.32636	10/50	64
● + 422.32638	10/50	64
● + 422.3264	10/50	64
● + 422.3265	10/50	64
● 422.3266	10/50	64
● + 422.32661	10/50	64
● + 422.32662	10/50	64
● + 422.32664	10/50	64
● + 422.32665	10/50	64
● + 422.32666	10/50	64
● + 422.32667	10/50	64
● 422.3267	10/50	64
● + 422.3267.K	10/50	169
● + 422.32672	10/50	64
● + 422.32674	10/50	64
● + 422.32675	10/50	64
● + 422.32676	10/50	64
● + 422.32677	10/50	64
● + 422.3268	10/50	64

423		
Cat.num.	Pack qty.	Page
● + 423.6360		60
● + 423.6361		60
● + 423.6362		60
● + 423.6363	6/30	60
● + 423.63632		60
● + 423.63633		60
● + 423.63634		60
● + 423.63636		60
● + 423.63638		60
● + 423.6364		60
● + 423.6365		60
● + 423.6366	6/30	60

# Index by product number

423		
Cat.numb.	Pack qty.	Page
● + 423.63661		60
● + 423.63662		60
● + 423.63664		60
● + 423.63665		60
● + 423.63666		60
● + 423.63667		60
● + 423.6367	6/30	60
● + 423.63672		60
● + 423.63674		60
● + 423.63675		60
● + 423.63676		60
● + 423.63677		60
● + 423.6368		60

427		
Cat.numb.	Pack qty.	Page
● + 427.1660	10/100	71
● + 427.1661	10/100	71
● + 427.1662	10/100	71
● 427.1663	10/100	71
● + 427.16632	10/100	71
● + 427.16633	10/100	71
● + 427.16634	10/100	71
● + 427.16636	10/100	71
● + 427.16638	10/100	71
● + 427.1664	10/100	71
● + 427.1665	10/100	71
● 427.1666	10/100	71
● + 427.16661	10/100	71
● + 427.16662	10/100	71
● + 427.16664	10/100	71
● + 427.16665	10/100	71
● + 427.16666	10/100	71
● + 427.16667	10/100	71
● 427.1667	10/100	71
● + 427.16672	10/100	71
● + 427.16674	10/100	71
● + 427.16675	10/100	71
● + 427.16676	10/100	71
● + 427.16677	10/100	71
● + 427.1668	10/100	71
● + 427.3260	10/50	71
● + 427.3261	10/50	71
● + 427.3262	10/50	71
● 427.3263	10/50	71
● + 427.32632	10/50	71
● + 427.32633	10/50	71
● + 427.32634	10/50	71
● + 427.32636	10/50	71
● + 427.32638	10/50	71
● + 427.3264	10/50	71
● + 427.3265	10/50	71
● 427.3266	10/50	71
● + 427.32661	10/50	71
● + 427.32662	10/50	71
● 427.32664	10/50	71
● + 427.32665	10/50	71
● + 427.32666	10/50	71
● + 427.32667	10/50	71
● 427.3267	10/50	71

427		
Cat.numb.	Pack qty.	Page
● + 427.32672	10/50	71
● + 427.32674	10/50	71
● + 427.32675	10/50	71
● + 427.32676	10/50	71
● + 427.32677	10/50	71
● + 427.3268	10/50	71
● + 427.812563		181
● + 427.812566		181
● + 427.812567		181
● + 427.81663	1/5	181
● + 427.81666		181
● + 427.81667	1/5	181
● + 427.83263	1/5	181
● + 427.83266		181
● + 427.83267	1/5	181
● + 427.86363		181
● + 427.86366		181
● + 427.86367	1	181

428		
Cat.numb.	Pack qty.	Page
● + 428.12560	1/10	67
● + 428.12561	1/10	67
● + 428.12562	1/10	67
● + 428.12563	1/10	67
● + 428.125632	1/10	67
● + 428.125633	1/10	67
● + 428.125634	1/10	67
● + 428.125638	1/10	67
● + 428.12564	1/10	67
● + 428.12565	1/10	67
● + 428.12566	1/10	67
● + 428.125661	1/10	67
● + 428.125662	1/10	67
● + 428.125664	1/10	67
● + 428.125665	1/10	67
● + 428.125666	1/10	67
● + 428.125667	1/10	67
● + 428.12567	1/10	67
● + 428.125672	1/10	67
● + 428.125674	1/10	67
● + 428.125675	1/10	67
● + 428.125676	1/10	67
● + 428.125677	1/10	67
● + 428.12568	1/10	67
● + 428.6360	6/30	67
● + 428.6361	6/30	67
● + 428.6362	6/30	67
● + 428.6363	6/30	67
● + 428.63632	6/30	67
● + 428.63633	6/30	67
● + 428.63634	6/30	67
● + 428.63636	6/30	67
● + 428.63638	6/30	67
● + 428.6364	6/30	67
● + 428.6365	6/30	67
● + 428.6366	6/30	67
● + 428.63661	6/30	67
● + 428.63662	6/30	67

428		
Cat.numb.	Pack qty.	Page
● + 428.63664	6/30	67
● + 428.63665	6/30	67
● + 428.63666	6/30	67
● + 428.63667	6/30	67
● + 428.6367	6/30	67
● + 428.63672	6/30	67
● + 428.63674	6/30	67
● + 428.63675	6/30	67
● + 428.63676	6/30	67
● + 428.63677	6/30	67
● + 428.6368	6/30	67

430		
Cat.numb.	Pack qty.	Page
● 430.1615	10/100	158
● 430.1615/R	10/100	158
● 430.1616	10/100	158
● + 430.1616/R	10/100	158
● + 430.16160	10/100	158
● + 430.16160/R	10/100	158
● + 430.16162	10/100	158
● + 430.16162/R	10/100	158
● + 430.16164	10/100	158
● + 430.16164/R	10/100	158
● + 430.16165	10/100	158
● + 430.16165/R	10/100	158
● + 430.1617	10/100	158
● + 430.1617/R	10/100	158
● 430.1618	10/100	158
● + 430.1618/R	10/100	158
● + 430.16180	10/100	158
● 430.16180/R	10/100	158
● + 430.16182	10/100	158
● + 430.16182/R	10/100	158
● + 430.16184	10/100	158
● + 430.16184/R	10/100	158
● + 430.16185	10/100	158
● + 430.16185/R	10/100	158
● 430.1619	10/100	158
● + 430.1619/R	10/100	158
● 430.3215	10/100	158
● + 430.3215/R	10/100	158
● + 430.3216	10/100	158
● + 430.3216/R	10/100	158
● + 430.32160	10/100	158
● + 430.32162	10/100	158
● + 430.32162/R	10/100	158
● + 430.32164	10/100	158
● + 430.32164/R	10/100	158
● + 430.32165	10/100	158
● + 430.32165/R	10/100	158
● + 430.3217	10/100	158
● + 430.3217/R	10/100	158
● + 430.3218	10/100	158
● + 430.3218/R	10/100	158
● 430.32180	10/100	158
● + 430.32180/R	10/100	158
● + 430.32182	10/100	158
● + 430.32182/R	10/100	158
● + 430.32184	10/100	158
● + 430.32184/R	10/100	158
● + 430.32185	10/100	158
● + 430.32185/R	10/100	158
● + 430.3219	10/100	158

430		
Cat.numb.	Pack qty.	Page
● + 430.32184	10/100	158
● + 430.32184/R	10/100	158
● + 430.32185	10/100	158
● + 430.32185/R	10/100	158
● 430.3219	10/100	158
● + 430.3219/R	10/100	158

435		
Cat.numb.	Pack qty.	Page
● 435.1615	10/100	159
● + 435.1615/R	10/100	159
● + 435.1616	10/100	159
● + 435.1616/R	10/100	159
● + 435.16160	10/100	159
● + 435.16160/R	10/100	159
● + 435.16162	10/100	159
● + 435.16162/R	10/100	159
● + 435.16164	10/100	159
● + 435.16164/R	10/100	159
● + 435.16165	10/100	159
● + 435.16165/R	10/100	159
● + 435.1617	10/100	159
● + 435.1617/R	10/100	159
● + 435.1618	10/100	159
● + 435.1618/R	10/100	159
● + 435.16180	10/100	159
● + 435.16180/R	10/100	159
● + 435.16182	10/100	159
● + 435.16182/R	10/100	159
● + 435.16184	10/100	159
● + 435.16184/R	10/100	159
● + 435.16185	10/100	159
● + 435.16185/R	10/100	159
● + 435.1619	10/100	159
● + 435.1619/R	10/100	159
● + 435.3215	10/100	159
● + 435.3215/R	10/100	159
● + 435.3216	10/100	159
● + 435.3216/R	10/100	159
● + 435.32160	10/100	159
● + 435.32160/R	10/100	159
● + 435.32162	10/100	159
● + 435.32162/R	10/100	159
● + 435.32164	10/100	159
● + 435.32164/R	10/100	159
● + 435.32165	10/100	159
● + 435.32165/R	10/100	159
● + 435.3217	10/100	159
● + 435.3217/R	10/100	159
● + 435.3218	10/100	159
● + 435.3218/R	10/100	159
● + 435.32180	10/100	159
● + 435.32180/R	10/100	159
● + 435.32182	10/100	159
● + 435.32182/R	10/100	159
● + 435.32184	10/100	159
● + 435.32184/R	10/100	159
● + 435.32185	10/100	159
● + 435.32185/R	10/100	159
● + 435.3219	10/100	159

435		
Cat.numb.	Pack qty.	Page
● + 435.3219/R	10/100	159

452		
Cat.numb.	Pack qty.	Page

● + 452.1660	10/100	63
● + 452.1661	10/60	63
● + 452.1662	10/60	63
● 452.1663	10/100	63
● + 452.16632		63
● + 452.16633		63
● + 452.16634		63
● + 452.16636		63
● + 452.16638		63
● + 452.1664	10/60	63
● + 452.1665	10/60	63
● 452.1666	10/60	63
● + 452.16661	10/60	63
● + 452.16662		63
● + 452.16664		63
● + 452.16665		63
● + 452.16666		63
● + 452.16667		63
● 452.1667	10/60	63
● + 452.16672	10/60	63
● + 452.16674		63
● + 452.16675		63
● + 452.16676		63
● + 452.16677		63
● + 452.1668	10/100	63
● + 452.3260	10/40	63
● + 452.3261	10/40	63
● + 452.3262	10/40	63
● 452.3263	10/40	63
● + 452.32632		63
● + 452.32633		63
● + 452.32634	10/40	63
● + 452.32636		63
● + 452.32638		63
● + 452.3264	10/40	63
● + 452.3265	10/40	63
● 452.3266	10/40	63
● + 452.32661		63
● + 452.32662		63
● + 452.32664	10/40	63
● + 452.32665	10/40	63
● + 452.32666		63
● + 452.32667		63
● 452.3267	10/40	63
● + 452.32672	10	63
● + 452.32674	10	63
● + 452.32675	10	63
● + 452.32676	10	63
● + 452.32677	10	63
● + 452.3268	10/40	63

457		
Cat.numb.	Pack qty.	Page
● + 457.1660	10/60	70

457		
Cat.numb.	Pack qty.	Page

● + 457.1661	10/50	70
● + 457.1662	10/50	70
● 457.1663	10/60	70
● + 457.16632		70
● + 457.16633		70
● + 457.16634		70
● + 457.16636		70
● + 457.16638		70
● + 457.1664	10/50	70
● + 457.1665	10/50	70
● 457.1666	10/50	70
● + 457.16661	10/50	70
● + 457.16662		70
● + 457.16664		70
● + 457.16665		70
● + 457.16666	10/50	70
● + 457.16667		70
● + 457.1667	10/50	70
● + 457.16672		70
● + 457.16674	10/50	70
● + 457.16675		70
● + 457.16676		70
● + 457.16677		70
● + 457.1668	10/60	70
● + 457.3260	10/40	70
● + 457.3261	10/40	70
● + 457.3262	10/40	70
● + 457.3263	10/40	70
● + 457.32632		70
● + 457.32633		70
● + 457.32634	10/40	70
● + 457.32636	10/40	70
● + 457.32638		70
● + 457.3264	10/40	70
● + 457.3265	10/40	70
● 457.3266	10/40	70
● + 457.32661		70
● + 457.32662		70
● + 457.32664	10/40	70
● + 457.32665		70
● 457.32666	10/40	70
● + 457.32667		70
● 457.3267	10	70
● + 457.32672	10	70
● + 457.32674	10/40	70
● + 457.32675	10/40	70
● + 457.32676	10	70
● + 457.32677	10/40	70
● + 457.3268	10/40	70

499		
Cat.numb.	Pack qty.	Page

✓ 499.AMRSW-000		155
✓ 499.AMRSW-001		155
✓ 499.AMRSW-010		155
✓ 499.AMRSW-030		155
✓ 499.AMRSW-060		155
✓ 499.AMRSW-100		155
✓ 499.AMRSW-999		155

500		
Cat.numb.	Pack qty.	Page

● + 500.1670	6	100
● + 500.1672	6	100
● + 500.1674	6	100
● + 500.1675	6	100
● + 500.1678	6	100
● + 500.1679	6	100
● 500.1683	6	100
● + 500.16832	6	100
● + 500.16833	6	100
● + 500.16834	6	100
● + 500.16836	6	100
● + 500.16838	6	100
● + 500.1686	6	100
● + 500.16861	6	100
● + 500.16862	6	100
● + 500.16864	6	100
● + 500.16865	6	100
● + 500.16866	6	100
● + 500.16867	6	100
● 500.1687	6	100
● + 500.16872	6	100
● + 500.16874	6	100
● + 500.16875	6	100
● + 500.16876	6	100
● + 500.16877	6	100
● + 500.2420	6	107
● + 500.2421	6	107
● + 500.2620	6	107
● + 500.2621	6	107
● + 500.3270	6	100
● + 500.3272	6	100
● + 500.3274	6	100
● + 500.3275	6	100
● + 500.3278	6	100
● + 500.3279	6	100
● + 500.3283	6	100
● + 500.32832	6	100
● + 500.32833	6	100
● + 500.32834	6	100
● + 500.32836	6	100
● + 500.32838	6	100
● + 500.3286	6	100
● + 500.32861	6	100
● + 500.32862	6	100
● + 500.32864	6	100
● + 500.32865	6	100
● + 500.32866	6	100
● + 500.32867	6	100
● 500.3287	6	100
● + 500.32872	6	100
● + 500.32874	6	100
● + 500.32875	6	100
● + 500.32876	6	100
● + 500.32877	6	100

501		
Cat.numb.	Pack qty.	Page

● + 501.1670	6	104
● + 501.1672	6	104
● + 501.1674	6	104

501		
Cat.numb.	Pack qty.	Page

● + 501.1675	6	104
● + 501.1678	6	104
● + 501.1679	6	104
● + 501.1683	6	104
● + 501.16832	6	104
● + 501.16833	6	104
● + 501.16834	6	104
● + 501.16836	6	104
● + 501.16838	6	104
● + 501.1686	6	104
● + 501.16861	6	104
● + 501.16862	6	104
● + 501.16864	6	104
● + 501.16865	6	104
● + 501.16866	6	104
● + 501.16867	6	104
● + 501.1687	6	104
● + 501.16872	6	104
● + 501.16874	6	104
● + 501.16875	6	104
● + 501.16876	6	104
● + 501.16877	6	104
● + 501.3270	6	104
● + 501.3272	6	104
● + 501.3274	6	104
● + 501.3275	6	104
● + 501.3278	6	104
● + 501.3279	6	104
● + 501.3283	6	104
● + 501.3286	6	104
● + 501.3287	6	104

503		
Cat.numb.	Pack qty.	Page

● + 503.12583	1	138
● + 503.12583-F	1	139
● + 503.12583-FS	1	139
● + 503.12583-M	1	140
● + 503.12583-RM	1	140
● + 503.12583-T	1	141
● + 503.125834-F	1	139
● 503.12586	1	138
● 503.12586-F	1	139
● + 503.12586-FS	1	139
● 503.12586-M	1	140
● 503.12586-RM	1	140
● + 503.12586-T	1	141
● + 503.125865	1	138
● 503.12587	1	138
● 503.12587-F	1	139
● + 503.12587-FS	1	139
● 503.12587-M	1	140
● 503.12587-RM	1	140
● + 503.12587-T	1	141
● + 503.1683	1	0
● + 503.1683-F	1	0
● + 503.1686	1	0
● + 503.1686-F	1	0
● + 503.1687	1	0
● + 503.1687-F	1	0



# Index by product number

503		
Cat.numb.	Pack qty.	Page
● + 503.3283	1	0
● + 503.3283-F	1	0
● + 503.3286	1	0
● + 503.3286-F	1	0
● + 503.3287	1	0
● + 503.3287-F	1	0
● + 503.6383	1	0
● + 503.6383-F	1	0
● + 503.6386	1	0
● + 503.6386-F	1	0
● + 503.6387	1	0
● + 503.6387-F	1	0
● ✓ 503.AMR12583	1	153
● ✓ 503.AMR12583-F	1	153
● ✓ 503.AMR12583-M	1	153
● ✓ 503.AMR12586	1	153
● ✓ 503.AMR12586-F	1	153
● ✓ 503.AMR12586-M	1	153
● ✓ 503.AMR12587	1	153
● ✓ 503.AMR12587-F	1	153
● ✓ 503.AMR12587-M	1	153

505		
Cat.numb.	Pack qty.	Page
● + 505.1670	6	101
● + 505.1672	6	101
● + 505.1674	6	101
● + 505.1675	6	101
● + 505.1678	6	101
● + 505.1679	6	101
● 505.1683	6	101
● + 505.16832	6	101
● + 505.16833	6	101
● + 505.16834	6	101
● + 505.16836	6	101
● + 505.16838	6	101
● + 505.1686	6	101
● + 505.16861	6	101
● + 505.16862	6	101
● + 505.16864	6	101
● + 505.16865	6	101
● + 505.16866	6	101
● + 505.16867	6	101
● + 505.1687	6	101
● + 505.16872	6	101
● + 505.16874	6	101
● + 505.16875	6	101
● + 505.16876	6	101
● + 505.16877	6	101
● 505.2420	6	107
● + 505.2421	6	107
● + 505.2620	6	107
● + 505.2621	6	107
● + 505.3270	6	101
● + 505.3272	6	101
● + 505.3274	6	101
● + 505.3275	6	101
● + 505.3278	6	101
● + 505.3279	6	101
● + 505.3283	6	101

505		
Cat.numb.	Pack qty.	Page
● + 505.32832	6	101
● + 505.32833	6	101
● + 505.32834	6	101
● + 505.32836	6	101
● + 505.32838	6	101
● + 505.3286	6	101
● + 505.32861	6	101
● + 505.32862	6	101
● + 505.32864	6	101
● + 505.32865	6	101
● + 505.32866	6	101
● + 505.32867	6	101
● + 505.3287	6	101
● + 505.32872	6	101
● + 505.32874	6	101
● + 505.32875	6	101
● + 505.32876	6	101
● + 505.32877	6	101
● ✓ 505.6370		101
● ✓ 505.6372		101
● ✓ 505.6374		101
● ✓ 505.6375		101
● ✓ 505.6378		101
● ✓ 505.6379	16	101
● ✓ 505.6383	16	101
● ✓ 505.63833		101
● ✓ 505.63834		101
● ✓ 505.63836		101
● ✓ 505.6386	16	101
● ✓ 505.63865		101
● ✓ 505.63866		101
● ✓ 505.63867		101
● ✓ 505.6387	16	101
● ✓ 505.63875		101
● ✓ 505.63876		101
● ✓ 505.63877		101

506		
Cat.numb.	Pack qty.	Page
● + 506.1670	6	105
● + 506.1672	6	105
● + 506.1674	6	105
● + 506.1675	6	105
● + 506.1678	6	105
● + 506.1679	6	105
● 506.1683	6	105
● + 506.16832	6	105
● + 506.16833	6	105
● + 506.16834	6	105
● + 506.16836	6	105
● + 506.16838	6	105
● + 506.1686	6	105
● + 506.16861	6	105
● + 506.16862	6	105
● + 506.16864	6	105
● + 506.16865	6	105
● + 506.16866	6	105
● + 506.16867	6	105
● + 506.1687	6	105
● + 506.16872	6	105

506		
Cat.numb.	Pack qty.	Page
● + 506.16874	6	105
● + 506.16875	6	105
● + 506.16876	6	105
● + 506.16877	6	105
● ✓ 506.3270	6	105
● ✓ 506.3272	6	105
● ✓ 506.3274	6	105
● ✓ 506.3275	6	105
● ✓ 506.3278	6	105
● ✓ 506.3279	6	105
● ✓ 506.3283	6	105
● ✓ 506.3286	6	105
● ✓ 506.3287	6	105

512		
Cat.numb.	Pack qty.	Page
● 512.1650	1050	78
● + 512.1651	1050	78
● + 512.1652	1050	78
● 512.1653	1050	78
● 512.1654	1050	78
● + 512.1655	1050	78
● 512.1656	1050	78
● 512.1657	1050	78
● ✓ 512.1657-7	10	201
● 512.1658	1050	78
● 512.3250	1040	78
● + 512.3251	1040	78
● + 512.3252	1040	78
● 512.3253	1040	78
● 512.3254	1040	78
● + 512.3255	1040	78
● 512.3256	1040	78
● 512.3257	1040	78
● ✓ 512.3257-7	10	201
● + 512.3258	1040	78

513		
Cat.numb.	Pack qty.	Page
● 513.1650	1040	72
● 513.1650T	1040	73
● 513.1650TF	1040	74
● + 513.1650TH	1040	76
● + 513.1651T	1040	73
● + 513.1652T	1040	73
● 513.1653	1040	72
● ✓ 513.1653-1FNS	8	87
● ✓ 513.1653-2AFS	8	87
● ✓ 513.1653-2FNS	8	87
● ✓ 513.1653-AF	10	77
● + 513.1653-BN	10	77
● 513.1653-CF	10	77
● 513.1653-DN	10	77
● 513.1653-FN	10	77
● ✓ 513.1653-KN	10	77
● + 513.1653-LN	10	77
● 513.1653-PN	10	77
● + 513.16532T	1040	73

513		
Cat.numb.	Pack qty.	Page
● + 513.16533T	1040	73
● + 513.16534T	1040	73
● + 513.16536T	1040	73
● + 513.16538T	1040	73
● 513.1653T	1040	73
● 513.1653TF	1040	74
● + 513.1653TH	1040	76
● ✓ 513.1653TS	10	86
● + 513.1654T	1040	73
● 513.1654TF	1040	74
● + 513.1654TH	1040	76
● + 513.1655T	1040	73
● 513.1656	1040	72
● ✓ 513.1656-1FNR	8	88
● ✓ 513.1656-1FNS	8	87
● ✓ 513.1656-2AFS	8	87
● ✓ 513.1656-2FNR	8	88
● ✓ 513.1656-2FNS	8	87
● ✓ 513.1656-AF	10	77
● + 513.1656-BN	10	77
● 513.1656-CF	10	77
● 513.1656-DN	10	77
● 513.1656-FN	10	77
● ✓ 513.1656-KN	10	77
● + 513.1656-LN	10	77
● 513.1656-PN	10	77
● + 513.16561T	1040	73
● + 513.16562T	1040	73
● + 513.16564T	1040	73
● + 513.16565T	1040	73
● + 513.16566T	1040	73
● + 513.16567T	1040	73
● 513.1656T	1040	73
● 513.1656TF	1040	74
● + 513.1656TH	1040	76
● ✓ 513.1656TS	10	86
● 513.1657	1040	72
● ✓ 513.1657-1FNR	8	88
● ✓ 513.1657-1FNS	8	87
● ✓ 513.1657-2AFS	8	87
● ✓ 513.1657-2FNR	8	88
● ✓ 513.1657-2FNS	8	87
● ✓ 513.1657-AF	10	77
● + 513.1657-BN	10	77
● 513.1657-CF	10	77
● 513.1657-DN	10	77
● 513.1657-FN	10	77
● ✓ 513.1657-KN	10	77
● + 513.1657-LN	10	77
● 513.1657-PN	10	77
● + 513.16572T	1040	73
● + 513.16574T	1040	73
● + 513.16575T	1040	73
● + 513.16576T	1040	73
● + 513.16577T	1040	73
● 513.1657T	1040	73
● 513.1657TF	1040	74
● + 513.1657TH	1040	76
● ✓ 513.1657TS	10	86
● + 513.1658T	1040	73
● 513.1658TF	1040	74
● + 513.1658TH	1040	76

513		
Cat.numb.	Pack qty.	Page
● 513.3250	10	72
● + 513.3250T	10	73
● 513.3250TF	10	74
● + 513.3251T	10	73
● + 513.3252T	10	73
● 513.3253	10	72
● ✓ 513.3253-1FFS	8	87
● ✓ 513.3253-2AFS	8	87
● ✓ 513.3253-2FFS	8	87
● ✓ 513.3253-AF	10	77
● + 513.3253-BF	10	77
● 513.3253-CF	10	77
● 513.3253-DF	10	77
● 513.3253-FF	10	77
● ✓ 513.3253-KF	10	77
● + 513.3253-LF	10	77
● 513.3253-PF	10	77
● + 513.32532T	10	73
● + 513.32533T	10	73
● + 513.32534T	10	73
● + 513.32536T	10	73
● + 513.32538T	10	73
● 513.3253T	10	73
● 513.3253TF	10	74
● ✓ 513.3253TS	10	86
● ✓ 513.3253TS.A	10	86
● + 513.3254T	10	73
● 513.3254TF	10	74
● + 513.3255T	10	73
● 513.3256	10	72
● ✓ 513.3256-1FFR	8	88
● ✓ 513.3256-1FFS	8	87
● ✓ 513.3256-2AFS	8	87
● ✓ 513.3256-2FFR	8	88
● ✓ 513.3256-2FFS	8	87
● ✓ 513.3256-AF	10	77
● + 513.3256-BF	10	77
● 513.3256-CF	10	77
● 513.3256-DF	10	77
● 513.3256-FF	10	77
● ✓ 513.3256-KF	10	77
● + 513.3256-LF	10	77
● 513.3256-PF	10	77
● + 513.32561T	10	73
● + 513.32562T	10	73
● + 513.32564T	10	73
● + 513.32565T	10	73
● + 513.32566T	10	73
● + 513.32567T	10	73
● 513.3256T	10	73
● 513.3256TF	10	74
● ✓ 513.3256TS	10	86
● ✓ 513.3256TS.A	10	86
● 513.3257	10	72
● ✓ 513.3257-1FFR	8	88
● ✓ 513.3257-1FFS	8	87
● ✓ 513.3257-2AFS	8	87
● ✓ 513.3257-2FFR	8	88
● ✓ 513.3257-2FFS	8	87
● ✓ 513.3257-AF	10	77
● + 513.3257-BF	10	77
● 513.3257-CF	10	77

513		
Cat.numb.	Pack qty.	Page
● 513.3257-DF	10	77
● 513.3257-FF	10	77
● ✓ 513.3257-KF	10	77
● + 513.3257-LF	10	77
● 513.3257-PF	10	77
● + 513.32572T	10	73
● + 513.32574T	10	73
● + 513.32575T	10	73
● + 513.32576T	10	73
● + 513.32577T	10	73
● 513.3257T	10	73
● 513.3257TF	10	74
● ✓ 513.3257TS	10	86
● ✓ 513.3257TS.A	10	86
● + 513.3258T	10	73
● 513.3258TF	10	74
● ✓ 513.6350T	4	75
● ✓ 513.6351T	4	75
● ✓ 513.6352T	4	75
● ✓ 513.63532T	75	
● ✓ 513.63533T	75	
● ✓ 513.63534T	75	
● ✓ 513.63536T	75	
● ✓ 513.63538T	75	
● ✓ 513.6353T	4	75
● ✓ 513.6354T	4	75
● ✓ 513.6355T	4	75
● ✓ 513.63561T	75	
● ✓ 513.63562T	75	
● ✓ 513.63564T	75	
● ✓ 513.63565T	75	
● ✓ 513.63566T	75	
● ✓ 513.63567T	75	
● ✓ 513.6356T	4	75
● ✓ 513.63572T	75	
● ✓ 513.63574T	75	
● ✓ 513.63575T	75	
● ✓ 513.63576T	75	
● ✓ 513.63577T	75	
● ✓ 513.6357T	4	75
● ✓ 513.6358T	4	75

517		
Cat.numb.	Pack qty.	Page
● + 517.1650	10/50	84
● + 517.1651	10/50	84
● + 517.1652	10/40	84
● 517.1653	10/50	84
● 517.1654	10/50	84
● + 517.1655	10/40	84
● 517.1656	10/50	84
● 517.1657	10/40	84
● ✓ 517.1657-7	5	201
● + 517.1658	10/50	84
● + 517.3250	10/40	84
● + 517.3251	10/40	84
● + 517.3252	10/40	84
● 517.3253	10/40	84
● + 517.3254	10/40	84
● + 517.3255	10/40	84

517		
Cat.numb.	Pack qty.	Page
● 517.3256	10/40	84
● 517.32564	10/40	84
● 517.3257	10/40	84
● ✓ 517.3257-7	5	201
● + 517.3258	10/40	84

518		
Cat.numb.	Pack qty.	Page
● ✓ 518.12550T	1/4	82
● ✓ 518.12551T	1/4	82
● ✓ 518.12552T	1/4	82
● ✓ 518.125532T	82	
● ✓ 518.125533T	82	
● ✓ 518.125534T	82	
● ✓ 518.125536T	82	
● ✓ 518.125538T	82	
● ✓ 518.12553T	1/4	82
● ✓ 518.12554T	1/4	82
● ✓ 518.12555T	1/4	82
● ✓ 518.125561T	82	
● ✓ 518.125562T	82	
● ✓ 518.125564T	82	
● ✓ 518.125565T	82	
● ✓ 518.125566T	82	
● ✓ 518.125567T	82	
● ✓ 518.12556T	1/4	82
● ✓ 518.125572T	82	
● ✓ 518.125574T	82	
● ✓ 518.125575T	82	
● ✓ 518.125576T	82	
● ✓ 518.125577T	82	
● ✓ 518.12557T	1/4	82
● ✓ 518.12558T	1/4	82
● 518.1650T	10/40	80
● 518.1650TF	10/40	81
● + 518.1650TH	10/40	83
● + 518.1651T	10/40	80
● + 518.1652T	10/40	80
● + 518.16532T	10/40	80
● + 518.16533T	10/40	80
● + 518.16534T	10/40	80
● + 518.16536T	10/40	80
● + 518.16538T	10/40	80
● 518.1653T	10/40	80
● 518.1653TF	10/40	81
● + 518.1653TH	10/40	83
● ✓ 518.1653TS	10	89
● + 518.1654T	10/40	80
● 518.1654TF	10/40	81
● + 518.1654TH	10/40	83
● + 518.1655T	10/40	80
● + 518.16561T	10/40	80
● + 518.16562T	10/40	80
● + 518.16564T	10/40	80
● + 518.16565T	10/40	80
● + 518.16566T	10/40	80
● + 518.16567T	10/40	80
● 518.1656T	10/40	80
● 518.1656TF	10/40	81
● + 518.1656TH	10/40	83

518		
Cat.numb.	Pack qty.	Page
● ✓ 518.1656TS	10	89
● + 518.16572T	10/40	80
● + 518.16574T	10/40	80
● + 518.16575T	10/40	80
● + 518.16576T	10/40	80
● + 518.16577T	10/40	80
● 518.1657T	10/40	80
● 518.1657TF	10/40	81
● + 518.1657TH	10/40	83
● ✓ 518.1657TS	10	89
● + 518.1658T	10/40	81
● 518.1658TF	10/40	81
● + 518.1658TH	10/40	83
● + 518.3250T	10	80
● 518.3250TF	10	81
● + 518.3251T	10	80
● + 518.3252T	10	80
● + 518.32532T	10	80
● + 518.32533T	10	80
● + 518.32534T	10	80
● + 518.32536T	10	80
● + 518.32538T	10	80
● 518.3253T	10	80
● 518.3253TF	10	81
● ✓ 518.3253TS	10	89
● ✓ 518.3253TS.A	10	89
● + 518.3254T	10	80
● 518.3254TF	10	81
● + 518.3255T	10	80
● + 518.32561T	10	80
● + 518.32562T	10	80
● + 518.32564T	10	80
● 518.32564TF	10	81
● + 518.32565T	10	80
● 518.32566T	10	80
● + 518.32567T	10	80
● 518.3256T	10	80
● 518.3256TF	10	81
● ✓ 518.3256TS	10	89
● ✓ 518.3256TS.A	10	89
● + 518.32572T	10	80
● + 518.32574T	10	80
● + 518.32575T	10	80
● + 518.32576T	10	80
● + 518.32577T	10	80
● 518.3257T	10	80
● 518.3257TF	10	81
● ✓ 518.3257TS	10	89
● ✓ 518.3257TS.A	10	89
● + 518.3258T	10	80
● 518.3258TF	10	81
● ✓ 518.6350T	4	82
● ✓ 518.6351T	4	82
● ✓ 518.6352T	4	82
● ✓ 518.63532T	82	
● ✓ 518.63533T	82	
● ✓ 518.63534T	82	
● ✓ 518.63536T	82	
● ✓ 518.63538T	82	
● ✓ 518.6353T	4	82
● ✓ 518.6354T	4	82
● ✓ 518.6355T	4	82



## Index by product number

518		
Cat.numb.	Pack qty.	Page
● ✓ 518.63561T		82
● ✓ 518.63562T		82
● ✓ 518.63564T		82
● ✓ 518.63565T		82
● ✓ 518.63566T		82
● ✓ 518.63567T		82
● ✓ 518.6356T	4	82
● ✓ 518.63572T		82
● ✓ 518.63574T		82
● ✓ 518.63575T		82
● ✓ 518.63576T		82
● ✓ 518.63577T		82
● ✓ 518.6357T	4	82
● ✓ 518.6358T	4	82

522		
Cat.numb.	Pack qty.	Page
● + 522.1650	10/50	79
● + 522.1651	10/50	79
● + 522.1652	10/50	79
● 522.1653	10/50	79
● 522.1654	10/50	79
● + 522.1655	10/50	79
● 522.1656	10/50	79
● 522.1657	10/50	79
● + 522.1658	10/50	79
● + 522.3250	10/40	79
● + 522.3251	10/40	79
● + 522.3252	10/40	79
● 522.3253	10/40	79
● + 522.3254	10/40	79
● + 522.3255	10/40	79
● 522.3256	10/40	79
● 522.3257	10/40	79
● + 522.3258	10/40	79

527		
Cat.numb.	Pack qty.	Page
● + 527.1650	10/50	85
● + 527.1651	10/50	85
● + 527.1652	10/50	85
● 527.1653	10/50	85
● + 527.1654	10/50	85
● + 527.1655	10/50	85
● 527.1656	10/50	85
● 527.1657	10/50	85
● + 527.1658	10/50	85
● + 527.3250	10/40	85
● + 527.3251	10/40	85
● + 527.3252	10/40	85
● 527.3253	10/40	85
● + 527.3254	10/40	85
● + 527.3255	10/40	85
● 527.3256	10/40	85
● 527.3257	10/40	85
● + 527.3258	10/40	85

530		
Cat.numb.	Pack qty.	Page
● 530.01610	10/50	160
● + 530.01611	10/50	160
● + 530.016110	10/50	160
● + 530.016112	10/50	160
● + 530.016114	10/50	160
● + 530.016115	10/50	160
● + 530.01612	10/50	160
● + 530.01613	10/50	160
● + 530.016130	10/50	160
● + 530.016132	10/50	160
● + 530.016134	10/50	160
● + 530.016135	10/50	160
● 530.01614	10/50	160
● + 530.03210	10/50	161
● + 530.03211	10/50	161
● + 530.032110	10/50	161
● + 530.032112	10/50	161
● + 530.032114	10/50	161
● + 530.032115	10/50	161
● + 530.03212	10/50	161
● + 530.03213	10/50	161
● + 530.032130	10/50	161
● + 530.032132	10/50	161
● + 530.032134	10/50	161
● + 530.032135	10/50	161
● + 530.03214	10/50	161
● 530.1610	10/50	160
● 530.1611	10/50	160
● + 530.16110	10/50	160
● + 530.16112	10/50	160
● + 530.16114	10/50	160
● + 530.16115	10/50	160
● + 530.1612	10/50	160
● + 530.1613	10/50	160
● + 530.16130	10/50	160
● + 530.16132	10/50	160
● + 530.16134	10/50	160
● + 530.16135	10/50	160
● + 530.1614	10/50	160
● + 530.3210	10/50	160
● + 530.3211	10/50	160
● + 530.32110	10/50	160
● + 530.32112	10/50	160
● + 530.32114	10/50	160
● + 530.32115	10/50	160
● + 530.3212	10/50	160
● + 530.3213	10/50	160
● + 530.32130	10/50	160
● + 530.32132	10/50	160
● + 530.32134	10/50	160
● + 530.32135	10/50	160
● + 530.3214	10/50	160

535		
Cat.numb.	Pack qty.	Page
● 535.01610	10/50	161
● + 535.01611	10/50	161
● + 535.016110	10/50	161
● + 535.016112	10/50	161
● + 535.016114	10/50	161

535		
Cat.numb.	Pack qty.	Page
● + 535.016115	10/50	161
● + 535.01612	10/50	161
● + 535.01613	10/50	161
● + 535.016130	10/50	161
● + 535.016132	10/50	161
● + 535.016134	10/50	161
● + 535.016135	10/50	161
● + 535.01614	10/50	161
● 535.03210	10/50	161
● 535.03211	10/50	161
● + 535.032110	10/50	161
● + 535.032112	10/50	161
● + 535.032114	10/50	161
● + 535.032115	10/50	161
● + 535.03212	10/50	161
● + 535.03213	10/50	161
● + 535.032130	10/50	161
● + 535.032132	10/50	161
● + 535.032134	10/50	161
● + 535.032135	10/50	161
● + 535.03214	10/50	161
● 535.1610	10/50	161
● + 535.1611	10/50	161
● + 535.16110	10/50	161
● + 535.16112	10/50	161
● + 535.16114	10/50	161
● + 535.16115	10/50	161
● + 535.1612	10/50	161
● + 535.1613	10/50	161
● + 535.16130	10/50	161
● + 535.16132	10/50	161
● + 535.16134	10/50	161
● + 535.16135	10/50	161
● + 535.1614	10/50	161
● + 535.3210	10/50	161
● + 535.3211	10/50	161
● + 535.32110	10/50	161
● + 535.32112	10/50	161
● + 535.32114	10/50	161
● + 535.32115	10/50	161
● + 535.3212	10/50	161
● + 535.3213	10/50	161
● + 535.32130	10/50	161
● + 535.32135	10/50	161
● + 535.3214	10/50	161

560		
Cat.numb.	Pack qty.	Page
● + 560.1670	1/12	118
● + 560.1672	1/12	118
● + 560.1674	1/12	118
● + 560.1675	1/12	118
● + 560.1678	1/12	118
● + 560.1679	1/12	118
● 560.1683	1/12	118
● + 560.16832	1/12	118
● + 560.16833	1/12	118
● + 560.16834	1/12	118

560		
Cat.numb.	Pack qty.	Page
● + 560.16836	1/12	118
● + 560.16838	1/12	118
● 560.1686	1/12	118
● + 560.16861	1/12	118
● + 560.16862	1/12	118
● + 560.16864	1/12	118
● + 560.16865	1/12	118
● + 560.16866	1/12	118
● + 560.16867	1/12	118
● 560.1687	1/12	118
● + 560.16872	1/12	118
● + 560.16874	1/12	118
● + 560.16875	1/12	118
● + 560.16876	1/12	118
● + 560.16877	1/12	118
● + 560.3270	1/12	118
● + 560.3272	1/12	118
● + 560.3274	1/12	118
● + 560.3275	1/12	118
● + 560.3278	1/12	118
● + 560.3279	1/12	118
● + 560.3283	1/12	118
● + 560.32832	1/12	118
● + 560.32833	1/12	118
● + 560.32834	1/12	118
● + 560.32836	1/12	118
● + 560.32838	1/12	118
● + 560.3286	1/12	118
● + 560.32861	1/12	118
● + 560.32862	1/12	118
● + 560.32864	1/12	118
● + 560.32865	1/12	118
● + 560.32866	1/12	118
● + 560.32867	1/12	118
● + 560.3287	1/12	118
● + 560.32872	1/12	118
● + 560.32874	1/12	118
● + 560.32875	1/12	118
● + 560.32876	1/12	118
● + 560.32877	1/12	118

561		
Cat.numb.	Pack qty.	Page
● + 561.1670	1/12	119
● + 561.1672	1/12	119
● + 561.1674	1/12	119
● + 561.1675	1/12	119
● + 561.1678	1/12	119
● + 561.1679	1/12	119
● 561.1683	1/12	119
● + 561.16832	1/12	119
● + 561.16833	1/12	119
● + 561.16834	1/12	119
● + 561.16836	1/12	119
● + 561.16838	1/12	119
● 561.1686	1/12	119
● + 561.16861	1/12	119
● + 561.16862	1/12	119
● + 561.16864	1/12	119
● + 561.16865	1/12	119

561		
Cat.numb.	Pack qty.	Page
● + 561.16866	1/2	119
● + 561.16867	1/2	119
● 561.1687	1/2	119
● + 561.16872	1/2	119
● + 561.16874	1/2	119
● + 561.16875	1/2	119
● + 561.16876	1/2	119
● 561.16877	1/2	119
● + 561.3270	1/2	119
● + 561.3272	1/2	119
● + 561.3274	1/2	119
● + 561.3275	1/2	119
● + 561.3278	1/2	119
● + 561.3279	1/2	119
● + 561.3283	1/2	119
● + 561.32832	1/2	119
● + 561.32833	1/2	119
● + 561.32834	1/2	119
● + 561.32836	1/2	119
● + 561.32838	1/2	119
● 561.3286	1/2	119
● + 561.32861	1/2	119
● + 561.32862	1/2	119
● + 561.32864	1/2	119
● + 561.32865	1/2	119
● + 561.32866	1/2	119
● + 561.32867	1/2	119
● + 561.3287	1/2	119
● + 561.32872	1/2	119
● + 561.32874	1/2	119
● + 561.32875	1/2	119
● + 561.32876	1/2	119
● + 561.32877	1/2	119
● + 561.6370	1/4	119
● + 561.6372	1/4	119
● + 561.6374	1/4	119
● + 561.6375	1/4	119
● + 561.6378	1/4	119
● + 561.6379	1/4	119
● 561.6383	1/4	119
● + 561.63833	1/4	119
● 561.63834	1/4	119
● + 561.63836	1/4	119
● + 561.63838	1/4	119
● 561.6386	1/4	119
● 561.63865	1/4	119
● 561.63866	1/4	119
● 561.63867	1/4	119
● 561.6387	1/4	119
● + 561.63875	1/4	119
● + 561.63876	1/4	119
● + 561.63877	1/4	119

562		
Cat.numb.	Pack qty.	Page
● + 562.1670	1/2	120
● + 562.1672	1/2	120
● 562.1674	1/2	120
● + 562.1675	1/2	120
● + 562.1678	1/2	120

562		
Cat.numb.	Pack qty.	Page
● + 562.1679	1/2	120
● 562.1683	1/2	120
● + 562.16832	1/2	120
● + 562.16833	1/2	120
● 562.16834	1/2	120
● + 562.16836	1/2	120
● + 562.16838	1/2	120
● 562.1686	1/2	120
● + 562.16861	1/2	120
● + 562.16862	1/2	120
● + 562.16864	1/2	120
● + 562.16865	1/2	120
● + 562.16866	1/2	120
● + 562.16867	1/2	120
● 562.1687	1/2	120
● + 562.16872	1/2	120
● + 562.16874	1/2	120
● + 562.16875	1/2	120
● + 562.16876	1/2	120
● + 562.16877	1/2	120
● + 562.3270	1/2	120
● + 562.3272	1/2	120
● 562.3274	1/2	120
● + 562.3275	1/2	120
● + 562.3278	1/2	120
● + 562.3279	1/2	120
● 562.3283	1/2	120
● + 562.32832	1/2	120
● + 562.32833	1/2	120
● + 562.32834	1/2	120
● + 562.32836	1/2	120
● + 562.32838	1/2	120
● 562.3286	1/2	120
● + 562.32861	1/2	120
● + 562.32862	1/2	120
● + 562.32864	1/2	120
● + 562.32865	1/2	120
● + 562.32866	1/2	120
● + 562.32867	1/2	120
● 562.3287	1/2	120
● + 562.32872	1/2	120
● + 562.32874	1/2	120
● + 562.32875	1/2	120
● + 562.32876	1/2	120
● + 562.32877	1/2	120

563		
Cat.numb.	Pack qty.	Page
● + 563.1670	1/2	121
● + 563.1672	1/2	121
● + 563.1674	1/2	121
● + 563.1675	1/2	121
● + 563.1678	1/2	121
● + 563.1679	1/2	121
● + 563.1683	1/2	121
● + 563.16832	1/2	121
● + 563.16833	1/2	121
● + 563.16834	1/2	121
● + 563.16836	1/2	121
● + 563.16838	1/2	121

563		
Cat.numb.	Pack qty.	Page
● 563.1686	1/2	121
● + 563.16861	1/2	121
● + 563.16862	1/2	121
● + 563.16864	1/2	121
● + 563.16865	1/2	121
● + 563.16866	1/2	121
● + 563.16867	1/2	121
● 563.1687	1/2	121
● + 563.16872	1/2	121
● + 563.16874	1/2	121
● + 563.16875	1/2	121
● + 563.16876	1/2	121
● + 563.16877	1/2	121
● + 563.3270	1/2	121
● + 563.3272	1/2	121
● + 563.3274	1/2	121
● + 563.3275	1/2	121
● + 563.3278	1/2	121
● + 563.3279	1/2	121
● 563.3283	1/2	121
● + 563.32832	1/2	121
● + 563.32833	1/2	121
● + 563.32834	1/2	121
● + 563.32836	1/2	121
● + 563.32838	1/2	121
● 563.3286	1/2	121
● + 563.32861	1/2	121
● + 563.32862	1/2	121
● + 563.32864	1/2	121
● 563.32865	1/2	121
● + 563.32866	1/2	121
● + 563.32867	1/2	121
● 563.3287	1/2	121
● + 563.32872	1/2	121
● + 563.32874	1/2	121
● + 563.32875	1/2	121
● + 563.32876	1/2	121
● + 563.32877	1/2	121
● + 563.6370	1/4	121
● + 563.6372	1/4	121
● 563.6374	1/4	121
● + 563.6375	1/4	121
● + 563.6378	1/4	121
● + 563.6379	1/4	121
● 563.6383	1/4	121
● + 563.63833	1/4	121
● + 563.63834	1/4	121
● + 563.63838	1/4	121
● 563.6386	1/4	121
● 563.6387	1/4	121

564		
Cat.numb.	Pack qty.	Page
● + 564.1670	1/2	124
● + 564.1672	1/2	124
● + 564.1674	1/2	124
● + 564.1675	1/2	124
● + 564.1678	1/2	124
● + 564.1679	1/2	124
● 564.1683	1/2	124

564		
Cat.numb.	Pack qty.	Page
● + 564.16832	1/2	124
● + 564.16833	1/2	124
● + 564.16834	1/2	124
● + 564.16836	1/2	124
● + 564.16838	1/2	124
● + 564.1686	1/2	124
● + 564.16861	1/2	124
● + 564.16862	1/2	124
● + 564.16864	1/2	124
● + 564.16865	1/2	124
● + 564.16866	1/2	124
● + 564.16867	1/2	124
● + 564.1687	1/2	124
● + 564.16872	1/2	124
● + 564.16874	1/2	124
● + 564.16875	1/2	124
● + 564.16876	1/2	124
● + 564.16877	1/2	124
● + 564.3270	1/2	124
● + 564.3272	1/2	124
● + 564.3274	1/2	124
● + 564.3275	1/2	124
● + 564.3278	1/2	124
● + 564.3279	1/2	124
● + 564.3283	1/2	124
● + 564.32832	1/2	124
● + 564.32833	1/2	124
● + 564.32834	1/2	124
● + 564.32836	1/2	124
● + 564.32838	1/2	124
● + 564.3286	1/2	124
● + 564.32861	1/2	124
● + 564.32862	1/2	124
● + 564.32864	1/2	124
● + 564.32865	1/2	124
● + 564.32866	1/2	124
● + 564.32867	1/2	124
● + 564.3287	1/2	124
● + 564.32872	1/2	124
● + 564.32874	1/2	124
● + 564.32875	1/2	124
● + 564.32876	1/2	124
● + 564.32877	1/2	124
● + 564.6370	1/4	124
● + 564.6372	1/4	124
● + 564.6374	1/4	124
● + 564.6375	1/4	124
● + 564.6378	1/4	124
● + 564.6379	1/4	124
● + 564.6383	1/4	124
● + 564.63832	1/4	124
● + 564.63833	1/4	124
● + 564.63834	1/4	124
● + 564.63836	1/4	124
● + 564.63837	1/4	124

565		
Cat.numb.	Pack qty.	Page
● 565.2416	1/10	126

## Index by product number

565		
Cat.numb.	Pack qty.	Page
● 565.2416/S	1/10	126
● + 565.2420	1/10	127
● + 565.2420/S	1/10	127
● + 565.2421	1/10	127
● + 565.2421/S	1/10	127
● + 565.2432	1/10	127
● + 565.2432/S	1/10	127
● + 565.2433	1/10	127
● + 565.2433/S	1/10	127
● + 565.2516	1/4	126
● 565.2516/S	1/4	126

566		
Cat.numb.	Pack qty.	Page
● + 566.2416	1/10	126
● + 566.2416/S	1/10	126
● + 566.2420	1/10	127
● + 566.2420/S	1/10	127
● + 566.2421	1/10	127
● + 566.2421/S	1/10	127
● + 566.2432	1/10	127
● + 566.2432/S	1/10	127
● + 566.2433	1/10	127
● + 566.2433/S	1/10	127
● + 566.2516	1/4	126
● 566.2516/S	1/4	126

567		
Cat.numb.	Pack qty.	Page
● + 567.1670	1/4	122
● + 567.1672	1/4	122
● + 567.1674	1/4	122
● + 567.1675	1/4	122
● + 567.1678	1/4	122
● + 567.1679	1/4	122
● 567.1683	1/4	122
● 567.16832	1/4	122
● 567.16833	1/4	122
● + 567.16834	1/4	122
● + 567.16836	1/4	122
● + 567.16838	1/4	122
● + 567.1686	1/4	122
● + 567.16861	1/4	122
● + 567.16862	1/4	122
● + 567.16864	1/4	122
● + 567.16865	1/4	122
● + 567.16866	1/4	122
● + 567.16867	1/4	122
● + 567.1687	1/4	122
● + 567.16872	1/4	122
● + 567.16874	1/4	122
● + 567.16875	1/4	122
● + 567.16876	1/4	122
● + 567.16877	1/4	122
● + 567.3270	1/4	122
● + 567.3272	1/4	122
● + 567.3274	1/4	122
● + 567.3275	1/4	122

567		
Cat.numb.	Pack qty.	Page
● + 567.3278	1/4	122
● + 567.3279	1/4	122
● + 567.3283	1/4	122
● + 567.32832	1/4	122
● + 567.32833	1/4	122
● + 567.32834	1/4	122
● + 567.32836	1/4	122
● + 567.32838	1/4	122
● + 567.3286	1/4	122
● + 567.32861	1/4	122
● + 567.32862	1/4	122
● + 567.32864	1/4	122
● + 567.32865	1/4	122
● + 567.32866	1/4	122
● + 567.32867	1/4	122
● 567.3287	1/4	122
● + 567.32872	1/4	122
● + 567.32874	1/4	122
● + 567.32875	1/4	122
● + 567.32876	1/4	122
● + 567.32877	1/4	122

568		
Cat.numb.	Pack qty.	Page
● + 568.1670	1/4	123
● + 568.1672	1/4	123
● + 568.1674	1/4	123
● + 568.1675	1/4	123
● + 568.1678	1/4	123
● + 568.1679	1/4	123
● 568.1683	1/4	123
● 568.16832	1/4	123
● 568.16833	1/4	123
● 568.16834	1/4	123
● 568.16836	1/4	123
● 568.16838	1/4	123
● 568.1686	1/4	123
● 568.16861	1/4	123
● 568.16862	1/4	123
● 568.16864	1/4	123
● 568.16865	1/4	123
● 568.16866	1/4	123
● + 568.16867	1/4	123
● 568.1687	1/4	123
● 568.16872	1/4	123
● 568.16874	1/4	123
● 568.16875	1/4	123
● 568.16876	1/4	123
● 568.16877	1/4	123
● + 568.3270	1/4	123
● + 568.3272	1/4	123
● + 568.3274	1/4	123
● + 568.3275	1/4	123
● + 568.3278	1/4	123
● + 568.3279	1/4	123
● 568.3283	1/4	123
● 568.32832	1/4	123
● 568.32833	1/4	123
● 568.32834	1/4	123
● 568.32836	1/4	123

568		
Cat.numb.	Pack qty.	Page
● 568.32838	1/4	123
● 568.3286	1/4	123
● 568.32861	1/4	123
● 568.32862	1/4	123
● + 568.32864	1/4	123
● 568.32865	1/4	123
● 568.32866	1/4	123
● 568.32867	1/4	123
● 568.3287	1/4	123
● 568.32872	1/4	123
● 568.32874	1/4	123
● 568.32875	1/4	123
● 568.32876	1/4	123
● 568.32877	1/4	123
● + 568.6370	1/4	123
● + 568.6372	1/4	123
● + 568.6374	1/4	123
● + 568.6375	1/4	123
● + 568.6378	1/4	123
● + 568.6379	1/4	123
● + 568.6383	1/4	123
● 568.63833	1/4	123
● 568.63834	1/4	123
● 568.63838	1/4	123
● 568.6386	1/4	123
● 568.6387	1/4	123

569		
Cat.numb.	Pack qty.	Page
● + 569.1670	1/4	125
● + 569.1672	1/4	125
● + 569.1674	1/4	125
● + 569.1675	1/4	125
● + 569.1678	1/4	125
● + 569.1679	1/4	125
● + 569.1683	1/4	125
● + 569.16832	1/4	125
● + 569.16833	1/4	125
● + 569.16834	1/4	125
● + 569.16836	1/4	125
● + 569.16838	1/4	125
● 569.1686	1/4	125
● 569.16861	1/4	125
● + 569.16862	1/4	125
● + 569.16864	1/4	125
● + 569.16865	1/4	125
● + 569.16866	1/4	125
● + 569.16867	1/4	125
● + 569.1687	1/4	125
● + 569.16872	1/4	125
● + 569.16874	1/4	125
● + 569.16875	1/4	125
● + 569.16876	1/4	125
● + 569.16877	1/4	125
● + 569.3270	1/4	125
● + 569.3272	1/4	125
● + 569.3274	1/4	125
● + 569.3275	1/4	125
● + 569.3278	1/4	125
● + 569.3279	1/4	125

569		
Cat.numb.	Pack qty.	Page
● + 569.3283	1/4	125
● + 569.32832	1/4	125
● + 569.32833	1/4	125
● + 569.32834	1/4	125
● + 569.32836	1/4	125
● + 569.32838	1/4	125
● + 569.3286	1/4	125
● 569.32861	1/4	125
● + 569.32862	1/4	125
● 569.32864	1/4	125
● 569.32865	1/4	125
● + 569.32866	1/4	125
● + 569.32867	1/4	125
● 569.3287	1/4	125
● 569.32872	1/4	125
● + 569.32874	1/4	125
● + 569.32875	1/4	125
● + 569.32876	1/4	125
● + 569.32877	1/4	125
● + 569.6370	1/4	125
● + 569.6372	1/4	125
● + 569.6374	1/4	125
● + 569.6375	1/4	125
● + 569.6378	1/4	125
● + 569.6379	1/4	125
● + 569.6383	1/4	125
● 569.63832	1/4	125
● + 569.63833	1/4	125
● 569.63834	1/4	125
● + 569.63838	1/4	125
● + 569.6386	1/4	125
● + 569.6387	1/4	125

570		
Cat.numb.	Pack qty.	Page
● 570.0016	10/100	94
● 570.0032	10	94
● 570.0116	10	94
● 570.0116.20	10	94
● + 570.0116.25	10	94
● 570.0132	10	94
● + 570.0132.32	10	94
● + 570.2001	10/100	92
● + 570.2041	10/100	90
● 570.2061	10/100	90
● 570.2062	10/100	90
● 570.2071	10/100	90
● 570.2081	10/100	90
● 570.2091	10/100	90
● + 570.2092	10/100	90
● 570.2093	10/100	90
● + 570.2561	10/100	90
● + 570.2591	10/100	90
● + 570.4041	10/100	90
● 570.4051	10/100	90
● 570.4061	10/100	90
● 570.4062	10/100	90
● + 570.4062-SW	10/100	0
● 570.4071	10/100	90
● 570.4081	10/100	90

570		
Cat.num.	Pack qty.	Page
● 570.4091	10/100	90
● ✓ 570.4092	10/100	90
● 570.4093	10/100	90
● + 570.4141	9/90	90
● + 570.4151	9/90	90
● 570.4161	9/90	90
● 570.4162	9/90	90
● + 570.4171	9/90	90
● + 570.4181	9/90	90
● + 570.4191	9/90	90
● ✓ 570.4192	9/90	90
● + 570.4193	9/90	90
● 570.5012	10/100	92
● 570.5052	10/100	92
● + 570.6001	1/12	93
● 570.6011	5	93
● + 570.6403	1/12	93
● + 570.6404	1/12	93
● + 570.6405	1/12	93
● + 570.6407	1/12	93
● + 570.6411	1/12	93
● + 570.6413	1/12	93
● + 570.6414	1/12	93
● + 570.6417	1/12	93
● 570.6421	1/12	93
● + 570.6424	1/12	93
● + 570.6427	1/12	93
● + 570.6428	1/12	93
● + 570.6481.50	1/12	93
● 570.7180	1/12	91
● + 570.80163	10/100	182
● + 570.80164	10/100	182
● + 570.80165	10/100	182
● + 570.80324	10/100	182
● + 570.80325	10/100	182
● + 570.8063	10	182
● + 570.8125	10	182
● + 570.90163	10/100	43
● + 570.90164	10/100	43
● + 570.90165	10/100	43
● + 570.90324	10/100	43
● + 570.90325	10/100	43
● + 570.9063	10	43
● + 570.9125	10	43
● + 570.M0125	6	94
● 570.M0163	6	94

572		
Cat.num.	Pack qty.	Page
● 572.0120	6	113
● 572.0200	6	110
● 572.0205	6	110
● 572.0210	6/60	110
● 572.0220	6/60	110
● ✓ 572.0308	1/6	111
● ✓ 572.0309	6	111
● 572.0310	6	111
● 572.0311	1	112
● 572.0312	1	113
● 572.0313	1	112

572		
Cat.num.	Pack qty.	Page
● 572.0314	1	113
● 572.0315	1	112
● 572.0316	1	113
● + 572.0320	1/6	111
● + 572.0322	1/10	111
● + 572.0330	4	114
● + 572.3390	6	111

576		
Cat.num.	Pack qty.	Page
● 576.4300	12	128
● 576.4301	12	128
● 576.4302	6	129
● 576.4303	12	129
● 576.4304	6	129
● 576.4305	6	129
● 576.4321	12	128
● 576.4322	6	129
● 576.4323	12	129
● 576.4324	6	129
● 576.4325	6	129
● 576.4340	6	128
● + 576.4390	6	129

578		
Cat.num.	Pack qty.	Page
● 578.4300	12	130
● 578.4301	12	130
● 578.4302	6	131
● 578.4304	6	131
● 578.4305	6	131
● 578.4321	12	130
● 578.4322	6	131
● 578.4324	6	131
● 578.4325	6	131
● 578.4340	6	130

579		
Cat.num.	Pack qty.	Page
● + 579.0021		145
● + 579.0022		145
● + 579.0030		145
● + 579.0031		145
● + 579.0040		145
● + 579.0100	12	146
● 579.0125	1	146
● 579.0200	1/12	146
● 579.0201	1/12	146
● 579.0332	12	146
● + 579.0400	12	147
● ✓ 579.0450	10	147
● 579.5001	10	147
● 579.5100	1	143
● 579.5110	1	143
● 579.5111	1	144
● 579.5120	1	143

579		
Cat.num.	Pack qty.	Page
● 579.5121	1	144
● 579.5200	1	143
● 579.5210	1	143
● 579.5211	1	144

590		
Cat.num.	Pack qty.	Page
● + 590.BK040	12	262
● + 590.BK040H	12	262
● + 590.BK080	5	262
● + 590.BK080H	5	262
● + 590.DC0416	6	224
● + 590.DC0815	6	224
● + 590.DC0820	6	224
● + 590.DC0825	6	224
● + 590.DC0830	6	224
● + 590.DC0840	6	224
● 590.DCGE0416	1/12	253
● 590.DCGE0815	1/10	253
● 590.DCGE0820	1/10	253
● 590.DCGE0825	1/5	253
● 590.DCGE0830	1/5	253
● 590.DCGE0840	1	253
● + 590.EL10003	1/5	241
● + 590.EL10005	1/5	241
● + 590.EL1606	1/5	239
● + 590.EL1608	1/5	239
● + 590.EL2012	1/12	239
● + 590.EL2013	1/12	239
● + 590.EL2015	1/12	239
● + 590.EL2506	1/5	239
● + 590.EL2508	1/5	239
● + 590.EL3206	1/5	239
● + 590.EL3208	1/5	239
● + 590.EL3212	1/12	239
● + 590.EL3213	1/12	239
● + 590.EL3215	1/12	239
● + 590.EL4006	1/5	239
● + 590.EL4008	1/5	239
● + 590.EL4012	1/12	239
● + 590.EL4013	1/12	239
● + 590.EL4015	1/12	239
● + 590.EL6302	1/5	241
● + 590.EL6303	1/5	241
● + 590.EL6305	1/5	241
● + 590.EL8002	1/5	241
● + 590.EL8003	1/5	241
● + 590.EL8005	1/5	241
● 590.EM10003	1/5	242
● + 590.EM10005	1/5	242
● + 590.EM10006	1	242
● + 590.EM10008	1	242
● + 590.EM12503	1	242
● + 590.EM12505	1	242
● + 590.EM12506	1	242
● + 590.EM12508	1	242
● + 590.EM16003	1	242
● + 590.EM16005	1	242
● + 590.EM16006	1	242
● + 590.EM16008	1	242

590		
Cat.num.	Pack qty.	Page
● 590.EM1606	1/5	240
● 590.EM1608	1/5	240
● 590.EM2002	1/12	238
● 590.EM2003	1/12	238
● 590.EM2004	1/12	238
● 590.EM2005	1/12	238
● 590.EM2012	1/12	240
● 590.EM2013	1/12	240
● 590.EM2014	1/12	240
● 590.EM2015	1/12	240
● 590.EM2506	1/5	240
● 590.EM2508	1/5	240
● 590.EM3202	1/12	238
● 590.EM3203	1/12	238
● 590.EM3204	1/12	238
● 590.EM3205	1/12	238
● 590.EM3206	1/5	240
● 590.EM3208	1/5	240
● 590.EM3212	1/12	240
● 590.EM3213	1/12	240
● 590.EM3214	1/12	240
● 590.EM3215	1/12	240
● + 590.EM4002	1/12	238
● + 590.EM4003	1/12	238
● + 590.EM4004	1/12	238
● 590.EM4005	1/12	238
● 590.EM4006	1/5	240
● 590.EM4008	1/5	240
● + 590.EM4012	1/12	240
● + 590.EM4013	1/12	240
● 590.EM4014	1/12	240
● 590.EM4015	1/12	240
● + 590.EM6302	1/5	242
● 590.EM6303	1/5	242
● 590.EM6304	1/5	242
● + 590.EM6305	1/5	242
● + 590.EM6306	1	242
● + 590.EM6308	1	242
● + 590.EM8002	1/5	242
● + 590.EM8003	1/5	242
● + 590.EM8004	1/5	242
● + 590.EM8005	1/5	242
● + 590.EM8006	1	242
● + 590.EM8008	1	242
● ✓ 590.EMB10003		254
● ✓ 590.EMB10005		254
● ✓ 590.EMB12503		254
● ✓ 590.EMB12505		254
● ✓ 590.EMB16003		254
● ✓ 590.EMB16005		254
● ✓ 590.EMB6303		254
● ✓ 590.EMB6305		254
● ✓ 590.EMB8003		254
● ✓ 590.EMB8005		254
● ✓ 590.EMD10003		254
● ✓ 590.EMD10005		254
● ✓ 590.EMD12503		254
● ✓ 590.EMD12505		254
● ✓ 590.EMD16003		254
● ✓ 590.EMD16005		254
● ✓ 590.EMD6303		254
● ✓ 590.EMD6305		254

## Index by product number

590			590			590			590		
Cat.numb.	Pack qty.	Page	Cat.numb.	Pack qty.	Page	Cat.numb.	Pack qty.	Page	Cat.numb.	Pack qty.	Page
● ✓ 590.EMD8003		254	● ✓ 590.GE3205-C	1/5	259	● ✓ 590.GEF3203		254	● + 590.HEM2004	1/12	246
● ✓ 590.EMD8005		254	● + 590.GE3206		239	● ✓ 590.GEF3204		254	● + 590.HEM2005	1/12	246
● ✓ 590.EMF1602		254	● + 590.GE3208	1/5	239	● ✓ 590.GEF3205	1	254	● + 590.HEM2506	1/5	246
● ✓ 590.EMF1603		254	● + 590.GE3212	1/12	239	● + 590.GR2002	1/12	237	● + 590.HEM2508	1/5	246
● ✓ 590.EMF1604		254	● + 590.GE3213	1/12	239	● + 590.GR2003	1/12	237	● + 590.HEM3202	1/12	246
● ✓ 590.EMF1605		254	● + 590.GE3214	1/12	239	● + 590.GR2004	1/12	237	● + 590.HEM3203	1/12	246
● ✓ 590.EMF3202		254	● + 590.GE3215	1/12	239	● + 590.GR2005	1/12	237	● 590.HEM3204	1/12	246
● ✓ 590.EMF3203		254	● + 590.GE3221	1/12	243	● + 590.GR3202	1/12	237	● + 590.HEM3205	1/12	246
● ✓ 590.EMF3204		254	● + 590.GE4002	1/12	238	● + 590.GR3203	1/12	237	● + 590.HEM3206	1/5	246
● ✓ 590.EMF3205		254	● + 590.GE4003	1/12	238	● + 590.GR3204	1/12	237	● + 590.HEM3208	1/5	246
● + 590.ER2002	1/12	237	● ✓ 590.GE4003-C	1/5	259	● + 590.GR3205	1/12	237	● + 590.HEM4002	1/12	246
● + 590.ER2003	1/12	237	● + 590.GE4004	1/12	238	● 590.GR4002	1/12	237	● 590.HEM4003	1/12	246
● + 590.ER2004	1/12	237	● + 590.GE4005	1/12	238	● 590.GR4003	1/12	237	● + 590.HEM4004	1/12	246
● + 590.ER2005	1/12	237	● ✓ 590.GE4005-C	1/5	259	● 590.GR4004	1/12	237	● + 590.HEM4005	1/12	246
● + 590.ER3202	1/12	237	● + 590.GE4006	1/5	239	● ✓ 590.GR4005	1/12	237	● + 590.HEM4006	1/5	246
● + 590.ER3203	1/12	237	● + 590.GE4008	1/5	239	● + 590.HEL10003	1/5	247	● + 590.HEM4008	1/5	246
● + 590.ER3204	1/12	237	● + 590.GE4012	1/12	239	● + 590.HEL10005	1/5	247	● + 590.HEM6302	1/5	248
● + 590.ER3205	1/12	237	● + 590.GE4013	1/12	239	● + 590.HEL1606	1/5	245	● + 590.HEM6303	1/5	248
● 590.ER4002	1/12	237	● + 590.GE4014	1/12	239	● + 590.HEL1608	1/5	245	● + 590.HEM6304	1/5	248
● 590.ER4003	1/12	237	● + 590.GE4015	1/12	239	● + 590.HEL2002	1/12	245	● + 590.HEM6305	1/5	248
● 590.ER4004	1/12	237	● 590.GE4021	1/12	243	● + 590.HEL2003	1/12	245	● + 590.HEM6306	1	248
● ✓ 590.ER4005	1/12	237	● 590.GE4021	1/12	243	● + 590.HEL2005	1/12	245	● + 590.HEM6308	1	248
● + 590.GE10003	1/5	241	● + 590.GE6302	1/5	241	● + 590.HEL2506	1/5	245	● + 590.HEM8002	1/5	248
● ✓ 590.GE10003-C	1	259	● ✓ 590.GE6303	1/5	241	● + 590.HEL2508	1/5	245	● + 590.HEM8003	1/5	248
● + 590.GE10005	1/5	241	● ✓ 590.GE6303-C	1	259	● + 590.HEL2508	1/5	245	● + 590.HEM8004	1/5	248
● ✓ 590.GE10005-C	1	259	● + 590.GE6304	1/5	241	● + 590.HEL3202	1/12	245	● + 590.HEM8005	1/5	248
● + 590.GE10006	1	241	● + 590.GE6305	1/5	241	● + 590.HEL3203	1/12	245	● + 590.HEM8006	1	248
● + 590.GE10008	1	241	● ✓ 590.GE6305-C	1	259	● + 590.HEL3205	1/12	245	● + 590.HEM8008	1	248
● + 590.GE12503	1	241	● + 590.GE6306	1	241	● + 590.HEL3206	1/5	245	● ✓ 590.HEMB6303		255
● ✓ 590.GE12503-C	1	259	● + 590.GE6308	1	241	● + 590.HEL3208	1/5	245	● ✓ 590.HEMB6305		255
● + 590.GE12505	1	241	● + 590.GE8002	1/5	241	● + 590.HEL4002	1/12	245	● ✓ 590.HEMB8003		255
● ✓ 590.GE12505-C	1	259	● + 590.GE8003	1/5	241	● + 590.HEL4003	1/12	245	● ✓ 590.HEMB8005		255
● + 590.GE12506	1	241	● ✓ 590.GE8003-C	1	259	● + 590.HEL4005	1/12	245	● ✓ 590.HEMB8005		255
● + 590.GE12508	1	241	● + 590.GE8004	1/5	241	● + 590.HEL4006	1/5	245	● ✓ 590.HEMD6303		255
● + 590.GE16003	1	241	● + 590.GE8005	1/5	241	● + 590.HEL4008	1/5	245	● ✓ 590.HEMD6305		255
● ✓ 590.GE16003-C	1	259	● ✓ 590.GE8005-C	1	259	● + 590.HEL6302	1/5	247	● ✓ 590.HEMD8003		255
● + 590.GE16005	1	241	● + 590.GE8006	1	241	● + 590.HEL6303	1/5	247	● ✓ 590.HEMD8005		255
● ✓ 590.GE16005-C	1	259	● + 590.GE8008	1	241	● + 590.HEL6305	1/5	247	● ✓ 590.HEMF1602		255
● + 590.GE16006	1	241	● ✓ 590.GEB10003		254	● + 590.HEL8002	1/5	247	● ✓ 590.HEMF1603		255
● + 590.GE16008	1	241	● ✓ 590.GEB10005		254	● + 590.HEL8003	1/5	247	● ✓ 590.HEMF1604		255
● ✓ 590.GE1603-C	1/5	259	● ✓ 590.GEB12503		254	● + 590.HEL8005	1/5	247	● ✓ 590.HEMF1605		255
● ✓ 590.GE1605-C	1/5	259	● ✓ 590.GEB12505		254	● + 590.HEM10003	1/5	248	● ✓ 590.HEMF3202		255
● + 590.GE1606	1/5	239	● ✓ 590.GEB16003		254	● ✓ 590.HEM10003.W	1	249	● ✓ 590.HEMF3203		255
● + 590.GE1608	1/5	239	● ✓ 590.GEB16005		254	● + 590.HEM10005	1/5	248	● ✓ 590.HEMF3204		255
● + 590.GE2002	1/12	238	● ✓ 590.GEB6303		254	● ✓ 590.HEM10005.W	1	249	● ✓ 590.HEMF3205		255
● + 590.GE2003	1/12	238	● ✓ 590.GEB6305		254	● + 590.HEM10006	1	248	● + 590.HGE10003	1/5	247
● + 590.GE2004	1/12	238	● ✓ 590.GEB8003		254	● + 590.HEM10008	1	248	● ✓ 590.HGE10003-C	1	260
● + 590.GE2005	1/12	238	● ✓ 590.GEB8005		254	● + 590.HEM12503	1	248	● ✓ 590.HGE10003.W	1	249
● + 590.GE2012	1/12	239	● ✓ 590.GED10003		254	● ✓ 590.HEM12503.W	1	249	● + 590.HGE10005	1/5	247
● + 590.GE2013	1/12	239	● ✓ 590.GED10005		254	● + 590.HEM12505	1	248	● ✓ 590.HGE10005-C	1	260
● 590.GE2014	1/12	239	● ✓ 590.GED12503		254	● ✓ 590.HEM12505.W	1	249	● ✓ 590.HGE10005.W	1	249
● + 590.GE2015	1/12	239	● ✓ 590.GED12505		254	● + 590.HEM12506	1	248	● + 590.HGE10006	1	247
● 590.GE2021	1/12	243	● ✓ 590.GED16003		254	● + 590.HEM12508	1	248	● + 590.HGE10008	1	247
● ✓ 590.GE2503-C	1/5	259	● ✓ 590.GED16005	1	254	● + 590.HEM16003	1	248	● + 590.HGE12503	1	247
● ✓ 590.GE2505-C	1/5	259	● ✓ 590.GED6303		254	● ✓ 590.HEM16003.W	1	249	● ✓ 590.HGE12503-C	1	260
● + 590.GE2506	1/5	239	● ✓ 590.GED6305		254	● + 590.HEM16005	1	248	● ✓ 590.HGE12503.W	1	249
● + 590.GE2508	1/5	239	● ✓ 590.GED8003		254	● + 590.HEM16005.W	1	249	● + 590.HGE12505	1	247
● + 590.GE3202	1/12	238	● ✓ 590.GED8005	1	254	● + 590.HEM16006	1	248	● ✓ 590.HGE12505-C	1	260
● + 590.GE3203	1/12	238	● ✓ 590.GEF1602		254	● + 590.HEM16008	1	248	● ✓ 590.HGE12505.W	1	249
● ✓ 590.GE3203-C	1/5	259	● ✓ 590.GEF1603		254	● + 590.HEM1606	1/5	246	● + 590.HGE12506	1	247
● + 590.GE3204	1/12	238	● ✓ 590.GEF1604		254	● + 590.HEM1608	1/5	246	● + 590.HGE12508	1	247
● + 590.GE3205	1/12	238	● ✓ 590.GEF1605		254	● + 590.HEM2002	1/12	246	● + 590.HGE16003	1	247
			● ✓ 590.GEF3202		254	● + 590.HEM2003	1/12	246	● ✓ 590.HGE16003-C	1	260



590		
Cat.num.	Pack qty.	Page
● ✓ 590.HGE16003.W	1	249
● + 590.HGE16005	1	247
● ✓ 590.HGE16005-C	1	260
● ✓ 590.HGE16005.W	1	249
● + 590.HGE16006	1	247
● + 590.HGE16008	1	247
● ✓ 590.HGE1603-C	1/5	260
● ✓ 590.HGE1605-C	1/5	260
● + 590.HGE1606	1/5	245
● + 590.HGE1608	1/5	245
● 590.HGE2002	1/12	245
● + 590.HGE2003	1/12	245
● 590.HGE2004	1/12	245
● + 590.HGE2005	1/12	245
● ✓ 590.HGE2503-C	1/5	260
● ✓ 590.HGE2505-C	1/5	260
● + 590.HGE2506	1/5	245
● + 590.HGE2508	1/5	245
● 590.HGE3202	1/12	245
● + 590.HGE3203	1/12	245
● ✓ 590.HGE3203-C	1/5	260
● 590.HGE3204	1/12	245
● + 590.HGE3205	1/12	245
● ✓ 590.HGE3205-C	1/5	260
● + 590.HGE3206	1/5	245
● + 590.HGE3208	1/5	245
● + 590.HGE4002	1/12	245
● + 590.HGE4003	1/12	245
● ✓ 590.HGE4003-C	1/5	260
● 590.HGE4004	1/12	245
● + 590.HGE4005	1/12	245
● ✓ 590.HGE4005-C	1/5	260
● + 590.HGE4006	1/5	245
● + 590.HGE4008	1/5	245
● + 590.HGE6302	1/5	247
● + 590.HGE6303	1/5	247
● ✓ 590.HGE6303-C	1	260
● 590.HGE6304	1/5	247
● + 590.HGE6305	1/5	247
● ✓ 590.HGE6305-C	1	260
● + 590.HGE6306	1	247
● + 590.HGE6308	1	247
● + 590.HGE8002	1/5	247
● + 590.HGE8003	1/5	247
● ✓ 590.HGE8003-C	1	260
● + 590.HGE8004	1/5	247
● + 590.HGE8005	1/5	247
● ✓ 590.HGE8005-C	1	260
● + 590.HGE8006	1	247
● + 590.HGE8008	1	247
● ✓ 590.HGEB6303	255	
● ✓ 590.HGEB6305	255	
● ✓ 590.HGEB8003	255	
● ✓ 590.HGEB8005	255	
● ✓ 590.HGED6303	255	
● ✓ 590.HGED6305	255	
● ✓ 590.HGED8003	255	
● ✓ 590.HGED8005	1	255
● ✓ 590.HGEF1602	255	
● ✓ 590.HGEF1603	255	
● ✓ 590.HGEF1604	255	
● ✓ 590.HGEF1605	255	

590		
Cat.num.	Pack qty.	Page
● ✓ 590.HGEF3202		255
● ✓ 590.HGEF3203		255
● ✓ 590.HGEF3204		255
● ✓ 590.HGEF3205	1	255
● + 590.JEM2002	1/12	244
● + 590.JEM2003	1/12	244
● + 590.JEM2005	1/12	244
● + 590.JEM3202	1/12	244
● + 590.JEM3203	1/12	244
● + 590.JEM3205	1/12	244
● + 590.JEM4002	1/12	244
● + 590.JEM4003	1/12	244
● + 590.JEM4005	1/12	244
● + 590.JGE2002	1/12	244
● + 590.JGE2003	1/12	244
● + 590.JGE2005	1/12	244
● + 590.JGE3202	1/12	244
● + 590.JGE3203	1/12	244
● + 590.JGE3205	1/12	244
● + 590.JGE4002	1/12	244
● + 590.JGE4003	1/12	244
● + 590.JGE4005	1/12	244
● ✓ 590.K100003B	1	223
● ✓ 590.K100005B	1	223
● ✓ 590.K125003B	1	223
● ✓ 590.K125005B	1	223
● ✓ 590.K160003B	1	223
● ✓ 590.K160005B	1	223
● ✓ 590.K16003B	1	223
● ✓ 590.K16005B	1	223
● ✓ 590.K20003B	1	223
● ✓ 590.K20005B	1	223
● ✓ 590.K25003B	1	223
● ✓ 590.K25005B	1	223
● ✓ 590.K31503B	1	223
● ✓ 590.K31505B	1	223
● ✓ 590.K40003B	1	223
● ✓ 590.K40005B	1	223
● ✓ 590.K50003B	1	223
● ✓ 590.K50005B	1	223
● ✓ 590.K63003B	1	223
● ✓ 590.K63005B	1	223
● ✓ 590.K80003B	1	223
● ✓ 590.K80005B	1	223
● ✓ 590.KEM100003	1	251
● ✓ 590.KEM100005	1	251
● ✓ 590.KEM125003	1	251
● ✓ 590.KEM125005	1	251
● ✓ 590.KEM160003	1	251
● ✓ 590.KEM160005	1	251
● ✓ 590.KEM16003	1	251
● ✓ 590.KEM16005	1	251
● ✓ 590.KEM20003	1	251
● ✓ 590.KEM20005	1	251
● ✓ 590.KEM25003	1	251
● ✓ 590.KEM25005	1	251
● ✓ 590.KEM31503	1	251
● ✓ 590.KEM31505	1	251
● ✓ 590.KEM40003	1	251
● ✓ 590.KEM40005	1	251
● ✓ 590.KEM50003	1	251
● ✓ 590.KEM50005	1	251

590		
Cat.num.	Pack qty.	Page
● ✓ 590.KEM63003	1	251
● ✓ 590.KEM63005	1	251
● ✓ 590.KEM80003	1	251
● ✓ 590.KEM80005	1	251
● ✓ 590.KEMB10003	257	
● ✓ 590.KEMB10005	257	
● ✓ 590.KEMB12503	257	
● ✓ 590.KEMB12505	257	
● ✓ 590.KEMB16003	257	
● ✓ 590.KEMB16005	257	
● ✓ 590.KEMB20003	257	
● ✓ 590.KEMB20005	257	
● ✓ 590.KEMB25003	257	
● ✓ 590.KEMB25005	257	
● ✓ 590.KEMB31503	257	
● ✓ 590.KEMB31505	257	
● ✓ 590.KEMB40003	257	
● ✓ 590.KEMB40005	257	
● ✓ 590.KEMB63003	257	
● ✓ 590.KEMB63005	257	
● ✓ 590.KEMD10003	256	
● ✓ 590.KEMD10005	256	
● ✓ 590.KEMD12503	256	
● ✓ 590.KEMD12505	256	
● ✓ 590.KEMD16003	256	
● ✓ 590.KEMD16005	256	
● ✓ 590.KEMD20003	256	
● ✓ 590.KEMD20005	256	
● ✓ 590.KEMD25003	256	
● ✓ 590.KEMD25005	256	
● ✓ 590.KEMD31503	256	
● ✓ 590.KEMD31505	256	
● ✓ 590.KEMD40003	256	
● ✓ 590.KEMD40005	256	
● ✓ 590.KEMD63003	256	
● ✓ 590.KEMD63005	256	
● ✓ 590.KFB10003B	1	225
● ✓ 590.KFB10005B	1	225
● ✓ 590.KFB12503B	1	225
● ✓ 590.KFB12505B	1	225
● ✓ 590.KFB16003B	1	225
● ✓ 590.KFB16005B	1	225
● ✓ 590.KFB20003B	1	225
● ✓ 590.KFB20005B	1	225
● ✓ 590.KFB25003B	1	225
● ✓ 590.KFB25005B	1	225
● ✓ 590.KFB31503B	1	225
● ✓ 590.KFB31505B	1	225
● ✓ 590.KFB40003B	1	225
● ✓ 590.KFB40005B	1	225
● ✓ 590.KFB63003B	1	225
● ✓ 590.KFB63005B	1	225
● ✓ 590.KFB6303B	1	225
● ✓ 590.KFB6305B	1	225
● ✓ 590.KFB8003B	1	225
● ✓ 590.KFB8005B	1	225
● ✓ 590.KFD10003B	1	226
● ✓ 590.KFD10005B	1	226
● ✓ 590.KFD12503B	1	226
● ✓ 590.KFD12505B	1	226
● ✓ 590.KFD16003B	1	226
● ✓ 590.KFD16005B	1	226

590		
Cat.num.	Pack qty.	Page
● ✓ 590.KFD20003B	1	226
● ✓ 590.KFD20005B	1	226
● ✓ 590.KFD25003B	1	226
● ✓ 590.KFD25005B	1	226
● ✓ 590.KFD31503B	1	226
● ✓ 590.KFD31505B	1	226
● ✓ 590.KFD40003B	1	226
● ✓ 590.KFD40005B	1	226
● ✓ 590.KFD63003B	1	226
● ✓ 590.KFD63005B	1	226
● ✓ 590.KFD6303B	1	226
● ✓ 590.KFD6305B	1	226
● ✓ 590.KFD8003B	1	226
● ✓ 590.KFD8005B	1	226
● ✓ 590.KFS1	1/6	235
● ✓ 590.KFS2	1/6	235
● ✓ 590.KFS3	1/10	235
● ✓ 590.KFS4	1/10	235
● ✓ 590.KFS5	1/10	235
● + 590.KGE100003	1	251
● + 590.KGE100003B	1	252
● + 590.KGE100005	1	251
● + 590.KGE100005B	252	
● + 590.KGE125003	1	251
● + 590.KGE125003B	1	252
● + 590.KGE125005	1	251
● + 590.KGE125005B	252	
● + 590.KGE160003	1	251
● + 590.KGE160003B	1	252
● + 590.KGE160005	1	251
● + 590.KGE160005B	252	
● ✓ 590.KGE16003	1	251
● ✓ 590.KGE16003B	1	252
● ✓ 590.KGE16005	1	251
● ✓ 590.KGE16005B	1	252
● + 590.KGE20003	1	251
● + 590.KGE20003B	1	252
● + 590.KGE20005	1	251
● + 590.KGE20005B	1	252
● + 590.KGE25003	1	251
● + 590.KGE25003B	1	252
● + 590.KGE25005	1	251
● + 590.KGE25005B	1	252
● + 590.KGE31503	1	251
● + 590.KGE31503B	1	252
● + 590.KGE31505	1	251
● + 590.KGE31505B	1	252
● + 590.KGE40003	1	251
● + 590.KGE40003B	1	252
● + 590.KGE40005	1	251
● + 590.KGE40005B	1	252
● + 590.KGE50003	1	251
● + 590.KGE50003B	1	252
● + 590.KGE50005	1	251
● + 590.KGE50005B	1	252
● + 590.KGE63003	1	251
● + 590.KGE63003B	1	252
● + 590.KGE63005	1	251
● + 590.KGE63005B	1	252
● + 590.KGE80003	1	251
● + 590.KGE80003B	1	252
● + 590.KGE80005	1	251

## Index by product number

590			590			590			590		
Cat.numb.	Pack qty.	Page	Cat.numb.	Pack qty.	Page	Cat.numb.	Pack qty.	Page	Cat.numb.	Pack qty.	Page
● + 590.KGEB0005B	1	252	● ✓ 590.KMM300GE	10	232	● + 590.PSCR8DOC	10	267	● + 590.SGE3202	1/12	250
● ✓ 590.KGEB10003		257	● ✓ 590.KMM500EM	10	232	● + 590.PSCR8TOC	10	267	● 590.SGE3203	1/12	250
● ✓ 590.KGEB10003B		258	● ✓ 590.KMM500GE	10	232	● 590.PSLN8D0	1/10	267	● ✓ 590.SGE3203-C	1/12	261
● ✓ 590.KGEB10005		257	● ✓ 590.KMM550EM	10	232	● + 590.PSLN8D2	1/10	267	● + 590.SGE3205	1	250
● ✓ 590.KGEB10005B		258	● ✓ 590.KMM550GE	10	232	● 590.PSLN8T0	1/10	267	● ✓ 590.SGE3205-C	1/12	261
● ✓ 590.KGEB12503		257	● ✓ 590.KMM600EM	10	232	● 590.PSLN8T3	1/10	267	● 590.SGE3206	1/12	250
● ✓ 590.KGEB12503B		258	● ✓ 590.KMM600GE	10	232	● + 590.PTA00	10/100	269	● + 590.SGE4002	1/12	250
● ✓ 590.KGEB12505		257	● ✓ 590.KMT11	10	234	● + 590.PTE/A	10/100	270	● 590.SGE4003	1	250
● ✓ 590.KGEB12505B		258	● ✓ 590.KMT12	10	234	● 590.PTE/I	10/100	270	● ✓ 590.SGE4003-C	1/12	261
● ✓ 590.KGEB16003		257	● ✓ 590.KMT21	10	234	● + 590.PTRN8	10/100	270	● + 590.SGE4005	1/12	250
● ✓ 590.KGEB16003B		258	● ✓ 590.KMT22	10	234	● 590.SEM10003	1/5	250	● ✓ 590.SGE4005-C	1/12	261
● ✓ 590.KGEB16005		257	● ✓ 590.KMT31	10	234	● + 590.SEM10005	1/5	250	● 590.SGE4006	1	250
● ✓ 590.KGEB16005B		258	● ✓ 590.KMT32	10	234	● 590.SEM10006	1/5	250	● 590.SGE6303	1	250
● ✓ 590.KGEB20003		257	● ✓ 590.KMT41	10	234	● 590.SEM12503	1/5	250	● ✓ 590.SGE6303-C	1/12	261
● ✓ 590.KGEB20003B		258	● ✓ 590.KMT42	10	234	● + 590.SEM12505	1/5	250	● + 590.SGE6305	1	250
● ✓ 590.KGEB20005		257	● ✓ 590.KMT51	10	234	● 590.SEM12506	1/5	250	● ✓ 590.SGE6305-C	1/12	261
● ✓ 590.KGEB20005B		258	● ✓ 590.KMT52	10	234	● 590.SEM16003	1	250	● 590.SGE6306	1/5	250
● ✓ 590.KGEB25003		257	● + 590.PCF	10	269	● + 590.SEM16005	1	250	● 590.SGE8003	1/5	250
● ✓ 590.KGEB25003B		258	● 590.PG1M9W01	12	272	● 590.SEM16006	1	250	● ✓ 590.SGE8003-C	1/12	261
● ✓ 590.KGEB25005		257	● + 590.PG8M9W10	12	272	● 590.SEM1606	1/12	250	● + 590.SGE8005	1/5	250
● ✓ 590.KGEB25005B		258	● 590.PL004001	10/60	117	● + 590.SEM2002	1/12	250	● ✓ 590.SGE8005-C	1/12	261
● ✓ 590.KGEB31503		257	● 590.PL004002	10/60	117	● 590.SEM2003	1/12	250	● 590.SGE8006	1/5	250
● ✓ 590.KGEB31505		257	● + 590.PL004003	10	117	● + 590.SEM2005	1	250	● + 590.YA1003B	6	221
● ✓ 590.KGEB40003		257	● + 590.PL004004	10	117	● 590.SEM2506	1/12	250	● ✓ 590.YA1003B-C	6	227
● ✓ 590.KGEB40005		257	● + 590.PL004007	10/60	268	● + 590.SEM3202	1/12	250	● + 590.YA1003R	6	222
● ✓ 590.KGEB63003		257	● 590.PL005	50	236	● 590.SEM3203	1/12	250	● + 590.YA1004B	6	221
● ✓ 590.KGEB63005		257	● 590.PL006011	10	236	● + 590.SEM3205	1	250	● + 590.YA1004R	6	222
● ✓ 590.KGED10003		256	● 590.PL006012	10	236	● 590.SEM3206	1/12	250	● + 590.YA1005B	6	221
● ✓ 590.KGED10003B		258	● 590.PL006013	10	236	● + 590.SEM4002	1/12	250	● ✓ 590.YA1005B-C	6	227
● ✓ 590.KGED10005		256	● 590.PL006021	10	236	● 590.SEM4003	1/12	250	● + 590.YA1006B	6	221
● ✓ 590.KGED10005B		258	● 590.PL006022	10	236	● + 590.SEM4005	1/12	250	● + 590.YA1008B	6	221
● ✓ 590.KGED12503		256	● 590.PL006023	10	236	● 590.SEM4006	1/12	250	● + 590.YA1253B	6	221
● ✓ 590.KGED12503B		258	● 590.PLML1L220	10	268	● 590.SEM6303	1/5	250	● ✓ 590.YA1253B-C	6	227
● ✓ 590.KGED12505		256	● 590.PLML2L220	10	268	● + 590.SEM6305	1/5	250	● 590.YA1255B	6	221
● ✓ 590.KGED12505B		258	● 590.PLML3L220	10	268	● 590.SEM6306	1/5	250	● ✓ 590.YA1255B-C	6	227
● ✓ 590.KGED16003		256	● 590.PLML4L220	10	268	● 590.SEM8003	1/5	250	● + 590.YA1256B	6	221
● ✓ 590.KGED16003B		258	● 590.PLML5L220	10	268	● + 590.SEM8005	1/5	250	● + 590.YA1258B	6	221
● ✓ 590.KGED16005	1	256	● 590.PPFN1C4N	1/10	266	● 590.SEM8006	1/5	250	● + 590.YA1603B	5	221
● ✓ 590.KGED16005B	1	258	● 590.PPFN1M4N	1/10	266	● 590.SGE10003	1/5	250	● ✓ 590.YA1603B-C	6	227
● ✓ 590.KGED20003		256	● 590.PPFN1R4N	1/10	266	● ✓ 590.SGE10003-C	1/12	261	● + 590.YA1605B	5	221
● ✓ 590.KGED20003B		258	● 590.PPFN1R6N	1/10	266	● + 590.SGE10005	1/5	250	● ✓ 590.YA1605B-C	6	227
● ✓ 590.KGED20005		256	● 590.PPRL2	1/10	266	● ✓ 590.SGE10005-C	1/12	261	● + 590.YA1606B	6	221
● ✓ 590.KGED20005B		258	● 590.PPRL5	1/10	266	● 590.SGE10006	1	250	● + 590.YA1608B	6	221
● ✓ 590.KGED25003		256	● 590.PPRN1	1/10	265	● 590.SGE12503	1/5	250	● + 590.YA162B	6	220
● ✓ 590.KGED25003B		258	● 590.PPRN2	1/10	265	● ✓ 590.SGE12503-C	1/12	261	● 590.YA162R	6	222
● ✓ 590.KGED25005	1	256	● + 590.PPRN5	1/10	265	● + 590.SGE12505	1/5	250	● 590.YA163B	6	220
● ✓ 590.KGED25005B	1	258	● 590.PPRN8	1/10	265	● ✓ 590.SGE12505-C	1/12	261	● ✓ 590.YA163B-C	6	227
● ✓ 590.KGED31503		256	● + 590.PPSN1	1/10	265	● 590.SGE12506	1/5	250	● + 590.YA163R	6	222
● ✓ 590.KGED31505		256	● + 590.PPSN8	1/10	265	● 590.SGE16003	1	250	● 590.YA164B	6	220
● ✓ 590.KGED40003		256	● 590.PPTN8	10/100	269	● ✓ 590.SGE16003-C	1/12	261	● 590.YA164R	6	222
● ✓ 590.KGED40005	1	256	● 590.PRO1C4N	1/12	273	● + 590.SGE16005	1	250	● + 590.YA165B	6	220
● ✓ 590.KGED63003		256	● 590.PRO1K	1/12	271	● ✓ 590.SGE16005-C	1/12	261	● ✓ 590.YA165B-C	6	227
● ✓ 590.KGED63005	1	256	● 590.PRO1R4N	1/12	273	● 590.SGE16006	1	250	● + 590.YA165R	6	222
● ✓ 590.KMA200A	10	233	● 590.PRO1R4S	1/12	273	● ✓ 590.SGE1603-C	1/12	261	● + 590.YA166B	6	220
● ✓ 590.KMA200B	10	233	● 590.PRO1R6N	12	272	● ✓ 590.SGE1605-C	1/12	261	● + 590.YA168B	6	220
● ✓ 590.KMA300A	10	233	● + 590.PRO1RN8	1/12	272	● 590.SGE1606	1/12	250	● + 590.YA202B	6	220
● ✓ 590.KMA300B	10	233	● 590.PRO2A	1/10	272	● + 590.SGE2002	1/12	250	● + 590.YA203B	6	220
● ✓ 590.KMA400A	10	233	● 590.PRO2K	1/10	271	● 590.SGE2003	1/12	250	● + 590.YA204B	6	220
● ✓ 590.KMA400B	10	233	● 590.PRO3A	1/10	272	● + 590.SGE2005	1/12	250	● + 590.YA205B	6	220
● ✓ 590.KMM100EM	10	232	● 590.PRO3K	1/10	271	● ✓ 590.SGE2503-C	1/12	261	● ✓ 590.YA253B-C	6	227
● ✓ 590.KMM100GE	10	232	● 590.PRO4K		271	● ✓ 590.SGE2505-C	1/12	261	● ✓ 590.YA255B-C	6	227
● ✓ 590.KMM300EM	10	232	● 590.PRO6K		271	● + 590.SGE2506	1/12	250	● + 590.YA256B	6	220

● = IMQ or other quality marks    ✓ = new product    + = make to order



590		
Cat.num.	Pack qty.	Page
● + 590.YA258B	6	220
● + 590.YA322B	6	220
● + 590.YA322R	6	222
● 590.YA323B	6	220
● ✓ 590.YA323B-C	6	227
● 590.YA323R	6	222
● 590.YA324B	6	220
● 590.YA324R	6	222
● + 590.YA325B	6	220
● ✓ 590.YA325B-C	6	227
● + 590.YA325R	6	222
● + 590.YA326B	6	220
● + 590.YA328B	6	220
● + 590.YA402B	6	220
● + 590.YA402R	6	222
● + 590.YA403B	6	220
● ✓ 590.YA403B-C	6	227
● + 590.YA403R	6	222
● + 590.YA404B	6	220
● + 590.YA404R	6	222
● + 590.YA405B	6	220
● ✓ 590.YA405B-C	6	227
● + 590.YA405R	6	222
● + 590.YA406B	6	220
● + 590.YA408B	6	220
● + 590.YA632B	6	221
● + 590.YA632R	6	222
● + 590.YA633B	6	221
● ✓ 590.YA633B-C	6	227
● + 590.YA633R	6	222
● 590.YA634B	6	221
● 590.YA634R	6	222
● + 590.YA635B	6	221
● ✓ 590.YA635B-C	6	227
● + 590.YA635R	6	222
● + 590.YA636B	6	221
● + 590.YA638B	6	221
● + 590.YA802B	6	221
● + 590.YA802R	6	222
● 590.YA803B	6	221
● ✓ 590.YA803B-C	6	227
● + 590.YA803R	6	222
● + 590.YA804B	6	221
● + 590.YA804R	6	222
● + 590.YA805B	6	221
● ✓ 590.YA805B-C	6	227
● + 590.YA805R	6	222
● + 590.YA806B	6	221
● + 590.YA808B	6	221
● + 590.YF162B	6	224
● 590.YF163B	6	224
● 590.YF164B	6	224
● 590.YF165B	6	224
● 590.YF322B	6	224
● 590.YF323B	6	224
● + 590.YF324B	6	224
● 590.YF325B	6	224
● + 590.YM48B1	1/10	228
● 590.YM48B2	1/10	228
● + 590.YM48R1	1/10	228
● 590.YM48R2	1/10	228
● + 590.YM49B1	1/10	228

590		
Cat.num.	Pack qty.	Page
● + 590.YM49B2	1/10	228
● + 590.YM49R1	1/10	228
● + 590.YM49R2	1/10	228
● 590.YM50B1	10	228
● 590.YM50B2	10	228
● 590.YM50R1	10	228
● 590.YM50R2	10	228
● + 590.YM51B1	10	228
● 590.YM51B2	10	228
● + 590.YM51R1	10	228
● + 590.YM51R2	10	228
● + 590.YM67B1	1/10	229
● + 590.YM67B2	1/10	229
● 590.YM67B6	1/10	229
● + 590.YM67B7	1/10	229
● 590.YM67R1	1/10	229
● 590.YM67R2	1/10	229
● 590.YM67R6	1/10	229
● + 590.YM67R7	1/10	229
● 590.YM68B1	10	229
● 590.YM68B2	10	229
● 590.YM68B6	10	229
● 590.YM68B7	10	229
● 590.YM68R1	10	229
● 590.YM68R2	10	229
● + 590.YM70R1	10	230
● + 590.YM70R2	10	230
● + 590.YM70R6	10	230
● + 590.YM70R7	10	230
● + 590.YM80B1	5	229
● + 590.YM80B2	5	229
● ✓ 590.YM80B2-C	1/10	229
● + 590.YMA070	10/100	233
● + 590.YMA085	10/100	233
● + 590.YMA101	10/100	233
● ✓ 590.YMA102		0
● 590.YMA185	10/100	233
● + 590.YMA201	10/100	233
● ✓ 590.YMA202		0
● 590.YMA300	10	233
● + 590.YMA301	10/100	233
● ✓ 590.YMA302		0
● + 590.YMB085	10/100	233
● + 590.YMB185	10/100	233
● + 590.YMB300	10	233
● + 590.YMC1	10	230
● + 590.YMC2	10	230
● + 590.YMDIN	10	231
● ✓ 590.YMZZ	10/50	233

600		
Cat.num.	Pack qty.	Page
● 600.1623	1/6	431
● 600.1624	1/6	431
● 600.1626	1/6	431
● + 600.1626/1	1/6	431
● 600.1627	1/6	431
● + 600.1629	1/6	431

601		
Cat.num.	Pack qty.	Page
● 601.1623	1/6	431
● 601.1626	1/6	431
● 601.1627	1/6	431
● 601.1629	1/6	431

602		
Cat.num.	Pack qty.	Page
● 602.3005-059	1/6	434
● 602.3005-061	1/6	434
● 602.3005-062	1/6	434
● 602.3005-063	1/6	434
● 602.3005-064	1/6	434
● 602.3005-215	1/6	434
● 602.3505-059	1/6	434
● 602.3505-061	1/6	434
● 602.3505-062	1/6	434
● 602.3505-063	1/6	434
● 602.3505-064	1/6	434
● 602.3505-443	1/6	434
● 602.5005-358	1/6	435
● 602.5005-359	1/6	435
● 602.5005-360	1/6	435

603		
Cat.num.	Pack qty.	Page
● 603.3005-000	1/10	317
● 603.3005-059	1/10	433
● 603.3005-061	1/10	433
● 603.3005-062	1/10	433
● 603.3005-063	1/10	433
● 603.3005-064	1/10	433
● 603.3505-059	1/10	433
● 603.3505-061	1/10	433
● 603.3505-062	1/10	433
● 603.3505-063	1/10	433
● 603.3505-064	1/10	433
● 603.5005-358	1/10	434
● 603.5005-359	1/10	434
● 603.5005-360	1/10	434
● 603.5005-415	1/10	434
● 603.5005-427	1/10	434
● 603.83505-059		183
● 603.83505-061	1/10	183
● 603.83505-062	1/10	183
● 603.83505-063		183
● 603.83505-064		183

604		
Cat.num.	Pack qty.	Page
● 604.1623/C	1/6	432
● 604.1626/C	1/6	432
● + 604.1626/I-C	1/6	432
● + 604.1627/C	1/6	432
● 604.1629/C	1/6	432
● 604.3226/C	1/6	432
● 604.3227/C	1/6	432

605		
Cat.num.	Pack qty.	Page
● 605.1623/C	1/6	432
● + 605.1626/C	1/6	432
● + 605.1627/C	1/6	432
● + 605.1629/C	1/6	432
● 605.3226/C	1/6	432
● 605.3227/C	1/6	432

606		
Cat.num.	Pack qty.	Page
● 606.3005-059	1/6	432
● 606.3005-062	1/6	432
● 606.3005-063	1/6	432
● + 606.3005-479	1/6	432
● + 606.3015-059	1/6	433
● 606.3015-062	1/6	433
● + 606.3015-063	1/6	433
● 606.3015-479	1/6	433
● + 606.3015-740	6	433
● 606.3505-059	1/6	432
● 606.3505-062	1/6	432
● 606.3505-063	1/6	432
● 606.3505-479	1/6	432
● 606.3515-059	1/6	433
● 606.3515-062	1/6	433
● 606.3515-063	1/6	433
● 606.3515-479	1/6	433

610		
Cat.num.	Pack qty.	Page
● + 610.3444	10/50	430
● 610.3464	10	430
● 610.3646	10/50	430
● 610.3666	10	430
● 610.367	10/100	428
● 610.368	10/100	426
● + 610.368	10/100	426
● + 610.369	10/100	429
● 610.370	10/100	426
● 610.371	10/100	426
● 610.372	10/100	426
● 610.373	10/100	426
● 610.374	10/100	427
● 610.3746	10	431
● 610.3747	10/50	430
● 610.375	10/100	427
● 610.376	10/100	427
● 610.377	10/100	428
● 610.378	10/100	429
● 610.379	10/100	428
● 610.380	10/100	426
● 610.380.N	10/100	177
● 610.381	10/100	427
● 610.382	10/100	427
● 610.383	10/100	428
● 610.384	10/100	428
● 610.384.N	10/100	177
● 610.388	10/100	427
● 610.388.N	10/100	177
● 610.390	10/100	427

## Index by product number

610		
Cat.numb.	Pack qty.	Page
● 610.391	10/100	427
● + 610.392	10/100	427
● 610.394	10/100	429
● 610.395	10/100	428

623		
Cat.numb.	Pack qty.	Page
● 623.3000-056	1	435
● 623.3000-062	1	435
● 623.3000-063	1	435
● 623.3006-054	1	436
● 623.3006-062	1	436
● 623.3006-063	1	436
● 623.3500-000	1/4	317
● 623.3500-062	1	435
● 623.3500-063	1	435
● 623.3506-062	1	436
● 623.3506-063	1	436
● 623.4005-003	1	437
● 623.4005-006	1	437
● 623.4005-010	1	437
● 623.4005-012	1	437
● 623.4500-000	1/4	317
● 623.4505-003	1	437
● 623.4505-006	1	437
● 623.4505-012	1	437

625		
Cat.numb.	Pack qty.	Page
● 625.3500-000	1/4	317
● 625.3500-059	1	436
● 625.3500-060	1	436
● 625.3500-062	1	436
● 625.3500-063	1	436
● 625.3506-059	1	437
● 625.3506-060	1	437
● 625.3506-062	1	437
● 625.4500-000	1/4	317
● 625.4505-003	1	438
● 625.4505-012	1	438

630		
Cat.numb.	Pack qty.	Page
● 630.001	1	410
● 630.002	1	410
● 630.011	1	411
● 630.012	1	411
● 630.021	1	412
● 630.022	1	412
● 630.031	1	413
● 630.032	1	413
● 630.3000-052	1	388
● 630.3000-054	1	388
● 630.3000-055	1	388
● 630.3000-056	1	388
● 630.3000-059	1	388

630		
Cat.numb.	Pack qty.	Page
● 630.3000-060	1	388
● 630.3000-062	1	388
● 630.3000-063	1	388
● 630.3000-401	1	388
● 630.3006-052	1	390
● 630.3006-054	1	390
● 630.3006-055	1	390
● 630.3006-056	1	390
● 630.3006-059	1	391
● 630.3006-060	1	391
● 630.3006-062	1	391
● 630.3006-063	1	391
● 630.3006-362	1	390
● 630.3500-059	1	388
● 630.3500-060	1	388
● 630.3500-062	1	388
● 630.3500-063	1	388
● 630.3506-052	1	391
● 630.3506-054	1	391
● 630.3506-055	1	391
● 630.3506-056	1	391
● 630.3506-059	1	391
● 630.3506-060	1	391
● 630.3506-062	1	391
● 630.3506-063	1	391
● 630.3506-362	1	391
● 630.4000-001	1	389
● 630.4000-002	1	389
● 630.4000-003	1	389
● 630.4000-006	1	389
● 630.4000-007	1	389
● 630.4000-008	1	389
● 630.4000-010	1	389
● 630.4000-012	1	389
● 630.4000-013	1	389
● 630.4000-326	1	389
● 630.4000-327	1	389
● 630.4000-328	1	389
● 630.4000-329	1	389
● 630.4006-001	1	392
● 630.4006-002	1	392
● 630.4006-003	1	392
● 630.4006-006	1	392
● 630.4006-007	1	392
● 630.4006-008	1	392
● 630.4006-010	1	392
● 630.4006-012	1	392
● 630.4006-013	1	392
● 630.4006-188	1	392
● 630.4009-014	1	394
● 630.4009-016	1	394
● 630.4009-017	1	394
● 630.4009-017	1	394
● 630.4009-323	1	394
● 630.4106-003	1	393
● 630.4106-006	1	393
● 630.4106-008	1	393
● 630.4106-012	1	393
● 630.4106-013	1	393
● 630.4500-003	1	389
● 630.4500-006	1	389
● 630.4500-007	1	389
● 630.4500-008	1	389

630		
Cat.numb.	Pack qty.	Page
● 630.4500-012	1	389
● 630.4500-013	1	389
● 630.4500-326	1	389
● 630.4500-327	1	389
● 630.4500-328	1	389
● 630.4500-329	1	389
● 630.4506-001	1	392
● 630.4506-002	1	392
● 630.4506-003	1	392
● 630.4506-006	1	392
● 630.4506-007	1	392
● 630.4506-008	1	392
● 630.4506-010	1	392
● 630.4506-012	1	392
● 630.4506-013	1	392
● 630.4509-014	1	394
● 630.4509-016	1	394
● 630.4509-017	1	394
● 630.4509-323	1	394
● 630.4606-003	1	393
● 630.4606-008	1	393
● 630.4606-012	1	393
● 630.4606-013	1	393

632		
Cat.numb.	Pack qty.	Page
● 632.1500-000	4	308
● 632.1510-000	4	308
● 632.1530-000	4	310
● 632.3000-052	1	395
● 632.3000-054	1	395
● 632.3000-055	1	395
● 632.3000-056	1	395
● 632.3000-059	1	395
● 632.3000-060	1	395
● 632.3000-062	1	395
● 632.3000-063	1	395
● 632.3005-052	1	399
● 632.3005-054	1	399
● 632.3005-055	1	399
● 632.3005-056	1	399
● 632.3005-059	1	399
● 632.3005-060	1	399
● 632.3005-062	1	399
● 632.3005-063	1	399
● 632.3006-052	1	397
● 632.3006-054	1	397
● 632.3006-056	1	397
● 632.3006-059	1	397
● 632.3006-060	1	397
● 632.3006-062	1	397
● 632.3006-063	1	397
● 632.3006-324	1	397
● 632.3006-325	1	397
● 632.3500-000	4	308
● 632.3500-059	1	395
● 632.3500-060	1	395
● 632.3500-062	1	395
● 632.3500-063	1	395

632		
Cat.numb.	Pack qty.	Page
● 632.3501-000	4	309
● 632.3505-059	1	399
● 632.3505-060	1	399
● 632.3505-062	1	399
● 632.3505-063	1	399
● 632.3506-059	1	397
● 632.3506-060	1	397
● 632.3506-062	1	397
● 632.3506-063	1	397
● 632.3506-324	1	397
● 632.3506-325	1	397
● 632.3510-000	4	308
● 632.3511-000	4	309
● 632.3520-000	4	310
● + 632.3530-000	4	311
● 632.4000-001	1	396
● 632.4000-002	1	396
● 632.4000-003	1	396
● 632.4000-006	1	396
● 632.4000-007	1	396
● 632.4000-008	1	396
● 632.4000-010	1	396
● 632.4000-012	1	396
● 632.4000-013	1	396
● 632.4000-328	1	396
● 632.4000-329	1	396
● 632.4000-342	1	396
● 632.4005-001	1	401
● 632.4005-002	1	401
● 632.4005-003	1	401
● 632.4005-006	1	401
● 632.4005-007	1	401
● 632.4005-008	1	401
● 632.4005-010	1	401
● 632.4005-012	1	401
● 632.4005-013	1	401
● 632.4005-326	1	401
● 632.4005-327	1	401
● 632.4005-328	1	401
● 632.4005-329	1	401
● 632.4006-001	1	398
● 632.4006-002	1	398
● 632.4006-003	1	398
● 632.4006-006	1	398
● 632.4006-007	1	398
● 632.4006-008	1	398
● 632.4006-010	1	398
● 632.4006-012	1	398
● 632.4006-013	1	398
● 632.4006-328	1	398
● 632.4006-329	1	398
● 632.4009-014	1	402
● 632.4009-015	1	402
● 632.4009-016	1	402
● 632.4009-017	1	402
● 632.4500-000	4	309
● 632.4500-003	1	396
● 632.4500-006	1	396
● 632.4500-007	1	396
● 632.4500-008	1	396
● 632.4500-012	1	396
● 632.4500-013	1	396

632		
Cat.num.	Pack qty.	Page
● 632.4500-328	1	396
● 632.4500-329	1	396
● 632.4505-003	1	401
● 632.4505-006	1	401
● 632.4505-007	1	401
● 632.4505-008	1	401
● 632.4505-012	1	401
● 632.4505-013	1	401
● 632.4505-326	1	401
● 632.4505-327	1	401
● 632.4505-328	1	401
● 632.4505-329	1	401
● 632.4506-003	1	398
● 632.4506-006	1	398
● 632.4506-007	1	398
● 632.4506-008	1	398
● 632.4506-012	1	398
● 632.4506-013	1	398
● 632.4506-188	1	398
● 632.4506-328	1	398
● 632.4506-329	1	398
● 632.4509-014	1	402
● 632.4509-015	1	402
● 632.4509-016	1	402
● 632.4509-017	1	402
● 632.4510-000	4	309
● 632.4520-000	4	311
● 632.4530-000	4	311
● + 632.4700-000	4	309
● + 632.4710-000	4	309
● 632.5500-000	2	309
● 632.5510-000	2	309
● 632.5520-000	2	311

633		
Cat.num.	Pack qty.	Page
● 633.1010	12	315
● 633.1011	12	316
● 633.1012	12	316
● 633.1013	12	316
● 633.1014	12	316
● 633.2020	6	315
● 633.2021	6	316
● 633.2022	6	316
● 633.2023	6	316
● 633.2024	6	316
● 633.2025	6	316
● 633.2026	6	316

639		
Cat.num.	Pack qty.	Page
● 639.1040	26	355
● 639.1060	38	355
● 639.1080	25	355
● 639.2040	24	355
● 639.2060	18	355
● 639.2080	12	355
● 639.2120	8	355

639		
Cat.num.	Pack qty.	Page
● 639.4060	8	355
● 639.4080	6	355
● 639.4120	4	355

653		
Cat.num.	Pack qty.	Page
● 653.00	1/32	360
● 653.01	1/24	360
● 653.011	1/40	361
● 653.012	1/20	361
● 653.013	1/20	361
● 653.014	1/10	361
● 653.015	1/10	361
● 653.017	1/5	361
● 653.02	1/16	360
● 653.020	1/25	361
● 653.021	1/25	361
● 653.022	1/20	361
● 653.023	1/25	361
● 653.024	1/20	361
● + 653.025	1/30	361
● + 653.027	1/50	361
● 653.03	1/12	360
● 653.04	1/6	360
● 653.05	1/2	360
● 653.07	1	360

654		
Cat.num.	Pack qty.	Page
● + 654.0002	10	327
● 654.0003	10	327
● + 654.0010	1/12	0
● 654.0020	1/10	292
● 654.0021	1/10	349
● 654.0022	100/2000	349
● 654.0023	1/10	349
● 654.0024	10	327
● 654.0025	50	307
● 654.0026	15	307
● 654.0030	1/25	297
● 654.0032	1/25	350
● + 654.0033	1/25	297
● + 654.0038	25	293
● 654.0040	1/25	293
● 654.0041	6/60	294
● + 654.0041B	6/60	294
● 654.0042	6/60	294
● + 654.0042B	6/60	294
● 654.0043	6	294
● + 654.0043B	6	294
● 654.0044	6	294
● + 654.0044B	6	294
● 654.0045	6/72	295
● + 654.0046	200	295
● + 654.0050	10	318
● 654.0051	10	327
● 654.0060	1/10	297
● 654.0070	1/10	297

654		
Cat.num.	Pack qty.	Page
✓ 654.0071	1/10	325
● 654.0072	1/10	297
● 654.0073	10	0
✓ 654.0074	10	307
✓ 654.0077	10	344
● 654.0079	1/10	132
● 654.0080	10/100	350
● 654.0085	1/20	350
● 654.0090	20/100	298
● 654.0091	12/120	298
● 654.0092	12/120	298
● 654.0100	25	300
● + 654.0101	25	270
● + 654.0101Y	25	270
● + 654.0102	25	270
● 654.0103	25	91
● 654.0105	25	310
● 654.0108	5	94
● 654.0120	6/72	116
● 654.0121	6	116
● + 654.0122	6	116
● 654.0125	6/72	116
● 654.0126	6/72	116
● 654.0140	50	344
● 654.0140-06	10	344
● 654.0140-08	10	344
● 654.0140-12	10	344
● 654.0141-06	10	344
● 654.0141-08	10	344
● 654.0141-12	10	344
● + 654.0180-04	10	422
● + 654.0180-06	10	422
● + 654.0180-08	10	422
● + 654.0180-12	10	422
● 654.0180-16	1/10	422
✓ 654.0180-24		422
● + 654.0181-01	1/10	422
● + 654.0181-03	5/10	422
● 654.0181-04	5/10	422
● + 654.0181-04Y	5/10	422
● 654.0181-05	5/10	422
✓ 654.0181-07		422
● 654.0190	10	422
● 654.0191	10	422
● + 654.0205	1	313
● + 654.0207	1	313
● + 654.0210	1	301
● 654.0220	1	301
● 654.0349	10/100	305
● 654.0358	1/10	303
● + 654.0359	1/10	303
● 654.0360	1/10	305
● 654.0361	1/10	304
● + 654.0361C	10	304
● 654.0362	1/10	304
● + 654.0362C	10	304
● 654.0363	1/10	303
● 654.0364	1/10	305
● + 654.0364C	10	305
● 654.0365	10	303
● + 654.0376	20/200	625
✓ 654.0377	25	307

654		
Cat.num.	Pack qty.	Page
● + 654.0382	10/100	95
● 654.0391	10	95
● 654.0392	10	95
● 654.0393	10	95
● 654.0394	10	95
● 654.0400	25	117
● 654.0400B	25	299
✓ 654.0401	5/20	336
● 654.0410	25/250	117
● 654.0420	25/400	117
● 654.0600	2	314
● 654.0610	1	115
✓ 654.0615		296
● + 654.0650	1	292
● + 654.0651	1	0
● 654.0652	2	292
● + 654.0653	2	292
● + 654.0654	2	292
● 654.0655	4	292
● 654.0656	4	292
✓ 654.0657	1	292
✓ 654.0658	1	0
● 654.0700	1	293
● 654.0710	1	293
● 654.0750	1/10	299
● 654.0751	1/10	299
● 654.0752	10	299
✓ 654.0753	10	299
● 654.0787	1/30	349
● 654.0788	1/20	349
● 654.0789	1/15	349
● 654.0790	1/10	349
● 654.0791	1/10	349
✓ 654.11163		423
✓ 654.11164		423
✓ 654.11165		423
● 654.11324	5/25	423
✓ 654.11325		423
✓ 654.11634		423
✓ 654.11635		423
● 654.12324	25	423
✓ 654.12325	25	423
✓ 654.13163		423
✓ 654.13164		423
✓ 654.13165	5/25	423
✓ 654.13324		423
✓ 654.13325	5/25	423
✓ 654.13634		423
✓ 654.13635		423
✓ 654.161253		423
✓ 654.161255		423
✓ 654.16163	25	423
✓ 654.16164		423
✓ 654.16165		423
✓ 654.16323		423
✓ 654.16324		423
✓ 654.16325		423
✓ 654.16633		423
✓ 654.16635		423
✓ 654.2110	5/10	422
✓ 654.2111		422
● + 654.906396	1	328

## Index by product number

654		
Cat.numb.	Pack qty.	Page
● + 654.906397	1	328
● + 654.912597	1	328

655		
Cat.numb.	Pack qty.	Page

● 655.0010	1	329
● 655.0011	1	330
● 655.0012	1	331
● 655.0014	1/4	331
● 655.0015	1/4	331
● 655.0016	1/8	331
● 655.0019	1/8	332
● 655.0020	1	329
● ✓ 655.0020-K40	1	330
● 655.0021	1	330
● 655.0022	1	331
● 655.0024	1/4	331
● 655.0025	1/4	331
● 655.0026	1/9	331
● 655.0030	1	329
● ✓ 655.0030-K60	1	330
● 655.0031	1	330
● 655.0032	1	331
● 655.0034	1/2	331
● 655.0035	1/2	331
● 655.0036	1/9	331
● 655.0039	1/10	332
● 655.0040	1	329
● ✓ 655.0040-K80	1	330
● 655.0041	1	330
● 655.0042	1	331
● 655.0044	1/2	331
● 655.0045	1/2	331
● 655.0046	1/9	331
● 655.0050	1	329
● 655.0051	1	330
● 655.0052	1	331
● 655.0054	1/2	331
● 655.0055	1/2	331
● 655.00550	1/5	332
● 655.0056	1/2	331
● 655.00560	1/4	332
● 655.0059	1/6	332
● 655.0110	1	329
● 655.0111	1	330
● 655.0112	1	331
● 655.0120	1	329
● 655.0121	1	330
● 655.0122	1	331
● 655.0130	1	329
● 655.0131	1	330
● 655.0132	1	331
● 655.0140	1	329
● 655.0141	1	330
● 655.0142	1	331
● 655.0150	1	329
● 655.0151	1	330
● 655.0152	1	331
● 655.02101	1	329
● 655.02201	1	329

655		
Cat.numb.	Pack qty.	Page

● 655.02301	1	329
● 655.02401	1	329
● 655.02501	1	329
● 655.32010	1/10	333
● 655.32011	1/8	333
● 655.32012	1/4	333
● 655.32020	1/5	333
● 655.32021	1/8	334
● 655.32022	1/10	334
● 655.32024	1/5	334
● 655.32090	1/3	335
● 655.46010	1/18	333
● 655.46011	1/8	333
● 655.46012	1/4	333
● 655.46020	1/4	333
● 655.46021	1/10	334
● 655.46022	1/10	334
● 655.46024	1/4	334
● 655.46025	1/9	334
● 655.46090	1/3	335
● 655.75010	1/20	333
● 655.75011	1/6	333
● 655.75012	1/6	333
● 655.75020	1/12	333
● 655.75021	1/24	334
● 655.75022	1/16	334
● 655.75023	1/18	334
● 655.75024	1/10	334
● + 655.75090	1	335
● 655.900	10	335
● 655.910	1/10	335
● 655.911	1/10	335
● 655.920	1/10	335
● 655.930	1/10	335
● 655.950	1	335
● 655.960	1/10	335
● 655.970	1/10	335

656		
Cat.numb.	Pack qty.	Page

● ✓ 656.0010	10	324
● 656.0012		324
● 656.0024-000	1	320
● 656.0024-000L	1	320
● 656.0026-000	1	320
● 656.0026-000L	1	320
● ✓ 656.0110	5/10	324
● 656.0120	1	325
● 656.0220	1	326
● 656.0221	1	326
● 656.0222	1	326
● ✓ 656.0300		322
● 656.0320	10	322
● 656.0420	10	325
● 656.0924-000	1	320
● 656.0924-000L	1	320
● 656.0926-000	1	320
● 656.0926-000L	1	320
● 656.7024-006	1	377
● 656.7024-008	1	377

656		
Cat.numb.	Pack qty.	Page

● 656.7024-056	1	377
● 656.7024-611	1	377
● 656.7026-639	1	379
● 656.7026-640	1	379
● ✓ 656.7026-739	1	379
● 656.7124-006	1	377
● 656.7124-008	1	377
● 656.7124-056	1	377
● 656.7124-611	1	377
● 656.7126-639	1	379
● 656.7126-640	1	379
● 656.7824-006	1	377
● 656.7824-008	1	377
● 656.7824-611	1	377
● 656.7826-639	1	379
● 656.7826-640	1	379
● 656.7926-639	1	379
● 656.7926-640	1	379
● 656.9024-613	1	0
● 656.9024-614	1	0

657		
Cat.numb.	Pack qty.	Page

● 657.0014		324
● 657.0035-000	1	321
● 657.0036-000	1	321
● 657.0038-000	1	321
● 657.0121	1	325
● 657.0330	10	322
● 657.0331	10	323
● 657.0332	10	323
● 657.0333	10	323
● 657.0340	10	322
● + 657.0341	10	323
● + 657.0342	10	323
● 657.0343	10	323
● 657.0421	10	325
● 657.0935-000	1	321
● 657.0936-000	1	321
● 657.0938-000	1	321
● 657.8034-006	1	377
● 657.8034-008	1	377
● 657.8035-012	1	377
● 657.8035-013	1	377
● 657.8035-087	1	377
● 657.8135-012	1	377
● 657.8135-013	1	377
● 657.8135-087	1	377
● 657.8835-012	1	377
● 657.8835-013	1	377
● 657.8835-087	1	377
● 657.8839-825	1	381
● 657.8839-826	1	381
● 657.8839-827	1	381
● 657.8935-012	1	377
● 657.8935-013	1	377
● 657.8935-087	1	377

658		
Cat.numb.	Pack qty.	Page

● 658.0016		324
● 658.0050-000	1	321
● 658.0350	10	322
● + 658.0351	10	323
● + 658.0352	10	323
● + 658.0353	10	323
● 658.0360	10	322
● + 658.0361	10	323
● + 658.0362	10	323
● + 658.0363	10	323
● 658.0369	10	324
● + 658.0422	10	325
● 658.0950-000	1	321
● 658.8050-702	1	379
● 658.8050-705	1	379
● 658.8056-138	1	379
● 658.8058-040	1	379
● 658.8059-043	1	379
● 658.8150-702	1	379
● 658.8156-138	1	379
● 658.8158-040	1	379
● 658.8159-043	1	379
● 658.8850-702	1	379
● 658.8850-705	1	379
● 658.8856-138	1	379
● 658.8950-702	1	379
● 658.8950-705	1	379
● 658.8956-138	1	379
● 658.8959-043	1	379

659		
Cat.numb.	Pack qty.	Page

● 659.BA5040-00		337
● 659.BA5140-02		403
● 659.DA5041-00		337
● 659.DA5081-00		337
● 659.DA5121-01	1	403
● 659.DA5141-02	1	403
● 659.DA5141-04	1	403
● 659.DA5181-03	1	403
● 659.DA5181-05	1	403
● 659.DA5221-01	1	406
● 659.DA5241-02	1	406
● 659.DA5241-04	1	406
● 659.DA5281-03	1	406
● 659.DA5281-05	1	406
● 659.DB5041-00		337
● 659.DB5081-00		337
● 659.DB5121-01	1	403
● 659.DB5141-02	1	403
● 659.DB5141-04	1	403
● 659.DB5181-03	1	403
● 659.DB5181-05	1	403
● 659.DB5221-01		406
● 659.DB5241-02		406
● 659.DB5241-04		406
● 659.DB5281-03		406
● 659.DB5281-05		406
● 659.MA5041-00		337
● 659.MA5121-01		404

659		
Cat.numb.	Pack qty.	Page
● 659.MA5141-02		404
● 659.MA5141-04		404
● 659.MA5221-01		406
● 659.MA5241-02		406
● 659.MA5241-04		406
● 659.MB5041-00		337
● 659.MB5121-01		404
● 659.MB5141-02		404
● 659.MB5141-04		404
● 659.MB5221-01		406
● 659.MB5241-02		406
● 659.MB5241-04		406
● 659.SC5041-00		338
● 659.SC5121-01		404
● 659.SC5141-02		404
● 659.SC5141-04		404
● 659.SC5221-01		407
● 659.SC5241-02		407
● 659.SC5241-04		407
● 659.SC5243-07		407
● 659.SC5263-06		407
● 659.SC5263-09		407
● 659.SCBASE		338
● 659.SCFIRE-E		340
● 659.SCFIRE-M		340
● 659.SK5041-00		339
● 659.SK5121-01		405
● 659.SK5123-12		405
● 659.SK5141-02		405
● 659.SK5141-04		405
● 659.SK5143-07		405
● 659.SK5163-06		405
● 659.SK5221-01		407
● 659.SK5241-02		407
● 659.SK5241-04		407
● 659.SK5243-08		407
● 659.SKBASE		339
● 659.SKFIRE-E		340
● 659.SKFIRE-M		340
● 659.SX5040-00		340
● 659.SX5140-02		405

661		
Cat.numb.	Pack qty.	Page
● + 661.0160-057	1	383
● + 661.0160-065	1	383
● + 661.0160-068	1	383
● + 661.0160-075	1	383
● + 661.5160-053		383
● + 661.5160-160		383
● + 661.5250-008		383

670		
Cat.numb.	Pack qty.	Page
● 670.3026-75	1	385
● 670.3026-77	1	385
● 670.3526-77	1	385
● 670.3536-59	1	386

670		
Cat.numb.	Pack qty.	Page
● 670.3536-62	1	386
● 670.6046-03	1	385
● 670.6046-08	1	385
● 670.6046-12	1	385
● 670.6546-03	1	385
● 670.6546-12	1	385
● 670.6566-117	1	386
● 670.6566-126	1	386
● 670.6566-137	1	386
● 670.9566-456	1	414
● 670.9566-457	1	414
● 670.9566-458	1	414
● 670.9566-459	1	414
● 670.9566-464	1	414
● 670.9566-465	1	414
● 670.9566-466	1	414
● 670.9566-467	1	414

671		
Cat.numb.	Pack qty.	Page
● 671.2012-001	1	384
● 671.2012-002	1	384
● 671.2012-003	1	384
● 671.2012-004	1	384
● 671.2012-005	1	384
● 671.2012-006	1	384
● 671.2012-009	1	384
● 671.2016-008	1	384
● 671.2912-001	1	384
● 671.2912-002	1	384
● 671.2912-003	1	384
● 671.2912-004	1	384
● 671.3020-75	1	385
● 671.3020-77	1	385
● 671.3025-75	1	386
● 671.3030-59	1	387
● 671.3030-97	1	387
● 671.3035-59	1	387
● 671.3035-97	1	387
● 671.3530-59	1	387
● 671.3530-97	1	387
● 671.3535-59	1	387
● 671.3535-97	1	387
● 671.6040-03	1	385
● 671.6040-07	1	385
● 671.6040-95	1	385
● 671.6045-03	1	386
● 671.6045-06	1	386
● 671.6045-07	1	386
● 671.6045-08	1	386
● 671.6045-95	1	386
● 671.6065-117	1	387
● 671.6545-03	1	386
● 671.6545-95	1	386
● 671.6560-117	1	387
● 671.6565-117	1	387

672		
Cat.numb.	Pack qty.	Page
● 672.1100	1/6	280
● + 672.1101	6	280
● 672.1200	1/6	282
● 672.1300	1/6	286
● 672.1301	6	286
● 672.2002	1/24	276
● 672.2004	1/16	277
● 672.2008	1/10	277
● 672.2008.1101	1/10	277
● 672.2012	1/9	277
● 672.2012.1101	1/9	277
● 672.2016	1/6	277
● 672.2016.1101	1/6	277
● 672.2100	1/10	281
● 672.2200	1/10	283
● 672.2300	1/10	286
● 672.2301	1/10	286
● 672.3100	1/6	281
● ✓ 672.3100.1102	6	281
● 672.3200	1/6	283
● 672.3300	1/6	287
● 672.3302	1/6	287
● 672.4024	1/6	278
● 672.4024.1102	1/6	278
● 672.4032	1/4	278
● 672.4032.1102	1/4	278
● 672.4116	1/4	281
● 672.4216	1/4	283
● 672.4316	1/4	287
● 672.5048	1/3	278
● 672.5048.1102	1/3	278
● 672.5116	1/3	282
● 672.5122	3	282
● ✓ 672.5122.1102	3	282
● 672.5316	1/3	285
● 672.5416	1/3	284
● 672.5522	3	285
● 672.5616	1/3	287
● 672.5622	3	284
● 672.5822	3	287
● ✓ 672.5822.1102	3	287
● 672.7064	1	279
● + 672.7064.1102	1	279

673		
Cat.numb.	Pack qty.	Page
● 673.2008	1/12	290
● ✓ 673.2008.1102	1/12	290
● 673.2008B	1/12	290
● + 673.2008B.2010	1/12	290
● 673.2008B.2012	1/10	290
● 673.2012	1/7	290
● ✓ 673.2012.1102	6	290
● 673.2012B	1/7	290
● 673.2012B.2010	1/7	290
● + 673.2012B.2012	1/6	290
● 673.2018	1/6	290
● 673.2018B	1/6	290
● + 673.2018B.2010	1/6	290
● + 673.2018B.2012	1	290

673		
Cat.numb.	Pack qty.	Page
● 673.2102	1/36	289
● 673.2102B	1/36	289
● 673.2104	1/24	289
● 673.2104B	1/24	289
● 673.2108	1/12	289
● 673.2108B	1/12	289
● + 673.2108B.0012	1/10	289
● 673.2112	1/7	289
● 673.2112B	1/7	289
● + 673.2112B.0012	1/6	289
● 673.2118	1/6	289
● ✓ 673.2118.0011	1/6	289
● 673.2118B	1/6	289
● + 673.2118B.0012	1	289
● 673.4024	1/5	290
● 673.4024B	1/5	290
● 673.4024B.2010	1/5	290
● 673.4024B.2012	1	290
● 673.4036	1/4	290
● 673.4036B	1/4	290
● 673.4036B.2010	1/4	290
● 673.4036B.2012	1	290
● 673.4124	1/5	289
● 673.4124B	1/5	289
● + 673.4124B.0012	1	289
● 673.4136	1/4	289
● + 673.4136B	1/4	289
● + 673.4136B.0012	1	289
● 673.5054	1/2	290
● 673.5054B	1/2	290
● 673.5054B.2010	1/2	290
● + 673.5054B.2012	1	290
● 673.5154	1/2	289
● + 673.5154B	1/2	289
● + 673.5154B.0012	1	289

674		
Cat.numb.	Pack qty.	Page
● 674.1000	1/6	288
● + 674.1001	6	288
● 674.1100	1/6	288
● + 674.1101	6	288
● 674.1200	1/6	288
● 674.1300	1/6	288
● + 674.1301	6	288

675		
Cat.numb.	Pack qty.	Page
● 675.2008	1/10	291
● ✓ 675.2008.1102	1/10	291
● 675.2008B	1/10	291
● 675.2008B.2010	1/10	291
● 675.2008B.2012	1/6	291
● 675.2012	1/7	291
● ✓ 675.2012.1102	1/7	291
● 675.2012B	1/7	291
● 675.2012B.2010	1/7	291
● 675.2012B.2012	1/4	291



## Index by product number

675		
Cat.numb.	Pack qty.	Page
● 675.2018	1/7	291
● 675.2018B	1/7	291
● + 675.2018B.2010	1/7	291
● + 675.2018B.2012	1	291
● 675.2104	1/38	291
● 675.2104B	1/38	291
● 675.4024	1/5	291
● 675.4024B	1/5	291
● 675.4024B.2010	1/5	291
● + 675.4024B.2012	1	291
● 675.4036	1/3	291
● 675.4036B	1/3	291
● 675.4036B.2010	1/3	291
● 675.4036B.2012	1	291
● 675.5054	1/2	291
● 675.5054B	1/2	291
● 675.5054B.2010	1/2	291
● 675.5054B.2012	1	291

676		
Cat.numb.	Pack qty.	Page
676.10101	10	346
676.10102	10	346
+ 676.10103	20	346
● 676.25100	1/13	345
● 676.35100	1/14	345
● 676.35201	1/6	345
● + 676.35205	1/6	346

677		
Cat.numb.	Pack qty.	Page
● + 677.1012.1	1	306
● ✓ 677.1012.1-HW	1	306
● ✓ 677.2024.1	1	306
● ✓ 677.2024.1-HW	1	306
● + 677.3036.2	1	306
● ✓ 677.3036.2-HW	1	306
● 677.4048.2	1	306
● ✓ 677.4048.2-HW	1	306
● ✓ 677.5060.2	1	306
● ✓ 677.5060.2-HW	1	306

680		
Cat.numb.	Pack qty.	Page
● 680.001	4/100	347
● 680.002	4/100	347
● 680.003	4/60	347

685		
Cat.numb.	Pack qty.	Page
● 685.004	1/48	347
● 685.005	1/54	347
● 685.006	1/40	347
● 685.007	1/24	347
● 685.008	1/12	347

685		
Cat.numb.	Pack qty.	Page
● 685.009	1/6	347
● 685.010	1/4	347
● 685.011	1	347

686		
Cat.numb.	Pack qty.	Page
● 686.204	1/40	348
● 686.205	1/42	348
● 686.206	1/48	348
● 686.207	1/30	348
● 686.208	1/16	348
● 686.209	1/8	348
● 686.210	1/4	348
● 686.211	1	348
● 686.224	1/40	348
● 686.225	1/42	348
● 686.226	1/48	348
● 686.227	1/30	348
● 686.228	1/16	348
● 686.229	1/8	348
● 686.230	1/4	348
● 686.231	1	348
● 686.404	1/24	348
● 686.408	1/6	348
● 686.409	1/6	348
● 686.410	1/3	348
● 686.411	1	348
● + 686.424	1/24	348
● 686.428	1/6	348
● 686.429	1/6	348
● 686.430	1/3	348
● 686.431	1	348
● ✓ 686.AMRTA-01	154	
● ✓ 686.AMRTA-005	153	
● ✓ 686.AMRTA-032	153	
● ✓ 686.AMRTA-063	153	
● ✓ 686.AMRTA-125	153	
● ✓ 686.AMRTA-225	153	

687		
Cat.numb.	Pack qty.	Page
● 687.001	4/100	351
● 687.002	4/100	351
● 687.003	4/60	351
● 687.004	1/48	352
● 687.005	1/54	352
● 687.006	1/40	352
● 687.204	1/40	353
● 687.205	1/42	353
● 687.206	1/48	353

688		
Cat.numb.	Pack qty.	Page
● 688.001	4/100	351
● 688.002	4/100	351
● 688.003	4/60	351

688		
Cat.numb.	Pack qty.	Page
● 688.003.R	4/60	351
● 688.004	1/48	352
● + 688.004.R	1/48	352
● + 688.005	1/54	352
● + 688.005.R	1/54	352
● 688.006	1/40	352
● 688.204	1/40	353
● 688.204.R	1/40	353
● + 688.205	1/42	353
● + 688.205.R	1/42	353
● 688.206	1/48	353
● 688.206.R	48	353

689		
Cat.numb.	Pack qty.	Page
● 689.001	4/100	354
● 689.002	4/100	354
● 689.003	4/60	354
● 689.004	48	354
● 689.005	54	354
● 689.006	40	354
● 689.204	40	354
● 689.205	42	354
● 689.206	48	354

690		
Cat.numb.	Pack qty.	Page
● 690.4200-00	1	342
● 690.4200-295	1	409
● 690.4200-300	1	409
● 690.4200-301	1	409

692		
Cat.numb.	Pack qty.	Page
● 692.4200-00	1	342
● ✓ 692.4201-00	1	341
● ✓ 692.4202-00	1	341
● ✓ 692.4203-00	1	342
● ✓ 692.4204-00	1	342
● ✓ 692.4205-00	1	342
● ✓ 692.4206-00	1	342
● 692.4300-00	1	343
● 692.4300-305	1	408
● 692.4300-69	1	408
● 692.4300-70	1	408
● 692.4330	1	343
● 692.4340	1	318
● 692.4342	1/5	318

707		
Cat.numb.	Pack qty.	Page
● 707.1105	1/12	576
● 707.1205	1/12	577
● 707.1210	1/12	577
● 707.1215	1/12	577

707		
Cat.numb.	Pack qty.	Page
● 707.2110	1/12	576
● 707.2115	1/12	576
● 707.2220	1/12	577

709		
Cat.numb.	Pack qty.	Page
● 709.2405	1/12	575
● 709.2505	1/12	575
● 709.2605	1/12	575
● + 709.3310	1/6	575
● + 709.3410	1/6	575
● + 709.3415	1/6	575
● 709.3510	1/6	575
● 709.3610	1/6	575
● 709.3705	1/6	575
● 709.3710	1/6	575
● + 709.3810	1/6	575
● 709.3910	1/6	575
● + 709.4320	1/6	575
● + 709.4420	1/6	575
● 709.4615	1/6	575
● 709.4620	1/6	575
● 709.4715	1/6	575
● 709.4720	1/6	575
● + 709.4820	1/6	575
● + 709.4920	1/6	575

745		
Cat.numb.	Pack qty.	Page
✓ 745.0000-000	1	457
● 745.3005-003	1	453
● 745.3005-006	1	453
● 745.3005-008	1	453
● 745.3005-012	1	453
● 745.3005-013	1	453
● 745.3005-094	1	453
● 745.3005-096	1	453
● 745.3005-441	1	453
● 745.3505-003	1	453
● 745.3505-006	1	453
● 745.3505-008	1	453
● 745.3505-012	1	453
✓ 745.3505-012.P	1	457
● 745.3505-013	1	453
● 745.3505-094	1	453
● 745.3505-096	1	453
● 745.3505-441	1	453
● 745.5005-003	1	453
● 745.5005-006	1	453
● 745.5005-008	1	453
● 745.5005-012	1	453
● 745.5005-013	1	453
● 745.5005-094	1	453
● 745.5005-096	1	453
● 745.5505-003	1	453
● 745.5505-006	1	453
✓ 745.5505-006.P	1	457
● 745.5505-008	1	453

745		
Cat.numb.	Pack qty.	Page
● 745.5505-012	1	453
✓ 745.5505-012.P	1	457
● 745.5505-013	1	453
● 745.5505-094	1	453
● 745.5505-096	1	453

746		
Cat.numb.	Pack qty.	Page
✓ 746.0000-000	1	456
● 746.2010-052	1	449
✓ 746.2010-052.P	1	456
● 746.2010-075	1	449
● + 746.2010-093	1	449
● + 746.2010-101	1	449
● 746.2010-102	1	449
● + 746.2010-390	1	449
● + 746.2025-352	1	451
● 746.2510-075	1	449
● + 746.2510-093	1	449
● + 746.2512-352	1	449
● + 746.2525-352	1	451
● 746.3000-010	1	447
✓ 746.3000-010.P	1	456
● + 746.3000-349	1	447
● 746.3000-384	1	447
● 746.3000-385	1	447
✓ 746.3000-385.P	1	456
● + 746.3000-388	1	447
● + 746.3000-389	1	447
● + 746.3005-894	1	447
● + 746.3005-895	1	447
● 746.3010-054	1	449
✓ 746.3010-054.P	1	456
● 746.3010-056	1	449
✓ 746.3010-056.P	1	456
● 746.3010-077	1	449
✓ 746.3010-077.P	1	456
● 746.3010-091	1	449
● + 746.3025-350	1	451
● + 746.3025-351	1	451
● 746.3510-077	1	449
✓ 746.3510-077.P	1	456
● 746.3510-091	1	449
✓ 746.3510-091.P	1	456
● 746.3512-350	1	449
● + 746.3512-351	1	449
● + 746.3525-350	1	451
● + 746.3525-351	1	451
● 746.4000-010	1	447
✓ 746.4000-010.P	1	456
● + 746.4000-349	1	447
● 746.4000-384	1	447
● 746.4000-385	1	447
✓ 746.4000-385.P	1	456
● + 746.4000-388	1	447
● + 746.4000-389	1	447
● + 746.4005-895	1	447
● + 746.4005-896	1	447
● + 746.4005-897	1	447
● + 746.4005-898	1	447

749		
Cat.numb.	Pack qty.	Page
● 749.3005-350	1	455
● 749.3005-351	1	455
● 749.3005-352	1	455
● 749.3005-353	1	455
● 749.3005-354	1	455
● 749.3505-350	1	455
● 749.3505-351	1	455
● 749.3505-352	1	455
● 749.3505-353	1	455
● 749.3505-354	1	455
● 749.5005-350	1	455
● 749.5005-351	1	455
● 749.5005-352	1	455
● 749.5505-350	1	455
● 749.5505-351	1	455
● 749.5505-352	1	455

749		
Cat.numb.	Pack qty.	Page
● 749.5005-350	1	455
● 749.5005-351	1	455
● 749.5005-352	1	455
● 749.5505-350	1	455
● 749.5505-351	1	455
● 749.5505-352	1	455

751		
Cat.numb.	Pack qty.	Page
● 751.0210-D	1	442
● 751.0215-D	1	442
● 751.0225-D	1	442
● 751.0310-D	1	442
● 751.0315-D	1	442
● 751.0325-D	1	442
● 751.1315-D	1	442
● 751.7210-D	1	443
● 751.9210	1	443

756		
Cat.numb.	Pack qty.	Page
● 756.9211	1	445

770		
Cat.numb.	Pack qty.	Page
● 770.200	1/24	370
● 770.207	1/24	370
● 770.208	1/18	370
● + 770.250	1/24	370
● 770.400	1/6	371
● + 770.405	1/6	371
● 770.406	1/6	371
● 770.407	1/6	371
● 770.408	1/6	371
● + 770.409	1/6	371
● 770.410	1/6	371

780		
Cat.numb.	Pack qty.	Page
● + 780.2262	12	364
● 780.2762	12	364

781		
Cat.numb.	Pack qty.	Page
● + 781.2260	1/12	364
● + 781.2261	1/12	364
● 781.2760	1/12	364
● 781.2761	1/12	364
● + 781.2761/1	1	365
● + 781.2761/2	1	365
● + 781.2761/3	1	365

786		
Cat.numb.	Pack qty.	Page
● 786.0100	1/12	366
● 786.0200	1/12	367
● 786.0210	1/12	367
● + 786.0220	1/12	367
● + 786.2260	1/12	364
● + 786.2261	1/12	364
● 786.2760	1/12	364
● 786.2761	1/12	364

790		
Cat.numb.	Pack qty.	Page
790.101	1/6	369
+ 790.102	1/6	369
+ 790.301	1/6	369
+ 790.302	1/6	369

791		
Cat.numb.	Pack qty.	Page
● + 791.12210	1/6	368
● 791.12710	1/6	368
● + 791.22210	1/6	368
● + 791.22710	1/6	368
● + 791.32210	1/6	369
● 791.32710	1/6	369

796		
Cat.numb.	Pack qty.	Page
● + 796.12210	1/6	368
● 796.12710	1/6	368
● + 796.22210	1/6	368
● 796.22710	1/6	368
● + 796.32210	1/6	369
● 796.32710	1/6	369

805		
Cat.numb.	Pack qty.	Page
805.3304	100/1000	469
805.3305	100/1000	469
805.3306	50/500	469
805.3307	25/200	469
805.3314	100/1000	469
+ 805.3314HF	100/1000	469
+ 805.3315	100/1000	469

805		
Cat.numb.	Pack qty.	Page
+ 805.3315HF	100/1000	469
+ 805.3324	100/1000	469
+ 805.3324HF	100/1000	469
+ 805.3325	100/1000	469
+ 805.3325HF	100/1000	469
+ 805.3334	10/50	468
805.3335	10/50	468
805.3336	10/50	468
805.3337	5/25	468
805.3340	50/600	464
● + 805.3340.0	50/600	465
● 805.3340.1	50/600	465
● + 805.3340.2	50/600	465
● 805.3341	50/600	464
● 805.3341.0	50/600	465
● 805.3341.1	50/600	465
● + 805.3341.2	50/600	465
● 805.3342	25/500	464
● 805.3342.0	25/500	465
● + 805.3342.1	25/500	465
● + 805.3342.2	25/500	465
● 805.3343	25/600	464
● + 805.3343.0	25/500	465
● 805.3343.1	25/500	465
● + 805.3343.2	25/500	465
● 805.3344	25/300	464
● 805.3344.0	25/300	465
● + 805.3344.1	25/300	465
● 805.3344.2	25/300	465
● 805.3345	25/400	464
● 805.3345.0	25/400	465
● + 805.3345.1	25/400	465
● + 805.3345.2	25/400	465
● 805.3346	25/350	464
● 805.3346.0	25/350	465
● 805.3346.1	25/350	465
● + 805.3346.2	25/350	465
● 805.3347	10/140	464
● + 805.3347.0	10/140	465
● + 805.3347.1	10/140	465
● + 805.3347.2	10/140	465
● 805.3348	10/100	464
● + 805.3348.0	10/100	465
● + 805.3348.1	10/100	465
● + 805.3348.2	10/100	465
● 805.3349	10/100	464
● + 805.3349.0	10/100	465
● + 805.3349.1	10/100	465
● + 805.3349.2	10/100	465
● 805.3350	50/600	466
● 805.3351	50/600	466
● 805.3352	25/500	466
● 805.3353	25/500	466
● 805.3354	25/300	466
● 805.3355	25/400	466
● 805.3356	25/350	466
● 805.3357	10/140	466
● 805.3358	10/100	466
● 805.3359	10/100	466
● 805.3360	100/1000	467
● 805.3361	100/1000	467
● 805.3362	100/1000	467



## Index by product number

805		
Cat.numb.	Pack qty.	Page
805.3363	100/1000	467
805.3364	100/1000	467
805.3365	100/1000	467
805.3366	50/500	467
805.3367	50/500	467
805.3368	50/500	467
805.3369	50/500	467
◆ 805.3370	100/1000	467
◆ 805.3371	100/1000	467
◆ 805.3372	100/1000	467
◆ 805.3373	100/1000	467
◆ 805.3374	100/1000	467
◆ 805.3375	100/1000	467
◆ 805.3376	50/500	467
◆ 805.3377	50/500	467
◆ 805.3378	50/500	467
◆ 805.3379	50/500	467
805.3380	100/1000	467
805.3381	100/1000	467
805.3382	100/1000	467
805.3383	100/1000	467
805.3384	100/1000	467
805.3385	100/1000	467
805.3386	50/500	467
805.3387	25/250	467
805.3388	25/250	467
805.3389	25/250	467
805.3390	100/1000	467
805.3391	100/1000	467
805.3392	100/1000	467
805.3393	100/1000	467
805.3394	100/1000	467
805.3395	100/1000	467
805.3396	50/500	467
805.3397	50/500	467
805.3398	50/500	467
805.3399	50/500	467
805.5020	100/1000	95
805.5025	100/1000	95
805.5032	100/1000	95
805.5225	10/50	468
805.5240	5/25	468
805.5325	10/50	468
805.5340	5/25	468
● 805.5412	50/600	464
● ◆ 805.5412.0	50/600	465
● ◆ 805.5412.1	50/600	465
● ◆ 805.5412.2	50/600	465
● 805.5416	50/600	464
● 805.5416.0	50/600	465
● ◆ 805.5416.1	50/600	465
● 805.5416.2	50/600	465
● 805.5420	25/500	464
● 805.5420.0	25/500	465
● 805.5420.1	25/500	465
● ◆ 805.5420.2	25/500	465
● 805.5425	25/400	464
● 805.5425.0	25/400	465
● 805.5425.1	25/400	465
● ◆ 805.5425.2	25/400	465
● 805.5432	25/350	464
● ◆ 805.5432.0	25/350	465

805		
Cat.numb.	Pack qty.	Page
● ◆ 805.5432.1	25/350	465
● ◆ 805.5432.2	25/350	465
● 805.5440	10/140	464
● ◆ 805.5440.0	10/140	465
● ◆ 805.5440.1	10/140	465
● ◆ 805.5440.2	10/140	465
● 805.5450	10/100	464
● ◆ 805.5450.0	10/100	465
● ◆ 805.5450.1	10/100	465
● ◆ 805.5450.2	10/100	465
● 805.5463	10/100	464
● ◆ 805.5463.0	10/100	465
● ◆ 805.5463.1	10/100	465
● ◆ 805.5463.2	10/100	465
● ◆ 805.5512	50/600	466
● 805.5516	50/600	466
● 805.5520	25/500	466
● 805.5525	25/400	466
● 805.5532	25/350	466
● ◆ 805.5540	10/140	466
● ◆ 805.5550	10/100	466
● ◆ 805.5563	10/100	466
◆ 805.5612	100/1000	467
805.5616	100/1000	467
805.5620	100/1000	467
805.5625	100/1000	467
805.5632	50/500	467
805.5640	50/500	467
805.5650	50/500	467
805.5663	50/500	467
◆ 805.5712	100/1000	467
◆ 805.5716	100/1000	467
◆ 805.5720	100/1000	467
◆ 805.5725	100/1000	467
◆ 805.5732	50/500	467
◆ 805.5740	50/500	467
◆ 805.5750	50/500	467
◆ 805.5763	50/500	467
◆ 805.5812	100/1000	467
◆ 805.5816	100/1000	467
◆ 805.5820	100/1000	467
805.5825	100/1000	467
◆ 805.5832	50/500	467
805.5840	25/250	467
805.5850	25/250	467
805.5863	25/250	467
◆ 805.5912	100/1000	467
805.5916	100/1000	467
805.5920	100/1000	467
◆ 805.5925	100/1000	467
◆ 805.5932	100/1000	467
◆ 805.5940	50/500	467
◆ 805.5950	50/500	467
◆ 805.5963	50/500	467
● ◆ 805.7340	50/600	464
● ◆ 805.7341	50/600	464
● ◆ 805.7343	25/500	464
● ◆ 805.7344	25/300	464
● ◆ 805.7345	25/400	464
● ◆ 805.7346	25/350	464
● ◆ 805.7347	10/140	464
● ◆ 805.7348	10/140	464

805		
Cat.numb.	Pack qty.	Page
● ◆ 805.7349	10/100	464
● ◆ 805.7350	50/600	466
● 805.7351	50/600	466
● ◆ 805.7353	25/500	466
● ◆ 805.7354	25/300	466
● ◆ 805.7355	25/400	466
● ◆ 805.7356	25/350	466
● ◆ 805.7357	10/140	466
● 805.7358	10/140	466
● ◆ 805.7359	10/100	466

810		
Cat.numb.	Pack qty.	Page
● ◆ 810.372/AS	100/600	487
● ◆ 810.372/B	100/600	486
● ◆ 810.372/G	100/600	486
● ◆ 810.372/M	100/600	486
● ◆ 810.372/N	100/600	486
● 810.372/TR	600/6000	486
● ◆ 810.372/V	100/600	486
● 810.374/AS	1000/4000	487
● ◆ 810.374/B	100/1000	486
● 810.374/G	100/1000	486
● ◆ 810.374/M	100/1000	486
● ◆ 810.374/N	100/1000	486
● 810.374/TR	1000/4000	486
● ◆ 810.374/V	100/1000	486
● 810.375/AS	100/1000	487
● ◆ 810.375/B	100/1000	486
● ◆ 810.375/G	100/1000	486
● ◆ 810.375/M	100/1000	486
● ◆ 810.375/N	100/1000	486
● 810.375/TR	100/1000	486
● ◆ 810.375/V	100/1000	486
● 810.376/AS	100/1000	487
● ◆ 810.376/B	100/1000	486
● ◆ 810.376/G	100/1000	486
● ◆ 810.376/M	100/1000	486
● ◆ 810.376/N	100/1000	486
● 810.376/TR	100/1000	486
● ◆ 810.376/V	100/1000	486
● 810.378/AS	100/1000	487
● ◆ 810.378/B	100/1000	486
● ◆ 810.378/G	100/1000	486
● ◆ 810.378/M	100/1000	486
● ◆ 810.378/N	100/1000	486
● 810.378/TR	100/1000	486
● ◆ 810.378/V	100/1000	486
● ◆ 810.379/AS	50/500	487
● ◆ 810.379/B	50/500	486
● ◆ 810.379/G	50/500	486
● ◆ 810.379/M	50/500	486
● ◆ 810.379/N	50/500	486
● 810.379/TR	50/500	486
● ◆ 810.379/V	50/500	486
● 810.425/TR	10/100	486
● 810.435/TR	5/250	486

812		
Cat.numb.	Pack qty.	Page
● 812.372	10/200	488
● 812.374	10/400	488
● 812.375	10/400	488
● 812.376	10/200	488
● 812.378	10/150	488
● 812.379	10/60	488

815		
Cat.numb.	Pack qty.	Page
● 815.1361	50/800	494
● 815.1362	50/400	494
● 815.13625	50/400	494
● 815.1363	25/300	494
● 815.1364	25/150	494
● 815.1365	15/60	494
● 815.1366	10/40	494
● 815.2361	50/800	493
● 815.2361B	50/800	493
● 815.2362	50/400	493
● 815.23625	50/400	493
● 815.23625B	50/400	493
● 815.2362B	50/400	493
● 815.2363	25/300	493
● 815.2363B	25/300	493
● 815.2364	25/150	493
● 815.2364B	25/150	493
● 815.2365	15/60	493
● 815.2365B	15/60	493
● 815.2366	10/40	493
● 815.2366B	10/40	493

817		
Cat.numb.	Pack qty.	Page
817.001	10/500	492
● 817.0602	25/650	489
● 817.0603	25/400	490
● 817.0605	10/270	490
● 817.1602	10/270	489
● 817.1603	10/270	490
● 817.1605	10/260	490
● 817.1606C	10/260	491
● 817.3502	10/160	489
● 817.3503	10/260	490
● 817.3506C	10/120	491

818		
Cat.numb.	Pack qty.	Page
818.2	100/1000	480

820		
Cat.numb.	Pack qty.	Page
820.610	100/1000	502
820.612	100/1000	502
◆ 820.614	100/1000	502
820.616	100/1000	502

820		
Cat.numb.	Pack qty.	Page
820.620	100/1000	502
820.622	100/1000	502
820.625	100/1000	502
820.628	100/1000	502
820.632	100/1000	502
820.640	100/1000	502
820.650	50/400	502
820.710	200/1000	502
820.710/P	100/1000	502
820.712	200/1000	502
820.712/P	100/1000	502
820.714	200/1000	502
820.714/P	100/1000	502
820.716	100/1000	502
820.716/P	100/1000	502
820.720	100/1000	502
820.720/P	100/1000	502
820.722	100/1000	502
820.722/P	100/1000	502
820.725	100/1000	502
820.725/P	100/1000	502
820.732/P	100/1000	502
820.740/P	100/500	502
820.750/P	50/500	502
820.810	100/1000	502
820.813	100/1000	502
820.816	100/1000	502
820.819	100/1000	502
820.822	100/1000	502
820.826	100/1000	502
820.828	100/1000	502
820.832	100/1000	502
820.838	100/1000	502
820.850	50/500	502

830		
Cat.numb.	Pack qty.	Page
830.30/10	100/5000	480
830.30/10G	100/5000	480
◆ 830.30/12	100/3000	480
830.30/12G	100/3000	480
830.30/14G	100/3000	480
830.30/16G	100/5000	480
830.30/19G	100/3000	480
830.30/22G	100/1000	480
830.30/26G	100/1000	480
◆ 830.30/28G	100/1000	480
830.30/3-4	100/5000	480
830.30/3-4G	100/5000	480
830.30/32G	100/1000	480
830.30/5	100/5000	480
830.30/5G	100/5000	480
830.30/6	100/5000	480
830.30/6G	100/5000	480
830.30/7	100/5000	480
830.30/7G	100/5000	480
830.30/8	100/5000	480
830.30/8G	100/5000	480
830.30/P11	100/1000	479
◆ 830.30/P11G	100/1000	479

830		
Cat.numb.	Pack qty.	Page
◆ 830.30/P13	100/1000	479
◆ 830.30/P13G	100/1000	479
830.30/P3	100/5000	479
◆ 830.30/P3G	100/5000	479
830.30/P5	100/3000	479
◆ 830.30/P5G	100/3000	479
830.30/P6	100/5000	479
◆ 830.30/P6G	100/5000	479
830.30/P8	100/3000	479
830.30/P8G	100/3000	479

839		
Cat.numb.	Pack qty.	Page
839.39/100	100/1000	473
839.39/101	100/1000	474
◆ 839.39/102	100/1000	474
839.39/103	100/1000	474
839.39/104	20	472
● ◆ 839.39/6115	100/2000	471
● ◆ 839.39/6175	100/2000	471
● ◆ 839.39/9120	100/2000	471
● 839.39/9180	100/2000	471
● 839.39/9260	100/2000	471
● 839.39/9350	100/2000	471
● 839.42080	100/2000	470
● 839.42100	100/2000	470
● 839.42120	100/2000	470
● 839.42160	100/2000	470
● 839.42200	100/2000	470
● 839.43140	100/2000	470
● 839.43200	100/2000	470
● 839.43300	100/2000	470
● 839.43370	100/2000	470
● 839.44190	100/2000	470
● 839.44200	100/2000	470
● 839.44250	100/2000	470
● 839.44300	100/2000	470
● 839.44370	100/2000	470
● 839.44430	100/2000	470
● 839.47200	100/2000	470
● 839.47290	100/2000	470
● 839.47370	100/2000	470
● 839.47780	100/1000	470
● 839.52080	100/2000	470
● 839.52100	100/2000	470
● 839.52120	100/2000	470
● 839.52160	100/2000	470
● 839.52200	100/2000	470
● 839.53140	100/2000	470
● 839.53200	100/2000	470
● 839.53300	100/2000	470
● 839.53370	100/2000	470
● 839.54190	100/2000	470
● 839.54200	100/2000	470
● 839.54250	100/2000	470
● 839.54300	100/2000	470
● 839.54370	100/2000	470
● 839.54430	100/2000	470
● 839.57200	100/2000	470
● 839.57290	100/2000	470

839		
Cat.numb.	Pack qty.	Page
● 839.57370	100/2000	470
● 839.57780	100/1000	470

845		
Cat.numb.	Pack qty.	Page
845.46	50/500	475
845.46/1	50/1000	475
845.46/2	50/500	475

846		
Cat.numb.	Pack qty.	Page
846.13-10	100/2000	476
◆ 846.13-4	100/2000	476
846.13-5	100/2000	476
846.13-6	100/2000	476
◆ 846.13-7	100/2000	476
846.13-8	100/2000	476
846.14-10	100/2000	476
846.14-4	100/2000	476
846.14-5	100/2000	476
846.14-6	100/2000	476
846.14-7	100/2000	476
846.14-8	100/2000	476

860		
Cat.numb.	Pack qty.	Page
860.01620	100/1200	501
860.02532	50/600	501
860.04050	40/300	501
● 860.1116/G	50/800	503
● 860.1120/G	50/600	503
● 860.1125/G	50/400	503
● 860.1132/G	25/200	503
● 860.1216/G	50/800	503
● 860.1220/G	50/400	503
● 860.1225/G	25/300	503
● 860.1232/G	20/160	503
● 860.1316/G	100/1000	500
● 860.1320/G	100/1000	500
● 860.1325/G	100/800	500
● 860.1332/G	100/800	500
● 860.1340/G	50/400	500
● 860.1350/G	25/250	500
● 860.1516	100/1000	500
● 860.1520	100/1000	500
● 860.1525	100/800	500
● 860.1532	50/500	500
● 860.1540	50/400	500
● 860.1550	25/250	500
860.1616	100/1000	501
860.1640	100/500	501
● 860.2016	100/1000	501
● 860.2020	100/1000	501
● 860.2025	100/800	501
● 860.2032	50/400	501

862		
Cat.numb.	Pack qty.	Page
● 862.1016/G	100/1200	503
● 862.1020/G	100/800	503
● 862.1025/G	50/600	503
● 862.1032/G	25/300	503
● 862.1040/G	20/160	503
● 862.1050/G	20/120	503
862.1916	100/2000	503
862.1920	100/1200	503
862.1925	50/700	503
862.1932	25/400	503
862.1940	300	503
862.1950	150	503
● 862.916/G	50/800	503
● 862.920/G	50/400	503
● 862.925/G	25/200	503
● 862.932/G	25/150	503
● 862.940/G	15/60	503
● 862.950/G	10/40	503

864		
Cat.numb.	Pack qty.	Page
● ◆ 864.0601	50/1200	506
● ◆ 864.0603	50/1200	506
● ◆ 864.0605	50/800	506
● ◆ 864.0606	50/800	506
● ◆ 864.0607	50/400	506
● ◆ 864.0609	25/300	506
● ◆ 864.0611	20/160	506
● 864.0653	50/1200	506
● 864.0655	50/800	506
● 864.0657	50/400	506
● 864.0659	25/300	506
● 864.0661	25/200	506
● 864.0663	15/120	506
● 864.0665	10/80	506
● ◆ 864.2016	50	504
● ◆ 864.2020	50	504
● ◆ 864.2025	50	504
● ◆ 864.2032	25	504
● ◆ 864.2040	25	504
● ◆ 864.2050	15	504
● 864.216	50/600	504
● 864.220	50/400	504
● 864.225	25/200	504
● 864.232	25/100	504
● 864.240	15/60	504
● 864.250	10/40	504
● 864.316	50/800	504
● 864.320	50/600	504
● 864.325	50/400	504
● 864.332	25/200	504
● 864.340	20/160	504
● 864.350	10/80	504
● 864.516	50/800	504
● 864.520	50/600	504
● 864.525	50/400	504
● 864.532	25/300	504
● 864.540	25/200	504
● 864.550	15/120	504
● 864.601	50/1200	506

## Index by product number

864		
Cat.numb.	Pack qty.	Page
● 864.603	50/120	506
● 864.605	50/800	506
● 864.606	50/800	506
● 864.607	50/400	506
● 864.609	25/300	506
● 864.611	25/200	506
● + 864.651	50/1200	506
● 864.653	50/1200	506
● 864.655	50/800	506
● 864.657	50/400	506
● 864.659	25/300	506
● 864.661	25/200	506
● 864.663	15/120	506
● 864.665	10/80	506
● + 864.7016	50/800	505
● + 864.7020	50/600	505
● + 864.7025	50/400	505
● + 864.7032	25/200	505
● + 864.7040	20/160	505
● + 864.7050	15/120	505
● 864.716	50/800	505
● 864.720	50/600	505
● 864.725	50/400	505
● 864.732	25/200	505
● 864.740	20/160	505
● 864.750	15/120	505
● + 864.8016	50/600	505
● + 864.8020	50/400	505
● + 864.8025	25/200	505
● + 864.8032	20/160	505
● + 864.8040	15/120	505
● + 864.8050	10/80	505
● 864.816	50/600	505
● 864.820	50/400	505
● 864.825	25/200	505
● 864.832	20/160	505
● 864.840	15/120	505
● 864.850	10/80	505
● + 864.9016	50	504
● + 864.9020	50	504
● + 864.9025	50	504
● + 864.9032	25	504
● + 864.9040	25	504
● + 864.9050	15	504

865		
Cat.numb.	Pack qty.	Page
● 865.002	200/1600	477
● 865.003	200/1000	477
● 865.004	200/1000	477
● 865.005	200/1000	477
● 865.006	200/600	477
● 865.007	200/600	477
● 865.008	200/400	477
● 865.009	200/600	477
● 865.010	200/400	477
● 865.012	100/200	477
● 865.014	100/200	477
● 865.016	100/200	477
● 865.018	100/200	477

865		
Cat.numb.	Pack qty.	Page
● 865.020	50/150	477
● 865.022	50/150	477
● 865.024	50/100	477
● 865.026	50/100	477
● 865.028	50/150	477
● 865.030	50/100	477
● 865.036	25/100	477
● 865.040	25/50	477
● 865.106	200/800	477
● 865.200	50/500	483
● + 865.210	20	481
● + 865.211	20	481
● 865.220	40	482
● 865.221	40	482
● 865.230	20	481
● 865.231	20	481
● + 865.240	100	482
● + 865.241	100	482
● 865.603	25/700	478
● 865.604	25/600	478
● 865.606	25/500	478
● 865.608	25/400	478
● 865.610	25/200	478
● 865.612	20/160	478
● 865.614	20/120	478

866		
Cat.numb.	Pack qty.	Page
● 866.216	10/200	507
● 866.220	10/200	507
● 866.225	10/160	507
● 866.232	10/100	507
● 866.240	5/50	507
● 866.250	5/20	507
● 866.316	10/200	507
● 866.320	10/200	507
● 866.325	10/160	507
● 866.332	10/100	507
● 866.340	5/50	507
● 866.350	5/20	507
● 866.516	10/240	507
● 866.520	10/240	507
● 866.525	10/200	507
● 866.532	10/100	507
● 866.540	5/60	507
● 866.550	5/40	507
● 866.816	10/240	507
● 866.820	10/240	507
● 866.825	10/200	507
● 866.832	10/100	507
● 866.840	5/60	507
● 866.850	5/40	507

871		
Cat.numb.	Pack qty.	Page
● 871.060	24	531
● 871.080	16	531
● 871.110	8	531

871		
Cat.numb.	Pack qty.	Page
● 871.AE060	12	532
● 871.AE080	9	532
● 871.AE110	6	532
● 871.AEV060	8	532
● 871.AEV080	6	532
● 871.AI060	8	532
● 871.AI080	6	532
● 871.AI110	4	532
● 871.AIV060	6	532
● 871.AIV080	4	532
● 871.AP060	10	532
● 871.AP080	8	532
● 871.AP110	6	532
● 871.APV060	8	532
● 871.APV080	6	532
● 871.AV101	1	535
● 871.AV201	1	535
● 871.AV202	1	535
● 871.AVD060	6	532
● 871.AVD080	4	532
● 871.AVS060	6	532
● 871.AVS080	4	532
● 871.CM060	9	532
● 871.CM080	6	532
● 871.CM110	4	532
● 871.GF060	6	532
● 871.GF080	4	532
● 871.GT080	4	532
● 871.GT110	2	532
● 871.GU060	30	532
● 871.GU080	30	532
● 871.GU110	20	532
● 871.GY16	20	534
● 871.MP100	1	535
● 871.MP140	1	535
● 871.PA85	15	534
● 871.PK85	5	534
● 871.RD060	12	534
● 871.RD080	8	534
● 871.SP001	24	534
● 871.SP035	2	534
● 871.SP045	2	534
● 871.SP100	4	534
● 871.TF060	30	533
● 871.TF080	30	533
● 871.TF110	20	533
● 871.TM060	10	533
● 871.TM080	8	533
● 871.TM110	8	533
● 871.TT060	12	533
● 871.TT080	9	533

872		
Cat.numb.	Pack qty.	Page
● 872.04040	60	525
● 872.06040	40	525
● 872.06060	32	525
● 872.08060	24	525
● 872.10060	18	525
● 872.10080	16	525

872		
Cat.numb.	Pack qty.	Page
● 872.15060	12	525
● 872.15080	8	525
● 872.20080	8	525
● 872.AE04040	10/60	525
● 872.AE06040	10/40	525
● 872.AE06060	10/40	525
● 872.AE08060	10/30	525
● 872.AE10060	8/16	525
● 872.AE10080	8/16	525
● 872.AE15060	1/6	525
● 872.AE15080	1/6	525
● 872.AE20080	1/4	525
● 872.AI04040	10/60	525
● 872.AI06040	10/60	525
● 872.AI06060	10/40	525
● 872.AI08060	10/30	525
● 872.AI10060	10/30	525
● 872.AI10080	10/20	525
● 872.AI15060	1/8	525
● 872.AI15080	1/6	525
● 872.AI20080	1/4	525
● 872.AP04040	10/120	525
● 872.AP06040	10/60	525
● 872.AP06060	10/40	525
● 872.AP08060	10/20	525
● 872.AP10060	1/20	525
● 872.AP10080	10/20	525
● 872.AP15060	1/12	525
● 872.AP15080	1/9	525
● 872.AP20080	1/6	525
● 872.CS40	100	529
● 872.CS60	72	529
● 872.GL02	10	526
● 872.GP40	20	526
● 872.GP60	20	526
● 872.GP80	20	526
● 872.GT40	20	526
● 872.GT60	10	526
● 872.GT80	10	526
● 872.GU040	20	526
● 872.GU060	20	526
● 872.GU080	20	526
● 872.GU100	20	526
● 872.GU150	20	526
● 872.GU200	20	526
● 872.GV02	10	526
● 872.MP01	20/80	529
● 872.MP02	1/20	529
● 872.PA02	1/20	528
● 872.PA080	20	528
● 872.PA100	15	528
● 872.PA150	15	528
● 872.PA200	10	528
● 872.PB02	1/30	527
● 872.PB04	1/20	527
● 872.PB080	20	527
● 872.PB100	15	527
● 872.PB150	15	527
● 872.PB200	10	527
● 872.PC02	1/30	528
● 872.PC080	20	528
● 872.PC100	15	528

872		
Cat.numb.	Pack qty.	Page
● 872.PC150	15	528
● 872.PC200	10	528
● 872.PD150	10	528
● 872.PD200	10	528
● 872.SA40	1/10	527
● 872.SA60	1/4	527
● 872.SCO1	1/9	527
● 872.SCO2	1/10	527
● 872.TA02	1/10	529
● 872.TB100	20	529
● 872.TB150	20	529
● 872.TC10060	10/120	529
● 872.TC10080	10/120	529
● 872.TE060	20	529
● 872.TE080	20	529
● 872.TE100	20	529
● 872.TF100	20	529
● 872.TF150	20	529
● 872.TF200	20	529
● 872.TT04040	20	526
● 872.TT06040	20	526
● 872.TT06060	20	526
● 872.TT08060	20	526
● 872.TT10060	20	526
● 872.TT10080	20	526
● 872.TT15060	20	526
● 872.TT15080	20	526
● 872.TT20080	20	526

874		
Cat.numb.	Pack qty.	Page
● + 874.0040	24	530
● 874.0060	20	530
● 874.0080	16	530
● + 874.0240	20	530
● + 874.0260	14	530
● + 874.0280	12	530
● 874.2530	98	530
● 874.2540	48	530
● 874.2560	34	530
● + 874.2580	28	530
● 874.4030	38	530
● 874.4040	30	530
● 874.4060	22	530
● 874.4080	36	530
● 874.6040	40	530
● 874.6060	32	530
● 874.6080	24	530
● 874.8040	32	530
● 874.8060	24	530
● 874.8080	16	530
● + 874.R0040	24	530
● 874.R0060	20	530
● 874.R0080	16	530
● + 874.R0240	20	530
● 874.R0260	14	530
● 874.R0280	12	530
● 874.R2530	98	530
● 874.R2540	48	530
● 874.R2560	34	530

874		
Cat.numb.	Pack qty.	Page
● 874.R2580	28	530
● 874.R4030	38	530
● 874.R4040	30	530
● 874.R4060	22	530
● 874.R4080	36	530
● 874.R6040	40	530
● 874.R6060	32	530
● 874.R6080	24	530
● 874.R8040	32	530
● 874.R8060	24	530
● 874.R8080	16	530

875		
Cat.numb.	Pack qty.	Page
● 875.4201	500	356
● 875.4301	12/60	356
● 875.4303	6/300	357
● 875.4410	1/170	357
● 875.4411	1/120	357
● 875.4411P	90	357
● 875.4412	1/70	357
● 875.4413	1/44	357
● 875.4414	1/40	357
● 875.4415	1/24	357
● 875.4416	1/20	357
● 875.4417	1/12	357
● 875.4490	25/200	358
● 875.4491	25/200	358
● 875.4500	1/120	358
● 875.4501	50/600	356
● 875.4502	40/480	356
● 875.4510	5/100	358
● 875.4511	5/160	358
● 875.4512	5/140	358
● 875.4513	5/80	358
● 875.4514	5/60	358
● 875.4515	2/40	358
● 875.4516	2/30	358
● 875.4517	2/24	358
● 875.4603	120	357
● + 875.4610	5/100	359
● + 875.4611	5/160	359
● + 875.4612	5/140	359
● + 875.4613	5/80	359
● + 875.4614	5/60	359
● + 875.4615	2/40	359
● + 875.4616	2/30	359
● + 875.4617	2/24	359

876		
Cat.numb.	Pack qty.	Page
● 876.1207AD	160	510
● 876.1212AD	90	510
● 876.1612AD	70	510
● 876.2010	80	511
● + 876.2010G	80	511
● 876.2015	50	511
● 876.2015AV	50	511

876		
Cat.numb.	Pack qty.	Page
● + 876.2015G	50	511
● 876.3015	60	511
● 876.3015AV	60	511
● + 876.3015G	60	511
● 876.4010	72	511
● + 876.4010G	72	511
● 876.4015	48	511
● 876.4015AV	48	511
● + 876.4015G	48	511
● 876.4020	36	511
● 876.4020AV	36	511
● + 876.4020G	36	511
● 876.4021	36	511
● + 876.4021G	36	511
● 876.6020	32	511
● 876.6020AV	32	511
● + 876.6020G	32	511
● 876.AE2010	30	512
● + 876.AE2010G	30	512
● 876.AE2015	30	512
● + 876.AE2015G	30	512
● 876.AE3015	30	512
● + 876.AE3015G	30	512
● 876.AE4010	30	512
● + 876.AE4010G	30	512
● 876.AE4015	30	512
● + 876.AE4015G	30	512
● 876.AE4020	30	512
● + 876.AE4020G	30	512
● 876.AE6020	30	512
● + 876.AE6020G	30	512
● 876.AI2010	30	512
● + 876.AI2010G	30	512
● 876.AI2015	30	512
● + 876.AI2015G	30	512
● 876.AI3015	30	512
● + 876.AI3015G	30	512
● 876.AI4010	30	512
● + 876.AI4010G	30	512
● 876.AI4015	30	512
● + 876.AI4015G	30	512
● 876.AI4020	30	512
● + 876.AI4020G	30	512
● 876.AI6020	30	512
● + 876.AI6020G	30	512
● 876.AL2010	30	513
● + 876.AL2010G	30	513
● 876.AL2015	30	513
● + 876.AL2015G	30	513
● 876.AL3015	30	513
● + 876.AL3015G	30	513
● + 876.AL4010	6/30	513
● + 876.AL4010G	6/30	513
● + 876.AL4015	6/30	513
● + 876.AL4015G	6/30	513
● + 876.AL4020	6/30	513
● + 876.AL4020G	6/30	513
● + 876.AL6020	6/30	513
● + 876.AL6020G	6/30	513
● 876.AP2010	30	512
● + 876.AP2010G	30	512
● 876.AP2015	30	512

876		
Cat.numb.	Pack qty.	Page
● + 876.AP2015G	30	512
● 876.AP3015	30	512
● + 876.AP3015G	30	512
● 876.AP4010	30	512
● + 876.AP4010G	30	512
● 876.AP4015	30	512
● + 876.AP4015G	30	512
● 876.AP4020	30	512
● + 876.AP4020G	30	512
● 876.AP6020	30	512
● + 876.AP6020G	30	512
● 876.AT2010	30	513
● + 876.AT2010G	30	513
● 876.AT2015	30	513
● + 876.AT2015G	30	513
● 876.AT3015	30	513
● + 876.AT3015G	30	513
● 876.AT4010	30	513
● + 876.AT4010G	30	513
● 876.AT4015	30	513
● + 876.AT4015G	30	513
● 876.AT4020	30	513
● + 876.AT4020G	30	513
● 876.AT6020	30	513
● + 876.AT6020G	30	513
● 876.GT2010	30	514
● + 876.GT2010G	30	514
● 876.GT2015	30	514
● + 876.GT2015G	30	514
● 876.GT3015	30	514
● + 876.GT3015G	30	514
● 876.GT4010	30	514
● + 876.GT4010G	30	514
● 876.GT4015	30	514
● + 876.GT4015G	30	514
● 876.GT4020	30	514
● + 876.GT4020G	30	514
● 876.GT6020	30	514
● + 876.GT6020G	30	514
● 876.GU2010	30	514
● + 876.GU2010G	30	514
● 876.GU2015	30	514
● + 876.GU2015G	30	514
● 876.GU3015	30	514
● + 876.GU3015G	30	514
● 876.GU4010	30	514
● + 876.GU4010G	30	514
● 876.GU4015	30	514
● + 876.GU4015G	30	514
● 876.GU4020	30	514
● + 876.GU4020G	30	514
● 876.GU6020	30	514
● + 876.GU6020G	30	514
● + 876.PA5530	10	515
● + 876.PA5530G	10	515
● 876.PA6040	10	515
● + 876.PA6040G	10	515
● 876.PA6050	10	515
● + 876.PA6050G	10	515
● 876.PA8040	10	515
● + 876.PA8040G	10	515
● 876.PA8050	10	515



## Index by product number

876		
Cat.numb.	Pack qty.	Page
● + 876.PA8050G	10	515
● + 876.PK04	100/1000	516
● + 876.PK05	100/1000	524
● + 876.PK06	100/1000	524
● 876.PK60	10	515
● + 876.PK60G	10	515
● 876.PK80	10	515
● + 876.PK80G	10	515
● + 876.RT2010	30	514
● + 876.RT2010G	30	514
● + 876.RT2015	30	514
● + 876.RT2015G	30	514
● 876.SA70	10	516
● + 876.SA70G	10	516
● 876.TF20	30	514
● 876.TF30	30	514
● 876.TF40	30	514
● 876.TF60	30	514
● 876.TT2010	30	514
● + 876.TT2010G	30	514
● 876.TT2015	30	514
● + 876.TT2015G	30	514
● 876.TT3015	30	514
● + 876.TT3015G	30	514
● 876.TT4010	30	514
● + 876.TT4010G	30	514
● 876.TT4015	30	514
● + 876.TT4015G	30	514
● 876.TT4020	30	514
● + 876.TT4020G	30	514
● 876.TT6020	30	514
● + 876.TT6020G	30	514

879		
Cat.numb.	Pack qty.	Page
● 879.0007	20	517
● 879.0007A	20	517
● 879.0007G	20	517
● 879.0007M	20	517
● 879.0080	20	517
● 879.0080A	20	517
● 879.0080M	20	517
● 879.0120	20	517
● 879.0120A	20	517
● 879.0120M	20	517
● 879.AE0080	10	518
● 879.AE0080A	10	518
● 879.AE0080M	10	518
● 879.AE0120	10	518
● 879.AE0120A	10	518
● 879.AE0120M	10	518
● 879.AI0080	10	518
● 879.AI0080A	10	518
● 879.AI0080M	10	518
● 879.AI0120	10	518
● 879.AI0120A	10	518
● 879.AI0120M	10	518
● 879.AP0080	10	518
● 879.AP0080A	10	518
● 879.AP0080M	10	518

879		
Cat.numb.	Pack qty.	Page
● 879.AV0120	10	518
● 879.AV0120A	10	518
● 879.AV0120M	10	518
● 879.CC0080	10	519
● 879.CC0080A	10	519
● 879.CC0080M	10	519
● 879.CC0120	10	519
● 879.CC0120A	10	519
● 879.CC0120M	10	519
● 879.CC0121	10	519
● 879.CC0121A	10	519
● 879.CC0121M	10	519
● 879.CC0122	10	519
● 879.CC0122A	10	519
● 879.CC0122M	10	519
● 879.CP80	20/200	520
● 879.GM0080	10	518
● 879.GM0080A	10	518
● 879.GM0080M	10	518
● 879.GM0120	10	518
● 879.GM0120A	10	518
● 879.GM0120M	10	518
● 879.GS0080	10	518
● 879.GS0080A	10	518
● 879.GS0080M	10	518
● 879.GS0120	10	518
● 879.GS0120A	10	518
● 879.GS0120M	10	518
● 879.GT0007	10	521
● + 879.GT0007A	10	521
● + 879.GT0007G	10	521
● + 879.GT0007M	10	521
● 879.GT0080	10	518
● 879.GT0080A	10	518
● 879.GT0080M	10	518
● 879.GT0120	10	518
● 879.GT0120A	10	518
● 879.GT0120M	10	518
● 879.GU0080	10	518
● 879.GU0080A	10	518
● 879.GU0080M	10	518
● 879.GU0120	10	518
● 879.GU0120A	10	518
● 879.GU0120M	10	518
● 879.PA6050	5	521
● 879.PA6050A	5	521
● 879.PA6050M	5	521
● 879.PA6051	5	521
● + 879.PA6051A	5	521
● + 879.PA6051M	5	521
● 879.PA8040	5	522
● + 879.PA8040A	5	522
● + 879.PA8040M	5	522
● 879.PA8050	5	522
● 879.PA8050A	5	522
● 879.PA8050M	5	522
● 879.PA8051	5	522
● 879.PA8051A	5	522
● 879.PA8051M	5	522
● 879.PA8450	5	522
● + 879.PA8450A	5	522
● + 879.PA8450M	5	522

879		
Cat.numb.	Pack qty.	Page
● 879.PA8451	5	522
● + 879.PA8451A	5	522
● + 879.PA8451M	5	522
● 879.PA9050	5	523
● 879.PA9050A	5	523
● 879.PA9050M	5	523
● 879.PA9051	5	523
● 879.PA9051A	5	523
● 879.PA9051M	5	523
● 879.PB8040	5	523
● 879.PB8040A	5	523
● 879.PB8040M	5	523
● 879.PB8050	5	523
● 879.PB8050A	5	523
● 879.PB8050M	5	523
● 879.PD60	5/30	524
● 879.PD60A	5/30	524
● 879.PD60M	5/30	524
● 879.PD80	5/30	524
● 879.PD80A	5/30	524
● 879.PD80M	5/30	524
● 879.TE80	5	520
● 879.TE80A	5	520
● 879.TE80M	5	520
● 879.TF80	30	520
● 879.TM0080	5	519
● 879.TM0080A	5	519
● 879.TM0080M	5	519
● 879.TM0120	5	519
● 879.TM0120A	5	519
● 879.TM0120M	5	519
● 879.TT0080	10	519
● 879.TT0080A	10	519
● 879.TT0080M	10	519
● 879.TT0120	10	519
● 879.TT0120A	10	519
● 879.TT0120M	10	519

899		
Cat.numb.	Pack qty.	Page
● ✓ 899.AL2CE350VS	1	203
● ✓ 899.AL2CE370S	1	203
● ✓ 899.AL2CE395S	1	203
● ✓ 899.AL2CE450VS	1	203
● ✓ 899.AL2CE470S	1	203
● ✓ 899.AL2DE350V	1	202
● ✓ 899.AL2DE370	1	202
● ✓ 899.AL2DE395	1	202
● ✓ 899.AL2DE450V	1	202
● ✓ 899.AL2DE470	1	202
● ✓ 899.AL2PC	1	207
● ✓ 899.AL2PR350V	1	202
● ✓ 899.AL2PR370	1	202
● ✓ 899.AL2PR395	1	202
● ✓ 899.AL2PR450V	1	202
● ✓ 899.AL2PR470	1	202
● ✓ 899.AL5CE312S	1	205
● ✓ 899.AL5CE315S	1	205
● ✓ 899.AL5CE318S	1	205
● ✓ 899.AL5CE324S-18	1	205

899		
Cat.numb.	Pack qty.	Page
● ✓ 899.AL5CE395S	1	205
● ✓ 899.AL5CE412S	1	205
● ✓ 899.AL5CE415S	1	205
● ✓ 899.AL5CE415S-16	1	205
● ✓ 899.AL5CE418S-16	1	205
● ✓ 899.AL5CE495S	1	205
● ✓ 899.AL5DE312	1	204
● ✓ 899.AL5DE315	1	204
● ✓ 899.AL5DE318	1	204
● ✓ 899.AL5DE324-18	1	204
● ✓ 899.AL5DE395	1	204
● ✓ 899.AL5DE412	1	204
● ✓ 899.AL5DE415	1	204
● ✓ 899.AL5DE415-16	1	204
● ✓ 899.AL5DE418-16	1	204
● ✓ 899.AL5DE495	1	204
● ✓ 899.AL5PC	1	207
● ✓ 899.AL5PR312	1	204
● ✓ 899.AL5PR312S	1	205
● ✓ 899.AL5PR315	1	204
● ✓ 899.AL5PR315S	1	205
● ✓ 899.AL5PR318	1	204
● ✓ 899.AL5PR318S	1	205
● ✓ 899.AL5PR324-18	1	204
● ✓ 899.AL5PR324S-18	1	205
● ✓ 899.AL5PR395	1	204
● ✓ 899.AL5PR395S	1	205
● ✓ 899.AL5PR412	1	204
● ✓ 899.AL5PR412S	1	205
● ✓ 899.AL5PR415	1	204
● ✓ 899.AL5PR415-16	1	204
● ✓ 899.AL5PR415S	1	205
● ✓ 899.AL5PR415S-16	1	205
● ✓ 899.AL5PR418-16	1	204
● ✓ 899.AL5PR418S-16	1	205
● ✓ 899.AL5PR495	1	204
● ✓ 899.AL5PR495S	1	205
● ✓ 899.AL8CF324S	1	207
● ✓ 899.AL8CF330S	1	207
● ✓ 899.AL8CF424S	1	207
● ✓ 899.AL8CF430S	1	207
● ✓ 899.AL8DF324	1	206
● ✓ 899.AL8DF330	1	206
● ✓ 899.AL8DF424	1	206
● ✓ 899.AL8DF430	1	206
● ✓ 899.AL8PC	1	207
● ✓ 899.AL8PM324S	1	206
● ✓ 899.AL8PM330S	1	206
● ✓ 899.AL8PM424S	1	206
● ✓ 899.AL8PM430S	1	206
● ✓ 899.AS2AR350V	1	209
● ✓ 899.AS2AR370	1	209
● ✓ 899.AS2AR395	1	209
● ✓ 899.AS2AR450V	1	209
● ✓ 899.AS2AR470	1	209
● ✓ 899.AS2CE350V	1	209
● ✓ 899.AS2CE370	1	209
● ✓ 899.AS2CE395	1	209
● ✓ 899.AS2CE450V	1	209
● ✓ 899.AS2CE470	1	209
● ✓ 899.AS2DE350V	1	208
● ✓ 899.AS2DE370	1	208

899		
Cat.numb.	Pack qty.	Page
● ✓ 899.AS2DE395	1	208
● ✓ 899.AS2DE450V	1	208
● ✓ 899.AS2DE470	1	208
● ✓ 899.AS2PC	1	214
● ✓ 899.AS2PR350V	1	208
● ✓ 899.AS2PR370	1	208
● ✓ 899.AS2PR395	1	208
● ✓ 899.AS2PR450V	1	208
● ✓ 899.AS2PR470	1	208
● ✓ 899.AS5AR312	1	211
● ✓ 899.AS5AR315	1	211
● ✓ 899.AS5AR318	1	211
● ✓ 899.AS5AR324-18	1	211
● ✓ 899.AS5AR395	1	211
● ✓ 899.AS5AR412	1	211
● ✓ 899.AS5AR415	1	211
● ✓ 899.AS5AR415-16	1	211
● ✓ 899.AS5AR418-16	1	211
● ✓ 899.AS5AR495	1	211
● ✓ 899.AS5CE312	1	211
● ✓ 899.AS5CE315	1	211
● ✓ 899.AS5CE318	1	211
● ✓ 899.AS5CE324-18	1	211
● ✓ 899.AS5CE395	1	211
● ✓ 899.AS5CE412	1	211
● ✓ 899.AS5CE415	1	211
● ✓ 899.AS5CE415-16	1	211
● ✓ 899.AS5CE418-16	1	211
● ✓ 899.AS5CE495	1	211
● ✓ 899.AS5DE312	1	210
● ✓ 899.AS5DE315	1	210
● ✓ 899.AS5DE318	1	210
● ✓ 899.AS5DE324-18	1	210
● ✓ 899.AS5DE395	1	210
● ✓ 899.AS5DE412	1	210
● ✓ 899.AS5DE415	1	210
● ✓ 899.AS5DE415-16	1	210
● ✓ 899.AS5DE418-16	1	210
● ✓ 899.AS5DE495	1	210
● ✓ 899.AS5PC	1	214
● ✓ 899.AS5PR312	1	210
● ✓ 899.AS5PR315	1	210
● ✓ 899.AS5PR318	1	210
● ✓ 899.AS5PR324-18	1	210
● ✓ 899.AS5PR395	1	210
● ✓ 899.AS5PR412	1	210
● ✓ 899.AS5PR415	1	210
● ✓ 899.AS5PR415-16	1	210
● ✓ 899.AS5PR418-16	1	210
● ✓ 899.AS5PR495	1	210
● ✓ 899.AS8AM324	1	213
● ✓ 899.AS8AM330	1	213
● ✓ 899.AS8AM424	1	213
● ✓ 899.AS8AM430	1	213
● ✓ 899.AS8CF324	1	213
● ✓ 899.AS8CF330	1	213
● ✓ 899.AS8CF424	1	213
● ✓ 899.AS8CF430	1	213
● ✓ 899.AS8DF324	1	212
● ✓ 899.AS8DF330	1	212
● ✓ 899.AS8DF424	1	212
● ✓ 899.AS8DF430	1	212

899		
Cat.numb.	Pack qty.	Page
● ✓ 899.AS8PC	1	214
● ✓ 899.AS8PM324	1	212
● ✓ 899.AS8PM330	1	212
● ✓ 899.AS8PM424	1	212
● ✓ 899.AS8PM430	1	212
● ✓ 899.IN25086	1	215
● ✓ 899.IN25086F	1	215
● ✓ 899.IN25086M	1	215
● ✓ 899.IN25086RM	1	215
● ✓ 899.IN25087	1	215
● ✓ 899.IN25087F	1	215
● ✓ 899.IN25087M	1	215
● ✓ 899.IN25087RM	1	215
● ✓ 899.SD2A3NE01	1	216
● ✓ 899.SD2A3OE01	1	216
● ✓ 899.SD2A3OE03	1	216
● ✓ 899.SD2D3NE01	1	216
● ✓ 899.SD2D3OE01	1	216
● ✓ 899.SD2D3OE03	1	216
● ✓ 899.SD2G	1	216
● ✓ 899.SD2GM	1	216
● ✓ 899.SD2GMA	1	216
● ✓ 899.SD2LB	1	217
● ✓ 899.SD2P3NE01	1	216
● ✓ 899.SD2P3OE01	1	216
● ✓ 899.SD2P3OE03	1	216
● ✓ 899.SD2PC	1	217
● ✓ 899.SD2WAS	1	217

MP3		
Cat.numb.	Pack qty.	Page
◆ MP36246		417
◆ MP36247		417
◆ MP36275		417
◆ MP36276		417

SC9		
Cat.numb.	Pack qty.	Page
SC92062	20	458
SC92063	20	458
◆ SC92064		458
SC92065	1	459
SC92066	1	459
◆ SC92068	80	458
◆ SC92070		458
SC92072	80	458
SC92074	80	458
◆ SC92076		458
◆ SC92078		458
SC92080	80	458
◆ SC92082		458
◆ SC92085	1	459
SC92086	1	459
SC92088	1	459
◆ SC92089	1	459
◆ SC92092	1	459
◆ SC92094	1	459

SCM		
Cat.numb.	Pack qty.	Page
● + SCM3100B4W		192
● + SCM3100B5W		192
● + SCM3100B6W		192
● + SCM3100B7W		192
● ✓ SCM3100B8W	1	192
● + SCM3100C4W		193
● + SCM3100C5W		193
● + SCM3100C6W	1	193
● + SCM3100C7W		193
● ✓ SCM3100C8W	1	193
● + SCM3100P4W		192
● + SCM3100P5W		192
● + SCM3100P6W	1	192
● + SCM3100P7W		192
● ✓ SCM3100P8W	1	192
● + SCM3100R4W		193
● + SCM3100R5W		193
● + SCM3100R6W	1	193
● + SCM3100R7W		193
● ✓ SCM3100R8W	1	193
● SCM3125B6W	1	187
● SCM3125C6W	1	187
● SCM3125P6W	1	186
● SCM3125R6W	1	187
● + SCM316B4S	1/5	184
● + SCM316B4W	1/5	186
● + SCM316B6S	1/5	184
● + SCM316B6W	1/5	186
● + SCM316C4S	1/5	185
● + SCM316C4W	1/5	187
● + SCM316C6S	1/5	185
● + SCM316C6W	1/5	187
● + SCM316P4S	1/5	184
● + SCM316P4W	1/5	186
● + SCM316P6S	1/5	184
● + SCM316P6W	1/5	186
● + SCM316R4S	1/5	185
● + SCM316R4W	1/5	187
● + SCM316R6S	1/5	185
● + SCM316R6W	1/5	187
● + SCM320B4S	1/5	188
● + SCM320B4W	1/5	190
● + SCM320B5S	1/5	188
● + SCM320B5W	1/5	190
● + SCM320B6S	1/5	188
● + SCM320B6W	1/5	190
● + SCM320B7S	1/5	188
● + SCM320B7W	1/5	190
● + SCM320C4S	1/5	189
● + SCM320C4W	1/5	191
● + SCM320C5S	1/5	189
● + SCM320C5W	1/5	191
● + SCM320C6S	1/5	189
● + SCM320C6W	1/5	191
● + SCM320C7S	1/5	189
● + SCM320C7W	1/5	191
● ✓ SCM320M14W	1/6	198
● ✓ SCM320M14W-C	1/6	199
● ✓ SCM320M14W-NB	1/6	197
● ✓ SCM320M16W	1/6	198
● ✓ SCM320M16W-C	1/6	199
● ✓ SCM320M16W-NB	1/6	197

SCM		
Cat.numb.	Pack qty.	Page
● ✓ SCM320M17W	1/6	198
● ✓ SCM320M17W-C	1/6	199
● ✓ SCM320M17W-NB	1/6	197
● + SCM320P4S	1/5	188
● + SCM320P4W	1/5	190
● + SCM320P5S	1/5	188
● + SCM320P5W	1/5	190
● + SCM320P6S	1/5	188
● + SCM320P6W	1/5	190
● + SCM320P7S	1/5	188
● + SCM320P7W	1/5	190
● + SCM320R4S	1/5	189
● + SCM320R4W	1/5	191
● + SCM320R5S	1/5	189
● + SCM320R5W	1/5	191
● + SCM320R6S	1/5	189
● + SCM320R6W	1/5	191
● + SCM320R7S		189
● + SCM320R7W	1/5	191
● + SCM330B4S	1/5	188
● + SCM330B4W	1/5	190
● + SCM330B6S	1/5	188
● + SCM330B6W	1/5	190
● + SCM330B7S		188
● + SCM330B7W	1/5	190
● ✓ SCM330B8S	1/5	188
● ✓ SCM330B8W	1/5	190
● + SCM330C4S	1/5	189
● + SCM330C4W	1/5	191
● + SCM330C6S	1/5	189
● + SCM330C6W	1/5	191
● + SCM330C7S	1/5	189
● + SCM330C7W	1/5	191
● ✓ SCM330C8S	1	189
● ✓ SCM330C8W	1	191
● ✓ SCM330M14W	1/6	198
● ✓ SCM330M14W-C	1/6	199
● ✓ SCM330M14W-NB	1/6	197
● ✓ SCM330M16W	1/6	198
● ✓ SCM330M16W-C	1/6	199
● ✓ SCM330M16W-NB	1/6	197
● ✓ SCM330M17W	1/6	198
● ✓ SCM330M17W-C	1/6	199
● ✓ SCM330M17W-NB	1/6	197
● + SCM330P4S	1/5	188
● + SCM330P4W	1/5	190
● + SCM330P6S	1/5	188
● + SCM330P6W	1/5	190
● + SCM330P7S	1/5	188
● + SCM330P7W	1/5	190
● ✓ SCM330P8S	1/5	188
● ✓ SCM330P8W	1/5	190
● + SCM330R4S	1/5	189
● + SCM330R4W	1/5	191
● + SCM330R6S	1/5	189
● + SCM330R6W	1/5	191
● + SCM330R7S		189
● + SCM330R7W	1/5	191
● ✓ SCM330R8S	1/5	189
● ✓ SCM330R8W	1/5	191
● + SCM332B4W	1/5	186
● + SCM332B6S	1/5	184

## Index by product number

SCM			SCM			SCM			SCM		
Cat.numb.	Pack qty.	Page	Cat.numb.	Pack qty.	Page	Cat.numb.	Pack qty.	Page	Cat.numb.	Pack qty.	Page
● + SCM332B6W	1/5	186	● + SCM4100R12W	1	193	● + SCM420R5W	1/5	191	● + SCM432C6S	1/5	185
● + SCM332C4S	1/5	185	● + SCM4100R5W	1	193	● + SCM420R6S	1/5	189	● + SCM432C6W	1/5	187
● + SCM332C4W	1/5	187	● + SCM4100R6W	1/10	193	● + SCM420R6W	1/5	191	● ✓ SCM432MI3W	1/6	198
● + SCM332C6S	1/5	185	● + SCM4100R7W	1	193	● + SCM420R7S	1/5	189	● ✓ SCM432MI3W-C	1/6	199
● + SCM332C6W	1/5	187	● + SCM4100R9W	1	193	● + SCM420R7W	1/5	191	● ✓ SCM432MI3W-NB	1/6	197
● + SCM332P4S	1/5	184	● + SCM4125B6W	1	187	● + SCM420R9S	1/5	189	● + SCM432P3W	1/5	186
● + SCM332P4W	1/5	186	● + SCM4125C6W	1	187	● + SCM420R9W	1/5	191	● + SCM432P5W	1/5	186
● + SCM332P6S	1/5	184	● + SCM4125P6W	1	186	● + SCM430B12S	1/5	188	● + SCM432P6S	1/5	184
● + SCM332P6W	1/5	186	● + SCM4125R6W	1	187	● + SCM430B12W	1/5	190	● + SCM432P6W	1/5	186
● + SCM332R4S	1/5	185	● + SCM416B6S	1/5	184	● + SCM430B5S	1/5	188	● ✓ SCM432R3S	1/5	185
● + SCM332R4W	1/5	187	● + SCM416B6W	1/5	186	● + SCM430B5W	1/5	190	● ✓ SCM432R3W	1/5	187
● + SCM332R6S	1/5	185	● + SCM416C6S	1/5	185	● + SCM430B6S	1/5	188	● + SCM432R5W	1/5	187
● + SCM332R6W	1/5	187	● + SCM416C6W	1/5	187	● + SCM430B6W	1/5	190	● + SCM432R6S	1/5	185
● + SCM360B3W	1	192	● + SCM416P6S	1/5	184	● + SCM430B7S	1/5	188	● + SCM432R6W	1/5	187
● + SCM360B4W	1	192	● + SCM416P6W	1/5	186	● + SCM430B7W	1/5	190	● + SCM460B12W	1	192
● + SCM360B5W	1	192	● + SCM416R6S	1/5	185	● + SCM430B9S	1/5	188	● + SCM460B5W	1	192
● + SCM360B6W	1	192	● + SCM416R6W	1/5	187	● + SCM430B9W	1/5	190	● + SCM460B6W	1/10	192
● + SCM360B7W	1	192	● + SCM420B12S	1/5	188	● + SCM430C12S	1/5	189	● + SCM460B7W	1	192
● ✓ SCM360B8W	1	192	● + SCM420B12W	1/5	190	● + SCM430C12W	1/5	191	● + SCM460B9W	1	192
● + SCM360C3W	1	193	● + SCM420B5S	1/5	188	● + SCM430C5S	1/5	189	● + SCM460C12W	1	193
● + SCM360C4W	1	193	● + SCM420B5W	1/5	190	● + SCM430C5W	1/5	191	● + SCM460C5W	1	193
● + SCM360C5W	1	193	● + SCM420B6S	1/5	188	● + SCM430C6S	1/5	189	● + SCM460C6W	1	193
● + SCM360C6W	1	193	● + SCM420B6W	1/5	190	● + SCM430C6W	1/5	191	● + SCM460C7W	1	193
● + SCM360C7W	1	193	● + SCM420B7S	1/5	188	● + SCM430C7S	1/5	189	● + SCM460C9W	1	193
● ✓ SCM360C8W	1	193	● + SCM420B7W	1/5	190	● + SCM430C7W	1/5	191	● ✓ SCM460MI5W	1	198
● ✓ SCM360MI6W	1	198	● + SCM420B9S	1/5	188	● + SCM430C9S	1/5	189	● ✓ SCM460MI5W-C	1	199
● ✓ SCM360MI6W-C	1	199	● + SCM420B9W	1/5	190	● + SCM430C9W	1/5	191	● ✓ SCM460MI5W-NB	1	197
● ✓ SCM360MI6W-NB	1	197	● + SCM420C12S	1/5	189	● ✓ SCM430MI12W	1/6	198	● ✓ SCM460MI7W	1	198
● ✓ SCM360MI7W	1	198	● + SCM420C12W	1/5	191	● ✓ SCM430MI12W-C	1/6	199	● ✓ SCM460MI7W-C	1	199
● ✓ SCM360MI7W-C	1	199	● + SCM420C5S	1/5	189	● ✓ SCM430MI12W-NB	1/6	197	● ✓ SCM460MI9W	1	198
● ✓ SCM360MI7W-NB	1	197	● + SCM420C5W	1/5	191	● ✓ SCM430MI5W	1/6	198	● ✓ SCM460MI9W-C	1	199
● + SCM360P3W	1	192	● + SCM420C6S	1/5	189	● ✓ SCM430MI5W-C	1/6	199	● ✓ SCM460MI9W-NB	1	197
● + SCM360P4W	1	192	● + SCM420C6W	1/5	191	● ✓ SCM430MI5W-NB	1/6	197	● + SCM460P12W	1	192
● + SCM360P5W	1	192	● + SCM420C7S	1/5	189	● ✓ SCM430MI7W	1/6	199	● + SCM460P5W	1	192
● + SCM360P6W	1	192	● + SCM420C7W	1/5	191	● ✓ SCM430MI7W-C	1/6	199	● + SCM460P6W	1/6	192
● + SCM360P7W	1	192	● + SCM420C9S	1/5	189	● ✓ SCM430MI7W-NB	1/6	197	● + SCM460P7W	1	192
● ✓ SCM360P8W	1	192	● + SCM420C9W	1/5	191	● ✓ SCM430MI9W	1/6	198	● + SCM460P9W	1	192
● + SCM360R3W	1	193	● ✓ SCM420MI12W	1/6	198	● ✓ SCM430MI9W-C	1/6	199	● + SCM460R12W	1	193
● + SCM360R4W	1	193	● ✓ SCM420MI12W-C	1/6	199	● ✓ SCM430MI9W-NB	1/6	197	● + SCM460R5W	1	193
● + SCM360R5W	1	193	● ✓ SCM420MI12W-NB	1/6	197	● + SCM430P12S	1/5	188	● + SCM460R6W	1/10	193
● + SCM360R6W	1	193	● ✓ SCM420MI5W	1/6	198	● + SCM430P12W	1/5	190	● + SCM460R7W	1	193
● + SCM360R7W	1	193	● ✓ SCM420MI5W-C	1/6	199	● + SCM430P5S	1/5	188	● + SCM460R9W	1	193
● ✓ SCM360R8W	1	193	● ✓ SCM420MI5W-NB	1/6	197	● + SCM430P5W	1/5	190	● + SCM463B6W	1	186
● + SCM363B6W	1	186	● ✓ SCM420MI7W	1/6	198	● + SCM430P6S	1/5	188	● + SCM463C6W	1	187
● + SCM363C6W	1	187	● ✓ SCM420MI7W-C	1/6	199	● + SCM430P6W	1/5	190	● + SCM463P5W	1	186
● + SCM363P6W	1	186	● ✓ SCM420MI7W-NB	1/6	197	● + SCM430P7S	1/5	188	● + SCM463P6W	1	186
● + SCM363R6W	1	187	● ✓ SCM420MI9W	1/6	198	● + SCM430P7W	1/5	190	● + SCM463R5W	1/6	187
● + SCM4100B12W	1	192	● ✓ SCM420MI9W-C	1/6	199	● + SCM430P9S	1/5	188	● + SCM463R6W	1	187
● + SCM4100B5W	1	192	● ✓ SCM420MI9W-NB	1/6	197	● + SCM430P9W	1/5	190	● + SCM5100B5W	1	192
● + SCM4100B6W	1/10	192	● + SCM420P12S	1/5	188	● + SCM430R12S	1/5	189	● + SCM5100B6W	1/10	192
● + SCM4100B7W	1	192	● + SCM420P12W	1/5	190	● + SCM430R12W	1/5	191	● + SCM5100B7W	1	192
● + SCM4100B9W	1	192	● + SCM420P5S	1/5	188	● + SCM430R5S	1/5	189	● ✓ SCM5100B8W	1	192
● + SCM4100C12W	1	193	● + SCM420P5W	1/5	190	● + SCM430R5W	1/5	191	● + SCM5100B9W	1	192
● + SCM4100C5W	1	193	● + SCM420P6S	1/5	188	● + SCM430R6S	1/5	189	● + SCM5100C5W	1	193
● + SCM4100C6W	1/6	193	● + SCM420P6W	1/5	190	● + SCM430R6W	1/5	191	● + SCM5100C6W	1/6	193
● + SCM4100C7W	1	193	● + SCM420P7S	1/5	188	● + SCM430R7S	1/5	189	● + SCM5100C7W	1	193
● + SCM4100C9W	1	193	● + SCM420P7W	1/5	190	● + SCM430R7W	1/5	191	● ✓ SCM5100C8W	1	193
● + SCM4100P12W	1	192	● + SCM420P9S	1/5	188	● + SCM430R9S	1/5	189	● + SCM5100C9W	1	193
● + SCM4100P5W	1	192	● + SCM420P9W	1/5	190	● + SCM430R9W	1/5	191	● + SCM5100P5W	1	192
● + SCM4100P6W	1/6	192	● + SCM420R12S	1/5	189	● + SCM432B6S	1/5	184	● + SCM5100P6W	1/6	192
● + SCM4100P7W	1	192	● + SCM420R12W	1/5	191	● + SCM432B6W	1/5	186	● + SCM5100P7W	1	192
● + SCM4100P9W	1	192	● + SCM420R5S	1/5	189	● + SCM432C3W	1/5	187	● ✓ SCM5100P8W	1	192



SCM		
Cat.numb.	Pack qty.	Page
● + SCM5100P9W	1	192
● + SCM5100R5W	1	193
● + SCM5100R6W	1/10	193
● + SCM5100R7W	1	193
● + SCM5100R8W	1	193
● + SCM5100R9W	1	193
● + SCM5125B6W	1	187
● + SCM5125C6W	1	187
● + SCM5125P6W	1	186
● + SCM5125R6W	1	187
● + SCM516B6W	1/5	186
● + SCM516C6S	1/5	185
● + SCM516C6W	1/5	187
● + SCM516P6S	1/5	184
● + SCM516P6W	1/5	186
● + SCM516R6S	1/5	185
● + SCM516R6W	1/5	187
● + SCM520B5S		188
● + SCM520B5W		190
● + SCM520B6S	1/5	188
● + SCM520B6W	1/5	190
● + SCM520B7S		188
● + SCM520B7W	1/5	190
● + SCM520B9S	1/5	188
● + SCM520B9W	1/5	190
● + SCM520C5S	1/5	189
● + SCM520C5W	1/5	191
● + SCM520C6S	1/5	189
● + SCM520C6W	1/5	191
● + SCM520C7S	1/5	189
● + SCM520C7W	1/5	191
● + SCM520C9S	1	189
● + SCM520C9W	1/5	191
● + SCM520M15W	1/6	198
● + SCM520M15W-C	1/6	199
● + SCM520M15W-NB	1/6	197
● + SCM520M17W	1/6	198
● + SCM520M17W-C	1/6	199

SCM		
Cat.numb.	Pack qty.	Page
● + SCM520M17W-NB	1/6	197
● + SCM520M19W	1/6	198
● + SCM520M19W-C	1/6	199
● + SCM520M19W-NB	1/6	197
● + SCM520P5S	1/5	188
● + SCM520P5W	1/5	190
● + SCM520P6S	1/5	188
● + SCM520P6W	1/5	190
● + SCM520P7S	1/5	188
● + SCM520P7W	1/5	190
● + SCM520P9S	1/5	188
● + SCM520P9W	1/5	190
● + SCM520R5S	1/5	189
● + SCM520R5W	1/5	191
● + SCM520R6S	1/5	189
● + SCM520R6W	1/5	191
● + SCM520R7S	1/5	189
● + SCM520R7W	1/5	191
● + SCM520R9S	1/5	189
● + SCM520R9W	1/5	191
● + SCM530B5S	1/5	188
● + SCM530B5W	1/5	190
● + SCM530B6S	1/5	188
● + SCM530B6W	1/5	190
● + SCM530B7S	1/5	188
● + SCM530B7W	1/5	190
● + SCM530B9S		188
● + SCM530B9W	1/5	190
● + SCM530C5S		189
● + SCM530C5W	1/5	191
● + SCM530C6S	1/5	189
● + SCM530C6W	1/5	191
● + SCM530C7S	1/5	189
● + SCM530C7W	1/5	191
● + SCM530C9S	1/5	189
● + SCM530C9W	1/5	191
● + SCM530M15W	1/6	198
● + SCM530M15W-C	1/6	199

SCM		
Cat.numb.	Pack qty.	Page
● + SCM530M15W-NB	1/6	197
● + SCM530M17W	1/6	198
● + SCM530M17W-C	1/6	199
● + SCM530M17W-NB	1/6	197
● + SCM530M19W	1/6	198
● + SCM530M19W-C	1/6	199
● + SCM530M19W-NB	1/6	197
● + SCM530P5S	1/5	188
● + SCM530P5W	1/5	190
● + SCM530P6S	1/5	188
● + SCM530P6W	1/5	190
● + SCM530P7S	1/5	188
● + SCM530P7W	1/5	190
● + SCM530P9S	1/5	188
● + SCM530P9W	1/5	190
● + SCM530R5S		189
● + SCM530R5W	1/5	191
● + SCM530R6S	1/5	189
● + SCM530R6W	1/5	191
● + SCM530R7S	1/5	189
● + SCM530R7W	1/5	191
● + SCM530R9S	1/5	189
● + SCM530R9W	1/5	191
● + SCM532B6S	1/5	184
● + SCM532B6W	1/5	186
● + SCM532C6S	1/5	185
● + SCM532C6W	1/5	187
● + SCM532P6S	1/5	184
● + SCM532P6W	1/5	186
● + SCM532R6S	1/5	185
● + SCM532R6W	1/5	187
● + SCM560B5W	1	192
● + SCM560B6W	1/10	192
● + SCM560B7W	1	192
● + SCM560B9W	1	192
● + SCM560C5W	1	193
● + SCM560C6W	1/6	193
● + SCM560C7W	1	193

SCM		
Cat.numb.	Pack qty.	Page
● + SCM560C9W	1	193
● + SCM560M15W	1	198
● + SCM560M15W-C	1	199
● + SCM560M15W-NB	1	197
● + SCM560M17W	1/1	198
● + SCM560M17W-C	1	199
● + SCM560M17W-NB	1/1	197
● + SCM560M19W	1	198
● + SCM560M19W-C	1	199
● + SCM560M19W-NB	1	197
● + SCM560P5W	1	192
● + SCM560P6W	1/6	192
● + SCM560P7W	1	192
● + SCM560P9W	1	192
● + SCM560R5W	1	193
● + SCM560R6W	1/10	193
● + SCM560R7W	1	193
● + SCM560R9W	1	193
● + SCM563B6W	1	186
● + SCM563C6W	1	187
● + SCM563P6W	1	186
● + SCM563R6W	1	187
● + SCMBB01	1/12	195
● + SCMBB02	1/12	195
● + SCMBB03	1/6	195
● + SCMSAA12	5	194
● + SCMSAB12	5	194
● + SCMSAB34	5	194
● + SCMSAC100	5	194
● + SCMSAC125	5	194
● + SCMSAC34	5	194
● + SCMSAD125	5	194



# Definition of symbols

In order to give further product specification these symbols have been used throughout the catalogue. They are defined as follows:

---

 = Coaxial TV socket  $\varnothing$  9,5mm

 = 3 pole telephone socket

 = RJ telephone socket

 = Cat. 5E RJ45 socket

---

 = Socket EN 60309 - 2P - 16A - 24V~

 = Socket EN 60309 - 2P+E - 16A - 100/130V~ 4h

 = Socket EN 60309 - 2P+E - 16A - 220/250V~ 6h

 = Socket EN 60309 - 3P+E - 16A - 380/415V~ 6h

 = Socket EN 60309 - 3P+N+E - 16A - 380/415V~ 6h

---

 = Unwound cable power

 = Wound cable power

---

















 = Screw terminals

 = Insulation perforating terminals

 = Spring terminals

 = Mantle terminals



- 
-  = Italian standard socket  
2P 10A (P10) - Shuttered socket - CEI 23-50
-  = Italian standard socket  
2P+E 10A (P11) - Shuttered socket - CEI 23-50
-  = Italian standard socket  
2P+E 16A biv. (P17/11) - Shuttered socket - CEI 23-50
-  = Socket 2P+E 16A (P30) - Shuttered socket - CEI 23-50
-  = Pluristandard socket  
2P+E 16A - Shuttered socket
-  = German standard socket  
2P+E 16A- Shuttered socket
-  = French standard socket  
2P+E 16A - Shuttered socket
-  = British standard socket  
2P+E 13A - Shuttered socket - BS1363-2
-  = British standard socket  
2P+E 15A - Shuttered socket - BS546
-  = Indian standard socket  
2P+E 6/16A - Shuttered socket - IS 1293:1998
-  = Euro-american standard socket  
2P+E 15A
-  = Argentinian standard socket  
2P+E 10A - Unshuttered socket - IRAM 2071
-  = Argentinian standard socket  
2P+E 10A - Unshuttered socket - IRAM 2071
-  = Argentinian standard socket  
2P+E 20A - Unshuttered socket - IRAM 2071
-  = New Zealand standard socket  
2P+E 10A - Unshuttered socket - AS/N25 3112
-  = Swiss standard socket  
2P+E 10A - Unshuttered socket - SEV 1011:1998
-  = Brazilian standard socket  
2P+E 10A - Unshuttered socket - ABNT NBR 14136:3003





# The SCAME product range

## SYSTEMS CATALOGUE



SCAME offers a wide range of products for the home environment, industry and tertiary sector, developed according to the most important international standards.

The range includes:

- electrical components for domestic use and similar items
- components and systems for electrical installations
- assembled equipment
- accessories and components for electrical plants

## ATEX CATALOGUE



SCAME offers specific products for environments at risk of explosion and fire, developed according to the ATEX Directive and certified in compliance with the IECEx standard.

The range includes :

- interlocked sockets and plugs from 16 to 125 A
- junction boxes and control systems
- disconnectors in enclosure from 20 A to 63 A
- plastic and metal cable glands

## ECOMOBILITY CATALOGUE



SCAME has been involved for many years now in the field of electric mobility, making connectors and charging stations intended for electric vehicles. The range includes:

- charging connectors
- charging panels for the home
- charging stations for public environments
- vehicle-charging station connecting cables
- systems for the management of charging systems

## WIRING CATALOGUE

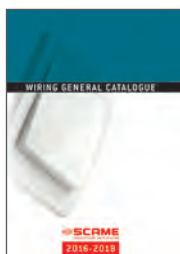

SCAME offers, for the domestic sector, a wide range of flush- and wall-mounted wiring accessories, developed in compliance with different national standards (British, German, Italian, etc). The range includes:

- Flush-mounted series with plastic plate
- Flush-mounted series with metal plate
- Wall-mounted series in airtight enclosure
- Wall-mounted series in metal enclosure
- Outdoor series with degree of protection

**SCAME PARRE S.p.A.**  
MEMBER OF:



Scame parre S.p.A. reserves the right to modify products illustrated in this catalogue without prior notice as part of its policy of constant product improvement and development.







ScameOnLine  
 www.scame.com  
 export@scame.com

SCAME PARRE S.p.A.  
 VIA COSTA ERTA, 15  
 24020 PARRE (BG) ITALY  
 TEL. +39 035 705000  
 FAX +39 035 703122



## X-ON Electronics

Largest Supplier of Electrical and Electronic Components

*Click to view similar products for [Electrical Enclosures](#) category:*

*Click to view products by [SCAME](#) manufacturer:*

Other Similar products are found below :

[MR-25L+](#) [30-8739](#) [30-9715](#) [A242012LP](#) [A16N12BLP](#) [81641001](#) [9511096](#) [9511016](#) [16.4330000](#) [127-906](#) [79021101](#) [73383001](#) [EKIV 17](#)  
[19817001](#) [2327000](#) [2534100](#) [2561400](#) [18600801](#) [19001201](#) [19001301](#) [19501001](#) [19500601](#) [19701101](#) [19600901](#) [TM 0808](#) [TRH 24](#)  
[A317SEAL](#) [A3735SEAL](#) [A3783SEAL](#) [UV 150 K](#) [UV 250 K](#) [X10 R LGR-TR](#) [X01 UT G LGR](#) [X16C LGR-TR](#) [X25C LGR-TR](#) [T 160 OE](#)  
[HD LGR](#) [T 350 OE HD LGR](#) [T 60 M20](#) [T 60 M20 NL](#) [SDB 03 PS](#) [P2018SEAL](#) [12.0000011](#) [12.0000012](#) [04.3080000](#) [04.3090000](#) [KM-](#)  
[326G](#) [2763-00](#) [2765-00](#) [2761-00](#) [20500703-D101000](#)