

General Purpose EMI Filter with High Attenuation Performance



- Rated currents from 1 to 30 A
- High performance filter attenuation
- High differential-mode attenuation
- Optional medical versions (B type)
- Optional safety versions (A type)
- Optional overvoltage protection (Z type)



Performance indicators

Attenuation performance



Rated current [A]

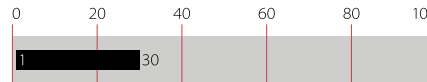

Technical specifications

Operating voltage	110/250 VAC, 50/60 Hz
Operating frequency	dc to 400 Hz
Rated currents	1 to 30 A @ 40°C max.
High potential test voltage	P → PE 2000 VAC for 2 sec (standard types) P → PE 2500 VAC for 2 sec (B types) P → N 1100 VDC for 2 sec
Temperature range (operation and storage)	-25°C to +100°C (25/100/21)
Design corresponding to	UL 1283, CSA 22.2 No. 8 1986, IEC/EN 60939
Flammability corresponding to	UL 94 V-2 or better
Surge pulse protection (optional)	2 kV, IEC 61000-4-5
MTBF @ 40°C/230 V (Mil-HB-217F)	2,200,000 hours (1 to 10 A types) 1,200,000 hours (12 to 30 A types)

Approvals



Features and benefits

- FN 2030 filters are designed for easy and fast chassis mounting
- The FN 2030 filters are also available as B versions with no Y-capacitors for medical applications as well as A versions with low capacitance for safety critical applications with a requirement for low leakage currents
- All filters provide an exceptional conducted attenuation performance, based on chokes with high permeable core material and excellent thermal behavior
- The higher inductivity versus amperage offers increased attenuation performance with same form factor compared to FN 1010 and FN 2020 filter series
- All FN 2030 filters can be delivered with optional surge pulse protection. FN 2030 filters are also available as two-stage filters (FN 2090 series) for very noisy environment
- Various terminal options allow you to select the desired connection style



Typical application

- Electrical and electronic equipment
- Consumer goods
- Household equipment
- Medical equipment
- Electronic data processing equipment
- Office automation and datacom equipment
- Various noisy applications requiring high filter performance

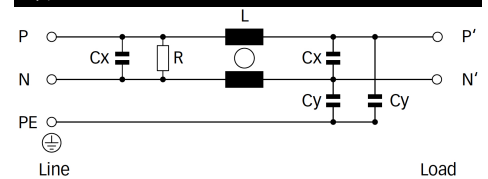
Typical electrical schematic



Filter selection table

Filter*	Rated current	Leakage current**	Inductance L	Capacitance		Resistance R	Input/Output connections			Weight [g]
	@ 40°C (25°C)	@ 230 VAC/50 Hz		Cx	Cy					
	[A]	[mA]	[mH]	[µF]	[nF]	[kΩ]				
FN 2030-1-..	1 (1.1)	0.34	20	0.22	2.2	1000	-06	-07		58
FN 2030-3-..	3 (3.4)	0.52	14	0.33	3.3	1000	-06	-07		87
FN 2030-4-..	4 (4.5)	0.52	14	0.33	3.3	1000	-06	-07		92
FN 2030-6-..	6 (6.7)	0.73	8	0.47	4.7	680	-06	-07		100
FN 2030-8-..	8 (8.9)	0.73	8	0.47	4.7	680	-06	-07		170
FN 2030-10-..	10 (11.2)	0.73	8	0.47	4.7	680	-06	-07		196
FN 2030-12-..	12 (13.4)	0.87	4	1.0	10	330	-06	-07		185
FN 2030-16-..	16 (17.9)	0.87	4	1.0	10	330	-06	-07		225
FN 2030-20-..	20 (22.4)	0.87	4	1.0	10	330	-06		-08	285
FN 2030-30-08	30 (33.5)	0.87	2	1.0	10	330			-08	326
FN 2030 A-1-..	1 (1.1)	0.074	20	0.22	0.47	1000	-06	-07		58
FN 2030 A-3-..	3 (3.4)	0.074	14	0.33	0.47	1000	-06	-07		87
FN 2030 A-4-..	4 (4.5)	0.074	14	0.33	0.47	1000	-06	-07		92
FN 2030 A-6-..	6 (6.7)	0.074	8	0.47	0.47	680	-06	-07		100
FN 2030 A-8-..	8 (8.9)	0.074	8	0.47	0.47	680	-06	-07		170
FN 2030 A-10-..	10 (11.2)	0.074	8	0.47	0.47	680	-06	-07		196
FN 2030 A-12-..	12 (13.4)	0.074	4	1.0	0.47	330	-06	-07		185
FN 2030 A-16-..	16 (17.9)	0.074	4	1.0	0.47	330	-06	-07		225
FN 2030 A-20-..	20 (22.4)	0.074	4	1.0	0.47	330	-06		-08	285
FN 2030 A-30-08	30 (33.5)	0.074	2	1.0	0.47	330			-08	326
FN 2030 B-1-..	1 (1.1)	0.002	20	0.22		1000	-06	-07		58
FN 2030 B-3-..	3 (3.4)	0.002	14	0.33		1000	-06	-07		87
FN 2030 B-4-..	4 (4.5)	0.002	14	0.33		1000	-06	-07		92
FN 2030 B-6-..	6 (6.7)	0.002	8	0.47		680	-06	-07		100
FN 2030 B-8-..	8 (8.9)	0.002	8	0.47		680	-06	-07		170
FN 2030 B-10-..	10 (11.2)	0.002	8.45	0.47		680	-06	-07		196
FN 2030 B-12-..	12 (13.4)	0.002	4	1.0		330	-06	-07		185
FN 2030 B-16-..	16 (17.9)	0.002	4	1.0		330	-06	-07		225
FN 2030 B-20-..	20 (22.4)	0.002	4	1.0		330	-06		-08	285
FN 2030 B-30-08	30 (33.5)	0.002	2	1.0		330			-08	326

* To compile a complete part number, please replace the .. with the required I/O connection style. For surge pulse protection, please add Z (e.g. FN 2030Z-10-06, FN 2030BZ-20-08).
 ** Maximum leakage under normal operating conditions. Note: if the neutral line is interrupted, worst case leakage could reach twice this level.

Typical filter attenuation

Per CISPR 17; A=50 Ω/50 Ω sym; B=50 Ω/50 Ω asym; C=0.1 Ω/100 Ω sym; D=100 Ω/0.1 Ω sym

1 to 4 A types

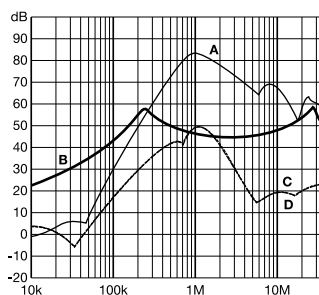

6 to 10 A types

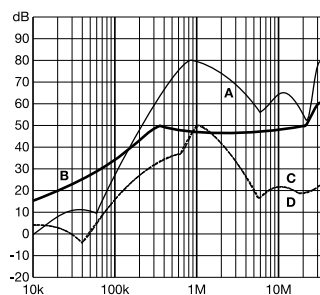

12 to 20 A types

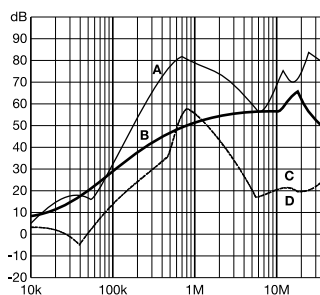

30 A types

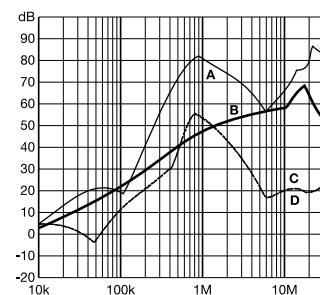

Mechanical data

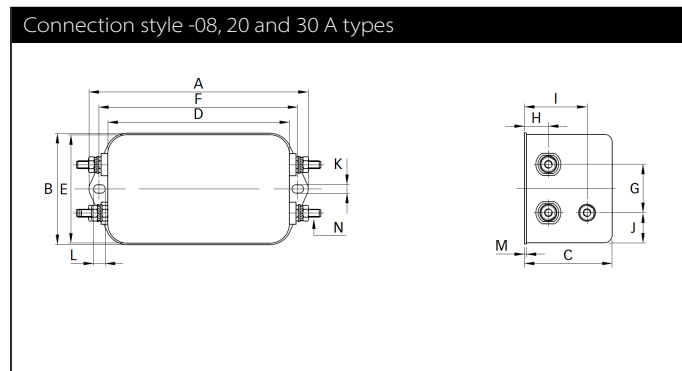
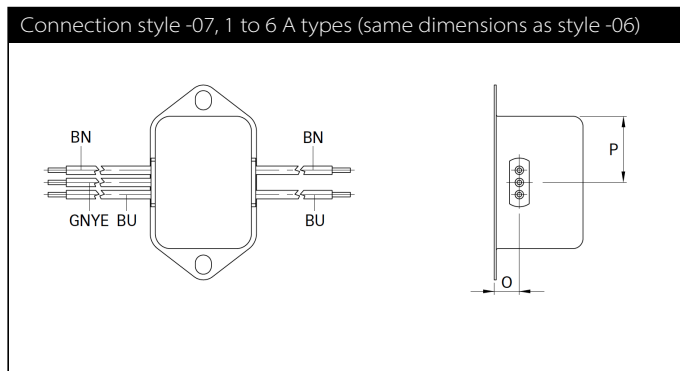
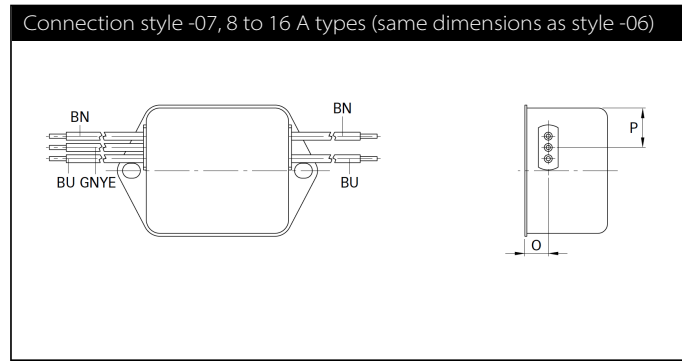
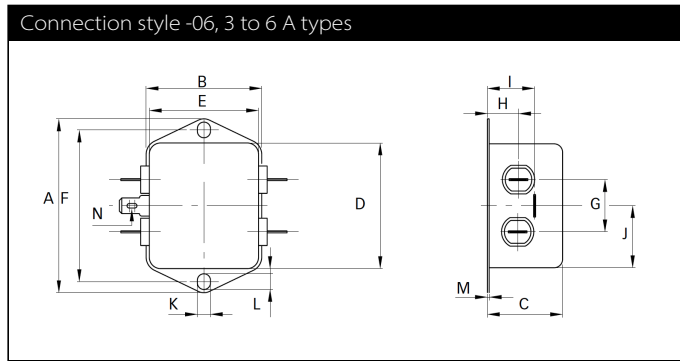
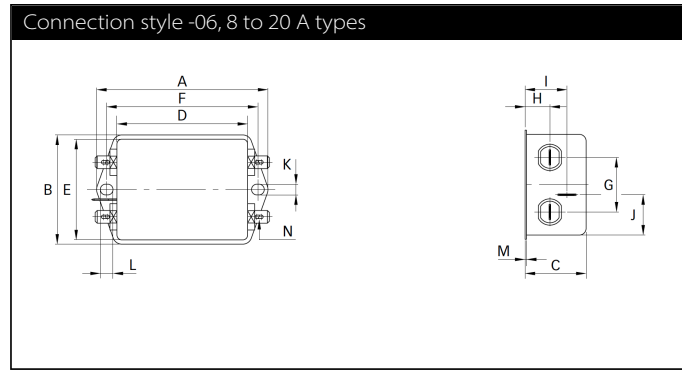
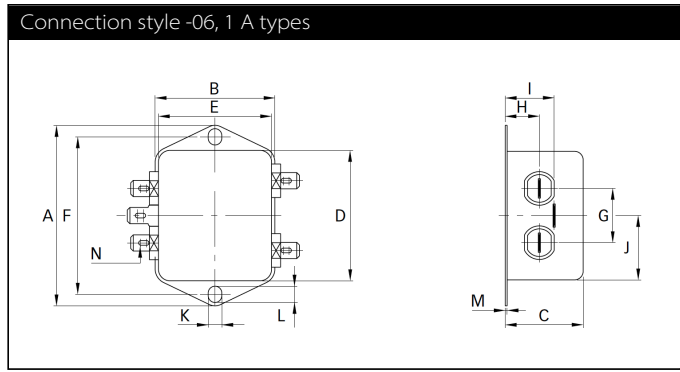

Dimensions

	1 A	3 A	4 A	6 A	8 A	10 A	12 A	16 A	20 A	30 A	Tolerances
A	64	71	71	71	85	85	85	85	85	85	±0.5
B	35	46.6	46.6	46.6	54	54	54	54	54	54	±0.5
C	24.3	22.3	22.3	22.3	30.3	30.3	30.3	40.3	40.3	40.3	±0.5
D	43.5	50.5	50.5	50.5	64.8	64.8	64.8	64.8	64.8	64.8	±0.5
E	32.5	44.5	44.5	44.5	49.8	49.8	49.8	49.8	49.8	49.8	±0.5
F	54	61	61	61	75	75	75	75	75	75	±0.3
G	21	21	21	21	27	27	27	27	27	27	±0.2
H	9.3	10.8	10.8	10.8	12.3	12.3	12.3	12.3	12.3	12.3	±0.5
I	15.3	16.8	16.8	16.8	20.8	20.8	20.8	29.8	29.8	29.8	±0.5
J	21.8	25.25	25.25	25.25	19.9	19.9	19.9	11.4	11.4	11.4	±0.5
K	5.3	5.3	5.3	5.3	5.3	5.3	5.3	5.3	5.3	5.3	
L	6.3	6.3	6.3	6.3	6.3	6.3	6.3	6.3	6.3	6.3	
M	0.7	0.7	0.7	0.7	0.7	0.7	0.7	0.7	0.7	0.7	
Connection style -06											
N	6.3 x 0.8	6.3 x 0.8	6.3 x 0.8	6.3 x 0.8	6.3 x 0.8	6.3 x 0.8	6.3 x 0.8	6.3 x 0.8	6.3 x 0.8	6.3 x 0.8	
Connection style -07											
O	8.3	8.3	8.3	8.3	8.3	8.3	8.3	8.3	8.3		±0.5
P	21.8	14	14	14	14.9	14.9	14.9	14.9			±0.5
AWG type wire	AWG 20	AWG 20	AWG 20	AWG 18	AWG 18	AWG 18	AWG 16	AWG 16			
Wire length	140	140	140	140	140	140	140	140			
Connection style -08											
N									M4	M4	

All dimensions in mm; 1 inch = 25.4 mm
Tolerances according: ISO 2768-m/EN 22768-m



Headquarters, global innovation and development

Switzerland

Schaffner Group

Nordstrasse 11
4542 Luterbach
T +41 32 681 66 26
F +41 32 681 66 30
info@schaffner.com
<http://www.schaffner.com>



Sales and application centers

China

Schaffner EMC Ltd. Shanghai
T20-3 C, No 565 Chuangye Road,
Pudong district
201201 Shanghai
T +86 21 3813 9500
cschina@schaffner.com
<http://www.schaffner.com.cn>

Finland

Schaffner Oy
Sauvonrinne 19 H
08500 Lohja
T +358 10 567 2855
finlandsales@schaffner.com

France

Schaffner EMC S.A.S.
112 Quai de Bezons
95100 Argenteuil
T +33 1 34 34 30 60
F +33 1 39 47 02 28
francesales@schaffner.com

Germany

Schaffner Deutschland GmbH
Schoemperlenstrasse 12B
76185 Karlsruhe
T +49 721 56910
F +49 721 569110
germanysales@schaffner.com

India

Schaffner India Pvt. Ltd
Unit 59, Level, Mfar Greenheart 7
Manyata Tech Park, Hebbal Outer Ring Road
560045 Bangalore
T +91 80 6781 9805
F +91 80 6781 9998
indiasales@schaffner.com

Italy

Schaffner EMC S.r.l.
Via Galileo Galilei 47
20092 Cinisello Balsamo (MI)
T +39 02 66 04 30 45 /47
F +39 02 61 23 943
italysales@schaffner.com

Japan

Schaffner EMC K.K.
1-32-12, Kamiyama, Setagaya-ku
7F Mitsui-seimei Sangenjaya Bldg.
154-0011 Tokyo
T +81 3 5712 3650
F +81 3 5712 3651
japansales@schaffner.com
<http://www.schaffner.jp>

Singapore

Schaffner EMC Pte Ltd.
#05-09, Kg Ubi Ind. Estate
408705 Singapore
T +65 6377 3283
F +65 6377 3281
singaporesales@schaffner.com

Spain

Schaffner EMC España
Calle Caléndula 93, Miniparc III, Edificio E
El Soto de Moraleja, Alcobendas
28109 Madrid
T +34 917 912 900
F +34 917 912 901
spainsales@schaffner.com

Sweden

Schaffner EMC AB
Tegeluddsvägen 76, 2tr
115 28 Stockholm
T +46 8 5050 2425
swedensales@schaffner.com
<http://www.schaffner.com>

Switzerland

Schaffner EMV AG
Nordstrasse 11
4542 Luterbach
T +41 32 681 66 26
switzerlandsales@schaffner.com

Taiwan R.O.C.

Schaffner EMV Ltd.
20 Floor-2, No 97, Section 1, XinTai 5th Road
22175 XiZhi District New Taipei City 22175
T +886 2 2697 5500
F +886 2 2697 5533
taiwansales@schaffner.com
<http://www.schaffner.tw>

Thailand

Schaffner EMC Co. Ltd.
Northern Region Industrial Estate
67 Moo 4 Tambon Ban Klang
Amphur Muangng P.O. Box 14
51000 Lamphun
T +66 53 58 11 04
F +66 53 58 10 19
thailandsales@schaffner.com

United Kingdom

Schaffner Ltd.
5 Ashville Way, Molly Millars Lane
Wokingham
RG41 2PL Berkshire
T +44 118 9770070
F +44 118 9792969
uksales@schaffner.com

USA

Schaffner EMC Inc.
52 Mayfield Avenue
08837 Edison, New Jersey
T +1 800 367 5566
T +1 732 225 9533
F +1 732 225 4789
usasales@schaffner.com
<http://www.schaffnerusa.com>

Schaffner North America

6722 Thirlane Road
24019 Roanoke, Virginia
T +1 276 228 7943
F +1 276 228 7953

Schaffner North America

823 Fairview Road
24382 Wytheville, Virginia
T +1 276 228 7943
F +1 276 228 7258

To find your local partner within Schaffner's global network: www.schaffner.com

© 2016 Schaffner Group

The content of this document has been carefully checked and understood. However, neither Schaffner nor its subsidiaries assume any liability whatsoever for any errors or inaccuracies of this document and the consequences thereof. Published specifications are subject to change without notice. Product suitability for any area of application must ultimately be determined by the customer. In all cases, products must never be operated outside their published specifications. Schaffner does not guarantee the availability of all published products. This disclaimer shall be governed by substantive Swiss law and resulting disputes shall be settled by the courts at the place of business of Schaffner Holding AG. Latest publications and a complete disclaimer can be downloaded from the Schaffner website. All trademarks recognized.

X-ON Electronics

Largest Supplier of Electrical and Electronic Components

Click to view similar products for [Power Line Filters](#) category:

Click to view products by [Schaffner](#) manufacturer:

Other Similar products are found below :

[6609019-3](#) [6609026-5](#) [6609030-6](#) [6609973-2](#) [D30A](#) [7-1609090-5](#) [F2810](#) [F4456A](#) [F7382Z](#) [F7863Z](#) [FAHAV3100ZC000](#) [806276](#) [FN2020B-1-06](#) [FN2080B-10-06](#) [FN2410H-32-33](#) [FP144](#) [FS4153-20-06](#) [FS4353-500-99](#) [12-MMB-030-11-D](#) [DB4-393](#) [15811T200](#) [20B1](#) [LC630](#) [2B1](#) [1609080-2](#) [1609993-8](#) [1-6609070-1](#) [F1100AA02](#) [F1150CC10](#) [F1500CA10](#) [F1500CA15](#) [F4041Z](#) [F7585E](#) [1B1](#) [FN2070A-16-06](#) [FN2090A-20-06](#) [FN2090B-12-06](#) [FN2090Z-1-06](#) [FN2410H-25-33](#) [FN2410H-60-34](#) [FN2410H-8-44](#) [FN2412H-8-44](#) [FN323B-6-01](#) [FN3258H-130-35](#) [FN610R-3-06](#) [20EHQ7](#) [20EHZ7](#) [20K1](#) [30B6](#) [3K1](#)