

Versatile Filtered Power Entry Module



- Rated currents up to 10 A
- For one or two fuses
- Fuses Ø6.3 x 32 mm or Ø5 x 20 mm
- 2-pole rocker switch
- Voltage selector
- Optional earth line choke (E type)



Performance indicators

Attenuation performance



Rated current [A]



Technical specifications

Maximum continuous operating voltage	250 VAC, 50/60 Hz
Operating frequency	DC to 400 Hz
Rated currents	1 to 10 A @ 40°C max.
High potential test voltage	P → PE 2000 VAC for 2 sec P → N 760 VAC for 2 sec
Protection category	IP 40 according to IEC 60529
Temperature range (operation and storage)	-25°C to +85°C (25/85/21)
Design corresponding to	UL 1283, CSA 22.2 No. 8 1986, IEC/EN 60939
Flammability corresponding to	UL 94V-2 or better
MTBF @ 40°C/230 V (Mil-HB-217F)	2,200,000 hours
Voltage selector description	
Function	Series/parallel
Voltage marking	
Series	110-120 V
Parallel	220-240 V
Rocker switch description	
Function	2-pole, dark not illuminated Marking I - 0
Electrical specifications	Inrush current 51 A 6,000 on-off operations according to UL 1054, TV 5 10,000 on-off operations according to ENEC
Mechanical life	50,000 cycles
Switch ratings	
USA (UL) and Canada (C-UL)	10 A, 125 VAC; 10 A, 250 VAC; 1/3 HP
Europe (ENEC)	10 A (4 A), 250 VAC*

* Value in () relates to the inductive current charge: $\cos \varphi=0.65$

Approvals



The FN 390 power entry module combines an IEC inlet, mains filter with single or dual-fuse holder, voltage selector and 2-pole rocker switch. Choosing FN 390 product line brings you the rapid availability of a standard filter associated with the necessary safety acceptances. Standard IEC connector filters are a practical solution helping you to pass EMI system approval in a short time. Multiple options designed to offer you the desired solution.

Features and benefits

- High conducted attenuation performance, based on chokes with high saturation resistance and excellent thermal behavior
- Rear or front mounting
- Single or dual-fuse holder
- USA Ø6.3 x 32 mm or EU Ø5 x 20 mm fuses
- 2-pole rocker switch
- Voltage selector 110-120 V/220-240 V
- Custom-specific versions are available on request

Typical applications

- Portable electrical and electronic equipment
- Consumer goods
- EDP and office equipment
- Single-phase power supplies, switch-mode power supplies
- Test and measurement equipment

Typical electrical schematic

Standard types

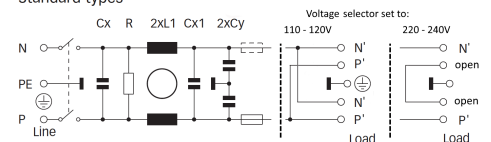

E types

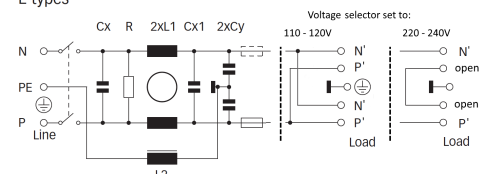

Filter selection table

Filter	Rated current @ 40°C (25°C) [A]	Leakage current* @ 230 VAC/50 Hz [µA]	Inductance		Capacitance			Resistance R [kΩ]	Output connections 	Fuses** [Qty]	Weight [g]
			L1 [mH]	L2 [mH]	Cx [nF]	Cx1 [nF]	Cy [nF]				
FN 393-1-05-11	1 (1.2)	560	7.5		220		3.3	1000	05-11	1	200
FN 393-2.5-05-11	2.5 (3)	560	2		220		3.3	1000	05-11	1	200
FN 393-6-05-11	6 (7.2)	560	0.45		220		3.3	1000	05-11	1	200
FN 394-1-05-11	1 (1.2)	560	7.5		220		3.3	1000	05-11	2	200
FN 394-2.5-05-11	2.5 (3)	560	2		220		3.3	1000	05-11	2	200
FN 394-6-05-11	6 (7.2)	560	0.45		220		3.3	1000	05-11	2	200
FN 393 E-1-05-11	1 (1.2)	560	7.5	0.4	220		3.3	1000	05-11	1	205
FN 393 E-2.5-05-11	2.5 (3)	560	2	0.4	220		3.3	1000	05-11	1	205
FN 393 E-6-05-11	6 (7.2)	560	0.45	0.4	220		3.3	1000	05-11	1	205
FN 394 E-1-05-11	1 (1.2)	560	7.5	0.4	220		3.3	1000	05-11	2	205
FN 394 E-2.5-05-11	2.5 (3)	560	2	0.4	220		3.3	1000	05-11	2	205
FN 394 E-6-05-11	6 (7.2)	560	0.45	0.4	220		3.3	1000	05-11	2	205
FN 1393-1-05-11	1 (1.2)	797	16		220	100	4.7	470	05-11	1	210
FN 1393-2.5-05-11	2.5 (3)	797	8		220	100	4.7	470	05-11	1	210
FN 1393-6-05-11	6 (7.2)	797	2.5		220	100	4.7	470	05-11	1	210
FN 1393-10-05-11	10 (12)	797	0.6		220	100	4.7	470	05-11	1	210
FN 1394-1-05-11	1 (1.2)	797	16		220	100	4.7	470	05-11	2	210
FN 1394-2.5-05-11	2.5 (3)	797	8		220	100	4.7	470	05-11	2	210
FN 1394-6-05-11	6 (7.2)	797	2.5		220	100	4.7	470	05-11	2	210
FN 1394-10-05-11	10 (12)	797	0.6		220	100	4.7	470	05-11	2	210

* Maximum leakage under normal operating conditions. Note: if the neutral line is interrupted, worst case leakage could reach twice this level.

** Filters are delivered without fuse.

Note: for medical versions please contact your local partner within Schaffner's global network.

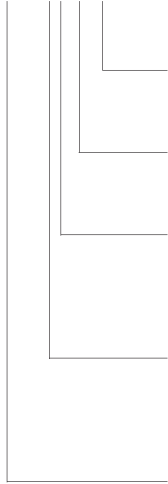
Product selector	
FN (1)39xx-y-zz	
	
05-11:	Faston 6.3 x 0.8mm
1 to 10:	Rated current
Blank:	Standard version
E:	Optional earth line choke
3:	1 fuse (Ø5 x 20mm or Ø6.3 x 32mm)
4:	2 fuses (Ø5 x 20mm or Ø6.3 x 32mm)
Blank:	Standard version
1:	Additional Cx1 capacitor and higher inductivity

For example: FN 393-1-05-11, FN 394 E-2.5-05-11, FN 1394-10-05-11

Typical filter attenuation

Per CISPR 17; A=50 Ω/50 Ω sym; B=50 Ω/50 Ω asym; C=0.1 Ω/100 Ω sym; D=100 Ω/0.1 Ω sym

FN 39x: 1 A types

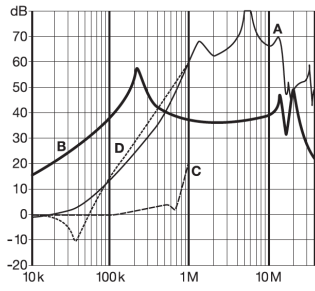

FN 39x: 2.5 A types

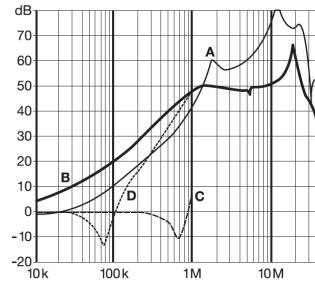

FN 39x: 6 A types

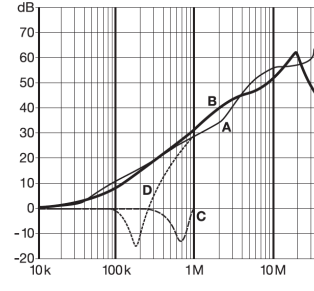

FN 139x: 1 A types

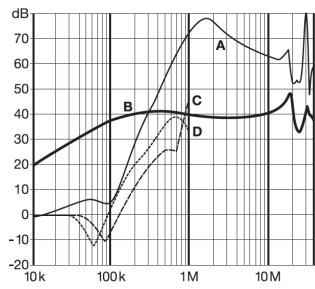

FN 139x: 2.5 A types

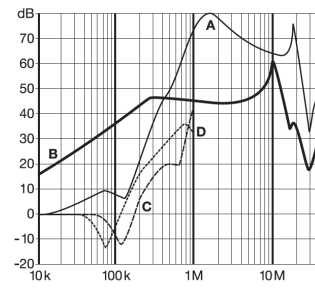

FN 139x: 6 and 10 A types

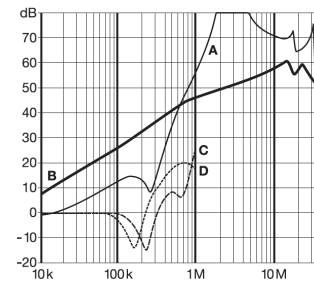

Mechanical data

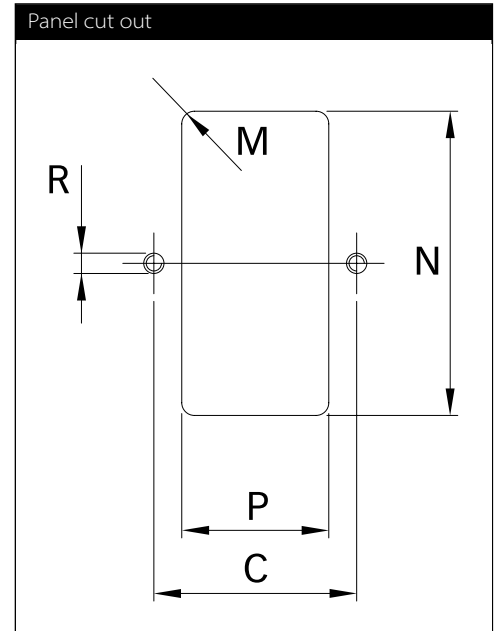
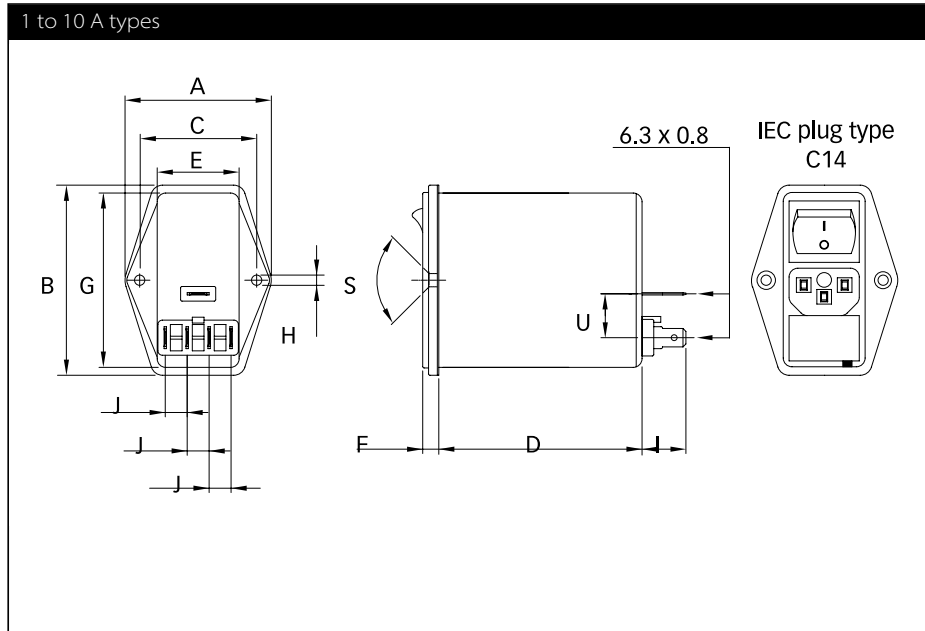

Dimensions

	1 to 10 A	Tolerances
A	50	±0.3
B	65	±0.3
C	40	±0.1
D	70	±0.5
E	28.5	±0.3
F	5.5	±0.3
G	59.8	±0.2
H	Ø 3.3	
I	13.5	±0.5
J	7.5	
M	R ≤ 2.5	
N	60	+0.5/-0
P	29	+0.5/-0
R	M3	
S	90°	
U	15	±0.3

All dimensions in mm; 1 inch=25.4 mm
Tolerances according: ISO 2768-m/EN 22768-m

Please visit www.schaffner.com to find more details on filter connections.



Headquarters, global innovation and development

Switzerland

Schaffner Group

Nordstrasse 11
4542 Luterbach
T +41 32 681 66 26
info@schaffner.com



Sales and application centers

China

Schaffner EMC Ltd. Shanghai

T20-3 C, No 565 Chuangye Road,
Pudong district
201201 Shanghai
T +86 21 3813 9500
cschina@schaffner.com
www.schaffner.com.cn

Finland

Schaffner Oy

Sauvonrinne 19 H
08500 Lohja
T +358 10 567 2855
finlandsales@schaffner.com

France

Schaffner EMC S.A.S.

16-20 Rue Louis Rameau
95875 Bezons
T +33 1 34 34 30 60
F +33 1 39 47 02 28
francesales@schaffner.com

Germany

Schaffner Deutschland GmbH

Schoemperlenstrasse 12B
76185 Karlsruhe
T +49 721 56910
F +49 721 569110
germanysales@schaffner.com

India

Schaffner India Pvt. Ltd

REGUS WORLD TRADE CENTRE
WTC, 22nd Floor Unit No 2238, Brigade
Gateway Campus, 26/1, Dr. Rajkumar Road
Malleshwaram (W)
560055 Bangalore
T +91 80 67935355
indiasales@schaffner.com

Italy

Schaffner EMC S.r.l.

Via Ticino, 30
20900 Monza (MB)
T +39 039 21 41 070
italysales@schaffner.com

Japan

Schaffner EMC K.K.

Taiju-Seimei Sangenjaya Bldg.
1-32-12, Kamiuma, Setagaya-ku
154-0011 Tokyo
T +81 3 5712 3650
F +81 3 5712 3651
japansales@schaffner.com
www.schaffner.jp

Singapore

Schaffner EMC Pte Ltd.

#05-09, Kg Ubi Ind. Estate
408705 Singapore
T +65 6377 3283
F +65 6377 3281
singaporesales@schaffner.com

Spain

Schaffner EMC España

Calle Caléndula 93, Miniparc III, Edificio E
El Soto de Moraleja, Alcobendas
28109 Madrid
T +34 917 912 900
F +34 917 912 901
spainsales@schaffner.com

Sweden

Schaffner EMC AB

Östermalmstorg 1
114 42 Stockholm
T +46 8 5050 2425
swedensales@schaffner.com
www.schaffner.com

Switzerland

Schaffner EMV AG

Nordstrasse 11
4542 Luterbach
T +41 32 681 66 26
switzerlandsales@schaffner.com

Taiwan R.O.C.

Schaffner EMV Ltd.

20 Floor-2, No 97, Section 1, XinTai 5th Road
22175 XiZhi District New Taipei City 22175
T +886 2 2697 5500
F +886 2 2697 5533
taiwansales@schaffner.com
www.schaffner.com.tw

Thailand

Schaffner EMC Co. Ltd.

Northern Region Industrial Estate
67 Moo 4 Tambon Ban Klang
Amphur Muangng P.O. Box 14
51000 Lamphun
T +66 53 58 11 04
F +66 53 58 10 19
thailandsales@schaffner.com

United Kingdom

Schaffner Ltd.

5 Ashville Way, Molly Millars Lane
Wokingham
RG41 2PL Berkshire
T +44 118 9770070
F +44 118 9792969
uksales@schaffner.com

USA

Schaffner EMC Inc.

52 Mayfield Avenue
Edison, New Jersey
T +1 732 225 9533
F +1 732 225 4789
usasales@schaffner.com
www.schaffnerusa.com

Schaffner North America

6722 Thirlane Road
24019 Roanoke, Virginia
T +1 276 228 7943
F +1 276 228 7953

Schaffner North America

823 Fairview Road
24382 Wytheville, Virginia
T +1 276 228 7943
F +1 276 228 7258

To find your local partner within Schaffner's global network: www.schaffner.com

© 2018 Schaffner Group

The content of this document has been carefully checked and understood. However, neither Schaffner nor its subsidiaries assume any liability whatsoever for any errors or inaccuracies of this document and the consequences thereof. Published specifications are subject to change without notice. Product suitability for any area of application must ultimately be determined by the customer. In all cases, products must never be operated outside their published specifications. Schaffner does not guarantee the availability of all published products. This disclaimer shall be governed by substantive Swiss law and resulting disputes shall be settled by the courts at the place of business of Schaffner Holding AG. Latest publications and a complete disclaimer can be downloaded from the Schaffner website. All trademarks recognized.

X-ON Electronics

Largest Supplier of Electrical and Electronic Components

Click to view similar products for [AC Power Entry Modules](#) category:

Click to view products by [Schaffner](#) manufacturer:

Other Similar products are found below :

[0098.0050](#) [6167.0002](#) [6609100-2](#) [7-6609955-2](#) [FKI2-50-6/M5](#) [FN361-6-06](#) [FN389-4-22](#) [FN9226B-6-02](#) [FN9233S1-10-06](#) [FN9233S1-8-06](#)
[FN9233S1B-8-06](#) [FN9233S1R-1-06](#) [FN9233S1R-12-06](#) [FN9233SB-1-06](#) [FN9233SB-12-06](#) [FN9233SB-8-06](#) [FN9233SR-10-06](#) [FN9244B-15-06HI](#) [FN9244EB-3-06](#) [FN9244EB-8-06](#) [FN9244ER-15-06](#) [FN9244ER-8-06](#) [FN9244ES1-8-06](#) [FN9244ESB-8-06](#) [FN9244R-12-06](#)
[FN9244S1-12-06](#) [FN9244S1R-3-06](#) [FN9244SB-8-06](#) [FN9244SR-6-06](#) [FN9244U-3-06](#) [FN9244U-8-06](#) [8-6609940-2](#) [PE00SSSXB](#) [Fuse-H-EUR-1](#) [Fuse-H-USA-1](#) [PM00XD000](#) [A-0701-HT-H](#) [15EJMS8](#) [1-6609941-2](#) [200JM6-2](#) [CA121003-6](#) [SK-1015\(F1-5\)](#) [161-R3015-E](#) [1-6609153-2](#) [FN323-1-05](#) [FN9233B-8-06](#) [FN9233EB-1-06](#) [FN9233ES1R-10-06](#) [FN9233R-12-06](#) [FN9233S-10-06](#)