

# 75 VDC Input PCB Filter



- Rated currents from 3 to 13 A, 75 VDC
- Very compact PCB-mounting design
- Exceptional attenuation performance
- High frequency noise compression



### Performance indicators

Attenuation performance

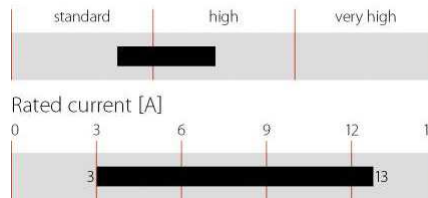

## Technical specifications

<b>Maximum continuous operating voltage</b>	75 V
<b>Rated currents</b>	3 to 13 A
<b>High potential test voltage</b>	VI1/VI2 → GND 1500 VDC for 2 sec VI1 → VI2 100 VDC for 2 sec
<b>Temperature range (operation and storage)</b>	-40 °C to +100 °C (40/100/21)
<b>Design corresponding to</b>	UL 1283, CSA 22.2 No. 8 1986, IEC/EN 60939
<b>Flammability corresponding to</b>	UL 94 V-0
<b>MTBF @ 40°C/230 V (Mil-HB-217F)</b>	4,450,000 hours

### Approvals



FN 409 PCB filters are designed to suppress common and differential-mode noise on DC voltage lines. The suppression performance is special designed to fulfill the requirements for high frequency switching DC/DC converter modules. FN 409 filters can also be used to filter the output current of switch-mode power supplies in applications with intelligent power distribution.

### Features and benefits

- High common and differential-mode noise suppression
- Rated currents up to 13 A at 75 VDC
- Small form factor
- Good thermal conductance

### Typical applications

- Input or output filter for high frequency DC/DC converters
- DC output filter for switch-mode power supplies
- Computer and office automation equipment
- Telecom equipment
- Input/output filter within DC power distribution networks

### Typical electrical schematic

3 and 6.5A types

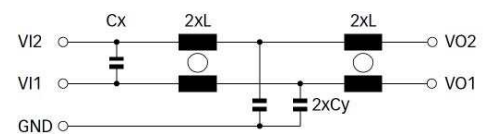

13A types

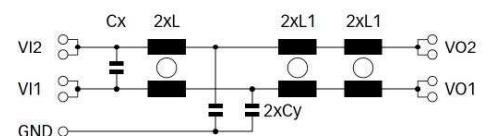

### Filter selection table

Filter	Rated current @ 50 °C (40 °C)	Inductance		Capacitance		DC Resistance R @ 25 °C per path	Input/Output connections	Weight
		L	L1	Cx	Cy			
	[A]	[mH]	[mH]	[nF]	[nF]	[mΩ]		[g]
<b>FN 409-3-02</b>	3 (3.2)	2.9		4700	4.7	86	-02	30
<b>FN 409-6.5-02</b>	6.5 (7)	0.5		4700	4.7	18	-02	30
<b>FN 409-13-02</b>	13 (14)	0.08	0.18	4700	4.7	7.8	-02	47

### Typical filter attenuation

Per CISPR 17; A = 50 Ω/50 Ω sym; B = 50 Ω/50 Ω asym; C = 0.1 Ω/100 Ω sym; D = 100 Ω/0.1 Ω sym

3 A types

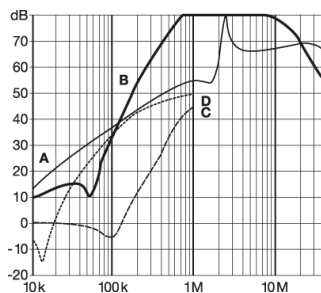

6.5 A types

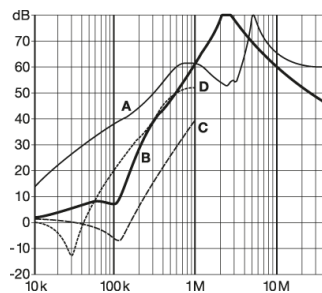

13 A types

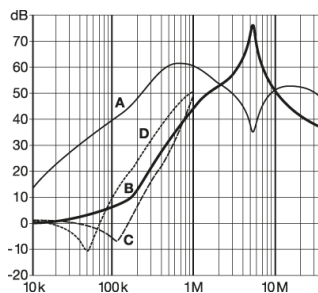

### Mechanical data

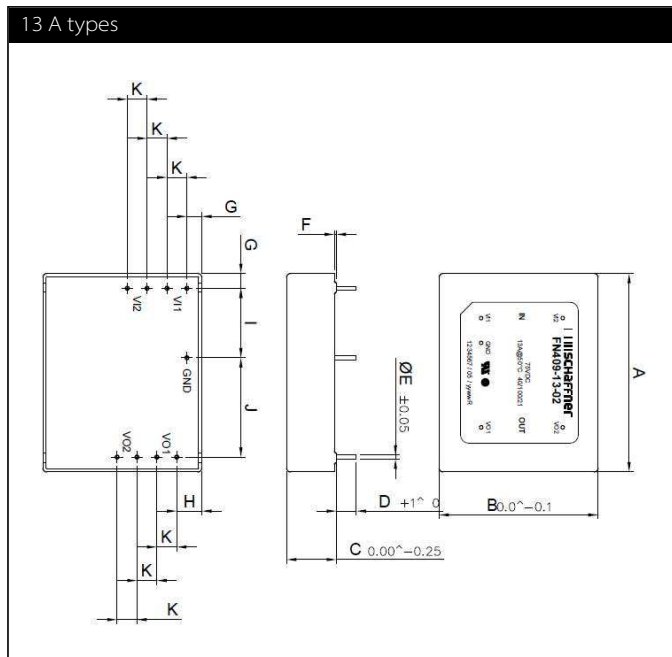
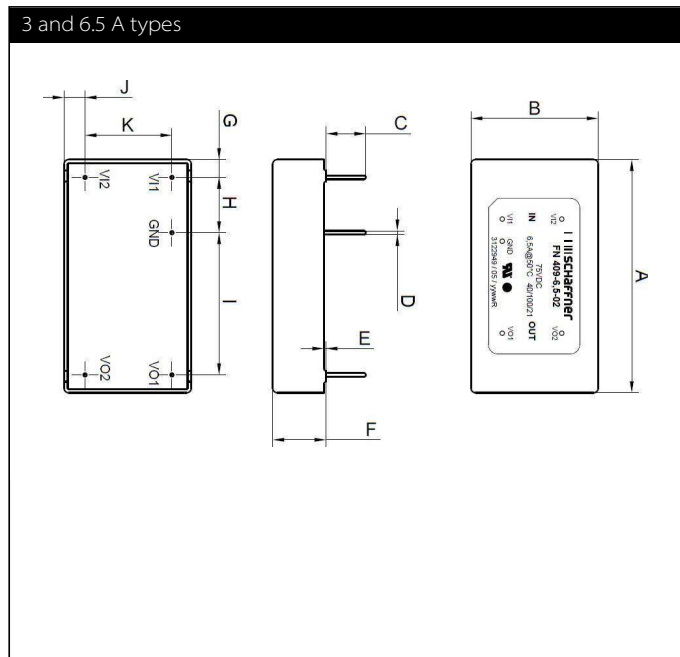

All dimensions in mm; 1 inch = 25.4 mm  
Tolerances according: ISO 2768-m / EN 22768-m

## Dimensions

	3 A	6.5 A	13 A
<b>A</b>	51	51	50.8
<b>B</b>	27.9	27.9	40.6
<b>C</b>	8.2	8.2	12.7
<b>D</b>	Ø0.8	Ø0.8	5.1
<b>E</b>	0.5	0.5	Ø1
<b>F</b>	11.7	11.7	0.5
<b>G</b>	3.9	3.9	3.8
<b>H</b>	12.1	12.1	6.4
<b>I</b>	31.1	31.1	17.8
<b>J</b>	4.6	4.6	25.4
<b>K</b>	19.05	19.05	5.08

## Application

The filters are intended to be used in DC applications per EN/IEC 60950, where no transient on the DC bus occurs. To protect the filter against transient voltages a varistor (VDR, fig. 1) or a transient diode (fig. 2) must be placed at the input side of the filter module.

For protection against overcurrent place a fuse on each input lead (VI+, VI-). When AC voltage is superimposed on DC voltage, VP-P or VO-P, whichever is larger, should be maintained within the rated voltage range.

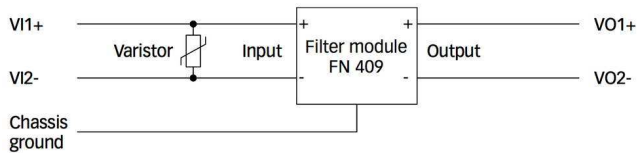

Figure 1: transient protection with a varistor

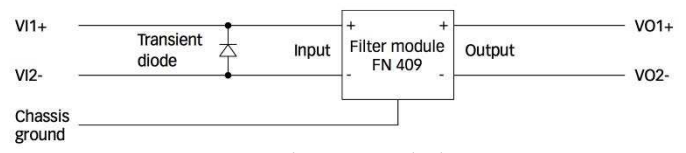
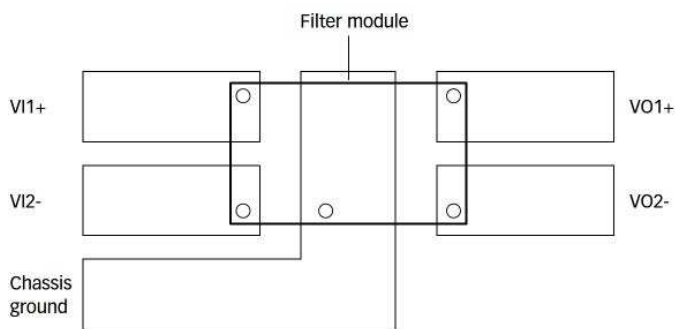

Figure 2: transient protection with a transient diode

## Recommended layout



Note: avoid routing signal tracks or planes under the filter module

Please visit [www.schaffner.com](http://www.schaffner.com) to find more details on filter connectors.



## Headquarters, global innovation and development

### Switzerland

#### Schaffner Group

Nordstrasse 11  
4542 Luterbach  
T +41 32 681 66 26  
[info@schaffner.com](mailto:info@schaffner.com)  
[www.schaffner.com](http://www.schaffner.com)



## Sales and application centers

### China

#### Schaffner EMC Ltd. Shanghai

T20-3 C, No 565 Chuangye Road,  
Pudong district  
201201 Shanghai  
T +86 21 3813 9500  
[cschina@schaffner.com](mailto:cschina@schaffner.com)  
[www.schaffner.com.cn](http://www.schaffner.com.cn)

### Finland

#### Schaffner Oy

Sauvonrinne 19 H  
08500 Lohja  
T +358 50 468 7284  
[finlandsales@schaffner.com](mailto:finlandsales@schaffner.com)

### France

#### Schaffner EMC S.A.S.

16-20 Rue Louis Rameau  
95875 Bezons  
T +33 1 34 34 30 60  
F +33 1 39 47 02 28  
[francesales@schaffner.com](mailto:francesales@schaffner.com)

### Germany

#### Schaffner Deutschland GmbH

Schoemperlenstrasse 12B  
76185 Karlsruhe  
T +49 721 56910  
F +49 721 569110  
[germanysales@schaffner.com](mailto:germanysales@schaffner.com)

### India

#### Schaffner India Pvt. Ltd

REGUS WORLD TRADE CENTRE  
WTC, 22nd Floor Unit No 2238, Brigade  
Gateway Campus, 26/1, Dr. Rajkumar Road  
Malleswaram (W)  
560055 Bangalore  
T +91 80 67935355  
[indiasales@schaffner.com](mailto:indiasales@schaffner.com)

### Italy

#### Schaffner EMC S.r.l.

Via Ticino, 30  
20900 Monza (MB)  
T +39 039 21 41 070  
[italysales@schaffner.com](mailto:italysales@schaffner.com)

### Japan

#### Schaffner EMC K.K.

1-32-12, Kamiyama, Setagaya-ku  
7F Mitsui-seimei Sangenjaya Bldg.  
154-0011 Tokyo  
T +81 3 5712 3650  
F +81 3 5712 3651  
[japansales@schaffner.com](mailto:japansales@schaffner.com)  
[www.schaffner.jp](http://www.schaffner.jp)

### Singapore

#### Schaffner EMC Pte Ltd.

#05-09, Kg Ubi Ind. Estate  
408705 Singapore  
T +65 6377 3283  
F +65 6377 3281  
[singaporesales@schaffner.com](mailto:singaporesales@schaffner.com)

### Spain

#### Schaffner EMC España

Calle Caléndula 93, Miniparc III, Edificio E  
El Soto de Moraleja, Alcobendas  
28109 Madrid  
T +34 917 912 900  
F +34 917 912 901  
[spainsales@schaffner.com](mailto:spainsales@schaffner.com)

### Sweden

#### Schaffner EMC AB

Tegeluddsvägen 76, 2tr  
115 28 Stockholm  
T +46 8 5050 2425  
[swedensales@schaffner.com](mailto:swedensales@schaffner.com)  
[www.schaffner.com](http://www.schaffner.com)

### Switzerland

#### Schaffner EMV AG

Nordstrasse 11  
4542 Luterbach  
T +41 32 681 66 26  
[switzerlandsales@schaffner.com](mailto:switzerlandsales@schaffner.com)

### Taiwan R.O.C.

#### Schaffner EMV Ltd.

20 Floor-2, No 97, Section 1, XinTai 5th Road  
22175 XiZhi District New Taipei City 22175  
T +886 2 2697 5500  
F +886 2 2697 5533  
[taiwansales@schaffner.com](mailto:taiwansales@schaffner.com)  
[www.schaffner.com.tw](http://www.schaffner.com.tw)

### Thailand

#### Schaffner EMC Co. Ltd.

Northern Region Industrial Estate  
67 Moo 4 Tambon Ban Klang  
Amphur Muangng P.O. Box 14  
51000 Lamphun  
T +66 53 58 11 04  
F +66 53 58 10 19  
[thailandsales@schaffner.com](mailto:thailandsales@schaffner.com)

### United Kingdom

#### Schaffner Ltd.

5 Ashville Way, Molly Millars Lane  
Wokingham  
RG41 2PL Berkshire  
T +44 118 9770070  
F +44 118 9792969  
[uksales@schaffner.com](mailto:uksales@schaffner.com)

### USA

#### Schaffner EMC Inc.

52 Mayfield Avenue  
08837 Edison, New Jersey  
T +1 800 367 5566  
T +1 732 225 9533  
F +1 732 225 4789  
[usasales@schaffner.com](mailto:usasales@schaffner.com)  
[www.schaffnerusa.com](http://www.schaffnerusa.com)

#### Schaffner North America

6722 Thirlane Road  
24019 Roanoke, Virginia  
T +1 276 228 7943  
F +1 276 228 7953

#### Schaffner North America

823 Fairview Road  
24382 Wytheville, Virginia  
T +1 276 228 7943  
F +1 276 228 7258

To find your local partner within Schaffner's global network: [www.schaffner.com](http://www.schaffner.com)

© 2018 Schaffner Group

The content of this document has been carefully checked and understood. However, neither Schaffner nor its subsidiaries assume any liability whatsoever for any errors or inaccuracies of this document and the consequences thereof. Published specifications are subject to change without notice. Product suitability for any area of application must ultimately be determined by the customer. In all cases, products must never be operated outside their published specifications. Schaffner does not guarantee the availability of all published products. This disclaimer shall be governed by substantive Swiss law and resulting disputes shall be settled by the courts at the place of business of Schaffner Holding AG. Latest publications and a complete disclaimer can be downloaded from the Schaffner website. All trademarks recognized.

## X-ON Electronics

Largest Supplier of Electrical and Electronic Components

*Click to view similar products for [Power Line Filters](#) category:*

*Click to view products by [Schaffner](#) manufacturer:*

Other Similar products are found below :

[6609019-3](#) [6609026-5](#) [6609030-6](#) [6609973-2](#) [D30A](#) [7-1609090-5](#) [F2810](#) [F4456A](#) [F7382Z](#) [F7863Z](#) [FAHAV3100ZC000](#) [806276](#) [FN2020B-1-06](#) [FN2080B-10-06](#) [FN2410H-32-33](#) [FP144](#) [FS4153-20-06](#) [FS4353-500-99](#) [12-MMB-030-11-D](#) [DB4-393](#) [15811T200](#) [20B1](#) [LC630](#) [2B1](#) [1609080-2](#) [1609993-8](#) [1-6609070-1](#) [F1100AA02](#) [F1150CC10](#) [F1500CA10](#) [F1500CA15](#) [F4041Z](#) [F7585E](#) [1B1](#) [FN2070A-16-06](#) [FN2090A-20-06](#) [FN2090B-12-06](#) [FN2090Z-1-06](#) [FN2410H-25-33](#) [FN2410H-60-34](#) [FN2410H-8-44](#) [FN2412H-8-44](#) [FN323B-6-01](#) [FN3258H-130-35](#) [FN610R-3-06](#) [20EHQ7](#) [20EHZ7](#) [20K1](#) [30B6](#) [3K1](#)