

Two-stage performance filter

- current ratings from 1 to 10A
- very high differential and common mode attenuation
- good low frequency attenuation
- Nennströme von 1 bis 10 A
- Sehr hohe differentielle und Gleichtakt-Dämpfung
- Gute Niederfrequenzdämpfung
- courants de service de 1 à 10 A
- très bonne atténuation en modes différentiel et commun
- bonne atténuation à des basses fréquences





Filter selection table

Choose the family FN xxx with the required current rating and features, and add /?? to determine input/output (line/load) connection style. Example: FN 682-4/07 is a 4A filter with wire connections.

Approvals



Family	Connections		Current ratings at 40°C (25°) A	Inductance L/L ₁ mH	Housing	Weight g	
						/06	/07
FN 680 -1 /??	/06	/07	1 (1.2)	22.5/1.2	J11	120	130
FN 680 -2.5 /??	/06	/07	2.5 (3)	16/0.27	K2	230	245
FN 682 -4 /??	/06	/07	4 (4.8)	8/0.08	K2	250	255
FN 682 -6.5 /??	/06	/07	6.5 (7.8)	4.1/0.055	L1	590	600
FN 682 -10 /??	/06	/07	10 (12)	4/0.04	L2	950	970

Additional specifications

Filter type	Capacitance		Res. R MΩ	Maximum leakage μA/phase	Maximum operating voltage		Operating frequency Hz	Hipot test voltage	
	C _x nF	C _y nF			VAC	Hz		PN→E VAC	P→N VDC
FN 680 types	220	4.7	1	410	250	50/60	DC to 400	2000	1700
FN 682 types (4A)	1000	22	0.33	1900	250	50/60	DC to 400	2000	1700
FN 682 types (6.5-10A)	470	22	0.47	1900	250	50/60	DC to 400	2000	1700

MTBF at 40°C, 230V, per Mil-HB-217F: 1,400,000 hours.

Electrical schematic

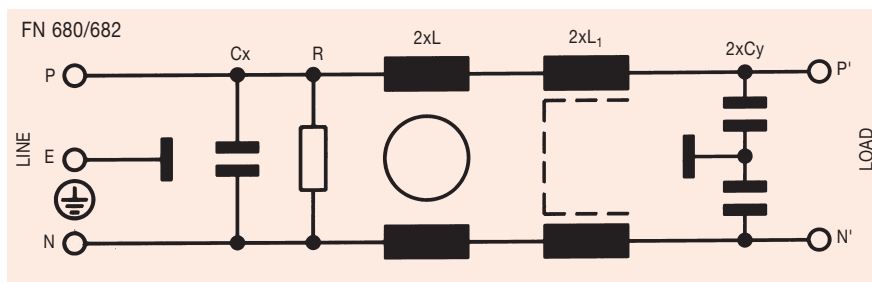

See tables for component values.

FN 680 insertion loss

Per CISPR 17; A = 50Ω/50Ω sym, B = 50Ω/50Ω asym, C = 0.1Ω/100Ω sym, D = 100Ω/0.1Ω sym

1 amp types

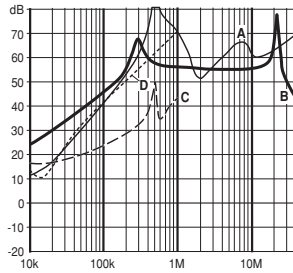

2.5 amp types

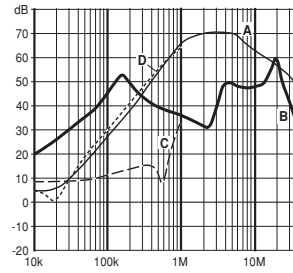

4 amp types

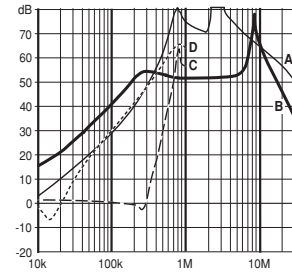

6.5 amp types

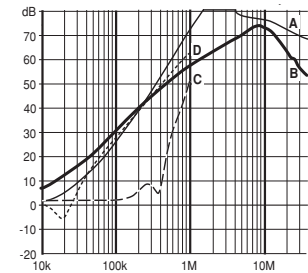

10 amp types

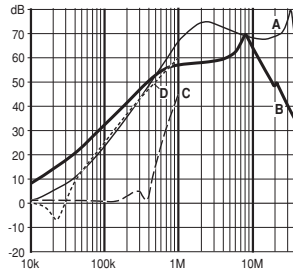

Mechanical data

FN 680-1

J11

		Tol. mm
A	71	± 0.5
B	52.6	± 0.5
C	29	± 0.5
D	50.5	± 1
F	61	± 0.2
J	21	± 0.5
K	14	± 0.5
L	20	± 0.5
M	5.3	± 0.1
N	6.3	± 0.1
Y	6	± 1
Z	140	+ 5

FN 680-2.5 FN 682-6.5 FN 682-10 FN 682-4

	K2	L1	L2	Tol.* mm
A	85	105		± 0.5
B	54	99.5 ± 1		± 0.5
C	40	38	57	± 1
D	65	84.5		± 1
E		79		± 0.5
F	75	95		± 0.2
G		51		± 0.1
J	27	40		± 0.5
K	12	9.5		± 0.5
L	29.5	19		± 0.5
M	5.3	4.4		± 0.1
N	6.3	6		± 0.1
Y		6		± 1
Z		140		+ 5

* Measurements share this common tolerance unless otherwise stated.

All dimensions in mm; 1 inch = 25.4 mm

FRONT VIEW

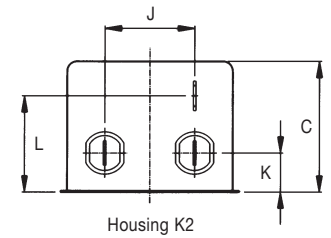
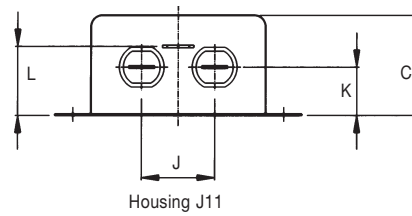

TOP VIEW

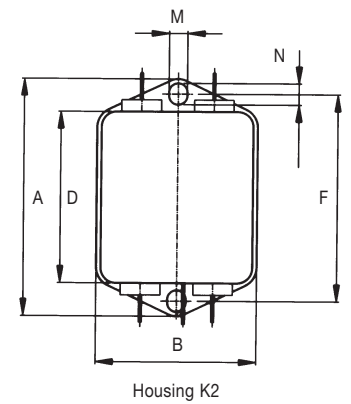
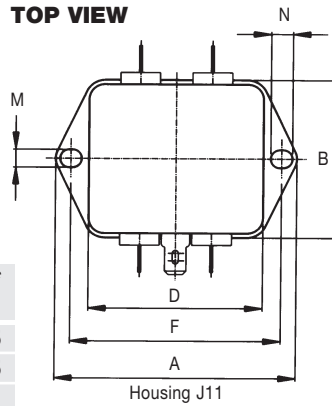

FRONT VIEW

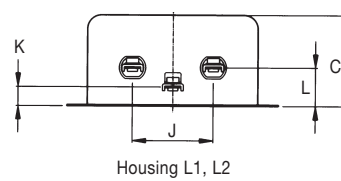

TOP VIEW

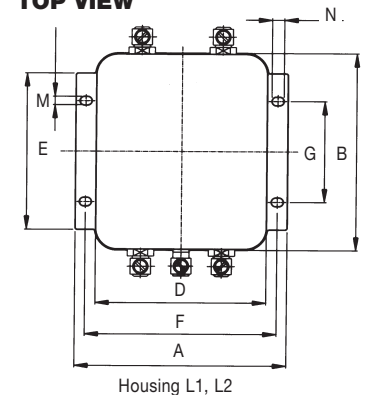

X-ON Electronics

Largest Supplier of Electrical and Electronic Components

Click to view similar products for [Power Line Filters](#) category:

Click to view products by [Schaffner](#) manufacturer:

Other Similar products are found below :

[6609019-3](#) [6609026-5](#) [6609030-6](#) [6609973-2](#) [D30A](#) [7-1609090-5](#) [F2810](#) [F4456A](#) [F7382Z](#) [F7863Z](#) [FAHAV3100ZC000](#) [806276](#) [FN2020B-1-06](#) [FN2080B-10-06](#) [FN2410H-32-33](#) [FP144](#) [FS4153-20-06](#) [FS4353-500-99](#) [12-MMB-030-11-D](#) [DB4-393](#) [15811T200](#) [20B1](#) [LC630](#) [2B1](#) [1609080-2](#) [1609993-8](#) [1-6609070-1](#) [F1100AA02](#) [F1150CC10](#) [F1500CA10](#) [F1500CA15](#) [F4041Z](#) [F7585E](#) [1B1](#) [FN2070A-16-06](#) [FN2090A-20-06](#) [FN2090B-12-06](#) [FN2090Z-1-06](#) [FN2410H-25-33](#) [FN2410H-60-34](#) [FN2410H-8-44](#) [FN2412H-8-44](#) [FN323B-6-01](#) [FN3258H-130-35](#) [FN610R-3-06](#) [20EHQ7](#) [20EHZ7](#) [20K1](#) [30B6](#) [3K1](#)