

Ultra Compact and Versatile Filtered Power Entry Module



- | Single stage filter
- | Ultra compact design
- | Rated currents up to 10 A
- | dual-fuse holder
- | Fuses Ø5x20mm
- | 2-pole rocker switch
- | Good attenuation performance
- | Faston or spring cage terminals



Approvals



RoHS

(CQC except HI-types); Patent US20110227692 / US8766761

Performance indicators

Attenuation performance



Rated current [A]



The FN 9280 power entry module combines an IEC inlet, a mains filter and a dual fuse holder with a 2-pole rocker switch in an ultra compact housing.

Choosing FN 9280/90 product line brings you the rapid availability of a standard filter associated with the necessary safety acceptances and a high attenuation performance. For higher attenuation performance the FN 9290 family with a dual stage filter and identical panel cut-out can be used.

Standard IEC connector filters are a practical solution to pass EMI system approval in a short time. A wide selection of amperage ratings, mounting possibilities and also filters for medical applications are designed to offer you the best solution.

Technical specifications

Mechanical life	50,000 cycles
High potential test voltage	P → PE 2000 VAC for 2 sec (standard types) P → N 760 VAC for 2 sec P → PE 2500 VAC for 2 sec (B types)
MTBF @ 40°C/230V (Mil-HB-217F)	> 1,000,000 hours
Temperature range (operation and storage)	- 25 °C to +85 °C (25/85/21)
Design corresponding to	UL 1283, CSA 22.2 No. 8 1986, EN60939, EN60950, EN60601-1, UL544, EN60320
Flammability corresponding to	UL 94 V-2 or better
Maximum continuous operating voltage	250 VAC, 50/60 Hz
Rated currents	1 to 10 A* @ 40 °C max.
Operating frequency	50 to 400 Hz
Switch ratings	
USA (UL) and Canada (C-UL)	10 A, 125 VAC; 10 A, 250 VAC; 1/3HP
Europe (ENEC)	10 A (4 A), 250 VAC**
Electrical specifications	Inrush current 82 A 6,000 on-off operations according to UL 1054 10,000 on-off operations according to ENEC
Leakage current	Standard: <500uA at 250 VAC/50 Hz Medical: <5uA at 250 VAC/50 Hz
Protection category	IP40 according to IEC 60529 (front side)
Fuse holder	2fuses (Ø5 x 20 mm) max. 250 V
Terminals	IP20 spring cage safe against finger touch
Spring cage wire range	0.2 – 1.5 mm ² / 24 – 16 AWG single or flexible wire
Rocker switch	2-pole, dark not illuminated, Marking I - 0

* 10 A version is 8 A UL approved

** Value in () relates to the inductive current charge: cos γ = 0.65



Features and benefits

- | Good conducted attenuation performance, based on chokes with high saturation resistance and excellent thermal behavior
- | Deep-drawn iron-sheet housing for best possible shielding against magnetic fields
- | Rear/front flange mounting or snap-in versions
- | Dual fuse holder
- | 2-pole rocker switch
- | Faston or spring cage terminals for more flexible assembly
- | Medical version (B Type) according IEC / EN60601-1
- | Spare fuse holder

Typical applications

- | Portable electrical and electronic equipment
- | Consumer goods
- | EDP and office equipment
- | Single-phase power supplies, switch-mode power supplies
- | Test and measurement equipment
- | Medical electrical devices (MD) and *In-Vitro*-Diagnostics (IVD) equipment

Filter selection table

Filter*	Rated current @ 40 °C	Leakage current** @ 250 V ~/50 Hz	Inductance		Capacitance		Resistance	Output connections		Weight
			L1	L2	Cx	R				
	[A]	[uA]	[mH]		[nF]		[kOhm]			[g]
FN9280-1-..	1	311	10.9	0	220	2.2	1000	-06	-100	101
FN9280-2-..	2	311	4.4	0	220	2.2	1000	-06	-100	102
FN9280-4-..	4	311	1.7	0	220	2.2	1000	-06	-100	105
FN9280-6-..	6	311	0.78	0	220	2.2	1000	-06	-100	104
FN9280-10-..	10	311	0.32	0	220	2.2	1000	-06	-100	106
FN9280B-1-..	1	2	10.9	0	220	0	1000	-06	-100	101
FN9280B-2-..	2	2	4.4	0	220	0	1000	-06	-100	102
FN9280B-4-..	4	2	1.7	0	220	0	1000	-06	-100	105
FN9280B-6-..	6	2	0.78	0	220	0	1000	-06	-100	104
FN9280B-10-..	10	2	0.32	0	220	0	1000	-06	-100	106
FN9289-1-..	1	311	10.9	0	220	2.2	1000	-06	-100	101
FN9289-2-..	2	311	4.4	0	220	2.2	1000	-06	-100	102
FN9289-4-..	4	311	1.7	0	220	2.2	1000	-06	-100	105
FN9289-6-..	6	311	0.78	0	220	2.2	1000	-06	-100	104
FN9289-10-..	10	311	0.32	0	220	2.2	1000	-06	-100	106
FN9289B-1-..	1	2	10.9	0	220	0	1000	-06	-100	101
FN9289B-2-..	2	2	4.4	0	220	0	1000	-06	-100	102
FN9289B-4-..	4	2	1.7	0	220	0	1000	-06	-100	105
FN9289B-6-..	6	2	0.78	0	220	0	1000	-06	-100	104
FN9289B-10-..	10	2	0.32	0	220	0	1000	-06	-100	106
FN9280E-1-..	1	311	10.9	0.4	220	2.2	1000	-06	-100	135
FN9280E-2-..	2	311	4.4	0.4	220	2.2	1000	-06	-100	136
FN9280E-4-..	4	311	1.66	0.4	220	2.2	1000	-06	-100	137
FN9280E-6-..	6	311	0.78	0.4	220	2.2	1000	-06	-100	138
FN9280E-10-..	10	311	0.32	0.4	220	2.2	1000	-06	-100	139
FN9280BE-1-..	1	2	10.9	0.4	220	0	1000	-06	-100	135
FN9280BE-2-..	2	2	4.4	0.4	220	0	1000	-06	-100	136
FN9280BE-4-..	4	2	1.66	0.4	220	0	1000	-06	-100	137
FN9280BE-6-..	6	2	0.78	0.4	220	0	1000	-06	-100	138
FN9280BE-10-..	10	2	0.32	0.4	220	0	1000	-06	-100	139
FN9289E-1-..	1	311	10.9	0.4	220	2.2	1000	-06	-100	135
FN9289E-2-..	2	311	4.4	0.4	220	2.2	1000	-06	-100	136
FN9289E-4-..	4	311	1.66	0.4	220	2.2	1000	-06	-100	137
FN9289E-6-..	6	311	0.78	0.4	220	2.2	1000	-06	-100	138
FN9289E-10-..	10	311	0.32	0.4	220	2.2	1000	-06	-100	139
FN9289BE-1-..	1	2	10.9	0.4	220	0	1000	-06	-100	135
FN9289BE-2-..	2	2	4.4	0.4	220	0	1000	-06	-100	136
FN9289BE-4-..	4	2	1.66	0.4	220	0	1000	-06	-100	137
FN9289BE-6-..	6	2	0.78	0.4	220	0	1000	-06	-100	138
FN9289BE-10-..	10	2	0.32	0.4	220	0	1000	-06	-100	139

* To compile a complete part number, please replace the .. with the required output connection style (e.g. FN 9289-1-06, FN 9282-4-100)

** Maximum leakage current under normal conditions according to IEC 60939-1 Ed. 3 at 250 V AC.

Product selector

FN 92www-xx-yy-zz

Blank:	Snap in range 1.0 to 2.5 mm
Optional: 30:	Snap in range >2.5 to 3.5 mm
06:	Fast-On 6.3 x 0.8 mm (spade/soldering)
100:	Spring cage
1 to 10:	Rated current [A]
Blank:	Standard version
B:	Medical version (without Y2-capacitor)
Optional: E:	Earth line choke
BE:	Medical version (without YZ-capacitor) with earth line choke
0:	Flange version vertical/horizontal/front/rear mounting set
9:	Snap-in version, snapper on horizontal side (top / bottom)
Optional: 1:	Rear Flange mounting (top / bottom)
2:	Front Flange mounting (top / bottom)
3:	Rear Flange mounting (left / right)
4:	Front Flange mounting (left / right)
8:	Snap-in version, snapper on vertical side (left / right)
8:	Single stage filter
9:	Dual stage filter

Typical electrical schematic

FN 9280 Standard types (B types without Cy)

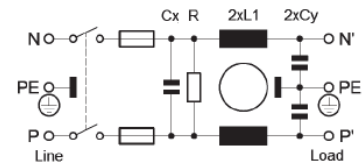

All FN 9280/FN 9290 are equipped with a dual fuse holder with a spare fuse holder.

Note: All FN 9280/FN 9280B/FN 9289/FN 9289B/FN 9290/FN 9290B/FN 9299/FN 9299B are stock types from our distribution partners.

Order Examples:

FN 9280B-6-100: Medical version of single stage, dual fuse EMC/EMI filter, flange set for vertical/horizontal/front/rear mounting, 6 A, spring cage terminals, from stock available.

FN 9298-6-06-30: Dual stage, dual fuse EMC/EMI filter, snap-in version, snappers for snap-in panel thickness range >2.5 to 3.5 mm, snapper on vertical side, 6 A, fast-on terminals, non-stock order type

Typical filter attenuation

FN 9280 Series | Per CISPR 17; A = 50 Ω/50 Ω sym; B = 50 Ω/50 Ω asym

1 A types

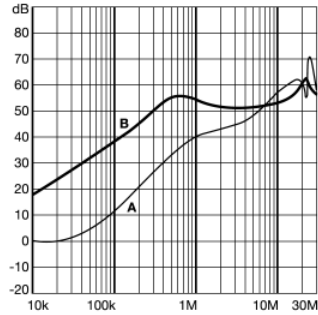

2 A types

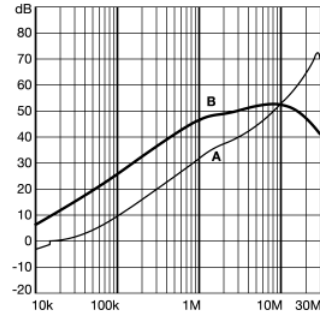

4 – 6 A types

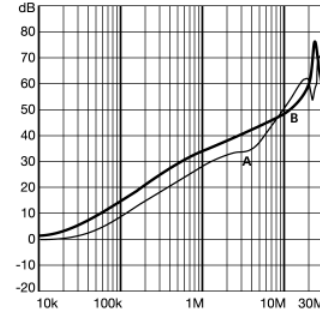

10 A types

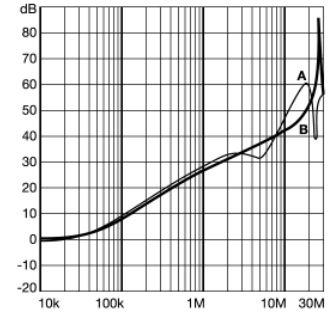

FN 9280B Series | Per CISPR 17; A = 50 Ω/50 Ω sym; B = 50 Ω/50 Ω asym

1 A types

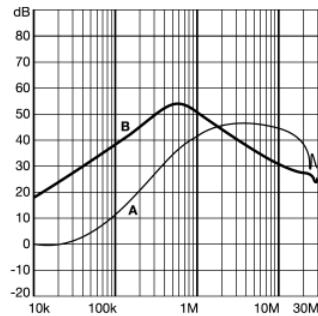

2 A types

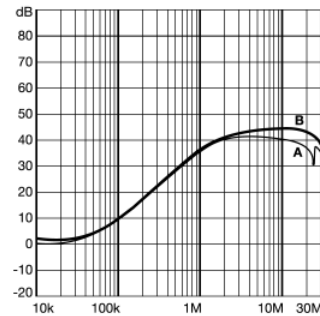

4 – 6 A types

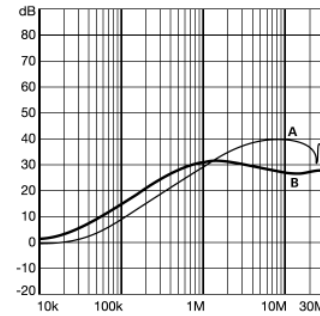

10 A types

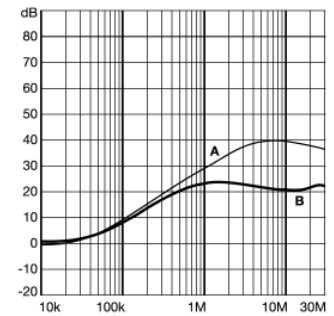

FN 9280E Series | Per CISPR 17; A = 50 Ω/50 Ω sym; B = 50 Ω/50 Ω asym

1 A types

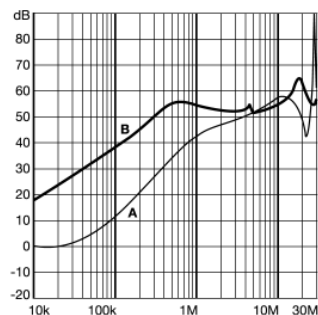

2 A types

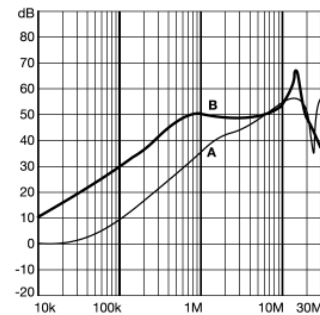

4 – 6 A types

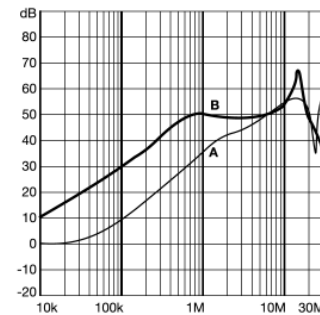

10 A types

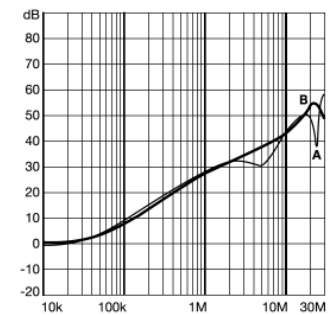

FN 9280BE Series | Per CISPR 17; A = 50 Ω/50 Ω sym; B = 50 Ω/50 Ω asym

1 A types

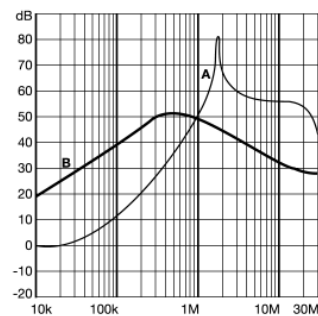

2 A types

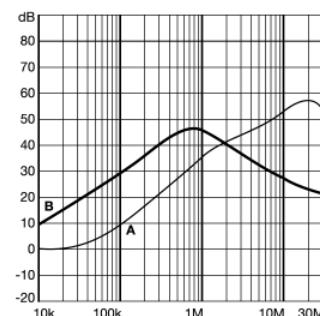

4 – 6 A types

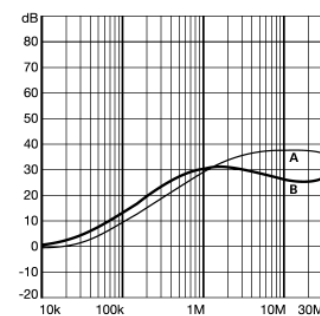

10 A types

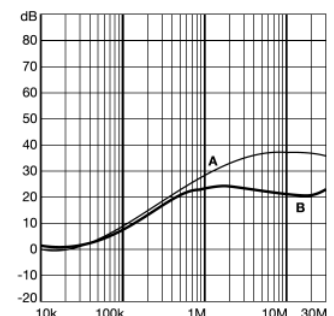

Mechanical Data:

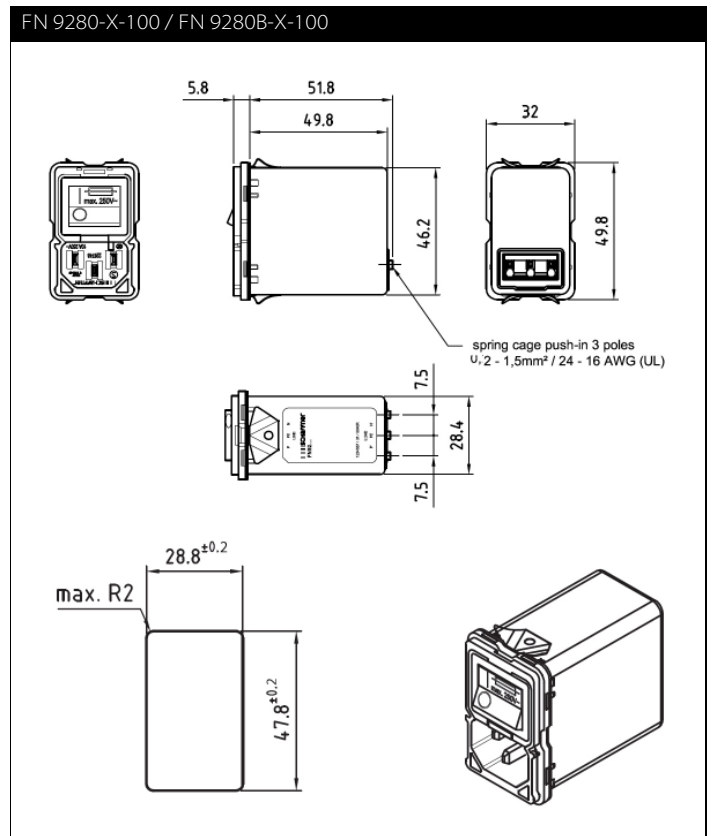
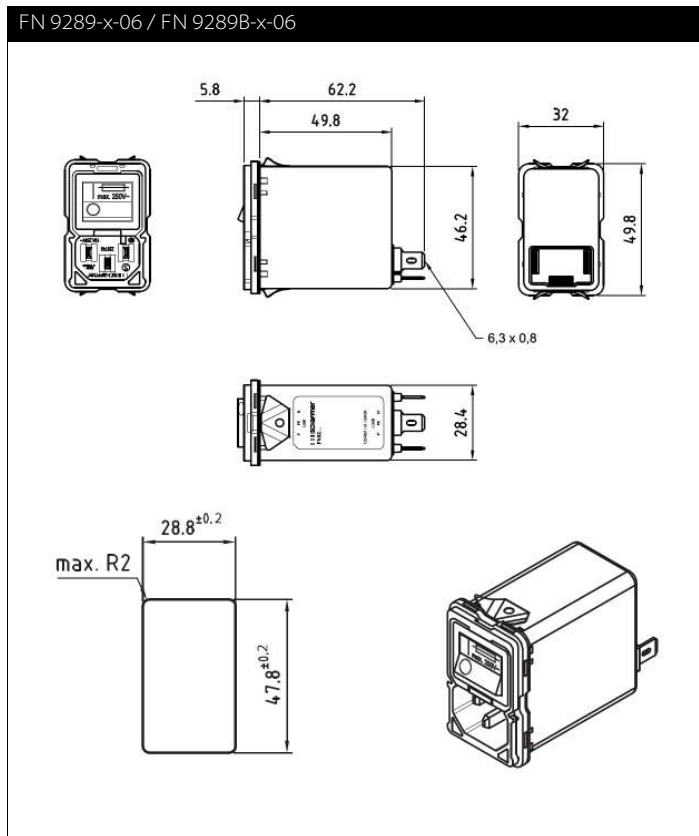
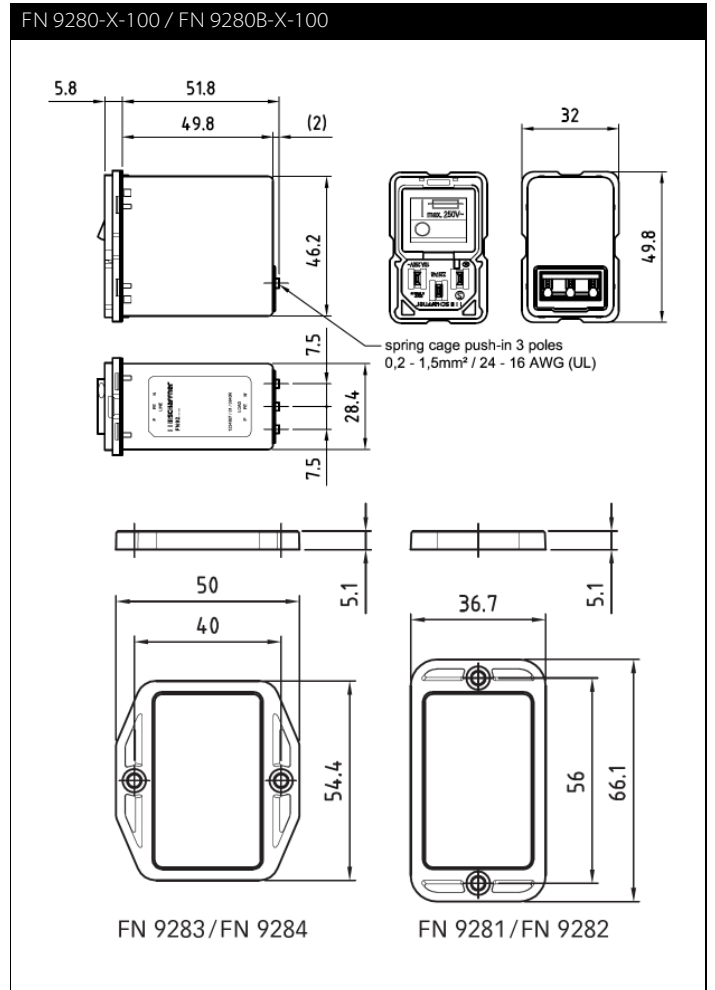
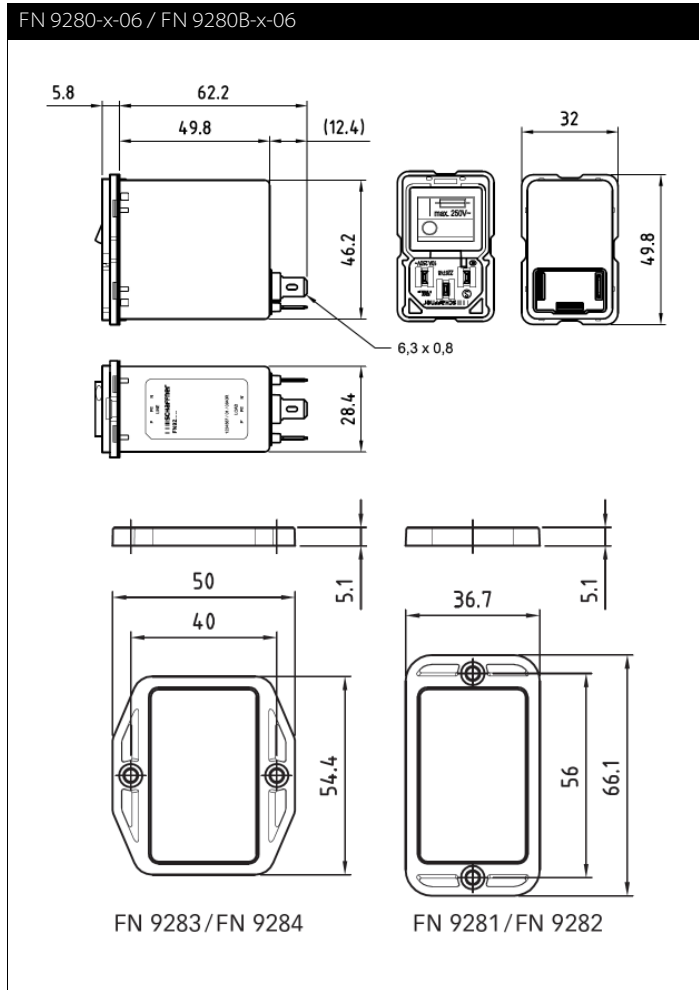

Assembly Instructions

REAR MOUNTING

FRONT MOUNTING

vertical:

horizontal:

vertical:

horizontal:

FN9280xx
FN9290xx
FN9281xx
FN9291xx

FN9280xx
FN9290xx
FN9283xx
FN9293xx

FN9280xx
FN9290xx
FN9282xx
FN9292xx

FN9280xx
FN9290xx
FN9284xx
FN9294xx

panel

panel

panel

panel

Cutout:

Cutout:

Cutout:

Cutout:

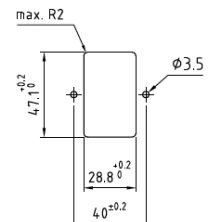
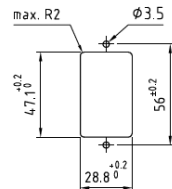
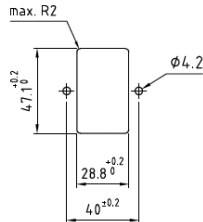
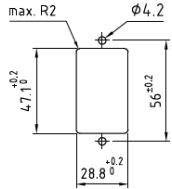

Assembly:

Assembly:

Assembly:

Assembly:

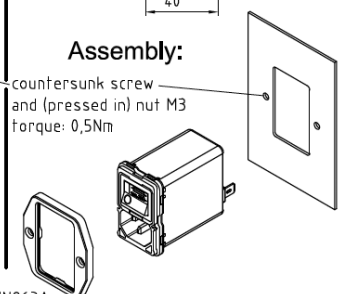
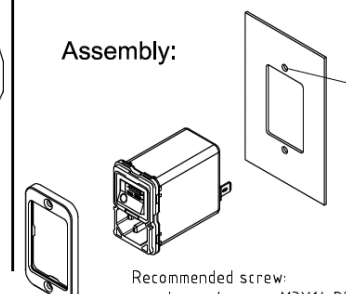
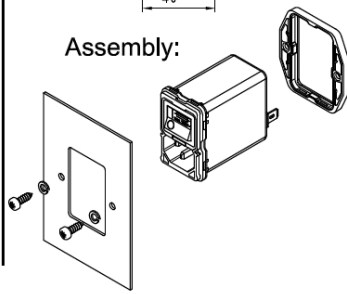
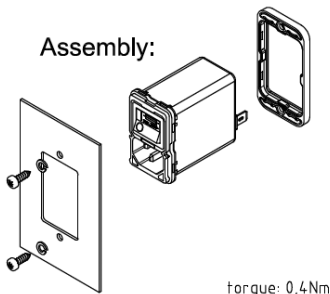

torque: 0,4Nm

Recommended screw:
countersunk screw M3X14 DIN963A

countersunk screw
and (pressed in) nut M3
torque: 0,5Nm

Terminal -100

clamping range, solid wire / flex wire

0,20 mm² – 1,5 mm², AWG24 – AWG16

operating force of slider

max. 40 N

recommended stripped length

8 mm

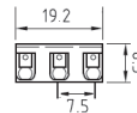

Push the knob above the terminal to insert the wire.

Removal of the combined switch / fuse holder unit

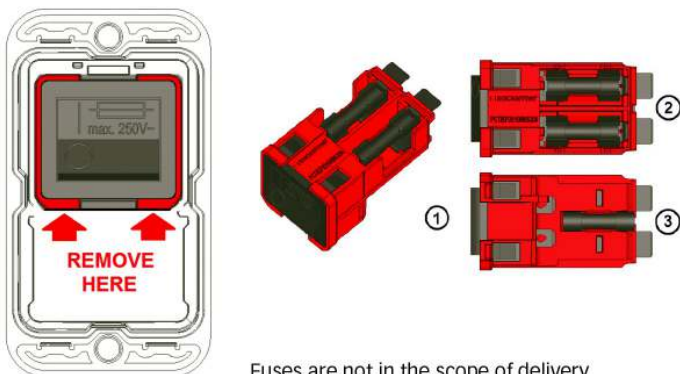

Fuses are not in the scope of delivery.

An additional fuse mark on the switch indicates the fuses holders behind the switch. The red frame shows the outline of the removable unit.

With a simple tool like a Swiss Army knife or a screwdriver No 1 or smaller the unit (1) can be removed from the filter. On the topside (2) behind the switch there are two fuse holders for each live connection. On the bottom side (3) is a clip to carry an additional spare fuse.

Please visit www.schaffner.com to find more details on filter connectors.



Headquarters, global innovation and development center

Switzerland

Schaffner Group

Nordstrasse 11
4542 Luterbach
T +41 32 6816 626
F +41 32 6816 630
info@schaffner.com
<http://www.schaffner.com>



Sales and application centers

China

Schaffner EMC Ltd. Shanghai

T20-3, No 565 Chuangye Road
Pudong New Area
201201 Shanghai
T +86 21 3813 9500
F +86 21 3813 9501 / 02
cschina@schaffner.com
<http://www.schaffner.com.cn/>

Finland

Schaffner Oy

Sauvonrinne 19 H
08500 Lohja
T +358 19 35 72 71
finlandsales@schaffner.com

France

Schaffner EMC S.A.S.

112, Quai de Bezons
Boîte postale 133
95103 Argenteuil
T +33 1 34 34 30 60
F +33 1 39 47 02 28
francesales@schaffner.com

Germany

Schaffner Deutschland GmbH

Schoemperlenstrasse 12B
76185 Karlsruhe
T +49 721 56910
F +49 721 569110
germanysales@schaffner.com

Italy

Schaffner EMC S.r.l.

Via Galileo Galilei 47
20092 Cinisello Balsamo (MI)
T +39 02 66 04 30 45/47
F +39 02 61 23 943
italysales@schaffner.com

Japan

Schaffner EMC K.K.

1-32-12, Kamiyama, Setagaya-ku
7F Mitsui-seimei Sangenjaya Bldg.
154-0011 Tokyo
T +81 3 5712 3650
F +81 3 5712 3651
japansales@schaffner.com
<http://www.schaffner.jp>

Singapore

Schaffner EMC Pte Ltd.

Blk 3015A Ubi Road 1
05-09 Kampong Ubi Industrial Estate
408705 Singapore
T +65 6377 3283
F +65 6377 3281
singaporesales@schaffner.com

Spain

Schaffner EMC España

Calle Caléndula 93
Miniparc III, Edificio E
El Soto de la Moraleja
Alcobendas
28109 Madrid
T +34 618 176 133
spainsales@schaffner.com

Sweden

Schaffner EMC AB

Turebergstorg 1, 6
19147 Sollentuna
T +46 8 5792 1121 / 22
F +46 8 92 96 90
swedensales@schaffner.com

Switzerland

Schaffner EMV AG

Nordstrasse 11
4542 Luterbach
T +41 32 6816 626
F +41 32 6816 641
sales@schaffner.ch

Taiwan R.O.C.

Schaffner EMV Ltd.

6 Floor, No. 413
Rui Guang Road
114 Neihu District Taipei City
T +886 2 87525050
F +886 2 87518086
taiwansales@schaffner.com

Thailand

Schaffner EMC Co. Ltd.

Northern Region Industrial Estate
67 Moo 4 Tambon Ban Klang
Amphur Muang P.O. Box 14
51000 Lamphun
T +66 53 58 11 04
F +66 53 58 10 19
thailandsales@schaffner.com

UK

Schaffner Ltd.

5 Ashville Way
Molly Millars Lane
Wokingham
RG41 2PL Berkshire
T +44 118 9770070
F +44 118 9792969
uksales@schaffner.com
<http://www.schaffner.uk.com>

USA

Schaffner EMC Inc.

52 Mayfield Avenue
08837 Edison, New Jersey
T +1 800 367 5566
T +1 732 225 9533
F +1 732 225 4789
usasales@schaffner.com
<http://www.schaffner.com/us>

Schaffner MTC LLC

6722 Thirlane Road
24019 Roanoke, Virginia
T +1 276 228 7943
F +1 276 228 7953
<http://www.schaffner-mtc.com>

Schaffner Trencos LLC

2550 Brookpark Road
44134 Cleveland, Ohio
T +1 216 741 5282
F +1 216 741 4860
www.schaffner-trencos.com

To find your local partner within Schaffner's global network: www.schaffner.com

© 2014 Schaffner Group

The content of this document has been carefully checked and understood. However, neither Schaffner nor its subsidiaries assume any liability whatsoever for any errors or inaccuracies of this document and the consequences thereof. Published specifications are subject to change without notice. Product suitability for any area of application must ultimately be determined by the customer. In all cases, products must never be operated outside their published specifications. Schaffner does not guarantee the availability of all published products. This disclaimer shall be governed by substantive Swiss law and resulting disputes shall be settled by the courts at the place of business of Schaffner Holding AG. Latest publications and a complete disclaimer can be downloaded from the Schaffner website. All trademarks recognized.

X-ON Electronics

Largest Supplier of Electrical and Electronic Components

Click to view similar products for [AC Power Entry Modules](#) category:

Click to view products by [Schaffner](#) manufacturer:

Other Similar products are found below :

[0098.0050](#) [6-1609987-9](#) [6167.0002](#) [7-6609955-2](#) [FN389-4-22](#) [FN9233ER-12-06](#) [FN9233S1-10-06](#) [FN9233S1-8-06](#) [FN9233S1B-8-06](#)
[FN9233S1R-1-06](#) [FN9233S1R-12-06](#) [FN9233SB-1-06](#) [FN9233SB-12-06](#) [FN9233SB-8-06](#) [FN9233SR-10-06](#) [FN9233SR-3-06](#) [FN9244B-15-06](#)
[HI](#) [FN9244EB-3-06](#) [FN9244EB-8-06](#) [FN9244ER-15-06](#) [FN9244ER-8-06](#) [FN9244ES1-8-06](#) [FN9244ESB-8-06](#) [FN9244EU-6-06](#)
[FN9244R-12-06](#) [FN9244R-3-07](#) [FN9244R-8-06](#) [FN9244S1-10-06](#) [FN9244S1-12-06](#) [FN9244S1-3-06](#) [FN9244S1B-6-06](#) [FN9244S1R-3-06](#)
[FN9244S-6-06](#) [FN9244SB-10-06](#) [FN9244SB-6-06](#) [FN9244SB-8-06](#) [FN9244SR-10-06](#) [FN9244SR-6-06](#) [FN9244U-3-06](#) [FN9244U-8-06](#)
[FN9260A-6-06](#) [PE00SSSXB](#) [Fuse-H-EUR-1](#) [Fuse-H-USA-1](#) [PM00XD000](#) [PS0SSDBX0](#) [PS0SXSH3B](#) [A-0701-HT-H](#) [RAPC3FG](#) [15EJMS8](#)