



EMC/EMI Chokes RD series

Current-compensated Chokes



- Rated currents from 6 to 64A
- Up to 600VAC or 850VDC
- DC to 400Hz frequencies
- Dual, triple and quad-choke configurations

Approvals

ROHS

Technical specifications

Flammability corresponding to:	UL 94V-0 (insulation tubes UL 94V-2)
High potential test voltage:	
Maximum continuous operating voltage:	600VAC/850VDC @ 40°C
MTBF @ 40°C/230V (Mil-HB-217F):	> 5,000,000 hours
Operating frequency:	dc to 400Hz
Rated currents:	6 to 64 A @ 40°C max.
Surge current @ 10msec:	20 x I _{nominal} @ 25°C
Temperature range (operation and storage):	-25°C to +110°C (25/110/21)
winding-to-housing:	4000VAC, 60 sec, guaranteed
winding-to-winding:	2500VAC, 60 sec, guaranteed
	2500V, 50Hz, 2 sec, factory test

Typical electrical schematic

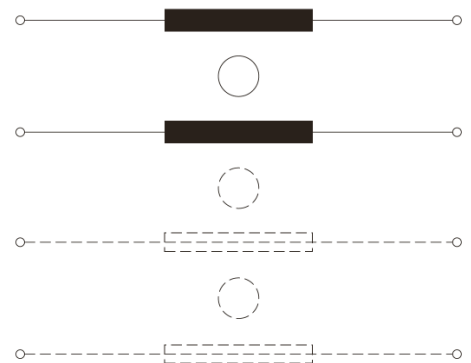

RD chokes are attenuating common-mode or asymmetric (P/N -> E) interference signals, by being connected in series with the phase and neutral lines of an AC powerline input. Symmetrical components of the noise are also attenuated by the leakage inductance of the windings. These chokes are typically used in conjunction with suppression capacitors.

Features and benefits

- High saturation resistance and excellent thermal behavior.
- Through hole or wire connections.
- Dual, triple and quad-choke configuration.
- Up to 64A quad configuration.
- Multiple housing options.
- Custom-specific versions are available on request.

Typical applications

- Phase-angle control circuits in combination with saturating chokes
- EMI input filters
- For suppressing equipment with no earth connection
- Suppressing high interference levels

Choke selection table

Choke	Nominal current @ 40°C	Inductance L	Resistance R	Choke configuration	Input/Output connections		Pin footprint connections	Weight
					[A]	[mH/path]		
RD 5122-6-9m6	6	9.6	52.55	2	-02		Ø1	160
RD 5122-10-6m0	10	6	24.25	2	-02		Ø1.3	160
RD 5122-16-2m0	16	2	9.5	2	-02		Ø1.6	160
RD 5132-6-5m0	6	5	38	3	-02		Ø1	160
RD 5132-10-3m0	10	3	17.6	3	-02		Ø1.3	160
RD 5132-16-1m0	16	1	6.9	3	-02		Ø1.6	160
RD 6127-6-15m0	6	15	66.65	2	-07		Ø1	235
RD 6127-10-9m0	10	9	25.9	2	-07		Ø1.5	235
RD 6127-16-3m0	16	3	10.9	2	-07		Ø1.8	235
RD 6137-6-7m5	6	7.5	49	3	-07		Ø1	235
RD 6137-10-4m5	10	4.5	18.35	3	-07		Ø1.5	235
RD 6137-16-1m5	16	1.5	8.3	3	-07		Ø1.8	235
RD 7127-6-25m0	6	25	84.2	2	-07		Ø1	320
RD 7127-10-14m0	10	14	33.5	2	-07		Ø1.4	350
RD 7127-16-5m7	16	5.7	14.1	2	-07		Ø1.8	370
RD 7127-25-2m8	25	2.8	6.4	2	-07		Ø2.4	400
RD 7127-36-1m0	36	1	3.3	2	-07		Ø2.7	380
RD 7137-6-12m0	6	12	60.6	3	-07		Ø1	340
RD 7137-10-6m6	10	6.6	21.9	3	-07		Ø1.5	380
RD 7137-16-2m8	16	2.8	10.7	3	-07		Ø1.8	380
RD 7137-25-1m3	25	1.3	4.45	3	-07		Ø2.5	440
RD 7137-36-0m5	36	0.5	2.75	3	-07		Ø2.7	400
RD 7147-6-6m0	6	6	45.1	4	-07		Ø1	320
RD 7147-10-3m5	10	3.5	19.1	4	-07		Ø1.4	370
RD 7147-16-1m5	16	1.5	8.5	4	-07		Ø1.8	390
RD 7147-25-0m7	25	0.7	3.65	4	-07		Ø2.4	430
RD 7147-36-0m2	36	0.2	2.3	4	-07		Ø2.5	400
RD 8127-16-12m0	16	12	20.05	2	-07		Ø2	590
RD 8127-25-5m0	25	5	8.45	2	-07		Ø2.4	630
RD 8127-36-3m0	36	3	4.55	2	-07		1.5 x 4.5	690
RD 8127-50-1m0	50	1	2.5	2	-07		1.7 x 5	640
RD 8127-64-0m8	64	0.8	1.6	2	-07		2.5 x 5	710
RD 8137-16-5m0	16	5	11.6	3	-07		Ø2	630
RD 8137-25-2m5	25	2.5	6.4	3	-07		Ø2.4	650
RD 8137-36-1m5	36	1.5	3.65	3	-07		1.5 x 4.5	720
RD 8137-50-0m6	50	0.6	2.15	3	-07		1.7 x 5	700
RD 8137-64-0m5	64	0.5	1.35	3	-07		2.5 x 5	780
RD 8147-16-3m0	16	3	9.25	4	-07		Ø2	650
RD 8147-25-1m3	25	1.3	5.05	4	-07		Ø2.4	650
RD 8147-36-0m8	36	0.8	3	4	-07		1.5 x 4.5	760
RD 8147-50-0m3	50	0.3	1.75	4	-07		1.7 x 5	740
RD 8147-64-0m2	64	0.2	1.1	4	-07		2.5 x 5	820

Test conditions:

Measuring frequency: 1kHz; 500µA > 0.16mH > 1.6mH; 50µA > 1.6mH < 160mH

Inductance tolerance: +50%, -30%

Resistance tolerance: max. ±15% @ 25°C; 200m, 100mA

Electrical characteristics @ 25°C: ±2°C

Typical choke attenuation/resonance frequency characteristics

Per CISPR 17; 50/50 asym

RD 51x2

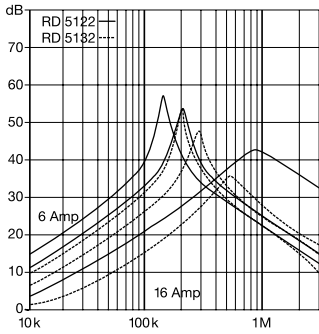

RD 61x7

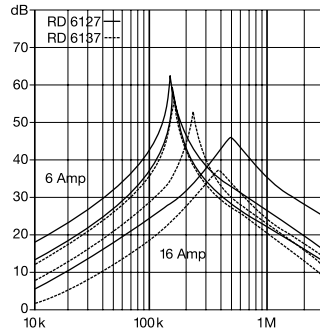

RD 7127

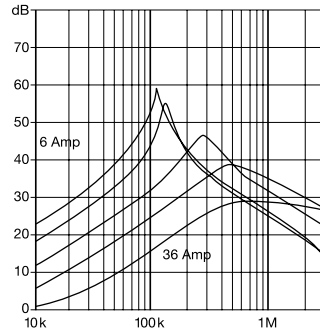

RD 7137

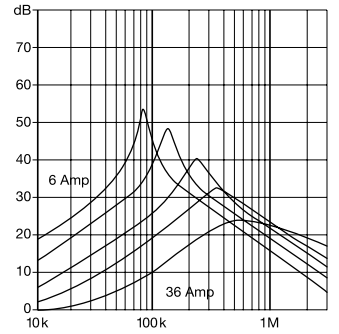

RD 7147

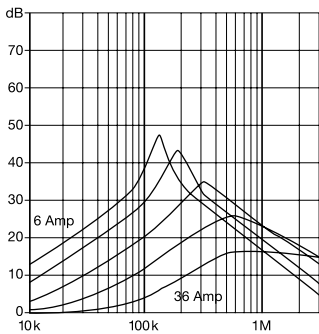

RD 8127

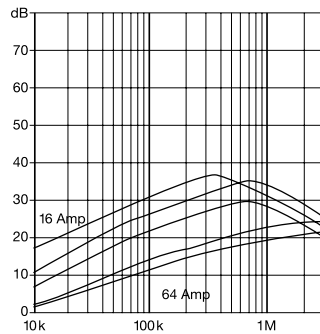

RD 8137

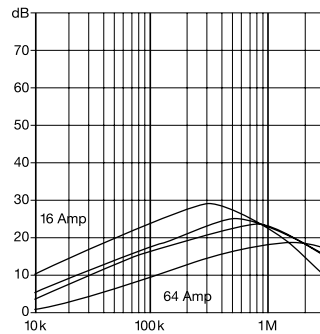

RD 8147

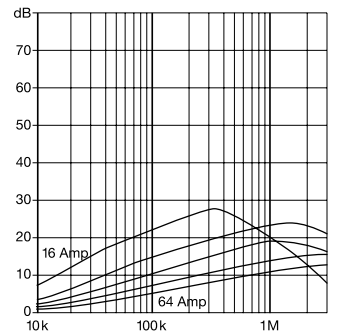

Typical saturation characteristics

Inductance (typical value in %) vs. nominal current (A DC)

RD 51x2

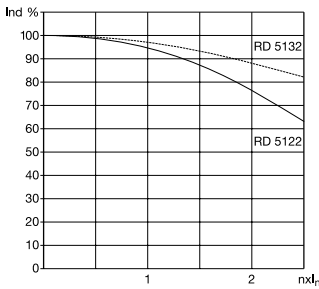

RD 61x7

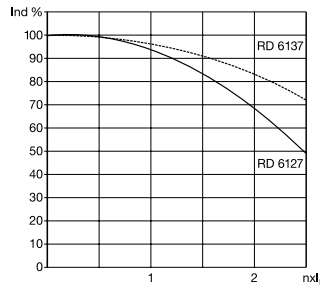

RD 71x7

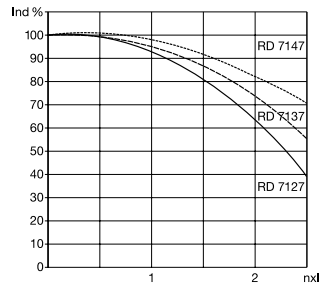

RD 81x7

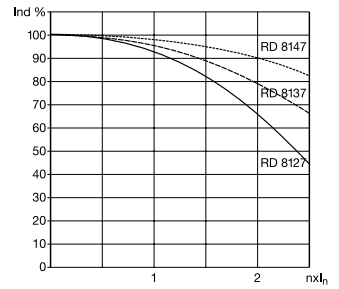

Mechanical data

RD 5122

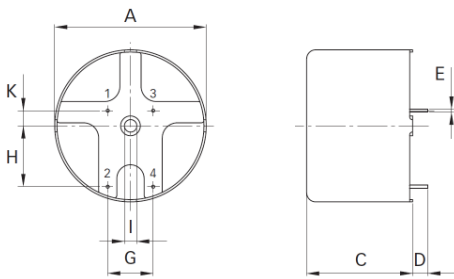

RD 5132

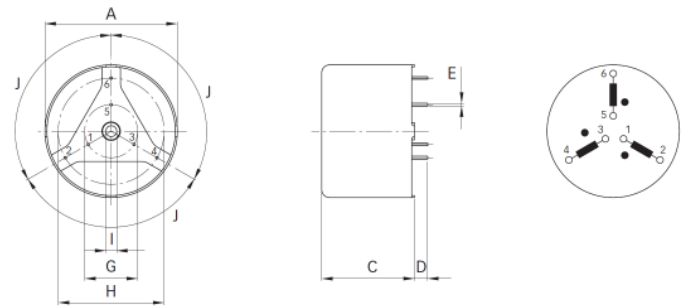

RD 6127, RD 7127, RD 8127

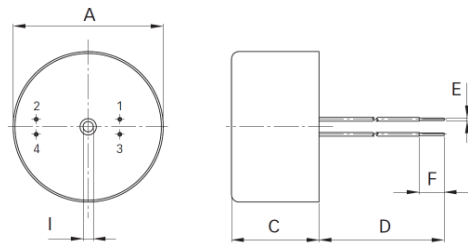

RD 6137, RD 7137, RD 8137

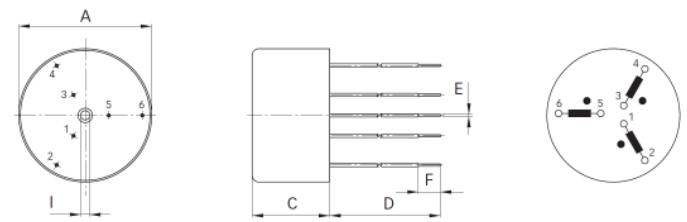

RD 7147, RD 8147

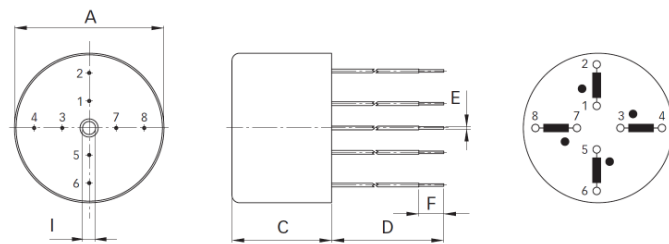

Dimensions

	RD 5122	RD 5132	RD 6127	RD 6137	RD 7127	RD 7137	RD 7147	RD 8127	RD 8137	RD 8147	Tolerances
A	50	50	60	60	70	70	70	80	80	80	±0.5
C	35	35	35	35	40	40	40	50	50	50	±0.5
D	5 ±0.5	5 ±0.5	150	150	150	150	150	200	200	200	+5/-0
E	see choke selection table										
F			10	10	10	10	10	20	20	20	±1
G	15	20									±0.3
H	20	40 ±0.4									±0.3
I	4.1 +3/-0	4.1 +3/-0	4.1 +3/-0	4.1 +3/-0	6.1	6.1	6.1	6.1	6.1	6.1	+6/-0
J		120°									
K	5										

All dimensions in mm; 1 inch = 25.4mm
Tolerances according to: ISO 2768-m / EN 22768-m

Headquarters, global innovation and development center

Schaffner Group

Nordstrasse 11
4542 Luterbach
Switzerland
T +41 32 681 66 26
F +41 32 681 66 30
info@schaffner.com
www.schaffner.com

To find your local partner within Schaffner's global network, please go to www.schaffner.com

© 2012 Schaffner Group
Specifications are subject to change without notice. The latest version of the data sheets can be obtained from the website. All trademarks recognized.

Schaffner is an ISO-registered company. Its products are designed and manufactured under the strict quality and environmental requirements of the ISO 9001 and ISO 14001 standards.

This document has been carefully checked. However, Schaffner does not assume any liability for errors or inaccuracies.

Sales and application centers

China
Schaffner EMC Ltd. Shanghai
T20-3, No 565 Chuangye Road
Pudong New Area
201201 Shanghai
T +86 21 3813 9500
F F +86 21 3813 9501 / 02
cschina@schaffner.com
<http://www.schaffner.com.cn/>

Finland
Schaffner Oy
Sauvonrinne 19 H
08500 Lohja
T +358 19 35 72 71
finlandsales@schaffner.com

France
Schaffner EMC S.A.S.
112, Quai de Bezons
Boîte postale 133
95103 Argenteuil
T +33 1 34 34 30 60
F +33 1 39 47 02 28
francesales@schaffner.com

Italy
Schaffner EMC S.r.l.
Via Galileo Galilei 47
20092 Cinisello Balsamo (MI)
T +39 02 66 04 30 45/47
F +39 02 61 23 943
italysales@schaffner.com

Japan
Schaffner EMC K.K.
1-32-12, Kamiuma, Setagaya-ku
7F Mitsui-seimei Sangenjaya Bldg.
154-0011 Tokyo
T +81 3 5712 3650
F +81 3 5712 3651
japansales@schaffner.com
<http://www.schaffner.jp>

Singapore
Schaffner EMC Pte Ltd.
Blk 3015A Ubi Road 1
05-09 Kampong Ubi Industrial Estate
408705 Singapore
T +65 6377 3283
F +65 6377 3281
singaporesales@schaffner.com

Germany
Schaffner Deutschland GmbH
Schoemperlenstrasse 12B
76185 Karlsruhe
T +49 721 56910
F +49 721 569110
germanysales@schaffner.com

Spain
Schaffner EMC España
Calle Caléndula 93, Miniparc III, Edificio E
El Soto de la Moraleja Alcobendas
28109 Madrid
T +34 618 176 133
spainsales@schaffner.com

Sweden
Schaffner EMC AB
Turebergstorg 1, 6
19147 Sollentuna
T +46 8 5792 1121 / 22
F +46 8 92 96 90
swedensales@schaffner.com

Switzerland
Schaffner EMV AG
Nordstrasse 11
4542 Luterbach
T +41 32 6816 626
F +41 32 6816 641
sales@schaffner.ch

Taiwan R.O.C.
Schaffner EMV Ltd.
6 Floor, No. 413
Rui Guang Road
114 Neihu District Taipei City
T +886 2 87525050
F +886 2 87518086
taiwansales@schaffner.com

Thailand
Schaffner EMC Co. Ltd.
Northern Region Industrial Estate
67 Moo 4 Tambon Ban Klang Amphur
Muangng P.O. Box 14
51000 Lamphun
T +66 53 58 11 04
F +66 53 58 10 19
thailandsales@schaffner.com

UK
Schaffner Ltd.
5 Ashville Way
Molly Millars Lane Wokingham
RG41 2PL Berks hire
T +44 118 9770070
F +44 118 9792969
uksales@schaffner.com
<http://www.schaffner.uk.com>

USA
Schaffner EMC Inc.
52 Mayfield Avenue
08837 Edison
T 1-800-367-5566
T 732-225-9533
F 732-225-4789
usasales@schaffner.com
<http://www.schaffner.com/us>

X-ON Electronics

Largest Supplier of Electrical and Electronic Components

Click to view similar products for [Common Mode Chokes / Filters](#) category:

Click to view products by [Schaffner](#) manufacturer:

Other Similar products are found below :

[74279408](#) [PE-62911NL](#) [PE-64683](#) [ST6118T-R](#) [T8114NLT](#) [RD5122-10-6M0](#) [TCM0806G-350-2P-T](#) [TCM0806G-650-2P-T](#) [IND-0110](#)
[UAL21V07012500](#) [UAL21VR0802000](#) [UAL24VR06500CH](#) [UALSC023000000](#) [UALSC1020JH000](#) [UALSC1520JH000](#)
[UALSU10VR20010](#) [UALSU16VD30030](#) [UALSU16VD40010](#) [UALSU9H0305000](#) [UALSU9HF060300](#) [UALSU9VD070100](#) [36-00037](#)
[5701610000](#) [UALW21HS072450](#) [UALSU9VD070400](#) [UALSU9HF050500](#) [UALSU9H0208000](#) [UALSCF25081300](#) [UAL24VK06450CH](#)
[PLT10HH501100PNB](#) [PLT10HH401100PNB](#) [PLT10HH1026R0PNB](#) [PE-67531](#) [EXC-X4CH120X](#) [TLH10UB 113 0R5](#) [2752041447](#)
[2752045447](#) [CMS3-11-R](#) [7351V](#) [CMF16-153131](#) [744252510](#) [T8116NLT](#) [FE2X10-4-2NL](#) [744253200](#) [744253101](#) [744252220](#) [TX8111NLT](#)
[UAL30VR3500470](#) [CTX01-19077-R](#) [T8003NLT](#)