

Saturating Chokes

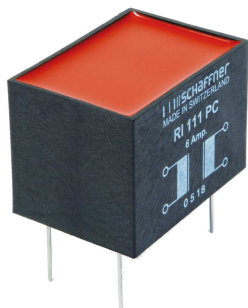

- Rated currents from 1.5 to 25 A

- Up to 500 VAC operating voltage

- DC to 1 kHz frequency

- Single or dual-choke configurations



Performance indicators

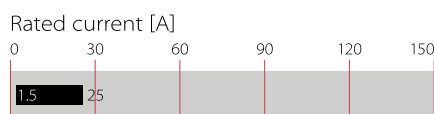

Technical specifications

Maximum continuous operating voltage	500 VAC @ 40°C
Rated currents	1.5 to 25 A @ 40°C max.
High potential test voltage winding-to-winding @ 25°C and/or winding-to-inserts	2500 VAC, 60 sec, guaranteed
Surge current @ 10 msec	20 x I _N @ 25°C
Temperature range (operation and storage)	-25°C to +110°C (25/110/21)
Flammability corresponding to	UL 94 V-0
MTBF @ 40°C/230 V (Mil-HB-217F)	>5,000,000 hours

Approvals

ROHS

RI saturating type chokes change impedance at the moment of switching, and can be used to attenuate differential-mode noise or symmetrical interference as generated in fast switching high current applications. These chokes are typically used in conjunction with suppression capacitors. For optimum attenuation chokes must be connected as close as possible to the semiconductor switching device.

Features and benefits

- Excellent thermal behavior

- Through hole or wire connections

- Single or dual-choke configurations

- Up to 25 A single configuration

- Custom-specific versions are available on request

Typical applications

- Suppressing high interference levels generated by fast switching circuits

- DC voltage smoothing

- EMC/EMI filters

- Phase angle control circuits



- Power supplies

- Chargers

Typical electrical schematic



Choke selection table

Choke	Nominal current @ 40°C [A]	Resistance R [mΩ/path]	Choke configuration [Qty]	Input/Output connections		Weight [g]
						
RI 111 PC	6	42	2	02		170
RI 401 PC	1.5	620	1	02		15
RI 403 PC	3	105	1	02		30
RI 406 PC	6	53	1	02		55
RI 410 PC	10	28	1	02		95
RI 415	15	8	1		07	205
RI 425	25	4	1		07	325

Test conditions:

Resistance tolerance: ±15% @ 25°C

Electrical characteristics @ 25°C: ±2°C

Typical saturation characteristics

Inductance (typical value in %) vs. nominal current in %

RI series

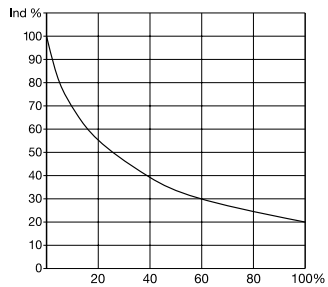

Mechanical data

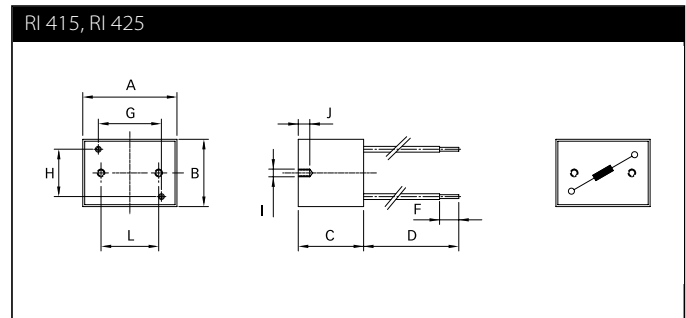
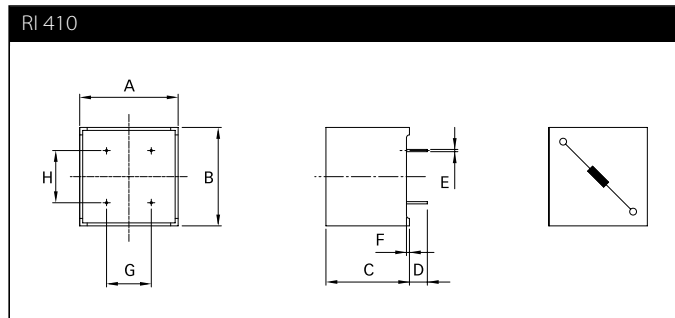
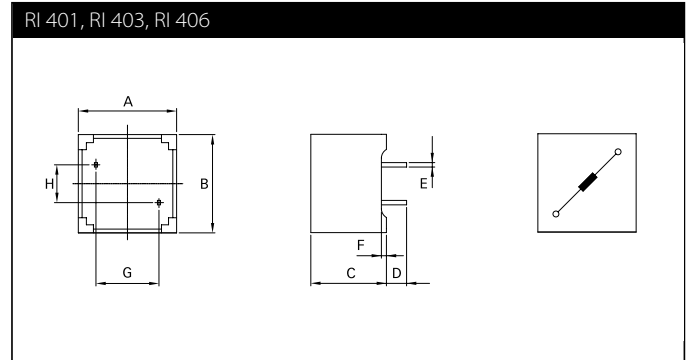
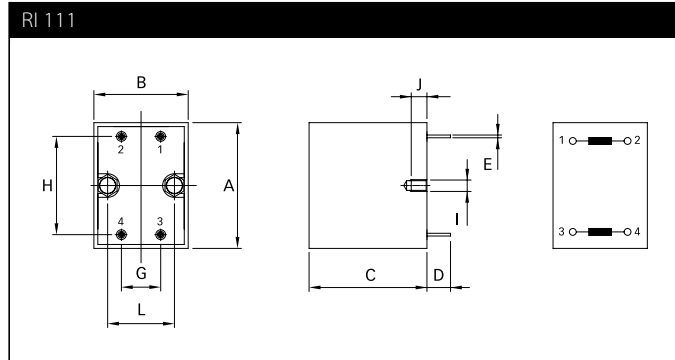

Dimensions

	RI 111	RI 401	RI 403	RI 406	RI 410	RI 415	RI 425	Tolerances
A	49	19.5	23.3	28.5	33	35	48	
B	35	19.5	23.3	28.5	33	49	48	
C	34	15	18	21.5	28	34	43	±0.3
D	15	4 ±0.5	6 ±0.5	4.5 ±0.5	6 ±0.5	200	200	
E	∅1.15	0.6 x 0.88	∅0.9	0.6 x 0.88	0.75 x 1.1			±0.1
F		1			1	10	10	
G	20	12.5	15	20	17.5	22	39	
H	40	7.5	10	10	15	36	35	
I	M4					M4	M4	
J	6					6	6	+0/-0.5
L	21					30	30	±0.25

All dimensions in mm; 1 inch = 25.4 mm
Tolerances according: ISO 2768-m/EN 22768-m

Please visit www.schaffner.com to find more details on filter connections.



Headquarters, global innovation and development

Switzerland

Schaffner Group

Nordstrasse 11
4542 Luterbach
T +41 32 681 66 26
info@schaffner.com
www.schaffner.com



Sales and application centers

China

Schaffner EMC Ltd. Shanghai

T20-3 C, No 565 Chuangye Road,
Pudong district
201201 Shanghai
T +86 21 3813 9500
cschina@schaffner.com
www.schaffner.com.cn

Finland

Schaffner Oy

Sauvonrinne 19 H
08500 Lohja
T +358 50 468 7284
finlandsales@schaffner.com

France

Schaffner EMC S.A.S.

16-20 Rue Louis Rameau
95875 Bezons
T +33 1 34 34 30 60
F +33 1 39 47 02 28
francesales@schaffner.com

Germany

Schaffner Deutschland GmbH

Schoemperlenstrasse 12B
76185 Karlsruhe
T +49 721 56910
F +49 721 569110
germanysales@schaffner.com

India

Schaffner India Pvt. Ltd

REGUS WORLD TRADE CENTRE
WTC, 22nd Floor Unit No 2238, Brigade
Gateway Campus, 26/1, Dr. Rajkumar Road
Malleswaram (W)
560055 Bangalore
T +91 80 67935355
indiasales@schaffner.com

Italy

Schaffner EMC S.r.l.

Via Ticino, 30
20900 Monza (MB)
T +39 039 21 41 070
italysales@schaffner.com

Japan

Schaffner EMC K.K.

1-32-12, Kamiyama, Setagaya-ku
7F Mitsui-seimei Sangenjaya Bldg.
154-0011 Tokyo
T +81 3 5712 3650
F +81 3 5712 3651
japansales@schaffner.com
www.schaffner.jp

Singapore

Schaffner EMC Pte Ltd.

#05-09, Kg Ubi Ind. Estate
408705 Singapore
T +65 6377 3283
F +65 6377 3281
singaporesales@schaffner.com

Spain

Schaffner EMC España

Calle Caléndula 93, Miniparc III, Edificio E
El Soto de Moraleja, Alcobendas
28109 Madrid
T +34 917 912 900
F +34 917 912 901
spainsales@schaffner.com

Sweden

Schaffner EMC AB

Tegeluddsvägen 76, 2tr
115 28 Stockholm
T +46 8 5050 2425
swedensales@schaffner.com
www.schaffner.com

Switzerland

Schaffner EMV AG

Nordstrasse 11
4542 Luterbach
T +41 32 681 66 26
switzerlandsales@schaffner.com

Taiwan R.O.C.

Schaffner EMV Ltd.

20 Floor-2, No 97, Section 1, XinTai 5th Road
22175 XiZhi District New Taipei City 22175
T +886 2 2697 5500
F +886 2 2697 5533
taiwansales@schaffner.com
www.schaffner.com.tw

Thailand

Schaffner EMC Co. Ltd.

Northern Region Industrial Estate
67 Moo 4 Tambon Ban Klang
Amphur Muangng P.O. Box 14
51000 Lamphun
T +66 53 58 11 04
F +66 53 58 10 19
thailandsales@schaffner.com

United Kingdom

Schaffner Ltd.

5 Ashville Way, Molly Millars Lane
Wokingham
RG41 2PL Berkshire
T +44 118 9770070
F +44 118 9792969
uksales@schaffner.com

USA

Schaffner EMC Inc.

52 Mayfield Avenue
08837 Edison, New Jersey
T +1 800 367 5566
T +1 732 225 9533
F +1 732 225 4789
usasales@schaffner.com
www.schaffnerusa.com

Schaffner North America

6722 Thirlane Road
24019 Roanoke, Virginia
T +1 276 228 7943
F +1 276 228 7953

Schaffner North America

823 Fairview Road
24382 Wytheville, Virginia
T +1 276 228 7943
F +1 276 228 7258

To find your local partner within Schaffner's global network: www.schaffner.com

© 2018 Schaffner Group

The content of this document has been carefully checked and understood. However, neither Schaffner nor its subsidiaries assume any liability whatsoever for any errors or inaccuracies of this document and the consequences thereof. Published specifications are subject to change without notice. Product suitability for any area of application must ultimately be determined by the customer. In all cases, products must never be operated outside their published specifications. Schaffner does not guarantee the availability of all published products. This disclaimer shall be governed by substantive Swiss law and resulting disputes shall be settled by the courts at the place of business of Schaffner Holding AG. Latest publications and a complete disclaimer can be downloaded from the Schaffner website. All trademarks recognized.

X-ON Electronics

Largest Supplier of Electrical and Electronic Components

Click to view similar products for [Fixed Inductors](#) category:

Click to view products by [Schaffner](#) manufacturer:

Other Similar products are found below :

[MLZ1608M6R8WTD25](#) [MLZ1608N6R8LT000](#) [MLZ1608N3R3LTD25](#) [MLZ1608N3R3LT000](#) [MLZ1608N150LT000](#)
[MLZ1608M150WTD25](#) [MLZ1608M3R3WTD25](#) [MLZ1608M3R3WT000](#) [MLZ1608M150WT000](#) [MLZ1608A1R5WT000](#)
[MLZ1608N1R5LT000](#) [B82432C1333K000](#) [PCMB053T-1R0MS](#) [PCMB053T-1R5MS](#) [PCMB104T-1R5MS](#) [CR32NP-100KC](#) [CR32NP-151KC](#) [CR32NP-180KC](#) [CR32NP-181KC](#) [CR32NP-1R5MC](#) [CR32NP-390KC](#) [CR32NP-3R9MC](#) [CR32NP-680KC](#) [CR32NP-820KC](#)
[CR32NP-8R2MC](#) [CR43NP-390KC](#) [CR43NP-560KC](#) [CR43NP-680KC](#) [CR54NP-181KC](#) [CR54NP-470LC](#) [CR54NP-820KC](#) [CR54NP-8R5MC](#)
[MGDQ4-00004-P](#) [MGDU1-00016-P](#) [MHL1ECTTP18NJ](#) [MHL1JCTTD12NJ](#) [PE-51506NL](#) [PE-53601NL](#) [PE-53630NL](#) [PE-53824SNLT](#) [PE-62892NL](#) [PE-92100NL](#) [PG0434.801NLT](#) [PG0936.113NLT](#) [PM06-2N7](#) [PM06-39NJ](#) [HC2LP-R47-R](#) [HC2-R47-R](#) [HC3-2R2-R](#) [HC8-1R2-R](#)