

Bell suction cup (round)

FSGA 22 NBR-55 G1/8-AG

Part no.:10.01.06.00079

<https://www.schmalz.com/10.01.06.00079>

Homepage > Vacuum Technology for Automation > Vacuum Components > Vacuum Suction Cups > Bellows Suction Cups (Round) > Bellows Suction Cups FSGA (1.5 Folds) > FSGA 22 NBR-55 G1/8-AG

Bellows suction cup (round) with optimal adaptation to uneven surfaces



Size: 22
 Number of folds: 1.5
 Suction cup material:
 Nitrile rubber NBR
 Material hardness: 55 °Sh
 Nipple material: Aluminium
 Vacuum connection: G1/8"-M

Design Data

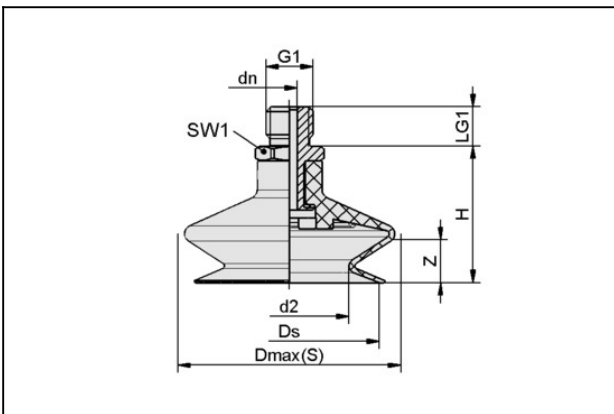

Attribute	Value
d2	11.7 mm
Dmax(S)	25 mm
dn	3.5 mm
Ds	21.5 mm
G1	G1/8"-AG
H	25 mm
LG1	7.5 mm
SW1	14 mm
Z (Stroke)	6 mm

Technical Data

Bell suction cup (round)

FSGA 22 NBR-55 G1/8-AG

Part no.:10.01.06.00079

<https://www.schmalz.com/10.01.06.00079>

Attribute	Value
Suction cup material	Nitrile rubber NBR
Material hardness [Shore A]	55 Shore A
Size	22
Number of folds	1.5
Connection	G1/8-AG
Curve radius (min) (convex)	25 mm
Volume	1.4 cm ³
Suction force (-600mbar)	5.7 N
Pull-off force	15.2 N
Hose diameter (empf.) d	4 mm
Weight	5.8 g
Product family	FSGA

Note: Suction force: The specified suction forces are theoretical values at a vacuum of -0.6 bar and with a smooth, dry workpiece surface - they do not include a safety factor Pull-off force: The pull-off force of the versions made of natural rubber is reduced by about 40% Hose diameter: The recommended hose diameter refers to a hose length of approx. 2 m

Spare Parts

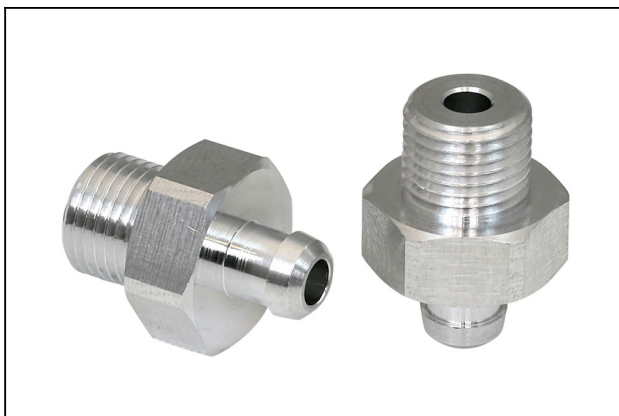

SA-NIP N016 G1/8-AG DN350

Part no.10.01.06.05735

Suction cup connection nipple

Nipple: N 016

Thread G1: G1/8"-M

Overall length: 20 mm

Fitting length: 6 mm

Nominal size: 3,50 mm

Material: Aluminium

Bell suction cup (round)

FSGA 22 NBR-55 G1/8-AG

Part no.:10.01.06.00079

<https://www.schmalz.com/10.01.06.00079>



FGA 22 NBR-55 N016

Part no.10.01.06.00097

Bellows suction cup (round) with optimal adaptation to uneven surfaces

Size: 22

Suction cup material:

Nitrile rubber NBR

Material hardness: 55 °Sh

Number of folds: 1.5

Accessories

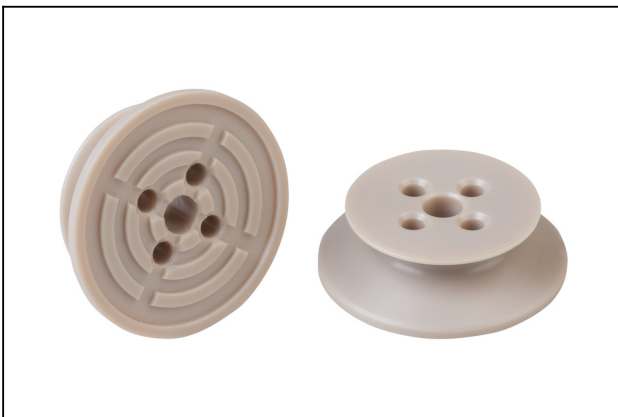

SPI 21 PEEK

Part no.10.01.06.03285

Suction cup insert for handling of sensitive workpieces without leaving marks

Size: 21

Material: Polyetheretherketon

X-ON Electronics

Largest Supplier of Electrical and Electronic Components

Click to view similar products for [Bench Top Tools](#) category:

Click to view products by [SCHMALZ](#) manufacturer:

Other Similar products are found below :

[0027](#) [6104-201-2102](#) [6104-201-2502](#) [6-1372442-6](#) [62500-1584](#) [63801-7252](#) [63801-7269](#) [69002-5525](#) [691667-1](#) [768539-1](#) [854130-1](#)
[854946-2](#) [856203-1](#) [904449-1](#) [9-22280-9](#) [986096-2](#) [992438-3](#) [1-21000-3](#) [1-21000-4](#) [1-21000-1](#) [1-25022-4](#) [1302263353](#) [1424264-1](#)
[1424267-1](#) [1428211-1](#) [1-455755-6](#) [1752324-1](#) [1752744-1](#) [18023-9](#) [189763-1](#) [1901726-1](#) [1954222-1](#) [2079747-1](#) [21001-2](#) [2119083-1](#)
[2119085-1](#) [2119371-1](#) [2161362-2](#) [2161930-1](#) [2217088-2](#) [2217339-1](#) [2217347-1](#) [22281-9](#) [22374-7](#) [240825-4](#) [992342-2](#) [2030790-2](#) [2063796-1](#) [2063799-2](#) [2119092-1](#)