

Universal holder

HTR-UNI 2N G2 110

Part no.:10.01.03.00328

<https://www.schmalz.com/10.01.03.00328>

Homepage > Vacuum Technology for Automation > Vacuum Components > Mounting Elements > Holder for Suction Cups and Spring Plungers
> Universal Holders HTR-UNI > HTR-UNI 2N G2 110

Universal holder for adjustable mounting of suction cups

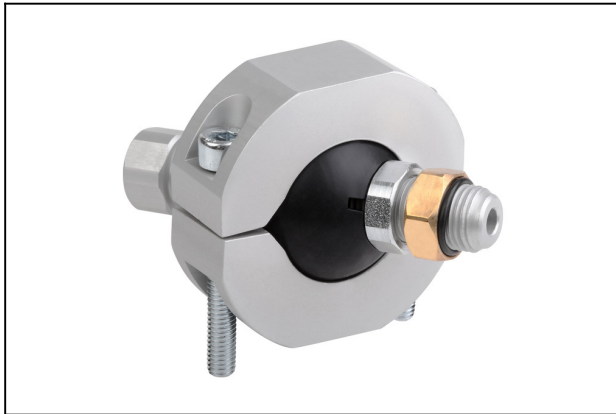

Cross-beam connection:
2 Sliding blocks
Suction cup connection: G1/4"-M
Overall length: 110 mm
Ambient temperature: 0 ... 80 °C

Design Data

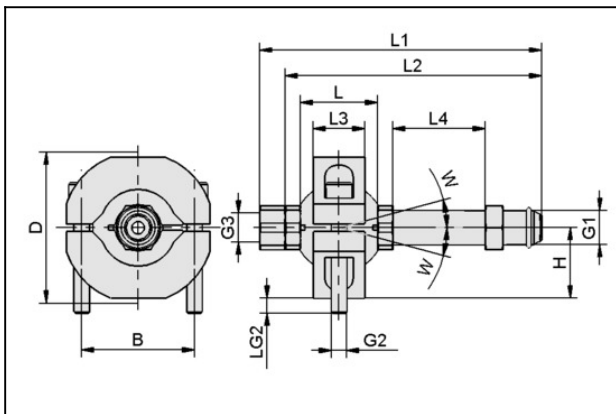

Attribute	Value
B	44 mm
D	59 mm
G1	G1/4"-AG
G2	M6-M
G3	G1/4"-F
H	27.5 mm
L	30 mm
L1	110 mm
L2	100 mm
L3	20 mm
L4	36 mm
LG2	6 mm
W	15 °

Universal holder

HTR-UNI 2N G2 110

Part no.:10.01.03.00328

<https://www.schmalz.com/10.01.03.00328>



Technical Data

Attribute	Value
Weight	204.2 g

Spare Parts

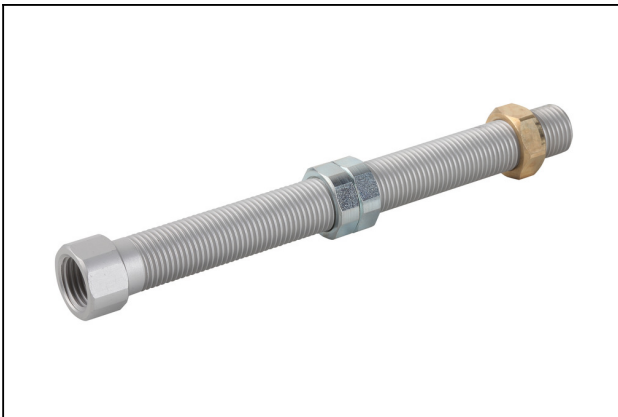

SAUG-ANB G1/4-AG 110

Part no.10.01.03.00327

Suction cup connection (rigid)

Suction cup connection: G1/4"-M

Length L: 110 mm

Accessories



STV-GE G1/4-AG 10

Part no.10.08.02.00251

Push-in Fitting, straight

Thread G1: G1/4"-M

External hose diameter: 10 mm

Material: Brass

Surface: nickel plated

Ambient temperature: -20 ... 80 °C

Universal holder

HTR-UNI 2N G2 110

Part no.:10.01.03.00328

<https://www.schmalz.com/10.01.03.00328>



STV-GE G1/4-AG 12

Part no.10.08.02.00208

Push-in Fitting, straight

Thread G1: G1/4"-M

External hose diameter: 12 mm

Material: Brass

Surface: nickel plated

Ambient temperature: -20 ... 80 °C



STV-GE G1/4-AG 6

Part no.10.08.02.00205

Push-in Fitting, straight

Thread G1: G1/4"-M

External hose diameter: 6 mm

Material: Brass

Surface: nickel plated

Ambient temperature: -20 ... 80 °C



STV-GE G1/4-AG 8

Part no.10.08.02.00207

Push-in Fitting, straight

Thread G1: G1/4"-M

External hose diameter: 8 mm

Material: Brass

Surface: nickel plated

Ambient temperature: -20 ... 80 °C

Universal holder

HTR-UNI 2N G2 110

Part no.:10.01.03.00328

<https://www.schmalz.com/10.01.03.00328>

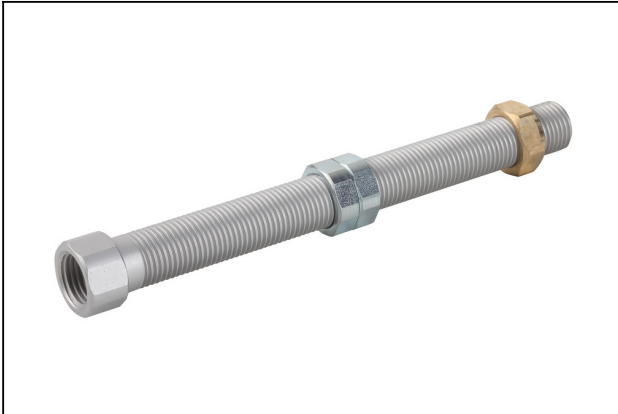

SAUG-ANB G1/4-AG 80

Part no.10.01.03.00292

Suction cup connection (rigid)

Suction cup connection: G1/4"-M

Length L: 80 mm

X-ON Electronics

Largest Supplier of Electrical and Electronic Components

Click to view similar products for [Bench Top Tools](#) category:

Click to view products by [SCHMALZ](#) manufacturer:

Other Similar products are found below :

[0027](#) [6104-201-2102](#) [6104-201-2502](#) [6-1372442-6](#) [62500-1584](#) [63801-7252](#) [63801-7269](#) [69002-5525](#) [691667-1](#) [768539-1](#) [854130-1](#)
[854946-2](#) [856203-1](#) [904449-1](#) [9-22280-9](#) [986096-2](#) [992438-3](#) [1-21000-3](#) [1-21000-4](#) [1-21000-1](#) [1-25022-4](#) [1302263353](#) [1424264-1](#)
[1424267-1](#) [1428211-1](#) [1-455755-6](#) [1752324-1](#) [1752744-1](#) [18023-9](#) [189763-1](#) [1901726-1](#) [1954222-1](#) [2079747-1](#) [21001-2](#) [2119083-1](#)
[2119085-1](#) [2119371-1](#) [2161362-2](#) [2161930-1](#) [2217088-2](#) [2217339-1](#) [2217347-1](#) [22281-9](#) [22374-7](#) [240825-4](#) [992342-2](#) [2030790-2](#) [2063796-1](#) [2063799-2](#) [2119092-1](#)