

## Cup

### ISCUP Cup 3 80x28x16

Part no.:10.01.15.00211

<https://www.schmalz.com/10.01.15.00211>

Homepage > Vacuum Clamping Technology > Clamping Equipment for Woodworking > Flexibilization of CNC Machining Centers > Innospann clamping equipment ISCUP/ISMB/ISQB > ISCUP Cup 3 80x28x16

## Suction cup for Innospann



Dimensions (LxW): 80 x 28 mm

Height H: 16 mm

## Design Data

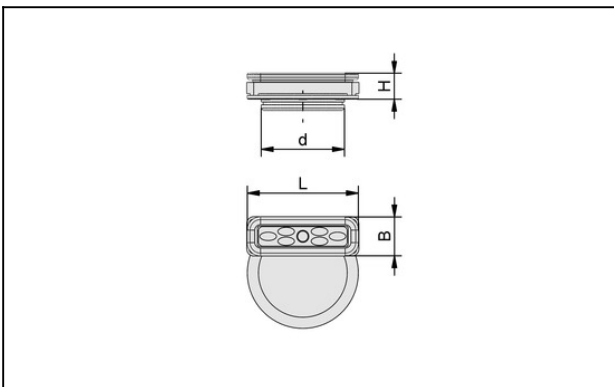

Attribute	Value
B	28 mm
d	60 mm
H	16 mm
L	80 mm

## Technical Data

Attribute	Value
Weight	0.058 kg

## Cup

### ISCUP Cup 3 80x28x16

Part no.:10.01.15.00211

<https://www.schmalz.com/10.01.15.00211>

#### Spare Parts

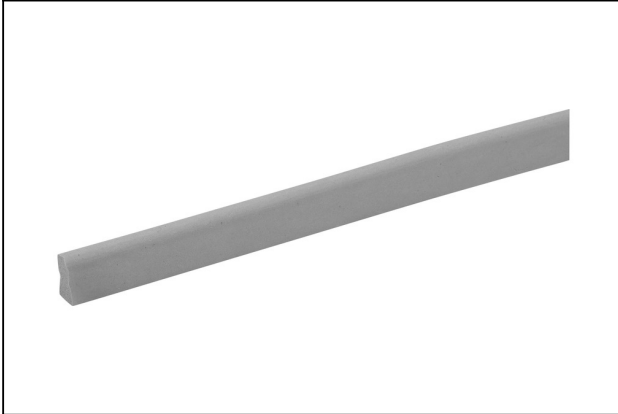

#### **DI-PROF 4x10 MOS EPDM HR**

Part no.10.01.15.00062

Sealing section for construction of specific gripper solutions

Width B: 4 mm

Height H: 10 mm

Material-Type: Foam rubber

Sealing material: EPDM

Shape: half-round

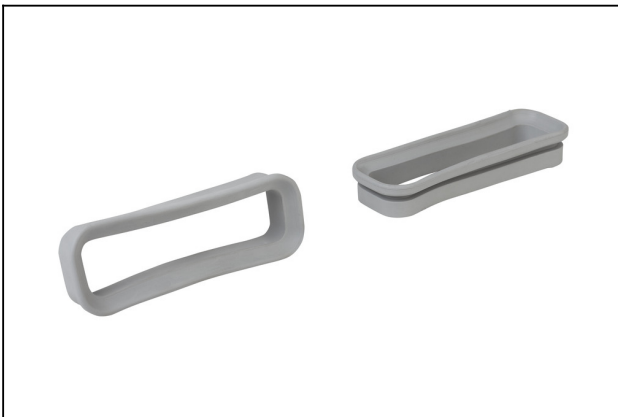

#### **ISDR 81x31x12 Cup 3 NK-50**

Part no.10.01.15.00022

Sealing frame

Length L: 81 mm

Width B: 31 mm

Height H: 12 mm

Type: Cup 3

Suction cup material:

Natural Rubber NK 50±5

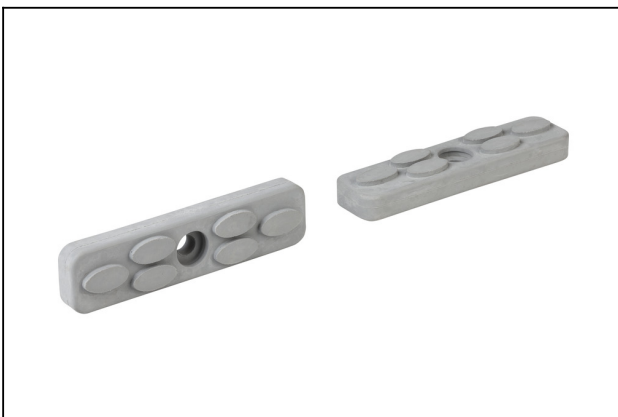

#### **ISRPL 66x14x8.5**

Part no.10.01.15.00019

Friction plate

Length L: 66 mm

Width B: 14 mm

Height H: 8.5 mm

Type: Cup 3

## X-ON Electronics

Largest Supplier of Electrical and Electronic Components

*Click to view similar products for [Bench Top Tools](#) category:*

*Click to view products by [SCHMALZ](#) manufacturer:*

Other Similar products are found below :

[0027](#) [6104-201-2102](#) [6104-201-2502](#) [6-1372442-6](#) [62500-1584](#) [63801-7252](#) [63801-7269](#) [69002-5525](#) [691667-1](#) [768539-1](#) [854130-1](#)  
[854946-2](#) [856203-1](#) [904449-1](#) [9-22280-9](#) [986096-2](#) [992438-3](#) [1-21000-3](#) [1-21000-4](#) [1-21000-1](#) [1-25022-4](#) [1302263353](#) [1424264-1](#)  
[1424267-1](#) [1428211-1](#) [1-455755-6](#) [1752324-1](#) [1752744-1](#) [18023-9](#) [189763-1](#) [1901726-1](#) [1954222-1](#) [2079747-1](#) [21001-2](#) [2119083-1](#)  
[2119085-1](#) [2119371-1](#) [2161362-2](#) [2161930-1](#) [2217088-2](#) [2217339-1](#) [2217347-1](#) [22281-9](#) [22374-7](#) [240825-4](#) [992342-2](#) [2030790-2](#) [2063796-1](#) [2063799-2](#) [2119092-1](#)