

Bellows suction cup NBR (round)

SAB 50 NBR-60 G1/4-AG

Part no.:10.01.06.00804

<https://www.schmalz.com/10.01.06.00804>

Homepage > Vacuum Technology for Automation > Vacuum Components > Vacuum Suction Cups > Suction Cups for Handling Sheet Metal >

Bellows Suction Cups SAB (1.5 Folds) > SAB 50 NBR-60 G1/4-AG

Bellows suction cup (round) for very dynamic handling of smooth and oily workpieces



Size: 50

Suction cup material:

Nitrile rubber NBR

Material hardness: 60 °Sh

Vacuum connection: G1/4"-M

Nipple material: Aluminium

Number of folds: 1.5

Design Data

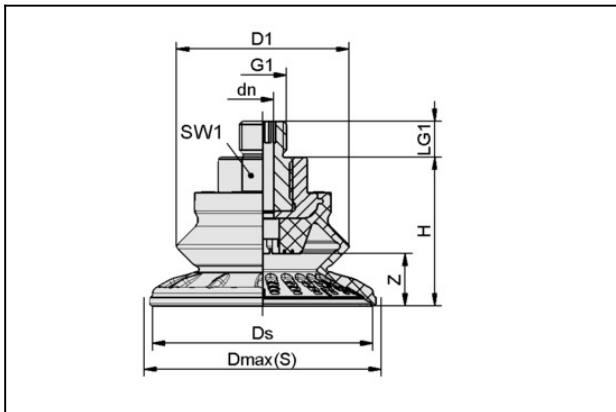

Attribute	Value
dn	6 mm
D1	39.5 mm
Dmax(S)	56 mm
Ds	50.1 mm
G1	G1/4"-AG
H	36.9 mm
LG1	10 mm
SW1	22 mm
Z (Stroke)	11.5 mm

Bellows suction cup NBR (round)

SAB 50 NBR-60 G1/4-AG

Part no.:10.01.06.00804

<https://www.schmalz.com/10.01.06.00804>



Technical Data

Attribute	Value
Suction force (-600mbar)	53 N
Pull-off force	87 N
Lateral force	55 N
Lateral force (oily surface)	52 N
Volume	16.1 cm ³
Curve radius (min) (convex)	50 mm
Hose diameter (empf.) d	4 mm
Size	50
Suction cup material	Nitrile rubber NBR
Material hardness [Shore A]	60 Shore A
Weight	41.4 g
Product family	SAB
Number of folds	1.5

Note: Suction force: The specified suction forces are theoretical values at a vacuum of -0.6 bar and with a smooth, dry workpiece surface - they do not include a safety factor Lateral force: The specified lateral forces are values measured at a vacuum of -0.6 bar with a dry or oily, smooth, flat workpiece surface. Depending on the workpiece surface and its quality, the actual values may deviate from these values Hose diameter: The recommended hose diameter refers to a hose length of approx. 2 m

X-ON Electronics

Largest Supplier of Electrical and Electronic Components

Click to view similar products for [Bench Top Tools](#) category:

Click to view products by [SCHMALZ](#) manufacturer:

Other Similar products are found below :

[0027](#) [6104-201-2102](#) [6104-201-2502](#) [6-1372442-6](#) [62500-1584](#) [63801-7252](#) [63801-7269](#) [69002-5525](#) [691667-1](#) [768539-1](#) [854130-1](#)
[854946-2](#) [856203-1](#) [904449-1](#) [9-22280-9](#) [986096-2](#) [992438-3](#) [1-21000-3](#) [1-21000-4](#) [1-21000-1](#) [1-25022-4](#) [1302263353](#) [1424264-1](#)
[1424267-1](#) [1428211-1](#) [1-455755-6](#) [1752324-1](#) [1752744-1](#) [18023-9](#) [189763-1](#) [1901726-1](#) [1954222-1](#) [2079747-1](#) [21001-2](#) [2119083-1](#)
[2119085-1](#) [2119371-1](#) [2161362-2](#) [2161930-1](#) [2217088-2](#) [2217339-1](#) [2217347-1](#) [22281-9](#) [22374-7](#) [240825-4](#) [992342-2](#) [2030790-2](#) [2063796-1](#) [2063799-2](#) [2119092-1](#)