

Bell suction cup (round)

SAX 50 ED-85 G3/8-IG

Part no.:10.01.19.00150

<https://www.schmalz.com/10.01.19.00150>

Homepage > Vacuum Technology for Automation > Vacuum Components > Vacuum Suction Cups > Suction Cups for Handling Sheet Metal >

Bell-Shaped Suction Cups SAX > SAX 50 ED-85 G3/8-IG

Bell suction cup (round) for best adaptation to strongly curved surfaces



Size: 50

Suction cup material: Elastodur

Material hardness: 85 °Sh

Vacuum connection: G3/8"-F

Nipple material: TPU-GF

Design Data

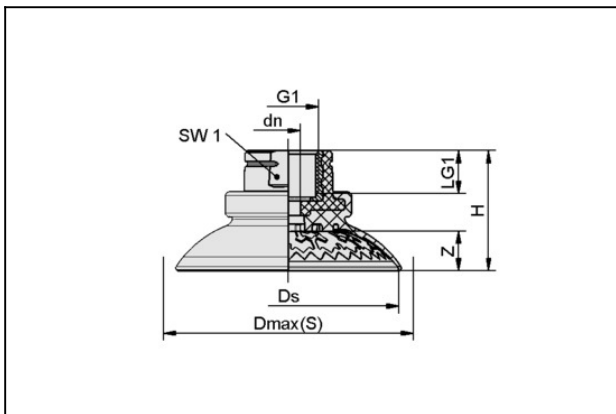

| Attribute | Value |
|------------|----------|
| dn | 6.75 mm |
| Dmax(S) | 58.4 mm |
| Ds | 51.5 mm |
| G1 | G3/8"-IG |
| H | 29.6 mm |
| LG1 | 12 mm |
| SW1 | 22 mm |
| Z (Stroke) | 8.4 mm |

Technical Data

Bell suction cup (round)

SAX 50 ED-85 G3/8-IG

Part no.:10.01.19.00150

<https://www.schmalz.com/10.01.19.00150>



| Attribute | Value |
|------------------------------|----------------------|
| Suction force (-600mbar) | 109 N |
| Lateral force | 74 N |
| Lateral force (oily surface) | 110 N |
| Volume | 15.2 cm ³ |
| Curve radius (min) (convex) | 25 mm |
| Size | 50 |
| Connection | G3/8"-F |
| Number of folds | 0 |
| Suction cup material | Elastodur |
| Material hardness [Shore A] | 85 Shore A |
| Weight | 26.2 g |
| Product family | SAX |

X-ON Electronics

Largest Supplier of Electrical and Electronic Components

Click to view similar products for [Bench Top Tools](#) category:

Click to view products by [SCHMALZ](#) manufacturer:

Other Similar products are found below :

[0027](#) [6104-201-2102](#) [6104-201-2502](#) [6-1372442-6](#) [62500-1584](#) [63801-7252](#) [63801-7269](#) [69002-5525](#) [691667-1](#) [768539-1](#) [854130-1](#)
[854946-2](#) [856203-1](#) [904449-1](#) [9-22280-9](#) [986096-2](#) [992438-3](#) [1-21000-3](#) [1-21000-4](#) [1-21000-1](#) [1-25022-4](#) [1302263353](#) [1424264-1](#)
[1424267-1](#) [1428211-1](#) [1-455755-6](#) [1752324-1](#) [1752744-1](#) [18023-9](#) [189763-1](#) [1901726-1](#) [1954222-1](#) [2079747-1](#) [21001-2](#) [2119083-1](#)
[2119085-1](#) [2119371-1](#) [2161362-2](#) [2161930-1](#) [2217088-2](#) [2217339-1](#) [2217347-1](#) [22281-9](#) [22374-7](#) [240825-4](#) [992342-2](#) [2030790-2](#) [2063796-1](#) [2063799-2](#) [2119092-1](#)