

Magnetic Grippers

SGM 50 G1/4-IG

Part no.:10.01.17.00164

<https://www.schmalz.com/10.01.17.00164>

Homepage > Vacuum Technology for Automation > Vacuum Components > Special Grippers > Magnetic gripper > Magnetic Grippers SGM > SGM 50 G1/4-IG

Magnetic gripper for handling metal sheets with holes



Size: 50
 Socket: G1/4"-F
 Holding force max friction ring: 180 N
 Pressure range (operating pressure):
 3.5 ... 6.0 bar

Design Data

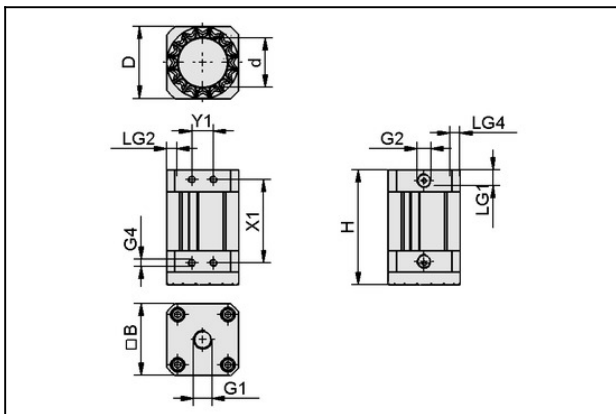

Attribute	Value
B	50.6 mm
D	50 mm
d	35 mm
G1	G1/4"-IG
G2	G1/8"-F
G4	M5-F
H	80.2 mm
LG1	11 mm
LG2	6 mm
LG4	7 mm
X1	58 mm
Y1	15 mm

Magnetic Grippers

SGM 50 G1/4-IG

Part no.:10.01.17.00164

<https://www.schmalz.com/10.01.17.00164>

Technical Data

Attribute	Value
Remaining force	0.3 N
Pressure range (operating pressure)	3.5 ... 6.0 bar
Installation position	Any
Control valve	Bistabil
Operating temperature	5 ... 70 °C
Weight	440 g

Note: Holding force: The value given is a statistical value with no safety factor; based on a plate with a thickness of 2 mm. For system configurations with magnetic grippers SGM, a safety factor of $S = 3$ must be applied

Spare Parts



REIB-RING SGM 50 PU-55

Part no.10.01.17.00138

Friction ring

for: Magnetic gripper

Size: 50

External diameter D: 50 mm

Internal diameter d: 35 mm

Accessories

Magnetic Grippers

SGM 50 G1/4-IG

Part no.:10.01.17.00164

<https://www.schmalz.com/10.01.17.00164>

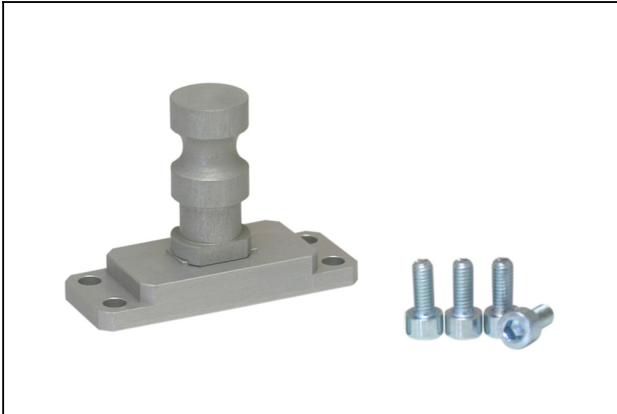

HTS-A2 SGM 50/70

Part no.10.01.17.00172

Holder system

Cross-beam connection:

Bolt with slot \varnothing 19mm

for: Magnetic gripper

Size: 50/70



HTS-A3 SGM 50/70

Part no.10.01.17.00173

Holder system

Cross-beam connection:

Ball head 28.5 mm

for: Magnetic gripper

Size: 50/70

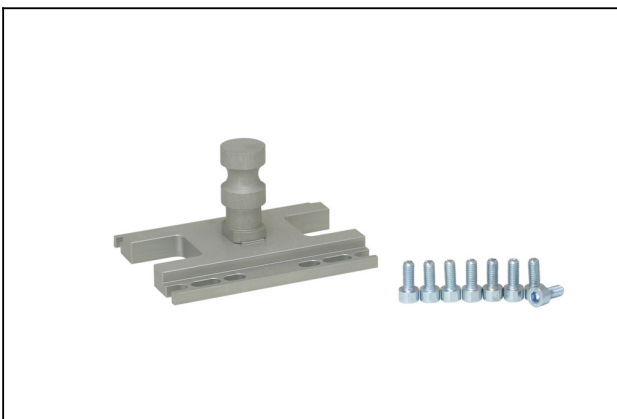

HTS-A2 D SGM 50/70

Part no.10.01.17.00178

Holder system

Cross-beam connection:

Bolt with slot \varnothing 19mm

Shape: Double block

for: Magnetic gripper

Size: 50/70

Magnetic Grippers

SGM 50 G1/4-IG

Part no.:10.01.17.00164

<https://www.schmalz.com/10.01.17.00164>

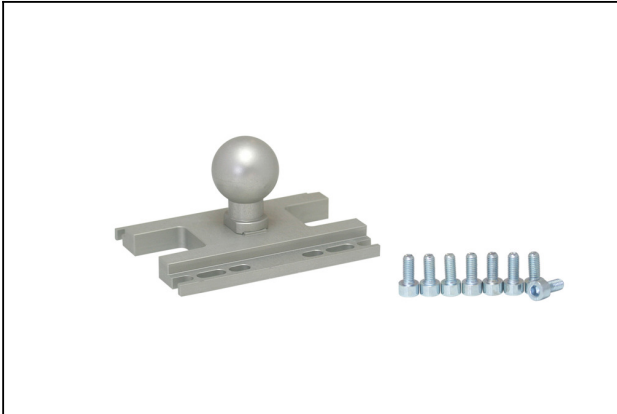

HTS-A3 D SGM 50/70

Part no.10.01.17.00179

Holder system

Cross-beam connection:

Ball head 28.5 mm

Shape: Double block

for: Magnetic gripper

Size: 50/70



STV-GE G1/8-AG 6

Part no.10.08.02.00204

Push-in Fitting, straight

Thread G1: G1/8"-M

External hose diameter: 6 mm

Material: Brass

Surface: nickel plated

Ambient temperature: -20 ... 80 °C



STV-W G1/8-AG 6

Part no.10.08.02.00158

Push-in Fitting, swivelling elbow

Thread G1: G1/8"-M

External hose diameter: 6 mm

Material: Brass, nickel-plated

Ambient temperature: -20 ... 80 °C

Magnetic Grippers

SGM 50 G1/4-IG

Part no.:10.01.17.00164

<https://www.schmalz.com/10.01.17.00164>



VSL 6-4 PU

Part no.10.07.09.00002

Hose for vacuum and compressed-air systems

External diameter D: 6 mm

Internal diameter d: 4 mm

Length (max): 500 m

Material: PU

Installation radius (min): 35 mm

Pressure range (operating pressure):

-0.95 ... 10.00 bar

Ambient temperature: -20 ... 90 °C

X-ON Electronics

Largest Supplier of Electrical and Electronic Components

Click to view similar products for [Bench Top Tools](#) category:

Click to view products by [SCHMALZ](#) manufacturer:

Other Similar products are found below :

[0027](#) [6104-201-2102](#) [6104-201-2502](#) [6-1372442-6](#) [62500-1584](#) [63801-7252](#) [63801-7269](#) [69002-5525](#) [691667-1](#) [768539-1](#) [854130-1](#)
[854946-2](#) [856203-1](#) [904449-1](#) [9-22280-9](#) [986096-2](#) [992438-3](#) [1-21000-3](#) [1-21000-4](#) [1-21000-1](#) [1-25022-4](#) [1302263353](#) [1424264-1](#)
[1424267-1](#) [1428211-1](#) [1-455755-6](#) [1752324-1](#) [1752744-1](#) [18023-9](#) [189763-1](#) [1901726-1](#) [1954222-1](#) [2079747-1](#) [21001-2](#) [2119083-1](#)
[2119085-1](#) [2119371-1](#) [2161362-2](#) [2161930-1](#) [2217088-2](#) [2217339-1](#) [2217347-1](#) [22281-9](#) [22374-7](#) [240825-4](#) [992342-2](#) [2030790-2](#) [2063796-1](#) [2063799-2](#) [2119092-1](#)