

Vacuum block

VCBL-B 120x50x74 TV

Part no.:10.01.12.03175

<https://www.schmalz.com/10.01.12.03175>

Homepage > Vacuum Clamping Technology > Clamping Equipment for Woodworking > Clamping Equipment for Systems from Biesse > Vacuum Blocks VCBL-B > VCBL-B 120x50x74 TV

Vacuum block



Dimensions (LxW): 120 x 50 mm
 Height H: 74 mm
 with: Sensing valve

Design Data

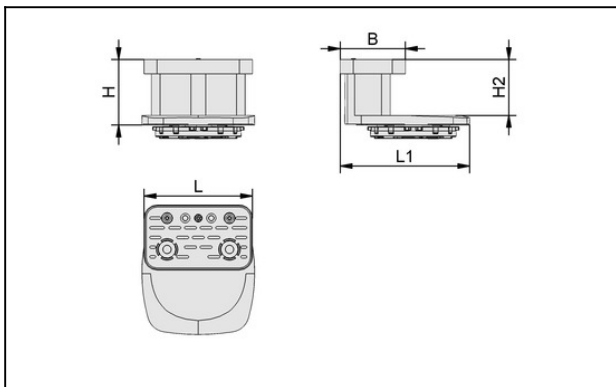

Attribute	Value
B	50 mm
H	74 mm
H2	64 mm
L	120 mm
L1	146 mm

Technical Data

Attribute	Value
Weight	0.478 kg

Biesse is a registered and protected trademark. The articles listed here are products of J. Schmalz GmbH that have been designed to fit CNC machining centers from Biesse.

Vacuum block

VCBL-B 120x50x74 TV

Part no.:10.01.12.03175

<https://www.schmalz.com/10.01.12.03175>



Spare Parts



VCSP-O 120x50x15.5

Part no.10.01.12.00012

Suction-Plate for vacuum block, (top)

Dimensions (LxW): 120 x 50 mm

Height H: 15.5 mm

X-ON Electronics

Largest Supplier of Electrical and Electronic Components

Click to view similar products for [Bench Top Tools](#) category:

Click to view products by [SCHMALZ](#) manufacturer:

Other Similar products are found below :

[0027](#) [6104-201-2102](#) [6104-201-2502](#) [6-1372442-6](#) [62500-1584](#) [63801-7252](#) [63801-7269](#) [69002-5525](#) [691667-1](#) [768539-1](#) [854130-1](#)
[854946-2](#) [856203-1](#) [904449-1](#) [9-22280-9](#) [986096-2](#) [992438-3](#) [1-21000-3](#) [1-21000-4](#) [1-21000-1](#) [1-25022-4](#) [1302263353](#) [1424264-1](#)
[1424267-1](#) [1428211-1](#) [1-455755-6](#) [1752324-1](#) [1752744-1](#) [18023-9](#) [189763-1](#) [1901726-1](#) [1954222-1](#) [2079747-1](#) [21001-2](#) [2119083-1](#)
[2119085-1](#) [2119371-1](#) [2161362-2](#) [2161930-1](#) [2217088-2](#) [2217339-1](#) [2217347-1](#) [22281-9](#) [22374-7](#) [240825-4](#) [992342-2](#) [2030790-2](#) [2063796-1](#) [2063799-2](#) [2119092-1](#)