

Vacuum block

VCBL-K2 125x75x100 Q

Part no.:10.01.12.00447

<https://www.schmalz.com/10.01.12.00447>

Homepage > Vacuum Clamping Technology > Clamping Equipment for Woodworking > Clamping Equipment for 2-Circuit Systems > Vacuum Blocks VCBL-K2 > VCBL-K2 125x75x100 Q

Vacuum block for Schmalz 2-circuit console



Dimensions (LxW): 125 x 75 mm

Height H: 100 mm

Arrangement: crossways

Design Data

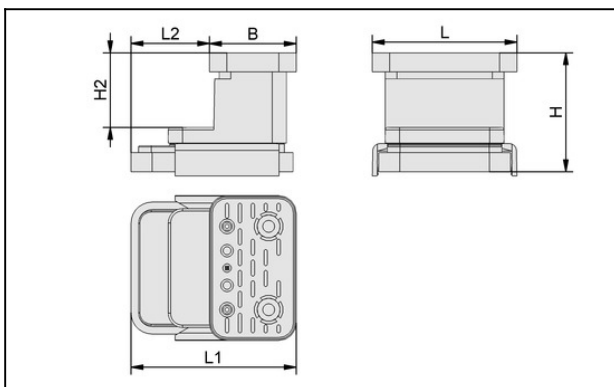

Attribute	Value
B	75 mm
H	100 mm
H2	63 mm
L	125 mm
L1	145 mm
L2	67.8 mm

Technical Data

Attribute	Value
Weight	0.63 kg

Vacuum block

VCBL-K2 125x75x100 Q

Part no.:10.01.12.00447

<https://www.schmalz.com/10.01.12.00447>

Spare Parts



VCSP-O 125x75x16.5

Part no.10.01.12.00011

Suction-Plate for vacuum block, (top)

Dimensions (LxW): 125 x 75 mm

Height H: 16.5 mm



VCSP-U 140x115x16.5 VCBL-K2

Part no.10.01.12.00798

Suction plate for vacuum block bottom

Dimensions (LxW): 140 x 115 mm

Height H: 16.5 mm

for: Vacuum block VCBL-K2

X-ON Electronics

Largest Supplier of Electrical and Electronic Components

Click to view similar products for [Bench Top Tools](#) category:

Click to view products by [SCHMALZ](#) manufacturer:

Other Similar products are found below :

[0027](#) [6104-201-2102](#) [6104-201-2502](#) [6-1372442-6](#) [62500-1584](#) [63801-7252](#) [63801-7269](#) [69002-5525](#) [691667-1](#) [768539-1](#) [854130-1](#)
[854946-2](#) [856203-1](#) [904449-1](#) [9-22280-9](#) [986096-2](#) [992438-3](#) [1-21000-3](#) [1-21000-4](#) [1-21000-1](#) [1-25022-4](#) [1302263353](#) [1424264-1](#)
[1424267-1](#) [1428211-1](#) [1-455755-6](#) [1752324-1](#) [1752744-1](#) [18023-9](#) [189763-1](#) [1901726-1](#) [1954222-1](#) [2079747-1](#) [21001-2](#) [2119083-1](#)
[2119085-1](#) [2119371-1](#) [2161362-2](#) [2161930-1](#) [2217088-2](#) [2217339-1](#) [2217347-1](#) [22281-9](#) [22374-7](#) [240825-4](#) [992342-2](#) [2030790-2](#) [2063796-1](#) [2063799-2](#) [2119092-1](#)