



EN Operating instructions. pages 1 to 6
Original

CS Aktuální verzi návodu k použití ve vašem jazyce naleznete na www.schmersal.net.

DA På www.schmersal.net findes aktuelle betjeningsvejledninger på EU's officielle sprog.

ES Encontrará el manual de instrucciones actual en su idioma oficial de la UE en nuestra página de Internet www.schmersal.net.

FR Vous trouverez la version actuelle du mode d'emploi dans votre langue nationale officielle sur l'Internet, www.schmersal.net.

IT Il manuale d'istruzioni aggiornato nella vostra lingua (lingua ufficiale UE) è scaricabile in Internet all'indirizzo www.schmersal.net.

JP 日本語の取扱説明書は、インターネット (www.schmersal.net) からダウンロード出来ます。

NL U vindt de huidige versie van de gebruikshandleiding in uw officiële landstaal op het Internet, www.schmersal.net.

PL Tutaj znajdziesz aktualną wersję instrukcji obsługi w Twoim języku na stronie internetowej www.schmersal.net.

PT O manual de instruções actual, no seu idioma oficial da UE, encontra-se na nossa página de Internet www.schmersal.net.

SV På www.schmersal.net finner ni de aktuella versionerna av bruksanvisningen på EU's officiella språk.

Content

1 About this document
 1.1 Function 1
 1.2 Target group: authorised qualified personnel. 1
 1.3 Explanation of the symbols used 1
 1.4 Appropriate use 1
 1.5 General safety instructions 1
 1.6 Warning about misuse 1
 1.7 Exclusion of liability 2

2 Product description
 2.1 Ordering code 2
 2.2 Special versions. 2
 2.3 Purpose 2
 2.4 Technical data 3
 2.5 Safety classification of the interlocking function. 3
 2.6 Safety classification of the guard locking function. 3

3 Mounting
 3.1 General mounting instructions 3
 3.2 Dimensions 4
 3.3 Adjustment. 4

4 Electrical connection
 4.1 General information for electrical connection. 4
 4.2 Connection and sealing 4
 4.3 Contact variants. 5

5 Set-up and maintenance
 5.1 Functional testing. 5
 5.2 Maintenance 5

6 Disassembly and disposal
 6.1 Disassembly. 5
 6.2 Disposal 5

7 EU Declaration of conformity

1. About this document

1.1 Function

This operating instructions manual provides all the information you need for the mounting, set-up and commissioning to ensure the safe operation and disassembly of the safety switchgear. The operating instructions must be available in a legible condition and a complete version in the vicinity of the device.

1.2 Target group: authorised qualified personnel

All operations described in this operating instructions manual must be carried out by trained specialist personnel, authorised by the plant operator only.

Please make sure that you have read and understood these operating instructions and that you know all applicable legislations regarding occupational safety and accident prevention prior to installation and putting the component into operation.

The machine builder must carefully select the harmonised standards to be complied with as well as other technical specifications for the selection, mounting and integration of the components.

1.3 Explanation of the symbols used



Information, hint, note:

This symbol is used for identifying useful additional information.



Caution: Failure to comply with this warning notice could lead to failures or malfunctions.

Warning: Failure to comply with this warning notice could lead to physical injury and/or damage to the machine.

1.4 Appropriate use

The products described in these operating instructions are developed to execute safety-related functions as part of an entire plant or machine. It is the responsibility of the manufacturer of a machine or plant to ensure the correct functionality of the entire machine or plant.

The safety switchgear must be exclusively used in accordance with the versions listed below or for the applications authorised by the manufacturer. Detailed information regarding the range of applications can be found in the chapter "Product description".

1.5 General safety instructions

The user must observe the safety instructions in this operating instructions manual, the country specific installation standards as well as all prevailing safety regulations and accident prevention rules.



Further technical information can be found in the Schmersal catalogues or in the online catalogue on the Internet: www.schmersal.net.

The information contained in this operating instructions manual is provided without liability and is subject to technical modifications.

There are no residual risks, provided that the safety instructions as well as the instructions regarding mounting, commissioning, operation and maintenance are observed.

1.6 Warning about misuse



In case of improper use or manipulation of the safety switchgear, personal hazards or damages to machinery or plant components cannot be excluded. The relevant requirements of the standard ISO 14119 must be observed.

1.7 Exclusion of liability

We shall accept no liability for damages and malfunctions resulting from defective mounting or failure to comply with this operating instructions manual. The manufacturer shall accept no liability for damages resulting from the use of unauthorised spare parts or accessories.

For safety reasons, invasive work on the device as well as arbitrary repairs, conversions and modifications to the device are strictly forbidden; the manufacturer shall accept no liability for damages resulting from such invasive work, arbitrary repairs, conversions and/or modifications to the device.

2. Product description

2.1 Ordering code

This operating instructions manual applies to the following types:

AZM 415-①②PK③-④-⑤⑥-⑦

No.	Option	Description
①		Magnet Actuator
	11/11	1 NC / 1 NO 1 NC / 1 NO
	11/02	1 NC / 1 NO 2 NC
	11/20	1 NC / 1 NO 2 NO
	02/11	2 NC 1 NC / 1 NO
	02/20	2 NC 2 NO
	02/02	2 NC 2 NC
②	X	Protection class IP54
	Z	Protection class IP67
③		Power to unlock
	A	Power to lock
④		cable entry M20
	ST	M23 connector bottom
	STR	M23 connector at the right-hand side without manual release
⑤	E	Manual release using triangular key
	F	Manual release using locking screw
	FE	Manual release using triangular key
	RS	Manual release using key
	T	Emergency exit using latched pushbutton
	TE	Emergency exit and manual release, outside mounting
	TEI	Emergency exit and manual release, inside mounting
	NS	Emergency release using lock button
⑥	24 VAC/DC	U _s 24 VAC/DC
	110 VAC	U _s 110 VAC
	230 VAC	U _s 230 VAC
⑦	1637	Gold-plated contacts



Only if the information described in this operating instructions manual are realised correctly, the safety function and therefore the compliance with the Machinery Directive is maintained.

2.2 Special versions

For special versions, which are not listed in the order code below 2.1, these specifications apply accordingly, provided that they correspond to the standard version.

2.3 Purpose

The solenoid interlock has been designed to prevent movable safety guards, e.g. fences, covers or doors, in conjunction with the control part of a machine, e.g. fail-safe delay timers or fail-safe standstill monitors, from being opened before hazardous conditions (e.g. run-on movements) have been eliminated.



Interlocks with power to lock principle may only be used in special cases after a thorough evaluation of the accident risk, since the safety guard can be opened immediately on failure of the power supply or upon activation of the main switch.



The safety switchgears are classified according to ISO 14119 as type 2 interlocking devices.

Manual release

The manual release is only used with components that operate on the power to unlock principle. It is used as a mounting tool and also as a tool to open a closed and locked safety guard in case of a power failure. The point of access to the manual release or the manual release itself must be protected in accordance with the provisions of the professional association, e.g. by sealing during mounting.

AZM 415-../..ZPKF

Unlocking: After opening the locking screw by means of the triangular key (available as accessory)
Reset: By closing the safety guard*

AZM 415-../..ZPKFE

Unlocking: Using triangular key (available as accessory)
Reset: By closing the safety guard*

AZM 415-../..XPKRS

Unlocking: Using key (included in delivery)
Reset: Using key



* In accordance with ISO 14119, a control measure is to be implemented to prevent the machine from running up when the guard system closes.

Emergency release

The emergency release enables a manual unlocking of the solenoid interlock from outside in a de-energised condition.

AZM 415-../..XPKNS

Unlocking: By actuating the lock button
Reset: Using key (included in delivery)



The emergency release should only be used in an emergency. The solenoid interlock should be installed and/or protected so that an inadvertent opening of the interlock by an emergency release can be prevented. The emergency release must be clearly labelled that it should only be used in an emergency. The label can be used that was included in the delivery.

Emergency exit

The emergency exit is used where an "inadvertently locked-in person" must leave a hazardous, already locked area. The actuating element must be installed so that an actuation from the escape side (hazardous area) is enabled.

AZM 415-../..ZPKT

Unlocking: By actuating the latched pushbutton
Reset: By pulling the latched pushbutton back

AZM 415-../..ZPKTE/TEI

Emergency exit Unlocking: By actuating the latched pushbutton
Reset: By pulling on the latched pushbutton

Manual release Unlocking: Using triangular key (available as accessory)
Reset: By turning the triangular key back



The user must evaluate and design the safety chain in accordance with the relevant standards and the required safety level.



The entire concept of the control system, in which the safety component is integrated, must be validated to the relevant standards.

2.4 Technical data

Standards:	IEC 60947-5-1, ISO 14119, BG-GS-ET-19
Enclosure:	light-alloy die-cast, enamel finish
Actuator and locking bolt:	zinc-plated metal / aluminium
Holding force F:	3,500 N
Latching force:	150 ... 400 N (adjustable)
Coding level according to ISO 14119:	low
Protection class:	IP67
- ordering suffix NS, RS:	IP54
Degree of pollution:	3
Contact material:	Silver
Contact types:	Change-over contact with double break, type Zb or 2 NC contacts, with galvanically separated contact bridges
Switching system:	⊖ IEC 60947-5-1; slow action, NC contact with positive break
Connection:	Screw terminals or M23 connector
Cable type:	rigid / flexible
Cable section:	min. 0.75 mm ² - max. 2.5 mm ² (including conductor ferrules)
Cable entry:	2 x M20 x 1.5
Rated impulse withstand voltage U _{imp} :	4 kV
Rated insulation voltage U _i :	250 V
Thermal test current I _{the} :	6 A
Utilisation category:	AC-15
Rated operating current/voltage I _e /U _e :	4 A / 230 VAC
Max. fuse rating:	6 A gG D-fuse
Required rated short-circuit current:	1,000 A
Positive break travel (unlocked):	5 mm
Positive break force (unlocked):	min. 15 N (depending on the setting of the ball latch)
Magnet switch-on time:	100 %
Rated control voltage U _s :	24 VAC/DC, 110 VAC, 50 / 60 Hz, 230 VAC, 50 / 60 Hz,
Power consumption:	max. 10 W
Actuating speed:	max. 0.2 ms
Max. actuating frequency:	2,000 s/h
Ambient temperature:	-25 °C ... + 50 °C
Mechanical life:	1 million operations

2.5 Safety classification of the interlocking function

Standards:	ISO 13849-1
Envisaged structure:	
- Basically:	applicable up to Cat. 1 / PL c
- With 2-channel usage and fault exclusion mechanism*:	applicable up to Cat. 3 / PL d with suitable logic unit
B _{10D} NC contact:	2,000,000
B _{10D} NO contact at 10% ohmic contact load:	1,000,000
Mission time:	20 years

* If a fault exclusion to the 1-channel mechanics is authorised.

$$MTTF_D = \frac{B_{10D}}{0,1 \times n_{op}} \quad n_{op} = \frac{d_{op} \times h_{op} \times 3600 \text{ s/h}}{t_{cycle}}$$

(Determined values can vary depending on the application-specific parameters h_{op}, d_{op} and t_{cycle} as well as the load.)

If multiple safety components are wired in series, the Performance Level to ISO 13849-1 will be reduced due to the restricted error detection under certain circumstances.

2.6 Safety classification of the guard locking function

If the device is used as an interlock for personal safety, a safety classification of the guard locking function is required. When classifying the interlock function, a distinction must be made between monitoring of the interlock function (locking function) and controlling the unlocking function. The following classification of the release function is based on the principle of isolating the supply of power to the solenoid.



The classification of the release function is only valid for devices with monitored guard locking function and in the power to unlock version (see ordering code).

By reliably isolating the power externally, it can be assumed that no errors can occur with regard to the locking device of the interlock. In that case, the locking device of the interlock does not contribute towards the failure probability of the release function. The level of safety of the release function relies, therefore, exclusively on reliable external deactivation of the power.

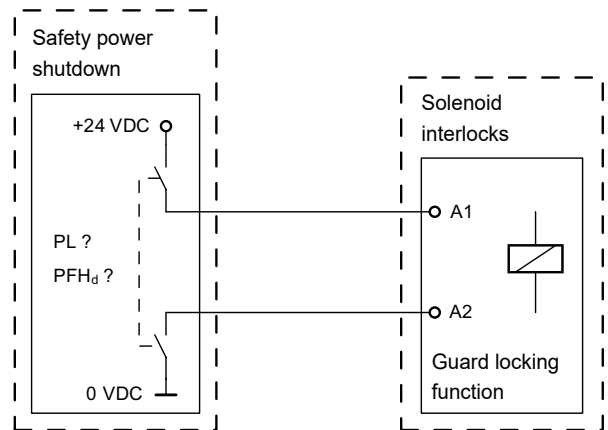

Fault exclusion with regard to wiring routing must be observed.



If for a certain application the power to unlock version of a solenoid interlock cannot be used, for this exception an interlock with power to lock can be used if additional safety measure need to be realised that have an equivalent safety level.

3. Mounting

3.1 General mounting instructions



Please observe the relevant requirements of the standards ISO 12100, ISO 14119 and ISO 14120.

Four mounting holes are provided for fitting the solenoid interlock. The solenoid interlock must not be used as an end stop. Any mounting position. The mounting position however must be chosen so that the ingress of dirt and soiling in the used opening is avoided. A smooth insertion of the actuator in the enclosure must be ensured.

Mounting of the actuator

See actuator mounting instructions.



The actuator must be permanently fitted to the safety guards and protected against displacement by suitable measures (tamperproof screws, gluing, drilling of the screw heads).

3.2 Dimensions

All measurements in mm.

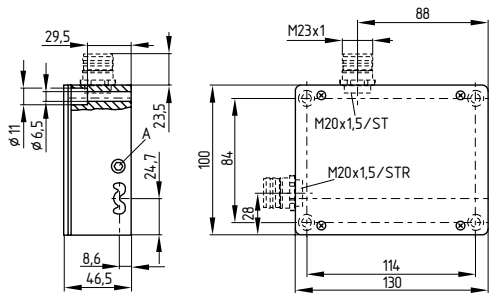

AZM 415-../..ZPKF

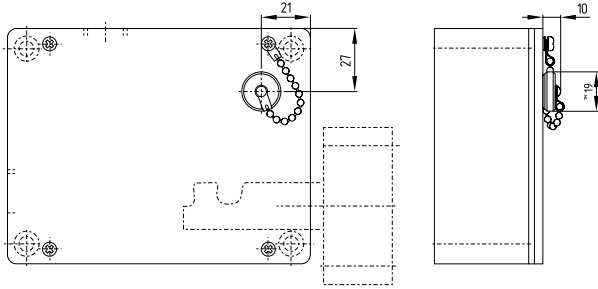

AZM 415-../..ZPKFE

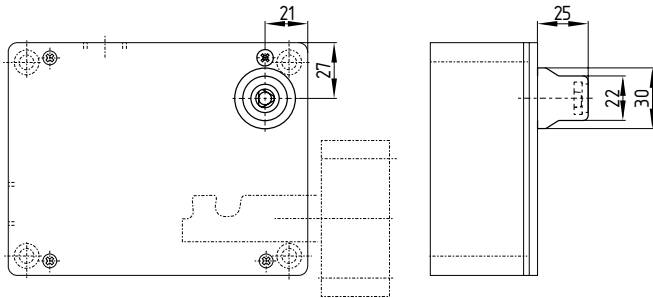

AZM 415-../..XPKRS

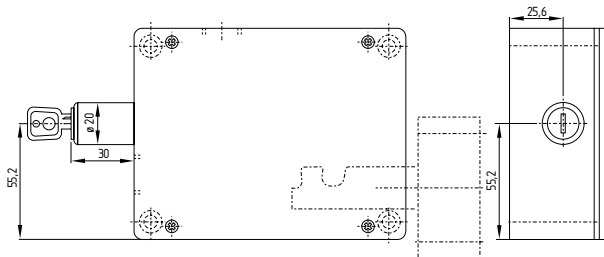

AZM 415-../..XPKNS

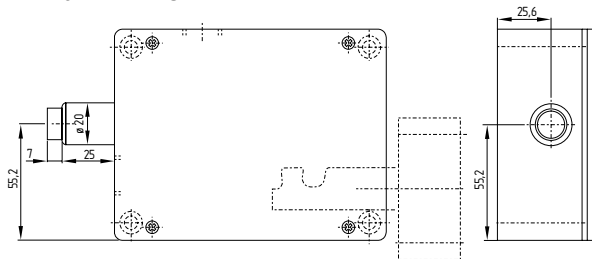

AZM 415-../..ZPKT

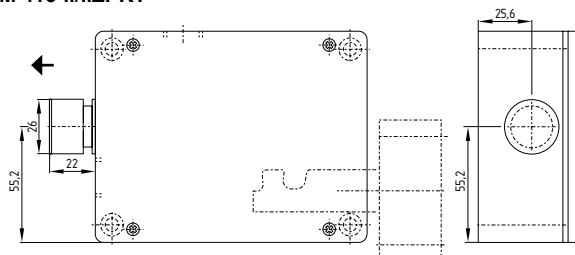

AZM 415-../..ZPKTE

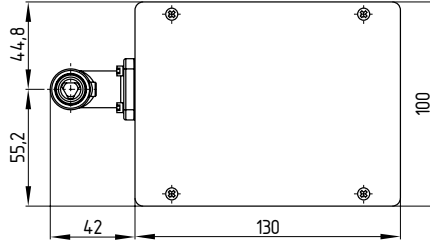

AZM 415-../..ZPKTEI

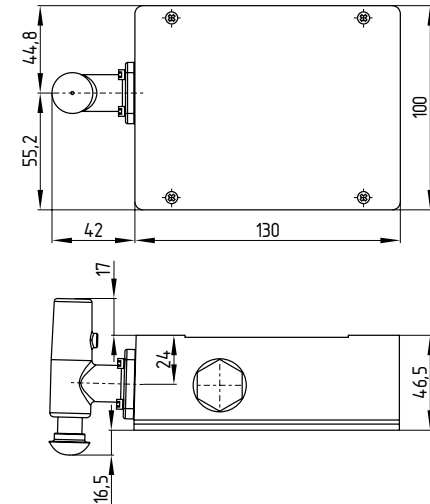

3.3 Adjustment

In the unlocked condition, the safety guard is kept in a closed condition by the adjustable ball latch. By rotating a hexagonal key wrench clockwise, the desired holding force can be increased; if the hexagonal key wrench is rotated counterclockwise, the holding force is decreased. The holding force must always be set as low as possible.

4. Electrical connection

4.1 General information for electrical connection



The electrical connection may only be carried out by authorised personnel in a de-energised condition.



If the risk analysis indicates the use of a monitored interlock they are to be connected in the safety circuit with the contacts indicated with the symbol

4.2 Connection and sealing

For the cable entry, suitable cable glands with an appropriate degree of protection must be used. Non-used openings must be sealed by means of threaded plugs. The switching compartment must be cleaned (removal of cable excess etc.); put back the cover after wiring and uniformly tighten the cover screws. Maximum tightening torque for the screws: cover $0.6 + 0.1$ Nm; bottom cover $0.7 + 0.1$ Nm.

4.3 Contact variants

Contacts shown in a de-energised condition and with the actuator inserted.

Power to unlock

Power to lock

AZM 415-11/11ZPK...

AZM 415-11/11ZPKA...

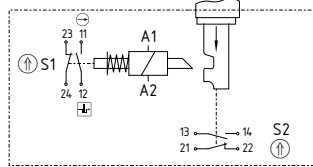
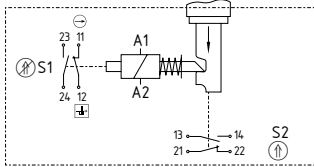

AZM 415-11/02ZPK...

AZM 415-11/02ZPKA...

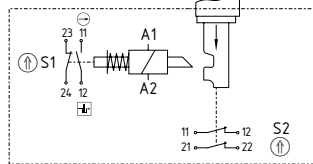
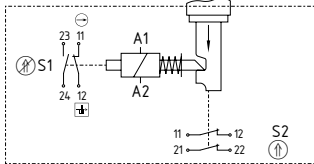

AZM 415-11/20ZPK...

AZM 415-11/20ZPKA...

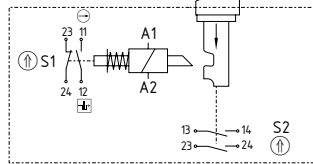
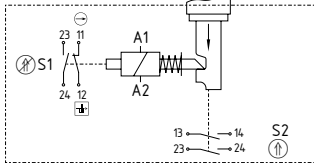

AZM 415-02/11ZPK...

AZM 415-02/11ZPKA...

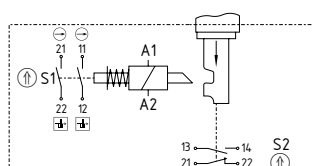
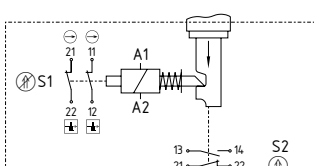

AZM 415-02/02ZPK...

AZM 415-02/02ZPKA...

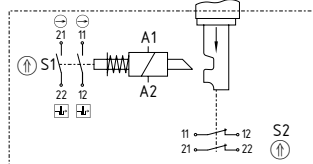
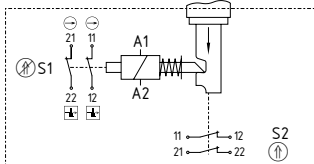

AZM 415-02/20ZPK...

AZM 415-02/20ZPKA...

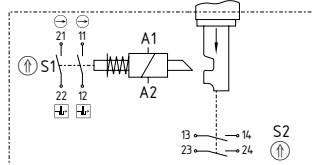
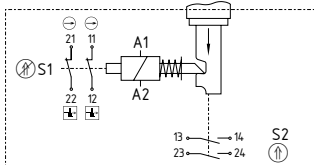

Key

- ⊖ positive break NC contact
- ⊕ Monitoring the interlock according to ISO 14119
- ⊕ Actuated
- ⊖ Not actuated

Table PIN configuration M23 ST and STR connector

PIN	Contact variant						
	11/11	11/02	11/20	02/11	02/02	02/20	
1	A1	A1	A1	A1	A1	A1	A1
2	A2	A2	A2	A2	A2	A2	A2
3	11	11	11	11	11	11	11
4	12	12	12	12	12	12	12
5	23	23	23	21	21	21	21
6	24	24	24	22	22	22	22
7	13	11	13	13	11	13	13
8	14	12	14	14	12	14	14
9	21	21	23	21	21	23	23
10	22	22	24	22	22	24	24
11	-	-	-	-	-	-	-
12	GND	GND	GND	GND	GND	GND	GND



Comparison of the old and new contact configurations in appendix.

5. Set-up and maintenance

5.1 Functional testing

The safety function of the safety components must be tested. The following conditions must be previously checked and met:

1. Fitting of the solenoid interlock and the actuator
2. Check the integrity of the cable entry and connections
3. Check the switch enclosure for damage

5.2 Maintenance

By use in extreme conditions, we recommend routine maintenance including the following steps:

1. Check for correct installation of the solenoid interlock and the actuator
2. Remove particles of dust and soiling
3. Check cable entry and connections



Adequate measures must be taken to ensure protection against tampering either to prevent tampering of the safety guard, for instance by means of replacement actuators.

Damaged or defective components must be replaced.

6. Disassembly and disposal

6.1 Disassembly

The safety switchgear must be disassembled in a de-energised condition only.

6.2 Disposal

The safety switchgear must be disposed of in an appropriate manner in accordance with the national prescriptions and legislations.

7. EU Declaration of conformity

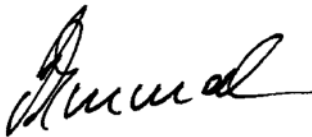
EU Declaration of conformity		
Original	K.A. Schmersal GmbH & Co. KG Möddinghofe 30 42279 Wuppertal Germany Internet: www.schmersal.com	
We hereby certify that the hereafter described components both in their basic design and construction conform to the applicable European Directives.		
Name of the component:	AZM 415	
Type:	See ordering code	
Description of the component:	Interlocking device with electromagnetic interlock for safety functions	
Relevant Directives:	Machinery Directive RoHS-Directive	2006/42/EC 2011/65/EU
Applied standards:	DIN EN 60947-5-1:2010 DIN EN ISO 14119:2014	
Person authorised for the compilation of the technical documentation:	Oliver Wacker Möddinghofe 30 42279 Wuppertal	
Place and date of issue:	Wuppertal, March 7, 2016	
		
	Authorised signature Philip Schmersal Managing Director	

AZM415-D-EN



The currently valid declaration of conformity can be downloaded from the internet at www.schmersal.net.



X-ON Electronics

Largest Supplier of Electrical and Electronic Components

Click to view similar products for [Emergency Stop Switches / E-Stop Switches](#) category:

Click to view products by [Schmersal](#) manufacturer:

Other Similar products are found below :

[84-6830.0020](#) [AVN302N-R](#) [3050.1302Y](#) [84-6841.2B20](#) [951FY000-WO](#) [ER6022-022N](#) [952+2000-00](#) [ES3S51653001](#) [601+0000-OP](#) [750111](#)
[XCSB502](#) [2TLA030051R0100](#) [D2D 1009M](#) [D2D 1013H](#) [84-6820.0040](#) [FB1W-HW1B-M220B](#) [FB1W-HW1B-X401R](#) [84-5221.2B20](#) [AZ](#)
[17/170-B15](#) [AZ 17/170-B11](#) [BNS 40S-12Z 10,0M](#) [SK-UV15Z M](#) [W0-63.10.00A](#) [SP22K201-1](#) [SP22K101-1](#) [SP22K105-1](#) [SP22K108-1](#)
[ST22K101-1](#) [ST22K104-1](#) [ST22K105-1](#) [ST22K108-1](#) [ST22K201-1](#) [ST22K302-1](#) [ST22K305-1](#) [3004.5246](#) [3031.1306](#) [3050.1303N](#)
[30B4.1206](#) [3100.0110N](#) [440A-A17101](#) [440E-A13078](#) [440E-A13081](#) [440G-A27011](#) [440G-S36001](#) [440G-T27127](#) [440K-A27010](#) [440K-](#)
[E33014](#) [440K-T11090](#) [440K-T11467](#) [506406](#)