

# PowerPact B-Frame 15 to 125 A Circuit Breakers

## Catalog

01/2017



# Legal Information

The Schneider Electric brand and any registered trademarks of Schneider Electric Industries SAS referred to in this guide are the sole property of Schneider Electric SA and its subsidiaries. They may not be used for any purpose without the owner's permission, given in writing. This guide and its content are protected, within the meaning of the French intellectual property code (Code de la propriété intellectuelle français, referred to hereafter as "the Code"), under the laws of copyright covering texts, drawings and models, as well as by trademark law. You agree not to reproduce, other than for your own personal, noncommercial use as defined in the Code, all or part of this guide on any medium whatsoever without Schneider Electric's permission, given in writing. You also agree not to establish any hypertext links to this guide or its content. Schneider Electric does not grant any right or license for the personal and noncommercial use of the guide or its content, except for a non-exclusive license to consult it on an "as is" basis, at your own risk. All other rights are reserved.

Electrical equipment should be installed, operated, serviced, and maintained only by qualified personnel. No responsibility is assumed by Schneider Electric for any consequences arising out of the use of this material.

As standards, specifications, and designs change from time to time, please ask for confirmation of the information given in this publication.

Schneider Electric, EverLink, Green Premium, I-Line, Micrologic, PowerPact and Square D are trademarks and the property of Schneider Electric SE, its subsidiaries and affiliated companies. All other trademarks are the property of their respective owners.

# Green Premium



## Green Premium™

Endorsing the most eco-friendly products in the industry



Green Premium is the only label that allows you to effectively develop and promote an environmental policy whilst preserving your business efficiency. This ecolabel guarantees compliance with the most up-to-date environmental regulations, but it does more than this.

Over 75% of Schneider Electric manufactured products have been awarded the Green Premium ecolabel



Discover what we mean by green ....

**Check your products!**

Schneider Electric's Green Premium ecolabel is committed to offering transparency, by disclosing extensive and reliable information related to the environmental impact of its products:

### RoHS

Schneider Electric products are subject to RoHS requirements at a worldwide level, even for the many products that are not required to comply with the terms of the regulation. Compliance certificates are available for products that fulfil the criteria of this European initiative, which aims to eliminate hazardous substances.

### REACH

Schneider Electric applies the strict REACH regulation on its products at a worldwide level, and discloses extensive information concerning the presence of SVHC (Substances of Very High Concern) in all of these products.

### PEP: Product Environmental Profile

Schneider Electric publishes the most complete set of environmental data, including carbon footprint and energy consumption data for each of the lifecycle phases on all of its products, in compliance with the ISO 14025 PEP ecopassport program. PEP is especially useful for monitoring, controlling, saving energy, and/or reducing carbon emissions.

### EOI: End of Life Instructions

Available at the click of a button, these instructions provide:

Recyclability rates for Schneider Electric products.

Guidance to mitigate personnel hazards during the dismantling of products and before recycling operations.

Parts identification for recycling or for selective treatment, to mitigate environmental hazards/incompatibility with standard recycling processes.



# Table of Contents

Introduction.....	9
Characteristics.....	9
Introduction.....	9
Dual-Break Rotating Contacts.....	9
Reduced Let-Through Currents.....	10
Internal Operating Mechanism.....	10
Handle Position Indication.....	10
Characteristics Indicated on the Faceplate Label.....	11
Codes and Standards.....	11
Circuit Breaker Applications.....	12
Performance and Ratings.....	13
PowerPact B-Frame Circuit Breakers.....	13
Circuit Breaker Ratings.....	13
Reverse Feeding of Circuit Breakers.....	13
Special Ratings.....	14
400 Hz Applications.....	15
Circuit Breaker Specifications.....	16
Automatic Molded Case Switch Specifications.....	18
Automatic Switch Functions.....	18
Automatic Switch Protection.....	18
Automatic Molded Case Switch Specifications.....	19
Trip Units.....	20
Circuit Breaker Mounting Positions.....	20
Catalog Numbering.....	21
I-Line Circuit Breakers.....	22
Trip Unit Options.....	22
Terminations.....	23
Accessories and Auxiliaries.....	24
Accessory Overview.....	24
Accessory Compatibility.....	25
Power Connections.....	26
Multiple Types of Power Connections.....	26
EverLink Lug Connector.....	26
Terminal Nut Connectors.....	28
Mechanical Lug Kits.....	30
Torque-Limiting Breakaway Bits.....	30
Insulation of Live Parts.....	31
Long Terminal Shields (IP40).....	31
Interphase Barriers.....	31
Rear Insulating Screens.....	31
Insulation Accessories.....	32
Insulation of Connectors.....	33
Selection of Electrical Auxiliaries.....	34
Electrical Auxiliaries.....	34
Electrical Accessory Connections.....	35

Auxiliary and Alarm Indication Contacts .....	36
Shunt Trip (MX) and Undervoltage Release (MN) .....	38
Shunt Trip (MX) .....	39
Undervoltage Release (MN) .....	40
Time Delay Unit for Undervoltage Release .....	41
Rotary Handles .....	42
Class 9421 Type L Door-Mounted Rotary Operators .....	42
Class 9422 Cable Operating Mechanism .....	43
Class 9422 Flange-Mounted Variable-Depth Operating Mechanism .....	44
Direct Rotary Handles .....	45
Extended Rotary Handles .....	46
Side Rotary Handles .....	48
Locks and Sealing Accessories .....	50
Locks .....	50
Interlocking of Circuit Breakers with Toggle Control .....	50
Manual Mechanical Interlocking System .....	51
Sealing Accessories .....	52
Operating and Installation Conditions .....	53
Environmental Conditions .....	53
Shunt Trip (MX) and Undervoltage Release (MN) Wiring Rules .....	55
Temperature Considerations .....	56
Correction Factor .....	56
Calculating Tripping Time .....	57
Installation and Operating Conditions .....	58
Installation in Equipment .....	59
Safety Clearances and Minimum Distances .....	59
B-frame Safety Clearance, UL Standard .....	60
B-Frame Safety Clearance, IEC Standard .....	61
Circuit Breaker Enclosures, Enclosure Accessories (Available Late 2017) .....	62
Dimensions .....	63
Circuit Breaker Dimensions .....	63
Connector Dimensions .....	64
Terminal Shield Dimensions .....	66
Interphase Barrier Dimensions .....	67
Insulation Screen Dimensions .....	68
Backplate Dimensions .....	69
DIN Rail Dimensions .....	70
Direct Rotary Handle Dimensions .....	71
Extended Rotary Handle .....	72
Side Rotary Handle Dimensions .....	73
Door-Mounted Operating Mechanism .....	74
NEMA 9422 Cable-Operating Mechanism .....	75
NEMA 9422 Variable Depth Operating Mechanism .....	76
Wiring Diagrams .....	77
Indication Contacts .....	77
Remote Operation (MN/MX Voltage Release) .....	77

---

Let-Through Curves and Trip Curves .....	78
PowerPact B-Frame Let-Through Energy Curve .....	78
PowerPact B-Frame Peak Let-Through Current Curve .....	79
PowerPact B-Frame 15/20 A Thermal-Magnetic Trip .....	80
PowerPact B-Frame 25/30 A Thermal-Magnetic Trip .....	81
PowerPact B-Frame 35/50 A Thermal-Magnetic Trip .....	82
PowerPact B-Frame 60/100 A Thermal-Magnetic Trip .....	83
PowerPact B-Frame 110/125 A Thermal-Magnetic Trip .....	84
Distribution System .....	85
Busbar Information .....	85
Catalog Numbers .....	87
PowerPact B-Frame Circuit Breaker Catalog Numbers .....	87
PowerPact B-Frame 1P Unit-Mount Single Phase Circuit Breakers .....	87
PowerPact B-Frame 1P I-Line Single Phase Circuit Breakers .....	89
PowerPact B-Frame 2P Unit-Mount Circuit Breakers .....	90
PowerPact B-Frame 2P I-Line Circuit Breakers .....	91
PowerPact B-Frame 3P Unit-Mount Circuit Breakers .....	92
PowerPact B-Frame 3P I-Line Circuit Breakers .....	93
PowerPact B-Frame 4P Unit-Mount Circuit Breakers .....	93
PowerPact B-Frame Switches .....	94
Electrical Accessories .....	95
Connection Accessories .....	97
Insulation Accessories Catalog Numbers .....	98
Rotary Handle Catalog Numbers .....	99
Locking and Sealing Accessories Catalog Numbers .....	101
Adapter/Conversion Kits .....	101
Spare Parts .....	102





# Introduction

## Characteristics

### Introduction



- The PowerPact B-frame circuit breakers are designed and certified to multiple standards in order to meet the needs of customers who have global designs or build and sell in regions with various standards. One product can be used and sourced globally.
- B-frame circuit breakers have the smallest footprint in the PowerPact family of industrial molded case circuit breaker products from Square D™ by Schneider Electric™.
- PowerPact B-frame circuit breakers are designed to protect electrical systems from damage caused by overloads and short circuits. They are available with thermal-magnetic trip units from 15 to 125 A, with a breaking capacity up to 65 kA at 480 Vac.
- The B-frame circuit breakers are offered in 1, 2, and 3-pole versions in both I-Line and unit-mount constructions. There is also a 4-pole version, offered in unit mount construction only, with a 100% protected neutral located in the far left pole. It is used in countries where the neutral is also switched (not typical for USA domestic applications).
- The B-frame product offers a flexible platform in which customer needs for various types of mounting and terminations can be accommodated with simple alterations of the base product. Field installable features and termination variety empower the customer to configure the product to their exact needs for control panel or power panel applications.
- B-frame circuit breakers with thermal-magnetic trip units contain individual thermal (overload) and instantaneous (short circuit) sensing elements in each pole. The amperage ratings of the thermal trip units are calibrated at 40°C (104°F) free air ambient temperature. Per the National Electric Code® (NEC®) and the Canadian Electrical Code, standard circuit breakers may only be applied continuously at up to 80% of their rating.

### Dual-Break Rotating Contacts



All PowerPact B-frame circuit breakers are equipped with dual-break rotating contacts that reduce the amount of peak current during a short circuit fault. This reduces the let-through currents and enhances equipment protection.

## Reduced Let-Through Currents

The moving contact has the shape of an elongated “S” and rotates around a floating axis. The shape of the fixed and moving contacts are such that the repelling forces appear as soon as the circuit reaches approximately 15 times nominal current rating ( $I_n$ ).

Due to the rotating movement, repulsion is rapid and the device greatly limits short-circuit currents, whatever the interrupting level of the unit. The fault current is extinguished before it can fully develop. Lower let-through currents provide less peak energy, reducing the required bus bar bracing, lowering enclosure pressure, and delivering improved series or combination ratings.

For let-through energy values, see *PowerPact B-Frame Let-Through Energy Curve*, page 78.

For peak let-through current values, see *PowerPact B-Frame Peak Let-Through Curve*, page 79.

## Internal Operating Mechanism

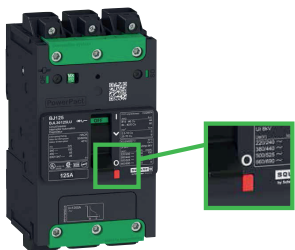

PowerPact B-frame circuit breakers have an over-center toggle mechanism providing quick-make, quick-break operation. The operating mechanism is also trip-free, which allows tripping even when the circuit breaker handle is held in the “ON” position.

Internal cross-bars provide common opening and closing of all poles with a single “ON” position.

All PowerPact circuit breakers have an integral push-to-trip button in the cover to manually trip the circuit breaker. This should be used as part of a regular preventive maintenance program.

## Handle Position Indication

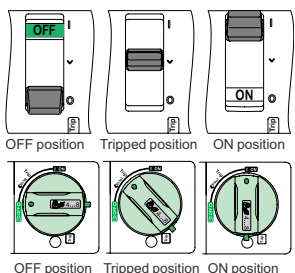

The circuit breaker handle can assume any of three positions: ON, tripped or OFF.

The tripped position provides positive visual indication that the circuit breaker has tripped.

The circuit breaker can be reset by first pushing the handle to the extreme “OFF” position. Power can then be restored to the load by pushing the handle to the “ON” position.

## Characteristics Indicated on the Faceplate Label

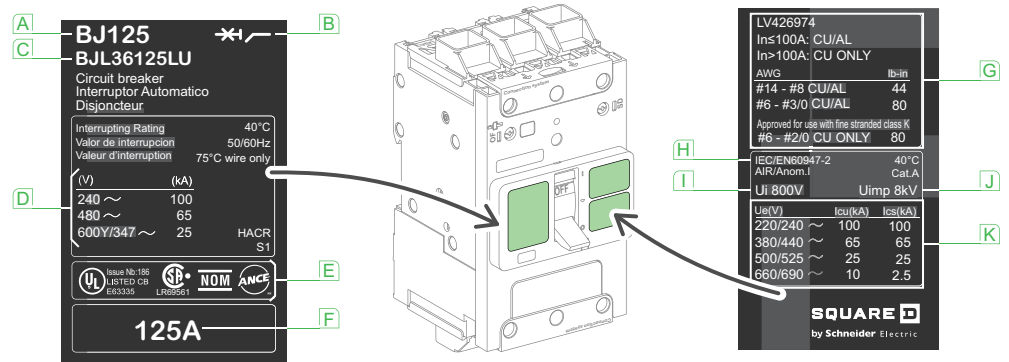

- A** — Circuit breaker type
- B** — Circuit breaker symbol
- C** — Commercial reference
- D** — UL interrupting rating
- E** — Certification marks
- F** — Circuit breaker rating
- G** — Termination characteristics
- H** — Reference standard
- I** —  $U_i$ : rated insulation voltage
- J** —  $U_{imp}$ : rated impulse withstand voltage
- K** — IEC interrupting ratings:
  - $I_{cu}$ : ultimate breaking capacity,
  - $I_{cs}$ : service breaking capacity, depending on the operating voltage  $U_e$ .

## Codes and Standards

B-frame circuit breakers are manufactured and tested in accordance with the following standards.

**NOTE:** Apply circuit breakers according to guidelines detailed in the National Electric Code (NEC) and other local wiring codes.

### PowerPact B-frame Circuit Breaker Standards and Certification Marks

UL 489 <sup>1</sup>	IEC/EN 60947-5-1	CE Marking
CSA C22.2 No. 5 <sup>2</sup>	GB 14048-2	EAC
NMX J-266	CCC	
IEC/EN 60947-2	NOM	

### Marine Type Approval Certification

PowerPact B-frame circuit breakers comply with most marine classification companies specifications:

- American Bureau of Shipping (ABS)
- Bureau Veritas (BV)
- China Classification Society (CCS)
- Det Norske Veritas / Germanischer Lloyd (DNV / GL)
- Korean register of Shipping (KROS)
- Lloyds Register of Shipping (LRoS)
- Nippon Kaiji Kyokai (NK)
- Registro Italia Navale (RINA)
- Russian Maritime Register of Shipping (RMROS).

1. PowerPact B-frame circuit breakers are in UL File E63335.

2. PowerPact B-frame circuit breakers are in CSA File 177007.

## Circuit Breaker Applications



PowerPact B-Frame 3P  
Circuit Breaker

### Industrial Control Panels

PowerPact B-frame circuit breakers are used for various circuit protection and switching functions in industrial control panels.

They serve as an incoming main circuit breaker and control panel disconnect, as branch circuit protective devices for final loads, or as feeder circuit protective devices (often combined with motor starters).

- Suitable for use in UL508 Industrial Control Equipment.
- In compliance with worldwide product standards including UL 489 / CSA C22.2 N° 5 and IEC 60947-2.
- Provide overload and short-circuit protection.
- For installation in universal and process-specific type enclosures.

Many PowerPact B-frame circuit breaker mechanical and electrical accessories are designed specifically for industrial control panel applications.

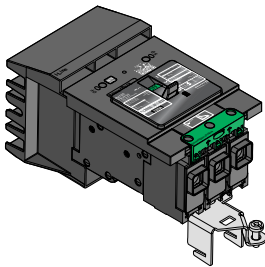

PowerPact B-Frame 3P  
I-Line Circuit Breaker

### Electrical Distribution

PowerPact B-frame circuit breakers are also used in electrical distribution for building applications. They can be used as incoming main circuit breakers but are more commonly applied in North American distribution equipment for outgoing feeder and branch circuit protection.

PowerPact B-frame unit-mount circuit breakers are both back-pan and DIN-rail mountable, compatible with all kinds of enclosures.

PowerPact B-frame circuit breakers are available with the unique I-Line™ plug-on connections. These group-mounted circuit breakers are featured in Square D brand Power-Style™ Switchboards and I-Line Panelboards.

A variety of PowerPact B-frame circuit breaker accessories are also well suited for electrical distribution applications.

## Performance and Ratings

### PowerPact B-Frame Circuit Breakers



### Circuit Breaker Ratings

The interrupting rating is the highest current at rated voltage the circuit breaker is designed to safely interrupt under standard test conditions. Circuit breakers must be selected with interrupting ratings equal to or greater than the available short-circuit current at the point where the circuit breaker is applied to the system (unless it is a branch device in a series rated combination). Interrupting ratings are shown on the front of the circuit breaker.

### Reverse Feeding of Circuit Breakers

The standard unit-mount and I-Line circuit breakers have sealed trip units and may be reverse fed.

## Special Ratings

The B-frame circuit breaker complies with the following special ratings:

- HACR rating
- SWD switch duty rating  
(applies only to 15 A and 20 A; 347 Vac or less; 1P, 2P and 3P)
- HID high intensity discharge lighting rating  
(15–30 A; 347 Vac or less; 1P, 2P and 3P)
- Automatic Molded case Switches are rated 600 Vac Delta (refer to switch table 125 A *PowerPact B-Frame Switches*, page 19)
- 100% Ratings (Optional)

B-frame 15–60 A circuit breakers are UL Listed/CSA Certified to be applied at up to 100% of their current rating. Because of the additional heat generated, the use of specially-designed enclosure and 194°F (90°C) rated wire is required when applying circuit breakers at 100% of continuous current rating. Markings on the circuit breaker indicate the minimum enclosure size and ventilation required. The 194°F (90°C) rated wire must be sized according to the ampacities of the 165°F (75°C) wire column in the NEC. Circuit breakers with 100% rating can also be used in applications requiring only standard (80%) continuous loading.

- Grounded B-Phase Systems (Corner-Grounded Delta)

Circuit breakers suitable for 240 Vac corner-grounded circuits are marked Ø1-Ø3.

### Three-Phase 240 Vac Corner-Grounded Delta System.

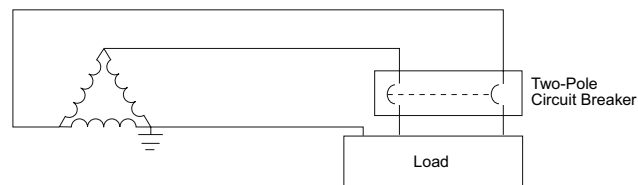

### 2P Frame

	BD	BG	BJ
Ampere Rating (A)	15–125		
Voltage Rating (Vac)	240		
UL Interrupting Rating (kA)	18	35	65

## 400 Hz Applications

### Impact on Protective Devices

The current in 400 Hz systems have higher losses caused by eddy currents and an increase in the skin effect (reduction in the useful cross-sectional area of conductors). The higher losses cause additional temperature rise in circuit breakers subjected to the higher frequency current. To remain within the rated temperature-rise limits of devices, current derating is required. On circuit breakers equipped with thermal-magnetic trip units, the current rating ( $I_n$ ) must be derated and the magnetic trip setting  $I_m$  must be increased.

**NOTE:** The following derating information pertains to 3Ø applications. For 1Ø applications, please contact Schneider Electric for additional information.

### Breaking Capacity in 400 Hz, 480 V Systems

The power levels of 400 Hz applications rarely exceed a few hundred kW with relatively low short circuit currents, generally not exceeding four times the rated current.

Circuit Breaker	Max. Breaking Capacity AIR at 400 Hz
B-frame	10 kA

### Thermal-Magnetic Trip Units

Thermal-magnetic trip units require the current rating ( $I_n$ ) to be derated and the magnetic trip setting ( $I_m$ ) to be increased.

### Current Rating ( $I_n$ ) and Magnetic Trip Setting ( $I_m$ ) Rerating

Circuit Breaker	Maximum Setting Coefficient	Max Ir Setting at 400 Hz	Magnetic $I_m$ Coefficient at 400 Hz
B-Frame, 125 A	0.9	112	1.6

### Shunt Trip (MX) or Undervoltage Trip (MN) Voltage Release at 400 Hz and 440 V

Undervoltage releases (MN) rated 24 Vac/dc, 48 Vac/dc, or 110/130 Vac/dc are 400 Hz compliant with their nominal voltages. For voltages greater than 110/130 Vac/dc, please contact Schneider Electric for additional information.

For all voltages of shunt trips (MX), please contact Schneider Electric for additional information.

## Circuit Breaker Specifications

Circuit breaker type	BD		BG		BJ		BK	
Number of poles	1	2-4	1	2-4	1	2-4	1	2
Amperage range (A)	15–125	15–125	15–125	15–125	15–125	15–125	15–30	15–30

### UL 489 circuit breaker ratings—50/60 Hz

UL/CSA/NOM (kA rms)	208Y/120 Vac	25	25	65	65	100	100	100	100
	240 Vac	25	25	65	65	100	100	100	100
	480Y/277 Vac	18	18	35	35	65	65	65	65
	480 Vac	—	18	—	35	—	65	—	65
	600Y/347 Vac	14	14	18	18	25	25	65	65

### IEC/EN 60947-2 circuit breaker ratings—50/60 Hz

Ultimate breaking capacity (Icu) (kA rms)	220–240 Vac	25	25	65	65	65	100	—	—
	30–415 Vac	—	18	—	35	—	65	—	—
	440 Vac	—	18	—	35	—	65	—	—
	500–525 Vac	—	14	—	18	—	25	—	—
	690 Vac	—	—	—	—	—	10	—	—
Service breaking capacity (Ics) (kA rms)	220–240 Vac	25	25	65	65	65	100	—	—
	380–415 Vac	—	18	—	35	—	65	—	—
	440 Vac	—	18	—	35	—	65	—	—
	500–525 Vac	—	14	—	18	—	25	—	—
	690 Vac	—	—	—	—	—	2.5	—	—
Rated insulation voltage	Ui	800 V							
Rated impulse withstand voltage	Uimp	8 kV							
Rated operational voltage (V)	Ue	240	525	240	525	240	690	—	—
Rated current (A)	In (40 °C)	15–125							
Utilization category	A								
Suitability for isolation	Yes								
Pollution degree	3								

### Durability operations (Open-Close cycles)

Mechanical durability <sup>3</sup>	15000								
Electrical durability <sup>3</sup>	240 Vac–In (1P)	10000							
	440 Vac–In (2P/3P/4P)	10000							

### Protection

Overload/short-circuit protection	Thermal-Magnetic	X							
-----------------------------------	------------------	---	--	--	--	--	--	--	--

**Dimensions/ Weight** See *PowerPact B-Frame Circuit Breaker Physical Properties*, page 17

### Connections

Connections / Terminations	I-Line™ Connection	X							
	EverLink™ Lug	X							
	Terminal Nut	X							
	Mechanical Lugs	X							

3. Durability (C-O cycles) as per IEC947–1 annex K.



**PowerPact B-Frame Circuit Breaker Physical Properties**

Property		Unit Mount Circuit Breaker				I-Line Circuit Breaker		
		1P	2P	3P	4P	1P	2P	3P
Dimensions mm (in.)	Height	137 (5.39)	137 (5.39)	137 (5.39)	137 (5.39)	246.5 (9.70)	246.5 (9.70)	246.5 (9.70)
	Width	27 (1.06)	54 (2.12)	81 (3.19)	108 (4.25)	37.6 (1.48)	75.6 (2.98)	113.8 (4.48)
	Depth	80 (3.15)	80 (3.15)	80 (3.15)	80 (3.15)	131.3 (5.17)	131.3 (5.17)	131.3 (5.17)
Product Weight		455 g (1.0 lbs)	810 g (1.8 lbs)	1140 g (2.5 lbs)	1487 g (3.3 lbs)	560 g (1.2 lbs)	1020 g (2.3 lbs)	1400 g (3.1 lbs)

## Automatic Molded Case Switch Specifications

### Automatic Switch Functions

An automatic switch can be used to open and close a circuit breaker under normal operating conditions. They are similar in construction to circuit breakers, except that the switches open instantaneously at a factory-set, non-adjustable trip point calibrated to protect only the molded case switch.

Molded case switches are intended for use as a disconnect device only. UL489 requires molded case switches to be protected by a circuit breaker or fuse of equivalent rating. Molded case switches are labeled with their appropriate withstand ratings. The withstand rating of a switch is defined as the maximum current at rated voltage that the molded case switch will withstand without damage when protected by a circuit breaker with an equal continuous current rating.

PowerPact B-frame automatic switches are available in unit mount versions. They use the same accessories and offer the same connection possibilities as the circuit breaker versions.

Switches are Listed under UL file E103740 and Certified under CSA file LR88980.

### Automatic Switch Protection

The automatic switch can make and break its rated current. For an overload or a short circuit, it must be protected by an upstream device, in compliance with installation standards. Due to their high-set instantaneous release, PowerPact B-frame automatic switches are self-protected.

## Automatic Molded Case Switch Specifications

Switch type		BD	BG	BJ
Number of poles		2-3	2-3	2-3
Amperage (A)		125	125	125
<b>UL489 automatic switch withstand ratings - 60 Hz</b>				
UL/CSA (kA rms)	208Y/120 Vac	25	65	100
	240 Vac	25	65	100
	480Y/277 Vac	18	35	65
	480 Vac	18	35	65
	600 Vac	14	18	25
<b>Durability operations (Open-Close cycles)</b>				
Mechanical durability <sup>4</sup>		15000		
Electrical durability <sup>4</sup>		440 Vac- In (2P/3P) 10000		
<b>Dimensions / Weight / Connections</b>				
Dimensions (H x W x D) mm (in.)	2P Unit Mount	137 x 54 x 80 (5.39 x 2.12 x 3.15)		
	3P Unit Mount	137 x 81 x 80 ( 5.39 x 3.19 x 3.15)		
Product Weight — kg (lb.)	2P Unit Mount	0.77 (1.7)		
	3P Unit Mount	1.07 (2.4)		
Connections / Terminations	EverLink™ Lug	X		
	Terminal Nut	X		
	Mechanical Lugs	X		

4. Durability (C-O cycles) as per IEC947-1 annex K.

## Trip Units

PowerPact B-frame circuit breakers offers a fixed, factory-sealed thermal-magnetic trip unit designed to open automatically under overload or short circuit conditions.

B-frame thermal-magnetic circuit breakers contain individual thermal (overload) and instantaneous (short circuit) sensing elements in each pole.

### Thermal-Magnetic Trip Units

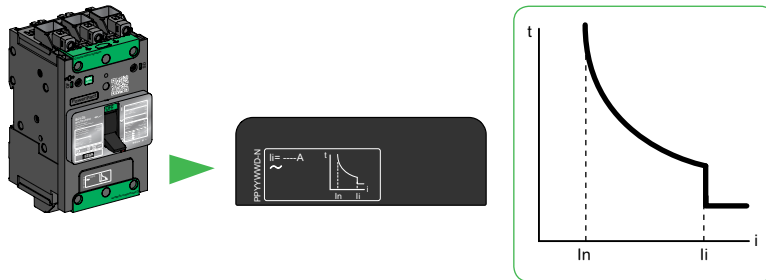

**B-Frame Trip Curve**

(In) Fixed threshold thermal protection against overload.

(Ii) Fixed threshold instantaneous protection against short-circuits.

### Magnetic Trip Level

ii	Rated Current (A)															
	15	20	25	30	35	40	45	50	60	70	80	90	100	110	125	
<b>Hold (A)</b>	400	400	400	400	400	400	400	480	640	640	800	1000	1000	1000	1000	
<b>Trip (A)</b>	600	600	600	600	600	600	600	720	960	960	1200	1500	1500	1500	1500	

## Circuit Breaker Mounting Positions

B-frame circuit breakers may be mounted vertically, horizontally, flat on their back or on their side without any derating of characteristics. These circuit breakers can be mounted on a 35 mm wide x 15 mm deep DIN rail using the integrated DIN rail mounting feature.

For backplate mounting, the circuit breakers are supplied with two mounting screws (M4), washers and nuts. These mounting screws can be inserted through mounting holes molded into the circuit breaker case and threaded into the mounting enclosure, backplate, or rails.

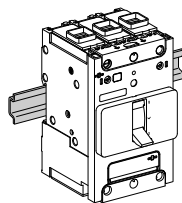

Mounting on DIN rail.

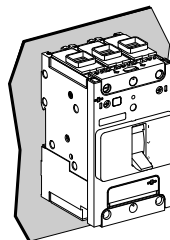

Mounting on backplate  
(Two mounting screws)

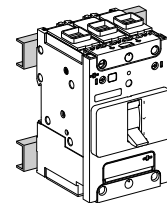

Mounting on rails  
(Two mounting screws)

## Catalog Numbering

Segment	Character	Description	B	J	L	3	6	125	C	6	LU	T
Frame	B	B-Frame										
Performance Levels (kA)	D	25 kA @ 240 Vac 18 kA @ 480 Vac 14 kA @ 600Y/347 Vac										
	G	65 kA @ 240 Vac 35 kA @ 480 Vac 18 kA @ 600Y/347 Vac										
	J	100 kA @ 240 Vac 65 kA @ 480 Vac 25 kA @ 600Y/347 Vac										
	K	100 kA @ 240 Vac 65 kA @ 480 Vac 65 kA @ 600Y/347 Vac										
Terminations	A	I-Line ON end, AI mechanical lug OFF end										
	F	Terminal Nut both ends										
	L	EverLink lugs both ends										
	M	EverLink ON end, terminal nut OFF end										
	P	EverLink OFF end, terminal nut ON end										
Number of poles	1	1 pole										
	2	2 pole										
	3	3 pole										
	4	4 pole										
Voltage	4	480Y/277 Vac (I-Line only)										
	6	600Y/347 Vac (480, 240 Vac delta)										
Current	000	Molded Case Switch (also requires S12 suffix)										
	015	15 A										
	020	20 A										
	025	25 A										
	030	30 A										
	035	35 A										
	040	40 A										
	045	45 A										
	050	50 A										
	060	60 A										
	070	70 A										
	080	80 A										
	090	90 A										
	100	100 A										
110	110 A											
125	125 A											
Trip Unit Options	See <i>Trip Unit Options</i> , page 22 for available options.											
I-Line Phasing	See <i>Phase Options</i> , page 22											
Connector type	See <i>Lug Options</i> , page 23 for available options											
Factory-Installed Accessories	See <i>Accessories Overview</i> , page 24.											

## I-Line Circuit Breakers

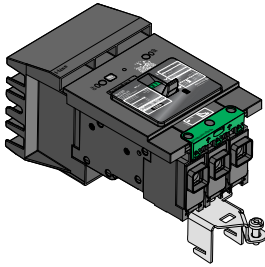

B-Frame 3P I-Line Circuit Breaker

PowerPact B-frame circuit breakers are available in I-Line construction for easy installation and removal in I-Line panelboard and switchboard applications.

I-Line circuit breakers use “blow-on” type line side connectors. In case of a short circuit, increased magnetic flux causes the plug-on connectors of the circuit breaker to tighten their grasp on the busbars.

The I-Line connectors and circuit breaker mounting bracket are integral parts of I-Line circuit breakers and cannot be removed or replaced.

I-Line circuit breakers come with aluminum mechanical load-side lugs, or optional copper mechanical lugs, EverLink™ lugs with control wire terminals, or terminal nuts to connect to bus bars or to compression (crimp) lugs.

### Phase Option Examples

Phase Option Number	Phase Connection	One-Pole Example	Two-Pole Example	Three-Pole Example
1	A	BJA161251	—	—
3	B	BJA161253	—	—
5	C	BJA161255	—	—
1	AB	—	BJA261251	—
2	AC	—	BJA261252	—
3	BA	—	BJA261253	—
4	BC	—	BJA261254	—
5	CA	—	BJA261255	—
6	CB	—	BJA261256	—
blank	ABC	—	—	BJA36125
6	CBA	—	—	BJA361256

## Trip Unit Options

### Trip Unit Options

Trip Unit Option	Description
blank	80% Rated
C	100% Rated
Y	480Y/277 Vac Rated Maximum
S12	Automatic Molded Case Switch

## Terminations

B-frame circuit breakers are available in a variety of configurations.

### Termination Options

Termination Letter	Poles
A = I-Line	1, 2, 3
F = Terminal Nut	1, 2, 3, 4
L = Lugs on Both Ends	1, 2, 3, 4
M = Lugs ON End, Terminal Nut OFF End	1, 2, 3, 4
P = Lugs OFF End, Terminal Nut ON End	1, 2, 3, 4

For factory-installed terminations, place termination letter in the third block of the circuit breaker catalog number.  
**B D F 3 6 1 2 5**  
 └ Termination Code

## Lug Options

### Lug Options

Lug Option Suffix	Description
No Suffix	EverLink Lugs Both Ends
LU	EverLink Lug with Control Wire Terminal ON End, EverLink Lug OFF End
LV	EverLink Lug ON End, EverLink Lug with Control Wire Terminal OFF End
LW	EverLink Lug with Control Wire Terminals Both Ends
LC	Copper Mechanical Lugs Both Ends
LH	Aluminum Mechanical Lugs Both Ends

For factory-installed lug option, place suffix after the amperage in the circuit breaker catalog number.  
**B D L 3 6 1 2 5 L U**  
 Lug Code └

# Accessories and Auxiliaries

## Accessory Overview

NOTE: In electronic versions of catalog, click product name for product details.

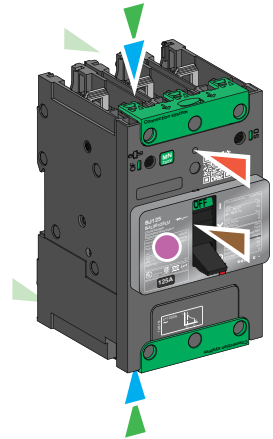

**A**  
Interphase Barriers, page 31

**B**  
Long Terminal Shields, page 31

**E**  
Torque-Limiting Breakaway Bits, page 30

**M**  
Cable Operating Mechanism, page 43

**L**  
EverLink Lug, page 26

**M**  
EverLink Lug with Control Wire Terminal, page 26

**D**  
Power Distribution Connectors, page 29

**M**  
Dual-Cable Operating Mechanism, page 43

**M**  
Variable-Depth Operating Mechanism, page 44

**L**  
Rear Insulating Screens, page 31

**L**  
Terminal Nut Connector, page 28

**L**  
Al Mechanical Lug Connector, page 30

**L**  
Cu Mechanical Lug Connector, page 30

**M**  
Door-Mounted Operating Mechanism, page 42

**I**  
Handle Padlocking Devices, page 50

**J**  
Auxiliary Contact OF / SD, page 36

**J**  
Pre-Wired Auxiliary Contact OF, page 36

**J**  
Pre-Wired Auxiliary Contact SD, page 36

**K**  
Voltage Releases, page 38

**K**  
Pre-Wired Undervoltage Release, page 38

**K**  
Pre-Wired Shunt Trip, page 38

**F**  
Side Rotary Handle, page 48

**C**  
Spreaders, page 29

**G**  
Direct-Mounted Rotary Handle, page 45

**H**  
Extended Rotary Handle, page 46



## Accessory Compatibility

### Accessory Compatibility with Power Connectors

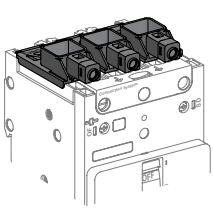
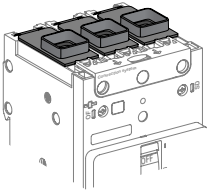
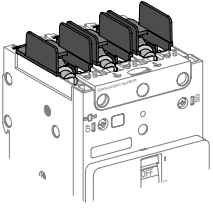
Accessory Overview Code												
	EverLink Lug With (shown) or Without Control Wire Terminal Connector				Mechanical Lug Connector				Terminal Nut Connector			
	1P	2P	3P	4P	1P	2P	3P	4P	1P	2P	3P	4P
A	—	—	—	—	—	X	X	X	—	X	X	X
B	—	—	—	—	—	X	X	X	—	X <sup>5</sup>	X <sup>5</sup>	X <sup>5</sup>
C	—	—	—	—	—	—	—	—	X <sup>6</sup>	X <sup>6</sup>	X	X
D	—	—	—	—	—	—	—	—	X	X	X	X
E	X	X	X	X	—	—	—	—	X	X	X	X
F	—	—	X	X	—	—	X	X	—	—	X	X
G	—	—	X	X	—	—	X	X	—	—	X	X
H	—	—	X	X	—	—	X	X	—	—	X	X
I	X	X	X	X	X	X	X	X	X	X	X	X
J	—	X <sup>7</sup>	X	X	—	X <sup>7</sup>	X	X	—	X <sup>7</sup>	X	X
K	—	X	X	X	—	X	X	X	—	X	X	X
L	—	X	X	X	—	X	X	X	—	X	X	X
M	—	X	X	—	—	X	X	—	—	X	X	—

PowerPact B-frame circuit breakers offer a whole range of field-installable accessories, giving panel builders and customers the chance to modify the circuit breaker at any time in the design/build cycle:

- Power connections, including the patented EverLink lug and control wire terminal feature.
- Electrical accessories, internal to the circuit breaker, with quick snap-in features, spring connections, and wire routing possible out of any of the four corners of the product.
- Insulation features, providing additional safety precautions between people, equipment and circuit breaker.
- Operating mechanisms, when external operation is required, including a side-operating mechanism.
- Locking devices, to secure personnel safety or continuity of service.

5. Long terminal shield is not compatible with spreader kit.

6. By using part(s) of the 3P or 4P spreader kit.

7. Two pole devices only have a slot for the auxiliary switch (OF). See *Electrical Auxiliaries*, page 34.

## Power Connections

### Multiple Types of Power Connections

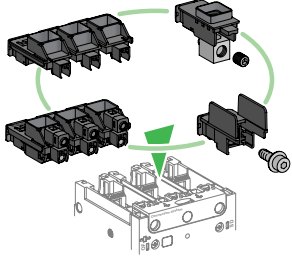

All lugs are UL Listed / CSA Certified for their proper application and marked for use with copper and aluminum (Cu/Al) or copper only (Cu) conductors.

All lug options are field installable. No matter which lugs are on the product, they can be removed and replaced by any of the lugs available:

#### **Available Power Connections, page 97**

- Standard EverLink Lug
- EverLink Lug with Control Wire Terminal
- Mechanical Lugs
  - Copper/Aluminum
  - Copper only
- Compression Lugs
  - Copper/Aluminum
  - Copper only
- Bus Bars
- Power Distribution Connectors
- Terminal Spreaders

#### **Unit-Mount Circuit Breakers**

Unit-mount circuit breakers are delivered with EverLink™ lugs on the line side and load side as standard for the "L" construction. EverLink with control wire terminals can be substituted, as well as aluminum or copper mechanical lugs, and terminal nuts (for compression lugs, power distribution connectors, busbar connection kits and terminal spreaders). See *Terminal Nut Connectors, page 28*.

#### **I-Line Circuit Breakers**

I-Line circuit breakers come with shrouded I-Line plug-on jaws permanently attached on the line side. Standard load side lugs are aluminum mechanical lugs. Optional load side connections include copper mechanical lugs, EverLink™ lugs with control wire terminals, or terminal nuts to connect to bus bars or to compression (crimp) lugs.



### EverLink Lug Connector

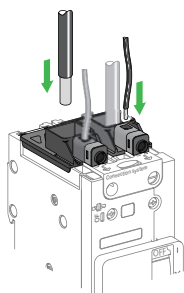

The EverLink lug<sup>8</sup> with creep<sup>9</sup> compensation makes it possible to achieve accurate and durable tightening torque. They minimize loose wiring at installation sites caused by wire strand deformation, terminal temperature changes, and vibration or shocks encountered during equipment transit and handling. EverLink lugs help maintain low-resistance connections for continuity of service.

When ordered as a field-installable kit or as a factory assembled option, the upstream and/or downstream EverLink connector includes control wire terminals (except for the 1 pole product). Control wire terminals provide an auxiliary power supply (10 A max.) to a control power transformer, convenience receptacle, or metering.

8. Schneider Electric patent

9. Creep: normal crushing phenomenon of conductors, that is accentuated over time.

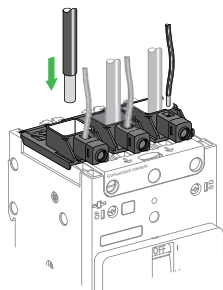

**EverLink Lugs for Use With Al or Cu Wire**

Connection Type	Ampere Rating	Wire Type	Fine Stranded Wire, Class D–K		Rigid Solid/Stranded Wire, Class B & C	
			No.	Range	No.	Range
Power Connection	15–125 A	Cu	1	2.5–70 mm <sup>2</sup> (6–2/0 AWG)	1	2.5–95 mm <sup>2</sup> (14–3/0 AWG)
	15–100 A	Al				
Control Wire Terminal	Up to 10 A	Cu	1	0.5–6 mm <sup>2</sup> (20–10 AWG)	1	1.5–6 mm <sup>2</sup> (20–10 AWG)

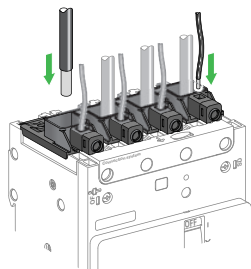

**EverLink Lug Connector Kits**

Description	Field-Installable Catalog Number
For 1 pole	LV426972
For 2 poles with control wire terminal	LV426973
For 3 poles with control wire terminal	LV426974
For 4 poles with control wire terminal	LV426975

**Factory-Installed Options**

ON End	OFF End	Factory-Installed Suffix
EverLink Lug	EverLink Lug	blank
EverLink Lug with Control Wire Terminal	EverLink Lug	LU
EverLink Lug	EverLink Lug with Control Wire Terminal	LV
EverLink Lug with Control Wire Terminal	EverLink Lug with Control Wire Terminal	LW

## Terminal Nut Connectors

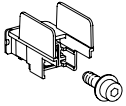
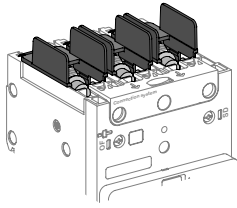

The B-frame circuit breakers may be equipped with terminal nuts and M6 power screws for direct connection to compression lugs, power distribution connectors, busbars and terminal spreaders.

These are readily field-installable, simply by removing the EverLink lug and replacing with the appropriate terminal nut assembly. They are also available factory installed (refer to *Catalog Numbering*, page 21).

### Terminal Nut Connector Kits

Terminal Nut Connector	Nut Size	Qty. per Kit	Catalog Number
B-Frame terminal nut insert-metric with screws	M6	2	LV426962
		3	LV426963

### Bus Bar Dimensions

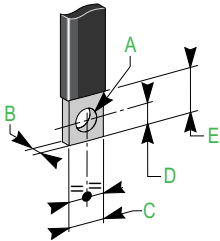

Dimension	A	B	C	D	E
mm (in.)	6.4 (0.250)	≤ 6.5 (≤ 0.25)	≤ 17 (≤ 0.67)	≤ 7 (≤ 0.27)	17→20 (0.67–0.78)

## Compression Lugs

Specific compression lugs can be ordered for copper and aluminum cable.

### B-Frame Compression Lug Kits

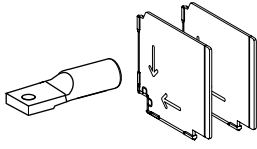
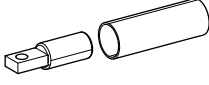
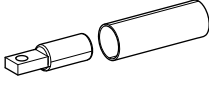
Copper Compression Lugs for Copper Cables	Qty Per Kit	Catalog Number
 For 95 mm <sup>2</sup> solid/stranded / 70 mm <sup>2</sup> fine stranded cable	3	LV426980
	4	LV426981
 For cable 1/0 AWG	2	LV426986
	3	LV426987
Aluminum Compression Lugs for Copper or Aluminum Cables	Qty per kit	
 For cable 1/0 AWG	2	LV426988
	3	LV426989

### Compression Lug Dimensions

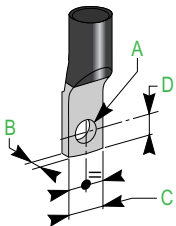

Dimension	A	B	C	D
mm (in.)	6.4 (0.250)	≤ 6.5 (≤ 0.25)	≤ 17 (≤ 0.67)	≤ 7 (≤ 0.27)

### Power Distribution Connectors

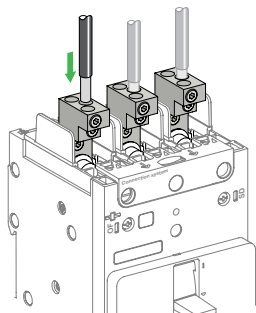



The power distribution connectors (PDCs) can be used for multiple load wire connections on one circuit breaker. Use in place of stand-alone power distribution blocks to save space and time. Field-installable kit includes tin-plated aluminum lug, interphase barriers, and required mounting hardware.

The connectors are attached to circuit breaker terminals equipped with separately provided terminal nut connectors. Interphase barriers (required for installation) are supplied with power distribution connectors, but may be replaced by long terminal shields.

Power distribution connectors are available in 3 wire or 6 wire versions.

- For use on load end of circuit breaker only.
- For use in UL 508 Industrial Control applications.
- For use in UL 1995/CSA C22.2 No. 236 heating and cooling equipment.
- For copper wire only.

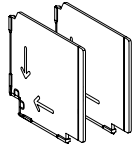
### Power Distribution Connector Kits

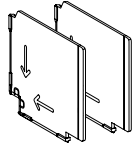
Power Distribution Connector Kit		Kit Number	Qty per Kit	Wires per Terminal	Wire Range	Wire Binding Screw Torque
Power Distribution Connector	Phase Barriers					
		PDC6BD6	3	6	10–16 mm <sup>2</sup> (8–6 AWG)	2.8 N•m (25 lb-in.)
				6	2.5–6 mm <sup>2</sup> (14–10 AWG)	2.3 N•m. (20 lb-in.)
		PDC3BD2	3	3	35 mm <sup>2</sup> (2 AWG)	4.5 N•m (40 lb-in.)
				3	2.5–35 mm <sup>2</sup> (14–3 AWG)	4.0 N•m (35 lb-in.)

### Spreaders

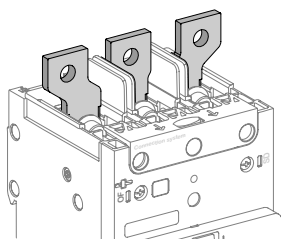

Spreaders can be used to increase the pitch of the circuit breaker from 27 mm (1.063 in.) to 35 mm (1.378 in.). They are delivered with interphase barriers and M8 screws, nuts and washers. The connectors are attached to device terminals equipped with separately provided terminal nut connectors.

Rear insulation screens may have to be used too, depending on the distance between the live uninsulated parts and the grounded metallic back pan.

Holes for customer connection use 8 mm (5/16 in.) hardware, provided.

### Spreader Kits

Description	Used With	Qty per Kit	Catalog Number
B-Frame 3–pole Spreader	B-Frame terminal nut connector	1	<b>LV426940</b>
B-Frame 4–pole Spreader	B-Frame terminal nut connector	1	<b>LV426941</b>

**NOTE:** For a one pole circuit breaker, use the middle part of a 3–pole spreader. For a two pole circuit breaker, use the two middle parts of a 4–pole spreader.

## Mechanical Lug Kits

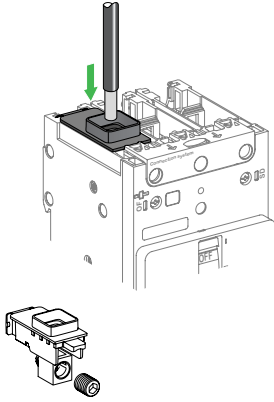

Mechanical lugs suitable for copper and aluminum conductors are available as field-installable kits or factory assembled. (Refer to *Connection Accessories*, page 97.

I-Line “A” type devices ship with load-end Al mechanical lugs as standard.

The mechanical lugs are fastened to the terminals with lug mounting screws inserted from the back of the circuit breaker. The lug cover is held in place with built-in snap features.

### Mechanical Lug Connection Kits



Lug Type	Wires	Wire Range	Factory-Installed Suffix	Field-Installable Kits	
				Qty per Kit	Catalog Number
Cu	1 Cu	2.5 - 50 mm <sup>2</sup> (14 - 1/0 AWG)	LC	2	LV426964
			LC	3	LV426965
Al	1 Al or Cu	2.5 - 70 mm <sup>2</sup> (14 - 2/0 AWG)	LH	2	LV426966
			LH	3	LV426967

## Torque-Limiting Breakaway Bits

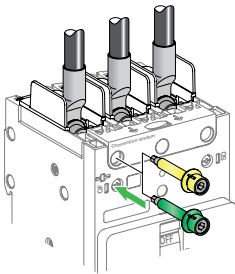
Single-use torque limiting breakaway bits are available for field use to tighten power terminals when a torque wrench is not available. They can also be used in production line quality control to periodically validate torque gun settings.



### Breakaway Bits

Breakaway Bits	Color	Torque	Used With	Qty Per Kit	Catalog Number
	Green	9±0.9 N•m 80±8 lb-in.	EverLink, #6–3/0 wire Terminal Nut, #8–1/0 wire	6	LV426990
				8	LV426991
	Yellow	5±0.5 N•m 44±4.4 lb-in.	EverLink, #14–8 wire	6	LV426992
				8	LV426993

## Insulation of Live Parts

For two, three, or four pole products, accessories are available to ensure insulation and IP rating:

- Long terminal shields (IP40)
- Interphase barriers
- Rear insulation screen.

### Long Terminal Shields (IP40)

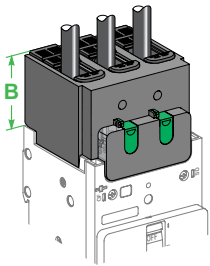

Products can be equipped with long terminal shields. They can be mounted upstream and downstream and are used for protection against direct contact with power circuits. They provide IP40 degree of protection and IK07 mechanical impact protection. The long terminal shield can be mounted after product installation on a plate or DIN rail, and can be removed and put in place even if there are auxiliary wires installed. They are not compatible with EverLink connectors.

They are used for connection with cables or insulated bars.

They are comprised of two parts assembled with two locks and captive screws, forming an IP40 cover.

- The top part is transparent to show the connection and is equipped with sliding grids with break marks for precise adaptation to cables or insulated bars.
- The rear part completely blocks off the connection zone. Partially cut squares can be removed to adapt to all types of connection for cables with lugs or copper bars.

### Interphase Barriers

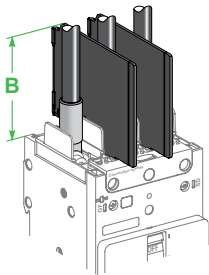

Interphase barriers provide phase to phase isolation at the power-connection points:

- They clip easily onto the circuit breaker.
- They are not compatible with long terminal shields or EverLink connectors.
- There are two ways of mounting: short / long insulation.

### Rear Insulating Screens

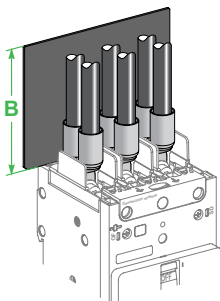

Rear insulating screens provide insulation between the power terminals and the back pan or circuit breaker mounting surface.

Their use may be mandatory if there is no long terminal shield depending on the distance between bare conductors and backplate (see *B-frame Safety Clearance, UL Standard, page 60* and *B-frame Safety Clearance, IEC Standard, page 61*).

## Insulation Accessories

### Insulation Accessories for Two, Three, and Four-Pole Products

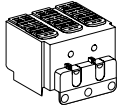
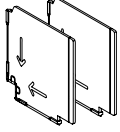
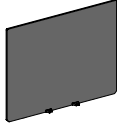
Insulation Accessory		Dimension B	Not Compatible With		Qty per Kit	Kit Catalog Number
<b>Long Terminal Shields</b> 	50 mm (1.97 in.)	EverLink connectors Spreader kit	2 poles	1	<b>LV426911</b>	
			3 poles	1	<b>LV426912</b>	
			4 poles	1	<b>LV426913</b>	
<b>Interphase Barriers</b> 	67/79 mm (2.64/3.11 in.)	EverLink connectors Long Terminal Shields		6	<b>LV426920</b>	
<b>Rear Insulation Screen</b> 	84 mm (3.30 in.)	No compatibility issues	2 poles	2	<b>LV426921</b>	
			3 poles	2	<b>LV426922</b>	
			4 poles	2	<b>LV426923</b>	



## Insulation of Connectors

The table below indicates the connection requirements for PowerPact B-frame devices to ensure insulation of live parts for the various types of connectors.

Connection accessories such as spreaders, PDC lugs, and some compression lugs are supplied with interphase barriers. Long terminal shields provide IP40 degree of protection.

### PowerPact B-Frame Circuit Breakers: Insulation of Live Parts

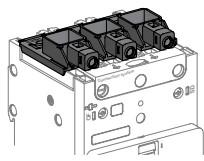
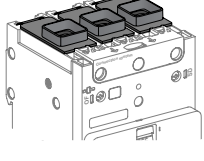
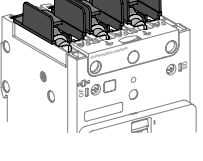
	EverLink Connector With or Without Control Wire Terminal	Mechanical Lug Connector	Terminal Nut Connectors
			

#### Insulation accessory options per conductor type

Type of conductor	No insulating accessory	Inter-phase barriers	Long terminal shield	No insulating accessory	Interphase barriers	Long terminal shield	No insulating accessory	Interphase barriers	Long terminal shield
Cables	Possible	—	—	Possible	Possible	Possible	—	—	—
Insulated Bars	—	—	—	—	—	—	Possible	Possible	Possible
Cables + Compression Lugs	—	—	—	—	—	—	Forbidden	Mandatory	Possible <sup>10</sup>
Cables + Compression Lugs with Heat-Shrink Sheath	—	—	—	—	—	—	Possible	Possible	Possible
Spreader Kits	—	—	—	—	—	—	Forbidden	Mandatory	—
Cables + Power Distribution Connector	—	—	—	—	—	—	Forbidden	Mandatory	Possible <sup>10</sup>

10. Instead of phase barriers.

# Selection of Electrical Auxiliaries

## Electrical Auxiliaries

PowerPact B-frame circuit breakers (except 1 pole) have slots for electrical auxiliaries.

**Indication Contact(s):**

- 1 ON/OFF (OF) Auxiliary Switch
- 1 trip alarm switch (SD).

**One Voltage Release:**

- 1 MN undervoltage release (MN)
- or 1 shunt trip (MX).

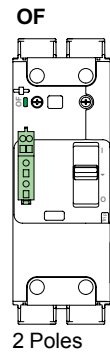

2 Poles

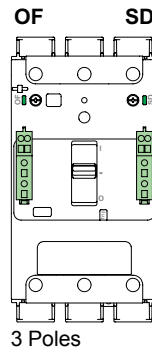

3 Poles

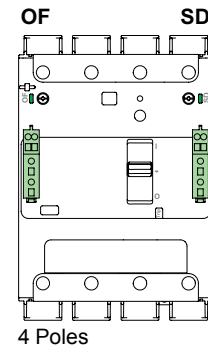

4 Poles

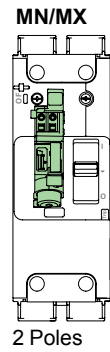

2 Poles

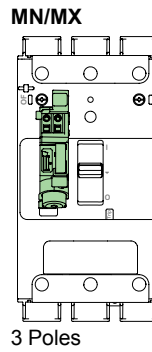

3 Poles

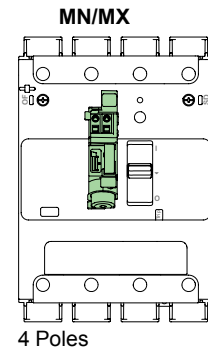

4 Poles

**Slot for Electrical Auxiliaries**

Used With	Number of Poles	Quantity OF	Quantity SD	Quantity MN or MX
B-Frame	1	—	—	—
	2	1	—	1
	3	1	1	1
	4	1	1	1

## Electrical Accessory Connections

Electrical accessories are fitted with numbered spring terminal blocks for wires. The maximum wire size is 1.5 mm<sup>2</sup> (16 AWG) for auxiliary switch (OF), trip alarm switch (SD), shunt trip (MX) or undervoltage release (MN).

Electrical accessory wire routing can be exited out any of the four corners of the unit mount circuit breaker, under the accessory cover even when using the long terminal shield.

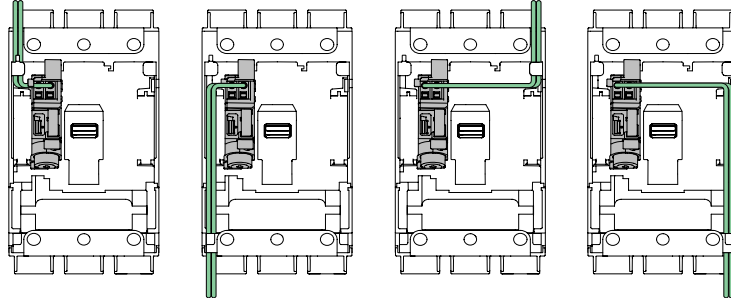

Electrical accessory wire routing can be exited out either of the two load-end corners of the I-Line circuit breaker, under the accessory cover even when using the load-end long terminal shield.

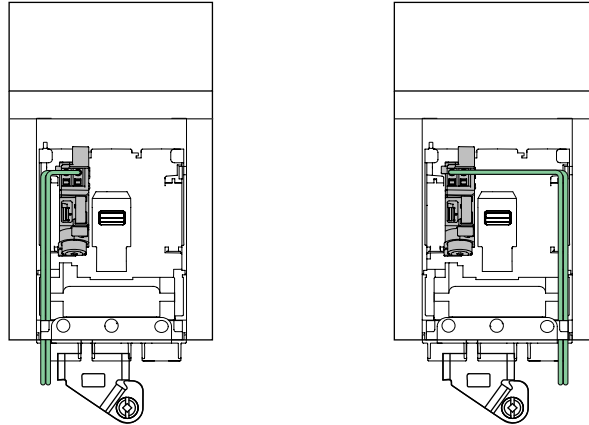

## Auxiliary and Alarm Indication Contacts

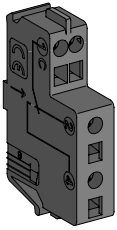

Auxiliary Switch (OF) /  
Alarm Switch (SD).

Indication contacts provide remote information of the circuit breaker status and can thus be used for indications, electrical interlocking, relays, etc.

They are 1A1B common point changeover type contacts, with a normally open (NO) contact and a normally closed (NC) contact.

### Open/Closed - Auxiliary Switch (OF)

- Indicates the position of the circuit breaker contacts.

### Trip Indication - Trip Alarm Switch (SD)

- Indicates that the circuit breaker has tripped due to:
  - an electrical fault (overload, short circuit)
  - the operation of a shunt trip or an undervoltage trip
  - the “push-to-trip” button.
- The activation of the “push-to-trip” button resets when the circuit breaker is reset.

### Electrical Characteristics of Indication Contacts

Characteristics						
Rated thermal current (A)		5				
Minimum load		5 mA at 17 Vdc				
Utilization Cat. (IEC 60947-5-1)		AC12	AC15	DC12	DC13	DC14
Operational current (A)	24 Vac/Vdc	5	5	5	2.5	1
	48 Vac/Vdc	5	5	2.5	1.2	0.2
	110–127 Vac / 110 Vdc	5	4	0.6	0.35	0.05
	220/240 Vac	5	3	—	—	—
	250 Vdc	—	—	0.3	0.05	0.03
	380/440 Vac	5	2.5	—	—	—
	660/690 Vac	5	0.11	—	—	—
UL489, CSA C22.2 No. 5		Ampere Rating (A)		Pilot Duty Standard (A) <sup>11</sup>		
48 Vac		5		—		
120 Vac		5		3		
240 Vac		5		1.5		
480 Vac		5		0.75		
600 Vac		—		0.6		
48 Vdc		2.5		—		
110 Vdc		0.8		—		
250 Vdc		0.3		—		

11. Certified to UL 489 and UL 508 per NEMA Type B600 of “Rating Codes for AC Control-circuit Contacts at 50 and 60 Hz” table.

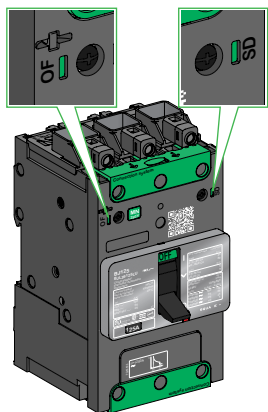

Auxiliary Switch (OF) and Alarm Switch (SD) Indication

**Installation and Connection**

- The auxiliary switch (OF) and alarm switch (SD) indication contacts snap into cavities behind the front accessory cover of the circuit breaker and their presence is visible on the front face through green flags.
- One model serves for all indication functions depending on where it is installed in the circuit breaker.
- Each NO and NC spring terminal may be connected by one 0.5–1.5 mm<sup>2</sup> (20–16 AWG) stranded copper wire and by two wires for the common point. See *Indication Contacts*, page 77 for indication contacts wiring diagrams.

**Auxiliary Contacts Catalog Numbers**

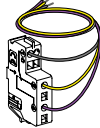
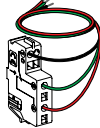
Auxiliary Contacts (Changeover)		Factory Installed Suffix	Field-Installable Kit Catalog Number
	Standard OF	<b>AA</b>	<b>LV426950</b>
	Standard SD	<b>BC</b>	
	Pre-wired OF (18 AWG wire lead length = 1 m)	<b>AAYH</b>	<b>LV426951</b>
	Pre-wired SD (18 AWG wire lead length = 1 m)	<b>BCYH</b>	<b>LV426952</b>

**Standards**

- Indication contacts comply with UL 489, CSA C22.2 No. 5 and IEC 60947-5-1 Standards.
- Indication contacts have also been tested according IEC 60 947-5-4 standard.
- Indication contacts are Listed for field installation per UL file E103955 and Certified under CSA file 177007.

## Shunt Trip (MX) and Undervoltage Release (MN)

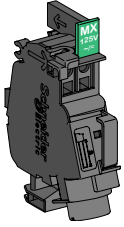

MX or MN Voltage Release

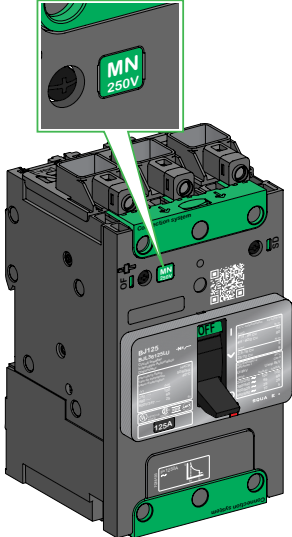

Operating Voltages for MN/MX, Visible Through Front Cover

A voltage release can be used to trip the circuit breaker using a control signal.

Shunt trips serve primarily for remote, emergency-off commands. Undervoltage releases disconnect under low-voltage conditions.

### Installation and Connection

- Voltage releases snap into a cavity under the front accessory cover of the circuit breaker. The presence and characteristics of the voltage release is visible from the front face through a window.
- Each spring terminal may be connected by one 0.5–1.5 mm<sup>2</sup> (20–16 AWG) stranded copper wire.

For information on electrical characteristics and wiring recommendations of MN/MX, see *Shunt Trip (MX) and Undervoltage Release (MN) Wiring Rules*, page 55

### Operation

- The circuit breaker must be reset locally after being tripped by shunt trip (MX) or undervoltage release (MN).
- Tripping by the shunt trip or undervoltage release has priority over manual closing; in the presence of a standing trip order such an action does not result in any closing, even temporarily, of the main contacts.
- Endurance: 50% of the rated mechanical endurance of the circuit breaker.

### Standards

- MN/MX voltage releases comply with with UL 489, CSA C22.2 No. 5 and IEC 60947-2 Standards.
- MN/MX voltage releases are Listed for field installation per UL file E103955 and Certified under CSA file 177007.

## Shunt Trip (MX)

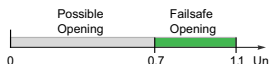

Opening conditions of the MX release.

### Shunt Trip (MX)

- Trips the circuit breaker when the control voltage rises above 70% of its rated voltage ( $U_n$ ).
- Control signals can be impulse type of  $\geq 20$  ms or maintained control signals.
- A 110-130 Vac shunt trip is suitable for ground-fault protection when combined with a Class I ground-fault sensing element.
- Continuous duty rated coil <sup>12</sup>.

### Shunt Trip (MX)

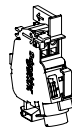
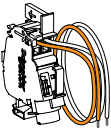
Shunt Trip		Voltage	Factory-Installed Suffix	Field-Installable Catalog Number
	Standard AC	24 Vac 50/60 Hz	SK	LV426841
		48 Vac 50/60 Hz	SL	LV426842
		110–130 Vac 50/60 Hz	SA	LV426843
		208–240 Vac 50/ 60 Hz 220–240 Vac 50 Hz 277 Vac 60 Hz	SD	LV426844
		380–415 V 50 Hz 440–480 V 60 Hz	SH	LV426846
	Standard DC	24 Vdc	SO	LV426841
		48 Vdc	SP	LV426842
		125 Vdc	SR	LV426843
250 Vdc		SS	LV426844	
 <p>Pre-Wired MX (18 AWG wire lead length = 1 m)</p>	Pre-wired AC	24 Vac 50/60 Hz	SKYH	LV426861
		48 Vac 50/60 Hz	SLYH	LV426862
		110–130 Vac 50/60 Hz	SAYH	LV426863
		208–240 Vac 50/60 Hz 220–240 Vac 50 Hz 277 Vac 60 Hz	SDYH	LV426864
		380–415 Vac 50 Hz 440–480 Vac 60 Hz	SHYH	LV426866
	Pre-wired DC	24 Vdc	SOYH	LV426861
		48 Vdc	SPYH	LV426862
		125 Vdc	SRYH	LV426863
		250 Vdc	SSYH	LV426864

12. For MX 24 Vdc only, in case of continuous activation, may generate some minor perturbation in sensitive environment.

## Undervoltage Release (MN)



Opening conditions of the MN release.



Closing conditions of the MN release.

- Trips the circuit breaker when the control voltage drops below 35% of its rated voltage.
- Between 35% and 70% of the rated voltage, opening is possible but not guaranteed.
- Above 70% of the rated voltage, opening does not take place.
- Continuous duty rated coil.
- Circuit breaker closing is possible only if the voltage exceeds 85% of the rated voltage. If an undervoltage condition exists, operation of the closing mechanism of the circuit breaker will not permit the main contacts to touch, even momentarily. This is commonly called “Kiss Free”.

### Undervoltage Release (MN)

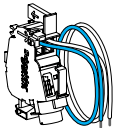
Undervoltage Release		Voltage	Factory-Installed Suffix	Field-Installable Catalog Number
	Standard AC	24 Vac 50/60 Hz	UK	LV426801
		48 Vac 50/60 Hz	UL	LV426802
		110–130 Vac 50/60 Hz	UA	LV426803
		208–240 Vac 50/60 Hz	UC	LV426804
		277 Vac 60 Hz	UD	LV426805
		380–415 Vac 50 Hz	UF	LV426806
		440–480 Vac 60 Hz	UH	LV426807
	Standard DC	24 Vdc	UO	LV426801
		48 Vdc	UP	LV426802
		125 Vdc	UR	LV426803
250 Vdc		US	LV426815	
 <p>Pre-wired MN (18 AWG wire lead length = 1 m)</p>	Pre-wired AC	24 Vac 50/60 Hz	UKYH	LV426821
		48 Vac 50/60 Hz	ULYH	LV426822
		110–130 Vac 50/60 Hz	UAYH	LV426823
		208–240 Vac 50/60 Hz	UCYH	LV426824
		277 Vac 60 Hz	UDYH	LV426825
		380–415 Vac 50 Hz	UFYH	LV426826
		440–480 Vac 60 Hz	UHYH	LV426827
	Pre-wired DC	24 Vdc	UOYH	LV426821
		48 Vdc	UPYH	LV426822
		125 Vdc	URYH	LV426823
		250 Vdc	USYH	LV426835



## Time Delay Unit for Undervoltage Release

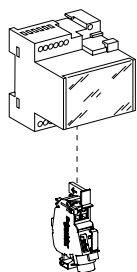

- A time delay unit for the MN eliminates the risk of nuisance tripping due to a transient voltage dip lasting less than 200 ms for fixed delay units and up to 3 seconds for adjustable units. For shorter micro-outages, a system of capacitors provides temporary supply to the MN at  $V > 0.7 V_n$  to ensure not tripping.
- The correspondence between MN and time-delay units is shown below.

### Time Delay Unit for Undervoltage Release (MN)

Time Delay Unit	Composed of:	Catalog Number
MN 48 Vac 50/60 Hz with Fixed Time Delay	MN 48 Vac	<b>LV426802</b>
	Delay Unit 48 Vac 50/60 Hz	<b>LV429426</b>
MN 220-240 Vac 50/60 Hz with Fixed Time Delay	MN 250 Vac	<b>LV426804</b>
	Delay Unit 220-240 Vac 50/60 Hz	<b>LV429427</b>
MN 48 Vac/Vdc 50/60 Hz with Adjustable Time Delay ( $\geq 200$ ms)	MN 48 Vdc	<b>LV426802</b>
	Delay unit 48 Vac/Vdc 50/60 Hz	<b>S33680</b>
MN 110-130 Vdc/Vac 50/60 Hz with Adjustable Time Delay ( $\geq 200$ ms)	MN 125 Vdc	<b>LV426803</b>
	Delay unit 100-130 Vac/Vdc 50/60 Hz	<b>S33681</b>
MN 220-250 Vac/Vdc 50/60 Hz with Adjustable Time Delay ( $\geq 200$ ms)	MN 250 Vdc	<b>LV426815</b>
	Delay Unit 200-250 Vac/Vdc 50-60 Hz	<b>S33682</b>

# Rotary Handles

## Class 9421 Type L Door-Mounted Rotary Operators

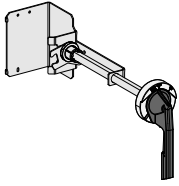

Door-Mounted Rotary Operating Handle

The door mounted operator makes it possible to externally open, close and reset a circuit breaker installed in an enclosure with the enclosure door closed.

- Provides ON (I), OFF (O), and TRIP indication.
- The circuit breaker may be locked in the off position.

The rotary operator kits shown below consist of:

- A mounting plate with a rotary actuator for a standard toggle circuit breaker.
- A heavy duty handle assembly rated for Type 1, 3R, and 12 enclosures.<sup>13</sup>
- An axial operating shaft (extension kit).

The shaft length is determined by the distance between the back of the circuit breaker and the door:

- Minimum mounting depth is 138 mm (5.5 in.).
- Maximum mounting depth is 273 mm (10.75 in.) with standard shaft.
- Maximum mounting depth is 543 mm (21.3 in.) with long shaft.

The extended rotary handle is compatible with 2 and 3-pole circuit breakers.



File E62922  
CCN: DIHS2

### Door-Mounted Extended Rotary Operating Handle

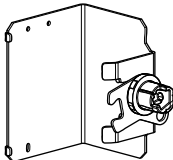
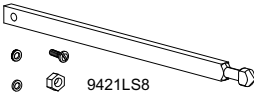
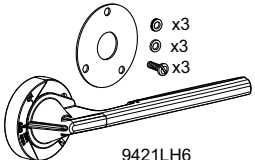
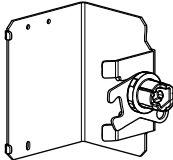
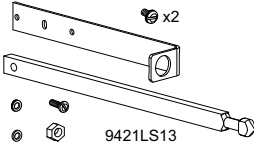
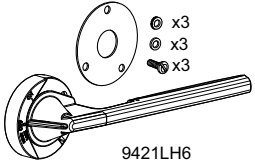
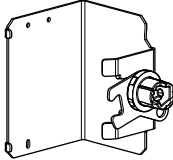
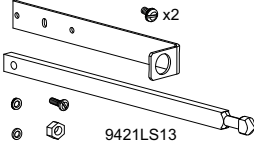
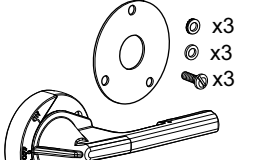
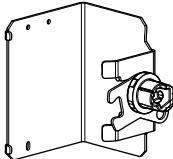
Kit	Catalog Number	Kit Contents		
		Operating Mechanism	Extension Kit	Operating Handle
Standard Shaft / Standard Handle	9421L-B1	 9421LB7	 9421LS8	 9421LH6 ⊙ x3 ⊙ x3 ⊙ x3
Long Shaft / Standard Handle	9421L-B4	 9421LB7	 9421LS13 ⊙ x2	 9421LH6 ⊙ x3 ⊙ x3 ⊙ x3
Long Shaft / Short Handle	9421L-B3	 9421LB7	 9421LS13 ⊙ x2	 9421LH3 ⊙ x3 ⊙ x3 ⊙ x3
Mechanism Only	9421L-B7	 9421LB7	—	—

13. More handle types rated for Type 3, 4, and 4X are available, see Section 8 of the Digest.

## Class 9422 Cable Operating Mechanism

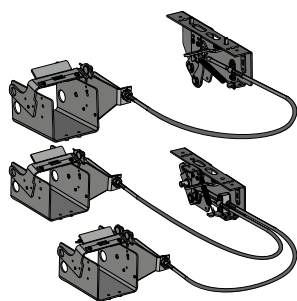

The flange-mounted handle cable operating mechanism is for use with Class 9422 Type A handle operators especially designed for tall, deep enclosures where placement flexibility is required.

The cable operator maintains:

- Suitability for isolation.
- Indication of three positions: O (OFF), I (ON) and tripped
- Access to push-to-test.
- The circuit breaker may be locked in the OFF position by one to three padlocks, 3/16–5/16 in. (4–8 mm) in diameter, not supplied.
- Door can be locked closed due to interlocking features of the handle operator.

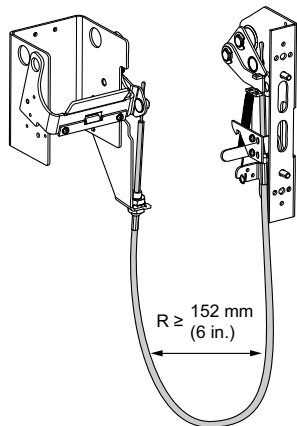

The handle is mounted on flange of enclosure using specified mounting dimensions while circuit breaker and operating mechanism are mounted to inside of enclosure using two screws.

- Cable is available in 0.9, 1.5, 2.1, or 3 m (3, 5, 7, or 10 ft.) lengths to accommodate a variety of mounting locations.
- Handles are available in painted Type 1, 3, 3R, 4 (sheet steel) and 12 ratings or chrome Type 4, 4X.

Note: Bend radius in cable must never be less than 152 mm (6 in.). Electrical clearances must be maintained between cable and live electrical parts.

Refer to NEC Article 430-10 for minimum dimension from circuit breaker top mounting hole to wall or barrier to ensure adequate wire bending space.

### Class 9422 Cable Operating Mechanisms

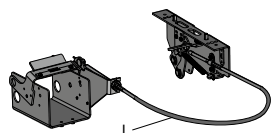

Cable Operating Mechanism

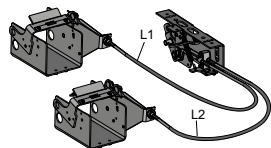

Dual-Cable Operating Mechanism

Mechanism Type	Compatible With	Cable Length	Kit Number <sup>14</sup>
Cable Operating Mechanism	2P, 3P Circuit Breakers	L = 914 mm (36 in.)	9422CSB30
		L = 1524 mm (60 in.)	9422CSB50
		L = 2134 mm (84 in.)	9422CSB70
		L = 3048 mm (120 in.)	9422CSB10
Dual-Cable Operating Mechanism	2P, 3P Circuit Breakers	L1 = 3048 mm (120 in.) L2 = 3048 mm (120 in.)	9422CSBD1
		L1 = 914 mm (36 in.), L2 = 1524 mm (60 in.)	9422CSBD35
		L1 = 1524 mm (60 in.) L2 = 1524 mm (60 in.)	9422CSBD55
		L1 = 914 mm (36 in.) L2 = 3048 mm (120 in.)	9422CSBD31
		L1 = 1524 mm (60 in.) L2 = 3048 mm (120 in.)	9422CSBD51
		L1 = 914 mm (36 in.) L2 = 914 mm (36 in.)	9422CSBD33

### Operating Mechanism Handles

Handle mechanism kits are used with all disconnect switch and circuit breaker installation. The kits contain all parts necessary for mounting the handle on the flange of the enclosure.

The handles are suitable for right- or left-hand flange mounting.

14. Handle ordered separately



9422A1 Handle Operating Mechanism Handle

### Class 9422 Handle Mechanisms

Mechanism Type	Description	Use With	Kit Number
Handle	6 in. Painted Flange Handle	30–300 A switches and all circuit breakers in Type 1, 3, 3R, 4 (sheet steel), and 12 enclosures	9422A1
	6 in. Stainless Steel Flange Handle	30–300 A switches and all circuit breakers in Type 4 (sheet steel) and 4X (stainless steel) enclosures	9422A2
	4 in. Painted Flange Handle	30–300 A switches and all circuit breakers in Type 1, 3, 3R, 4 (sheet steel), and 12 enclosures	9422A3
	4 in. Stainless Steel Flange Handle	30–300 A switches and all circuit breakers in Type 4 (sheet steel) and 4X (stainless steel) enclosures	9422A4
Electrical Interlock	Single Pole Double Throw	—	9999R26
	Double Pole Double Throw	—	9999R27

### Class 9422 Flange-Mounted Variable-Depth Operating Mechanism

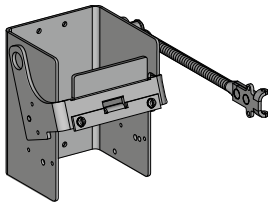

9422RB1

Designed for installation in custom-built control enclosures where external operation of main or branch circuit protective devices are required.

- All circuit breaker operating mechanisms are suitable for either right- or left-hand flange mounting, convertible on the job.
- Variable mounting depth range: 149–451 mm (5.88–17.75 in.).
- Operating mechanism 9422RB1 does not include handle mechanism.
- 9422Ax handle mechanisms shown above are suitable for use with the variable-depth operating mechanism.
- PowerPact B-Frame 2 and 3-pole circuit breakers are compatible with 9422RB1 operating mechanism.



File E62922  
CCN: DIHS2

## Direct Rotary Handles

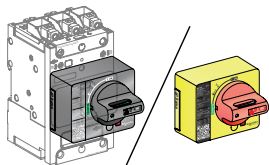

Directly Mounted Rotary Handle.

### Installation

The direct mounted rotary handle is mounted to the circuit breaker’s front accessory cover by three screws. The handle is compatible with 3- and 4-pole unit-mount circuit breakers.

### Operation

The direct rotary handle maintains:

- suitability for isolation
- indication of the three positions: OFF (O), ON (I) and tripped (Trip)
- access to the “push-to-trip” button
- visibility of the trip unit.

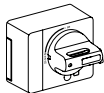
Rotary Handle	Description	Factory-Installed Suffix	Field-Installable Catalog Number
<b>Direct Rotary Handle</b> 	Standard black handle	RD10	<b>LV426930</b>
	Red handle on yellow bezel	RD20	<b>LV426931</b>

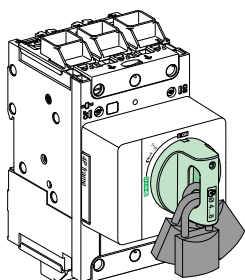

Padlocking Direct Rotary Handle

### Device Padlocking

The circuit breaker may be locked in the OFF position by using one to three padlocks (not supplied) or in the ON position after customer modification of the rotary handle before installation, padlock shackle Ø4–8 mm (3/16–5/16 in.). Locking in the ON position does not prevent the circuit breaker from tripping if an overload or short circuit condition occurs. In this case, the handle remains in the ON position after the circuit breaker trips. Unlocking is required for the handle to go to the tripped position then the OFF position to reset the circuit breaker.

### Variations: Door Locking

Door locking built-in functionality can be activated by the customer to prevent opening the door when the circuit breaker is ON or in trip position. For exceptional situations, door locking can be temporarily bypassed with a tool by qualified personnel to open the door when the circuit breaker is closed.

### Models

- Standard with black handle.
- VDE type with red handle and yellow bezel for machine tool control.

### Standards

- The direct-mounted rotary operating handle is UL Listed under file E103955 and CSA Certified under file 177007.
- Degree of protection IP40, IK07.

## Extended Rotary Handles

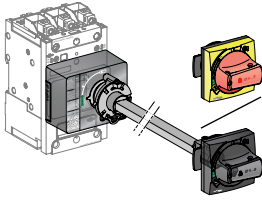

Door-Mounted Rotary Handle

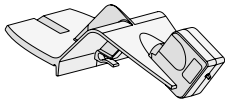

Laser Tool

### Installation

The door-mounted extended rotary handle is compatible with 3- and 4-pole unit-mount circuit breakers.

The door-mounted extended rotary handle kit is made up of:



- a rotary mechanism that is mounted to the front accessory cover of the circuit breaker.
- a handle assembly (handle mechanism and nut) that is mounted on the door. The handle mechanism is always secured in the same position, whether the circuit breaker is installed vertically or horizontally.
- a cut-to-length extension shaft.

The handle assembly is fixed with a nut (Ø 22 mm) to make assembly easier. The Laser Tool (GVAPL01) can be used to accurately align the hole to be cut in the door with the circuit breaker.

### Operation With Door Closed

The door mounted handle makes it possible to operate a circuit breaker installed in an enclosure from the front with the door closed. The door mounted operating handle maintains:

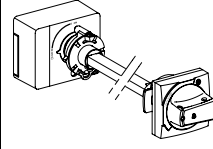
- suitability for isolation
- indication of the three positions OFF (O), ON (I) and tripped (Trip)
- visibility of the trip unit when the door is open
- degree of protection of the handle on the door: IP54 or IP65 as per IEC 529.

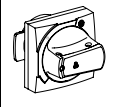
Rotary Handle	Description	Catalog Number
 <b>Door Mounted</b>	Standard black handle (IP54, Type 12)	LV426932
	Red handle on yellow bezel (IP54, Type 12)	LV426933
	Red handle on yellow bezel (IP65, Type 12, 3R, 4X)	LV426934
	Open door shaft operator	LV426937
	Laser tool	GVAPL01
 <b>Universal Handle</b>	Black handle (IP54, Type 12)	LV426997
	Red handle on yellow bezel (IP54, Type 12)	LV426998
	Red handle on yellow bezel (IP65, Type 12, 3R, 4X)	LV426999

### Mechanical Door Locking

A standard feature of the extended rotary handle is a locking function, built into the shaft, that prohibits door opening when the circuit breaker is in the ON or tripped positions.

Door locking can be temporarily bypassed with a tool by qualified personnel to open the door without opening the circuit breaker. This operation is not possible if the handle is locked by a padlock.

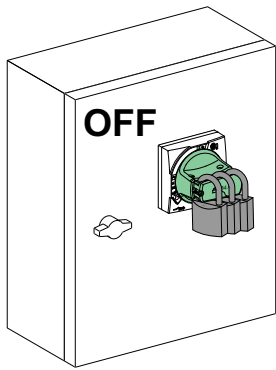

Padlocking Direct Rotary Handle

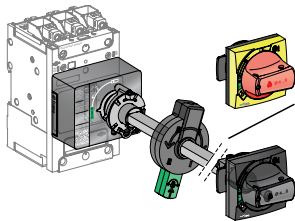

Door-Mounted Rotary Handle with Open Door Shaft Operator.

### Device and Door Padlocking

Padlocking locks the circuit breaker handle and disables door opening:

- The handle may be locked in the OFF position using 1 to 3 padlocks diameter  $\varnothing$  4–8 mm (3/16–5/16 in.). Padlocks are not supplied.
- A voluntary customer modification of the black handle allows locking in the ON and OFF positions. Locking in the ON position does not prevent the circuit breaker from tripping if an overload or short circuit condition occurs. In this case, the handle remains in the ON position after the circuit breaker trips. Unlocking is required for the handle to go to the tripped position then the OFF position to reset the circuit breaker.

### Operation With Door Opened

The indication of the three positions **OFF (O)**, **ON (I)** and **tripped (Trip)** is visible on the extended rotary handle mechanism. The circuit breaker itself may be locked in the OFF position when the door is opened by one padlock / lockout hasp, diameter  $\varnothing$  4–8 mm (3/16–5/16 in.). An optional open door shaft operator can be used to operate the circuit breaker when the door is opened. This UL508A accessory complies with NFPA79.

### Shaft Length

The shaft length is calculated using the distance between the back of the circuit breaker and the door:

- minimum shaft length is 200 mm (7.87 in.)
- maximum shaft length is 600 mm (23.62 in.)
- shaft length must be adjusted to the particular installation.

### Models

- Standard with black handle (IP54).
- VDE type with red handle and yellow bezel for machine tool control (IP54).
- Standard with an IP65 universal handle (red handle and yellow bezel). The IP65 version may not show trip indication.

IP54 models are suitable for mounting on the flat surface of enclosures rated Type 12. IP65 models are suitable for use in Type 12, 3R and/or 4X enclosure applications.

### Standards

The door-mounted rotary operating handle is UL Listed under file E103955 and CSA Certified under file 177007.

## Side Rotary Handles

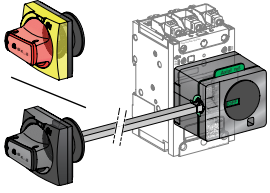

Side-Mounted Rotary Handle





### Installation

The side-mounted rotary handle is compatible with 3- and 4-pole unit-mount circuit breakers.

The side-mounted rotary handle kit is made up of:

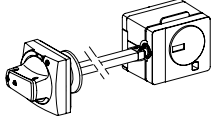
- a rotary mechanism that has to be mounted to the front accessory cover of the circuit breaker using three screws.
- an assembly (handle and nut) that mounts on the side (left or right) of the enclosure.
- a cut-to-length extension shaft.

The handle assembly is fixed with a nut (Ø 22 mm) to make assembly easier.

Rotary Handle	Description	Catalog Number
Side Mounted	 Standard black handle (IP54, Type 12)	LV426935
	 Red handle on yellow bezel (IP54, Type 12)	LV426936
Universal Handle	 Black handle (IP54, Type 12)	LV426997
	 Red handle on yellow bezel (IP54, Type 12)	LV426998
	 Red handle on yellow bezel (IP65, Type 12, 3R, 4X)	LV426999

### Operation

The side-mounted rotary handle makes it possible to operate a circuit breaker installed in an enclosure from the side. The side mounted rotary handle maintains:

- suitability for isolation.
- indication of the three positions OFF (O), ON (I) and tripped (Trip) is visible on the handle (outside the panel) and on the rotary mechanism (inside the panel).
- visibility of and access to the trip unit when the door is open.
- degree of protection of the handle on the side: IP54 or IP65 as per IEC 529.

### Device Padlocking

The handle may be locked in the OFF position using 1 to 3 padlocks diameter Ø 4–8 mm (3/16–5/16 in.). Padlocks are not supplied.

A voluntary customer modification of the black handle, during installation, allows locking in the ON and OFF positions. Locking in the ON position does not prevent the circuit breaker from tripping if an overload or short circuit condition occurs. In this case, the handle remains in the ON position after the circuit breaker trips. Unlocking is required for the handle to go to the tripped position then the OFF position to reset the circuit breaker.

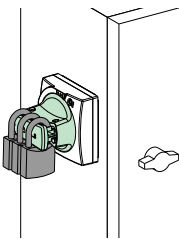

Padlocking Direct Rotary Handle

### Shaft Length

The shaft length is calculated using the distance between the nearest side of the circuit breaker and the side of the enclosure:

- Minimum shaft length is 45 mm (1.77 in.).
- Maximum shaft length is 480 mm (18.90 in.).
- Shaft length must be adjusted to the particular installation.



**Models**

- Standard with black handle (IP54).
- VDE type with red handle and yellow bezel for machine tool control (IP54).
- Standard with an IP65 universal handle (red handle and yellow bezel).

IP54 models are suitable for mounting on the flat surface of enclosures rated Type 12.

IP65 models are suitable for use in Type 12, 3R and/or 4X enclosure applications.

**Standards**

The side-mounted rotary operating handle is UL Listed under file E103955 and CSA Certified under file 177007.

## Locks and Sealing Accessories

### Locks

Padlocking systems can accept up to three padlocks with diameters of 5–8 mm (3/16–5/16 in.); padlocks not supplied.

Locking in the OFF position provides isolation as per IEC 60947-2.

Rotary handle has integral padlocking capability.

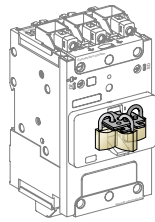
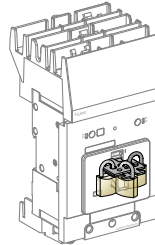
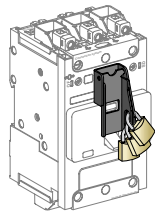
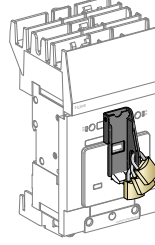
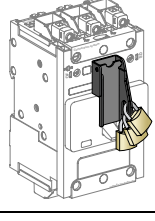
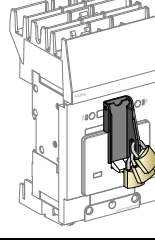
Lock Description	Handle Padlocking Device	Factory-Installed Catalog Suffix	Field-Installable Catalog Number
Removable (Lock OFF Only)	 Unit Mount	—	S29370
	 I-Line	—	S29370
Fixed (Lock OFF or ON)	 Unit Mount	YP	LV426905
	 I-Line	YP	LV426907
Fixed (Lock OFF Only)	 Unit Mount	YQ	LV426906
	 I-Line	YQ	LV426908

### Interlocking of Circuit Breakers with Toggle Control

Interlocking involves padlocking the toggle handles on two devices which may be either circuit breakers or automatic switches.

Authorized positions:

- one device closed (ON), the other open (OFF)
- both devices open (OFF).

The system is locked using up to three padlocks (shackle diameter 3/16–5/16 in. [5 to 8 mm]).

The devices must be unit mount construction, circuit breakers can be mounted via backpan mount or DIN rail. Interlocking is not available for I-Line constructions.

## Manual Mechanical Interlocking System

Some installations use two power supply sources to counter any temporary loss in the main supply. A mechanical interlocking system is required to safely switch between the two sources. The replacement source can be a generator set or another network.

The mechanical interlocking system is made up of:

- two B-frame devices
- mechanical interlock, which prevents handle movement of one device from the OFF position while the other device is in the ON position.

### Interlocking System

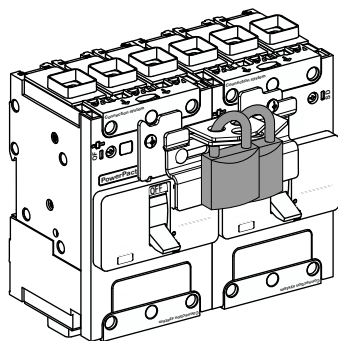

## Sealing Accessories

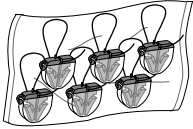

Sealing accessories

Sealing accessories are available. Each bag of accessories contains all the parts required for the types of sealing indicated below.

A bag contains:

- Six sealing accessories.
- Six plastic seals.

### Types of Seals and Corresponding Functions

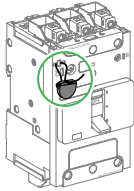
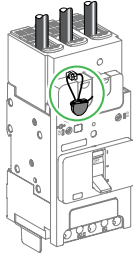
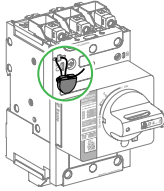
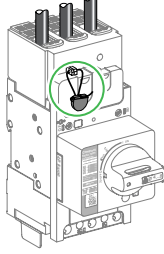
Control Type	Catalog Number	<ul style="list-style-type: none"> <li>• Front Removal</li> <li>• Access to Auxiliaries</li> </ul>	<ul style="list-style-type: none"> <li>• Access to Power Connections</li> </ul>
Toggle	MICROTUSEAL		
Rotary handle	MICROTUSEAL		

# Operating and Installation Conditions

## Environmental Conditions

### Ambient Temperature

PowerPact B-frame circuit breakers may be used between -25°C (-13°F) and +70°C (158°F).

For temperatures higher than 40°C (104°F) inside the enclosure, devices must be derated.

Circuit breakers should be put into service under normal ambient, operating temperature conditions.

Exceptionally, the circuit breaker may be put into service when the ambient temperature is between -35°C (-31°F) and -25°C (-13°F).

The permissible storage-temperature range for PowerPact B-frame circuit breakers in the original packing is -50°C (-67°F) and +85°C (185°F).

### Altitude Derating

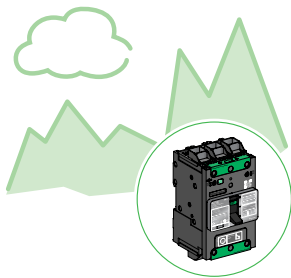

Altitude does not significantly affect the characteristics of PowerPact B-frame circuit breakers up to 2000 m (6560 ft). Above this altitude, it is necessary to take into account the decrease in the dielectric strength and cooling capacity of air.

The following table gives the corrections to be applied for altitudes above 2000 m (6560 ft).

The breaking capacities remain unchanged.

Altitude		2000 m (6560 ft)	3000 m (9840 ft)	4000 m (13120 ft)	5000 m (16400 ft)
Impulse withstand voltage (kV)		8	7.1	6.4	5.6
Insulation voltage (V)	U <sub>i</sub>	800	710	635	560
Maximum operational voltage (V)	U <sub>e</sub>	690	690	635	560
Average current capacity (A) at 40°C (104°F)	I <sub>n x</sub>	1.0	0.98	0.96	0.94

### Vibrations

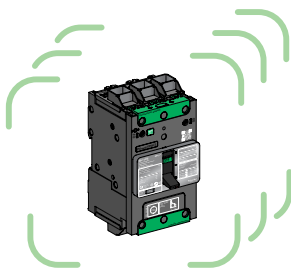

PowerPact B-frame devices resist mechanical vibrations.

They meet following levels of IEC 60068-2-6:

- 2.0 to 25 Hz and amplitude ±1.6 mm.
- 25 to 100 Hz acceleration ±4 g.

Excessive vibration may cause tripping, breaks in connections or damage to mechanical parts.

## Climatic Withstand

The materials used in PowerPact B-frame circuit breakers will not support the growth of fungus and mold.

PowerPact B-frame circuit breakers have passed the test defined below for extreme atmospheric conditions.

Dry cold and dry heat:

- IEC 60068-2-1-dry cold at  $-55^{\circ}\text{C}$ .
- IEC 60068-2-2-dry heat at  $+85^{\circ}\text{C}$ .

Damp heat (tropicalization):

- IEC 60068-2-30–damp heat (temperature  $+ 55^{\circ}\text{C}$  and relative humidity of 95%).
- IEC 60068-2-52 severity 2 - Cycling salt mist.

## Electromagnetic Disturbances

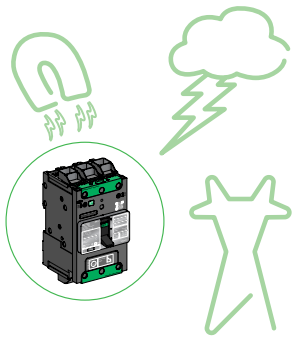

PowerPact B-frame circuit breakers have successfully passed the electromagnetic compatibility tests (EMC) defined by the following international standards: IEC/EN 60947-2: Low-voltage switchgear and controlgear, part 2: circuit breakers.

PowerPact B-frame circuit breakers are protected against:

- Overvoltages caused by circuit switching.
- Overvoltages caused by an atmospheric disturbances or by a distribution-system outage (such as from failure due to lightning).
- Devices emitting radio waves (radios, walkie-talkies, radar, etc.).
- Electrostatic discharges produced directly by users.

# Shunt Trip (MX) and Undervoltage Release (MN) Wiring Rules

## Recommended Maximum Cable Lengths

In certain circumstances, high cable capacitance (C) due to an excessive cable length could prevent an undervoltage release MN from dropping out resulting in safety issues. In case of a shunt trip MX, an untimely trip may occur due to capacitive current leak.

To avoid these dysfunctions due to excessive cable capacitance (C), the maximum cable length (L) is defined by the following table for a 1.5 mm<sup>2</sup> cable (#16 AWG).

## Maximum Cable Length

Power Supply Voltage (Vn)	Maximum Cable Length	
	Undervoltage Trip (MN) <sup>15</sup>	Shunt Trip (MX) <sup>15</sup>
24 Vac	1 243 m (4,078 ft)	3 653 m (11,985 ft)
24 Vdc	Unlimited	> 3653 m (11,985 ft)
48 Vac	583 m (1912 ft)	1 667 m (5,469 ft)
48 Vdc	Unlimited	> 1667 m (5,469 ft)
110...130 Vac	126 m (413 ft)	913 m (2,995 ft)
110...130 Vdc	Unlimited	> 913 m (2,995 ft)
208-240 ac	109 m (358 ft)	160 m (525 ft)
250 Vdc	Unlimited	> 160 m (525 ft)
277 Vac	98 m (322 ft)	120 m (394 ft)
380-415 Vac	86 m (282 ft)	80 m (262 ft)
440-480 Vac	56 m (184 ft)	67 m (220 ft)

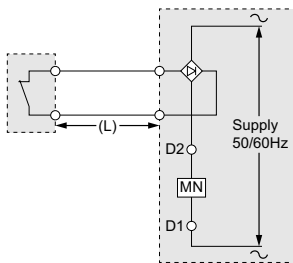
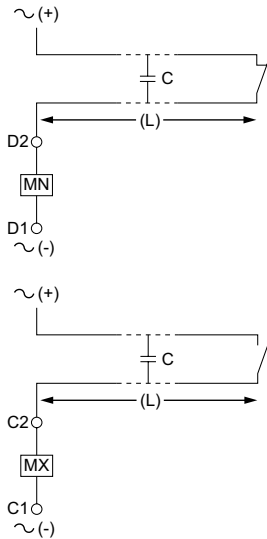

If a longer cable length is required, several solutions are possible to counteract excessive cable capacitance:

- Use DC operated auxiliaries.
- Use lower control voltage (make sure auxiliaries supply voltage is within working range: 0.85 Vn minimum–1.1 Vn maximum).
- If high voltage and long control cables are required for an AC undervoltage release (MN), add a rectifier bridge (ref LV426899 – DIN rail compatible) in the control circuit. It will prevent drop out problems but increase operating time.

## Electrical Characteristics of MN/MX

Characteristics		AC	DC
Rated voltage (V)		24, 48, 110–130, 208–240, 277, 380–415, 440–480	24, 48, 125, 250
Power requirements	MX	Pickup (< 50 ms)	< 10 W
		Seal-in	< 1 W
	MN	< 7 VA	< 2 W
Clearing time (ms)		< 50	< 50
Operating range		Up to 1.1 Vn	Up to 1.1 Vn

15. Make sure auxiliaries supply voltage is within working range (0.85 Vn min.–1.1 Vn max.).

## Temperature Considerations

### Correction Factor

The overload protection is calibrated at 40°C. This means that when the ambient temperature is less than or greater than 40°C, the In protection pick-up is slightly modified.

#### Derating Depending on the Temperature

Over the reference temperature of 40°C (104°F), the circuit breaker has to be derated following the table below:

**Correction Factor Table for PowerPact B-frame Circuit Breakers**

Rating (In) (A)	Temperature (°C / °F)						
	40 / 104	45 / 113	50 / 122	55 / 131	60 / 140	65 / 149	70 / 158
15	15	14	14	13	12	12	11
20	20	19	19	18	18	17	16
25	25	24	24	23	22	21	20
30	30	29	28	27	26	25	24
35	35	34	33	32	31	31	30
40	40	39	38	37	36	35	33
45	45	44	42	41	39	37	36
50	50	49	47	45	44	42	40
60	60	58	56	55	53	51	48
70	70	67	64	61	59	55	53
80	80	77	73	70	67	63	59
90	90	87	83	80	76	72	68
100	100	99	96	92	85	80	69
110	110	107	103	99	94	89	76
125	125	121	117	112	109	104	100



## Calculating Tripping Time

### Calculating the Tripping Time for a Given Temperature:

After having determine the corrected ratio  $I/I_n$ , the tripping time at 40°C (104°F) is defined with the tripping curves ( *Trip Curves, page 78*). Then to obtain the tripping time at a different temperature, the ratio  $I/I_n$  has to be corrected with the correction factor below:

**Correction Factor Table for PowerPact B-Frame Circuit Breakers**





Rating (In) (A)	Temperature °C (°F)												
	10 (50)	15 (59)	20 (68)	25 (77)	30 (86)	35 (95)	40 (104)	45 (113)	50 (122)	55 (131)	60 (140)	65 (149)	70 (158)
15	1.21	1.18	1.15	1.11	1.05	1.04	1	0.96	0.92	0.87	0.83	0.78	0.72
20	1.16	1.13	1.11	1.08	1.06	1.03	1	0.97	0.94	0.91	0.88	0.85	0.81
25	1.15	1.13	1.11	1.08	1.05	1.03	1	0.97	0.94	0.91	0.88	0.85	0.82
30	1.16	1.14	1.11	1.08	1.06	1.03	1	0.97	0.94	0.91	0.87	0.84	0.80
35	1.13	1.11	1.09	1.07	1.05	1.02	1	0.98	0.95	0.93	0.90	0.87	0.85
40	1.14	1.12	1.10	1.07	1.05	1.03	1	0.97	0.95	0.92	0.89	0.86	0.83
45	1.17	1.15	1.12	1.09	1.06	1.03	1	0.97	0.94	0.90	0.87	0.83	0.79
50	1.16	1.14	1.11	1.08	1.06	1.03	1	0.97	0.94	0.91	0.87	0.84	0.80
60	1.16	1.14	1.11	1.08	1.06	1.03	1	0.97	0.94	0.91	0.88	0.84	0.81
70	1.18	1.15	1.13	1.10	1.06	1.03	1	0.96	0.91	0.88	0.84	0.79	0.75
80	1.19	1.15	1.12	1.09	1.06	1.03	1	0.96	0.92	0.88	0.83	0.79	0.74
90	1.19	1.15	1.12	1.10	1.06	1.04	1	0.96	0.92	0.89	0.84	0.80	0.75
100	1.21	1.18	1.15	1.12	1.09	1.05	1	0.99	0.96	0.92	0.85	0.80	0.69
110	1.19	1.16	1.13	1.10	1.07	1.04	1	0.98	0.94	0.90	0.85	0.80	0.70
125	1.17	1.14	1.12	1.09	1.06	1.03	1	0.96	0.94	0.90	0.87	0.83	0.80

# Installation and Operating Conditions

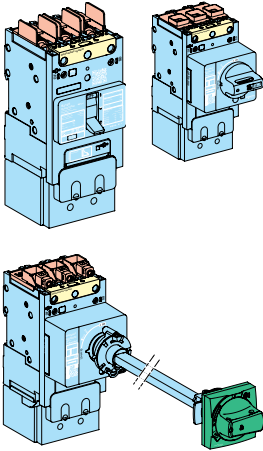
## Protection Degree

### Protection Degree of the Product (According to IEC60259, Protection Degree Depends on Configuration)

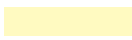

Colors	Definition
	IP 54/65: side / front extended rotary handle
	IP 40: front cover, side, back, long terminal shield, direct rotary handle
	IP20: mounting screws cover
	May be IP20 or less depending of the kind of power connections and cable size used (cable outside diameter (OD) including insulation to be greater than 200 mils)

## Reverse Feeding

PowerPact B-frame circuit breakers can be supplied from either the top or the bottom without any reduction in performance giving the designer/installer flexibility in choosing the mounting location for the breaker and feed cables.

All connection and insulation accessories can be used on circuit breakers supplied either from the top or bottom.

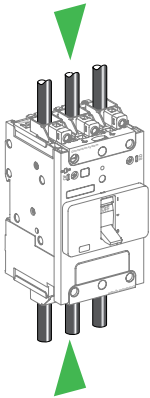

# Installation in Equipment

## Safety Clearances and Minimum Distances

When installing a circuit breaker, minimum distances (safety clearances) must be maintained between the device and panels, busbars and other protection devices installed nearby. These distances are defined by tests carried out in accordance with UL standards.

If installation is not checked by type tests, it is also necessary to:

- use insulated bars for circuit breaker connections.
- segregate the busbars using phase barriers.

For PowerPact B-frame devices, terminal shields and interphase barriers are recommended and may be mandatory depending on type of installation.

## B-frame Safety Clearance, UL Standard

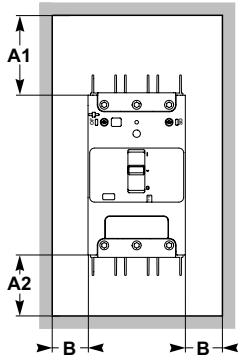

For all types of PowerPact B-frame circuit breakers that use uninsulated power connections (for example, busbars, spreaders, or uninsulated compression lugs), the minimum clearance distance between the enclosure backplate (grounded metal) and uninsulated power connections is shown below.

When using uninsulated connectors be sure to maintain the proper clearance between live parts and the grounded metallic back pan or use the insulation screen.

### Minimum Enclosure Dimensions

Standard (80%)	100% Rated
14.6 x 8.5 x 3.16 in. (371 x 216 x 80 mm)	18.13 x 8.63 x 4.13 in. (461 x 219 x 105 mm)

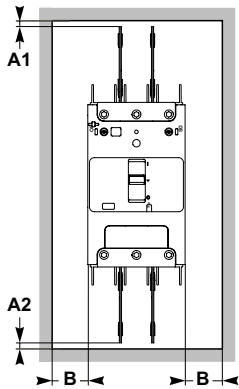

### Minimum Safety Clearance Dimensions to Enclosure or Any Grounded Metal

Operating voltage  $V < 690 V$

For devices equipped with:	Clearance (mm)						
	Between devices	Between device and sheet metal					
		Painted sheet metal			Bare sheet metal		
		A1	A2	B	A1	A2	B
No terminal accessories	0	30 mm (1.18 in.)	5 mm (0.19 in.)	0	40 mm (1.57 in.)	5 mm (0.19 in.)	5 mm (0.19 in.)
Interphase barriers	0	0	0	0	0	0	5 mm (0.19 in.)
Long terminal shields	0	0	0	0	0	0	5 mm (0.19 in.)

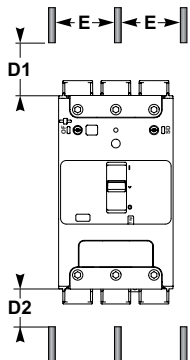

### Minimum Safety Clearances to Bare Busbars

Operating voltage  $V \leq 690 V$

Clearances to live bare busbars <sup>16</sup>			
Spacing $E \leq 60 \text{ mm (2.36 in.)}$		Spacing $E > 60 \text{ mm (2.36 in.)}$	
D1	D2	D1	D2
200 mm (7.87 in.)	100 mm (3.94 in.)	120 mm (4.72 in.)	60 mm (2.36 in.)

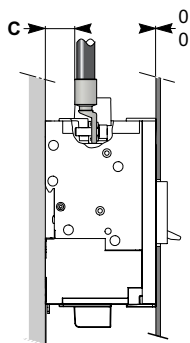

### Exposed Conductor Safety Clearance

An insulating screen or long terminal shield is required if  $C < 12.7 \text{ mm (<0.5 in.)}$  if voltage is  $\geq 300 V$ .

16. These clearances can be reduced for special installations as long as the configuration is checked by tests.

## B-Frame Safety Clearance, IEC Standard

For all types of PowerPact B-frame circuit breakers that use uninsulated power connections (for example, busbars, spreaders, or uninsulated compression lugs), the minimum clearance distance between the enclosure backplate and uninsulated power connections is shown below.

When using uninsulated connectors be sure to maintain the proper clearance between live parts and the grounded metallic back pan or use the insulation screen.

### Minimum Enclosure Dimensions

Operating voltage V < 690 V							
For devices equipped with:	Clearance (mm)						
	Between devices	Between device and sheet metal					
		Painted sheet metal			Bare sheet metal		
		A1	A2	B	A1	A2	B
No terminal accessories	0	30 mm (1.18 in.)	5 mm (0.19 in.)	0	40 mm (1.57 in.)	5 mm (0.19 in.)	5 mm (0.19 in.)
Interphase barriers	0	0	0	0	0	0	5 mm (0.19 in.)
Long terminal shields	0	0	0	0	0	0	5 mm (0.19 in.)

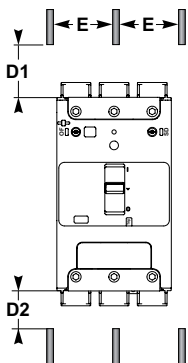
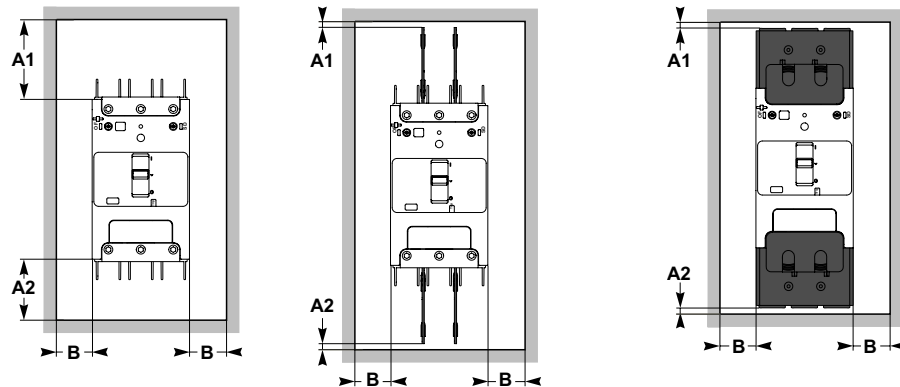

### Minimum Safety Clearances to Bare Busbars

Operating voltage V ≤ 690 V			
Clearances to live bare busbars <sup>17</sup>			
Spacing E ≤ 60 mm (2.36 in.)		Spacing E > 60 mm (2.36 in.)	
D1	D2	D1	D2
200 mm (7.87 in.)	100 mm (3.94 in.)	120 mm (4.72 in.)	60 mm (2.36 in.)

17. These clearances can be reduced for special installations as long as the configuration is checked by tests.

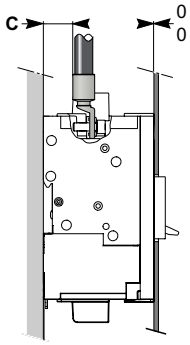

### Exposed Conductor Safety Clearance

An insulating screen or long terminal shield is required if:

- 2, 3, or 4 poles
- $C < 9.5 \text{ mm}$  ( $< 0.37 \text{ in.}$ ),

Customer-provided insulation material required if:

- 1 pole
- $C < 12.7 \text{ mm}$  ( $< 0.5 \text{ in.}$ ).

## Circuit Breaker Enclosures, Enclosure Accessories (Available Late 2017)

Square D™ brand circuit breaker enclosures are UL Listed/CSA Certified and are suitable for use as service entrance equipment.

The short circuit rating of an enclosed circuit breaker is equal to the rating of the circuit breaker installed.

Circuit breakers are ordered and shipped separately for field installation.

### Circuit Breaker Enclosure Catalog Numbers

Device Information		Enclosure Catalog No.				Neutral Kit Catalog No.	Service Ground Kit
Device	Poles						
		NEMA 1 Flush	NEMA 1 Flush 304 Stainless Steel Front	NEMA 1 Surface	NEMA 3R		
Circuit Breaker	1, 2, 3	B125F	B125FSS	B125S	B125RB	SN100FA	PKOGTA2
		NEMA 4X, 5 Type 304 Stainless Steel	NEMA 4X, 5 Type 316 Stainless Steel	NEMA 12K Without Knockouts	NEMA 4X Without Knockouts		
Circuit Breaker	1, 2, 3	B125DS	B125SS	B125A	B125AWK	SN100FA	PKOGTA2
Molded Case Switch	1, 2, 3	—	—	—	B125WKMC	—	—

# Dimensions

## Circuit Breaker Dimensions

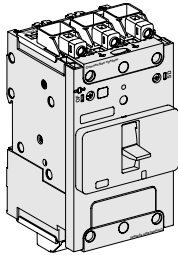

1P

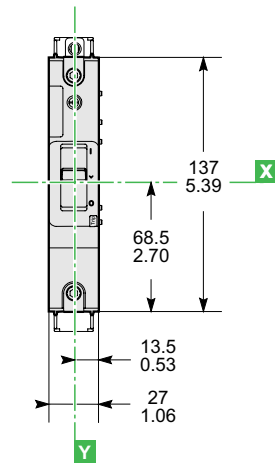

2P

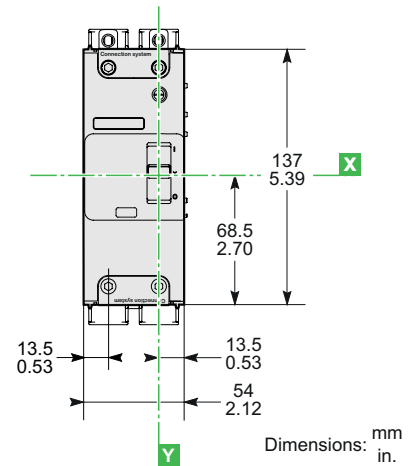

Dimensions: mm in.

3P

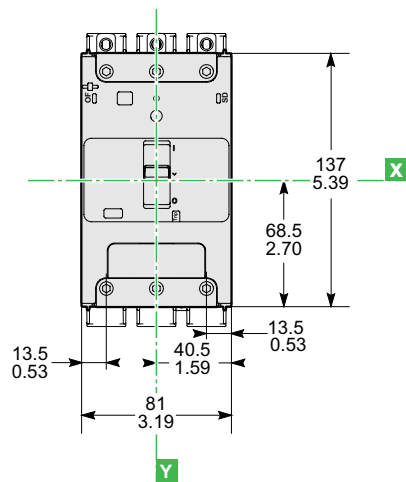

4P

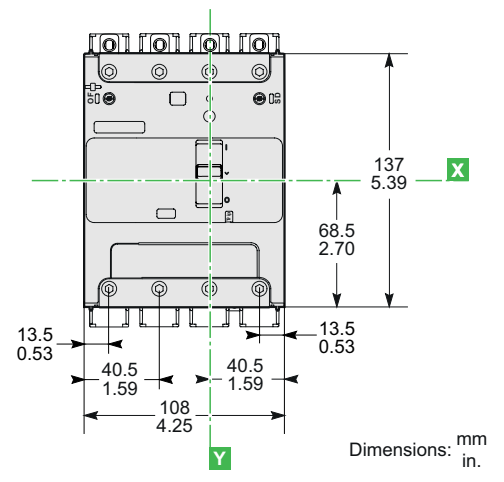

Dimensions: mm in.

Side View

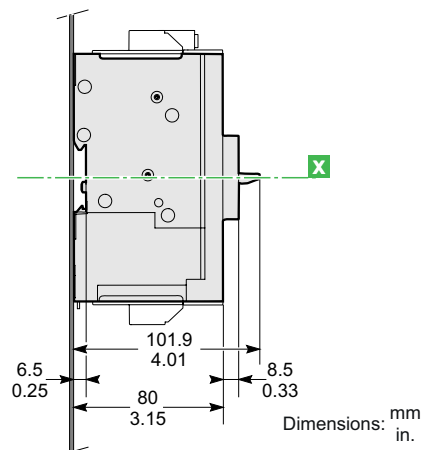

Dimensions: mm in.

# Connector Dimensions

## EverLink with Control Wire Terminal Connector

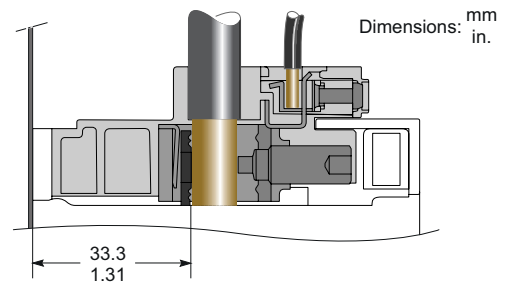
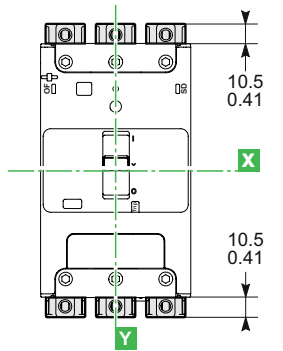
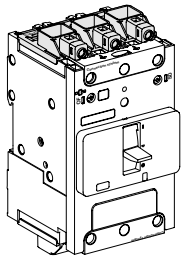

## EverLink Without Control Wire Terminal Connector

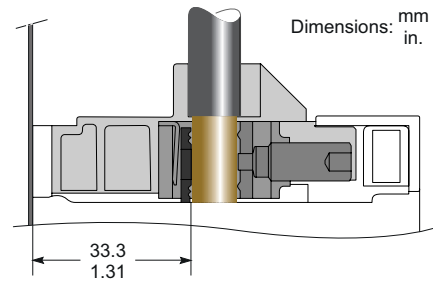
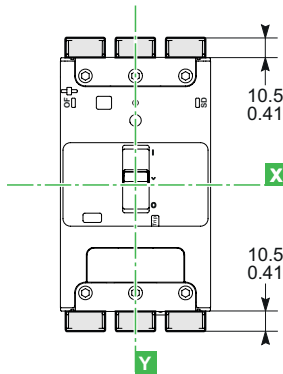
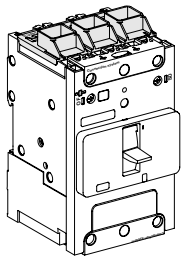

## Mechanical Lug Connector

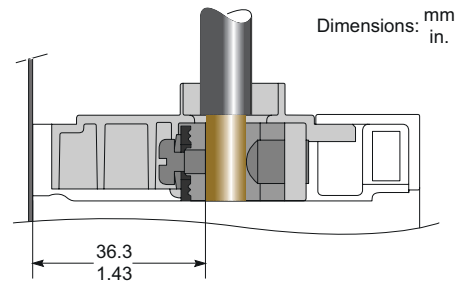
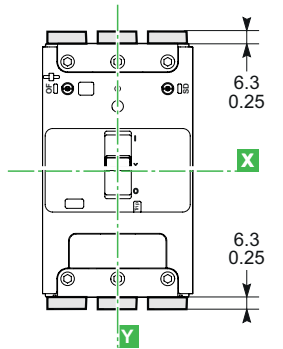
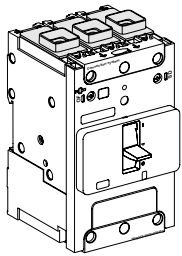

## Terminal Nut Connector

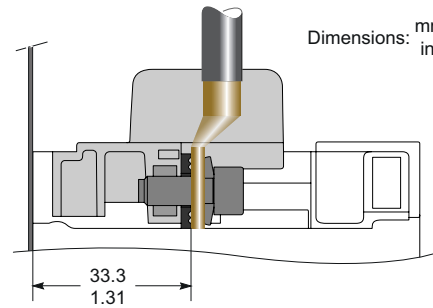
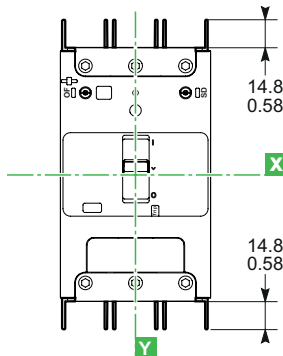
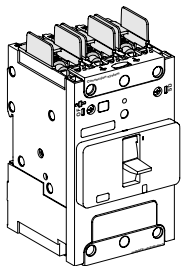



**Power Distribution Connectors**

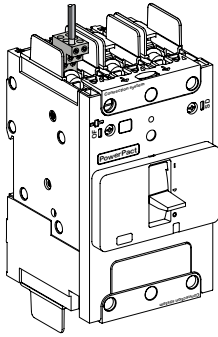

**6 Holes**

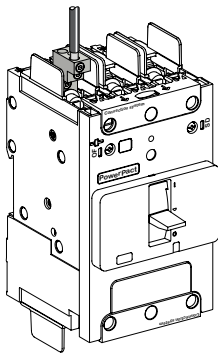
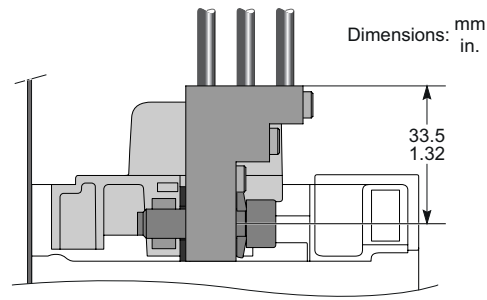

**3 Holes**

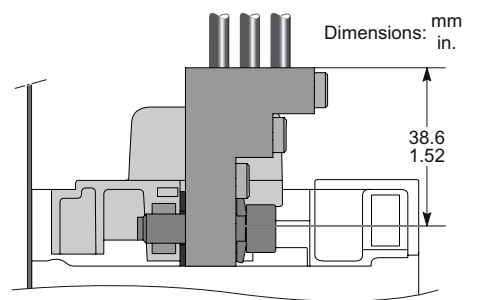

**Spreaders**

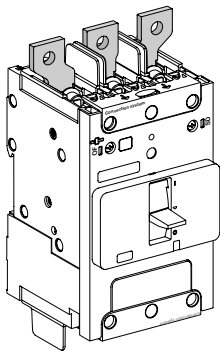

**3P**

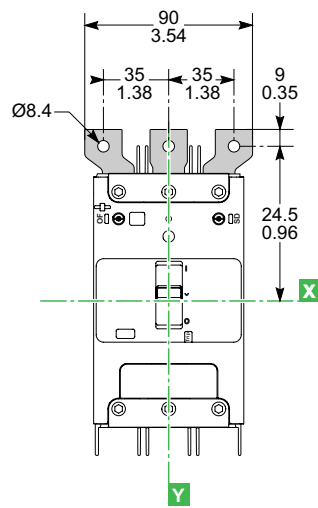

**4P**

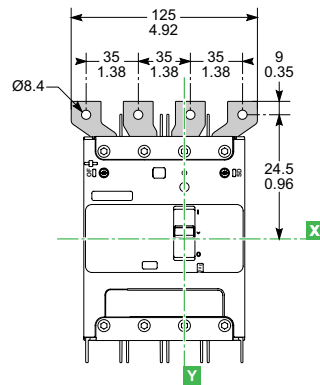

**Side view**

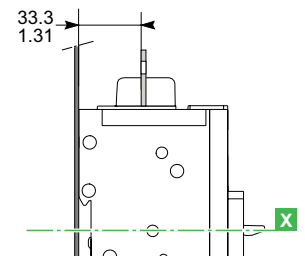

Dimensions: mm  
in.

# Terminal Shield Dimensions

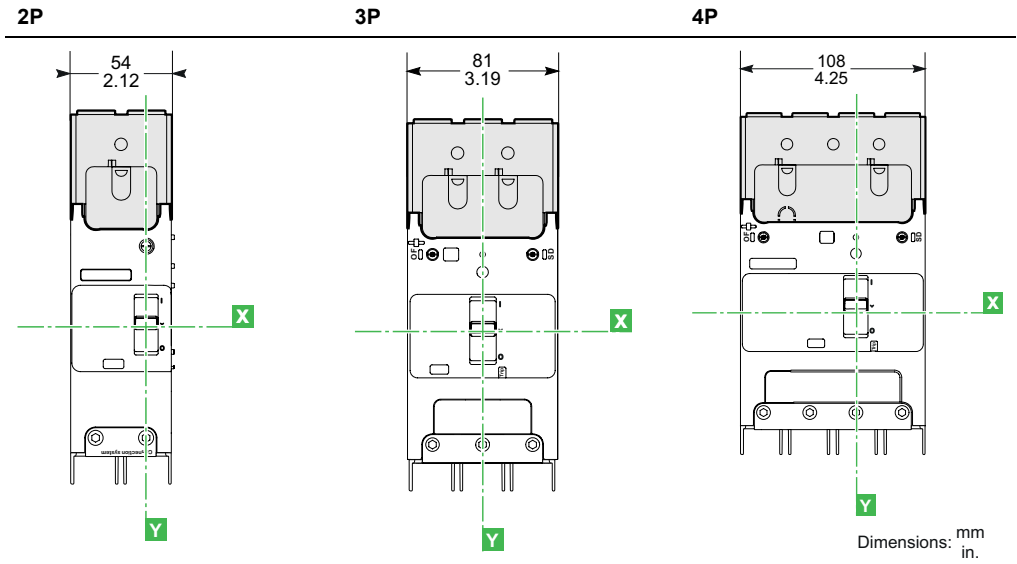
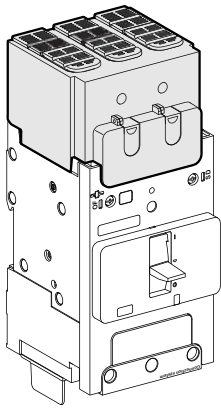

## Side View

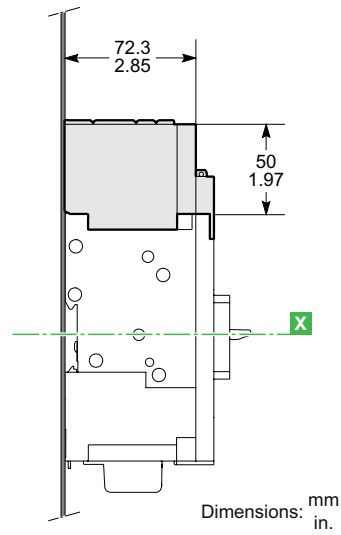

# Interphase Barrier Dimensions

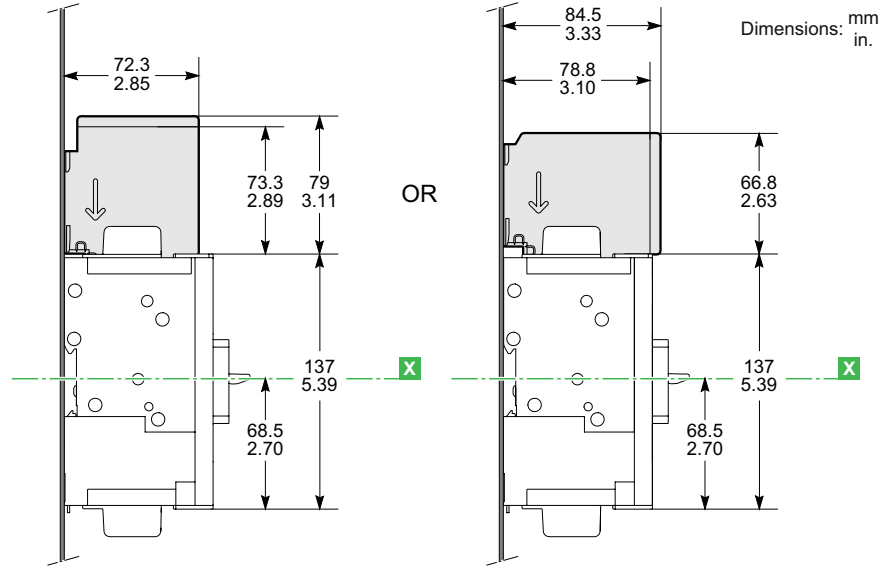
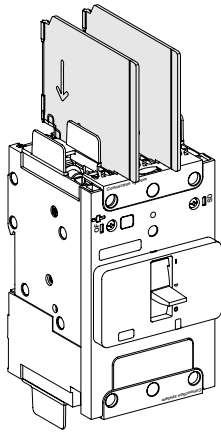

# Insulation Screen Dimensions

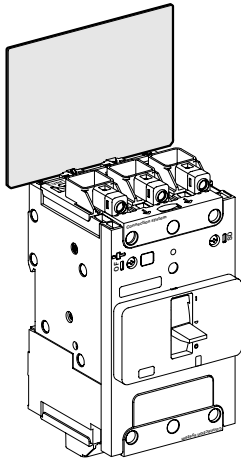

2P

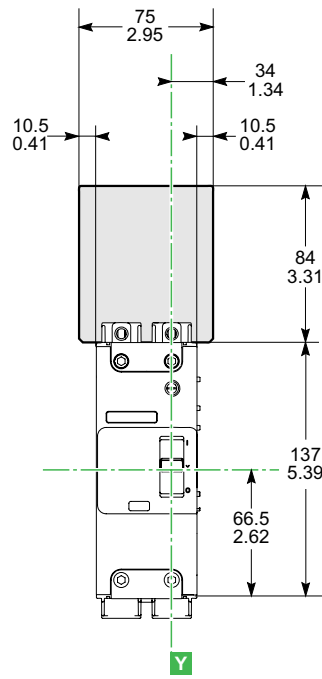

3P

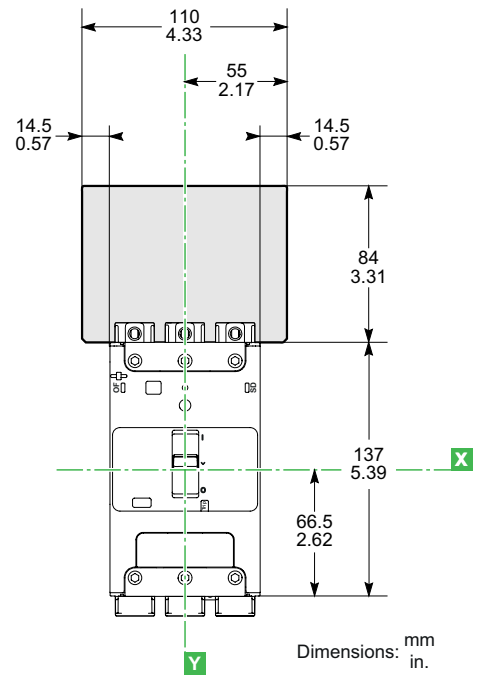

Dimensions: mm  
in.

4P

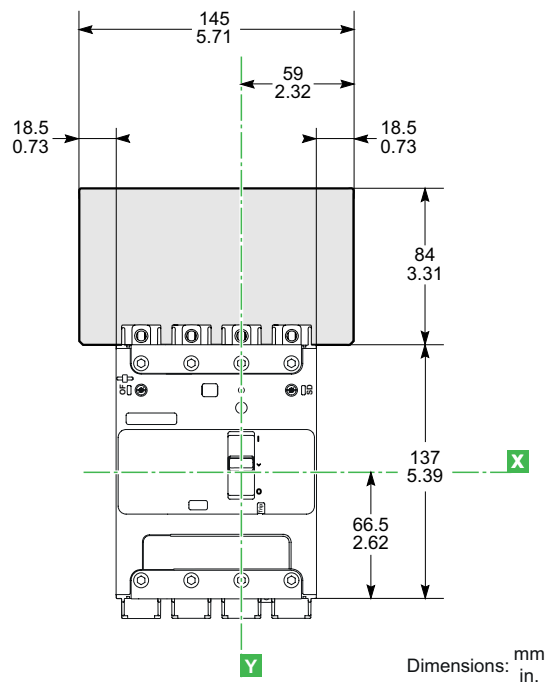

Dimensions: mm  
in.

# Backplate Dimensions

## 1P

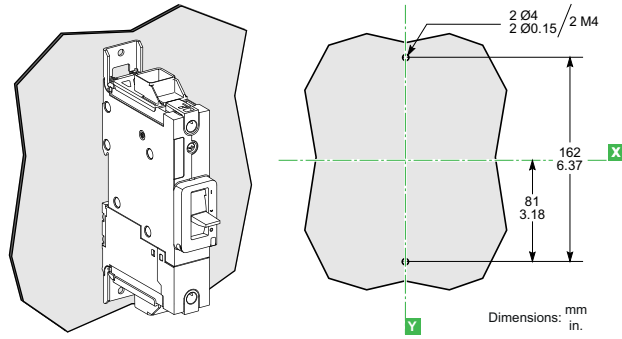

## 2P

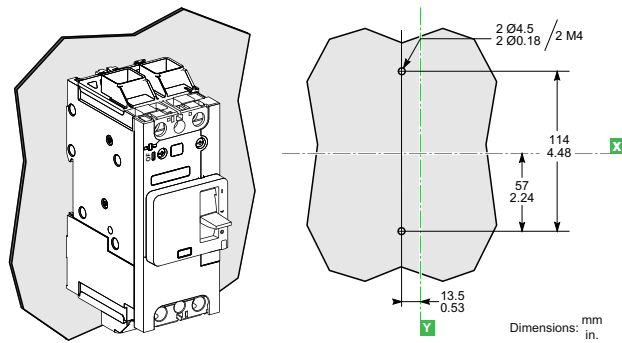

## 3P/4P

## 3P

## 4P

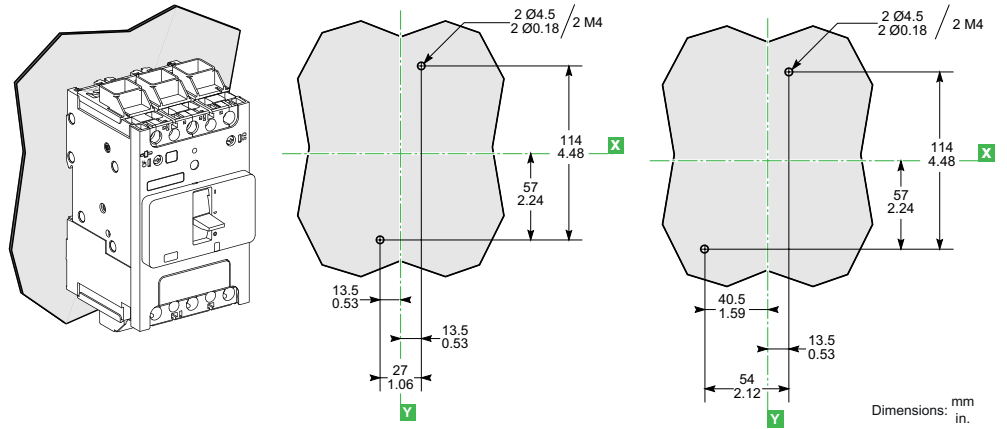

# DIN Rail Dimensions

1P, 2P, 3P, 4P

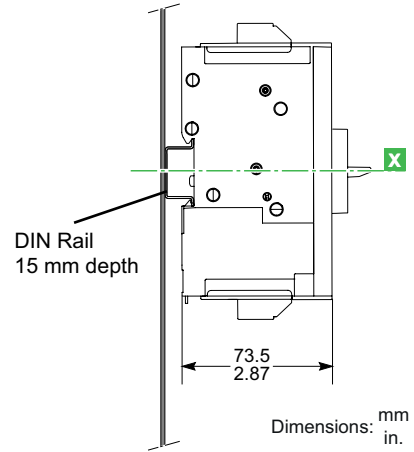
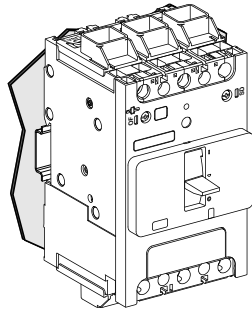

# Direct Rotary Handle Dimensions

3P

4P

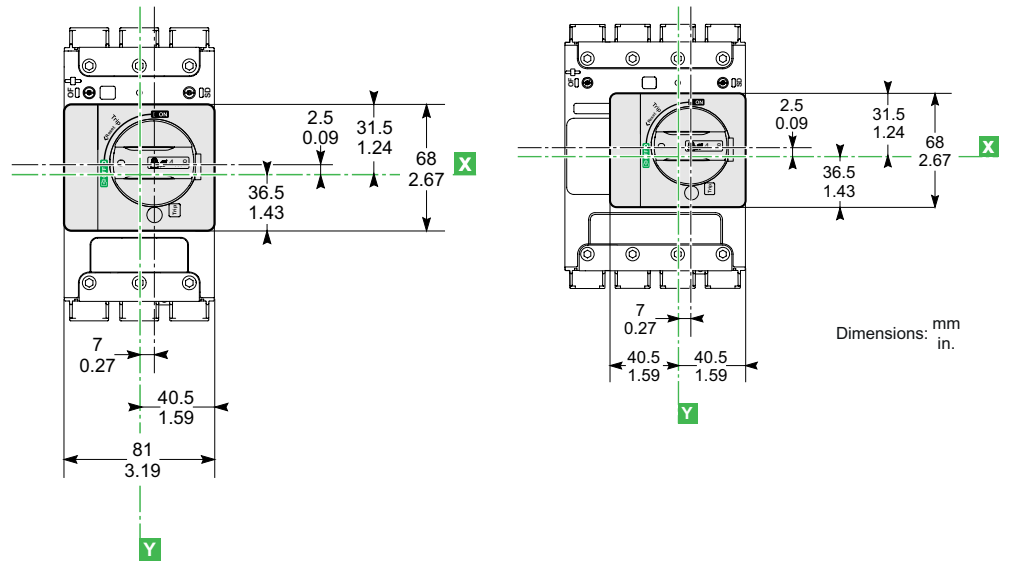

Side View

Door Cutout for 3P/4P

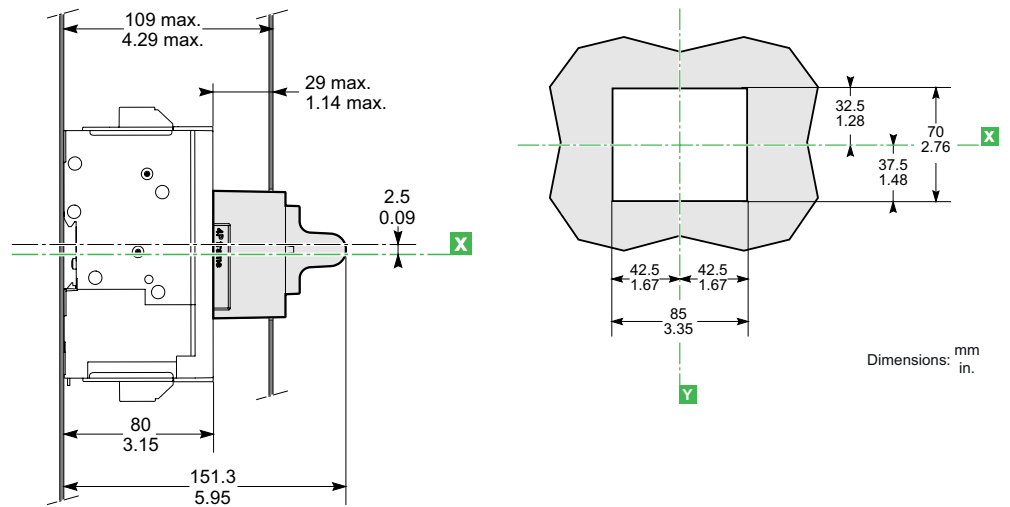

# Extended Rotary Handle

## Extended Rotary Handle Dimensions

3P

4P

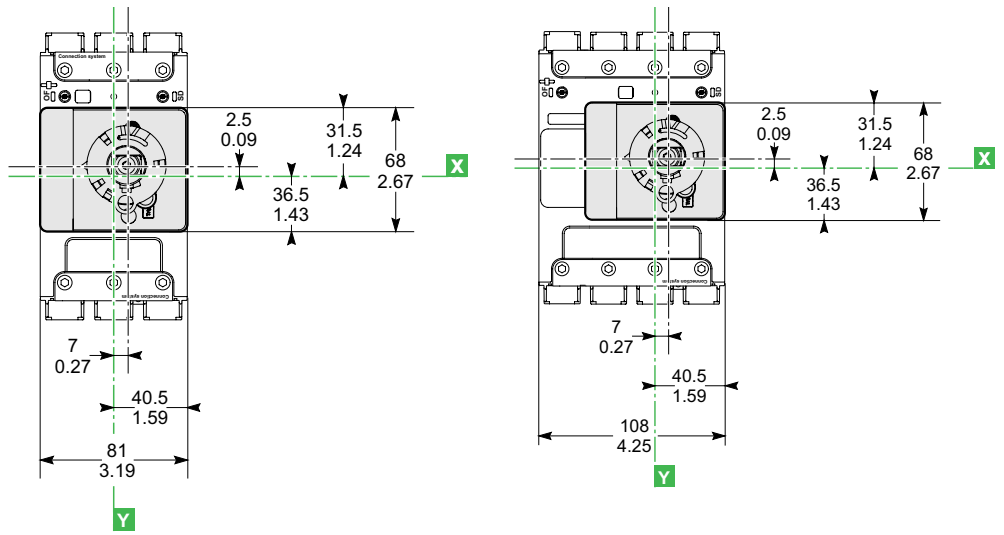

3P/4P

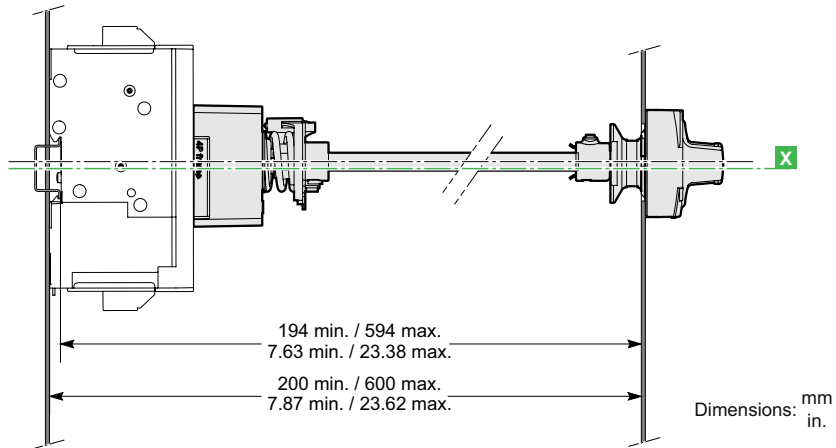

## Front -Panel Cutout Dimensions

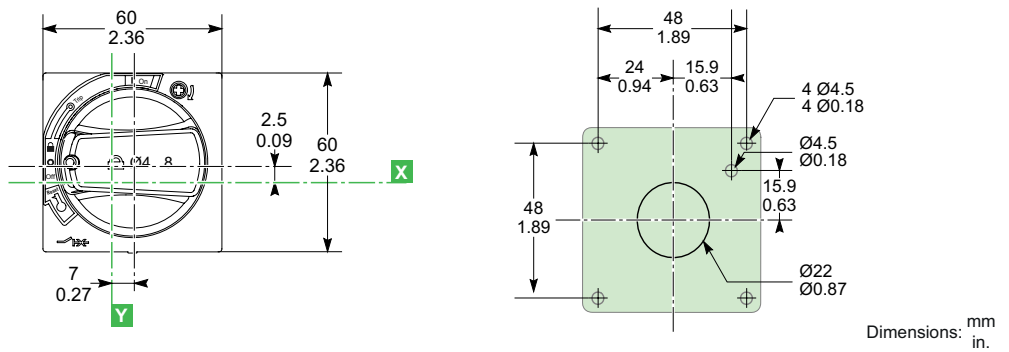



# Side Rotary Handle Dimensions

## 3P

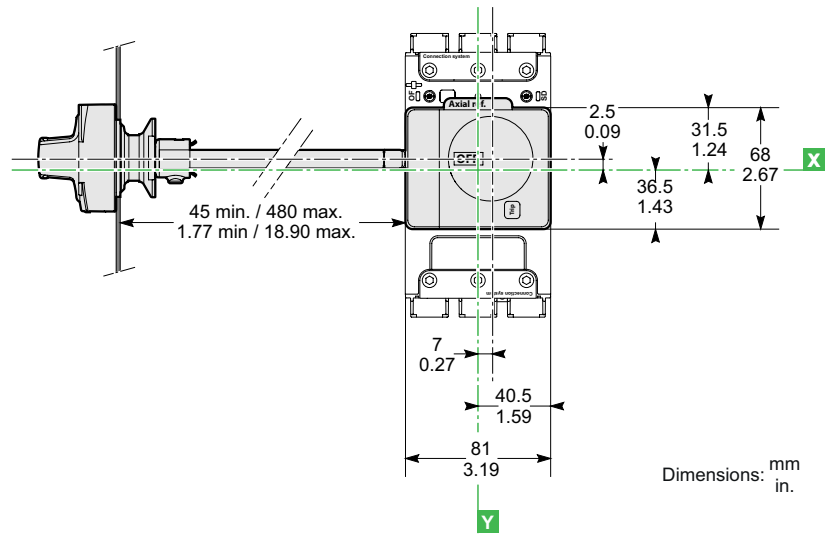

## 4P

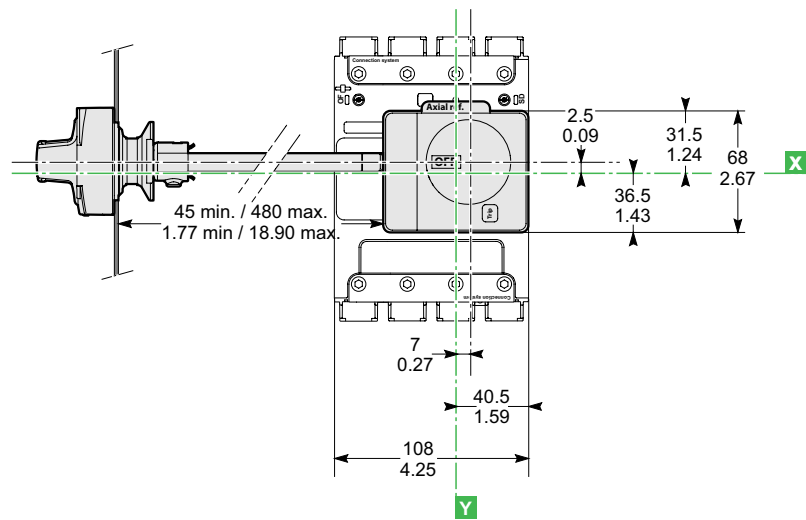

## 3P / 4P

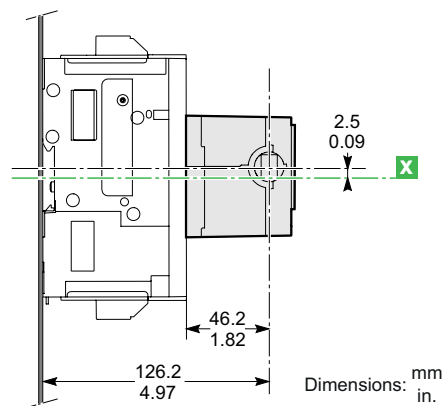

# Door-Mounted Operating Mechanism

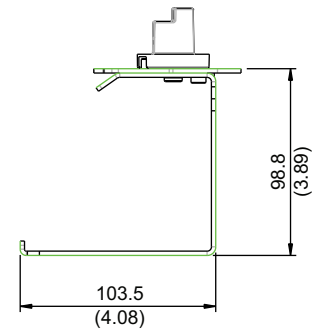
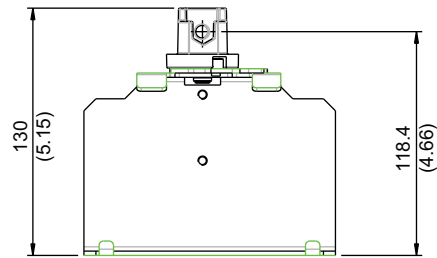
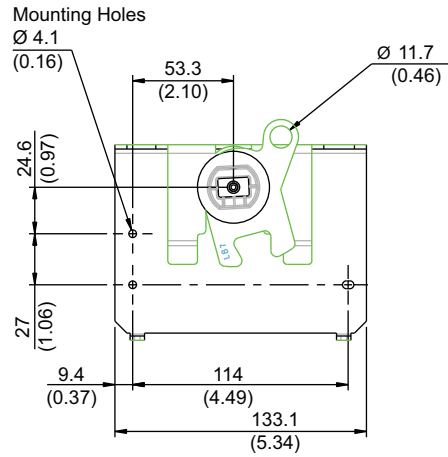

# NEMA 9422 Cable-Operating Mechanism

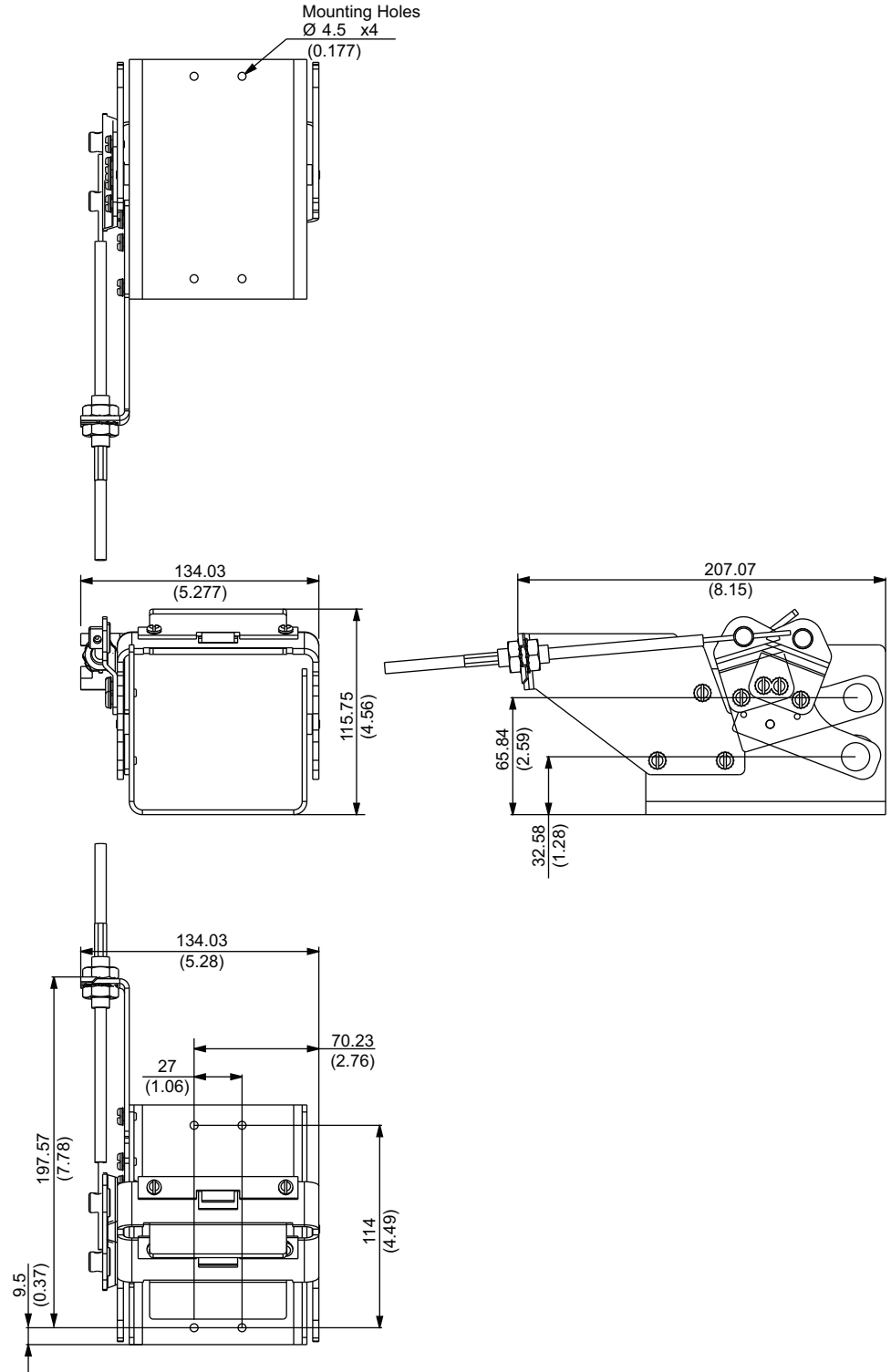

# NEMA 9422 Variable Depth Operating Mechanism

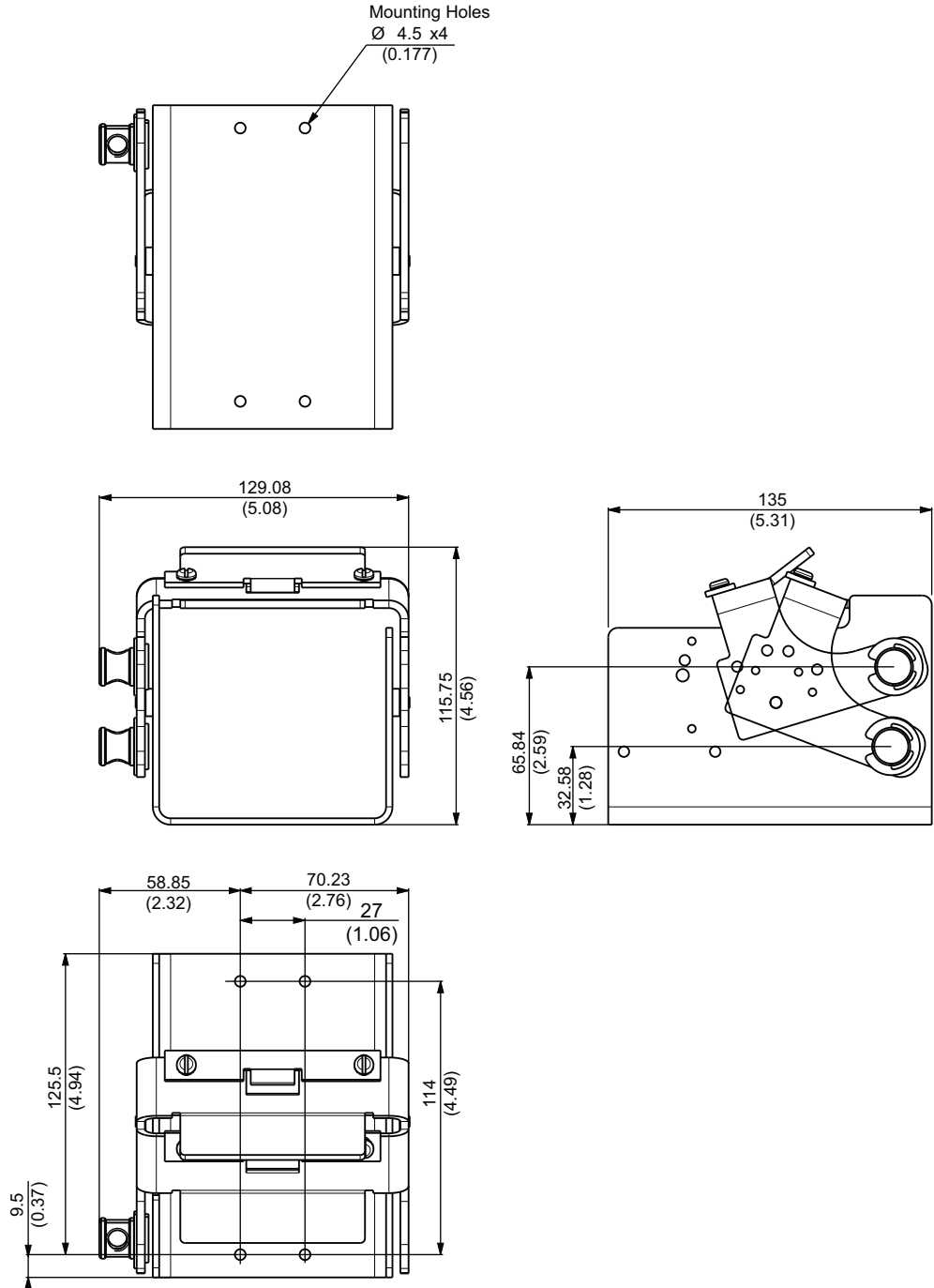

# Wiring Diagrams

## Indication Contacts

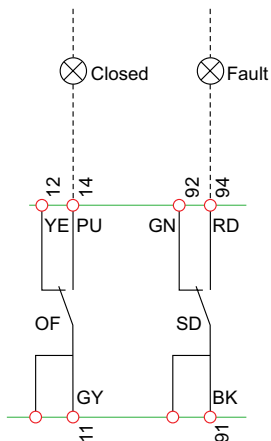

### Indication Contacts

OF	Device ON/OFF indication contacts
SD	Trip indication contact

### Color Code for Auxiliary Wiring

<b>RD:</b>	Red
<b>YE:</b>	Yellow
<b>BK:</b>	Black
<b>GN:</b>	Green
<b>PU:</b>	Purple
<b>GY:</b>	Grey

## Remote Operation (MN/MX Voltage Release)

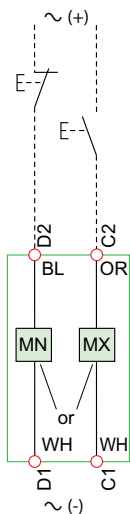

### Remote Operation

MN	Undervoltage Release
or	
MX	Shunt trip Release

### Color code for auxiliary wiring

<b>OR:</b>	Orange
<b>BL:</b>	Blue
<b>WH:</b>	White

# Let-Through Curves and Trip Curves

## PowerPact B-Frame Let-Through Energy Curve

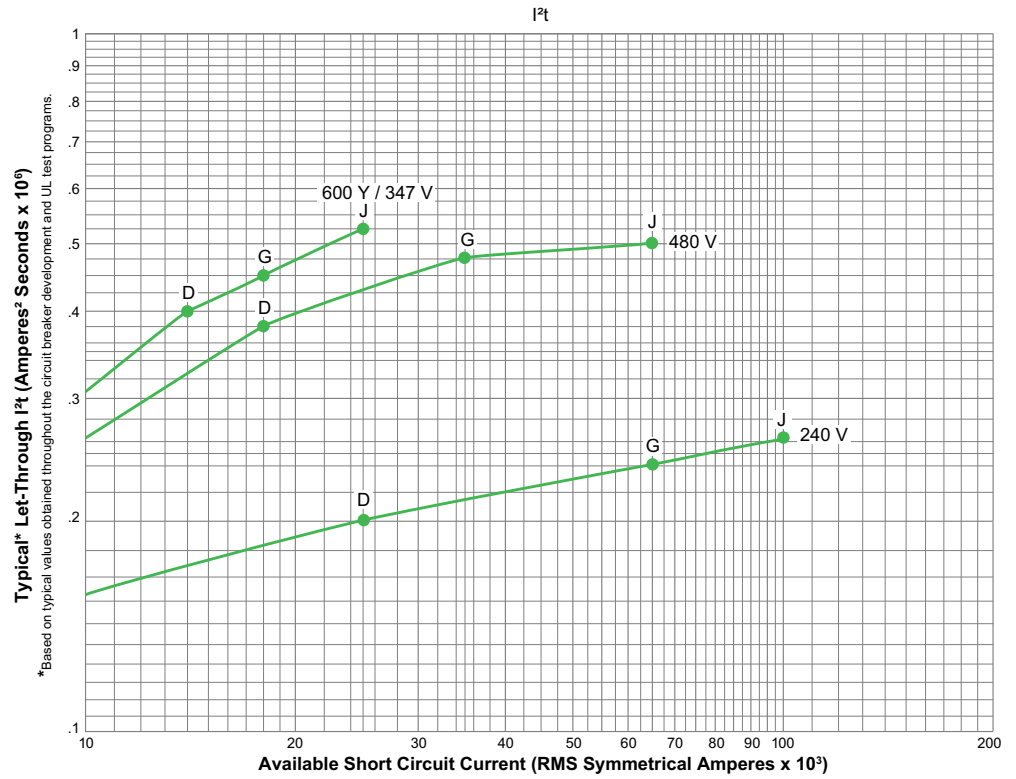

# PowerPact B-Frame Peak Let-Through Current Curve

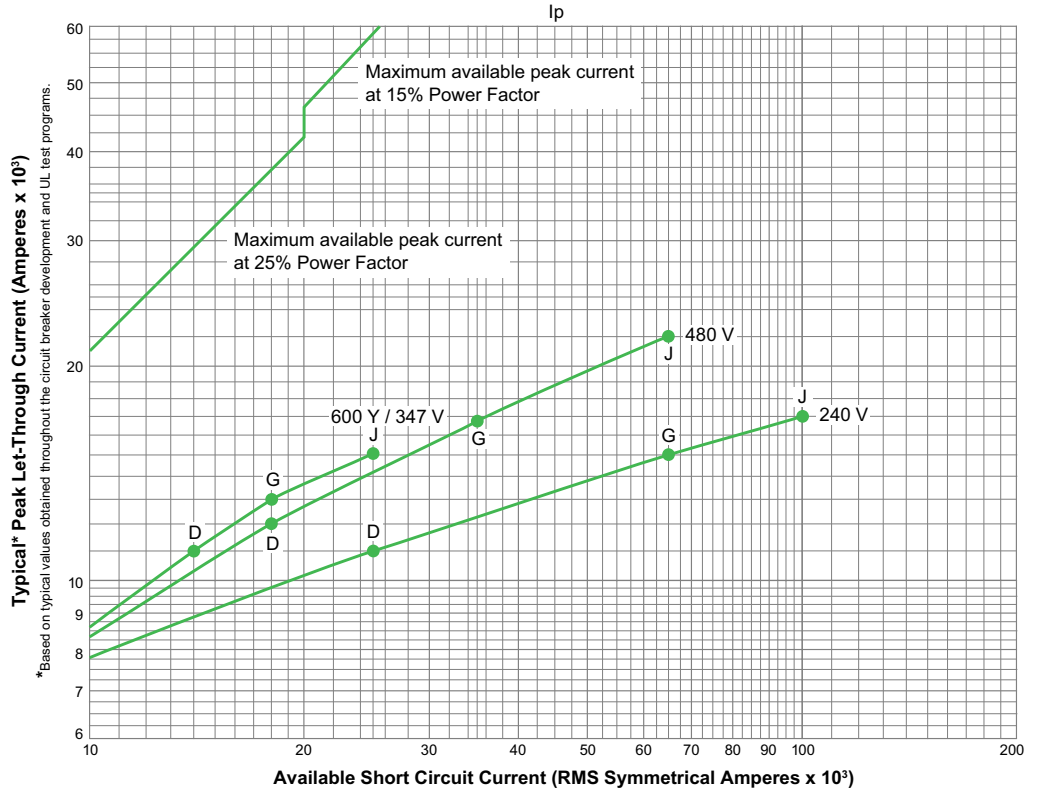

# PowerPact B-Frame 15/20 A Thermal-Magnetic Trip

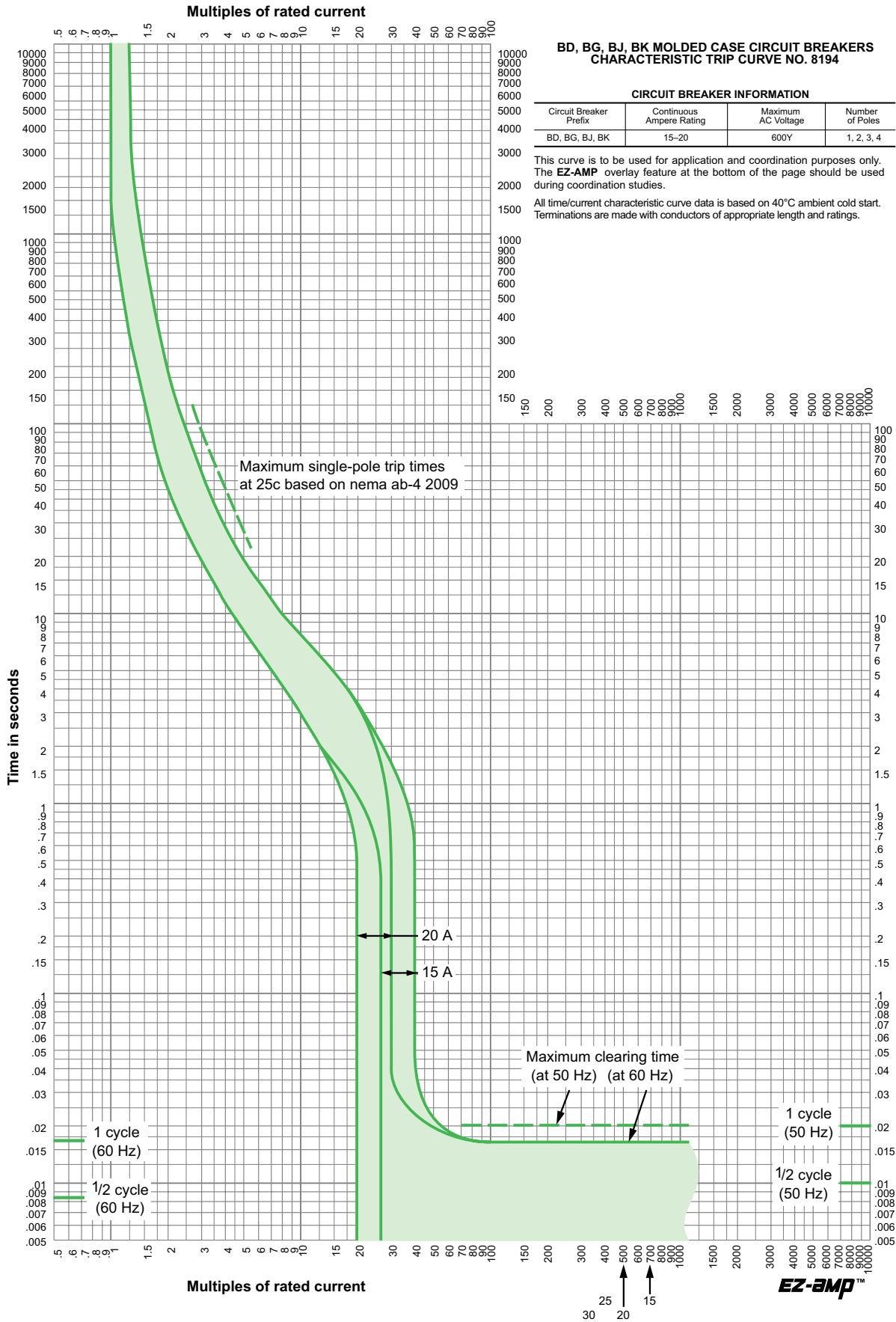



# PowerPact B-Frame 25/30 A Thermal-Magnetic Trip

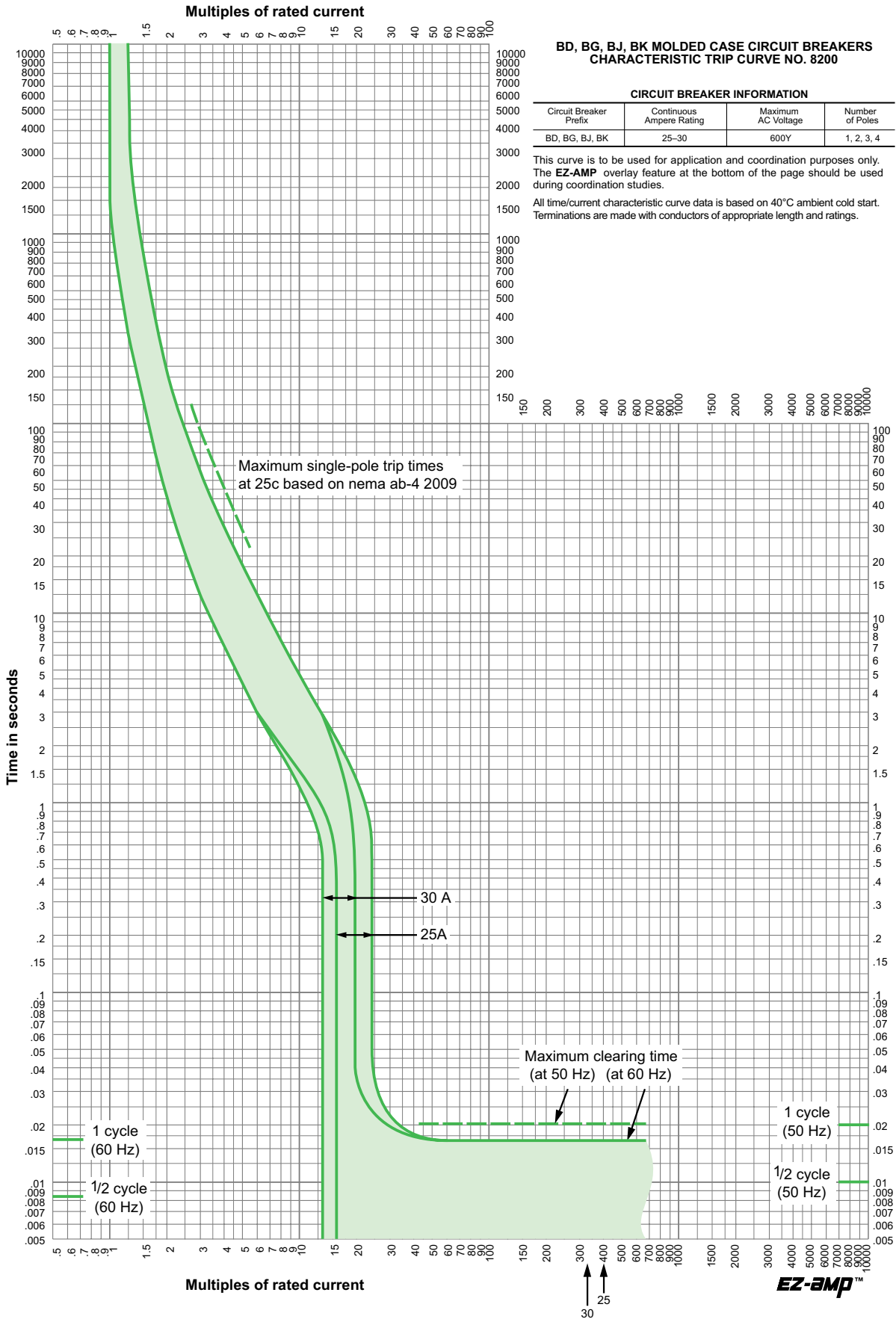

# PowerPact B-Frame 35/50 A Thermal-Magnetic Trip

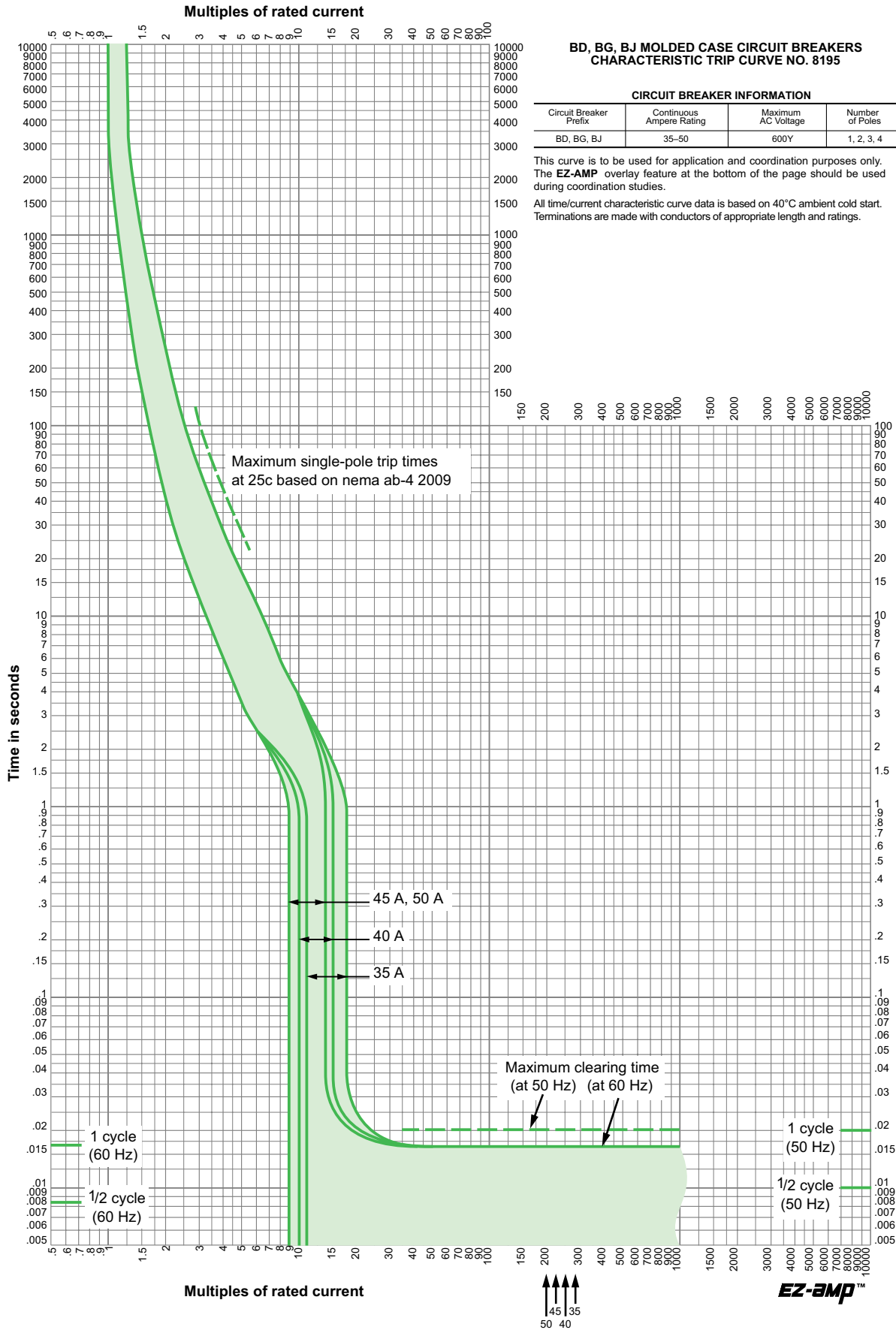

# PowerPact B-Frame 60/100 A Thermal-Magnetic Trip

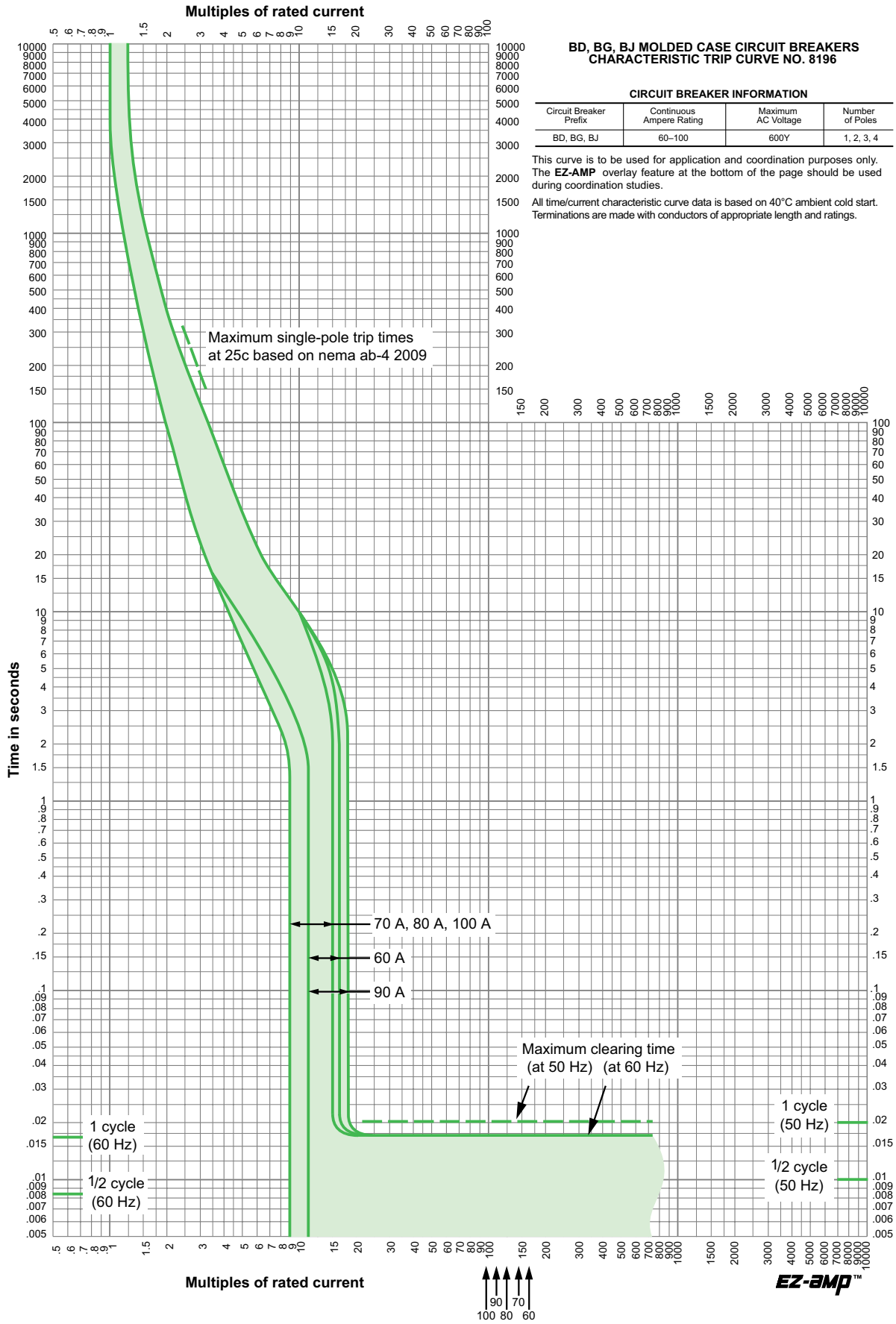

# PowerPact B-Frame 110/125 A Thermal-Magnetic Trip

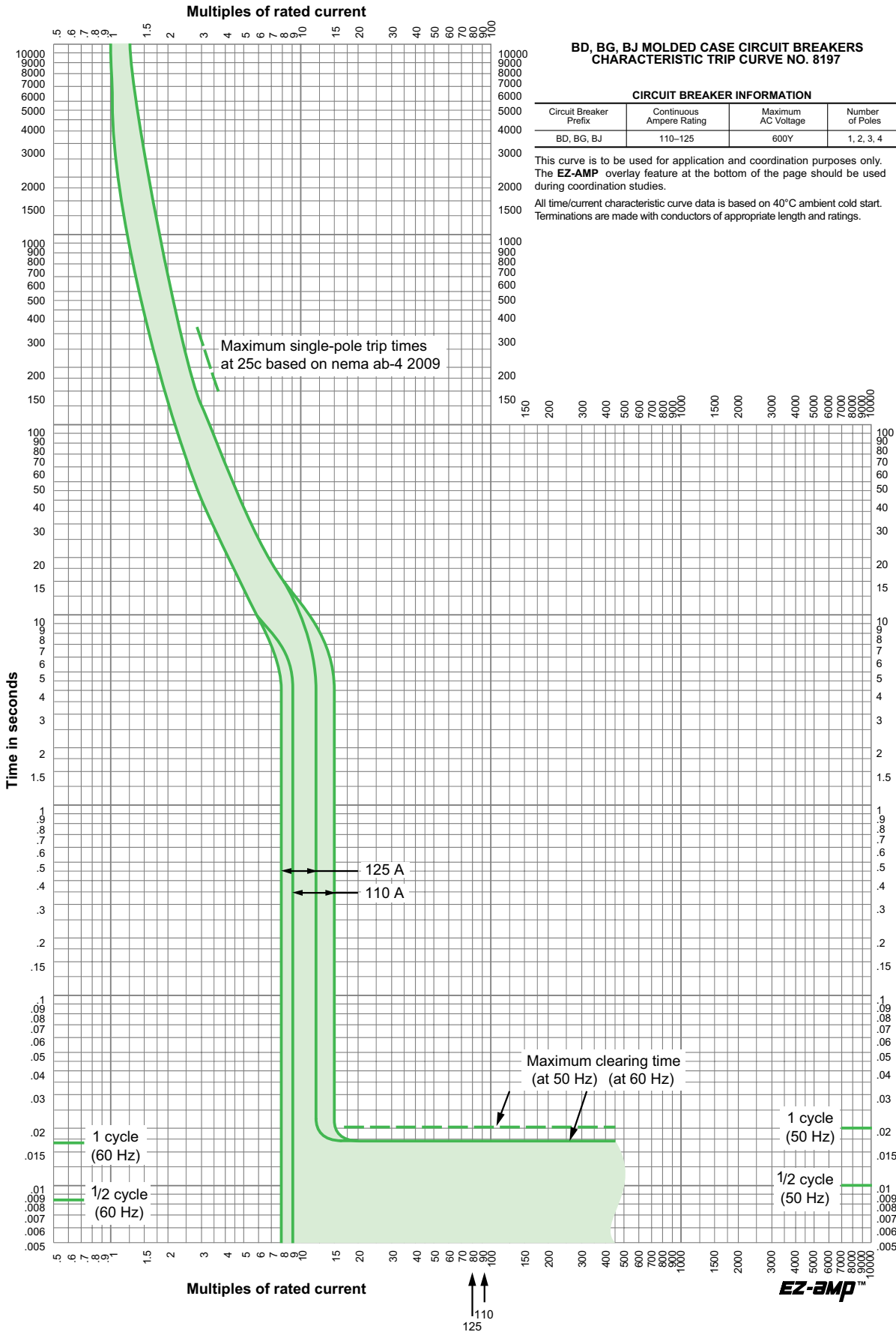

# Distribution System

## Busbar Information

### Plates for Mounting on Busbars

Determining the spacing between busbar supports (LA9ZX01495 and LA9ZX01485), according to IEC 60439-1.<sup>18</sup>

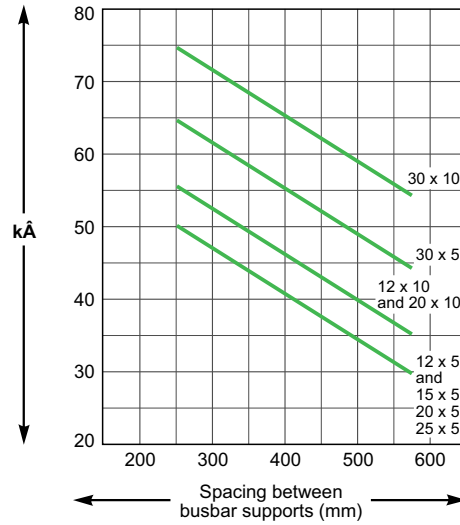

Short-circuit strength diagram according to UL845 (LA9ZX01508).

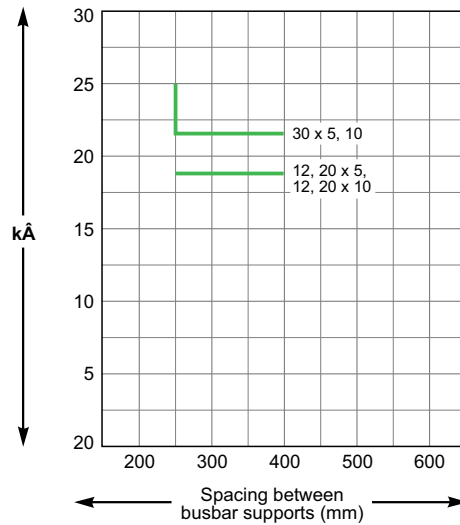

### Load Resistance of Busbar Assemblies in IEC Applications

For an Ambient Temperature of 35°C and a Busbar Temperature of 65°C

Cross Section	mm (in.)	12 x 5 (0.47 x 0.20)	15 x 5 (0.59 x 0.20)	20 x 5 (0.79 x 0.20)	25 x 5 (0.98 x 0.20)	30 x 5 (1.18 x 0.20)	12 x 10 (0.47 x 0.39)	20 x 10 (0.79 x 0.39)	30 x 10 (1.18 x 0.39)
Permissible current	A	200	250	320	400	450	360	520	630

In the event of changes in climatic conditions, the following curve indicates the correction factor K2 to be applied.

18. Depending on the short-circuit current.

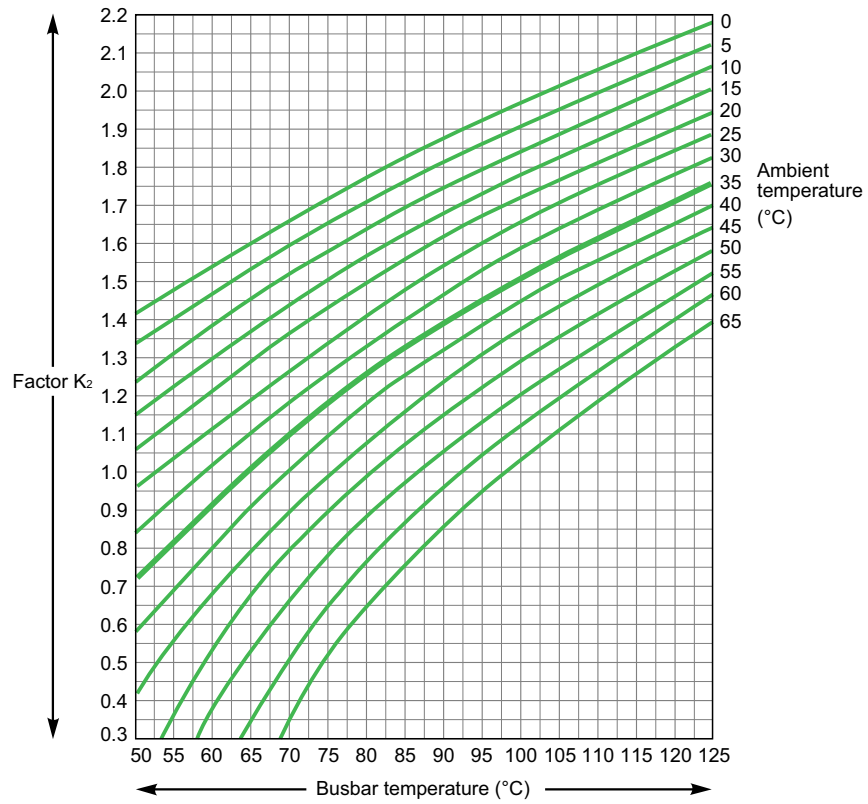

Example: In normal operating conditions, a tinned busbar of 30 x 10 can permanently withstand 630 A.

For a load of 800 A, the correction factor K2 to be applied will be 1.3 (800/630). As a result, the temperature rise in the busbars will reach 82.5°C.

# Catalog Numbers

## PowerPact B-Frame Circuit Breaker Catalog Numbers

### UL 489 Circuit Breaker Ratings

Circuit breaker type		BD		BG		BJ		BK	
Number of poles		1	2-4	1	2-4	1	2-4	1	2
Amperage range (A)		15-125	15-125	15-125	15-125	15-125	15-125	15-30	15-30
UL/CSA/NOM (kA rms)	208Y/120 Vac	25	25	65	65	100	100	100	100
	240 Vac	25	25	65	65	100	100	100	100
	480Y/277 Vac	18	18	35	35	65	65	65	65
	480 Vac	—	18	—	35	—	65	—	65
	600Y/347 Vac	14	14	18	18	25	25	65	65

### PowerPact B-Frame 1P Unit-Mount Single Phase Circuit Breakers

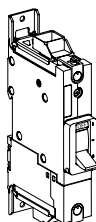

#### B-Frame, 1P, Single Phase Rated, with EverLink™ Connectors, Factory-Sealed Trip Unit (Suitable for Reverse Connection)

Current Rating at 40°C (A)	Fixed AC Magnetic Trip (A)		Interrupting Rating—Standard (80%) Rated		
	Hold	Trip	D	G	J
15	400	600	<b>BDL16015</b>	<b>BGL16015</b>	<b>BJL16015</b>
20	400	600	<b>BDL16020</b>	<b>BGL16020</b>	<b>BJL16020</b>
25	400	600	<b>BDL16025</b>	<b>BGL16025</b>	<b>BJL16025</b>
30	400	600	<b>BDL16030</b>	<b>BGL16030</b>	<b>BJL16030</b>
35	400	600	<b>BDL16035</b>	<b>BGL16035</b>	<b>BJL16035</b>
40	400	600	<b>BDL16040</b>	<b>BGL16040</b>	<b>BJL16040</b>
45	400	600	<b>BDL16045</b>	<b>BGL16045</b>	<b>BJL16045</b>
50	480	720	<b>BDL16050</b>	<b>BGL16050</b>	<b>BJL16050</b>
60	640	960	<b>BDL16060</b>	<b>BGL16060</b>	<b>BJL16060</b>
70	640	960	<b>BDL16070</b>	<b>BGL16070</b>	<b>BJL16070</b>
80	800	1200	<b>BDL16080</b>	<b>BGL16080</b>	<b>BJL16080</b>
90	1000	1500	<b>BDL16090</b>	<b>BGL16090</b>	<b>BJL16090</b>
100	1000	1500	<b>BDL16100</b>	<b>BGL16100</b>	<b>BJL16100</b>
110	1000	1500	<b>BDL16110</b>	<b>BGL16110</b>	<b>BJL16110</b>
125	1000	1500	<b>BDL16125</b>	<b>BGL16125</b>	<b>BJL16125</b>

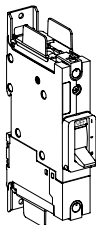

### B-Frame, 1P, Single Phase Rated, with Terminal Nut Connectors, Factory-Sealed Trip Unit (Suitable for Reverse Connection)

Current Rating at 40°C (A)	Fixed AC Magnetic Trip (A)		Interrupting Rating—Standard (80%) Rated		
	Hold	Trip	D	G	J
15	400	600	<b>BDF16015</b>	<b>BGF16015</b>	<b>BJF16015</b>
20	400	600	<b>BDF16020</b>	<b>BGF16020</b>	<b>BJF16020</b>
25	400	600	<b>BDF16025</b>	<b>BGF16025</b>	<b>BJF16025</b>
30	400	600	<b>BDF16030</b>	<b>BGF16030</b>	<b>BJF16030</b>
35	400	600	<b>BDF16035</b>	<b>BGF16035</b>	<b>BJF16035</b>
40	400	600	<b>BDF16040</b>	<b>BGF16040</b>	<b>BJF16040</b>
45	400	600	<b>BDF16045</b>	<b>BGF16045</b>	<b>BJF16045</b>
50	480	720	<b>BDF16050</b>	<b>BGF16050</b>	<b>BJF16050</b>
60	640	960	<b>BDF16060</b>	<b>BGF16060</b>	<b>BJF16060</b>
70	640	960	<b>BDF16070</b>	<b>BGF16070</b>	<b>BJF16070</b>
80	800	1200	<b>BDF16080</b>	<b>BGF16080</b>	<b>BJF16080</b>
90	1000	1500	<b>BDF16090</b>	<b>BGF16090</b>	<b>BJF16090</b>
100	1000	1500	<b>BDF16100</b>	<b>BGF16100</b>	<b>BJF16100</b>
110	1000	1500	<b>BDF16110</b>	<b>BGF16110</b>	<b>BJF16110</b>
125	1000	1500	<b>BDF16125</b>	<b>BGF16125</b>	<b>BJF16125</b>



## PowerPact B-Frame 1P I-Line Single Phase Circuit Breakers

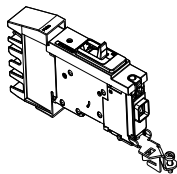

**B-Frame, 1P, Single Phase Rated, with OFF-End AI Mechanical Lugs, Factory-Sealed Trip Unit (Suitable for Reverse Connection)**

Current Rating at 40°C (A)	Fixed AC Magnetic Trip (A)		Interrupting Rating—Standard (80%) Rated <sup>19</sup>			
	Hold	Trip	D	G	J	K
15	400	600	BDA16015( )	BGA16015( )	BJA16015( )	BKA16015( )
20	400	600	BDA16020( )	BGA16020( )	BJA16020( )	BKA16020( )
25	400	600	BDA16025( )	BGA16025( )	BJA16025( )	BKA16025( )
30	400	600	BDA16030( )	BGA16030( )	BJA16030( )	BKA16030( )
35	400	600	BDA16035( )	BGA16035( )	BJA16035( )	—
40	400	600	BDA16040( )	BGA16040( )	BJA16040( )	—
45	400	600	BDA16045( )	BGA16045( )	BJA16045( )	—
50	480	720	BDA16050( )	BGA16050( )	BJA16050( )	—
60	640	960	BDA16060( )	BGA16060( )	BJA16060( )	—
70	640	960	BDA16070( )	BGA16070( )	BJA16070( )	—
80	800	1200	BDA16080( )	BGA16080( )	BJA16080( )	—
90	1000	1500	BDA16090( )	BGA16090( )	BJA16090( )	—
100	1000	1500	BDA16100( )	BGA16100( )	BJA16100( )	—
110	1000	1500	BDA16110( )	BGA16110( )	BJA16110( )	—
125	1000	1500	BDA16125( )	BGA16125( )	BJA16125( )	—

19. For 1P/2P I-Line breakers, phasing suffix must be added. See *Table Phase Option Examples*, page 22.

## PowerPact B-Frame 2P Unit-Mount Circuit Breakers

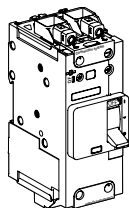

### B-Frame, 2P, with EverLink™ Connectors, Factory-Sealed Trip Unit (Suitable for Reverse Connection)

Current Rating at 40°C (A)	Fixed AC Magnetic Trip (A)		Interrupting Rating—Standard (80%) Rated		
	Hold	Trip	D	G	J
15	400	600	BDL26015	BGL26015	BJL26015
20	400	600	BDL26020	BGL26020	BJL26020
25	400	600	BDL26025	BGL26025	BJL26025
30	400	600	BDL26030	BGL26030	BJL26030
35	400	600	BDL26035	BGL26035	BJL26035
40	400	600	BDL26040	BGL26040	BJL26040
45	400	600	BDL26045	BGL26045	BJL26045
50	480	720	BDL26050	BGL26050	BJL26050
60	640	960	BDL26060	BGL26060	BJL26060
70	640	960	BDL26070	BGL26070	BJL26070
80	800	1200	BDL26080	BGL26080	BJL26080
90	1000	1500	BDL26090	BGL26090	BJL26090
100	1000	1500	BDL26100	BGL26100	BJL26100
110	1000	1500	BDL26110	BGL26110	BJL26110
125	1000	1500	BDL26125	BGL26125	BJL26125

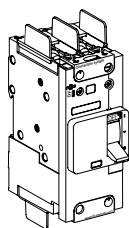

### B-Frame, 2P, with Terminal Nut Connectors, Factory-Sealed Trip Unit (Suitable for Reverse Connection)

Current Rating at 40°C (A)	Fixed AC Magnetic Trip (A)		Interrupting Rating—Standard (80%) Rated		
	Hold	Trip	D	G	J
15	400	600	BDF26015	BGF26015	BJF26015
20	400	600	BDF26020	BGF26020	BJF26020
25	400	600	BDF26025	BGF26025	BJF26025
30	400	600	BDF26030	BGF26030	BJF26030
35	400	600	BDF26035	BGF26035	BJF26035
40	400	600	BDF26040	BGF26040	BJF26040
45	400	600	BDF26045	BGF26045	BJF26045
50	480	720	BDF26050	BGF26050	BJF26050
60	640	960	BDF26060	BGF26060	BJF26060
70	640	960	BDF26070	BGF26070	BJF26070
80	800	1200	BDF26080	BGF26080	BJF26080
90	1000	1500	BDF26090	BGF26090	BJF26090
100	1000	1500	BDF26100	BGF26100	BJF26100
110	1000	1500	BDF26110	BGF26110	BJF26110
125	1000	1500	BDF26125	BGF26125	BJF26125

**PowerPact B-Frame 2P I-Line Circuit Breakers**

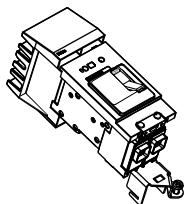

**B-Frame, 2P, with OFF-End AI Mechanical Lugs, Factory-Sealed Trip Unit  
(Suitable for Reverse Connection)**

Current Rating at 40°C (A)	Fixed AC Magnetic Trip (A)		Interrupting Rating—Standard (80%) Rated <sup>20</sup>		
	Hold	Trip	D	G	J
15	400	600	BDA26015( )	BGA26015( )	BJA26015( )
20	400	600	BDA26020( )	BGA26020( )	BJA26020( )
25	400	600	BDA26025( )	BGA26025( )	BJA26025( )
30	400	600	BDA26030( )	BGA26030( )	BJA26030( )
35	400	600	BDA26035( )	BGA26035( )	BJA26035( )
40	400	600	BDA26040( )	BGA26040( )	BJA26040( )
45	400	600	BDA26045( )	BGA26045( )	BJA26045( )
50	480	720	BDA26050( )	BGA26050( )	BJA26050( )
60	640	960	BDA26060( )	BGA26060( )	BJA26060( )
70	640	960	BDA26070( )	BGA26070( )	BJA26070( )
80	800	1200	BDA26080( )	BGA26080( )	BJA26080( )
90	1000	1500	BDA26090( )	BGA26090( )	BJA26090( )
100	1000	1500	BDA26100( )	BGA26100( )	BJA26100( )
110	1000	1500	BDA26110( )	BGA26110( )	BJA26110( )
125	1000	1500	BDA26125( )	BGA26125( )	BJA26125( )

20. For 1P/2P I-Line breakers, phasing suffix must be added. See *Table Phase Option Examples*, page 22.

## PowerPact B-Frame 3P Unit-Mount Circuit Breakers

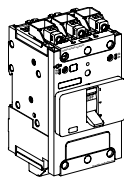

**B-Frame, 3P, with EverLink™ Connectors, Factory-Sealed Trip Unit (Suitable for Reverse Connection)**

Current Rating at 40°C (A)	Fixed AC Magnetic Trip (A)		Interrupting Rating—Standard (80%) Rated		
	Hold	Trip	D	G	J
15	400	600	BDL36015	BGL36015	BJL36015
20	400	600	BDL36020	BGL36020	BJL36020
25	400	600	BDL36025	BGL36025	BJL36025
30	400	600	BDL36030	BGL36030	BJL36030
35	400	600	BDL36035	BGL36035	BJL36035
40	400	600	BDL36040	BGL36040	BJL36040
45	400	600	BDL36045	BGL36045	BJL36045
50	480	720	BDL36050	BGL36050	BJL36050
60	640	960	BDL36060	BGL36060	BJL36060
70	640	960	BDL36070	BGL36070	BJL36070
80	800	1200	BDL36080	BGL36080	BJL36080
90	1000	1500	BDL36090	BGL36090	BJL36090
100	1000	1500	BDL36100	BGL36100	BJL36100
110	1000	1500	BDL36110	BGL36110	BJL36110
125	1000	1500	BDL36125	BGL36125	BJL36125

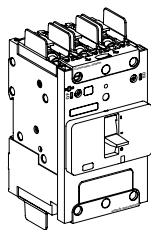

**B-Frame, 3P, with Terminal Nut Connectors, Factory-Sealed Trip Unit (Suitable for Reverse Connection)**

Current Rating at 40°C (A)	Fixed AC Magnetic Trip (A)		Interrupting Rating—Standard (80%) Rated		
	Hold	Trip	D	G	J
15	400	600	BDF36015	BGF36015	BJF36015
20	400	600	BDF36020	BGF36020	BJF36020
25	400	600	BDF36025	BGF36025	BJF36025
30	400	600	BDF36030	BGF36030	BJF36030
35	400	600	BDF36035	BGF36035	BJF36035
40	400	600	BDF36040	BGF36040	BJF36040
45	400	600	BDF36045	BGF36045	BJF36045
50	480	720	BDF36050	BGF36050	BJF36050
60	640	960	BDF36060	BGF36060	BJF36060
70	640	960	BDF36070	BGF36070	BJF36070
80	800	1200	BDF36080	BGF36080	BJF36080
90	1000	1500	BDF36090	BGF36090	BJF36090
100	1000	1500	BDF36100	BGF36100	BJF36100
110	1000	1500	BDF36110	BGF36110	BJF36110
125	1000	1500	BDF36125	BGF36125	BJF36125

### PowerPact B-Frame 3P I-Line Circuit Breakers

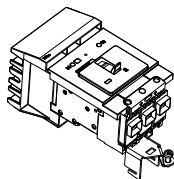

**B-Frame, 3P, with OFF-End AI Mechanical Lugs, Factory-Sealed Trip Unit (Suitable for Reverse Connection)**

Current Rating at 40°C (A)	Fixed AC Magnetic Trip (A)		Interrupting Rating—Standard (80%) Rated		
	Hold	Trip	D	G	J
15	400	600	BDA36015	BGA36015	BJA36015
20	400	600	BDA36020	BGA36020	BJA36020
25	400	600	BDA36025	BGA36025	BJA36025
30	400	600	BDA36030	BGA36030	BJA36030
35	400	600	BDA36035	BGA36035	BJA36035
40	400	600	BDA36040	BGA36040	BJA36040
45	400	600	BDA36045	BGA36045	BJA36045
50	480	720	BDA36050	BGA36050	BJA36050
60	640	960	BDA36060	BGA36060	BJA36060
70	640	960	BDA36070	BGA36070	BJA36070
80	800	1200	BDA36080	BGA26080	BJA36080
90	1000	1500	BDA36090	BGA36090	BJA36090
100	1000	1500	BDA36100	BGA36100	BJA36100
110	1000	1500	BDA36110	BGA36110	BJA36110
125	1000	1500	BDA36125	BGA36125	BJA36125

### PowerPact B-Frame 4P Unit-Mount Circuit Breakers

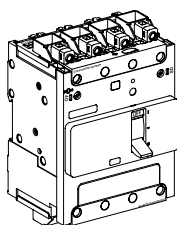

**B-Frame, 4P, with EverLink™ Connectors, Factory-Sealed Trip Unit (Suitable for Reverse Connection)**

Current Rating at 40°C (A)	Fixed AC Magnetic Trip (A)		Interrupting Rating—Standard (80%) Rated		
	Hold	Trip	D	G	J
15	400	600	BDL46015	BGL46015	BJL46015
20	400	600	BDL46020	BGL46020	BJL46020
25	400	600	BDL46025	BGL46025	BJL46025
30	400	600	BDL46030	BGL46030	BJL46030
35	400	600	BDL46035	BGL46035	BJL46035
40	400	600	BDL46040	BGL46040	BJL46040
45	400	600	BDL46045	BGL46045	BJL46045
50	480	720	BDL46050	BGL46050	BJL46050
60	640	960	BDL46060	BGL46060	BJL46060
70	640	960	BDL46070	BGL46070	BJL46070
80	800	1200	BDL46080	BGL46080	BJL46080
90	1000	1500	BDL46090	BGL46090	BJL46090
100	1000	1500	BDL46100	BGL46100	BJL46100
110	1000	1500	BDL46110	BGL46110	BJL46110
125	1000	1500	BDL46125	BGL46125	BJL46125

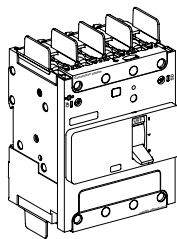

### B-Frame, 4P, with Terminal Nut Connectors, Factory-Sealed Trip Unit (Suitable for Reverse Connection)

Current Rating at 40°C (A)	Fixed AC Magnetic Trip (A)		Interrupting Rating—Standard (80%) Rated		
	Hold	Trip	D	G	J
15	400	600	<b>BDF46015</b>	<b>BGF46015</b>	<b>BJF46015</b>
20	400	600	<b>BDF46020</b>	<b>BGF46020</b>	<b>BJF46020</b>
25	400	600	<b>BDF46025</b>	<b>BGF46025</b>	<b>BJF46025</b>
30	400	600	<b>BDF46030</b>	<b>BGF46030</b>	<b>BJF46030</b>
35	400	600	<b>BDF46035</b>	<b>BGF46035</b>	<b>BJF46035</b>
40	400	600	<b>BDF46040</b>	<b>BGF46040</b>	<b>BJF46040</b>
45	400	600	<b>BDF46045</b>	<b>BGF46045</b>	<b>BJF46045</b>
50	480	720	<b>BDF46050</b>	<b>BGF46050</b>	<b>BJF46050</b>
60	640	960	<b>BDF46060</b>	<b>BGF46060</b>	<b>BJF46060</b>
70	640	960	<b>BDF46070</b>	<b>BGF46070</b>	<b>BJF46070</b>
80	800	1200	<b>BDF46080</b>	<b>BGF46080</b>	<b>BJF46080</b>
90	1000	1500	<b>BDF46090</b>	<b>BGF46090</b>	<b>BJF46090</b>
100	1000	1500	<b>BDF46100</b>	<b>BGF46100</b>	<b>BJF46100</b>
110	1000	1500	<b>BDF46110</b>	<b>BGF46110</b>	<b>BJF46110</b>
125	1000	1500	<b>BDF46125</b>	<b>BGF46125</b>	<b>BJF46125</b>

## PowerPact B-Frame Switches

### PowerPact B-Frame Automatic Molded Case Switches with EverLink Connectors

Withstand Rating	Poles	Catalog Number	Trip Point
D Withstand	2	BDL26000S12	1625 A
	3	BDL36000S12	1625 A
G Withstand	2	BGL26000S12	1625 A
	3	BGL36000S12	1625 A
J Withstand	2	BJL26000S12	1625 A
	3	BJL36000S12	1625 A

# Electrical Accessories

## Auxiliary Contacts

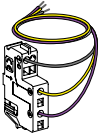
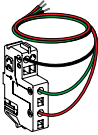
Auxiliary Contact		Catalog Number
	Standard OF or SD	<b>LV426950</b>
	Pre-wired OF	<b>LV426951</b>
	Pre-wired SD	<b>LV426952</b>

## Voltage Releases

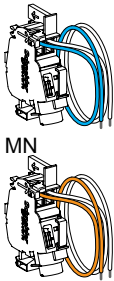
Voltage Release		Catalog Number			
	Standard	Voltage	MX	MN	
	AC	24 Vac 50/60 Hz	<b>LV426841</b>	<b>LV426801</b>	
		48 Vac 50/60 Hz	<b>LV426842</b>	<b>LV426802</b>	
		110–130 Vac 50/60 Hz	<b>LV426843</b>	<b>LV426803</b>	
		208–240 Vac 50/60 Hz	<b>LV426844</b>	<b>LV426804</b>	
		277 Vac 60 Hz	<b>LV426844</b>	<b>LV426805</b>	
		380–415 Vac 50 Hz	<b>LV426846</b>	<b>LV426806</b>	
		440–480 Vac 60 Hz	<b>LV426846</b>	<b>LV426807</b>	
	DC	24 Vdc	<b>LV426841</b>	<b>LV426801</b>	
		48 Vdc	<b>LV426842</b>	<b>LV426802</b>	
		125 Vdc	<b>LV426843</b>	<b>LV426803</b>	
		250 Vdc	<b>LV426844</b>	<b>LV426815</b>	
	 MN MX	Pre-wired	Voltage	MX	MN
		AC	24 Vac 50/60 Hz	<b>LV426861</b>	<b>LV426821</b>
48 Vac 50/60 Hz			<b>LV426862</b>	<b>LV426822</b>	
110–130 Vac 50/60 Hz			<b>LV426863</b>	<b>LV426823</b>	
208–240 Vac 50/60 Hz			<b>LV426864</b>	<b>LV426824</b>	
277 Vac 60 Hz			<b>LV426864</b>	<b>LV426825</b>	
380–415 Vac 50 Hz			<b>LV426866</b>	<b>LV426826</b>	
440–480 Vac 60 Hz			<b>LV426866</b>	<b>LV426827</b>	
DC		24 Vdc	<b>LV426861</b>	<b>LV426821</b>	
		48 Vdc	<b>LV426862</b>	<b>LV426822</b>	
		125 Vdc	<b>LV426863</b>	<b>LV426823</b>	
		250 Vdc	<b>LV426864</b>	<b>LV426835</b>	





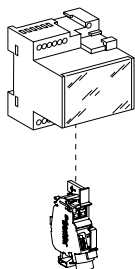

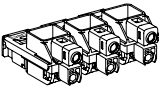
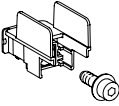

**Time Delay Unit for Undervoltage Release (MN)**

Time Delay Unit		Catalog Number
<b>MN 48 Vac 50/60 Hz with Fixed Time Delay</b>		
Composed of:	MN 48 Vac	<b>LV426802</b>
	Delay Unit 48 Vac 50/60 Hz	<b>LV429426</b>
<b>MN 220-240 Vac 50/60 Hz with Fixed Time Delay</b>		
Composed of:	MN 220/240 Vac	<b>LV426804</b>
	Delay Unit 220-240 Vac 50/60 Hz	<b>LV429427</b>
<b>MN 48 Vac/Vdc 50/60 Hz with Adjustable Time Delay (<math>\geq 200</math> ms)</b>		
Composed of:	MN 48 Vdc	<b>LV426802</b>
	Delay Unit 48 Vac/Vdc 50/60 Hz	<b>S33680</b>
<b>MN 110-130 Vac/Vdc 50/60 Hz with Adjustable Time Delay (<math>\geq 200</math> ms)</b>		
Composed of:	MN 125 Vdc	<b>LV426803</b>
	Delay Unit 100-130 Vac/Vdc 50/60 Hz	<b>S33681</b>
<b>MN 220-250 Vac/Vdc 50/60 Hz with Adjustable Time Delay (<math>\geq 200</math> ms)</b>		
Composed of:	MN 250 Vdc	<b>LV426815</b>
	Delay Unit 220-250 Vac/Vdc 50-60 Hz	<b>S33682</b>

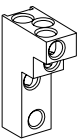
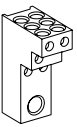

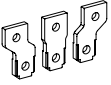

## Connection Accessories

Accessory Description			Qty per kit	Catalog Number
<b>EverLink Lug Connectors</b>				
	For 1 pole		1	LV426972
	For 2 poles with control wire terminal		1	LV426973
	For 3 poles with control wire terminal		1	LV426974
	For 4 poles with control wire terminal		1	LV426975
<b>Terminal Nut Connection Kits</b>				
	B-Frame terminal nut connector with metric screws	M6	2	LV426962
			3	LV426963
<b>Mechanical Lug Connection Kits</b>				
	Cu lugs for use with Cu wires	2.5–50 mm <sup>2</sup> (#14–1/0 AWG)	2	LV426964
			3	LV426965
	Al lugs for use with Al or Cu wires	2.5–70 mm <sup>2</sup> (#14–2/0 AWG)	2	LV426966
			3	LV426967
	Al lugs for 3 cables with 2 interphase barriers	2.5–35 mm <sup>2</sup> (#14–#2 AWG)	3	PDC3BD2
	Al lugs for 6 cables with 2 interphase barriers	2.5–16 mm <sup>2</sup> (#14–#6 AWG)	3	PDC6BD6
<b>Copper Compression Lugs for Copper Cables</b>				
	For cable 95 mm <sup>2</sup> solid/stranded / 70 mm <sup>2</sup> fine stranded <sup>21</sup>		3	LV426980
			4	LV426981
	For cable 1/0 AWG (Includes heat shrink sheaths)		2	LV426986
			3	LV426987
<b>Aluminum Compression Lugs for Copper or Aluminum Cables</b>				
	For cable 1/0 AWG (Includes heat shrink sheaths)		2	LV426988
			3	LV426989
<b>Terminal Extensions</b>				
	Spreaders from 27 to 35 mm pitch (Supplied with 2 or 3 interphase barriers.)	3 poles	1 set	LV426940
		4 poles	1 set	LV426941
<b>Torque Limiting Breakaway Bits</b>				
	9 N.m - Green	9±0.9 N•m 80±8 lb-in.	6	LV426990
			8	LV426991
	5 N.m - Yellow	5±0.5 N•m 44±4.4 lb-in.	6	LV426992
			8	LV426993



21. Supplied with 2 or 3 interphase barriers.

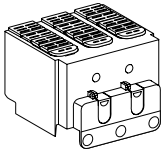
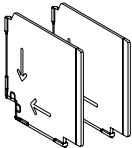
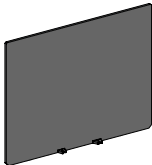

# Insulation Accessories Catalog Numbers

## Insulation Accessories

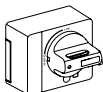
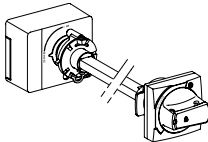
<b>Long Terminal Shields</b>				
	Used with terminal nut connectors, power distribution connectors, or mechanical lugs		Qty per kit	Catalog Number
	Long terminal shield	2 poles	1	<b>LV426911</b>
		3 poles	1	<b>LV426912</b>
		4 poles	1	<b>LV426913</b>
<b>Interphase Barriers</b>				
	Used with terminal nut connectors, power distribution connectors, or mechanical lugs		Qty per kit	Catalog Number
	Interphase barriers		6	<b>LV426920</b>
<b>Rear Insulation Screen</b>			Qty per kit	Catalog Number
	Rear insulation screen		2	<b>LV426921</b>
			2	<b>LV426922</b>
			2	<b>LV426923</b>

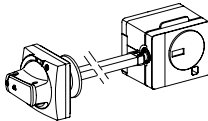
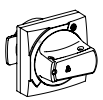
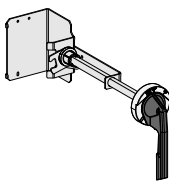
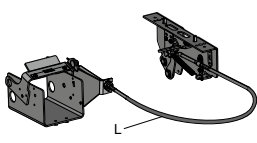
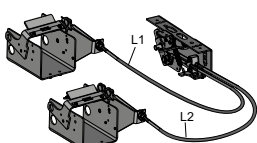

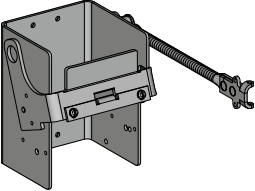

## Rotary Handle Catalog Numbers

Handle		Description	Catalog Number	
Direct Rotary Handle		Standard black handle	LV426930	
		Red handle on yellow bezel	LV426931	
Door-Mounted Rotary Handle		Standard black handle	LV426932	
		Red handle on yellow bezel (IP54)	LV426933	
		Red handle on yellow bezel (IP65)	LV426934	
		Open door shaft operator	LV426937	
		Laser tool	GVAPL01	
Side-Mounted Rotary Handle		Standard black handle	LV426935	
		Red handle on yellow bezel (IP54)	LV426936	
Universal Rotary Handle		Black handle	LV426997	
		Red handle on yellow bezel (IP54)	LV426998	
		Red handle on yellow bezel (IP65)	LV426999	
NEMA 9421 Door-Mounted Operating Mechanism		6 in. handle, standard shaft	9421LB1	
		3 in. handle, long shaft	9421LB3	
		6 in. handle, long shaft	9421LB4	
		Operating Mechanism Only	9421LB7	
NEMA 9422 Cable Operating Mechanism		Cable Length	L = 36 in. (914 mm)	9422CSB30
			L = 60 in. (1524 mm)	9422CSB50
			L = 84 in. (2134 mm)	9422CSB70
			L = 120 in. (3048 mm)	9422CSB10
NEMA 9422 Dual-Cable Operating Mechanism		Cable Length	L1 = 120 in. (3046 mm) L2 = 120 in. (3048 mm)	9422CSBD1
			L1 = 36 in. (914 mm) L2 = 60 in. (1524 mm)	9422CSBD35
			L1 = 60 in. (1524 mm) L2 = 60 in. (1524 mm)	9422CSBD55
			L1 = 36 in. (914 mm) L2 = 120 in. (3048 mm)	9422CSBD31
			L1 = 60 in. (1524 mm) L2 = 120 in. (3048 mm)	9422CSBD51
			L1 = 36 in. (914 mm) L2 = 36 in. (914 mm)	9422CSBD33

Handle		Description	Catalog Number
<p><b>NEMA 9422 Variable-Depth Operating Mechanism</b></p>		<p>Operator only</p>	<p><b>9422RB1</b></p>
<p><b>Operating Mechanism Handle</b></p>		<p>6 in. Painted Flange Handle</p>	<p><b>9422A1</b></p>
		<p>6 in. Stainless Steel Flange Handle</p>	<p><b>9422A2</b></p>
		<p>4 in. Painted Flange Handle</p>	<p><b>9422A3</b></p>
		<p>4 in. Stainless Steel Flange Handle</p>	<p><b>9422A4</b></p>
<p><b>Operating Mechanism Electrical Interlock</b></p>		<p>Single Pole Double Throw</p>	<p><b>9999R26</b></p>
		<p>Double Pole Double Throw</p>	<p><b>9999R27</b></p>

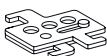
## Locking and Sealing Accessories Catalog Numbers

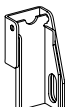
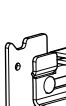
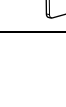
### Locking Systems

Handle Padlocking Devices <sup>22</sup>	Catalog Number
 Removable (lock OFF only)	29370
 UM Fixed (lock OFF or ON)	LV426905
 I-Line Fixed (lock OFF or ON)	LV426907
 UM Fixed (lock OFF only)	LV426906
 I-Line Fixed (lock OFF only)	LV426908
 Handle Interlock	LV426909

### Sealing Accessories

Sealing Accessories	Catalog Number
 Bag of accessories	MICROTUSEAL

### Adapter/Conversion Kits

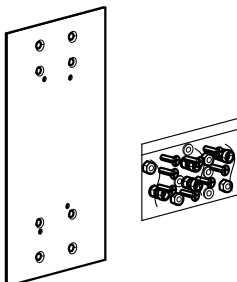
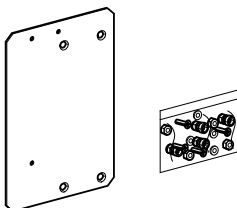
Kit Description	Catalog Number
 FA to PowerPact B-Frame Unit Mount Conversion Kit	HJKADAPT
 FA to PowerPact B-Frame 9421 Rotary Handle Conversion Kit <b>NOTE:</b> This kit conversion requires additional shaft kit 9421LS8 or 9421LS13.	LV426995

22. Rotary handle has integral padlocking capability.

## Spare Parts

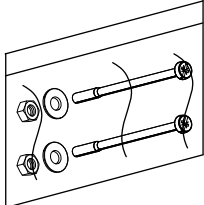
Kit Description	Catalog Number
 <p data-bbox="743 342 928 369">Mounting Screw Kit</p>	<p data-bbox="1284 342 1385 369">LV426994</p>

# Glossary

## Accessories

**Bare-cable connector:** Conducting part of the circuit breaker intended for connection to power circuits. On PowerPact circuit breakers, you can use Everlink lugs or copper/ aluminum lug options that screw to the connection terminals of the circuit breaker. Connectors have one or more holes (single or multiple cable connector) for the ends of bare cables.

**Connection terminals:** Flat copper surface, linked to the conducting parts of the circuit breaker and to which power connections are made using bars, connectors or lugs.

**Spreaders:** Set of three (3P device) or four (4P device) flat, conducting parts made of copper. They are screwed to the circuit breaker terminals to increase the pitch between poles.

## Circuit breaker characteristics

**Breaking capacity:** Value of prospective current that a switching device is capable of breaking at a stated voltage under prescribed conditions of use and behaviour. Reference is generally made to the ultimate breaking capacity (Icu) and the service breaking capacity (Ics).

**Degree of protection (IP) IEC 60529:** Defines device protection against the penetration of solid objects and liquids, using two digits specified in standard IEC 60259. Each digit corresponds to a level of protection, where 0 indicates no protection.

- First digit (0 to 6): protection against penetration of solid foreign objects. 1 corresponds to protection against objects with a diameter > 50 mm, 6 corresponds to total protection against dust.
- Second digit (0 to 8): protection against penetration of liquids (water). 1 corresponds to protection against falling drops of water (condensation), 8 corresponds to continuous immersion.

The enclosure of PowerPact circuit breakers provides a minimum of IP40 (protection against objects > 1 mm) and can reach IP56 (protection against dust and powerful water jets) depending on the installation conditions.

**Degree of protection against external mechanical impacts (IK):** Defines the aptitude of an object to resist mechanical impacts on all sides, resistance being designated by an identifying number set out by the listing standard. Each number corresponds to the impact energy that the object can handle according to a standardised procedure.

**Durability:** The term "durability" is used in the standards instead of "endurance" to express the expectancy of the number of operating cycles which can be performed by the equipment before repair or replacement of parts. The term "endurance" is used for specifically defined operational performance.

**Electrical durability:** With respect to its resistance to electrical wear, equipment is characterised by the number of loaded operating cycles, corresponding to the service conditions given in the relevant product standard, which can be made without replacement.

**Frame size:** "A term designating a group of circuit breakers, the external physical dimensions of which are common to a range of current ratings. Frame size is expressed in amperes corresponding to the highest current rating of the group. Within a frame size, the width may vary according to the number of poles. This definition does not imply dimensional standardization." PowerPact circuit breakers are available in seven frame sizes covering 125 A, 150 A, 250 A, 600 A, 800 A, 1200 A, and 3000 A.

**Insulation class:** Defines the type of device insulation in terms of earthing and the corresponding safety for the user, in one of three classes.

- Class I. The device is earthed. Any electrical faults, internal or external, or caused by the load, are cleared via the earthing circuit, thus ensuring user safety.
- Class II. The device is not connected to a protective conductor. User safety is ensured by reinforced insulation around the live parts (an insulating case and no contact with live parts, i.e. plastic buttons, moulded connections, etc.) or double insulation.
- Class III. The device may be connected only to SELV (safety extra-low voltage) circuits.

The PowerPact circuit breakers are class II devices (front) and may be installed through the door

in class II switchboards (standards IEC 61140 and IEC 60664-1), without reducing insulation, even with a rotary handle or motor mechanism module.

**Making capacity:** Value of prospective making current that a switching device is capable of making at a stated voltage under prescribed conditions of use and behaviour. Reference is generally made to the short-circuit making capacity  $I_{cm}$ .

**Maximum break time:** Maximum time after which breaking is effective, i.e. the contacts separated and the current completely interrupted.

**Mechanical durability:** With respect to its resistance to mechanical wear, equipment is characterised by the number of no-load operating cycles which can be effected before it becomes necessary to service or replace any mechanical parts.

**Non-tripping time:** This is the minimum time during which the protective device does not operate in spite of pick-up overrun, if the duration of the overrun does not exceed the corresponding voluntary time delay.

**Pollution degree of environment conditions IEC 60947-1:** "Conventional number based on the amount of conductive or hygroscopic dust, ionized gas or salt and on the relative humidity and its frequency of occurrence, resulting in hygroscopic absorption or condensation of moisture leading to reduction in dielectric strength and/or surface resistivity".

Standard IEC 60947-1 distinguishes four pollution degrees:

- Degree 1. No pollution or only dry, non-conductive pollution occurs.
- Degree 2. Normally, only non-conductive pollution occurs. Occasionally, however, a temporary conductivity caused by condensation may be expected.
- Degree 3. Conductive pollution occurs, or dry, non-conductive pollution occurs which becomes conductive due to condensation.
- Degree 4. The pollution generates persistent conductivity caused, for instance, by conductive dust or by rain or snow.

PowerPact circuit breakers meet degree 3, which corresponds to industrial applications.

**Prospective short-circuit current:** Current that would flow through the poles if they remained fully closed during the short-circuit.

**Rated current ( $I_n$ ):** This is the current that the device has been certified to carry continuously within all parameters described by the standard.

**Rated impulse withstand voltage:** "The peak value of an impulse voltage of prescribed form and polarity which the equipment is capable of withstanding without failure under specified conditions of test and to which the values of the clearances are referred. The rated impulse withstand voltage of an equipment shall be equal to or higher than the values stated for the transient overvoltages occurring in the circuit in which the equipment is fitted".

**Rated insulation voltage ( $V_i$ ):** "The rated insulation voltage of an equipment is the value of voltage to which dielectric tests and creepage distances are referred. In no case shall the maximum value of the rated operational voltage exceed that of the rated insulation voltage".



**Rated operational current (Ie):** "A rated operational current of an equipment is stated by the manufacturer and takes into account the rated operational voltage, the rated frequency, the rated duty, the utilization category and the type of protective enclosure, if appropriate".

**Rated operational voltage (Ve):** "A value of voltage which, combined with a rated operational current, determines the application of the equipment and to which the relevant tests and the utilisation categories are referred. For multipole equipment, it is generally stated as the voltage between phases".

This is the maximum continuous voltage at which the equipment may be used.

**Rated short-time withstand current (Icw):** "Value of short-time withstand current, assigned to the equipment by the manufacturer, that the equipment can carry without damage, under the test conditions specified in the relevant product standard". Generally expressed in kA for 0.5, 1 or 3 seconds. This is an essential characteristic for air circuit breakers. It is not significant for molded-case circuit breakers for which the design targets fast opening and high limiting capacity.

**Service breaking capacity (Ics):** Expressed as a percentage of Icu, it provides an indication on the robustness of the device under severe conditions. It is confirmed by a test with one opening and one closing/opening at Ics, followed by a check that the device operates correctly at its rated current, i.e. 50 cycles at In, where temperature rise remains within tolerances and the protection system suffers no damage.

**Short-circuit making capacity (Icm):** Value indicating the capacity of the device to make and carry a high current without repulsion of the contacts. It is expressed in kA peak.

**Suitability for isolation:** This capability means that the circuit breaker meets the conditions below.

- In the open position, it must withstand, without flashover between the upstream and downstream contacts, the impulse voltage specified by the standard as a function of the Uimp indicated on the device.
- It must indicate contact position by one or more of the following systems:
  - position of the operating handle
  - separate mechanical indicator
  - visible break of the moving contacts
- Leakage current between each pole, with the contacts open, at a test voltage of 1.1 x the rated operating voltage, must not exceed:
  - 0.5 mA per pole for new devices
  - 2 mA per pole for devices already subjected to normal switching operations
  - 6 mA, the maximum value that must never be exceeded.
- It must not be possible to install padlocks unless the contacts are open. Locking in the closed position is permissible for special applications. PowerPact complies with this requirement by positive contact indication.

**Suitable for isolation with positive contact indication:** Suitability for isolation is defined here by the mechanical reliability of the position indicator of the operating mechanism, where:

- the isolation position corresponds to the O (OFF) position
- the operating handle cannot indicate the "OFF" position unless the contacts are effectively open.

The other conditions for isolation must all be fulfilled:

- locking in the open position is possible only if the contacts are effectively open
- leakage currents are below the standardised limits
- overvoltage impulse withstand between upstream and downstream connections.

**Ultimate breaking capacity (Icu):** Expressed in kA, it indicates the maximum breaking capacity of the circuit breaker.

It is confirmed by a test with one opening and one closing/opening at  $I_{cu}$ , followed by a check that the circuit is properly isolated. This test ensures user safety.

**Controls:**

**CNOMO machine-tool rotary handle:** Handle used for machine-tool control enclosures and providing IP54 and IK08.

**Direct rotary handle :** This is an optional control handle for the circuit breaker. It has the same three positions I (ON), O (OFF) and TRIPPED as the toggle control. It provides IP40, IK07 and the possibility, due to its extended travel, of using early-make and early-break contacts. It maintains suitability for isolation and offers optional locking using a padlock.

**Emergency off:** In a circuit equipped with a circuit breaker, this function is carried out by an opening mechanism using an MN undervoltage release or an MX shunt trip in conjunction with an emergency off button.

**Extended rotary handle :** Rotary handle with an extended shaft to control devices installed at the rear of switchboards or control panels. It has the same characteristics as direct rotary handles. It offers multiple locking possibilities using a padlock or a door interlock.

**Side rotary handle :** Rotary handle with a side shaft to control devices installed in the switchboards. It has the same characteristics as direct rotary handles. It offers multiple locking possibilities using a padlock.

**Failsafe remote tripping:** Remote tripping is carried out by an opening mechanism using an MN undervoltage release in conjunction with an emergency off button. If power is lost, the protection device opens the circuit breaker.

**Discrimination / Cascading:**

**Cascading /Series Ratings:** Cascading implements the current-limiting capacity of a circuit breaker, making it possible to install downstream circuit breakers with lower performance levels.

The upstream circuit breaker reduces any high short-circuit currents. This makes it possible to install downstream circuit breakers with breaking capacities less than the prospective short-circuit current at their point of installation.

The main advantage of cascading is to reduce the overall cost of electrical distribution equipment.

Because the current is limited throughout the circuit downstream of the limiting circuit breaker, cascading applies to all the devices located downstream.

**Current discrimination/Selective coordination:** Discrimination based on the difference between the current-protection settings of the circuit breakers. The difference in settings between two successive circuit breakers in a circuit must be sufficient to allow the downstream breaker to clear the fault before the upstream breaker trips.

**Discrimination:**

Discrimination is ensured between upstream and downstream circuit breakers if, when a fault occurs, only the circuit breaker placed immediately upstream of the fault trips.

Discrimination is the key to ensuring the continuity of service of an installation.

**Energy discrimination:** This function is specific to PowerPact circuit breakers and supplements the other types of discrimination.

**Partial discrimination:** The ultimate short-circuit current  $I_{cu}$ , but only up to a lesser value. This value is called the discrimination limit. If a fault exceeds the discrimination limit, both circuit breakers trip.

**Time discrimination:** Discrimination based on the difference between the time-delay settings of the circuit breakers. The upstream trip unit is delayed to provide the downstream breaker the time required to clear the fault.

**Total discrimination:** Total discrimination is ensured between upstream and downstream circuit breakers if, for all fault values, from overloads up to solid short-circuits, only the downstream circuit breaker trips and the upstream circuit breaker remains closed.

**Environmental:**

**EMC (Electromagnetic compatibility) :** EMC is the capacity of a device not to disturb its environment during operation (emitted electromagnetic disturbances) and to operate in a disturbed environment (electromagnetic disturbances affecting the device). The standards define various classes for the types of disturbances. Micrologic™ trip units comply with annexes F and J in standard IEC IE60947-2.

**Power loss (Pole resistance) :** The flow of current through the circuit breaker poles produces Joule-effect losses caused by the resistance of the poles.

**Product environmental profile (PEP)**

**LCA: Life-cycle assessment ISO 14040:** An assessment on the impact of the construction and use of a product on the environment, in compliance with standard ISO 14040, Environmental management, life-cycle assessment (LCA), principles and framework . For PowerPact, this assessment is carried out using the standardised EIME (Environmental Impact and Management Explorer) software, which makes possible comparisons between the products of different manufacturers.

It includes all stages, i.e. manufacture, distribution, use and end of life, with set usage assumptions:

- use over 20 years at a percent load of 80 % for 14 hours per day and 20 % for ten hours
- according to the European electrical-energy model.

It provides the information presented below.

- Materials making up the product: composition and proportions, with a check to make sure no substances forbidden by the RoHS directive are included.
- Manufacture: on Schneider Electric production sites that have set up an environmental management system certified ISO 14001.
- Distribution: packaging in compliance with the 94/62/EC packaging directive (optimised volumes and weights) and optimised distribution flows via local centres.
- Use: no aspects requiring special precautions for use. Power lost through Joule effect in Watts (W) must be < 0.02 % of total power flowing through the circuit breaker. Based on the above assumptions, annual consumption from 95 to 200 kWh.
- End of life: products dismantled or crushed. For PowerPact circuit breakers, 81 % of materials can be recycled using standard recycling techniques. Less than 2 % of total weight requires special recycling.

**RoHS directive (Restriction of Hazardous substances):** \European directive 2002/95/EC dated 27 January 2003 aimed at reducing or eliminating the use of hazardous substances. The manufacturer must attest to compliance, without third-party certification. Circuit breakers are not included in the list of concerned products, which are essentially consumer products.

That notwithstanding, Schneider Electric decided to comply with the RoHS directive.

PowerPact products are designed in compliance with RoHS and do not contain (above the authorised levels) lead, mercury, cadmium, hexavalent chromium or flame retardants (polybrominated biphenyls PBB and polybrominated diphenyl ether PBDE).

**Safety clearances:** When installing a circuit breaker, minimum distances (safety clearances) must be maintained between the device and panels, bars and other protection systems installed nearby. These distances, which depend on the ultimate breaking capacity, are defined by tests carried out in accordance with standard IEC 60947- 2.

**Temperature derating:** An ambient temperature varying significantly from 40°C can modify operation of magnetic or thermal-magnetic protection functions. It does not

affect electronic trip units. However, when electronic trip units are used in high-temperature situations, it is necessary to check the settings to ensure that only the permissible current for the given ambient temperature is let through.

**Vibration withstand IEC 60068-2-6** : Circuit breakers are tested in compliance with standard IEC 60068-2-6 for the levels required by merchant-marine inspection organisations (Veritas, Lloyd's, etc.):

**WEEE directive (Waste of Electrical and Electronic Equipment)**: European directive on managing the waste of electrical and electronic equipment.

Circuit breakers are not included in the list of concerned products.

However, PowerPact products respect the WEEE directive.

#### **Measurements:**

**Overvoltage category (OVC - Overvoltage category) IEC 60947-1. Annex H:** Standard IEC 60664-1 stipulates that it is up to the user to select a measurement device with a sufficient overvoltage category, depending on the network voltage and the transient overvoltages likely to occur.

Four overvoltage categories define the field of use for a device.

- Cat. I. Devices supplied by a SELV isolating transformer or a battery.
- Cat. II. Residential distribution, handheld or laboratory tools and devices connected to standardised 2P + earth electrical outlets (230 V).
- Cat. III. Industrial distribution, fixed distribution circuits in buildings (main low voltage switchboards, rising mains, elevators, etc.).
- Cat. IV. Utility substations, overhead lines, certain industrial equipment.

#### **Protection:**

**Instantaneous protection I (Ii)**: This protection supplements I<sub>sd</sub>. It provokes instantaneous opening of the device.

The pick-up is fixed (built-in). This value is always lower than the contact-repulsion level.

**Magnetic protection (Im)**: Short-circuit protection provided by magnetic trip units (see this term). The pick-up setting may be fixed.

**Neutral protection (IN)**: The neutral is protected because all circuit breaker poles are interrupted. The PowerPact B-frame 4P circuit breaker has fixed 100% protection in the far left pole.

**Thermal protection (Ir)**: Overload protection provided by thermal trip units (see this term) using an inverse time curve ( $I^2t$ ).

#### **Relays and auxiliary contacts:**

##### **Auxiliary contact**

**IEC 60947-1**: "Contact included in an auxiliary circuit and mechanically operated by the switching device".

##### **Break contact**

**IEC 60947-1** : "Control or auxiliary contact which is open when the main contacts of the mechanical switching device are closed and closed when they are open".

##### **Make contact**

**IEC 60947-1** : "Control or auxiliary contact which is closed when the main contacts of the mechanical switching device are closed and open when they are open".

**Relay (electrical) IEC 60947-1** : "Device designed to produce sudden, predetermined changes in one or more electrical output circuits when certain conditions are fulfilled in the electrical input circuits controlling the device".

#### **Switchgear:**

**Circuit breaker IEC 60947-2:** "Mechanical switching device, capable of making, carrying and breaking currents under normal circuit conditions and also making, carrying for a specified time and breaking currents under specified abnormal circuit conditions such as those of short circuit". Circuit breakers are the device of choice for protection against overloads and short-circuits. Circuit breakers may, as is the case for PowerPact, be suitable for isolation.

**Circuit breaker utilisation category IEC 60947-2:** The standard defines two utilisation categories, A and B, depending on circuit breaker discrimination with upstream breakers under short-circuit conditions.

- Category A. Circuit breakers not specifically designed for discrimination applications.
- Category B. Circuit breakers specifically designed for discrimination, which requires a short time-delay (which may be adjustable) and a rated short-time withstand current in compliance with the standard.

PowerPact 125 to 600 A circuit breakers are category A, however, by design, they provide discrimination with downstream devices (see the Complementary technical information guide).

**Contactors IEC 60947-1:** "Mechanical switching device having only one position of rest, operated otherwise than by hand, capable of making, carrying and breaking currents under normal circuit conditions including operating overload conditions". A contactor is provided for frequent opening and closing of circuits under load or slight overload conditions. It must be combined and coordinated with a protective device against overloads and short-circuits, such as a circuit breaker.

**Contactors utilisation categories IEC 60947-4-1:** The standard defines four utilisation categories, AC1, AC2, AC3 and AC4 depending on the load and the control functions provided by the contactor. The class depends on the current, voltage and power factor, as well as contactor withstand capacity in terms of frequency of operation and endurance.

**Current-limiting circuit breaker IEC 60947-2 :** "A Circuit breaker with a break-time short enough to prevent the short-circuit current reaching its otherwise attainable peak value".

**Disconnectors IEC 60947-3:** "Mechanical switching device which, in the open position, complies with the requirements specified for the isolating function". A disconnector serves to isolate upstream and downstream circuits. It is used to open or close circuits under no-load conditions or with a negligible current level. It can carry the rated circuit current and, for a specified time, the short-circuit current.

#### **Trip unit:**

**Magnetic release:** Release actuated by a coil or a lever. A major increase in the current (e.g. a short circuit) produces in the coil or the lever a change in the magnetic field that moves a core. This trips the circuit breaker operating mechanism. Action is instantaneous.

The pick-up setting may be adjustable.

**Reflex tripping:** PowerPact circuit breakers have a patented reflex-tripping system based on the energy of the arc and that is independent of the other protection functions. It operates extremely fast, before the other protection functions. It is an additional safety function that operates before the others in the event of a very high short circuit.

**Release IEC 60947-1:** Device, mechanically connected to a mechanical switching device (e.g. a circuit breaker), which releases the holding means and permits the opening or the closing of the switching device. For circuit breakers, releases are often integrated in a trip unit.

**Shunt trip (MX):** When the shunt trip (MX) receives a pulse-type or maintained voltage within specified tolerances it signals the circuit breaker to open.

**Thermal-magnetic trip unit:** Trip unit combining thermal protection for overloads and magnetic protection.

**Thermal release:** Release in which a bimetal strip is heated by the Joule effect. Above a temperature-rise threshold that is a function of the current and its duration ( $I^2t$  curve = constant, which is representative of temperature rise in cables), the bimetal strip bends and releases the circuit breaker opening mechanism. The pick-up setting may be adjustable.

**Undervoltage release (MN) :** This type of release operates when the supply voltage drops below the set minimum.



Schneider Electric  
35 rue Joseph Monier  
92500 Rueil Malmaison  
France

+ 33 (0) 1 41 29 70 00

[www.schneider-electric.com](http://www.schneider-electric.com)

As standards, specifications, and design change from time to time,  
please ask for confirmation of the information given in this publication.

© 2016 – 2017 Schneider Electric. All rights reserved.

0611CT1603



## X-ON Electronics

Largest Supplier of Electrical and Electronic Components

*Click to view similar products for [Schneider manufacturer](#):*

Other Similar products are found below :

[HMIGTO2310](#) [GS1AE21](#) [METSEPM8240](#) [XUZC31](#) [LU9M1](#) [7D](#) [7S](#) [7XA1](#) [FNQR2](#) [8501RS44V24](#) [8501RSD14P14V51](#) [8501XM4](#)  
[8501XO20V03Y414](#) [9001KXRK](#) [9001SKR9P35RH25](#) [9001SKT35L31](#) [9003K2C003GA](#) [9007AA1](#) [9007BA1](#) [9007C54D](#) [9007C62A2](#)  
[9007C68T5](#) [9007CA11](#) [9007FA3](#) [9007HA4](#) [9007HA6](#) [9007KA1](#) [9007KB11](#) [9007MS01S0206](#) [9012GAR4](#) [9012GAW2](#) [9012GBW1](#)  
[9012GDW5E3](#) [9012GFW1](#) [9012GNG1](#) [9012GNG3](#) [9012GNG6](#) [9013FHG39J69](#) [9013GHG2J30](#) [9050JCK2F30V14](#) [GV2P03](#) [GZ1E02](#)  
[A9F04316](#) [ATS01N206QN](#) [RSL1PRJU](#) [9001KA35](#) [9001KA3G](#) [9001KR1GH5](#) [9001KXSDC](#) [9007C52A2](#)