

9 Series

Multi9

Catalog 2023
Multistandard protection for OEM applications

se.com

Life Is On

Schneider
Electric

Multi9

Multistandard circuit protection for OEM

About the Book

Legal information

The information provided in this Catalog contains description of Schneider Electric products, solutions and services ("Offer") with technical specifications and technical characteristics of the performance of the corresponding Offer.

The content of this document is subject to revision at any time without notice due to continued progress in methodology, design and manufacturing.

To the extent permitted by applicable law, no responsibility or liability is assumed by Schneider Electric and its subsidiaries for any type of damages arising out of or in connection with (i) informational content of this Catalog not conforming with or exceeding the technical specifications, or (ii) any error contained in this Catalog, or (iii) any use, decision, act or omission made or taken on basis of or in reliance on any information contained or referred to in this Catalog.

SCHNEIDER ELECTRIC MAKES NO WARRANTY OR REPRESENTATION OF ANY KIND, WHETHER EXPRESS OR IMPLIED, AS TO WHETHER THIS CATALOG OR ANY INFORMATION CONTAINED THEREIN SUCH AS PRODUCTS AND SERVICES WILL MEET REQUIREMENTS, EXPECTATIONS OR PURPOSE OF ANY PERSON MAKING USE THEREOF.

Schneider Electric brand and any trademarks of Schneider Electric and its subsidiaries referred to in this Catalog are property of Schneider Electric or its subsidiaries. All other brands are trademarks of their respective owners.

This Catalog and its content are protected under applicable copyright laws and provided for informative use only. No part of this Catalog may be reproduced or transmitted in any form or by any means (electronic, mechanical, photocopying, recording, or otherwise), for any purpose, without the prior written permission of Schneider Electric.

Copyright, intellectual, and all other proprietary rights in the content of this Catalog (including but not limited to software, audio, video, text, and photographs) rests with Schneider Electric or its licensors. All rights in such content not expressly granted herein are reserved. No rights of any kind are licensed or assigned or shall otherwise pass to persons accessing this information.

Trademarks

QR Code is a registered trademark of DENSO WAVE INCORPORATED in Japan and other countries.



Green Premium™

Schneider Electric's commitment to deliver products with best-in-class environmental performance.



More than 75% of our product sales offer superior transparency on the material content, regulatory information and environmental impact of our products:

- RoHS compliance
- REACH substance information
- Industry leading # of PEP's*
- Circularity instructions



Learn more about **Green Premium**

Green Premium promises compliance with the latest regulations, transparency on environmental impacts as well as circular and low-CO2 products.

CO₂ and P&L impact through... Resource Performance

Green Premium brings improved resource efficiency throughout an asset's lifecycle. This includes efficient use of energy and natural resources, along with the minimization of CO₂ emissions.

Cost of ownership optimization through... Circular Performance

We're helping our customers optimize the total cost of ownership of their assets. To do this, we provide IoT-enabled solutions, as well as upgrade, repair, retrofit, and remanufacture services.

Peace of mind through... Well-being Performance

Green Premium products are RoHS and REACH compliant. We're going beyond regulatory compliance with step-by-step substitution of certain materials and substances from our products.

Improved sales through... Differentiation

Green Premium delivers strong value propositions through third-party labels and services. By collaborating with third-party organizations we can support our customers in meeting their sustainability goals such as green building certifications.

*PEP: Product Environmental Profile (i.e. Environmental Product Declaration)



Multi9 has been designed to offer enhanced protection by preventing and protecting people and equipment from electrical threats such as short circuits, earth leakages, overloads, and more.

A comprehensive range for enhanced protection against electrical threats.

Multi9™ is a range of DIN rail modular devices, a solution offering great performance. Multi9 range is built to meet the major standards for industry applications. Designed to meet your needs for most types of machines, it offers a wide range of modular devices providing protection, signalling functions and accessories.

Renowned quality

World leader's proven technology and experience.

Available worldwide

Sold under the same commercial reference.

Optimized

Small footprint to reduce your panel size, cost effective, less commercial references.

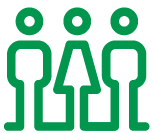
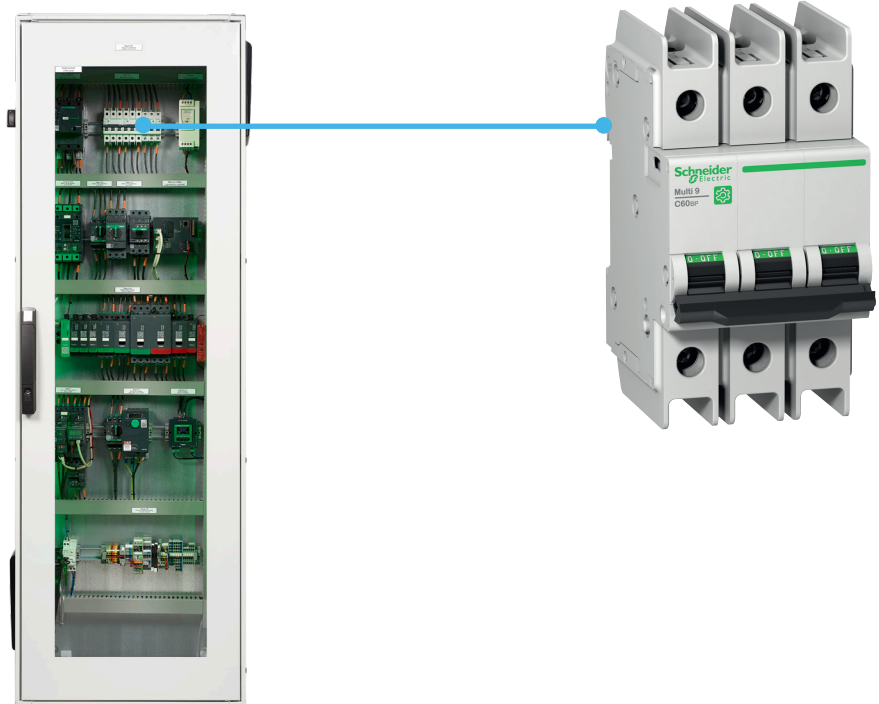

Multi-standard

Multi9 covers all standards for industry application: UL/CSA for North America, IEC, EAC, CCC and others for the rest of the world. It allows a unique panel design



Wide range of offers to cover all functions in a control panel

Wide range of solutions that are customized to fit your efficiency and sustainability needs



Optimized references which is easy to select

- Time-saving
- Easy to procure and install
- Meaningful commercial references



Sustainable with Green Premium Compliance

- 70% of the packaging is made with recycled cardboard
- Green Premium™ products are RoHS and REACH compliant

Multi-standard

Multi9 - range with advanced protection

Designed to offer enhanced protection by preventing and protecting people and equipment from electrical threats such as short circuits, earth leakages, overloads and more.



Miniature Circuit Breakers

Protection against short circuits and overcurrent faults ensuring uninterrupted functionality..

- Ensures no accidental contact with live part – Finger-proof IP-20 terminals
- Avoids false insertion of cables and loose termination with Pull up terminals
- Total Flexibility : Line-Load reversibility
- Low cost with higher performance: Cascading. Cascading charts available From ACB-MCCB-MCB level.
- Reduce Downtime: Discrimination. Discrimination charts available From ACB-MCCB-MCB level
- Easy Installation: Bi – connect terminals
- Increased service life: Fast Closing mechanism
- Environmentally friendly with 100% recyclable & recoverable materials.



Residual Current Devices

Safe and reliable protection against earth fault, fire protection and electrocution ensuring people's safety, delivering efficiency and service continuity.

- Easy monitoring: Earth fault indication on front face
- Immunity against nuisance tripping
- New SI RCDs offers enhanced immunity to electrical disturbances and polluted & corrosive environments
- Easy Installation: bi-connect terminals
- Field fittable auxiliaries for advanced protection & monitoring



Surge Protection Devices

Surge protection, harmonic filtering and voltage regulation from home to the data center to industrial environments.

- Affordable – An affordable way to protect your infrastructure from potential hazards.
- Easy Repair & Replacement – Surge protectors protect your electrical devices from burnout and expand their lifespan.
- Reduced Maintenance Costs – Because surge protectors limit excessive voltage, they can protect your appliances, HVAC system, and more. Thus reducing the number of maintenance calls you make.

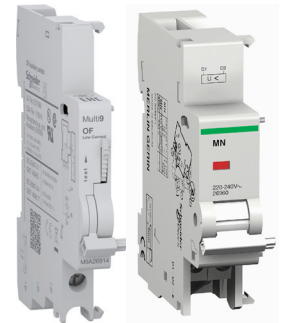

Indication and Tripping Auxiliaries

OF, SD, OF/SD+OF for standard (from 100 mA to 6 A) and advanced (from 2 mA to 100 mA) applications.

- Compliant in harsh environments with low current auxiliaries.
- Optimize your wiring (less wires and wiring time) inside a panel with the daisy chain architecture with low current auxiliaries.
- Monitor up to 100 protective devices (permanently close) under the daisy chain.
- Tripping auxiliaries: MN, MX
- Instantaneous or delayed option: independent of the supply voltage.





Wide range of offers to cover all functions in a Control Panels

Fully compliant with all industry standards, Multi9 is ideally suited for all types of machine and equipment, providing you not only with protection but plenty of accessories as well as signaling functions.



Time saving



Easy to buy from same vendor and install



Easy coordination



Easy warranty and maintenance



PLC (Programmable Logic Controllers)

Control and monitor industrial operations in a sustainable, flexible, efficient and protected way. Our PLCs and PACs supply edge technology, augmenting it with Ethernet connectivity, built-in cybersecurity, and processing power needed to handle Big Data analysis and protecting against new vulnerabilities among connected industrial assets, across devices or into the cloud.



Push buttons

Ensure robust, safe, ergonomic and easy control of machines and manufacturing lines delivering efficiency and effectiveness.



HMI

Simple and effective means of connecting systems, collecting data and presenting information. Perform diagnostics, add control and adjust system settings on simple or compact applications from the smallest text display to the most sophisticated industrial PC.



Speed drives

Powerful and reliable combination for your motor control solutions made to the highest quality level to meet your needs in various applications, such as industrial processes, machines or buildings.

Multi9 Range Highlights



C60BP

Miniature circuit breaker for Branch Protection

- UL 489, CSA, IEC and CCC certified,
- UL 489 performances: up to 35 A in 480Y/277V and up to 63 A in 240 V,
- New optimized design and smaller footprint (103 mm / 4,05 in): each references up to 35 A, cover both 480Y/277V and 240 V power supplies,
- In addition to the accessories range, the UL cuttable combs are now available.

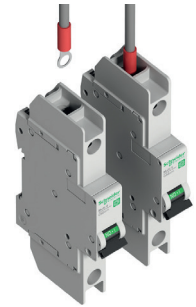

C60BPR

Miniature circuit breaker for Branch Protection with Ring terminal

- UL 489, CSA, IEC and CCC certified,
- UL 489 performances: up to 35 A in 480Y/277V and up to 63 A in 240 V,
- New optimized design and smaller footprint: each references up to 35 A cover both 480Y/277V and 240 V power supplies,
- Ring tongue terminal ready to wire as delivered open.



C60SP

Miniature Circuit Breaker for Supplementary Protection

- UL 1077, CSA, IEC and CCC certified
- UL 1077 performances: up to 63A in 480 Y/277 V
- B, C & D curves



C60N/H/L

Miniature Circuit Breaker for IEC zone

- IEC/EN 60947-2 and CCC certified
- Up to 20 kA (440 V)
- B, C & D curves



C60H-DC

Miniature circuit breaker, "H" breaking capacity for Direct Current applications

- UL1077, IEC, CCC certified,
- To protect your direct current applications up to 500 V DC
- B, C & K curves



Vigi C60

Residual Current Device

- IEC/EN 61009-1

Multi9 Range Highlights

Surge Protection Devices



Surge protection, harmonic filtering and voltage regulation from home to the data center to industrial environments.

- UL 1449 4th Edition Recognized, CSA C22.2 No. 269.4-17, 1st Edition

PowerTag Energy



PowerTag Energy is a wireless-communication energy sensor

PowerTag Energy is designed specifically for Energy Management, Load Monitoring and Power Availability applications.

Associated to a concentrator or a gateway, PowerTag Energy provides a full wireless class 1 solution to monitor energy at any level of a distribution panel.

Suitable for industrial and machine applications, PowerTag Energy sensor incorporates all features required to perform accurate real-time measurements (U, V, I, P, PF) and energy values up to 160 A.

Advantages:

- Wireless-communication
- Voltage loss alarming
- Class 1 accuracy
- Compact design
- Easy installation and commissioning
- Scalable solution
- Perfect for retrofit or new panels

See PowerLogic Catalog PLS3D309005EN



Click on
QR code or scan
to download



Multi9

Multistandard circuit protection for OEM

Miniature Circuit Breakers	12	1
UL/CSA + IEC/EN 60947-2 + GB	12	
Multi9 C60BP - Z, C, D curves – Tunnel terminals	12	
Multi9 C60BPR - Z, C, D curves – Ring-tongue terminals	14	
Multi9 C60SP - B, C, D curves – Tunnels terminals	16	
Multi9 C60H-DC - B, C, K curves – Tunnels terminals for DC circuits only	19	
IEC/EN 60947-2	22	
Multi9 C60N - B, C, D curves	22	
Multi9 C60H - B, C, D curves	24	
Multi9 C60L - C curve	26	
Multi9 C60CTRL - Z, C curves – For control circuits protection	28	
Multi9 N40N - C curve	30	
Residual Current Devices	32	2
UL + IEC/EN	32	
Multi9 GFP - Ground Fault Protector	32	
VDE + IEC/EN	34	
Acti9 iLD B-SI type Residual Current Circuit Breakers (RCCB)	34	
Acti9 RCCB-ID 125 A Residual Current Circuit Breakers (AC, A, A-SI, B types)	38	
IEC/EN	42	
Multi9 RCCB ID – Residual Current Circuit Breakers (AC, A-SI types)	42	
Multi9 Vigi C60 – Residual Current Devices – Add-on for C60	44	
Multi9 Vigi N40 – Residual Current Devices – Add-on for N40	46	
Multi9 N40 Vigi – Residual Current circuit Breakers with Overcurrent protection	48	
Surge Protective Devices	50	3
UL 1449 4th Edition + CSA C22.2 No. 269.4-17	50	
Multi9 PRD1 75r	50	
Auxiliaries and accessories	55	4
Multi9 Electrical auxiliaries for MCB and RCD, except Acti9 iLD B-SI type RCCB	55	
Electrical auxiliaries for Acti9 iLD B-SI type RCCB	63	
Multi9 Accessories for MCB and RCD, except Acti9 iLD B-SI type RCCB	72	
Accessories for Acti9 iLD B-SI type RCCB	77	
Comb busbars for C60BP	82	
Comb busbars for C60sp	84	
Comb busbars for C60N, C60H, C60L (18 mm / 0.71 in pitch)	86	
Comb busbars for N40N, N40 Vigi (9 mm / 0.35 in pitch)	88	
Linergy DS screw distribution blocks	90	
Technical information	94	5
Breaker standards	94	
The standards and their applications	95	
Circuit breakers tripping curves	96	
Influence of ambient temperature	100	
Dissipated power, Impedance and Voltage drop	104	
Short-circuit current limiting	105	
Clearance between device and bare sheet metal	112	
Copper Multi-cables connection	113	
Control panel technical guides library	115	6

Multi9 C60BP - Z, C, D curves – Tunnel terminals



UL 489 / CSA C22.2 No 5 / IEC/EN 60947-2 / GB 14048-2

As per the above standards:

C60BP are multi-standard miniature circuit breakers and branch circuit protection as defined by UL 489. It combines following functions:

- circuit protection against short-circuit currents
- circuit protection against overload currents
- tripping and electrical fault indication by the addition of auxiliaries.



Number of 18 mm (0.71 in) poles	Rating (A) 25°C/77°F	Breaking capacity (kA rms) AIR				Icu			
		UL 489 / CSA C22.2 No 5				IEC 60947-2			
1P	0.5 to 35	277 V ~	240 V ~	120 V ~	60 V ---	440 V ~	415 V ~	240 V ~	60 V ---
	40 to 63	-	10	10	10	-	3	10	20
2P	1 to 25	480Y/277 V ~		240 V ~	125 V ---	440 V ~	415 V ~	240 V ~	125 V ---
	30 to 35	10	10	14	10	6	10	20	10
3P	1 to 35	10	-	14	-	6	10	20	-
2P/3P	40 to 63	-	10	-	-	6	10	20	-



Electrical diagrams

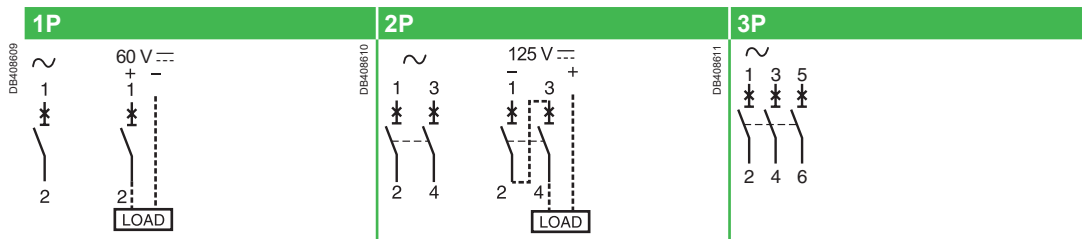

Catalog numbers

Tunnel terminal connection											
Type	UL489 and CSA voltages	1P			2P			3P			
Rating (In)		Curve			Width in 9 mm (0.35 in) modules	Curve		Width in 9 mm (0.35 in) modules	Curve		Width in 9 mm (0.35 in) modules
		Z	C	D (=K)		C	D (=K)		C	D (=K)	
C60BP											
0.5	480Y/277 V and 240 V	M9F44170	M9F42170	M9F43170	2	-	-	4	-	-	6
1		M9F44101	M9F42101	M9F43101		M9F42201	M9F43201		M9F42301	M9F43301	
2		M9F44102	M9F42102	M9F43102		M9F42202	M9F43202		M9F42302	M9F43302	
3		M9F44103	M9F42103	M9F43103		M9F42203	M9F43203		M9F42303	M9F43303	
4		M9F44104	M9F42104	M9F43104		M9F42204	M9F43204		M9F42304	M9F43304	
5		M9F44105	M9F42105	M9F43105		M9F42205	M9F43205		M9F42305	M9F43305	
6		M9F44106	M9F42106	M9F43106		M9F42206	M9F43206		M9F42306	M9F43306	
7		-	M9F42107	-		M9F42207	-		-	-	
8		M9F44108	M9F42108	M9F43108		M9F42208	M9F43208		M9F42308	M9F43308	
10		M9F44110	M9F42110	M9F43110		M9F42210	M9F43210		M9F42310	M9F43310	
13		-	M9F42113	-		M9F42213	-		-	-	
15		M9F44115	M9F42115	M9F43115		M9F42215	M9F43215		M9F42315	M9F43315	
20		M9F44120	M9F42120	M9F43120		M9F42220	M9F43220		M9F42320	M9F43320	
25	M9F44125	M9F42125	M9F43125		M9F42225	M9F43225		M9F42325	M9F43325		
30	M9F44130	M9F42130	M9F43130		M9F42230	M9F43230		M9F42330	M9F43330		
35	M9F44135	M9F42135	M9F43135		M9F42235	M9F43235		M9F42335	M9F43335		
40	240 V only	M9F44140	M9F42140	M9F43140	2	M9F42240	M9F43240	4	M9F42340	M9F43340	6
45		M9F44145	M9F42145	-		M9F42245	-		M9F42345	-	
50		M9F44150	M9F42150	-		M9F42250	-		M9F42350	-	
55		M9F44155	M9F42155	-		M9F42255	-		M9F42355	-	
63		M9F44163	M9F42163	-		M9F42263	-		M9F42363	-	
Auxiliaries		Remote indication and tripping, see page 55									
Accessories		See page 72									

Multi9 C60BP - Z, C, D curves – Tunnel terminals (cont.)

Conformity with product standards

- UL 489 branch circuit protection, document #E215117.
- CSAC22.2 No 5 branch circuit protection, document #E179014.
- IEC/EN 60947-2.
- GB 14048-2.

UL 486A connections for copper cables, document #E216919

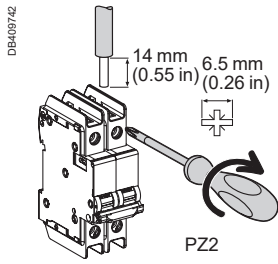

		Without accessory	
Rating	Tightening torque	Copper cables (*)	
		Rigid, flexible or with ferrule	
0.5 to 25 A	2.5 N.m (22 lb.in)	IEC 60947-2	UL 486A-B
30 to 63 A	3.5 N.m (31 lb.in)	1 to 25 mm ²	AWG #18 to #8
		1 to 35 mm ²	AWG #18 to #2

(*) See Copper Multi-cable connection chapter for more information, page 113.

Weight (g / oz)

Circuit breaker	
Type	C60BP
1P	130 g / 4.58 oz
2P	260 g / 9.17 oz
3P	390 g / 13.76 oz

Technical data

Main characteristics			
Insulation voltage (Ui)		500 V	
Service breaking capacity (Ics)	In alternating current	75 % of Icu	
	In direct current	100 % of Icu	
Pollution degree		3	
Rated impulse withstand voltage (Uimp)		6 kV	
Thermal tripping	Reference temperature	25°C / 77°F	
Magnetic tripping	Z curve	In alternating current	3 In ± 20 %
		In direct current	4.2 In ± 20 %
	C curve	In alternating current	8.5 In ± 20 %
		In direct current	12 In ± 20 %
	D curve (=K curve)	In alternating current	12 In ± 20 %
		In direct current	17 In ± 20 %

Dimensions (mm / inches)

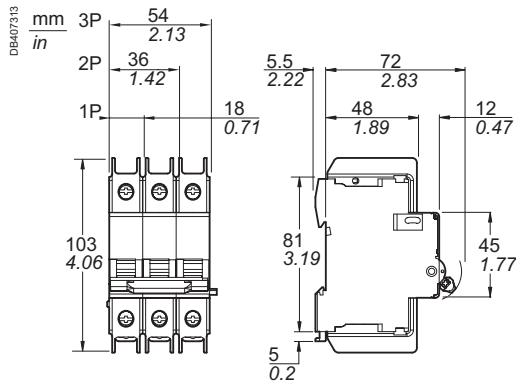

C60BPTunnel terminal

Additional characteristics		
Degree of protection Device only (IEC 60529)	Device only	IP20
	Device in modular enclosure	IP40
Endurance (O-C)	Electrical	10,000 cycles
	Mechanical	20,000 cycles
Operating temperature		-30°C to +70°C / -22°F to 158°F
Storage temperature		-40°C to +80°C / -40°F to 176°F
Tropicalization (IEC 60068-1)		Treatment 2 (relative humidity 95 % at 55°C / 131°F)
Dissipated power		See page 104

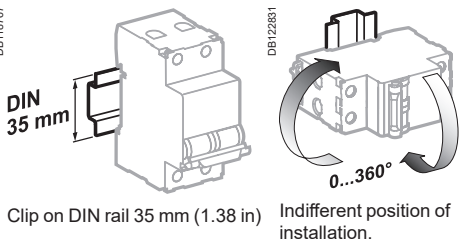

Clip on DIN rail 35 mm (1.38 in)

Indifferent position of installation.

Railways

Type	1P	2P	3P
Mass of combustible material	46.4 g / 1.64 oz	93.8 g / 3.31 oz	139.2 g / 4.91 oz
Type of combustible material	PA66 GF25 FR		
Fire and smoke requirements (EN 45545-2)	HL3 R22 / HL3 R23		
Resistance to shocks and vibrations (IEC 61373)	<ul style="list-style-type: none"> ■ Category 1 ■ Class B 		

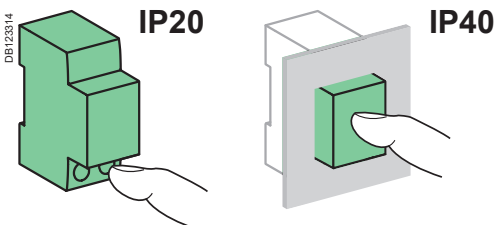

Multi9 C60BPR - Z, C, D curves – Ring-tongue terminals



UL 489 / CSA C22.2 No 5 / IEC/EN 60947-2 / GB 14048-2

As per the above standards:

C60BPR are multi-standard miniature circuit breakers and branch circuit protection as defined by UL 489. It combines following functions:

- circuit protection against short-circuit currents
- circuit protection against overload currents
- tripping and electrical fault indication by the addition of auxiliaries
- IP2X ring tongue terminal connection.



Number of poles	Rating (A) 25°C/77°F	Breaking capacity (kA rms) AIR				Icu			
		UL 489 / CSA C22.2 No 5				IEC 60947-2			
	Voltage (Ue)	277 V ~	240 V ~	120 V ~	60 V ---	440 V ~	415 V ~	240 V ~	60 V ---
1P	1 to 35	10	14	14	10	-	3	10	20
	40 to 63	-	10	10	10	-	3	10	20
2P	1 to 25	480Y/277 V ~		240 V ~	125 V ---	440 V ~	415 V ~	240 V ~	125 V ---
	30 to 35	10	14	-	-	6	10	20	-
3P	1 to 35	10	14	-	-	6	10	20	-
2P/3P	40 to 63	-	10	□	-	6	10	20	-



Electrical diagrams

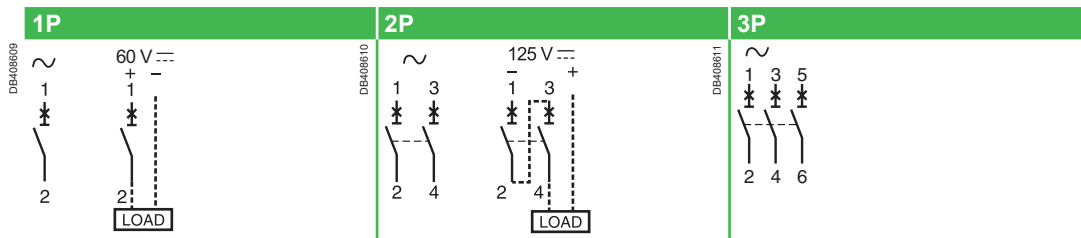

Catalog numbers

Ring tongue terminal connection											
Type	UL489 and CSA voltages	1P			2P			3P			
Rating (In)		Curve			Width in 9 mm (0.35 in) modules	Curve		Width in 9 mm (0.35 in) modules	Curve		Width in 9 mm (0.35 in) modules
		Z	C	D (=K)		C	D (=K)		C	D (=K)	
C60BPR											
1	480Y/277 V and 240 V	M9F54101	M9F52101	M9F53101	2	M9F52201	M9F53201	4	M9F52301	M9F53301	6
2		M9F54102	M9F52102	M9F53102		M9F52202	M9F53202		M9F52302	M9F53302	
4		M9F54104	M9F52104	M9F53104		M9F52204	M9F53204		M9F52304	M9F53304	
6		M9F54106	M9F52106	M9F53106		M9F52206	M9F53206		M9F52306	M9F53306	
8		M9F54108	M9F52108	M9F53108		M9F52208	M9F53208		M9F52308	M9F53308	
10		M9F54110	M9F52110	M9F53110		M9F52210	M9F53210		M9F52310	M9F53310	
15		M9F54115	M9F52115	M9F53115		M9F52215	M9F53215		M9F52315	M9F53315	
20		M9F54120	M9F52120	M9F53120		M9F52220	M9F53220		M9F52320	M9F53320	
25		M9F54125	M9F52125	M9F53125		M9F52225	M9F53225		M9F52325	M9F53325	
30		M9F54130	M9F52130	M9F53130		M9F52230	M9F53230		M9F52330	M9F53330	
35	M9F54135	M9F52135	M9F53135	M9F52235	M9F53235	M9F52335	M9F53335				
40	240 V only	M9F54140	M9F52140	M9F53140	2	M9F52240	M9F53240	4	M9F52340	M9F53340	6
45		M9F54145	M9F52145	-		M9F52245	-		M9F52345	-	
50		M9F54150	M9F52150	-		M9F52250	-		M9F52350	-	
63		M9F54163	M9F52163	-		M9F52263	-		M9F52363	-	
Auxiliaries		Remote indication and tripping, see page 55									
Accessories		See page 72									

Multi9 C60BPR - Z, C, D curves – Ring-tongue terminals (cont.)

1

Conformity with product standards

- UL 489 branch circuit protection, document #E215117.
- CSA C22.2 No 5 branch circuit protection, document #E179014.
- IEC/EN 60947-2.
- GB 14048-2.

UL 486A connections for copper wires, document #E216919

With accessory

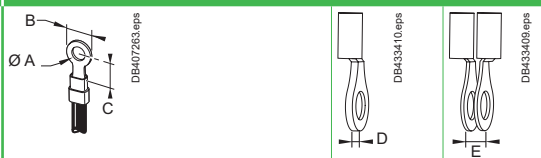
Rating	Tightening torque	Screw-on connection for ring terminal
1 to 63 A	2 N.m (18 lb.in)	 <p>A: Ø 6 mm (Ø 0.24 in) B: 12 mm +0.4/-2 (0.47 in +0.02/-0.08) C: 7.15 mm (0.28 in) minimum value D: 3 mm (0.12 in) maxi or E: 2 x 1.5 mm (2 x 0.06 in)</p>

Note: Please check instruction sheet QGH7334601 for proper cable insertion

Weight (g / oz)

Circuit breaker	
Type	C60BPR
1P	130 g / 4.58 oz
2P	260 g / 9.17 oz
3P	390 g / 13.76 oz

Dimensions

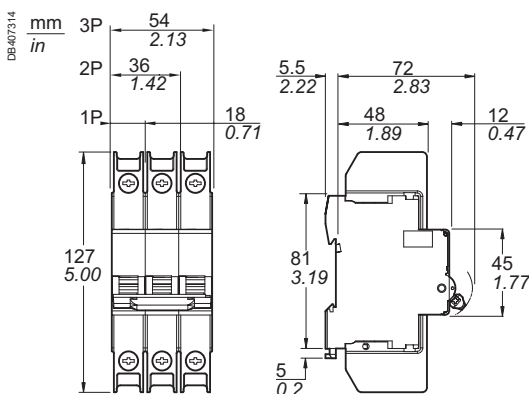

C60BPR Ring tongue terminal

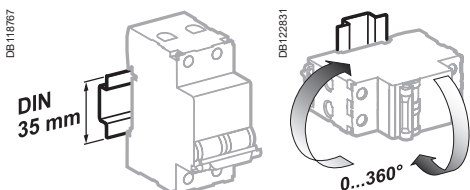

Clip on DIN rail 35 mm (1.38 in) Indifferent position of installation.

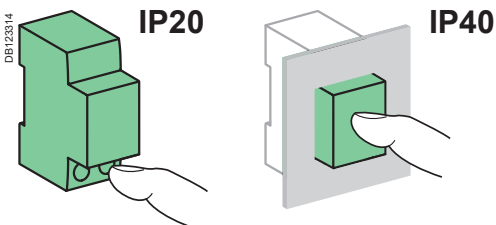

Technical data

Main characteristics			
Insulation voltage (Ui)		500 V	
Service breaking capacity (Ics) In alternating current		75 % of Icu	
	In direct current	100 % of Icu	
Pollution degree		3	
Rated impulse withstand voltage (Uimp)		6 kV	
Thermal tripping	Reference temperature	25°C / 77°F	
Magnetic tripping	Z curve	In alternating current	3 In ± 20 %
		In direct current	4.2 In ± 20 %
	C curve	In alternating current	8.5 In ± 20 %
		In direct current	12 In ± 20 %
	D curve (=K curve)	In alternating current	12 In ± 20 %
		In direct current	17 In ± 20 %
Additional characteristics			
Degree of protection (IEC 60529)	Device only	IP20	
	Device in modular enclosure	IP40	
Endurance (O-C)	Electrical	10,000 cycles	
	Mechanical	20,000 cycles	
Operating temperature		-30°C to +70°C / -22°F to 158°F	
Storage temperature		-40°C to +80°C / -40°F to 176°F	
Tropicalization (IEC 60068-1)		Treatment 2 (relative humidity 95 % at 55°C / 131°F)	
Dissipated power		See page 104	

Railways



Type	1P	2P	3P
Mass of combustible material	46.4 g / 1.64 oz	93.8 g / 3.31 oz	139.2 g / 4.91 oz
Type of combustible material	PA66 GF25 FR		
Fire and smoke requirements (EN 45545-2)	HL3 R22 / HL3 R23		
Resistance to shocks and vibrations (IEC 61373)	<ul style="list-style-type: none"> ■ Category 1 ■ Class B 		

Multi9 C60sP - B, C, D curves – Tunnels terminals



UL 1077 / CSA C22.2 No 235 / IEC/EN 60947-2 / GB 14048-2

As per the above standards:

C60sP are multi-standard miniature circuit breakers and supplementary protection as defined by UL 1077. It combines following functions:

- circuit protection against short-circuit currents
- circuit protection against overload currents
- tripping and electrical fault indication by the addition of auxiliaries.



Number of 18 mm (0.71 in) poles	Rating (A) 25°C/77°F	Breaking capacity (kA rms) AIR				Icu			
		UL 1077 / CSA C22.2 No 235				IEC 60947-2			
1P	0.5 to 32	277 V ~	240 V ~	120 V ~	65 V ~	440 V ~	415 V ~	240 V ~	60 V ~
	40 to 63	10	14	14	10	-	3	10	20
2P	1 to 25	480Y/277 V ~		240 V ~	125 V ~	440 V ~	415	240 V ~	125 V ~
	32	10	14	14	10	6	10	20	10
3P/4P	2 to 32	10	14	-	-	6	10	20	-
2P/3P/4P	40 to 63	5	10	□	□	6	10	20	-

Electrical diagrams

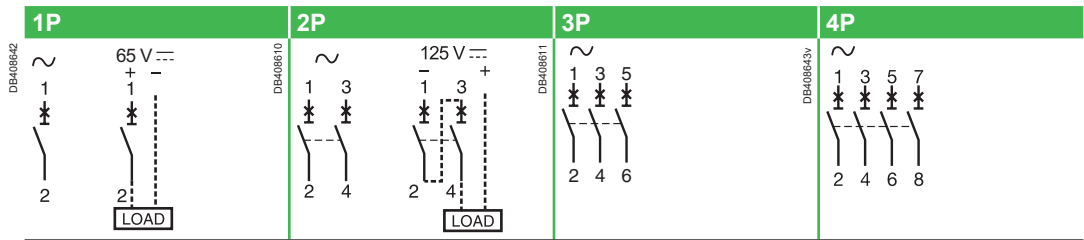

Catalog numbers

Tunnel terminal connection								
Type	1P			Width in 9 mm (0.35 in) modules	2P			Width in 9 mm (0.35 in) modules
Rating (In)	Curve	B	C		D (=K)	Curve	B	
C60sP								
0.5	M9F21170	M9F22170	M9F23170	2	-	-	-	4
1	M9F21101	M9F22101	M9F23101		M9F21201	M9F22201	M9F23201	
2	M9F21102	M9F22102	M9F23102		M9F21202	M9F22202	M9F23202	
3	M9F21103	M9F22103	M9F23103		M9F21203	M9F22203	M9F23203	
4	M9F21104	M9F22104	M9F23104		M9F21204	M9F22204	M9F23204	
5	M9F21105	M9F22105	M9F23105		M9F21205	M9F22205	M9F23205	
6	M9F21106	M9F22106	M9F23106		M9F21206	M9F22206	M9F23206	
8	M9F21108	M9F22108	M9F23108		M9F21208	M9F22208	M9F23208	
10	M9F21110	M9F22110	M9F23110		M9F21210	M9F22210	M9F23210	
13	M9F21113	M9F22113	M9F23113		M9F21213	M9F22213	M9F23213	
16	M9F21116	M9F22116	M9F23116		M9F21216	M9F22216	M9F23216	
20	M9F21120	M9F22120	M9F23120		M9F21220	M9F22220	M9F23220	
25	M9F21125	M9F22125	M9F23125		M9F21225	M9F22225	M9F23225	
32	M9F21132	M9F22132	M9F23132		M9F21232	M9F22232	M9F23232	
40	M9F21140	M9F22140	M9F23140		M9F21240	M9F22240	M9F23240	
45	M9F21145	M9F22145	-		M9F21245	M9F22245	-	
50	M9F21150	M9F22150	-	M9F21250	M9F22250	-		
63	M9F21163	M9F22163	-	M9F21263	M9F22263	-		
Auxiliaries	Remote indication and tripping, see page 55							
Accessories	See page 72							

Multi9 C60SP - B, C, D curves – Tunnels terminals (cont.)

1

Conformity with product standards

- UL 1077 supplementary protection , document #E90509.
- CSA C22.2 No. 235 supplementary protection, document #E179014.
- IEC/EN 60947-2.
- GB 14048-2.

UL 486A connections for copper cables, document #E216919

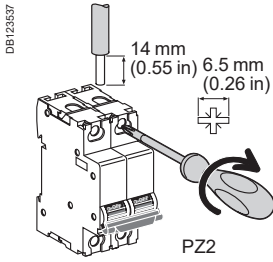

Without accessory

Rating	Tightening torque	Copper cables (*)	
		Rigid, flexible or with ferrule	
0.5 to 25 A	2.5 N.m (22 lb.in)	IEC 60947-2	UL 486A-B
30 to 63 A	3.5 N.m (31 lb.in)	1 to 25 mm ²	AWG #18 to #8
		1 to 35 mm ²	AWG #18 to #2

(*) See Copper Multi-cable connection chapter for more information, page 113.

Weight (g / oz)

Circuit-breaker	
Type	C60SP
1P	120 g / 4.23 oz
2P	240 g / 8.46 oz
3P	360 g / 12.70 oz
4P	480 g / 16.93 oz

Dimensions (mm / inches)

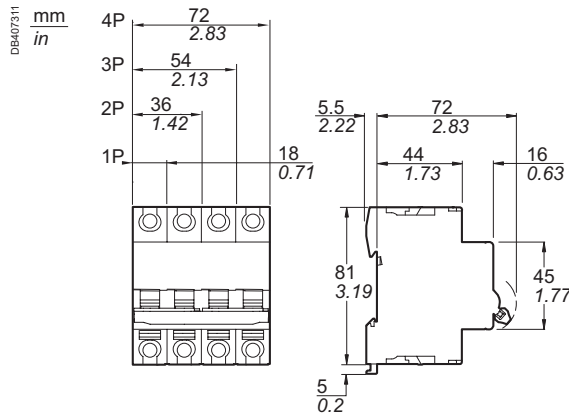

C60SP Tunnel terminal connection

3P				4P			
Curve			Width in 9 mm (0.35 in) modules	Curve			Width in 9 mm (0.35 in) modules
B	C	D (=K)		B	C	D (=K)	
-	-	-	6	-	-	-	8
-	-	-		-	-	-	
M9F21302	M9F22302	M9F23302		M9F21402	M9F22402	M9F23402	
-	-	-		-	-	-	
-	-	-		-	-	-	
-	-	-		-	-	-	
M9F21306	M9F22306	M9F23306		M9F21406	M9F22406	M9F23406	
M9F21308	M9F22308	M9F23308		M9F21408	M9F22408	M9F23408	
M9F21310	M9F22310	M9F23310		M9F21410	M9F22410	M9F23410	
M9F21313	M9F22313	M9F23313		M9F21413	M9F22413	M9F23413	
M9F21316	M9F22316	M9F23316		M9F21416	M9F22416	M9F23416	
M9F21320	M9F22320	M9F23320		M9F21420	M9F22420	M9F23420	
M9F21325	M9F22325	M9F23325		M9F21425	M9F22425	M9F23425	
M9F21332	M9F22332	M9F23332		M9F21432	M9F22432	M9F23432	
M9F21340	M9F22340	M9F23340	M9F21440	M9F22440	M9F23440		
M9F21345	M9F22345	-	M9F21445	M9F22445	-		
M9F21350	M9F22350	-	M9F21450	M9F22450	-		
M9F21363	M9F22363	-	M9F21463	M9F22463	-		

Multi9 C60sP - B, C, D curves – Tunnels terminals (cont.)

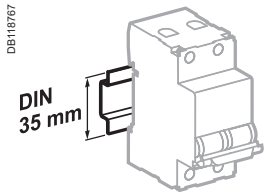

Clip on DIN rail 35 mm (1.38 in)

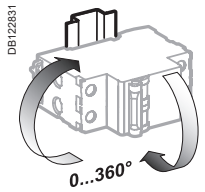

Indifferent position of installation.

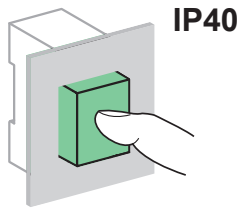
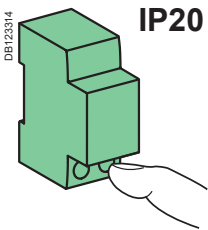

Technical data

Main characteristics			
Insulation voltage (Ui)		500 V	
Service breaking capacity (Ics)	In alternating current	75 % of Icu	
	In direct current	100 % of Icu	
Pollution degree		3	
Rated impulse withstand voltage (Uimp)		6 kV	
Thermal tripping	Reference temperature	25°C / 77°F	
Magnetic tripping	B curve	In alternating current	4 In ± 20 %
		In direct current	5.7 In ± 20 %
	C curve	In alternating current	8.5 In ± 20 %
		In direct current	12 In ± 20 %
	D curve (=K curve)	In alternating current	12 In ± 20 %
		In direct current	17 In ± 20 %
Additional characteristics			
Degree of protection (IEC 60529)	Device only	IP20	
	Device in modular enclosure	IP40	
Endurance (O-C)	Electrical	10,000 cycles	
	Mechanical	20,000 cycles	
Operating temperature		-30°C to +70°C / -22°F to 158°F	
Storage temperature		-40°C to +80°C / -40°F to 176°F	
Tropicalization (IEC 60068-1)		Treatment 2 (relative humidity 95 % at 55°C / 131°F)	
Dissipated power		See page 104	

Railways

Type	1P	2P	3P	4P
Mass of combustible material	46.4 g / 1.64 oz	93.8 g / 3.31 oz	139.2 g / 4.91 oz	185.6 g / 6.55 oz
Type of combustible material	PA66 GF25 FR			
Fire and smoke requirements (EN 45545-2)	HL3 R22 / HL3 R23			
Resistance to shocks and vibrations (IEC 61373)	<ul style="list-style-type: none"> ■ Category 1 ■ Class B 			



IEC/EN 60947-2, GB 14048.2, UL1077

As per the above standards:
C60H-DC are multi-standard miniature circuit breakers and supplementary protection as defined by UL 1077 dedicated to direct current. It combines following functions:

- circuit protection against short-circuit currents,
- circuit protection against overload currents,
- tripping and electrical fault indication by the addition of auxiliaries.



Number of 18 mm (0.71 in) poles	Rating (A) 25°C/77°F	Breaking capacity (kA rms)				
		AIR UL 1077	Icu IEC 60947-2			
Voltage (Ue)		12...250 V ---	110 V ---	220 V ---	250 V ---	
1P	0.5 to 63	5	20	10	6	
Voltage (Ue)		12...500 V ---		220 V ---	440 V ---	500 V ---
2P	0.5 to 63	5	-	20	10	6



Electrical diagrams

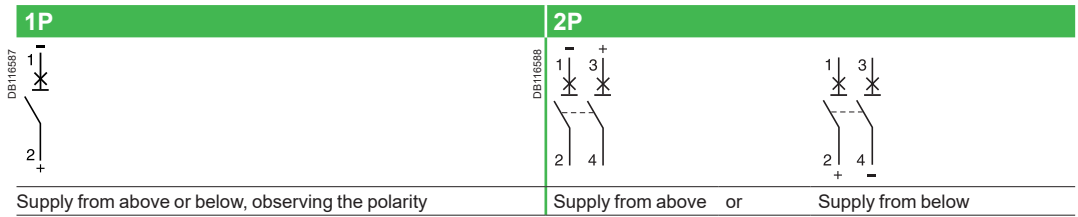

Catalog numbers

C60H-DC									
Type	1P			Width in 9 mm (0.35 in) modules	2P			Width in 9 mm (0.35 in) modules	
	Curve	B	C		D (=K)	Curve	B		C
Rating (In)									
C60H-DC									
0.5	-	M9U21170	-	2	-	M9U21270	-	4	
1	-	M9U21101	M9U31101		-	M9U21201	M9U31201		
2	-	M9U21102	M9U31102		-	M9U21202	M9U31202		
3	-	M9U21103	M9U31103		-	M9U21203	M9U31203		
4	-	M9U21104	M9U31104		-	M9U21204	M9U31204		
6	M9U11106	M9U21106	M9U31106		M9U11206	M9U21206	M9U31206		
10	M9U11110	M9U21110	M9U31110		M9U11210	M9U21210	M9U31210		
13	M9U11113	M9U21113	M9U31113		M9U11213	M9U21213	M9U31213		
16	M9U11116	M9U21116	M9U31116		M9U11216	M9U21216	M9U31216		
20	M9U11120	M9U21120	M9U31120		M9U11220	M9U21220	M9U31220		
25	M9U11125	M9U21125	M9U31125		M9U11225	M9U21225	M9U31225		
32	M9U11132	M9U21132	M9U31132		M9U11232	M9U21232	M9U31232		
40	M9U11140	M9U21140	M9U31140		M9U11240	M9U21240	M9U31240		
50	M9U11150	M9U21150	M9U31150		M9U11250	M9U21250	M9U31250		
63	M9U11163	M9U21163	M9U31163		M9U11263	M9U21263	M9U31263		
Auxiliaries	Remote indication and tripping, see page 55								
Accessories	See page 72								

Miniature Circuit Breakers

Multi9 C60H-DC - B, C, K curves – Tunnels terminals For DC circuits only (cont.)

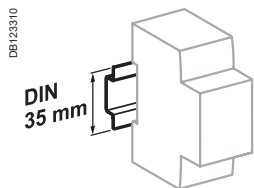

Clip on DIN rail 35 mm (1.38 in)

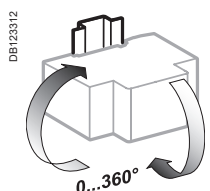

Indifferent position of installation.

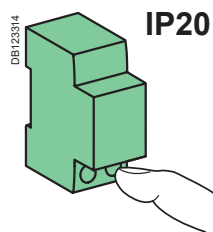

IP20

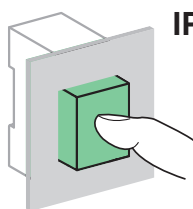

IP40

Weight (g / oz)

Circuit breaker	
Type	C60H-DC
1P	128 g / 4.51 oz
2P	256 g / 9.03 oz

Technical data

Main characteristics		
Insulation voltage (U _i)		500 V DC
Rated service breaking capacity (I _{cs})		75 % of I _{cu}
Pollution degree		3
Rated impulse withstand voltage (U _{imp}) under frame		6 kV
Thermal tripping	Reference temperature	25°C / 77°F
Magnetic tripping (I _i)	B curve	Between 3 and 7 I _n
	C curve	Between 7 and 10 I _n
	D curve (=K curve)	Between 10 and 14 I _n
Additional characteristics		
Degree of protection (IEC 60529)	Device only	IP20
	Device in modular enclosure	IP40 Insulation class II
Endurance (O-C)	Electrical	3,000 cycles (where L/R=2 ms) 6,000 cycles where the circuit is resistive
	Mechanical	20,000 cycles
Utilization category		A (no delay in accordance with IEC/EN 60947-2 standards)
Operating temperature		-25°C to 70°C / -13°F to 158°F
Storage temperature		-40°C to 85°C / -40°F to 185°F
Tropicalization (IEC 60068-1)		Treatment 2 (relative humidity 95 % at 55°C / 131°F)
Dissipated power		See page 104



Failure to match polarity during connection may lead to a fire hazard and/or serious injury.

- The connection polarity must be observed (marked on the front panel).
- Use only with direct current.
- If two poles are used in series for the American network, use at least a 12 inch / 30 cm cable.

Connection

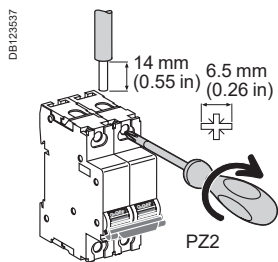

Rating	Tightening torque	Without accessory	
		Copper cables (*)	
		Rigid, flexible or with ferrule	
0.5 to 25 A	2.5 N.m (22 lb.in)	IEC 60947-2	UL 486A-B
30 to 63 A	3.5 N.m (31 lb.in)	1 to 25 mm ²	AWG #18 to #8
		1 to 35 mm ²	AWG #18 to #2

(*) See Copper Multi-cable connection chapter for more information, page 113.

Dimensions (mm / inches)

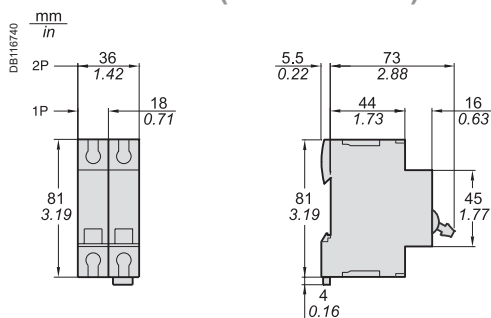

C60H-DC

Railways

Type	1P	2P
Mass of combustible material	39.3 g / 1.39 oz	78.6 g / 2.77 oz
Type of combustible material	PA6 GF20 FR	
Fire and smoke requirements (EN 45545-2)	HL2 R22 / HL2 R23	
Resistance to shocks and vibrations (IEC 61373)	<ul style="list-style-type: none"> ■ Category 1 ■ Class B 	



Schneider Electric

Automatic Shrink Wrap Machine

Speed 164 /Min

Temperature: 79.9, 19.4, 753

Status Monitor

Start Stop Reset

Transform

- Translate
- Rotate
- Scale
- Mirror
- Crash
- Edit
- Duplicate
- Duplicate Linked
- Delete
- Cell Fracture
- Cell Fracture
- History
- 3D Dev Tools

1

Miniature Circuit Breakers

Multi9 C60N - B, C, D curves



C60N 1P



C60N 3P



C60N 2P



C60N 4P

IEC/EN 60947-2

As per the above standards:

- C60N circuit breakers are circuit breakers which combine the following functions:
 - circuit protection against short-circuit currents,
 - circuit protection against overload currents,
 - breaking and industrial disconnection as per standards IEC/EN 60947-2.
- A green strip on the toggle indicates full opening of all the poles allowing downstream maintenance operation.

- Increased product service life thanks:
 - overvoltage resistance,
 - high performance limitation,
 - to fast closing independent of the speed of actuation of the toggle.
- Upstream or downstream connection.



- Compatible with PowerTag Energy (for 2P, only 200... 240 V AC)

Positive contact indication

- Suitability for isolation in accordance with the IEC/EN 60947-2 standard.

Alternating current (AC) 50/60 Hz					
Ultimate breaking capacity (Icu) as per IEC/EN 60947-2					Service breaking capacity (Ics)
Ph/Ph (2P, 3P, 4P)	Voltage (Ue)				
	240 V	415 V	-	440 V	75 % of Icu
Ph/N (1P)	-	240 V	415 V	-	
Rating (In)	1 to 63 A	20 kA	10 kA	3 kA ^(*)	6 kA
i_{tr}	1.2 x 12 In				

(*) Breaking capacity under 1 pole with IT isolated neutral system (case of double fault).

Direct current (DC)					
Breaking capacity (Icu) according to IEC/EN 60947-2					Service breaking capacity (Ics)
Between +/-	Voltage (Ue)				
	≤ 72 V	≤ 125 V	≤ 180 V	≤ 250 V	100 % of Icu
Number of poles	1P	2P	3P	4P	
Rating (In) 1 to 63 A	15 kA	20 kA	30 kA	40 kA	

Catalog numbers



C60N circuit breaker												
Type	1P			2P			3P			4P		
Rating (In)	Curve			Curve			Curve			Curve		
	B	C	D	B	C	D	B	C	D	B	C	D
1 A	M9F10101	M9F11101	M9F12101	M9F10201	M9F11201	M9F12201	M9F10301	M9F11301	M9F12301	M9F10401	M9F11401	M9F12401
2 A	M9F10102	M9F11102	M9F12102	M9F10202	M9F11202	M9F12202	M9F10302	M9F11302	M9F12302	M9F10402	M9F11402	M9F12402
3 A	M9F10103	M9F11103	M9F12103	M9F10203	M9F11203	M9F12203	M9F10303	M9F11303	M9F12303	M9F10403	M9F11403	M9F12403
4 A	M9F10104	M9F11104	M9F12104	M9F10204	M9F11204	M9F12204	M9F10304	M9F11304	M9F12304	M9F10404	M9F11404	M9F12404
6 A	M9F10106	M9F11106	M9F12106	M9F10206	M9F11206	M9F12206	M9F10306	M9F11306	M9F12306	M9F10406	M9F11406	M9F12406
10 A	M9F10110	M9F11110	M9F12110	M9F10210	M9F11210	M9F12210	M9F10310	M9F11310	M9F12310	M9F10410	M9F11410	M9F12410
13 A	M9F10113	M9F11113	M9F12113	M9F10213	M9F11213	M9F12213	M9F10313	M9F11313	M9F12313	M9F10413	M9F11413	M9F12413
16 A	M9F10116	M9F11116	M9F12116	M9F10216	M9F11216	M9F12216	M9F10316	M9F11316	M9F12316	M9F10416	M9F11416	M9F12416
20 A	M9F10120	M9F11120	M9F12120	M9F10220	M9F11220	M9F12220	M9F10320	M9F11320	M9F12320	M9F10420	M9F11420	M9F12420
25 A	M9F10125	M9F11125	M9F12125	M9F10225	M9F11225	M9F12225	M9F10325	M9F11325	M9F12325	M9F10425	M9F11425	M9F12425
32 A	M9F10132	M9F11132	M9F12132	M9F10232	M9F11232	M9F12232	M9F10332	M9F11332	M9F12332	M9F10432	M9F11432	M9F12432
40 A	M9F10140	M9F11140	M9F12140	M9F10240	M9F11240	M9F12240	M9F10340	M9F11340	M9F12340	M9F10440	M9F11440	M9F12440
50 A	M9F10150	M9F11150	-	M9F10250	M9F11250	-	M9F10350	M9F11350	-	M9F10450	M9F11450	-
63 A	M9F10163	M9F11163	-	M9F10263	M9F11263	-	M9F10363	M9F11363	-	M9F10463	M9F11463	-
Width in 9-mm (0.35 in) mod.	2			4			6			8		
Vigi C60	See page 44											
Auxiliaries	See page 55											
Accessories	See page 55											
PowerTag energy sensors	See PowerLogic catalog: PLS3D30905EN											

Miniature Circuit Breakers

Multi9 C60N - B, C, D curves (cont.)

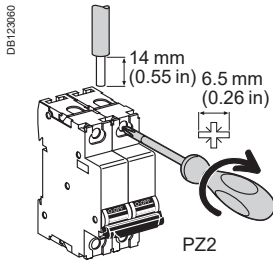
Connection



Rating	Tightening torque	Without accessory	
		Copper cables (*)	
		Rigid, flexible or with ferrule	
1 to 25 A	2.5 N.m / 22 lb.in		
32 to 63 A	3.5 N.m / 31 lb.in	1 to 25 mm ²	AWG #18 to #8
		1 to 35 mm ²	AWG #18 to #2

(*) See Copper Multi-cable connection chapter for more information, page 113.

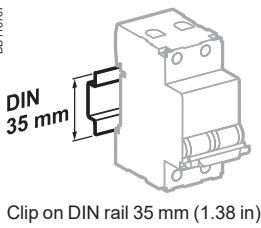

Clip on DIN rail 35 mm (1.38 in)

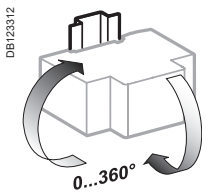

Indifferent position of installation.

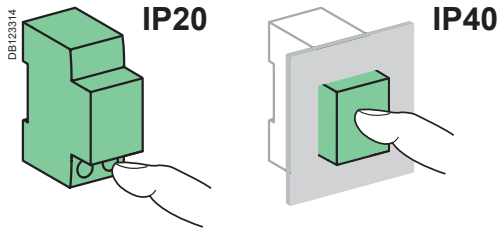

Technical data

According to IEC/EN 60947-2			
Insulation voltage (Ui)		500 V AC	
Pollution degree		3	
Rated impulse withstand voltage (Uimp)		6 kV	
Thermal tripping	Reference temperature	50°C / 122°F	
Magnetic tripping (Ii)	B curve	in alternative current	4 In ± 20 %
		in direct current	5.7 In (± 20 %)
C curve	in alternative current		8.5 In ± 20 %
	in direct current		12 In (± 20 %)
D curve	in alternative current		12 In ± 20 %
	in direct current		17 In (± 20 %)
According to current frequency			50/60 Hz
Utilization category			A
Additional characteristics			
Degree of protection (IEC 60529)	Device only		IP20
	Device in modular enclosure		IP40
Endurance (O-C)	Electrical		10,000 cycles
	Mechanical		20,000 cycles
Service temperature			-30°C to +70°C / -22°F to 158°F
Storage temperature			-40°C to +80°C / -40°F to 176°F
Tropicalization (IEC 60068-1)			Treatment 2 (relative humidity 95 % at 55°C / 131°F)
Dissipated power			See page 104

Weight (g / oz)

Circuit breaker	
Type	C60N
1P	120 g / 4.23 oz
2P	240 g / 8.46 oz
3P	360 g / 12.70 oz
4P	480 g / 16.93 oz

Dimensions (mm / inches)

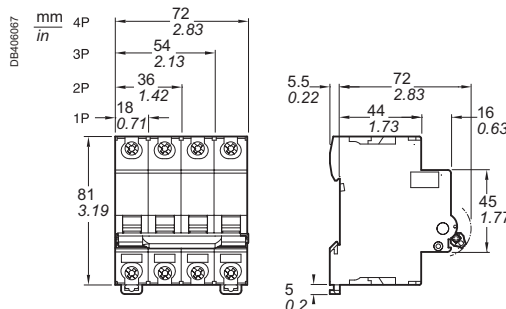

Miniature Circuit Breakers

Multi9 C60H - B, C, D curves



C60H 1P



C60H 3P



C60H 2P



C60H 4P

IEC/EN 60947-2

As per the above standards:

- C60H circuit breakers are circuit breakers which combine the following functions:
 - circuit protection against short-circuit currents,
 - circuit protection against overload currents,
 - breaking and industrial disconnection as per standards IEC/EN 60947-2.
 - A green strip on the toggle indicates full opening of all the poles allowing downstream maintenance operation.

- Increased product service life thanks:
 - overvoltage resistance,
 - high performance limitation,
 - to fast closing independent of the speed of actuation of the toggle.
 - Upstream or downstream connection.



- Compatible with PowerTag Energy

Positive contact indication

- Suitability for isolation in accordance with the IEC/EN 60947-2 standard.

Alternating current (AC) 50/60 Hz					
Ultimate breaking capacity (Icu) as per IEC/EN 60947-2					Service breaking capacity (Ics)
Ph/Ph (2P, 3P, 4P)	Voltage (Ue)				
Ph/Ph (2P, 3P, 4P)	240 V	415 V	-	440 V	50 % of Icu
Ph/N (1P)	-	240 V	415 V	-	
Rating (In) 1 to 40 A	30 kA	15 kA	3 kA ^(*)	10 kA	
i_{tr}	1.2 x 12 In				

(*) Breaking capacity under 1 pole with IT isolated neutral system (case of double fault).

Direct current (DC)					
Breaking capacity (Icu) according to IEC/EN 60947-2					Service breaking capacity (Ics)
Between +/-	Voltage (Ue)				
Between +/-	≤ 72 V	≤ 125 V	≤ 180 V	≤ 250 V	100 % of Icu
Number of poles	1P	2P	3P	4P	
Rating (In) 1 to 40 A	20 kA	25 kA	40 kA	50 kA	

Catalog numbers

C60N circuit breaker												
Type	1P			2P			3P			4P		
E45002												
Rating (In)	Curve			Curve			Curve			Curve		
	B	C	D	B	C	D	B	C	D	B	C	D
1 A	M9F13101	M9F14101	M9F15101	M9F13201	M9F14201	M9F15201	M9F13301	M9F14301	M9F15301	M9F13401	M9F14401	M9F15401
2 A	M9F13102	M9F14102	M9F15102	M9F13202	M9F14202	M9F15202	M9F13302	M9F14302	M9F15302	M9F13402	M9F14402	M9F15402
3 A	M9F13103	M9F14103	M9F15103	M9F13203	M9F14203	M9F15203	M9F13303	M9F14303	M9F15303	M9F13403	M9F14403	M9F15403
4 A	M9F13104	M9F14104	M9F15104	M9F13204	M9F14204	M9F15204	M9F13304	M9F14304	M9F15304	M9F13404	M9F14404	M9F15404
6 A	M9F13106	M9F14106	M9F15106	M9F13206	M9F14206	M9F15206	M9F13306	M9F14306	M9F15306	M9F13406	M9F14406	M9F15406
10 A	M9F13110	M9F14110	M9F15110	M9F13210	M9F14210	M9F15210	M9F13310	M9F14310	M9F15310	M9F13410	M9F14410	M9F15410
13 A	M9F13113	M9F14113	M9F15113	M9F13213	M9F14213	M9F15213	M9F13313	M9F14313	M9F15313	M9F13413	M9F14413	M9F15413
16 A	M9F13116	M9F14116	M9F15116	M9F13216	M9F14216	M9F15216	M9F13316	M9F14316	M9F15316	M9F13416	M9F14416	M9F15416
20 A	M9F13120	M9F14120	M9F15120	M9F13220	M9F14220	M9F15220	M9F13320	M9F14320	M9F15320	M9F13420	M9F14420	M9F15420
25 A	M9F13125	M9F14125	M9F15125	M9F13225	M9F14225	M9F15225	M9F13325	M9F14325	M9F15325	M9F13425	M9F14425	M9F15425
32 A	M9F13132	M9F14132	M9F15132	M9F13232	M9F14232	M9F15232	M9F13332	M9F14332	M9F15332	M9F13432	M9F14432	M9F15432
40 A	M9F13140	M9F14140	M9F15140	M9F13240	M9F14240	M9F15240	M9F13340	M9F14340	M9F15340	M9F13440	M9F14440	M9F15440
Width in 9-mm (0.35 in) mod.	2			4			6			8		
Vigi C60	See page 44											
Auxiliaries	See page 55											
Accessories	See page 72											
PowerTag energy sensors	See PowerLogic catalog: PLS309005EN											



Miniature Circuit Breakers

Multi9 C60H - B, C, D curves (cont.)

1

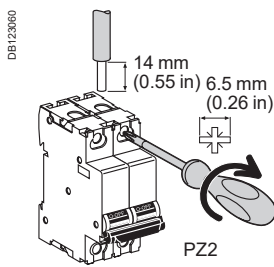
Connection



Rating	Tightening torque	Without accessory	
		Copper cables (*)	
		Rigid, flexible or with ferrule	
1 to 25 A	2.5 N.m / 22 lb.in		
32 and 40 A	3.5 N.m / 31 lb.in		

(*) See Copper Multi-cable connection chapter for more information, page 113.

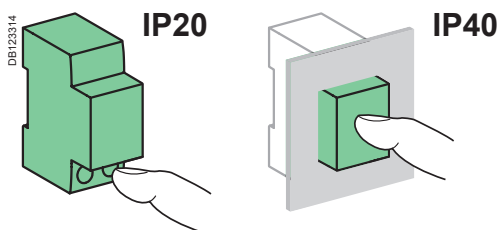
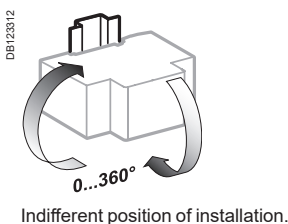
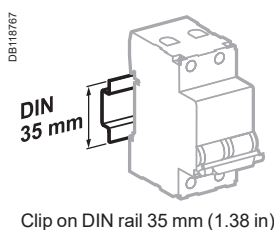

Technical data

According to IEC/EN 60947-2		
Insulation voltage (Ui)		500 V AC
Pollution degree		3
Rated impulse withstand voltage (Uimp)		6 kV
Thermal tripping	Reference temperature	50°C / 122°F
Magnetic tripping (Ii)	B curve	in alternative current in direct current
	C curve	in alternative current in direct current
D curve	in alternative current	12 In (± 20 %)
	in direct current	17 In (± 20 %)
According to current frequency		50/60 Hz
Utilization category		A
Additional characteristics		
Degree of protection (IEC 60529)	Device only	IP20
	Device in modular enclosure	IP40
Endurance (O-C)	Electrical	10,000 cycles
	Mechanical	20,000 cycles
Service temperature		-30°C to +70°C / -22°F to 158°F
Storage temperature		-40°C to +80°C / -40°F to 176°F
Tropicalization (IEC 60068-1)		Treatment 2 (relative humidity 95 % at 55°C / 131°F)
Dissipated power		See page 104

Weight (g / oz)

Circuit breaker	
Type	C60H
1P	120 g / 4.23 oz
2P	240 g / 8.46 oz
3P	360 g / 12.70 oz
4P	480 g / 16.93 oz

Dimensions (mm / inches)

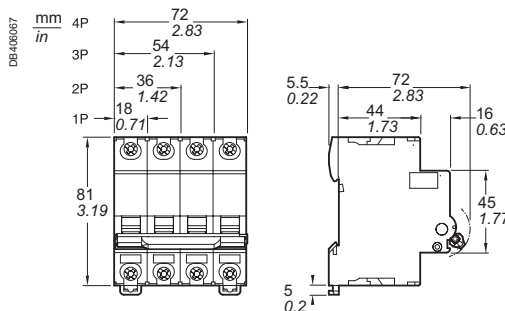

Miniature Circuit Breakers Multi9 C60L - C curve

IEC



C60L 1P



C60L 3P



C60L 2P



C60L 4P

IEC/EN 60947-2

As per the above standards:

- C60L circuit breakers are circuit breakers which combine the following functions:
 - circuit protection against short-circuit currents,
 - circuit protection against overload currents,
 - breaking and industrial disconnection as per standards IEC/EN 60947-2.
- A green strip on the toggle indicates full opening of all the poles allowing downstream maintenance operation.

- Increased product service life thanks:
 - overvoltage resistance,
 - high performance limitation,
 - to fast closing independent of the speed of actuation of the toggle.
- Upstream or downstream connection.

- Compatible with PowerTag Energy

Positive contact indication

- Suitability for isolation in accordance with the IEC/EN 60947-2 standard.

Alternating current (AC) 50/60 Hz					
Ultimate breaking capacity (Icu) as per IEC/EN 60947-2					Service breaking capacity (Ics)
Ph/Ph (2P, 3P, 4P)	Voltage (Ue)				
	240 V	415 V	-	440 V	50 % of Icu
Ph/N (1P)	-	240 V	415 V	-	
Rating (In) 1 to 25 A	50 kA	25 kA	3 kA ^(*)	20 kA	
i_{tr}	1.2 x 8.5 In				

(*) Breaking capacity under 1 pole with IT isolated neutral system (case of double fault).

Direct current (DC)					
Breaking capacity (Icu) according to IEC/EN 60947-2					Service breaking capacity (Ics)
Between +/-	Voltage (Ue)				
	≤ 72 V	≤ 125 V	≤ 180 V	≤ 250 V	100 % of Icu
Number of poles	1P	2P	3P	4P	
Rating (In) 1 to 25 A	25 kA	30 kA	50 kA	60 kA	

Catalog numbers



C60L circuit breaker				
Type	1P	2P	3P	4P
	E45092 1 2	E45094 1 3 2 4	E45095 1 3 5 2 4 6	E45097 1 3 5 7 2 4 6 8
Rating (In)	Curve C	Curve C	Curve C	Curve C
1 A	M9F17101	M9F17201	M9F17301	M9F17401
2 A	M9F17102	M9F17202	M9F17302	M9F17402
3 A	M9F17103	M9F17203	M9F17303	M9F17403
4 A	M9F17104	M9F17204	M9F17304	M9F17404
6 A	M9F17106	M9F17206	M9F17306	M9F17406
10 A	M9F17110	M9F17210	M9F17310	M9F17410
16 A	M9F17116	M9F17216	M9F17316	M9F17416
20 A	M9F17120	M9F17220	M9F17320	M9F17420
25 A	M9F17125	M9F17225	M9F17325	M9F17425
Width in 9-mm (0.35 in) modules	2	4	6	8
Vigi C60	See page 44			
Auxiliaries	See page 55			
Accessories	See page 72			
PowerTag energy sensors	See PowerLogic catalog: PLS309005EN			

Miniature Circuit Breakers

Multi9 C60L - C curve (cont.)

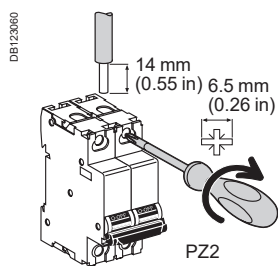
Connection



		Without accessory	
Rating	Tightening torque	Copper cables (*)	
		Rigid, flexible or with ferrule	
1 to 25 A	2.5 N.m / 22 lb.in		
		1 to 25 mm ²	AWG #18 to #8

(*) See Copper Multi-cable connection chapter for more information, page 113.

Technical data

According to IEC/EN 60947-2		
Insulation voltage (Ui)		500 V AC
Pollution degree		3
Rated impulse withstand voltage (Uimp)		6 kV
Thermal tripping	Reference temperature	50°C / 122°F
Magnetic tripping (Ii) C curve	in alternative current	8.5 In ± 20 %
	in direct current	12 In (± 20 %)
	According to current frequency	50/60 Hz
Utilization category		A
Additional characteristics		
Degree of protection (IEC 60529)	Device only	IP20
	Device in modular enclosure	IP40 Insulation class II
Endurance (O-C)	Electrical	10,000 cycles
	Mechanical	20,000 cycles
Service temperature		-30°C to +70°C / -22°F to 158°F
Storage temperature		-40°C to +80°C / -40°F to 176°F
Tropicalization (IEC 60068-1)		Treatment 2 (relative humidity 95 % at 55°C / 131°F)
Dissipated power		See page 104

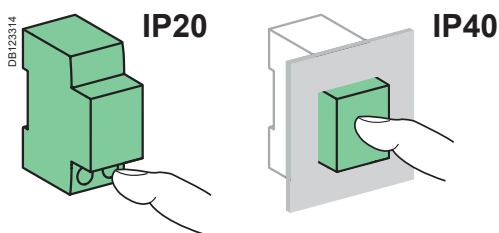
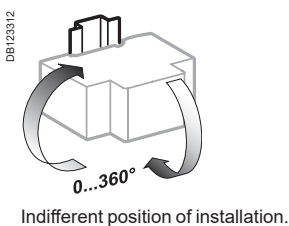
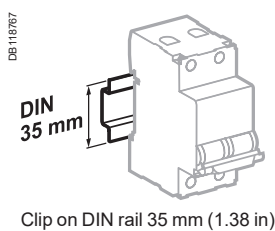

Weight (g / oz)

Circuit breaker	
Type	C60L
1P	120 g / 4.23 oz
2P	240 g / 8.46 oz
3P	360 g / 12.70 oz
4P	480 g / 16.93 oz

Dimensions (mm / inches)

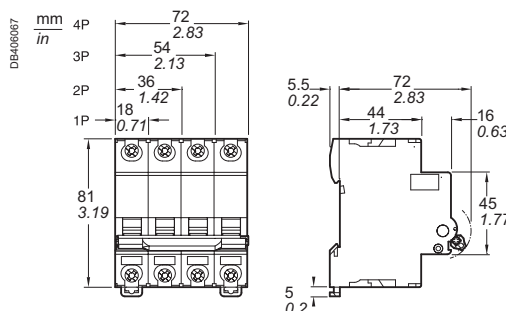

Miniature Circuit Breakers

Multi9 C60CTRL - Z, C curves

For control circuits protection

IEC



C60CTRL 1P



C60CTRL 2P

IEC/EN 60947-2.

As per the above standards:

"C60CTRL circuit breakers for the protection of control circuits" protect and isolate:

- control circuits for industrial equipment with contactor coils, transformers, small motors, etc.
- programmable controllers (PLCs), voltage presence indicators, measuring and monitoring instruments, etc.
- single-phase auxiliary circuits such as solenoid valves, battery chargers, etc.

■ C60CTRL circuit breakers combine the following features:

- protection of circuits against short-circuit and overload currents,
- breaking and isolation capability in the industrial sector to IEC/EN 60947-2.

■ A green strip on the toggle indicates full opening of all the poles allowing downstream maintenance operation.

■ The service life of the products is improved by:

- good overvoltage withstand capacity,
- fast closure, independent of handle operating speed.

■ They can be connected upstream and downstream.

Alternating current (AC) 50/60 Hz			
Breaking capacity (Icu) to IEC/EN 60947-2	Voltage (Ue)		Service breaking capacity (Ics)
	240 V	415 V	
Ph/Ph (2P)	240 V	415 V	50 % of Icu
Ph/N (1P)	-	240 V	
Rating (In) 1 to 4 A	100 kA	100 kA	

Direct current (DC)			
Breaking capacity (Icu) to IEC/EN 60947-2	Voltage (Ue)		Service breaking capacity (Ics)
	60 V	125 V	
Between +/-	60 V	125 V	100 % of Icu
Number of poles	1P	2P	
Rating (In) 1 to 4 A	25 kA	30 kA	

Catalog numbers

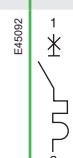
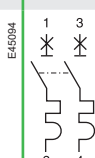
C60CTRL circuit breakers for the protection of control circuits				
Type	1P		2P	
				
Rating (In)	C curve	Z curve	C curve	Z curve
1 A	M9C01101	M9C02301	M9C01201	M9C02401
2 A	M9C01102	M9C02302	M9C01202	M9C02402
3 A	M9C01103	M9C02303	M9C01203	M9C02403
4 A	M9C01104	M9C02304	M9C01204	M9C02404
Width in 9 mm (0.35 in) modules	2		4	
Vigi C60	See page 44			
Auxiliaries	See page 55			
Accessories	See page 72			



Miniature Circuit Breakers

Multi9 C60CTRL - Z, C curves

For control circuits protection (cont.)

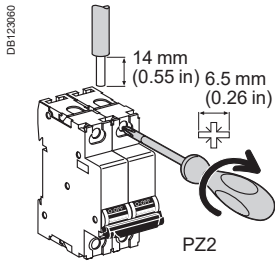
Connection



		Without accessory	
Rating	Tightening torque	Copper cables (*)	
		Rigid, flexible or with ferrule	
1 to 4 A	2.5 N.m / 22 lb.in		
		1 to 25 mm ²	AWG #18 to #8

(*) See Copper Multi-cable connection chapter for more information, page 113.

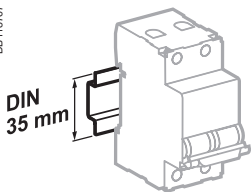

Clip on DIN rail 35 mm.

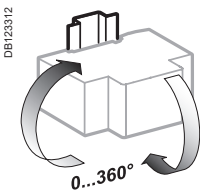

Indifferent position of installation.

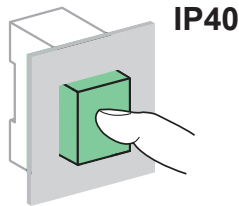
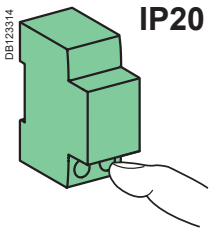

Technical data

According to IEC/EN 60947-2

Insulation voltage (Ui)	500 V AC
Pollution degree	1
Rated impulse withstand voltage (Uimp)	6 kV
Thermal tripping	Reference temperature 50°C / 122°F
Magnetic tripping (Ii)	C curve in alternative current 8.5 In ± 20 %
	in direct current 12 In (± 20 %)
Z curve	in alternative current 3 In ± 20 %
	in direct current 4.2 In (± 20 %)
According to current frequency	50/60 Hz
Utilization category	A

Additional characteristics

Degree of protection (IEC 60529)	Device only	IP20
	Device in modular enclosure	IP40
Endurance (O-C)	Electrical	10,000 cycles
	Mechanical	20,000 cycles
Operating temperature	-30°C to +70°C / -22°F to 158°F	
Storage temperature	-40°C to +80°C / -40°F to 176°F	
Tropicalization (IEC 60068-1)	Treatment 2 (relative humidity 95 % at 55°C / 131°F)	
Dissipated power	See page 104	

Weight (g / oz)

Circuit breakers

Type	C60CTRL
1P	120 g / 4.23 oz
2P	240 g / 8.46 oz

Dimensions (mm / inches)

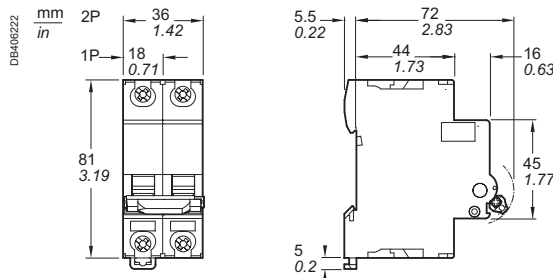

Miniature Circuit Breakers

Multi9 N40N - C curve

IEC



IEC/EN 60947-2

As per the above standards:

- N40N circuit breakers are circuit breakers which combine the following functions:
 - circuit protection against short-circuit currents,
 - circuit protection against overload currents,
 - breaking and industrial disconnection as per standards IEC/EN 60947-2.
- A green strip on the toggle indicates full opening of all the poles allowing downstream maintenance operation.

- Increased product service life thanks:
 - overvoltage resistance,
 - high performance limitation,
 - to fast closing independent of the speed of actuation of the toggle.
- Upstream or downstream connection.

- Compatible with PowerTag Energy

Positive contact indication

- Suitability for isolation in accordance with the IEC/EN 60947-2 standard.

Alternating current (AC) 50/60 Hz

Ultimate breaking capacity (Icu) as per IEC/EN 60947-2		Service breaking capacity (Ics)
	Voltage (Ue)	
Ph/Ph (3P+N)	415 V	75 % of Icu
Ph/N (1P+N)	240 V	
Rating (In) 1 to 40 A	10 kA	
i_{tr}	1.2 x 8.5 In	

Catalog numbers

N40N circuit breakers

Type	10 kA		
	1P+N	3P+N	
DB123889		DB123861	
Rating (In)	C curve	C curve	
1 A	M9P22601	-	
2 A	M9P22602	-	
3 A	M9P22603	-	
4 A	M9P22604	-	
6 A	M9P22606	M9P22706	
10 A	M9P22610	M9P22710	
16 A	M9P22616	M9P22716	
20 A	M9P22620	M9P22720	
25 A	M9P22625	M9P22725	
32 A	M9P22632	M9P22732	
40 A	M9P22640	M9P22740	
Width in 9-mm (0.35 in) mod.	2	6	
Vigi	See page 46		
Auxiliaries	See page 55		
Accessories	See page 72		
■ PowerTag energy sensors	See PowerLogic catalog: PLS309005EN		

Miniature Circuit Breakers

Multi9 N40N - C curve (cont.)

Connection

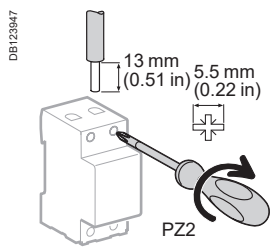

Rating	Tightening torque	Copper cables (*)			
		Rigid		Flexible or with ferrule	
1 to 40 A	2 N.m / 18 lb.in	1 to 16 mm ²	AWG #18 to #6	1 to 10 mm ²	AWG #18 to #8

(*) See Copper Multi-cable connection chapter for more information, page 113.

■ Connection by comb busbar or cables (as per EN 50027).

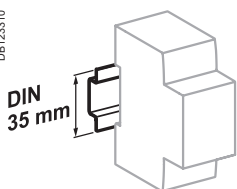

Clips on to 35 mm (1.38 in) DIN rail

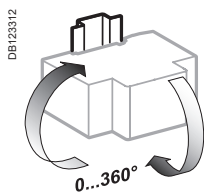

Indifferent position of installation.

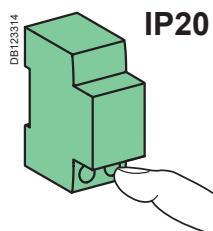

IP20

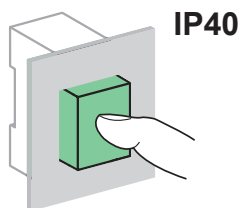

IP40

Technical data

Main characteristics			
According to IEC/EN 60947-2			
Insulation voltage (U _i)	Phase-to-phase	240...415 V AC	
Thermal tripping	Reference temperature	50°C / 122°F	
Magnetic tripping	C curve	8.5 I _n (± 20 %)	
Rated impulse withstand voltage (U _{imp})		4 kV	
Pollution degree		3	
Additional characteristics			
Degree of protection (IEC 60529)	Device only	IP20	
	Device in modular enclosure	IP40	
Endurance (O-C)	Electrical	≤ 20 A	20,000 cycles
		≥ 25 A	10,000 cycles
	Mechanical	20,000 cycles	
Operating temperature		-25°C to +70°C / -13°F to 158°F	
Storage temperature		-40°C to +70°C / -40°F to 158°F	
Tropicalization (IEC 60068-1)		Treatment 2 (relative humidity 95 % at 55°C / 131°F)	
Dissipated power		See page 104	

Dimensions (mm / inches)

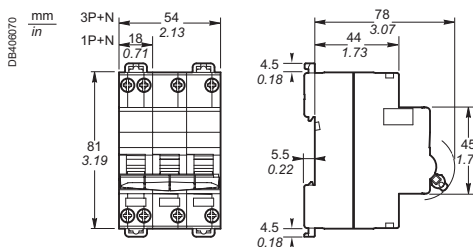

Weight (g / oz)

Circuit breakers	
Type	N40N
1P+N	115 g / 4.06 oz
3P+N	322 g / 11.35 oz

Multi9 GFP - Ground Fault Protector



IEC/EN 61008-1 UL 1053

As per the above standards:

UL 1053 residual current circuit breakers already protected upstream by a circuit breaker device are used for:

- control and disconnection of electric circuits
- protection of people against electric shock by direct and indirect contacts
- protection of installations against insulation faults
- enhanced continuity of supply, during a series of close lightning strokes, IT earthing system, equipment including interference suppression filters, variable speed controllers, frequency converters, electronic ballasts for lighting
- enhanced earth leakage protection: in presence of harmonics or high frequency rejections.

They comply with RCD standards UL 1053 and IEC/EN 61008.

A-SI type GFPs are ideal for operation in environments with a humid atmosphere and/or polluted by aggressive agents: swimming pools, marinas, agri-food industries, water treatment stations, industrial sites, etc.

Catalog numbers

GFP UL 1053 A-SI type						
A-SI type	Rating (A)	Sensitivity (mA)		Cat. no.		Width in mod. of 9 mm (0.35 in)
		UL 1053	IEC/EN 61008	120 or 240 V 230 or 240 V	240 V 480Y/277 V 230/400 or 240/415 V	
2P						
	25	26	30	M9R81225	M9R41225	4
		86	100	M9R12225	-	
		260	300	M9R84225	M9R44225	
	40	26	30	M9R81240	M9R41240	
		260	300	M9R84240	-	
		63	26	30	M9R81263	
4P						
	25	26	30	-	M9R81425	8
		86	100	-	M9R12425	
		260	300	-	M9R84425	
	40	26	30	-	M9R81440	
		260	300	-	M9R84440	
		63	26	30	-	
	100	86	100	-	M9R12463	
		86	100	-	M9R12491	
		260	300	-	M9R84491	
Auxiliaries		2P: without auxiliaries				
Accessories		4P: see page 55				
Voltage rating (Ue)		2P	230 - 240 V			
		4P	400 - 415 V			
Operating frequency		50/60 Hz				

UL 486A connections for copper cables, document #E216919

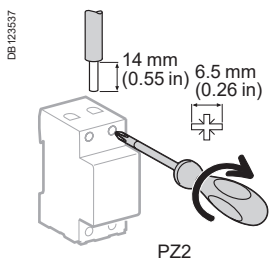

Rating	Tightening torque	Without accessory	
		Copper cables (*)	
		Rigid, flexible or with ferrule	
25 to 100 A	3.5 N.m / 31 lb.in		
		IEC/EN 61008-1	UL 486A-B
		1 to 35 mm ²	AWG #18 to #2

(*) See Copper Multi-cable connection chapter for more information, page 113.

Multi9 GFP - Ground Fault Protector (cont.)

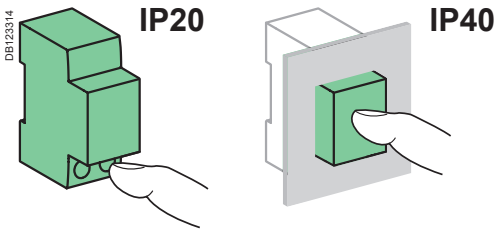
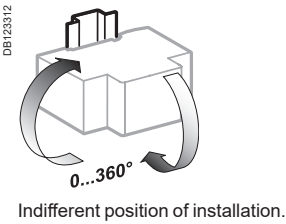
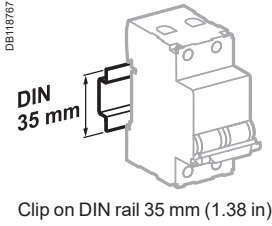

Technical data

GFP UL 1053 A-SI type

Technical data	
Insulation voltage (Ui)	440 V
Pollution degree	3
Making and breaking capacity: rated residual current (I Δ m)	1 500 A
Rated impulse withstand voltage (Uimp)	6 kV
Utilisation category	AC 23A
Level of immunity	In current wave 8/20 μ s: 3 kA In dampened recurrent current wave 0.5 μ s/100 kHz: 200 A
Short-circuit current withstand (I Δ c = Inc)	10 kA with 100 A gG upstream fuse
Test button minimum operating voltage	2P 113 V AC 4P 189 V AC
Phase-to-phase test circuit	To avoid external bridging on use on three-phase network without neutral
Locking possible in "tripped" position	By padlocking facility (not supplied)
Release with fixed sensitivity for all ratings	Instantaneous release: UL 1053 : \pm 15 % IEC/EN 61008 : +0 %, -50 %
Behaviour in case of voltage drop	Residual current protection down to 0 V according to IEC/EN 61008-1 § 3.3.4
Earth fault indication	On front face by red mechanical indicator
Number of cycles (O-C)	20,000 cycles
Degree of protection (IEC 60529)	Device only IP20 Device in modular enclosure IP40 Insulation class II
Operating temperature	-25°C to +60°C / -13°F to 140°F
Storage temperature	-40°C to +70°C / -40°F to 158°F
Tropicalization (IEC 60068-1)	Treatment 2 (relative humidity 95 % at 55°C / 131°F)
Dissipated power	See page 104

2

Weight (g / oz)

GFP UL 1053 A-SI type

Type	GFP
2P	220 g / 7.76 oz
4P	450 g / 15.87 oz

Dimensions (mm / inches)

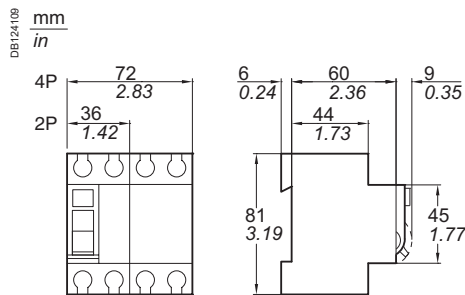

Residual current devices

Acti9 iID B-SI type Residual Current Circuit Breakers (RCCB)

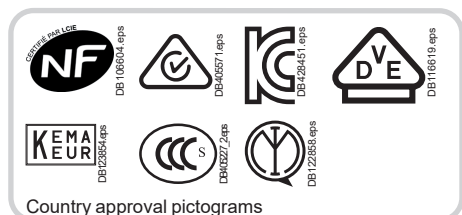

IEC/EN 61008-2-1, IEC/EN 62423
IEC 61543 ,VDE 0664

As per the above standards:

- The Acti9 iID B-SI type residual current circuit breakers provide:
 - protection of persons against electric shock by direct contact (30 mA),
 - protection of persons against electric shock by indirect contact (≥ 300 mA),
 - protection of installations against the risk of fire (300 mA or 500 mA).

B-SI type

The Acti9 iID B-SI type residual current circuit breakers provide:

- protection in the event of a continuous earth fault current on networks generated by:
 - controllers and variable speed drives,
 - battery chargers and inverters, such as used in photovoltaic application,
 - backed-up power supplies.

■ They include protection against earth fault currents:

- sinusoidal AC residual currents (AC type),
- pulsed DC residual currents (A type),
- multi frequency residual current (F type).

■ The use of Acti9 iID B-SI type residual current circuit breaker can be made mandatory, according to standards applicable in country.

■ For applications using 3-poles drives, such as:

- crane,
- lift,
- HVAC,
- pumping system.

B type is needed.

For more information, see Earth Fault Protection guide (CA908066E).

■ The Acti9 iID B-SI type works optimally with the variable speed drives manufactured by Schneider Electric, even with a long cable length between motor and variable speed drive (up to 50 m).

■ SI technology is embedded in Acti9 iID B-SI type residual current circuit breaker, providing increased immunity from electrical interference and polluted environments.

■ The Acti9 iID B-SI type is compatible with Schneider Electric AC and A types wired in parallel or in series in the installation, following coordination tables (refer to Earth Fault Protection guide CA908066E).

■ Compatible with PowerTag Energy

Catalog numbers

Acti9 iID B-SI type residual current circuit breakers						
Type	B-SI				Width in 9 mm (0.35 in) mod.	
	Sensitivity	30 mA	300 mA	300 mA	500 mA	
<p>2P</p>	Rating	25 A	40 A	63 A		
			A9Z61225	A9Z64225	-	-
			A9Z61240	A9Z64240	-	-
			A9Z61263	A9Z64263	-	-
Voltage rating (Ue)		230 V				
Operating frequency		50 Hz				
<p>4P</p>	Rating	25 A	40 A	63 A	80 A	
			A9Z61425	A9Z64425	-	-
			A9Z61440	A9Z64440	A9Z65440	A9Z66440
			A9Z61463	A9Z64463	A9Z65463	A9Z66463
			A9Z61480	A9Z64480	A9Z65480	A9Z66480
Voltage rating (Ue)		400 V				
Operating frequency		50 Hz				
PowerTag energy sensors		See PowerLogic catalog: PLSED309005EN				

Residual Current Devices

Acti9 iID B-SI type Residual Current Circuit Breakers (RCCB) (cont.)

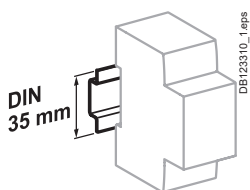

Clip on DIN rail 35 mm (1.38 in)

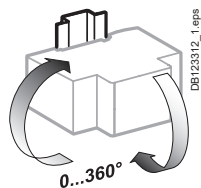

Indifferent position of installation.

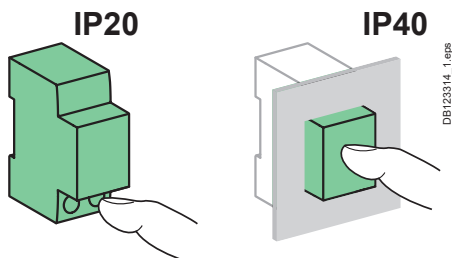

Technical data

Electrical characteristics			
Insulation voltage (U _i)	2P	250 V	
	4P	500 V	
Pollution degree		3	
Rated impulse withstand voltage (U _{imp})		6 kV	
According to IEC/EN 61008-2-1			
Making and breaking capacity (I _m /I _{Δm})		1500 A	
Surge current withstand (8/20 μs) without tripping	No selective	3 kA	
	Selective	5 kA	
Conditional rated short-circuit current (I _{nc} /I _{Δc})	With 100 A gG fuse	10,000 A	
Additional characteristics			
Degree of protection (IEC 60529)	Device only	IP20	
	Device in modular enclosure	IP40 Insulation class II	
Endurance (O-C)	Electrical	≤ 63 A	15,000 cycles
		> 63 A	10,000 cycles
	Mechanical		20,000 cycles
Range of test button operating voltage	30 mA	2P	180...270 V AC
		4P	300...450 V AC
	300, 500 mA	2P	140...330 V AC
		4P	220...450 V AC
Impulse withstand according to IEC 60068-2-27			15 g
Vibration withstand according to IEC 60068-2-6			3 g
Electromagnetic compatibility			According to IEC 61543
Operating temperature			-25°C to +60°C / -13°F to +140°F
Storage temperature			-40°C to +85°C / -40°F to +185°F
Dissipated power			See page 104

2

Dielectric test

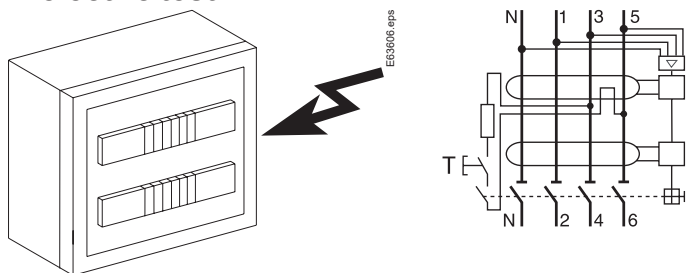

⚠ To perform any dielectric test, disconnect terminals:
 4P: 1, 3, 5 and 2, 4, 6
 2P: 1 and 2
 Except for insulation resistance test at 500 V DC between L1, L2, L3 & N all connected, and the earth circuit.

Weight (g / oz)

Residual current circuit breakers	
Type	iID
2P	350 g / 12.35 oz
4P	415 g / 14.64 oz

Dimensions (mm / inches)

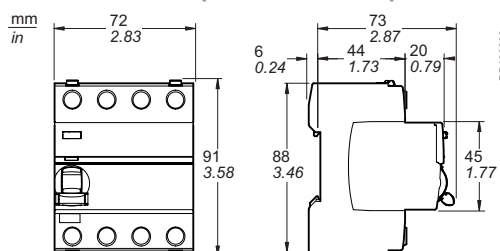

Acti9 iID B-SI type Residual Current Circuit Breakers (RCCB) (cont.)

Connection

Rating	Without accessory				With accessories			
	Back		Front		50 mm ² Al terminal	Screw-on connection for ring terminal	Multi-cables terminal	
	Rigid	Flexible or with ferrule	Rigid	Flexible or with ferrule			Rigid cables	Flexible cables
All	1 to 25 mm ² / AWG #18 to #4	1 to 16 mm ² / AWG #18 to #6	1 to 35 mm ² / AWG #18 to #2	1 to 25 mm ² / AWG #18 to #4	50 mm ² / AWG #1	Ø 5 mm / 0.2 in	3 x 16 mm ² / AWG #6	3 x 10 mm ² / AWG #8

Accessories: see page 77

- Insulated terminals IP20**
 - DB428584.eps
 - DB428595.eps
- Double terminals**
 - For top or bottom connections:
 - by cable,
 - by comb busbar
- Double clip locking** allowing tool-free removal, front panel side, with the comb busbar in position
- Test button**
 - DB428598.eps
- Large circuit labelling area**
- Voltage presence LED**
 - For an optimal use of the LED, Acti9 iID must be power supplied by top connections
 - Led indication (powered by top connections):
 - On: powered and ready
 - Off: not powered
- VISI-TRIP window**
 - Fault tripping is indicated by a red mechanical indicator on the front face
- VISI-SAFE window**
 - Positive contact indication**
 - A green strip on the toggle indicates full opening of all the poles
 - Padlocking possible

Residual Current Devices

Acti9 RCCB-ID 125 A Residual Current Circuit Breakers (AC, A, A-SI, B types)

IEC/EN 61008-1
IEC/EN 61008-2-1
VDE 0664

As per the above standards:

- The RCCB-ID 125 A residual current circuit breakers provide:
 - protection of persons against electric shock by direct contact (30 mA),
 - protection of persons against electric shock by indirect contact (≥ 100 mA),
 - protection of installations against the risk of fire (300 mA or 500 mA).

The **A-SI** type provides increased immunity from electrical interference and polluted or corrosive environments.

- Compatible with PowerTag Energy (4P only)

B type

■ The RCCB-ID B type residual current circuit breakers provide specific protection of three-phase installations and people even in the presence of DC fault currents on the network generated by:

- 3-poles controllers and variable speed drives,
- 3-poles battery chargers and inverters,
- 3-poles backed-up power supplies.

Instantaneous

It ensures instantaneous tripping (without time delay).

Selective

It ensures total discrimination with a non-selective RCD placed downstream.

OFsp auxiliary

■ Electrical indication: by OFsp auxiliary mounted to the left, it has a double changeover switch indicating the "open" or "closed" position of the RCCB-ID 125 A.

Accessories

- 2P and 4P sealable screw shield.



Catalog numbers

RCCB-ID 125 A residual current circuit breakers

Type		AC				A					
		30 mA	100 mA	300 mA	500 mA	30 mA	300 mA	300 mA	500 mA		
E91413 	Rating	Sensitivity		125 A							
		16966	-	16967	-	16970	16971	-	-		
E91414 	Rating	Sensitivity		125 A							
		16905	16906	16907	16908	16924	16926	16925	16927		
Voltage rating (Ue)		2P		230 V				400 V			
Operating frequency		4P		50 Hz							
PowerTag energy sensors						See PowerLogic catalog: PLSED309005EN					

Acti9 RCCB-ID 125 A Residual Current Circuit Breakers (AC, A, A-SI, B types) (cont.)

Catalog numbers

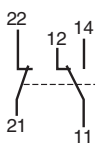
Auxiliary				Width in 9 mm (0.35 in) mod.
Type	Contact	Voltage		
	1 A	110 V DC	16940	1
	6 A	230 V AC (AC15)		

Accessory		
Type	Number of pole	
Screw shield (set of 10) for upstream or downstream	2P	16938
	4P	16939

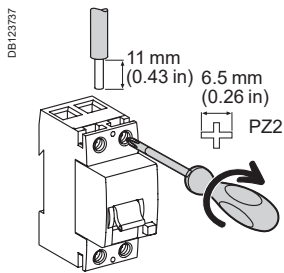

Connection

■ By tunnel terminals for:



Type	Tightening torque	Copper cables (*)	
		Rigid	Flexible or with ferrule
RCCB-ID	3 N.m / 26.6 lb.in	1.5 to 50 mm ² / AWG #15 to #1	1.5 to 35 mm ² / AWG #15 to #2
OFsp	0.8 N.m / 7 lb.in	1 to 1.5 mm ² / AWG #18 to #16	

(*) See Copper Multi-cable connection chapter for more information, page 113.

							Width in 9 mm (0.35 in) modules
A-SI 		B 					
30 mA	300 mA	-	-	-	-	-	4
16972	-	-	-	-	-	-	
30 mA	300 mA	30 mA	300 mA	300 mA 	500 mA		8
16920	16921	16763	16764	16765	16766		

Acti9 RCCB-ID 125 A Residual Current Circuit Breakers (AC, A, A-SI, B types) (cont.)

Technical data

OFsp contact status, depending on the position of the residual current circuit breaker				
Type				
RCCB-ID 125 A	Closed	■	-	-
	Open	-	■	-
	Tripped on electrical fault	-	-	■
Contact OFsp	22/21	Open	Closed	Closed
	12/11			
	14/11	Closed	Open	Open

Electrical characteristics	
Insulation voltage (Ui)	400 V
Pollution degree	3
Rated impulse withstand voltage (Uimp)	4 kV

According to IEC/EN 61008-1		
Making and breaking capacity (Im/IΔm)	1250 A	
Surge current withstand (8/20 μs) without tripping	AC and A types (not selective ☒)	250 A
	A-SI and B types (not selective ☒)	3 kA
	AC, A, A-SI and B types (selective ☒)	3 kA
Conditional rated short-circuit current (Inc/IΔc)	With FU 125 A gG fuse	10,000 A
Behaviour in case of voltage drop		Residual current protection down to 0 V according to IEC/EN 61008-1 § 3.3.4

Additional characteristics			
Degree of protection	Device only	IP20	
	Device in modular enclosure	IP40	
Endurance (O-C)	Electrical	> 2 000 cycles	
	Mechanical	> 5 000 cycles	
Operating temperature		-25°C to +40°C / -13°F to +104°F	
	Storage temperature	AC, A, A-SI types: -40°C to +85°C / -40°F to +185°F B type: -40°C to +60°C / -40°F to +140°F	
Range of test button operating voltage	30 mA	2P	160...250 V AC
		4P	250...440 V AC
	100, 300, 500 mA	2P	185...250 V AC
		4P	185...440 V AC



Indication of the status of the RCCB-ID via the 3-position toggle and front panel indicator

- Open (toggle in high position and green indicator)
- Closed (toggle in low position and red indicator)
- Tripped on electrical fault (toggle in middle position and green indicator)

Dielectric test

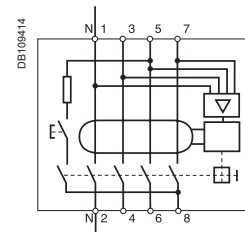
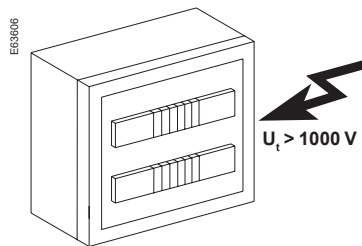

⚠ To perform the dielectric test, disconnect terminals 3, 5, 7 and 4, 6, 8.

Weight (g / oz)

Residual current circuit breakers and auxiliary		
Type	RCCB-ID 125 A	OFsp
2P	230 g / 8.11 oz	40 g / 1.41 oz
4P AC, A and A-SI types	420 g / 14.82 oz	
B type	500 g / 17.64 oz	

Dimensions (mm / inches)

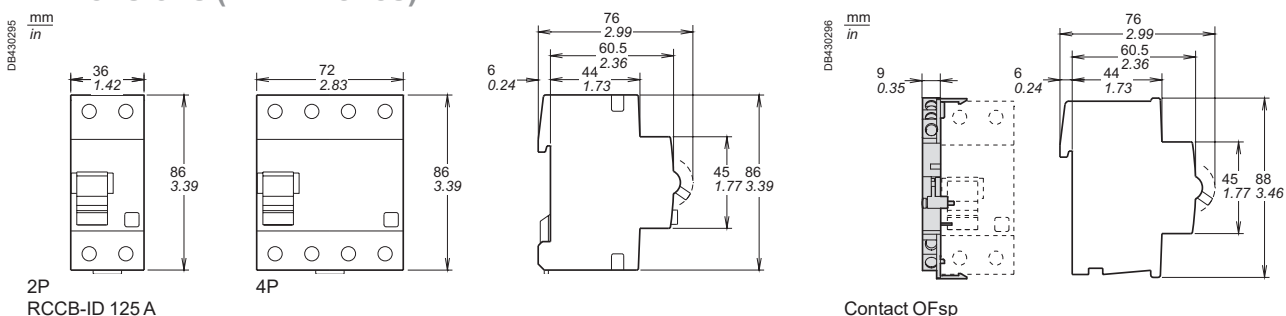

Residual Current Devices

Multi9 RCCB ID Residual Current Circuit Breakers (AC, A-SI types)

IEC

IEC/EN 61008-1

As per the above standard:

- RCCB-ID residual current circuit breakers offer the following functions:
 - protection of persons against electric shock by direct contact (30 mA),
 - protection of persons against electric shock by indirect contact (300 mA),
 - protection of installations against fire risks (300 mA).

A-SI type

The A-SI type provides increased immunity from electrical interference and polluted or corrosive environments.

- Compatible with PowerTag Energy.



Catalog numbers

RCCB-ID residual current circuit breakers

Type	AC	A-SI	Width in 9-mm (0.35 in) modules			
2P Rating	Sensitivity	30 mA	300 mA	30 mA	300 mA	4
	25 A	M9R11225	-	-	-	
	40 A	M9R11240	M9R14240	M9R31240	M9R35240	
63 A	M9R11263	-	-	-	-	
4P Rating	Sensitivity	30 mA	300 mA	30 mA	300 mA	8
	40 A	M9R11440	M9R14440	M9R31440	M9R35440	
	63 A	M9R11463	M9R14463	M9R31463	M9R35463	
Voltage rating (Ue)	2P	230 - 240 V				
	4P	400 - 415 V				
Operating frequency	50 Hz					
Auxiliaries	See page 55					
Accessories	See page 72					
PowerTag energy sensors	See PowerLogic catalog: PLS309005EN					

Connection

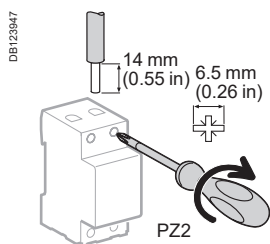

Rating	Tightening torque	Copper cables (*)			
		Rigid		Flexible or with ferrule	
25 to 63 A	3.5 N.m / 31 lb.in				
		1 to 35 mm ²	AWG #18 to #2	1 to 25 mm ²	AWG #18 to #4

(*) See Copper Multi-cable connection chapter for more information, page 113.

Residual Current Devices

Multi9 RCCB ID Residual Current Circuit Breakers (AC, A-SI types) (cont.)

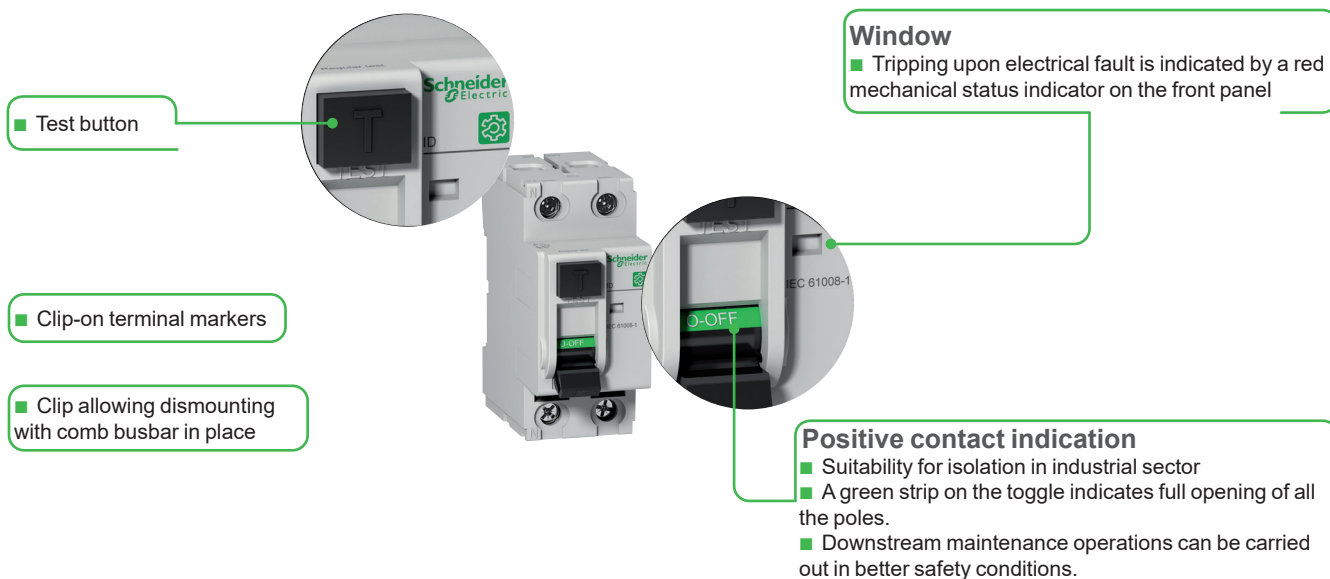

2

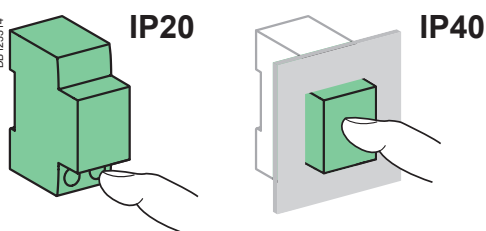
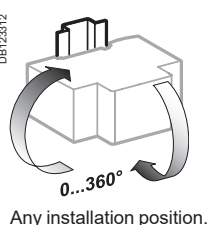
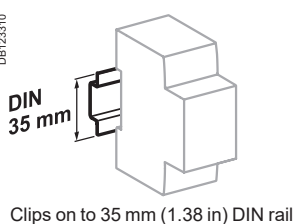

Technical data

Main characteristics		
Insulation voltage (U _i)		440 V
Pollution degree		3
Rated impulse withstand voltage (U _{imp})		6 kV
According to IEC/EN 61008-1		
Making and breaking capacity (I _m /I _{Δm})		10 In
Impulse current withstand (8/20 μs) without tripping	AC type	250 Å
	A-SI type	3 kÅ
Rated conditional short-circuit current (I _{nc} /I _{Δc})	With fuse	100 A, 10,000 A
Behaviour in case of voltage drop		Residual current protection down to 0 V according to IEC/EN 61008-1 § 3.3.4
Additional characteristics		
Degree of protection (IEC 60529)	Device only	IP20
	Device in modular enclosure	IP40
Endurance (O-C)	Electrical	2000 cycles
	Mechanical	20,000 cycles
Operating temperature	AC type	-5°C to +40°C / 23°F to 104°F
	A-SI type	-25°C to +40°C / -13°F to 104°F
Storage temperature		-40°C to +60°C / -40°F to 140°F
Tropicalization (IEC 60068-1)		Treatment 2 (relative humidity 95 % at 55°C / 131°F)
Dissipated power		See page 104

Weight (g / oz)

Residual current circuit breakers	
Type	ID
2P	230 g / 8.11 oz
4P	450 g / 15.87 oz

Dimensions (mm / inches)

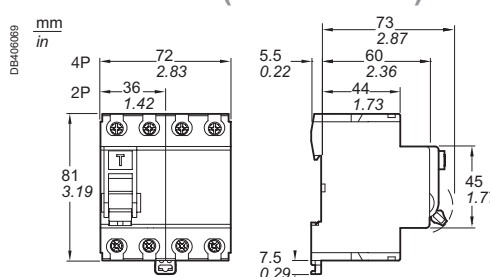

Residual Current Devices

Multi9 Vigi C60 – Residual Current Devices – Add-on for C60

IEC

IEC/EN 61009-1

As per the above standard:

- Combined with C60 circuit breaker, the Vigi C60 provide:
 - protection of persons against electric shock by direct contact (30 mA),
 - protection of persons against electric shock by indirect contact (300 mA),
 - protection of installations against the risk of fire (300 mA).

- The **A-SI** type provides increased immunity from electrical interference and polluted or corrosive environments.

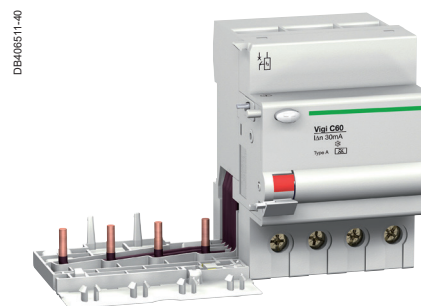
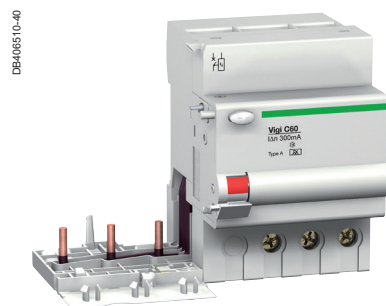
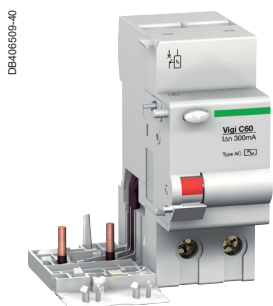

Catalog numbers

Vigi C60 add-on residual current devices					
Type		AC	A-SI		Width in 9-mm (0.35 in) modules
2P 	Sensitivity	30 mA	300 mA	30 mA	4
	Rating 63 A	M9V11263	M9V14263	M9V31263	
3P 	Sensitivity	30 mA	300 mA	30 mA	7
	Rating 63 A	M9V11363	M9V14363	M9V31363	
4P 	Sensitivity	30 mA	300 mA	30 mA	7
	Rating 63 A	M9V11463	M9V14463	M9V31463	
Voltage rating (Ue)	2P	230 - 240 V			
	3P-4P	400 - 415 V			
Operating frequency		50 Hz			

Connection

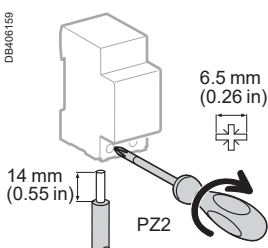

Tightening torque	Copper cables (*)		
	Rigid	Flexible or with ferrule	
3.5 N.m / 31 lb.in			
	1 to 35 mm ²	AWG #18 to #2	1 to 25 mm ²
			AWG #18 to #4

(*) See Copper Multi-cable connection chapter for more information, page 113.

Multi9 Vigi C60 – Residual Current Devices – Add-on for C60 (cont.)

- Reinforced cable pull-out strength: serrated terminals
- Automatic cable guiding in the correct position: terminals with guard

■ Test button

■ Every circuit breaker combined with a Vigi module remains compatible with the indication and tripping auxiliaries

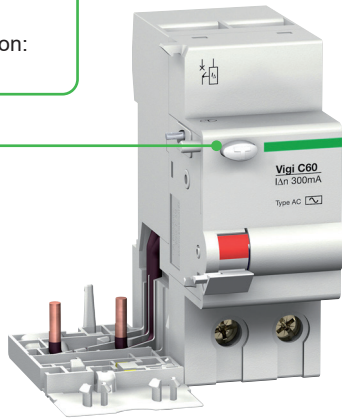

2

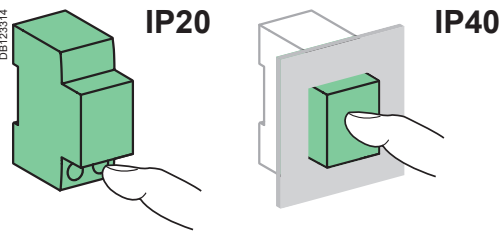
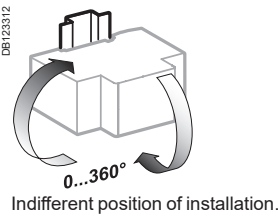
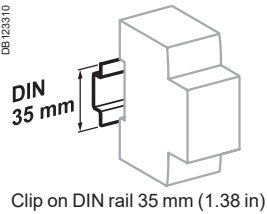

Weight (g / oz)

Type	Vigi modules
2P	150 g / 4.29 oz
3P	210 g / 7.40 oz
4P	210 g / 7.40 oz

Technical data

Main characteristics		
According to IEC/EN 61009-1		
Insulation voltage (U _i)	Phase-to-phase	500 V AC
Pollution degree		3
Rated impulse withstand voltage (U _{imp})		4 kV
Impulse current withstand (8/20 μs) without tripping	AC types	250 Å
	A-SI types	3 kÅ
Behaviour in case of voltage drop		Residual current protection down to 0 V according to IEC/EN 61009-1 § 3.3.8
Additional characteristics		
Degree of protection (IEC 60529)	Device only	IP20
	Device in modular enclosure	IP40
Operating temperature	A-SI types	-25°C to +60°C / -13°F to 140°F
	AC type	-5°C to +60°C / 23°F to 140°F
Storage temperature		-40°C to +60°C / -40°F to 140°F
Tropicalization (IEC 60068-1)		Treatment 2 (relative humidity 95 % at 55°C / 131°F)
Dissipated power		See page 104

Railways



Type	2P	3P	4P
Mass of combustible material	44.4 g / 1.55 oz	72.6 g / 2.54 oz	72.6 g / 2.54 oz
Type of combustible material	PA6 MD25 FR & PA6 MD30 FR		
Fire and smoke requirements (EN 45545-2)	HL2 R22 / HL2 R23		
Resistance to shocks and vibrations (IEC 61373)	<ul style="list-style-type: none"> ■ Category 1 ■ Class B 		

Dimensions (mm / inches)

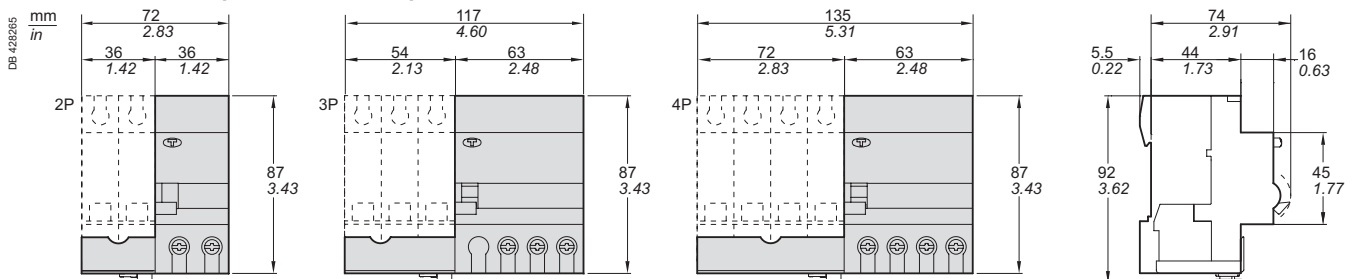

Residual Current Devices

Multi9 Vigi N40 – Residual Current Devices – Add-on for N40

IEC

Earth leakage protection devices offer the following functions:

- protection of electrical installations against insulation faults
- protection for people against direct and indirect contact
- protection of the installations against fire risks.

PBE11790-40



IEC/EN 61009-1

As per the above standard:

The Vigi N40N modules, to be combined with a circuit breaker, incorporate in a single enclosure the residual current relay and the toroid.

- The residual current tripping device is electromechanical and operates without an auxiliary source.
- A homogeneous unit in compliance with the EN 61009-1 and EN 61009-2-1 standards, a residual current device retains all the characteristics of the circuit breaker alone; in particular, the thermal tripping threshold of the circuit breaker is retained in the presence of the earth leakage module.

Operation

- When an earth fault occurs, the Vigi module causes automatic opening of the circuit breaker with which it is combined. Fault indication is performed by a red strip on the operating handle for Vigi module resetting.
- Resetting of the earth leakage module is performed, at the user's choice:
 - either by the reset handle of the circuit breaker (in one operation),
 - or independently of the circuit breaker (in 2 operations).

A-SI type

The A-SI type provides increased immunity from electrical interference and polluted or corrosive environments.

Catalog numbers

Vigi N40 add-on residual current devices						
Type		AC		A-SI		Width in 9-mm (0.35 in) modules
3P+N 	Sensitivity	30 mA	300 mA	30 mA	300 mA	4
	Rating 40 A	M9Y11740	M9Y14740	M9Y31740	M9Y34740	
Voltage rating (Ue)	400 - 415 V					
Operating frequency	50 Hz					

Connection

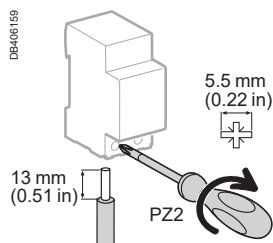

Tightening torque	Copper cables (*)			
	Rigid		Flexible or with ferrule	
2 N.m / 18 lb.in	1 to 16 mm ²	AWG #18 to #6	1 to 10 mm ²	AWG #18 to #8

(*) See Copper Multi-cable connection chapter for more information, page 113.

- Where there is a comb busbar tooth, the connection of cables of cross section 16 mm² remains possible.
- Connection:
 - upstream: direct by comb busbar,
 - downstream: by cables.

Multi9 Vigi N40 – Residual Current Devices – Add-on for N40 (cont.)

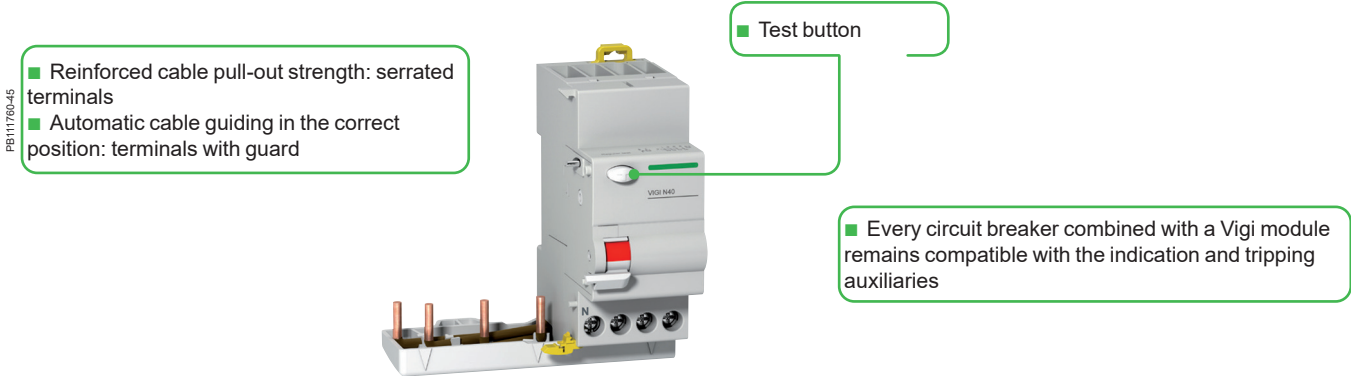

2

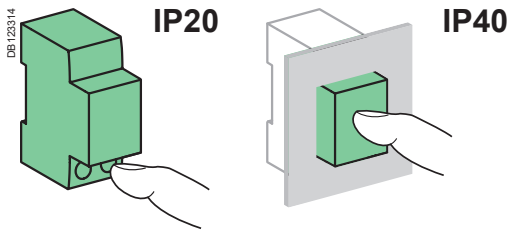
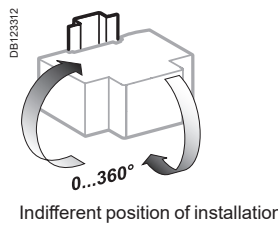
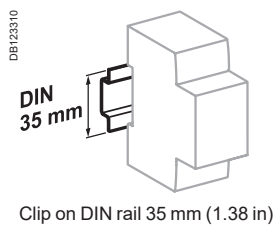

Technical data

Main characteristics		
According to IEC/EN 61009-1		
Insulation voltage (Ui)	Phase-to-phase	440 V AC
Pollution degree		3
Rated impulse withstand voltage (Uimp)		4 kV
Behaviour in the event of a phase-to-earth fault in TN-S earthing system		Residual breaking and making capacity (IΔm) identical to the rated breaking capacity (Icn)
Behaviour in case of voltage drop		Residual current protection down to 0 V according to IEC/EN 61009-1 § 3.3.8
Additional characteristics		
Degree of protection (IEC 60529)	Device only	IP20
	Device in modular enclosure	IP40 Insulation class II
Operating temperature	AC type	-5°C to +60°C / 23°F to 140°F
	A-SI types	-25°C to +60°C / -13°F to 140°F
Storage temperature		-40°C to +60°C / -40°F to 140°F
Tropicalization (IEC 60068-1)		Treatment 2 (relative humidity 95 % at 55°C / 131°F)
Dissipated power		See page 104

Weight (g / oz)

	Vigi modules
Type	
3P+N	210 g / 7.40 oz

Dimensions (mm / inches)

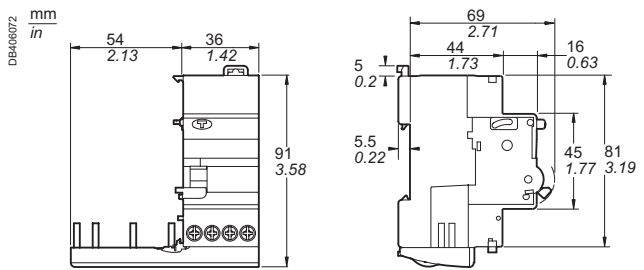

Multi9 N40 Vigi – Residual Current circuit Breakers with Overcurrent protection

IEC



IEC/EN 61009-1

As per the above standard:

- The N40 Vigi residual current device provides complete protection for final circuits (against overcurrents and insulation faults):
 - protection for people against electric shocks by direct contacts (30 mA),
 - protection for people against electric shocks by indirect contacts (300 mA),
 - protection of installations against risk of fire (300 mA).

Catalog numbers

N40 Vigi 6 kA		AC		Width in 9-mm (0.35 in) mod.	
Type		30 mA	300 mA		
1P+N C curve	Sensitivity				
	Rating (In)	6 A	M9D11606	4	
		10 A	M9D11610		M9D14610
		16 A	M9D11616		M9D14616
		20 A	M9D11620		M9D14620
		25 A	M9D11625		M9D14625
		40 A	M9D11640		M9D14640
Voltage rating (Ue)		240 V AC			
Operating frequency		50 Hz			
Auxiliaries		See page 55			
Accessories		See page 72			

Positive contact indication

- A green strip on the toggle indicates full opening of all the poles
- Downstream maintenance operations can be carried out in better safety conditions
- Padlocking possible

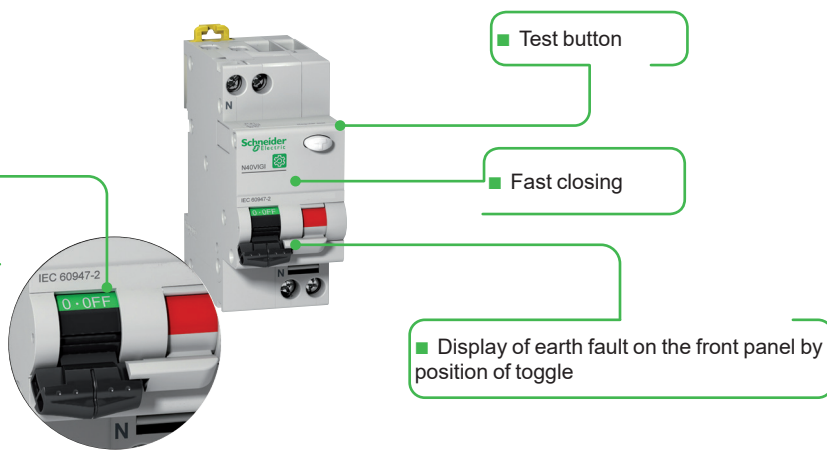

Multi9 N40 Vigi – Residual Current circuit Breakers with Overcurrent protection (cont.)

Connection

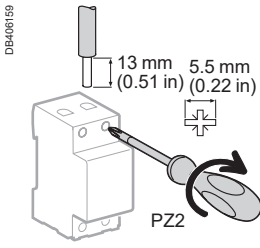

Tightening torque	Copper cables (*)			
	Rigid		Flexible or with ferrule	
2 N.m / 18 lb.in	1 to 16 mm ²	AWG #18 to #6	1 to 10 mm ²	AWG #18 to #8

(*) See Copper Multi-cable connection chapter for more information, page 113.

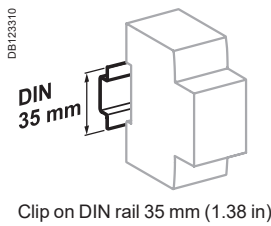

Clip on DIN rail 35 mm (1.38 in)

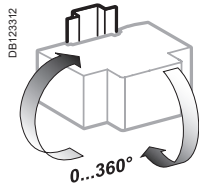

Indifferent position of installation.

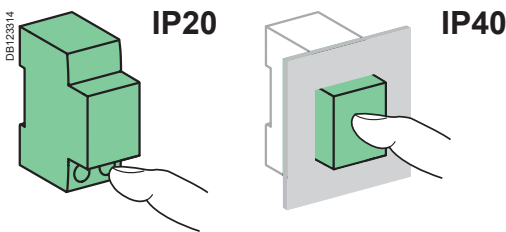

Technical data

Main characteristics

Insulation voltage (U _i)	400 V AC
Pollution degree	3
Rated impulse withstand voltage (U _{imp})	4 kV
Setting temperature for ratings	50°C / 122°F
Earth leakage protection with instantaneous tripping	30, 300 mA
Magnetic tripping C curve	8.5 In (± 20 %)
8/20 µs impulse withstand current	250 Å

According to IEC/EN 61009-1

Limitation class	3
Rated breaking capacity (I _{cn})	6000 A
Rated residual breaking and making capacity (I Δ m)	6000 A
Behaviour in case of voltage drop	Residual current protection down to 0 V according to IEC/EN 61009-1 § 3.3.8

According to IEC/EN 60947-2

Breaking capacity (I _{cu})	6 kA
Service breaking capacity (I _{cs})	75 % I _{cu}

Additional characteristics

Degree of protection (IEC 60529)	Device only	IP20
	Device in modular enclosure	IP40 Insulation class II
Endurance (O-C)	Electrical N40 Vigi ≤ 20A	20,000 cycles
	N40 Vigi ≥ 25A	10,000 cycles
	Mechanical	20,000 cycles
Overvoltage category (IEC 60364)	IV	
Operating temperature	-5°C to +60°C / 23°F to 140°F	
Storage temperature	-30°C to +70°C / -22°F to 158°F	
Tropicalization (IEC 60068-1)	Treatment 2 (relative humidity 95 % at 55°C / 131°F)	
Dissipated power	See page 104	

Railways



Type	1P+N
Mass of combustible material	45.8 g / 1.59 oz
Type of combustible material	PA6 MD25 FR & PA6 GF20 FR
Fire and smoke requirements (EN 45545-2)	HL2 R22 / HL2 R23
Resistance to shocks and vibrations (IEC 61373)	■ Category 1 ■ Class B

Weight (g / oz)

Residual current device	
Type	N40 Vigi
1P+N	125 g / 4.41 oz

Dimensions (mm / inches)

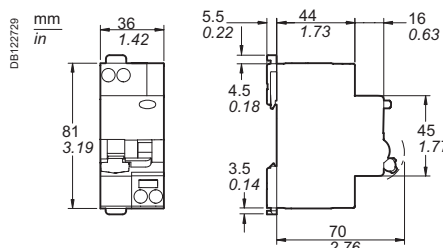

Load protection

Multi9 PRD1 75r

Type 1 surge protective devices



The Type 1 range of surge protective device meets the normative withstand capability of current wave type 8/20 μ s. PRD1 75r surge protective devices are fitted with dry contacts to send "end-of-life indication" information. PRD1 75r surge protective devices are fitted with easy-to-replace withdrawable cartridges.

UL 1449 4th Edition Recognized, CSA C22.2 No. 269.4-17, 1st Ed

As per the above standard:
 The PRD1 75r surge protective device (SPD) is rated UL and CSA Type 1, and is well suited for use installed within electrical equipment. Rated at 200kA SCCR, without additional upstream protection, it can be installed in a variety of installations including service entrance, branch panels and control panel environments. For serviceability considerations, connecting through a disconnecter is recommended.
 Replaceable devices are available, should the device reach end of life due to a surge event or sustained over-voltage.



PRD1 75r (1P)



PRD1 75r (2P)



PRD1 75r (3P)



PRD1 75r (4P)

Multi9 PRD1 75r Type 1

Type	Surge protective devices				
	Wiring configuration	Rated network voltage (V AC)	I max (kA) Surge Capacity	In (kA)	SCCR (kA)
1P		120	75	20	200
		240	75	20	200
		277	75	20	200
		347	75	10	200
2P		120/240	75	20	200
		240/480	75	20	200
3P		240	75	20	200
		480	75	10	200
		120/208	75	20	200
		277/480	75	20	200
		347/600	75	10	200
		400/690	75	10	200
4P		120/208	75	20	200
		277/480	75	20	200
		347/600	75	10 (L1/L2/L3) 20 (N-G)	200
		400/690	75	10 (L1/L2/L3) 20 (N-G)	200
		120/240	75	20	200
		240/480	75	20 (L1/L3/N-G) 10 (H-L)	200

Multi9 PRD1 75r

Type 1 surge protective devices (cont.)



3

	VPR (V) Voltage Protection Rating	MCOV (V)	SPD wiring (2-, 3-, 4- or 5- wire)	Catalog number	Associated cartridge				SPD only
					L1	L2/H-L	L3	G (Ground)	Width in 9 mm (0.35 in) modules
	600 (L-N)	175 (L-N)	2	M9L11120	M9LC175	-	-	-	2
	900 (L-N)	275 (L-N)	2	M9L21240	M9LC275	-	-	-	2
	1000 (L-N)	320 (L-N)	2	M9L31277	M9LC320	-	-	-	2
	1500 (L-N)	420 (L-N)	2	M9L41347	M9LC420	-	-	-	2
	600 (L-N) 1200 (L-L)	175 (L-N) 350 (L-L)	3	M9L12240	M9LC175	M9LC175	-	-	4
	900 (L-N) 1800 (L-L)	275 (L-N) 550 (L-L)	3	M9L22480	M9LC275	M9LC275	-	-	4
	900 (L-G) 1800 (L-L)	275 (L-G) 550 (L-L)	4	M9L23240	M9LC275	M9LC275	M9LC275	-	6
	1500 (L-G) 3000 (L-L)	550 (L-G) 1100 (L-L)	4	M9L53480	M9LC550	M9LC550	M9LC550	-	6
	600 (L-N) 1200 (L-L)	175 (L-N) 350 (L-L)	4	M9L13208	M9LC175	M9LC175	M9LC175	-	6
	1000 (L-N) 2000 (L-L)	320 (L-N) 640 (L-L)	4	M9L33480	M9LC320	M9LC320	M9LC320	-	6
	1500 (L-N) 2500 (L-L)	420 (L-N) 840 (L-L)	4	M9L43600	M9LC420	M9LC420	M9LC420	-	6
	1500 (L-N) 3000 (L-L)	550 (L-N) 1100 (L-L)	4	M9L53690	M9LC550	M9LC550	M9LC550	-	6
	600 (L-N) 1200 (L-G) 1200 (L-L) 600 (N-G)	175 (L-N) 175 (L-G) 350 (L-L) 175 (N-G)	5	M9L17208	M9LC175	M9LC175	M9LC175	M9LC175	8
	1000 (L-N) 1500 (L-G) 2000 (L-L) 600 (N-G)	320 (L-N) 495 (L-G) 640 (L-L) 175 (N-G)	5	M9L37480	M9LC320	M9LC320	M9LC320	M9LC175	8
	1500 (L-N) 2000 (L-G) 2500 (L-L) 800 (N-G)	420 (L-N) 695 (L-G) 840 (L-L) 275 (N-G)	5	M9L47600	M9LC420	M9LC420	M9LC420	M9LC275	8
	1500 (L-N) 2500 (L-G) 3000 (L-L) 1000 (N-G)	550 (L-N) 870 (L-G) 1100 (L-L) 320 (N-G)	5	M9L57690	M9LC550	M9LC550	M9LC550	M9LC320	8
	1200 (L-L/L-G) 600 (L-N/N-G) 1500 (H-L/H-G) 800 (H-N)	350 (L-L/L-G) 175 (L-N/N-G) 450 (H-L/H-G) 275 (H-N)	5	M9L17240	M9LC175	M9LC275	M9LC175	M9LC175	8
	1500 (L-L/L-G) 800 (L-N) 600 (N-G) 2500 (H-L) 2000 (H-G) 1500 (H-N)	550 (L-L) 450 (L-G) 275 (L-N) 175 (N-G) 825 (H-L) 725 (H-G) 550 (H-N)	5	M9L27480	M9LC275	M9LC550	M9LC275	M9LC175	8

Multi9 PRD1 75r

Type 1 surge protective devices (cont.)



M9LC275

Spare cartridge						
Un (V) Rated voltage network	I max (kA) Surge Capacity	In (kA)	SCCR (kA)	VPR (V) Voltage Protection Rating	MCOV (V)	Catalog number
120	75	20	200	600	175	M9LC175
240	75	20	200	900	275	M9LC275
277	75	20	200	1000	320	M9LC320
347	75	10	200	1500	420	M9LC420
400	75	10	200	1500	550	M9LC550

Technical data

		PRD1 75r Type 1
Operating frequency		50/60 Hz
Response time		< 25 ns
Short circuit withstand (I _{sc})		200 kA
Ground residual current (I _G)	I _G (Neutral-Ground)	< 1 mA
Surge protective device technology		MOV
End-of-life indication	Green	Correct operation
	Red	At end of life
	Remote notification	250 V AC / 1 A 125 V AC / 3 A
Operating temperature		-25°C to +60°C
Storage temperature		-40°C to +85°C
Relative humidity		5 % to 90 %
Operating altitude		2000 m
Degree of protection	IP	NEMA 1 built-in
	Impacts	IK05
Pollution degree		3
Standards		UL 1449: 4th Edition Recognized CSA C22.2 No. 269.4-17, 1 st Ed

Connection

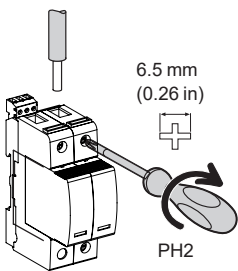

Wire stripping length		Tightening torque		Tunnel type terminals			
L/N/ Ground	Dry contacts	L/N/ Ground	Dry contacts	Rigid cable	Flexible cable or with ferrule	Dry contacts	
						Rigid cable	Flexible cable
10 mm (0.4 in.)	6 mm (0.24 in.)	3 N.m (26.5 Lbf. in.)	0.27 N.m (2.4 Lbf. in.)	DB122846.eps 6 to 35 mm ² (AWG 10...AWG 2)	DB122846.eps 6 to 25 mm ² (AWG 10...AWG 4)	DB122846.eps Max. 1.5 mm ² (AWG 16)	DB123007.eps 0.05 to 2.5 mm ² (AWG 30...AWG14)

Weight (g)

Surge protective device	
Type	PRD1 75r
1P	154
2P	340
3P	522
4P	703
Cartridge	82

Dimensions

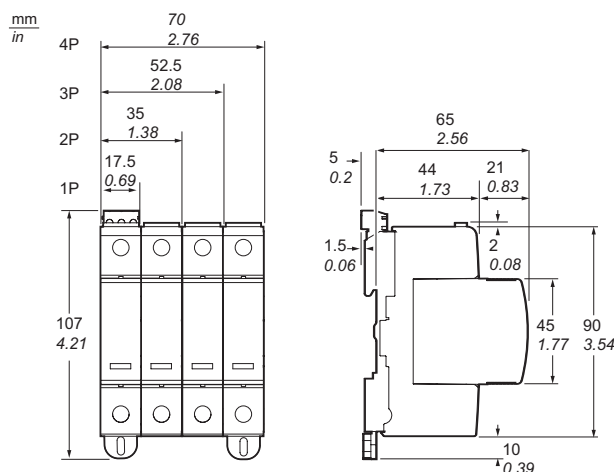



Auxiliaries and accessories

Multi9 Electrical auxiliaries for MCB and RCD, except Acti9 iID B-SI type RCCB



Compliance with electrical auxiliaries standards

- UL 489 Branch circuit protection File #E215117.
- CSA C22.2 No. 5 Branch circuit protection File #179014.
- UL 1077 Supplementary Protection File #E90509.
- CSA C22.2 No. 235 Supplementary Protection File #179014.
- IEC 60947-1 and IEC 60947-5-1.
- CE Marked.

- The electrical auxiliaries provide the remote tripping or position (open/closed/tripped) indication functions of these devices in the event of a fault.
- They clip on (no tool required) to the left-hand side of the associated device.
- The SD+OF auxiliary is a 2-in-1 product: a mechanical selector switch is used to select one of two contacts: SD or OF.
- The low current auxiliaries OF, SD (2 to 100 mA) are especially dedicated to low current application to report status information to a Programmable Logic Controller (Industry).

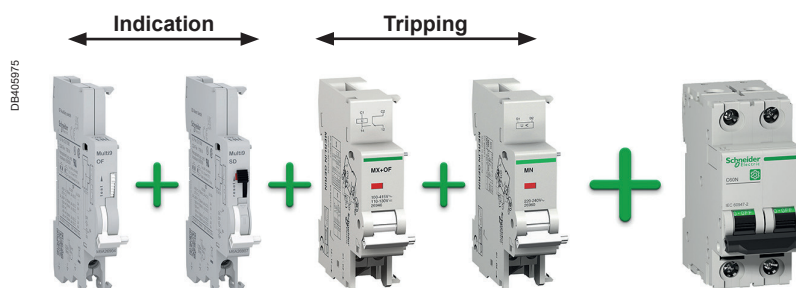

Combination table

Indication auxiliaries		Tripping auxiliaries		Devices	
1 OF + SD/OF maxi	1 OF + SD/OF maxi	1 maxi			C60, N40N, N40 Vigi
1 OF maxi	1 (OF + SD/OF or SD or OF) maxi	2 maxi			OF.S (26923)
None	1 (OF + SD/OF or OF) maxi	2 maxi			RCCB-ID, GFP
1 OF maxi	1 OF maxi	1 maxi			RCCB-ID B type, RCCB-ID > 63 A
None		None			









Note: iOF and iSD in combination table can be (2 to 100 mA) or (100 mA to 6A) products.

Note Tripping devices must be installed first.
 If two tripping devices are used: the MN undervoltage release must be installed first.
 Indication auxiliaries: install the SD auxiliary first

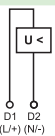

4

Railways		
Type	MN, MNs, MNx, MX, MX+OF	OF, SD, SD+OF
Mass of combustible material	25.5 g / 0,88 oz	17.6 g / 0.6 oz
Type of combustible material	PA6 GF20 FR	
Fire and smoke requirements (EN 45545-2)	HL2 R22 / HL2 R23	
Resistance to shocks and vibrations (IEC 61373)	<ul style="list-style-type: none"> ■ Category 1 ■ Class B 	







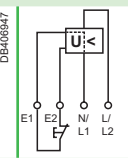
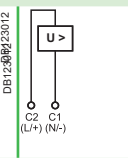
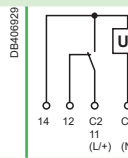



Multi9 Electrical auxiliaries for MCB and RCD, except Acti9 iLD B-SI type RCCB (cont.)

		Tripping					
Auxiliaries		MN				MN ^S	
Type		Undervoltage release					
		Instantaneous				Delayed	
							
Function		<ul style="list-style-type: none"> Trips the device with which it is combined when its input voltage decreases (between 70 % and 35 % Un). Prevents device closing again until its input voltage is restored 				<ul style="list-style-type: none"> No tripping in the event of transient voltage dips (up to 0.2 s) 	
Wiring diagrams							
Utilization		<ul style="list-style-type: none"> Emergency stoppage by normally closed push button Improve the safety of power supply circuits for several machines by preventing "uncontrolled" restarting 					
Catalog numbers		M9A27108	M9A27107	M9A26960	M9A26961	M9A26959	M9A26963
Technical specifications							
Rated voltage (Ue)	V AC	24	120	220...240	48	115	220...240
	V DC	24			48		—
Operating frequency	Hz	50/60				400	50/60
Pollution degree		3					3
Mechanical state indicator light, red		On front face					On front face
Test function		—					—
Width in 9 mm modules		2					2
Operating current		—					—
Number of contacts		—					—
Busbar compatibility		Top					Top
Operating temperature		-25...+50°C / -13...122°F					-25...+50°C / -13...122°F
Storage temperature		-40...+85°C / -40...185°F					-40...+85°C / -40...185°F
Standards							
IEC/EN 60947-1		■					■
IEC/EN 60947-5-1		—					—
EN 60947-2		■					■
EN 62019-2		—					—
		■				—	■
		■				—	■
		■				—	■
		—				—	—
		■				—	■

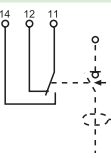
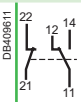
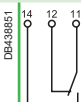

Multi9 Electrical auxiliaries for MCB and RCD, except Acti9 iID B-SI type RCCB (cont.)

MNx	MX	MX+OF
Independent of the supply voltage		
Shunt release		
With open/closed auxiliary contact		
 <p>PB100205_SE-30</p>	 <p>PB100199_SE-30</p>	 <p>PB100198_SE-30</p>
<ul style="list-style-type: none"> ■ Tripping of the associated device by opening of the control circuit (e.g. push-button, dry contact) 	<ul style="list-style-type: none"> ■ Trips the associated device when it is powered on 	<ul style="list-style-type: none"> ■ Includes an open/closed contact (OF contact) to indicate the "open" or "closed" position of the associated device
<ul style="list-style-type: none"> ■ A drop in the supply voltage does not trip the associated device ■ A locking push-button control allows the circuit protected (e.g. machine control) to be placed in safety configuration 		
 <p>DB406847</p>	 <p>DB12589p123012</p>	 <p>DB406829</p>
<ul style="list-style-type: none"> ■ Emergency stoppage with fail-safe principle ■ Insensitive to the variation in the control circuit voltage to improve continuity of service <p>Important: Before any servicing operation switch off the mains power supply (voltage presence at terminals E1/E2)</p>	<ul style="list-style-type: none"> ■ Emergency stoppage with fail-safe principle 	<ul style="list-style-type: none"> ■ Emergency stoppage with fail-safe principle ■ Remote indication of the position of the associated device
M9A26969 M9A26971	M9A26476 M9A26477 M9A26478	M9A26946 M9A26947 M9A26948
230 400	100...415 48 12...24	100...415 48 12...24
—	110...130 48 12...24	110...130 48 12...24
50/60	50/60	50/60
3	3	3
On front face	On front face	On front face
—	—	—
2	2	2
—	—	100 mA mini, 6 A maxi
—	—	≤ 130 V DC 1 A 48 V AC 2 A ≤ 24 V AC 6 A
—	—	≤ 240 V AC 6 A 48 V DC 2 A ≤ 24 V DC 6 A
—	—	277 V AC 3 A
—	—	415 V AC 3 A
—	—	1 NO/NC
Top	Top	Top
-25...+50°C / -13...122°F	-25...+50°C / -13...122°F	-25...+50°C / -13°F...122°F
-40...+85°C / -40...185°F	-40...+85°C / -40...185°F	-40...+85°C / -40°F...185°F
■	■	■
—	—	—
—	—	—
—	—	—
—	■	■
—	■	■
—	■	■
—	—	■
—	—	■
■	■	■

Multi9 Electrical auxiliaries for MCB and RCD, except Acti9 iID B-SI type RCCB (cont.)

		Indication			
Auxiliaries		OF.S		OFsp	OF
Type		Open/closed auxiliary contact			Open/closed auxiliary contact
					
Function		<ul style="list-style-type: none"> Changeover contact indicating the "open" or "closed" position of the associated device for RCCB-ID ≤ 63 A 			<ul style="list-style-type: none"> Changeover contact indicating the "open" or "closed" position of the associated device Low current auxiliary (2 to 100 mA): 2 contacts (1 NO/NC) can report the signalling information to a Programmable Logic Controller (Industry).
		<p>⚠ Compulsory for the addition of tripping or indication auxiliaries on a RCCB-ID</p>			
Wiring diagrams					
Utilization		Remote indication of the position of the associated device			Remote indication of the position of the associated device
Catalog numbers		26923	16940	M9A26914	M9A26904
Technical specifications					
Rated voltage (Ue)	V AC	24...415	230	24...250	24...415
	V DC	24...130	110	24...220	24...130
Operating frequency	Hz	50/60	50	50/60	
Pollution degree		3	3	3	
Mechanical state indicator light, red		-	-	-	
Test function		-	-	On front face	
Width in 9 mm modules		1	1	1	
Operating current	24 V DC	100 mA to 6 A	-	2 mA to 100 mA	100 mA to 6 A
	48 V DC	100 mA to 2 A			100 mA to 2 A
	60 V DC	100 mA to 1.5 A			100 mA to 1.5 A
	110 V DC	100 mA to 1 A	1 A		100 mA to 1 A
	130 V DC	-	-		-
	220 V DC	-	-		-
	≤ 230 V AC	100 mA to 6 A	6 A		100 mA to 6 A
	240 V AC	-	-		-
250 V AC	-	-	-		
277 V AC	-	-	-	100 mA to 3 A	
415 V AC	100 mA to 3 A	-	-	-	
Number of contacts		1 NO/NC	1 NC + NC/NO	1 NO/NC	
Connections - terminals		Screw clamp	Screw clamp	Screw clamp	
Wiring position		Bottom	Top and bottom	Bottom	
Busbar compatibility		Top	-	Top	
Operating temperature		-25...+50°C / -13°F...122°F	-25...+50°C / -13°F...122°F	-25...+70°C / -13°F...158°F	
Storage temperature		-40...+85°C / -40°F...185°F	-40...+85°C / -40°F...185°F	-40...+85°C / -40°F...185°F	
Standards					
IEC/EN 60947-1		-	-	-	
IEC/EN 60947-5-1		■	-	■	
IEC/EN 60947-5-4		-	-	■	-
EN 60947-2		-	-	-	
EN 62019-2		■	-	■	
		-	-	■	
		-	-	■	
		-	-	■	
		-	-	■	
		-	-	■	

Multi9 Electrical auxiliaries for MCB and RCD, except Acti9 iID B-SI type RCCB (cont.)

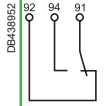
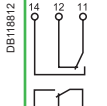
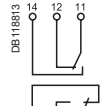
SD		OF+SD/OF
Fault indicating contact		Double open/closed or fault indicating contact
		
<ul style="list-style-type: none"> Changeover contact indicating the position of the associated device in the event of: <ul style="list-style-type: none"> electrical fault action on the tripping auxiliary Low current auxiliary 2 to 100 mA): 2 contacts (1 NO/NC) can report the signalling information to a Programmable Logic Controller (Industry). <p>⚠ Not compatible with a RCCB-ID ≤ 63 A. Use a SD+OF in the SD position</p>		<ul style="list-style-type: none"> The OF+OF/SD auxiliary is a 2-in-1 product: via a mechanical selector switch, it provides 2 contacts, OF+SD or OF+OF
		
<ul style="list-style-type: none"> Remote fault tripping indication of the associated device 	<ul style="list-style-type: none"> Remote position and/or fault tripping indication of the associated device 	<ul style="list-style-type: none"> Remote position and/or fault tripping indication of the associated device
M9A26917	M9A26907	M9A26909
24...250	24...415	24...415
24...220	24...130	24...130
50/60		50/60
3		3
On front face		On front face
On front face		On front face
1		1
2 mA to 100 mA	100 mA to 6 A	100 mA to 6 A
	100 mA to 2 A	100 mA to 2 A
	100 mA to 1.5 A	100 mA to 1.5 A
	100 mA to 1 A	100 mA to 1 A
	-	-
	100 mA to 6 A	100 mA to 6 A
	100 mA to 3 A	100 mA to 3 A
1 NO/NC		2 NO/NC
Screw clamp		Screw clamp
Bottom		Top and bottom
Top		-
-25...+70°C / -13°F...158°F		-25...+70°C / -13°F...158°F
-40...+85°C / -40°F...185°F		-40...+85°C / -40°F...185°F
-		-
■	-	■
■		■
-		-
■		■
■		■
■		■
■		■
■		■
■		■
■		■

Multi9 Electrical auxiliaries for MCB and RCD, except Acti9 iLD B-SI type RCCB (cont.)

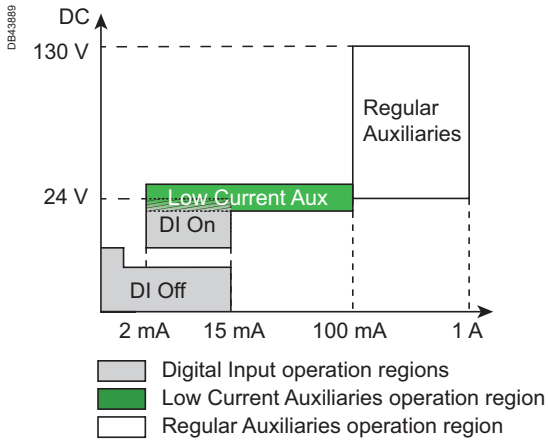

How to generate summary data using OF or SD contacts of low current electrical auxiliaries

- Electrical summary of the OF signals or electrical summary of the SD signals can be generated with low current indication auxiliaries (2 mA to 100 mA) wired as a daisy chain
- The OF connections and the SD connections must not be connected on the same daisy chain: 2 separate daisy chains are required to report OF information on the one hand and SD information on the other
- A daisy chain is made of up to 100 OF contacts or 100 SD contacts
- A daisy chain is connected locally to the PLC or the Controller (inside the same switchboard).

OF contacts within a daisy chain

- OF contacts are Normally Open (NO)
- The electrical summary of the OF signals can be done by cabling in series all OF signals
- Any open position opens the daisy chain and can be detected.

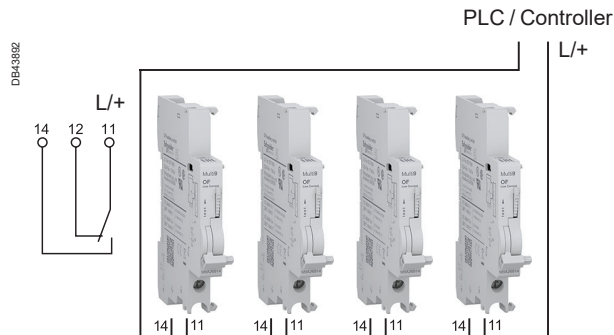

SD contacts within a daisy chain

- SD contacts are Normally Closed (NC)
- The electrical summary of the SD signals can be done by cabling in series all SD signals
- Any SD signal opens the daisy chain and can be detected.

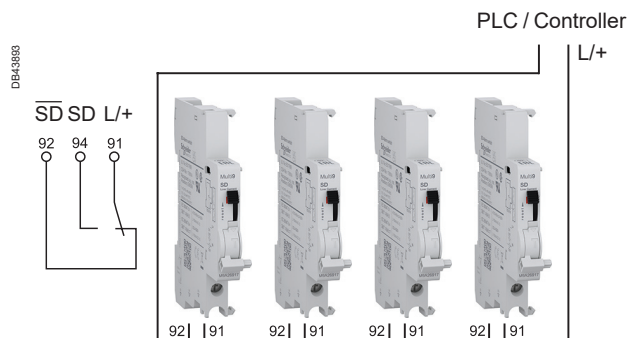

Multi9 Electrical auxiliaries for MCB and RCD, except Acti9 iID B-SI type RCCB (cont.)

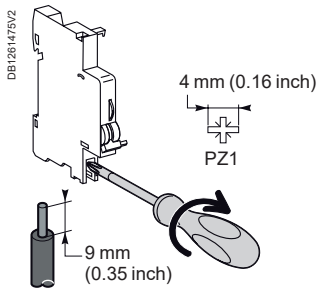

Connection

Type	Tightening torque	Copper cables
Indication and tripping auxiliaries	1 N.m (9 lb.in)	Rigid
		DB122946 2 cables, 1.5 mm ² / #16 AWG or DB405990 1 cable, 2.5 mm ² / #14 AWG
OFsp	0.8 N.m (7 lb.in)	1 cable, 1.5 mm ² / #16 AWG

Dimensions (mm / inches)

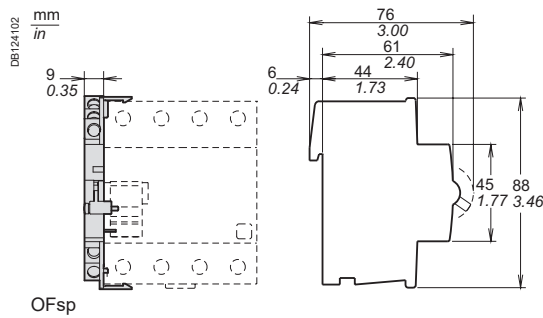
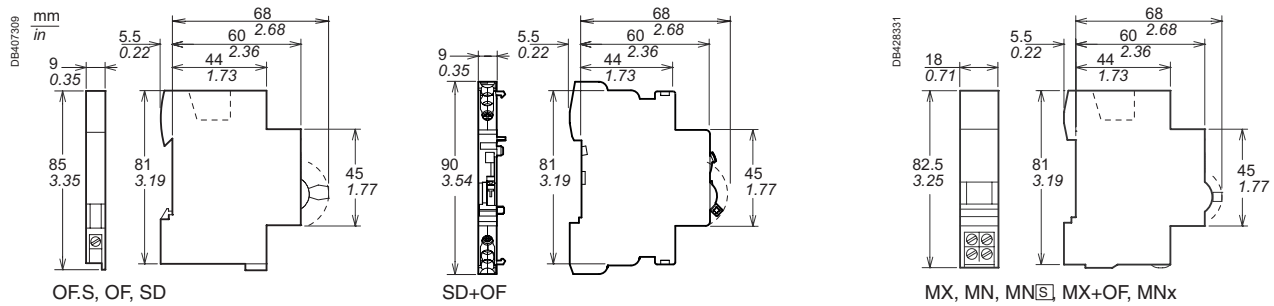

Weight (g / oz)

Electrical auxiliaries		
Type		
MN	66 g / 2.32 oz	
MN	66 g / 2.32 oz	
MNx	73 g / 2.57 oz	
MX	60 g / 2.32 oz	
MX+OF	65 g / 2.12 oz	
OF.S	33 g / 1.16 oz	
OF	2 mA to 100 mA	29 g / 1.02 oz
	100 mA to 6 A	30 g / 1.06 oz
OFsp	40 g / 1.41 oz	
SD	2 mA to 100 mA	29 g / 1.02 oz
	100 mA to 6 A	30 g / 1.06 oz
SD+OF	38 g / 1.34 oz	

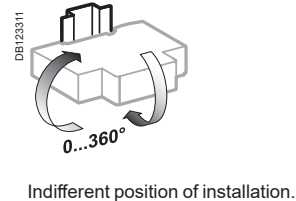
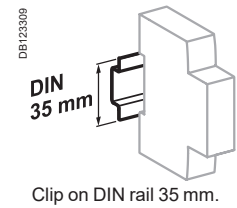
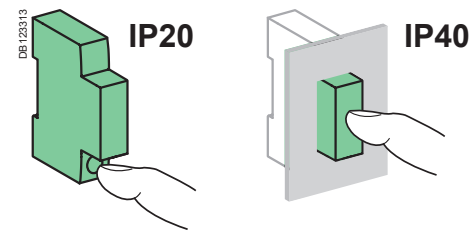

C60BP or C60BPR association

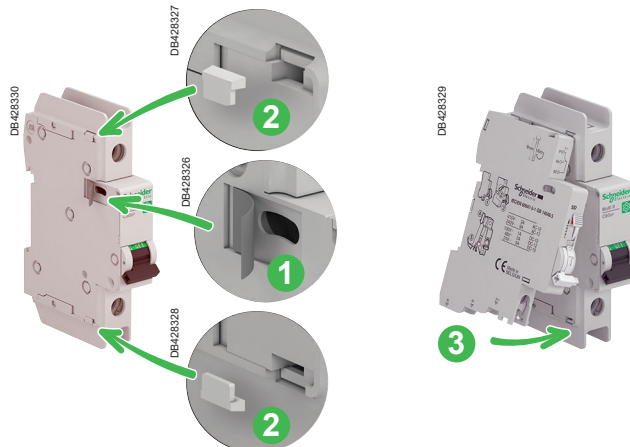

Electrical auxiliaries for Acti9 iID B-SI type RCCB

■ The electrical auxiliaries are combined with iID residual current circuit breakers; they enable tripping or remote indication of their position (open/closed/tripped) upon an electrical fault.

■ The iOF/SD+OF auxiliary is a 2-in-1 product: via a mechanical selector switch, it provides two contacts, OF+SD or OF+OF.

■ The low current auxiliaries iOF, iSD, iSD+OF (2 to 100 mA) are especially dedicated to low current application to report status information to a Programmable Logic Controller (Industry) or a Controller (Building/BMS).

■ The iOF+SD24 auxiliary can report open/closed (OF) status information and intentional or fault tripping of the associated device (SD) to the Acti9 Smartlink, a Programmable Logic Controller (Industry) or a Controller (Building/BMS), via the Ti24 interface (24 V DC).

Tripping auxiliaries:

IEC/EN 60947-1

- iMN: undervoltage release
- iMNs: delayed undervoltage release
- iMNx: undervoltage release, independant from supply voltage
- iMX: shunt release
- iMX+OF: shunt release with open/close contact.

EN 50550

- iMSU: overvoltage release.

Indication auxiliaries:

IEC/EN 60947-5-1

- iOF: open/close contact
- iSD: fault indicating contact
- iOF/SD+OF: open/close contact and switchable OF or SD function

IEC/EN 60947-5-4

- Auxiliaries dedicated to low current applications (PLC...)
- iOF Low Current: open/close contact
- iSD Low Current: fault indicating contact
- iSD+OF Low Current: open/close contact and fault indicating SD contact
- iOF+SD24: open/close contact OF and fault indicating contact SD with Ti24 interface.



Electrical auxiliaries for Acti9 iID B-SI type RCCB (cont.)

		Tripping						
Auxiliaries		iMN		iMNs		iMNx		
Type		Undervoltage release						
		Instantaneous		Delayed		Independent of the supply voltage		
Function		<ul style="list-style-type: none"> Trips the device with which it is combined when its input voltage decreases (between 70 % and 35 % U_n). Prevents device closing again until its input voltage is restored 		<ul style="list-style-type: none"> Not tripping on transient voltage dip (up to 0.2 s) 		<ul style="list-style-type: none"> Tripping of the associated device by opening of the control circuit (e.g. push-button, dry contact) A drop in the supply voltage does not trip the associated device A locking push-button control allows the circuit protected (e.g. machine control) to be placed in safety configuration 		
Wiring diagrams								
Use		<ul style="list-style-type: none"> Emergency stoppage by normally closed push button Improve the safety of power supply circuits for several machines by preventing "uncontrolled" restarting 		<ul style="list-style-type: none"> Emergency stoppage with fail-safe principle Insensitive to control circuit voltage variation to increase service continuity Important: Before any servicing operation switch off the mains power supply (voltage presence at terminals E1/E2) 				
Catalog numbers		A9A26960	A9A27108	A9A26961	A9A26959	A9A26963	A9A26969	A9A26971
iID double terminals		■	■	■	■	■	■	■
Technical specifications								
Rated voltage (U_e)	220...240 V AC	24 V AC	48 V AC	115 V AC	220...240 V AC	220...240 V AC	380...415 V AC	
	–	24 V DC	48 V CC	–	–	–	–	–
Standardised operating and non-response to voltage times (U_a)*	–	–	–	–	–	–	–	–
Maximum operating time	–	–	–	–	–	–	–	–
Minimum non-response time	–	–	–	–	–	–	–	–
Operating frequency	50/60 Hz	–	–	400 Hz	50/60 Hz	50/60 Hz	–	–
Red mechanical indicator	On front face	–	–	–	On front face	On front face	–	–
Test function	–	–	–	–	–	–	–	–
Width in 9 mm modules	2	–	–	–	2	2	–	–
Operating current	–	–	–	–	–	–	–	–
Number of contacts	–	–	–	–	–	–	–	–
Busbar compatibility	Top and bottom	–	–	–	Top and bottom	Top	–	–
Operating temperature	–35...+70°C / -31°F...158°F	–	–	–	–35...+70°C / -31°F...158°F	–35...+70°C / -31°F...158°F	–	–
Storage temperature	–40...+85°C / -40°F...185°F	–	–	–	–40...+85°C / -40°F...185°F	–40...+85°C / -40°F...185°F	–	–



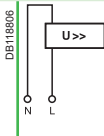
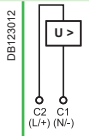
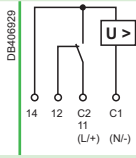

*(U_a)

Voltages measured between the phase and the neutral conductor, at which the iMSU device must control the associated protective device.



Electrical auxiliaries for Acti9 iID B-SI type RCCB (cont.)

iMSU					iMX			iMX+OF		
Overvoltage release					Shunt release			With Open/Close auxiliary contact		
										
<ul style="list-style-type: none"> Switches off the power supply by opening the breaker with which it is combined, in the event that the phase/neutral voltage is exceeded (loss of neutral). For a four-phase network, use three iMSU tripping auxiliaries. 					<ul style="list-style-type: none"> Trips the associated device when it is powered on 			<ul style="list-style-type: none"> Includes an open/close contact (OF) to indicate the "open" or "closed" position of the device 		
										
<ul style="list-style-type: none"> Protection of equipment against overvoltages on the electrical network (neutral conductor break) Voltage monitoring between phase and neutral conductors 					<ul style="list-style-type: none"> Emergency stoppage by normally open push button 			<ul style="list-style-type: none"> Emergency stoppage by normally open push button Remote indication of the position of the associated device 		
A9A26500					A9A26476	A9A26477	A9A26478	A9A26946	A9A26947	A9A26948
■					■	■	■	■	■	■
230 V AC					100...415 V AC			100...415 V AC		
-					110...130 V DC			110...130 V DC		
255 V AC					48 V AC			48 V AC		
275 V AC					48 V DC			48 V DC		
300 V AC					12...24 V AC			12...24 V AC		
350 V AC					-			-		
400 V AC					-			-		
No tripping					-			-		
15 s					-			-		
5 s					-			-		
0.75 s					-			-		
0.20 s					-			-		
3 s					-			-		
1 s					-			-		
0.25 s					-			-		
0.07 s					-			-		
50/60 Hz					50/60 Hz			50/60 Hz		
On front face					On front face			On front face		
-					-			-		
2					2			2		
-					-			100 mA mini, 6 A maxi		
-					-			≤ 130 V DC 1 A		
-					-			48 V AC 2 A		
-					-			≤ 24 V AC 6 A		
-					-			48 V DC 2 A		
-					-			≤ 24 V DC 6 A		
-					-			415 V AC 3 A		
-					-			1 NO/NC		
Top and bottom					Top and bottom			Top		
-35...+70°C / -31°F...158°F					-35...+70°C / -31°F...158°F			-35...+70°C / -31°F...158°F		
-40...+85°C / -40°F...185°F					-40...+85°C / -40°F...185°F			-40...+85°C / -40°F...185°F		

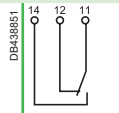
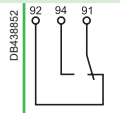
Electrical auxiliaries for Acti9 iID B-SI type RCCB (cont.)

		Indication			
Auxiliaries		iOF		iSD	
Type		Open/close auxiliary contact		Fault indicating contact	
					
Function		<ul style="list-style-type: none"> Changeover contact indicates "open" or "closed" position of the device Low current auxiliary (2 to 100 mA): 1 contact (1 NO/NC) can report the signalling information to a Programmable Logic Controller (Industry) or a Controller (Building/BMS) 		<ul style="list-style-type: none"> Changeover contact indicates position of the device upon: <ul style="list-style-type: none"> electrical fault action on tripping auxiliary Same indication as VISI-TRIP Low current auxiliary (2 to 100 mA): 1 contact (1 NO/ NC) can report the signalling information to a Programmable Logic Controller (Industry) or a Controller (Building/BMS) 	
Wiring diagrams					
Use		<ul style="list-style-type: none"> Remote indication of the position of the associated device 		<ul style="list-style-type: none"> Remote indication of tripping upon a fault of the associated device 	
Catalog numbers		A9A26915	A9A26905	A9A26916	A9A26906
iID double terminals		■	■	■	■
Technical specifications					
Rated voltage (Ue)		24...250 V AC	24...415 V AC	24...250 V AC	24...415 V AC
		24...220 V DC	24...130 V DC	24...220 V DC	24...130 V DC
Operating frequency		50/60 Hz		50/60 Hz	
Red mechanical indicator		-		On front face	
Test function		On toggle		On toggle	
Width in 9 mm modules		1		1	
Operating current	24 V DC	2 mA to 100 mA	100 mA to 6 A	2 mA to 100 mA	100 mA to 6 A
	48 V DC		100 mA to 2 A		100 mA to 2 A
	60 V DC		100 mA to 1.5 A		100 mA to 1.5 A
	130 V DC		100 mA to 1 A		100 mA to 1 A
	220 V DC		-		-
	24...240 V AC		100 mA to 6 A		100 mA to 6 A
	415 V AC		100 mA to 3 A		100 mA to 3 A
Number of contacts		1 NO (OF) / NC	1 NO (OF) / NC	1 NO / NC (SD)	1 NO / NC (SD)
Connections - terminals		Screw clamp		Screw clamp	
Wiring position		Top	Top	Top	Top
Busbar compatibility		Bottom	Bottom	Bottom	Bottom
Operating temperature		-25...+70°C / -13°F...158°	-35...+70°C / -31°F...158°F	-25...+70°C / -13°F...158°	-35...+70°C / -31°F...158°F
Storage temperature		-40...+85°C / -40°F...185°F		-40...+85°C / -40°F...185°F	

Electrical auxiliaries for Acti9 iID B-SI type RCCB (cont.)

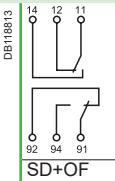
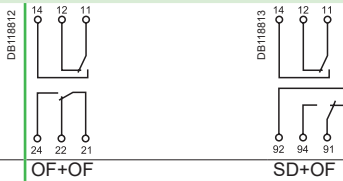
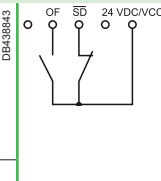
iSD+OF	iOF/SD+OF	iOF+SD24
Open/close and fault indicating contact	Double open/close or fault indicating contact	Double open/close and fault indicating contact
		
<ul style="list-style-type: none"> The iSD+OF auxiliary is a 2-in-1 product: it provides an OF+SD contact 2 contacts (2 NO/NC) can report the signalling information of the associated device to a Programmable Logic Controller (Industry) or a Controller (Building/BMS) 	<ul style="list-style-type: none"> The iOF/SD+OF auxiliary is a 2-in-1 product: via a mechanical selector switch, it provides 2 contacts, OF+SD or OF+OF 	<ul style="list-style-type: none"> 2 contacts (1 NO + 1 NC) can report the signalling information of the associated device to the Acti9 Smartlink, a Programmable Logic Controller (Industry) or a Controller (Building/BMS): <ul style="list-style-type: none"> electrical fault actuation of the tripping auxiliary "Open" or "Closed" position of the associated device
		
<ul style="list-style-type: none"> Remote indication of position and tripping upon a fault of the associated device 	<ul style="list-style-type: none"> Remote indication of position and/or tripping upon a fault of the associated device 	<ul style="list-style-type: none"> Remote indication of position and tripping upon a fault of the associated device
A9A26919	A9A26909	A9A26897
■	■	■
24...250 V AC	24...415 V AC	-
24...220 V DC	24...130 V DC	24 V DC
50/60 Hz	50/60 Hz	-
On front face	On front face	On front face
On toggle	On toggle	On toggle
1	1	1
2 mA to 100 mA	100 mA to 6 A 100 mA to 2 A 100 mA to 1.5A 100 mA to 1 A	2 mA to 100 mA
-	100 mA to 6 A	-
-	100 mA to 3 A	-
1 NO (OF) / NC 1 NO / NC (SD)	1 NO (OF) / NC 1 NO (OF) / NC	1 NO (OF) + 1 NC (SD)
Screw clamp	Screw clamp	Spring-loaded Ti24 (sold separately)
Top and bottom	Top and bottom	Top Bottom
-	-	-
-25...+70°C / -13°F...158°	-35...+70°C / -31°F...158°F	-25...+70°C / -13°F...158°
-40...+85°C / -40°F...185°F	-40...+85°C / -40°F...185°F	-40...+85°C / -40°F...185°F

Electrical auxiliaries for Acti9 iLD B-SI type RCCB (cont.)

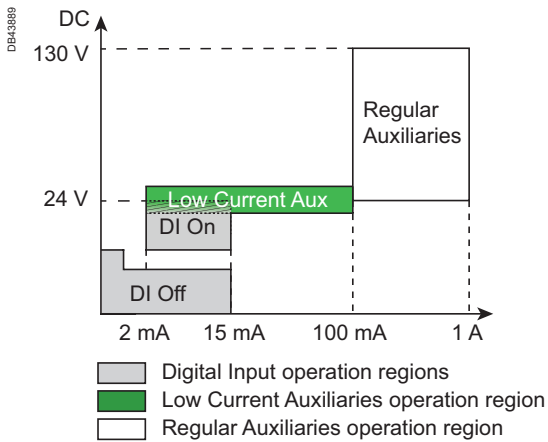

How to generate summary data using OF or SD contacts of low current electrical auxiliaries

- Electrical summary of the OF signals or electrical summary of the SD signals can be generated with low current indication auxiliaries (2 mA to 100 mA) wired as a daisy chain
- The OF connections and the SD connections must not be connected on the same daisy chain: 2 separate daisy chains are required to report OF information on the one hand and SD information on the other
- A daisy chain is made of up to 100 OF contacts or 100 SD contacts
- A daisy chain is connected locally to the PLC or the Controller (inside the same switchboard).

OF contacts within a daisy chain

- OF contacts are Normally Open (NO)
- The electrical summary of the OF signals can be done by cabling in series all OF signals
- Any open position opens the daisy chain and can be detected.



SD contacts within a daisy chain

- SD contacts are Normally Closed (NC)
- The electrical summary of the SD signals can be done by cabling in series all SD signals
- Any SD signal opens the daisy chain and can be detected.

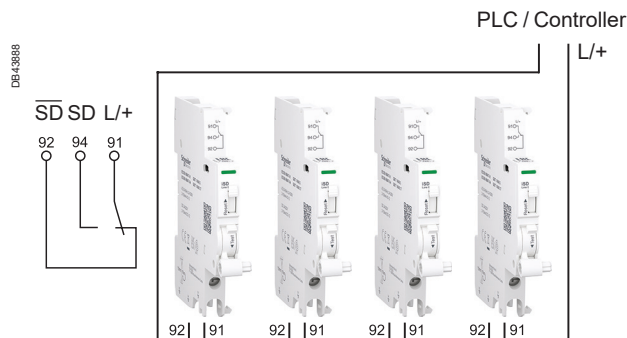

Electrical auxiliaries for Acti9 iID B-SI type RCCB (cont.)

Connection

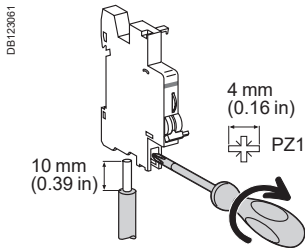

Type	Tightening torque	Copper cables		Multi-cables	
		Rigid	Flexible	Rigid	Cables with ferrule
		DB 122945	DB 123007	DB 123011	DB 123008
Indication auxiliaries	1 N.m / 8.85 lb.in	1 to 4 mm ² / AWG #18 to #12	0.5 to 2.5 mm ² / AWG #20 to #14	2 x 2.5 mm ² / 1 x AWG #14	2 x 1.5 mm ² / 1 x AWG #16
Tripping auxiliaries	1 N.m / 8.85 lb.in	1 to 6 mm ² / AWG #18 to #10	0.5 to 4 mm ² / AWG #20 to #12	2 x 2.5 mm ² / 1 x AWG #14	2 x 2.5 mm ² / 1 x AWG #14

Ti24 connector connection

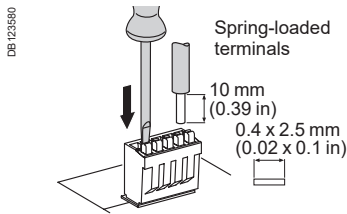

Type	Catalog numbers	Copper cables	
		Rigid	Flexible
		DB 122945	DB 123553
Ti24 interface	A9XC2412	1 x 0.5 to 1.5 mm ² / 1 x AWG #20 to #16	1 x 0.5 to 1.5 mm ² / 1 x AWG #20 to #16

Ti24 prefabricated cables connection

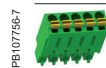
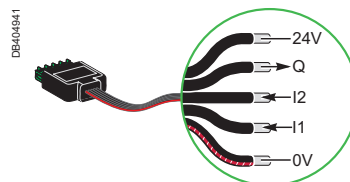

Type	Catalog numbers	Length
Connection for Acti9 Smartlink		
6 prefabricated	A9XCAS06	100 mm (3.94 in)
	A9XCAM06	160 mm (6.3 in)
	A9XCAH06	450 mm (17.72 in)
	A9XCAL06	870 mm (34.25 in)
Connection for PLC type terminals		
6 long prefabricated on a single side	A9XCAU06	870 mm (34.25 in)
1 long prefabricated on a single side	A9XCAC01	4000 mm (157.48 in)
12 connectors, 5-pins (Ti24)	A9XC2412	-

Electrical auxiliaries for Acti9 iID B-SI type RCCB (cont.)

Technical data

Weight (g / oz)

Electrical auxiliaries	
Type	
iMN	69 g / 2.43 oz
iMNs	72 g / 2.54 oz
iMNx	79 g / 2.79 oz
iMSU	68 g / 2.4 oz
iMX	64 g / 2.26 oz
iMX+OF	68 g / 2.4 oz
iOF	32 g / 1.13 oz
iSD	33 g / 1.16 oz
iOF/SD+OF	43 g / 1.52 oz
iOF+SD24	25 g / 0.88 oz

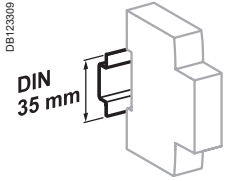

Clip on DIN rail 35 mm (1.38 in)

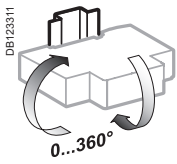

Indifferent position of installation

Dimensions (mm / inches)

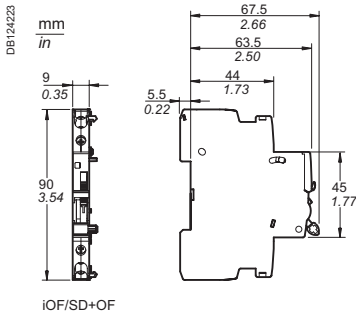

iOF/SD+OF

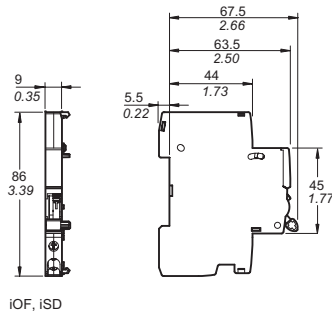

iOF, iSD

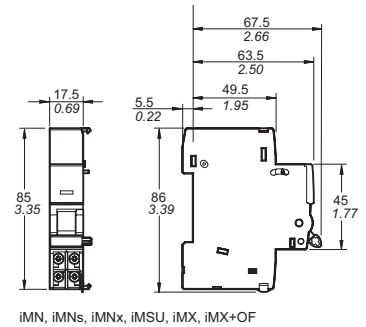

iMN, iMNs, iMNx, iMSU, iMX, iMX+OF

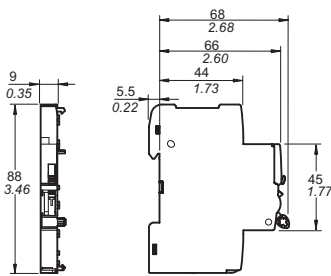

iOF+SD24 (A9A26897)

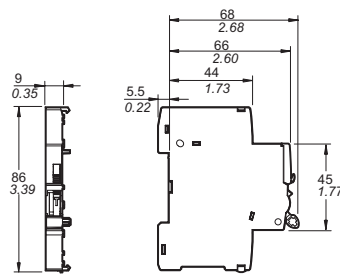





iOF+SD24 (A9A26898)

Accessories for MCB and RCD, except Acti9 iLD B-SI type RCCB

Installation				
Accessories	Rotary handle			Plug-in base
	<p>PB100137_SE-24 PB100138_SE-24</p>			<p>PB111764-40</p>
Function				
	<p>Front or side control of 2, 3 and 4-pole circuit breakers</p> <ul style="list-style-type: none"> ■ Degree of protection: IP40 ■ A complete rotary handle consists of: <ul style="list-style-type: none"> □ a circuit breaker operating sub-assembly, cat. no. 27046, □ a handle cat. no. 27047 or a handle cat. no. 27048 ■ Installation: <ul style="list-style-type: none"> □ the circuit breaker operating sub-assembly cat. no. 27046 is fixed to the circuit breaker □ the removable handle cat. no. 27047 is mounted on the removable front panel or on the enclosure door □ the fixed handle cat. no. 27048 is fixed to the front or side panel of the enclosure 			<p>Allows a circuit breaker to be quickly removed or replaced, without touching the connections</p> <ul style="list-style-type: none"> ■ Degree of protection: IP20 ■ It consists of: <ul style="list-style-type: none"> □ a base to be fixed to a rail (or panel) □ 2 "blades" to be fixed in the device terminals ■ Connection: tunnel terminals for cables up to 50 mm² (rigid) or 35 mm² (flexible) ■ Installation: <ul style="list-style-type: none"> □ on backplate □ on a horizontal rail ■ Centreline between two rows: 200 mm (7.87 in) ■ Only on the circuit breaker, without a Vigi device or auxiliary ■ Padlocking option: 8 mm (0.31 in) diameter, padlock not supplied)
Cat. numbers	27047 Removable extended handle	27048 Fixed handle	27046 Operating sub-assembly	26996 (1 per pole)
Set of	1	1	1	1
Suitable for the following devices:				
C60_{BP} UL489, C60_{BPR} UL489	■ 2P, 3P			—
C60_{SP} UL1077	■ 2P, 3P, 4P			■
C60_{H-DC}	■ 2P			■
GFP UL1053	—			■
C60_{N, H, L, C60_{CTRL}}	■ 2P, 3P, 4P			■
N40_N	■ 3P+N			—
RCCB-ID 125 A	—			—
N40 Vigi	—			—
Operating temperature	-35°C to +70°C / -31°F to 158°F			-35°C to +70°C / -31°F to 158°F

Accessories for MCB and RCD, except Acti9 iLD B-SI type RCCB (cont.)

Accessories		Padlocking device		
		Front		Side
				
	05720A_SE-20	DB409566-25	AGA26380-40	AGA26381-40
Function				
	<p>Used to padlock a circuit breaker in the "open" or "closed" position</p> <ul style="list-style-type: none"> Locking in the ON position does not prevent the circuit breaker from tripping in the event of an electrical fault Isolation: in conformity with IEC/EN 60947-2. Diameter of the padlock: 8 mm (0.31 in) max. 	<p>Used to padlock a circuit breaker in the "open" position</p> <ul style="list-style-type: none"> Isolation: in conformity with UL 489/CSA C22.2 No 5 Listed and UL 1077 Recognized. Diameter of the padlock: 8 mm (0.31 in) max. 	<p>Can be used to padlock a circuit breaker in open position</p> <ul style="list-style-type: none"> Attached directly to the circuit breaker, it cannot be lost Padlock diameter: 6 mm (0.24 in) 	
Cat. numbers	26970	M9PAF	MGN26380 Left-hand mounting	MGN26381 Right-hand mounting
Set of	2	1	1	1
Suitable for the following devices:				
C60 _{BP} UL489, C60 _{BPR} UL489	■	■	■	■
C60 _{SP} UL1077	■	■	■	■
C60 _{H-DC}	■	■	■	■
GFP UL1053	■	—	—	—
C60 _N , H, L, C60 _{CTRL}	■	■	■	■
N40N	■	■	■	■
RCCB-ID 125 A	—	—	—	—
N40 Vigi	■	—	—	—
Operating temperature	-35°C to +70°C / -31°F to 158°F	-35°C to +70°C / -31°F to 158°F	-35°C to +70°C / -31°F to 158°F	-35°C to +70°C / -31°F to 158°F





Accessories for MCB and RCD, except Acti9 iLD B-SI type RCCB (cont.)

Installation (continued)



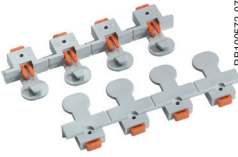



Accessories	Front mounting kit	DIN rail support	Pole filler	Front mounting bracket

Function	<ul style="list-style-type: none"> Consists of a transparent, hinged, weatherproof cover Allows installation of up to twenty modules (10 poles of C60) of circuit breakers or supplementary protectors and accessories A DIN rail with support is also available Degree of protection as per IEC 529: IP55 Includes a 10-Module divisible blanking plate and mounting template 	<ul style="list-style-type: none"> DIN rail with support for front mounting kit cat. no. 14210 Allows installation of up to twenty modules (10 poles of C60) of circuit breakers or supplementary protectors and accessories 	<ul style="list-style-type: none"> Used to fill empty panels spaces They clip into space They may be snapped apart in 9 mm (0.35 in) increments 	<ul style="list-style-type: none"> Provides a convenient way to mount circuit breakers, supplementary protectors or accessories Allows the C60 devices to be clipped onto it in a standard manner In 480 V AC UL 1077 applications, cat. no. 26981 terminal screw shield should be used for increased isolation between the terminal screws of the device and the mounting bracket. These shields are included with the mounting bracket kits 	
Cat. numbers	14210	14211	M9PF4 4 strips of 4 by 18 mm (0.71 in) pole filler	M9PF5 4 strips of 5 by 18 mm (0.71 in) pole filler	MG26983 MG26984 MG26985 MG26989
Set of	1	1	4	4	1
Suitable for the following devices:	<ul style="list-style-type: none"> C60^{BP} UL489, C60^{BPR} UL489 C60^{SP} UL1077 C60^{H-DC} GFP UL1053 C60N, H, L, C60^{CTRL} N40N RCCB-ID 125 A N40 Vigi 	For multi-pole mounting kit cat. no.14210	For multi-pole mounting kit cat. no.14210	<ul style="list-style-type: none"> 	
Operating temperature	-35°C to +70°C / -31°F to 158°F			-35°C to +70°C / -31°F to 158°F	

Accessories for MCB and RCD, except Acti9 iLD B-SI type RCCB (cont.)



Security						
Accessories	Screw shield		Terminal shield	Interpole barrier	Spacer	
						
Function	Prevents all contact with the fixing screws <ul style="list-style-type: none"> The degree of protection becomes IP40 Sealable, max. diameter 1.2 mm (0.05 in) 		Prevents all contact with the terminals <ul style="list-style-type: none"> Degree of protection becomes IP40 Sealable, max. diameter 1.2 mm (0.05 in) 1P <input type="checkbox"/> 2P <input type="checkbox"/> 3P: 1 x 26975 + 1 x 26976 4P: 2 x 26976 		Improves the insulation between the connections: cables, terminals, lugs, etc. <ul style="list-style-type: none"> Used to: <ul style="list-style-type: none"> complete the rows separate the devices Width: 1 x 9 mm (0.35 in) module Allows that 2 cables are routed from one row to another (above and below), up to 6 mm² 	
Cat. numbers	26981	16939	26975	26976	27001	27062
Set of	2 (4P dividable)	10	2 (for upstream/downstream terminal)		10	1
Suitable for the following devices:						
C60 ^{BP} UL489,	–	–	–	–	–	■
C60 ^{BPR} UL489	–	–	–	–	–	■
C60 ^{SP} UL1077	■	–	■	■	■	■
C60 ^{H-DC}	■	–	■	■	■	■
GFP UL1053	■	–	–	–	–	■
C60N, H, L,	■	–	■	■	■	■
C60 ^{CTRL}	–	–	–	–	–	■
N40N	–	–	–	–	–	■
RCCB-ID 125 A	–	■	–	–	–	■
N40 Vigi	–	–	–	–	–	■
Operating temperature	-35°C to +70°C / -31°F to 158°F	-35°C to +70°C / -31°F to 158°F	-35°C to +70°C / -31°F to 158°F		-35°C to +70°C / -31°F to 158°F	-35°C to +70°C / -31°F to 158°F

Accessories for MCB and RCD, except Acti9 iLD B-SI type RCCB (cont.)



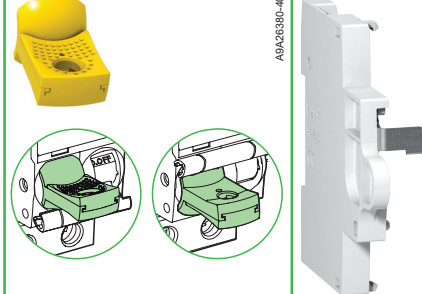

Accessories	Connection			Spare part
	Multi-cable terminal	50 mm ² / #1 AWG Al terminal	Connection kit for ring terminals	Locking clips
 DB10334_SE19	 DB12261	 DBA09586	 27052-16	
Function	For 3 copper cables: <ul style="list-style-type: none"> ■ Rigid up to 16 mm² ■ Flexible up to 10 mm²  DB116787	For 16 to 50 mm ² aluminium cables  DB12261	For terminal up to 63 A, front or rear access <ul style="list-style-type: none"> ■ It incorporates a "conductive" part and an "insulating" part which ensures the phase-to-phase clearance 	Top and bottom locking clips
Cat. numbers	19091	19096	27060	M9A17400
Set of	4	3	1	24
Suitable for the following devices:				
C60 _{BP} UL489, C60 _{BPR} UL489	–	–	–	–
C60 _{SP} UL1077 ≤ 25 A	–	–	–	■
C60 _{SP} UL1077 > 25 A	■	■	–	■
GFP UL1053	■	■	–	–
C60 _N , H, L, ≤ 25 A, C60 _{CTRL}	–	–	–	■
C60 _N , H, L, > 25 A, C60 _{CTRL}	■	■	■	■
C60 _{H-DC} ≤ 25 A	–	–	–	■
C60 _{H-DC} > 25 A	■	■	■	■
N40N	–	–	–	–
RCCB-ID 125 A	–	–	–	–
N40 Vigi	–	–	–	–
Tightening torque	2 N.m (18 lb.in)	10 N.m (89 lb.in)	2 N.m (18 lb.in)	–
Stripping length	11 mm (0.43 in)	13 mm (0.51 in)	–	–
Tools to be used	Flat 5 mm (0.2 in) or PZ2	Hc 1/5" or 5 mm (0.2 in)	Flat 5 mm (0.2 in) or PZ2	–
Operating temperature	–35°C to +70°C / -31°F to 158°F		–35°C to +70°C / -31°F to 158°F	–35°C to +70°C / -31°F to 158°F

Accessories	Identification			
	Clip-on terminal marker strip			
 031204D_SE23				
Function	For connection identification			
Cat. numbers	0: AB1-R0 1: AB1-R1 2: AB1-R2 3: AB1-R3 4: AB1-R4 5: AB1-R5 6: AB1-R6 7: AB1-R7 8: AB1-R8 9: AB1-R9	A: AB1-GA B: AB1-GB C: AB1-GC D: AB1-GD E: AB1-GE F: AB1-GF G: AB1-GG H: AB1-GH I: AB1-GI J: AB1-GJ	K: AB1-GK L: AB1-GL M: AB1-GM N: AB1-GN O: AB1-GO P: AB1-GP Q: AB1-GQ R: AB1-GR S: AB1-GS T: AB1-GT	U: AB1-GU V: AB1-GV W: AB1-GW X: AB1-GX Y: AB1-GY Z: AB1-GZ +: AB1-R12 -: AB1-R13 Blank: AB1-RV
Set of	250			
Suitable for the following devices:				
C60 _{BP} UL489	–			
C60 _{BPR} UL489	–			
C60 _{SP} UL1077	■ 4 markers max. per pole			
C60 _{H-DC}	■ 4 markers max. per pole			
GFP UL1053	■ 4 markers max. per pole			
C60 _{H-DC}	■ 4 markers max. per pole			
C60 _N , H, L, C60 _{CTRL}	■ 4 markers max. per pole			
N40N	■ 4 markers max. per pole			
RCCB-ID 125 A	–			
N40 Vigi	■ 4 markers max. per device			





Accessories for Acti9 iID B-SI type RCCB

Mounting							
Accessories	Rotary handle			Plug-in base	Padlocking device		
					Front	Side	
							
Function	<p>Front or side-mounted control rotary handle</p> <ul style="list-style-type: none"> ■ Degree of protection: IP55 ■ Installation: <ul style="list-style-type: none"> □ the control mechanism is mounted on the device □ the rotary handle is fixed to the front or side of the enclosure ■ Front-mounted (on door or faceplate) ■ Prevents the door from opening when the device is in the ON position (can be deactivated) ■ Can be padlocked when the device is in the "open" position (can be padlocked with the device in the "closed" position subject to adaptation) ■ Can be locked by padlock of (dia. 5 to 8 mm / 0.2 to 0.31 in), not supplied with the device ■ Pushbutton: iID test available in the front face of the rotary handle 			<ul style="list-style-type: none"> ■ The Laser Square tool brings the accuracy to align the breaker and the rotary handle 	<p>Allows a breaker to be removed or replaced quickly, without handling the connections</p> <ul style="list-style-type: none"> ■ Degree of protection: IP20 ■ Consists of: <ul style="list-style-type: none"> □ a base to be fastened on a rail (or panel) □ 2 "blades" to be fastened in the device's terminals ■ Connection: tunnel terminals for cable up to 35 mm² rigid, 25 mm² flexible, ■ Installation: <ul style="list-style-type: none"> □ in universal enclosure □ on horizontal rail ■ Height: 178 mm (7.01 in) ■ Not compatible with Vigi iC60 and auxiliaries ■ Can be locked by padlock of (dia. 6 mm / 0.24 in), not supplied with the device 	<p>Used to padlock a breaker in open or closed position</p> <ul style="list-style-type: none"> ■ Padlock diameter: 3 to 6 mm (0.12 to 0.24 in) ■ Sealable (max. diameter: 1.2 mm / 0.05 in) ■ Locking in ON position does not prevent tripping of the breaker in the event of faults ■ Suitable for IEC/EN 60947-2 compliant disconnection 	<p>Can be used to padlock a breaker in open position</p> <ul style="list-style-type: none"> ■ Attached directly to the circuit breaker, it cannot be lost ■ Padlock diameter: 6 mm (0.24 in)
Catalog numbers	A9A27005	A9A27006	A9A27008	GVAPL01	A9A27003 (1 per pole)	A9A26970	A9A26380
	Operating sub-assembly						Left-hand mounting
	+	+					
	Black handle	Red handle	No handle				
Set of	1	1	1	1	1	10	1
Suitability							
iID	■				■ ≤ 63 A	■	■
ARA+iID	-				-	■	-

Accessories for Acti9 iID B-SI type RCCB (cont.)

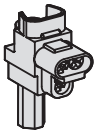
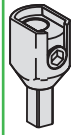
Security				
Accessories	Screw shield	Terminal shield	Inter-pole barrier	Spacer
	 <p>PB104488-14</p>	 <p>PB104503-35</p>	 <p>PB104484-30</p>	 <p>PB104483-35</p>
Function	<p>Prevents any contact with the connecting screws</p> <ul style="list-style-type: none"> Upgrades degree of protection to IP20D Sealable, max. diameter 1.2 mm (0.05 in) 	<p>Prevents any contact with the terminals</p> <ul style="list-style-type: none"> Upgrades degree of protection to IP20D Sealable, max. diameter 1.2 mm (0.05 in) Set of two, for power supply and output terminals For 3 poles: A9A26975 + A9A26976 For 4 poles: 2 X A9A26976 	<p>Enhances insulation between connections: cables, terminals, lugs, etc</p>	<ul style="list-style-type: none"> Used to: <ul style="list-style-type: none"> complete rows separate devices. Width: 1 x 9 mm (0.35 in) module Allows cable routing from one row to another, (above and below), up to 6 mm²
Catalog numbers	A9A26981	A9A26976	A9A27001	A9A27062
Set of	20 x 4 poles (splittable)	2 x 2 poles	10	5
Suitability				
iID	■	■	■	■
ARA+iID	■	■	■	■

Accessories for Acti9 iID B-SI type RCCB (cont.)

		Connection		
Accessories	Multi-cable terminal	50 mm ² Al terminal	Screw-on connection for ring terminal	
				
Function				
	<p>For 3 copper cables:</p> <ul style="list-style-type: none"> ■ Rigid up to 16 mm² ■ Flexible up to 10 mm² 	For aluminium cables from 16 to 50 mm ²	For lug tipped cables, front or rear mounting To be used only with inter-pole barrier (A9A27001)	
			 Ø 5 mm (0.2 in)	
Catalog numbers	19091	19096	27060	27053
Set of	4	3	1	8
Suitability				
iID	■	■	■	■
Tightening torque	2 N.m		10 N.m	2 N.m
Length stripping	11 mm (0.43 in)		13 mm (0.51 in)	–
Tools to use	Dia. 5 mm (0.2 in) or PZ2		Hc 1/5" or 5 mm (0.2 in)	Dia. 5 mm (0.2 in)

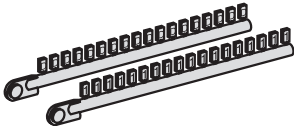
		Marking					
Accessories	Clip-on terminal markers						
							
Used for connection identification							
Catalog numbers	0: AB1-R0 1: AB1-R1 2: AB1-R2 3: AB1-R3 4: AB1-R4	5: AB1-R5 6: AB1-R6 7: AB1-R7 8: AB1-R8 9: AB1-R9	A: AB1-GA B: AB1-GB C: AB1-GC D: AB1-GD E: AB1-GE F: AB1-GF G: AB1-GG H: AB1-GH I: AB1-GI	J: AB1-GJ K: AB1-GK L: AB1-GL M: AB1-GM N: AB1-GN O: AB1-GO P: AB1-GP Q: AB1-GQ R: AB1-GR	S: AB1-GS T: AB1-GT U: AB1-GU V: AB1-GV W: AB1-GW X: AB1-GX Y: AB1-GY Z: AB1-GZ	+ : AB1-R12 - : AB1-R13 Blank: AB1-RV	
Set of	250						

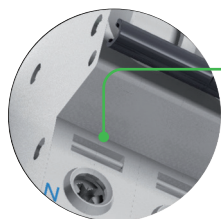

■ 4 markers max. per zone

Accessories for Acti9 iID B-SI type RCCB (cont.)

Dimensions (mm / inches)

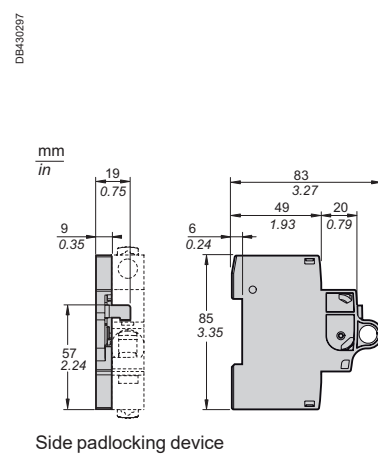
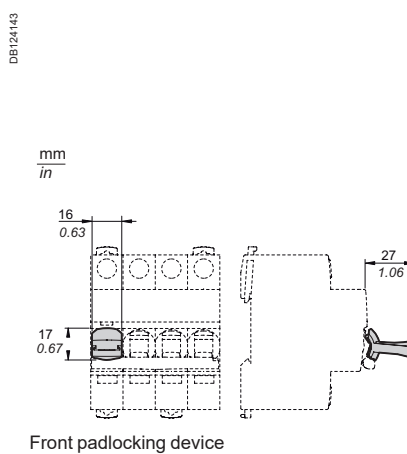
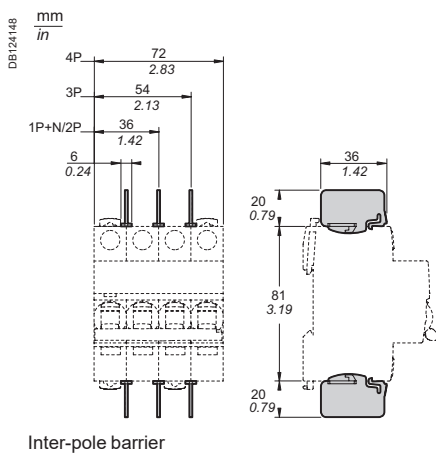
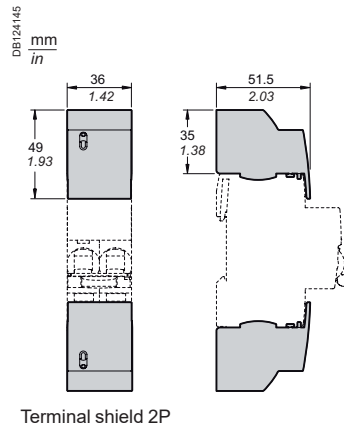
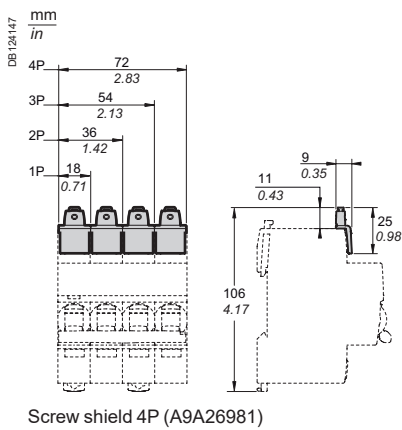
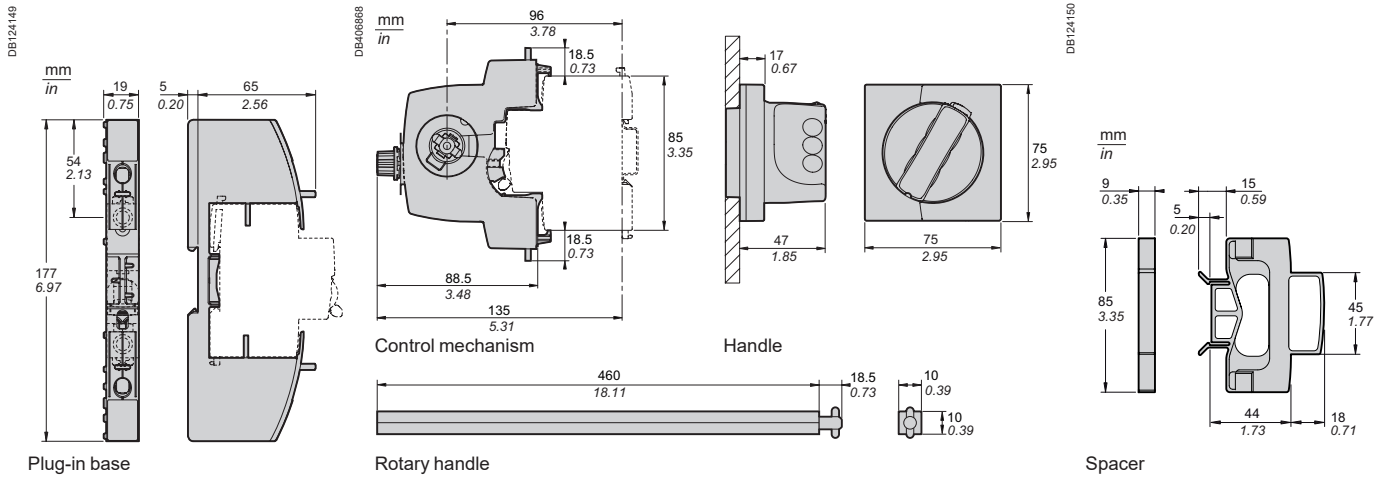

Accessories for Acti9 iID B-SI type RCCB (cont.)

Rotary handle installation

Dimensions (mm / inches)

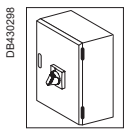

iID	Z (mm / in.)
2P	25.3 / 1.00
4P	25.3 / 1.00

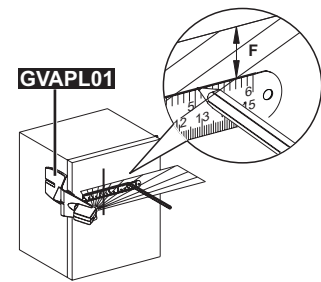
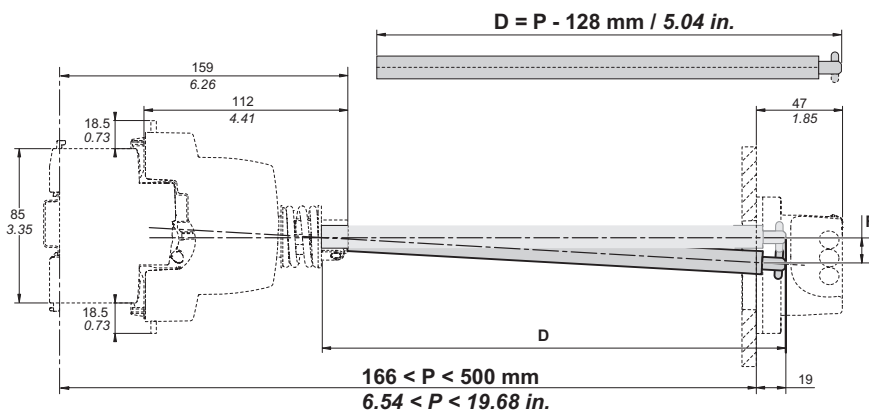
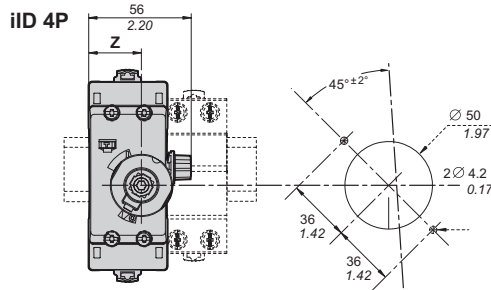

P (mm / in.)	F (mm / in.)
300 / 11.81	5 / 0.20
500 / 19.68	11 / 0.43

Rotary handle: front mounted control

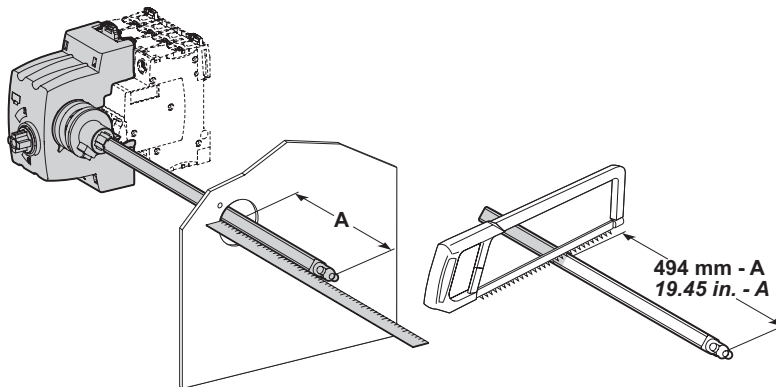
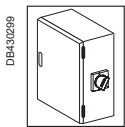

iID	X (mm / in.)	Y (mm / in.)
2P	44.5 / 1.75	76.8 / 3.02
4P	44.5 / 1.75	76.8 / 3.02

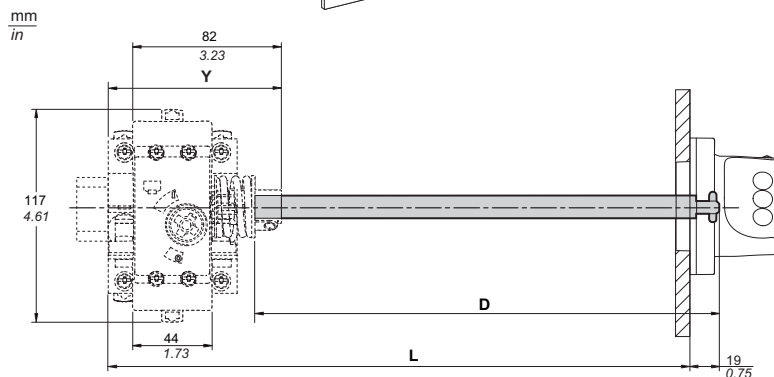

Rotary handle: side mounted control

Auxiliaries and accessories

Comb busbars for C60BP



These comb busbars are aimed to be used only with C60BP circuit breakers.

They perform distribution and subdistribution of the electric power supply and allow rapid assembly and disassembly of equipment.

Comb busbars

Connection accessories	Comb busbars
-------------------------------	---------------------

Function

- The comb busbars make it easier to install C60BP UL 489 circuit breakers
- They must not be cut

Use

- Power supply by insulated connector

Standard comb busbars



Number of poles	1P		2P		3P	
Catalog numbers	M9XUP106	M9XUP112	M9XUP206	M9XUP212	M9XUP306	M9XUP312
Number of 18 mm (0.71 in) mod.	6	12	6	12	6	12
Set of	1		1		1	

Cuttable comb busbars

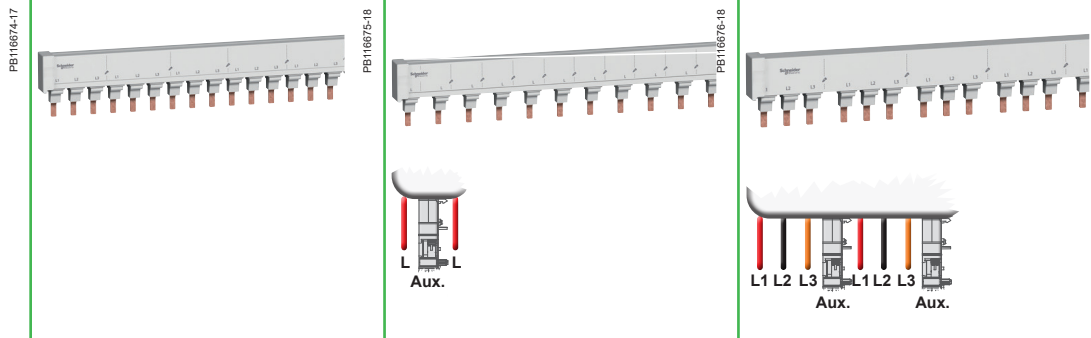

With spare spaces of 9 mm (0.35 in) for 9 mm (0.35 in) electrical auxiliary

Number of poles	1P	2P	3P	1P+Aux	3P+Aux	
Catalog numbers	M9XCP157	M9XCP256	M9XCP357	M9XCA137	M9XCA348	
Number of 18 mm (0.71 in) mod.	57	56	57	37	48	
Set of	1		1		1	

Technical specifications

Acceptable current at 40°C (104 °F) (Ie)	Standard comb busbars: 115 A Cutttable comb busbars: 80 A
Resistance to short-circuit currents	Compatible with the breaking capacity of Schneider Electric modular circuit breakers
Voltage rating (Ue)	480Y/277 V
Insulation voltage (Ui)	1000 V AC
Pollution degree	3
Fire resistance	Self-extinguishability 960°C (1760 °F) 30 secondes
Colour	RAL 9001
Standards	UL489 and UL508





Auxiliaries and accessories

Comb busbars for C60BP (cont.)

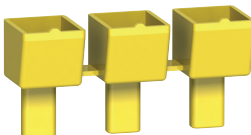

These comb busbars are aimed to be used only with C60BP circuit breakers.

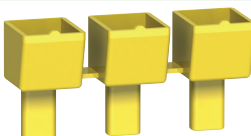
They perform distribution and subdistribution of the electric power supply and allow rapid assembly and disassembly of equipment.

Accessories			
Connection accessories	Insulated connectors	Tooth covers	End-piece
Function			
	<ul style="list-style-type: none"> Comb busbar power supply Vertical incoming feeder 	<ul style="list-style-type: none"> Insulation of teeth remaining free 	<ul style="list-style-type: none"> Insulation of end of comb busbar
Use			
	<ul style="list-style-type: none"> Rigid and flexible copper cable: 6 to 35 mm² (AWG #10 to #2) Tightening torque: 3.5 N.m (31 lb.in) Tool to use: hexagonal key Sw4 (4mm). 		
Standard comb busbars			
			
Number of poles	All	All	-
Catalog numbers	M9XUPC04	M9XUTC15	-
Number of 18 mm (0.71 in) mod.	-	-	-
Set of	4	5 x 3	-
Cuttable comb busbars			
			
Number of poles	All	All	All
Catalog numbers	M9XCPC04	M9XCTC15	M9XCEC10
Number of 18 mm (0.71 in) mod.	-	-	-
Set of	4	5 x 3	10
Technical specifications			
Acceptable current at 40°C (104 °F) (Ie)	-	-	-
Resistance to short-circuit currents	Compatible with the breaking capacity of Schneider Electric modular circuit breakers	Compatible with the breaking capacity of Schneider Electric modular circuit breakers	Compatible with the breaking capacity of Schneider Electric modular circuit breakers
Voltage rating (Ue)	480Y/277 V	480Y/277 V	480Y/277 V
Insulation voltage (Ui)	1000 V AC	1000 V AC	1000 V AC
Pollution degree	3	3	3
Fire resistance	Self-extinguishability 960°C (1760 °F) 30 secondes	Self-extinguishability 960°C (1760 °F) 30 secondes	Self-extinguishability 960°C (1760 °F) 30 secondes
Colour	RAL 7035	RAL 1021	RAL 7035
Standards	UL486E	-	-

Auxiliaries and accessories

Comb busbars for C60SP



The comb busbars are used only for C60SP circuit breakers UL 1077 supplementary protection in conformity with standards:
UL 1077 / CSA C22.2 No. 235 / IEC 60947-2 / GB 14048-2.

They perform distribution and subdistribution of the electric power supply and allow rapid assembly and disassembly of equipment.

Connection accessories	Comb busbars	Accessory
	Comb busbar	Tooth cover end-piece

Function			
	<ul style="list-style-type: none"> The comb busbars make it easier to install Schneider Electric circuit breakers UL 1077 supplementary protection Power supply directly in the cage of the circuit breaker 		<ul style="list-style-type: none"> The Tooth Caps are insulated protectors which may be slipped onto the unused teeth of the comb busbar They come in strips with 1-pole spacing, but can be snapped apart to be used individually
Number of poles	1P	2P	3P
Voltage rating (Ue)	480Y/277 V AC	480Y/277 V AC	480Y/277 V AC
Catalog numbers	10285	10286	10287
Number of 18 mm (0.71 in) modules	12 (216 mm / 8.5 in)	12 (216 mm / 8.5 in)	12 (216 mm / 8.5 in)
Set of	1	1	1
			20

Technical specifications			
Insulation voltage (Ui)	690 V		-
Impulse withstand voltage (Uimp)	12 kV under 240 V 5 kV under 480Y/277 V or 277 V		-
Acceptable current at 40°C (104 °F) (Ie)	63 A with 1 central power supply point	100 A with 2 power supply points	-
	<ul style="list-style-type: none"> Power supply via cable directly in the cage of the device: □ cross section maxi: 3 AWG (25 mm²) □ cross section mini: 10 AWG (5.27 mm²) 		
Resistance to short-circuit currents	Compatible with the breaking capacity of C60SP Schneider Electric circuit breakers UL 1077 supplementary protection		
Pollution degree	3		
Fire resistance	Self-extinguishability 960°C (1760 °F) 30 secondes		
Colour	RAL 7035		RAL 1021
Standards	UL 1077		-

Dimensions (mm / inches)

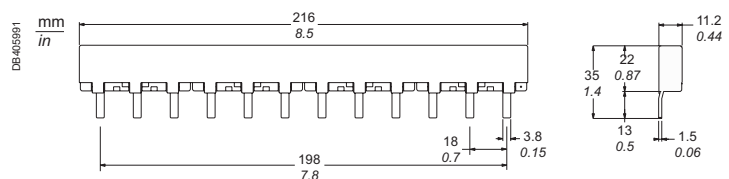

Auxiliaries and accessories



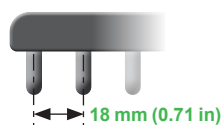

Comb busbars for C60N, C60H, C60L (18 mm / 0.71 in pitch)

IEC



IEC 60947-7-1, IEC 61439-2







C60					
18 mm (0.71 in) poles, cuttable					
Number of poles	1P	2P	3P	4P	3 (N+P)
	 L1	 L1 L2	 L1 L2 L3	 N L1 L2 L3	 N L1 NL2 NL3
Type	L1...	L1L2...	L1L2L3...	NL1L2L3...	NL1NL2NL3...
Set of	1	1	1	1	1
Catalog numbers					
6 modules of 18 mm (0.71 in)	A9XPH106	-	A9XPH306	-	-
12 modules of 18 mm (0.71 in)	A9XPH112	A9XPH212	A9XPH312	A9XPH412	A9XPH512
18 modules of 18 mm (0.71 in)	-	-	-	-	A9XPH518
24 modules of 18 mm (0.71 in)	A9XPH124	A9XPH224	A9XPH324	A9XPH424	A9XPH524
57 modules of 18 mm (0.71 in)	A9XPH157	A9XPH257	A9XPH357	A9XPH457	A9XPH557

Technical data

Operating current (Ie) at 40°C (104 °F)	100 A
Short-circuit current (Isc)	Compatible with the breaking capacity of Schneider Electric circuit breakers
Rated insulation voltage (Ui)	500 V AC
Operating voltage (Ue)	415 V AC
Pollution degree	3
Fire resistance IEC 695-2-1	Self-extinguishing at 960°C (1760 °F) 30 secondes
Color	RAL 7016 (anthracite grey)

Accessories

Number of poles	1P	2P	3P	4P	-	-
						
	End-pieces				Tooth covers	
	Lateral end-pieces providing IP20 protection				Insulate teeth that have been left free	
					Connectors	
					Monoconnect	
					Comb busbar power supply. Horizontal in-comer on each side. For 35 mm ² cable. Tightening torque 4 N.m (35.4 lb.in)	
Set of	10	10	10	10	20	4
Catalog numbers	A9XPE110	A9XPE210	A9XPE310	A9XPE410	A9XPT920	A9XPCM04

Comb busbars for C60N, C60H, C60L (18 mm / 0.71 in pitch) (cont.)



Cuttable comb busbars, 18 mm (0.71 in) modules, with 9 mm (0.35 in) auxiliary						
Aux+1P	Aux+2P	Aux+3P	Aux+4P	3 (Aux+1P)	3 (Aux+N+1P)	
AuxL1...	AuxL1L2...	AuxL1L2L3...	AuxNL1L2L3...	AuxL1AuxL2AuxL3...	AuxL1AuxL2AuxL3...	
1	1	1	1	1	1	
-	-	-	-	-	-	
-	-	-	-	-	-	
-	-	-	-	-	-	
-	-	-	-	-	-	
A9XAH157	A9XAH257	A9XAH357	A9XAH457	A9XAH657	A9XAH557	

Auxiliaries and accessories

Comb busbars for N40N, N40 Vigi (9 mm / 0.35 in pitch)

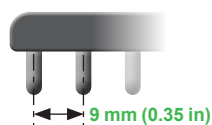
IEC
IEC 60439-1

N40N, N40 Vigi		9 mm (0.35 in) poles, cuttable							
Number of poles	1P + N				3P + N				
		 N L				 N L1 N L2 N L3			
Number of 18 mm (0.71 in) modules	12	18	24	48	12	18	24	48	
Supplied accessories									
Tooth covers (for 3 modules of 18 mm / 0.71 in)	1	1	2	-	1	1	2	-	
End-pieces	4	4	4	-	4	4	4	-	
Catalog numbers	21501	19512	21503	21089	21505	19516	21507	21093	

Technical data

Operating current at 40°C (104 °F)	(Ie)	80 A
Short-circuit current	(Isc)	Compatible with the breaking capacity of Schneider Electric circuit breakers
Rated insulation voltage	(Ui)	440 V AC
Operating voltage	(Ue)	230 V AC (P + N) - 400 V AC (3P + N)
Degree of protection		IP20
Pollution degree		3
Fire resistance IEC 695-2-1		Self-extinguishing at 960°C (1760 °F) 30 secondes
Color		RAL 7035

Accessories

Number of poles	1P + N		3P + N		Connectors (grey)
	End-pieces		Tooth covers (3 x 18 mm / 3 x 0.71 in modules)	Tooth covers (1 x 18 mm / 1 x 0.71 in module)	
Set of	40		12	10	4
Catalog numbers	021094	021095	021096	010405	021098

Comb busbars for N40N, N40 Vigi (9 mm / 0.35 in pitch) (cont.)

IEC

IEC 60439-1

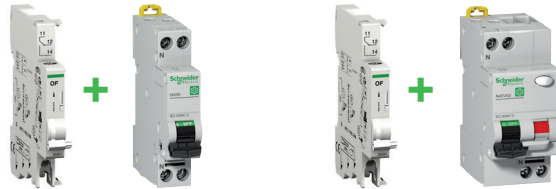
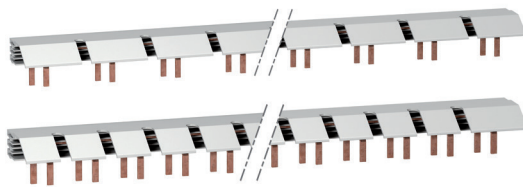
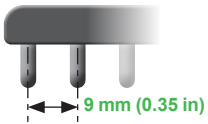

Comb busbar for 1P+N circuit breaker with 9 mm (0.35 in) auxiliary OF, SD

N40N, N40 Vigi		9 mm (0.35 in) poles, cuttable			
Number of poles	Aux., N, L	Aux. NL1, Aux. NL2, Aux. NL3	Aux., N, L1	Aux. NL1, Aux. NL2, Aux. NL3	
			18 mm (0.71 in)	18 mm (0.71 in) 18 mm (0.71 in)	
Number of 18 mm (0.71 in) modules	N40N comb busbar		N40 Vigi comb busbar		
Catalog numbers	A9N21035	A9N21036	A9N21037	A9N21038	

Technical data

Operating current at 40°C (104 °F) (Ie)	63 A
Short-circuit current (Isc)	Compatible with the breaking capacity of Schneider Electric circuit breakers
Rated insulation voltage (Ui)	500 V AC
Operating voltage (Ue)	230 V AC (P + N) - 400 V AC (3P + N)
Degree of protection	IP20
Pollution degree	3
Fire resistance IEC 695-2-1	Self-extinguishing at 960°C (1760 °F) 30 secondes
Color	RAL 7035

4

Accessories

Number of poles	Aux., N, L	Aux. NL1, Aux. NL2, Aux. NL3			
	End-pieces	Connectors (grey)	Neutral connectors (bleu)	Tooth covers (1 x 18 mm / 1 x 0.71 in module)	
Set of	20	10	10	10	
Catalog numbers	A9N21039	A9N21040	A9N21041	A9N21042	A9N21050

Linergy DS screw distribution blocks



IEC/EN 60947-7-1, IEC/EN 61439-1 & 2

As per the above standards:

Description

- Single-pole or four-pole distribution block that can be installed on a standard DIN rail or on a mounting plate.
- Compatible with Prisma G and P, Pragma, Mini Pragma and Resbo series switchboards.
- Incomers and feeders are connected to screw terminals that accept rigid or flexible cables with ferrule.
- Optional: additional neutral terminal strip for four-pole distribution block.

Advantages

- Simplified power supply for main incomers.
- Easy phase balancing.
- Easy, effortless cabling due to excellent accessibility.
- Visible cabling.
- Insulation between phases.
- The single-pole distribution blocks are adjacent and bridgeable via the second incoming hole for parallel connection.

Screw distribution blocks

Number of poles	1P			4P
				
Rated operational current	125 A	160 A	250 A	100 A
Total connections capacity	10	13	14	4 x 7
Terminal capacity				
Diameter	2 x Ø 9.5 mm (0.37 in)	2 x Ø 12 mm (0.47 in)	1 x Ø 15.3 mm	2 x Ø 7.5 mm (0.29 in)
	2 x Ø 7.5 mm (0.29 in)	3 x Ø 7.5 mm (0.29 in)	1 x Ø 10 mm (0.39 in)	5 x Ø 5.5 mm (0.22 in)
	6 x Ø 5.8 mm (0.23 in)	8 x Ø 5.8 mm (0.23 in)	4 x Ø 6 mm (0.24 in)	-
	-	-	8 x Ø 7.5 mm (0.29 in)	-
Rated peak withstand current (I _{pk})	I _{pk} /60 ms: 25 kÅ	36 kÅ	60 kÅ	14 kÅ
	I _{pk} /6 ms: -	-	-	24 kÅ
Rated short-time withstand current (I _{cw}) (IEC/EN 60947-7-1)	4.2 kA rms/1 s	8.4 kA rms/1 s	14.4 kA rms/1 s	3 kA rms/1 s
Width (nb of 9 mm / 0.35 in pitches)	3	4	5	8
Dimension (H x W x D)	85 x 27 x 50.5 mm 3.35 x 1.06 x 1.99 in	85 x 36 x 50.5 mm 3.35 x 1.42 x 1.99 in	85 x 45 x 50.5 mm 3.35 x 1.77 x 1.99 in	100 x 71 x 50.5 mm 3.94 x 2.79 x 1.99 in
Weight	125 g (4.41 oz)	163 g (5.75 oz)	239 g (8.43 oz)	210 g (7.41 oz)
Neutral terminal strip (optional)	-	-	-	LGYN1007
References	LGY112510	LGY116013	LGY125014	LGY410028

Linergy DS screw distribution blocks (cont.)

DB406005_1.eps



On LGY412560 and LGY416048 references.
Input cabling facilitated by side terminals.

Technical data





Common characteristics

To IEC/EN 60947-7-1 and IEC/EN 61439-1 & 2

Rated insulation voltage (Ui)	500 V AC
Rated operational voltage (Ue)	230 V AC (Ph/N) 440 V AC (Ph/Ph)
Rated impulse withstand voltage (Uimp)	8 kV
Rated conditional short-circuit current of an assembly	Up to the breaking capacity of Schneider Electric feeder circuit breakers, even in cascading configuration
Network frequency	50/60 Hz
Pollution degree	3
Overtoltage category	III

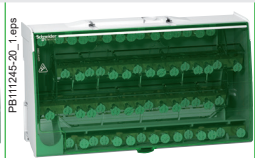
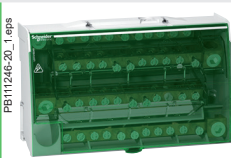
Additional technical characteristics

Reference temperature	40 °C (104 °F)
Operating temperature	-25 °C to 55 °C (-13 °F to 131 °F)
Dielectric withstand (IEC/EN 60947-1)	2500 V AC

			Neutral terminal strip		
					
125 A	160 A	160 A	100 A	125 A	15
4 x 12	4 x 15	4 x 12	7	12	15
1 x Ø 9 mm (0.35 in)	1 x Ø 9.5 mm (0.37 in)	1 x Ø 12 mm (0.47 in)	2 x Ø 7.5 mm (0.29 in)	1 x Ø 9 mm (0.35 in)	1 x Ø 9.5 mm (0.37 in)
7 x Ø 7.5 mm (0.29 in)	3 x Ø 8.5 mm (0.33 in)	3 x Ø 9 mm (0.35 in)	5 x Ø 5.5 mm (0.22 in)	7 x Ø 7.5 mm (0.29 in)	3 x Ø 8.5 mm (0.33 in)
4 x Ø 6.5 mm (0.26 in)	11 x Ø 6.5 mm (0.26 in)	8 x Ø 7.5 mm (0.29 in)	-	4 x Ø 6.5 mm (0.26 in)	11 x Ø 6.5 mm (0.26 in)
-	-	-	-	-	-
18 kA	18 kA	22 kA	-	-	-
26 kA	28 kA	36 kA	-	-	-
4.2 kA rms/1 s	4.2 kA rms/1 s	8.4 kA rms/1 s	-	-	-
14	20	18	7	14	17
100 x 126 x 50.5 mm 3.94 x 4.96 x 1.99 in	100 x 162 x 50.5 mm 3.94 x 6.38 x 1.99 in	100 x 174 x 50.5 mm 3.94 x 6.85 x 1.99 in	20 x 70 x 35 mm 0.79 x 2.76 x 1.38 in	20 x 125 x 35 mm 0.79 x 4.92 x 1.38 in	20 x 155 x 35 mm 0.79 x 6.1 x 1.38 in
390 g (13.76 oz)	559 g (19.72 oz)	567 g (20 oz)	63 g (2.22 oz)	111 g (3.91 oz)	149 g (5.26 oz)
LGYN12512	LGYN12515	LGYN12512	-	-	-
LGY412548	LGY412560	LGY416048	LGYN1007	LGYN12512	LGYN12515

4

Linergy DS screw distribution blocks (cont.)

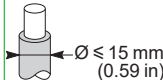
Terminal technical data								
Type	PZ2 screw							
Diameter	Ø 5.5 mm (0.22 in)	Ø 5.8 mm (0.23 in)	Ø 6 mm (0.24 in)	Ø 6.5 mm (0.26 in)	Ø 7.5 mm (0.3 in)	Ø 8.5 mm (0.33 in)	Ø 9 mm (0.35 in)	Ø 9.5 mm (0.37 in)
Section rigid cable	1.5 to 16 mm ² (AWG #16 to AWG #6)	1.5 to 16 mm ² (AWG #16 to AWG #6)	1.5 to 16 mm ² (AWG #16 to AWG #6)	1.5 to 16 mm ² (AWG #16 to AWG #6)	2.5 to 25 mm ² (AWG #14 to AWG #4)	6 to 35 mm ² (AWG #10 to AWG #2)	10 to 35 mm ² (AWG #8 to AWG #2)	10 to 35 mm ² (AWG #8 to AWG #2)
Section flexible cable or with ferrule	1.5 to 10 mm ² (AWG #16 to AWG #8)	1.5 to 10 mm ² (AWG #16 to AWG #8)	1.5 to 10 mm ² (AWG #16 to AWG #8)	1.5 to 10 mm ² (AWG #16 to AWG #8)	1.5 to 16 mm ² (AWG #16 to AWG #6)	4 to 25 mm ² (AWG #12 to AWG #4)	4 to 25 mm ² (AWG #12 to AWG #4)	6 to 35 mm ² (AWG #10 to AWG #2)
Tightening torque	2 N.m (18 lb.in)	2 N.m (18 lb.in)	2 N.m (18 lb.in)	2 N.m (18 lb.in)	2 N.m (18 lb.in)	2 N.m (18 lb.in)	2.5 N.m (22 lb.in)	2.5 N.m (22 lb.in)
Type	Hc screw							
Diameter	Ø 9.5 mm (0.37 in)	Ø 10 mm (0.39 in)	Ø 12 mm (0.47 in)	Ø 15.3 mm (0.6 in)				
Section rigid cable	10 to 35 mm ² (AWG #8 to AWG #2)	1.5 to 50 mm ² (AWG #16 to AWG #1)	25 to 70 mm ² (AWG #4 to AWG #2/0)			35 to 120 mm ² (AWG #2 to AWG #4/0)		
Section flexible cable or with ferrule	6 to 35 mm ² (AWG #10 to AWG #2)	1.5 to 35 mm ² (AWG #16 to AWG #2)	16 to 50 mm ² (AWG #6 to AWG #1)			25 to 95 mm ² (AWG #4 to AWG #3/0)		
Tightening torque	8 N.m (71 lb.in)	4 N.m (35 lb.in)	1P: 9 N.m (80 lb.in)	4P: 5 N.m (44 lb.in)	14 N.m (124 lb.in)			

Dimensions (mm / inches)

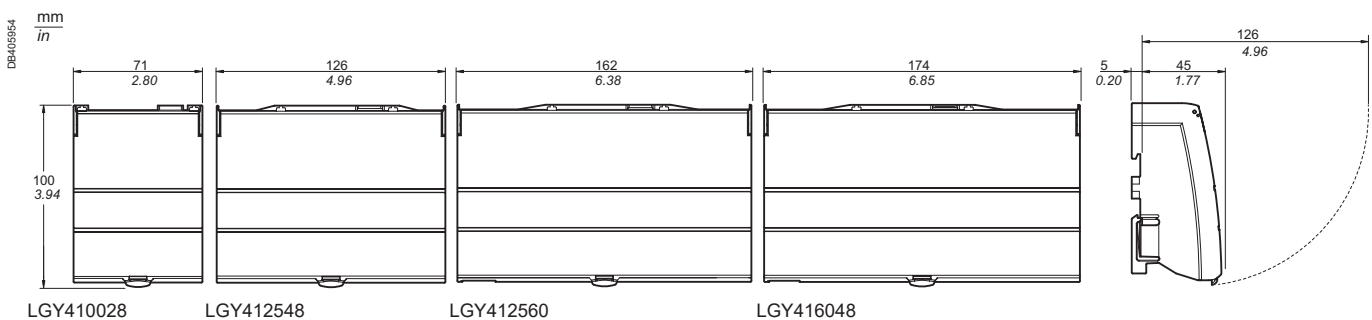
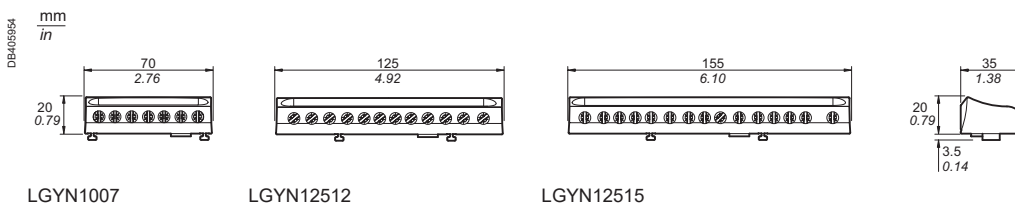
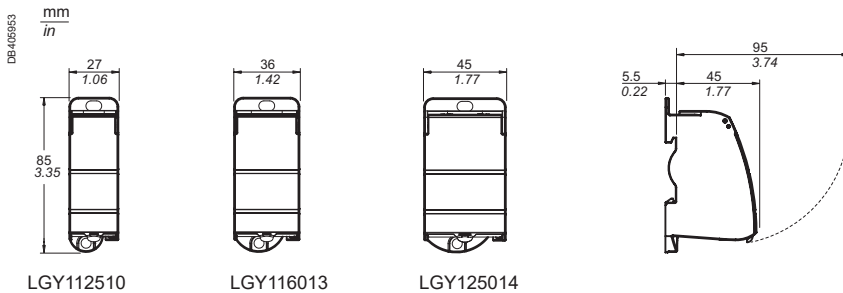



The setup of circuit protective devices depends on the electrical installation standard. Multi9 devices (designed for machinery and equipment manufacturers, integrators, panelbuilders, etc.) are tested in accordance with the UL (Underwriter Laboratories) product standard in order to meet the requirements of the NEC (National Electric Code) installation standard, in force in the United States. To allow the most extensive possible use worldwide, Multi9 “UL” products are also tested to ensure compliance with IEC and CSA standards.

The CE Marking is an administrative formality for free circulation and sale on the territory of the European Union.

Made compulsory by a European directive, the CE Marking of products complies with the administrative and legal requirements. Designed for the European supervisory authorities (customs authorities), the “CE Marking” declarations and dossiers are produced under the sole responsibility of the manufacturer and undergo no conformity check by a third-party organization. Only the quality marks, issued and inspected by an independent third-party organization, provide a full guarantee of operation, compatibility and safety in accordance with national and international standards.



UL 489

Branch circuit protection

The UL 489 standard applies primarily to the protection of circuits installed, in accordance with the NEC (National Electric Code):

- upstream of a device or a machine (branch circuit protection)
- inside the device or a machine, for certain loads (ventilation, air conditioning, heating, etc.)
- to power loads external to the device (motors, power sockets, etc.).



UL 1077

Supplementary protection - Internal protection of electrical equipment

The UL 1077 standard applies to circuit breakers for electrical equipment, in accordance with the NEC. These circuit breakers are considered as components forming part of the equipment but can in no case replace a UL 489 protective device. Their use is limited to the protection of specific loads exclusively inside the machine or equipment. Where the machine or equipment is powered upstream by a control panel, the UL 1077 protection must be combined with a UL 489 protective device in that panel.



CSA C22.2 No. 5-02

Branch circuit protection

The requirements of this standard cover circuit breakers that are specifically intended to provide service entrance, feeder and branch circuit protection in accordance with the National Installation Codes.

This standard is close to UL489.



CSA C22.2 No. 235-04

Supplementary protection - Internal protection of electrical equipment

This Standard applies to supplementary protectors that are intended for use as components within appliances or other electrical equipment where branch-circuit protection is already provided (or is not required), in accordance with the Rules of the Canadian Electrical Code.

This standard is close to UL1077.

IEC 60947-2

The IEC 60947-2 standard is an international product standard concerning circuit breakers; it is used for industrial circuit protection applications. It meets the requirements of the IEC 60364 installation standard.



GB 14048-2

The GB 14048-2 standard is close to the IEC 60947-2 standard for installations on Chinese territory.

The standards and their applications

Example of use of UL 489 circuit breakers and UL 1077 electrical equipment internal protective devices

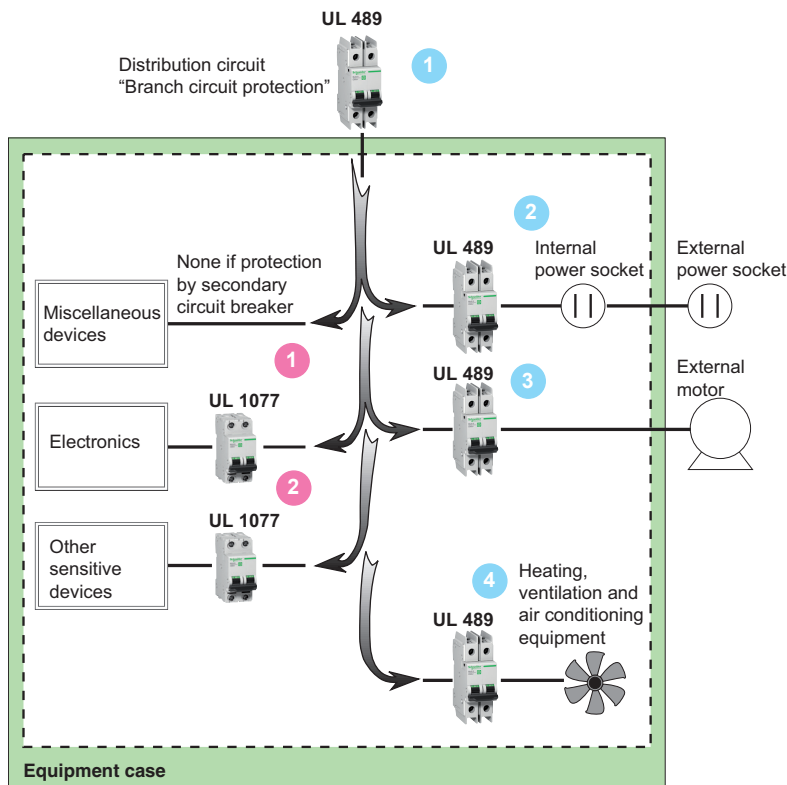

UL 1077

Applications allowing the use of electrical equipment internal protective devices

UL 1077 1

Supplements an existing protective device or provides additional protection inside equipment

UL 1077 2

Used for the protection of internal circuits such as:

- Computers and microprocessors
- Telecommunications equipment
- Electronic controllers
- Power supply sources
- Transformers
- Small motors.

UL 489

Applications requiring branch circuit protection

UL 489 1

Equipment incoming end protection.

UL 489 2

Power socket circuit protection (internal or external).

UL 489 3

Protection of an external circuit (e.g. motor).

UL 489 4

Protection of heating, ventilation and air conditioning equipment (HACR/HVAC).

Circuit breakers tripping curves

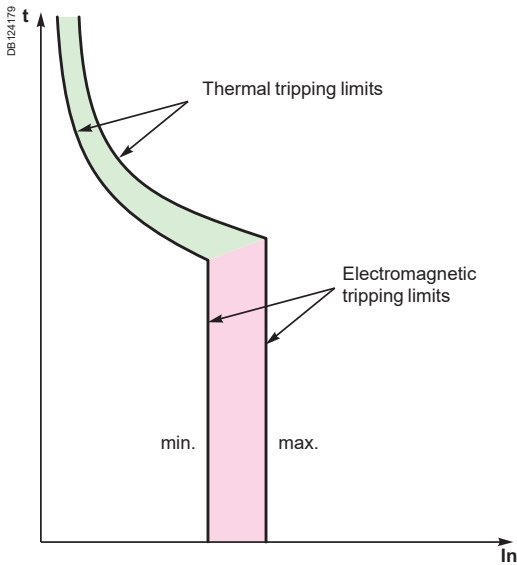

The following curves show the total fault current breaking time, depending on its amperage. For example: based on the curve on "Circuit breakers tripping curves", page 96, a C60 circuit breaker of curve C, 20 A rating, will interrupt a current of 100 A (5 times the rated current I_n) in:

- 1 second at least
- 7 seconds at most.

The circuit breakers' tripping curves consist of two parts:

- tripping of overload protection (thermal tripping device): the higher the current, the shorter the tripping time
- tripping of short-circuit protection (magnetic tripping device): if the current exceeds the threshold of this protection device, the breaking time is less than 10 milliseconds. For short-circuit currents exceeding 20 times the rated current, the time-current curves do not give a sufficiently precise representation. The breaking of high short-circuit currents is characterized by the current limiting curves, in peak current and in energy. The total breaking time can be estimated at 5 times the value of the ratio $(I^2t)/(I^2)$.

Verification of the discrimination between two circuit breakers

By superimposing the curve of a circuit breaker on that of the circuit breaker installed upstream, one can check whether this combination will be discriminating in cases of overload (discrimination for all current values, up to the magnetic threshold of the upstream circuit breaker). This verification is useful when one of the two circuit breakers has adjustable thresholds; for fixed-threshold devices, this information is provided directly by the discrimination tables.

To check discrimination on short circuit, the energy characteristics of the two devices must be compared.

Alternative current 50/60 Hz

C60BP, C60BPR, C60SP

According to IEC/EN 60947-2 (reference temperature 25°C)

Curves Z, B, C, D

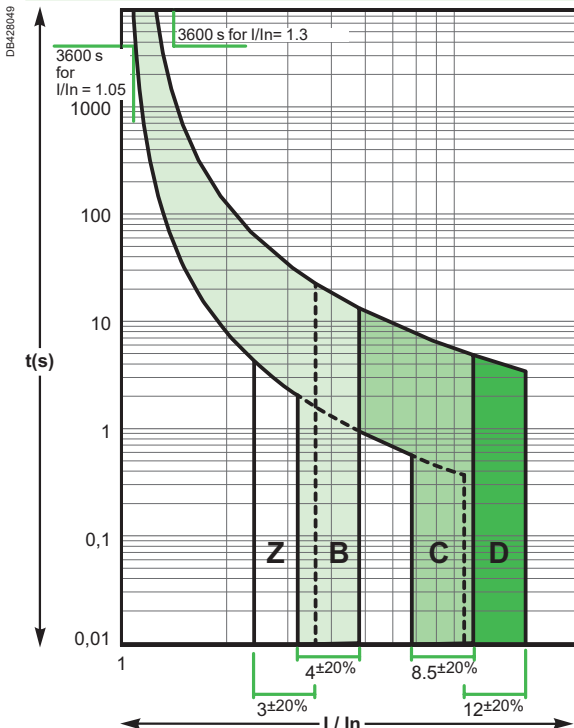

C60N, C60H, C60L, C60CTRL

According to IEC/EN 60947-2 (reference temperature 50°C)

Curves Z, B, C, D

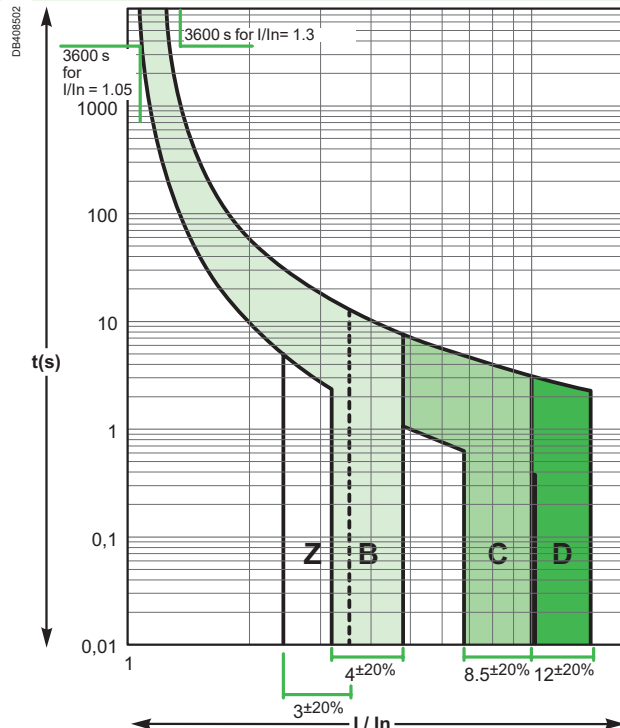

Note: IEC/EN 60947-2 tripping curves, respecting the tripping time specified by the standards UL 489, CSA C22.2 No 5, UL 1077 and CSA C22.2 No 235

Circuit breakers tripping curves (cont.)

Direct current

C60BP, C60BPR, C60SP

According to IEC/EN 60947-2 (reference temperature 25°C)

Curves Z, B, C, D

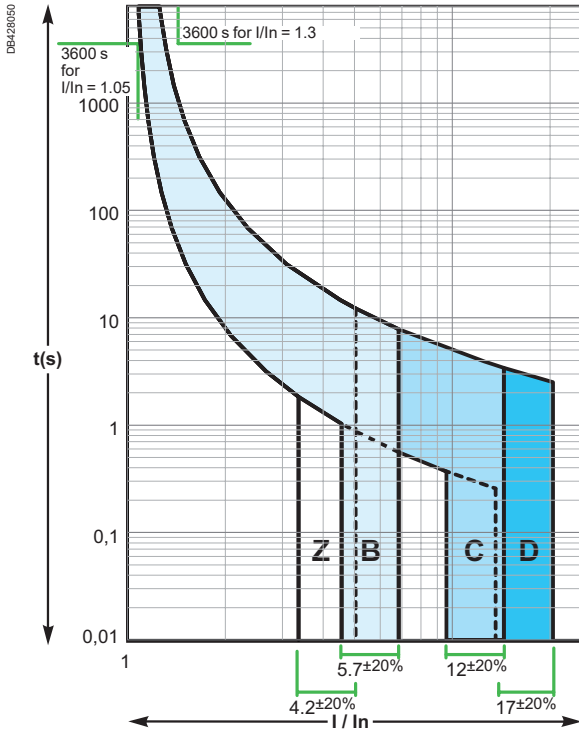

C60N, C60H, C60L, C60CTRL

According to IEC/EN 60947-2 (reference temperature 50°C)

Curves Z, B, C, D

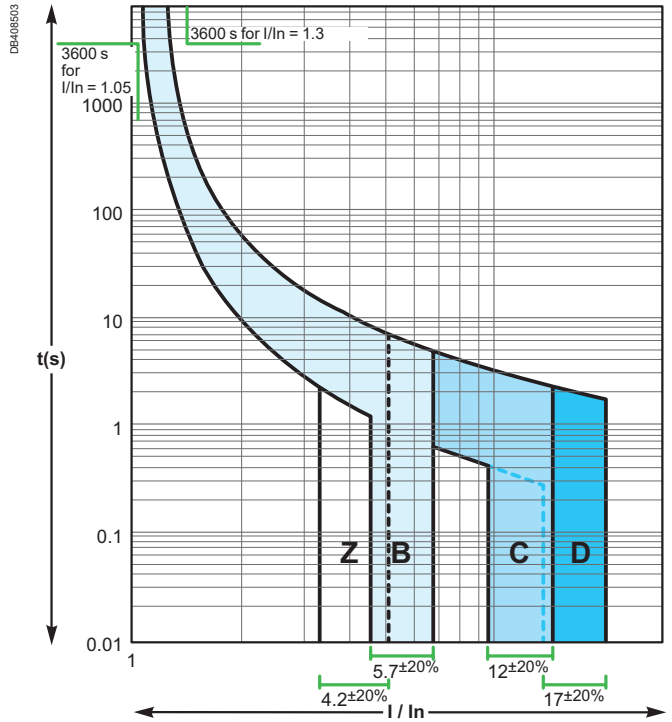

Note: IEC/EN 60947-2 tripping curves, respecting the tripping time specified by the standards UL 489, CSA C22.2 No 5, UL 1077 and CSA C22.2 No 235

C60H-DC

According to IEC/EN 60947-2 (reference temperature 25°C)

Curves B, C, K

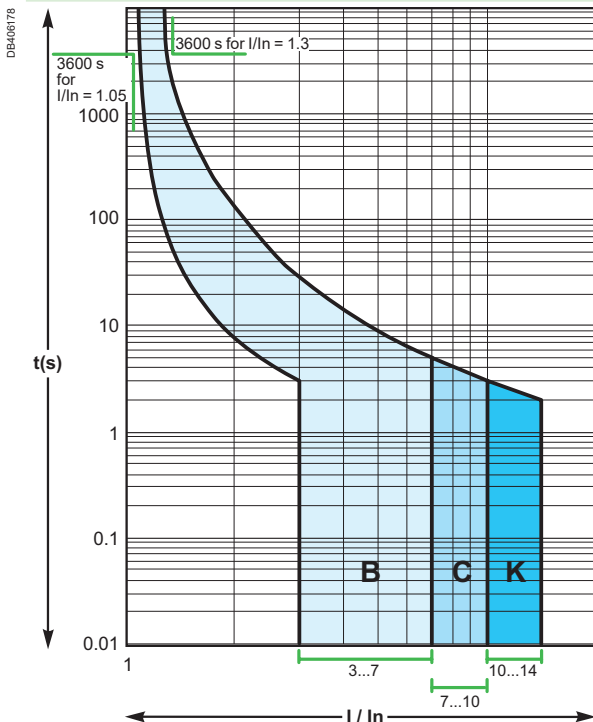

Note: IEC/EN 60947-2 tripping curves, respecting the tripping time specified by the standards UL 1077 and CSA C22.2 No 235

Circuit breakers tripping curves (cont.)

The circuit-breaker characteristics chosen depend on the type of load downstream of the installation.
 The rating depends on the size of the cables to be protected and the curves depend on the load inrush current.

Product selection according to the load inrush current

When certain "capacitive" loads are switched on, very high inrush currents appear during the first milliseconds of operation. The following graphs show the average non-tripping curves of our products for this time range (50 μs to 10 ms).

C60N, C60H, C60L, C60CTRL

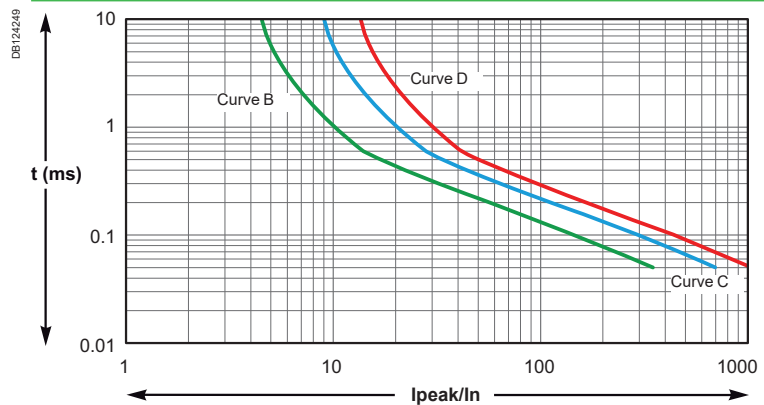

C60H-DC

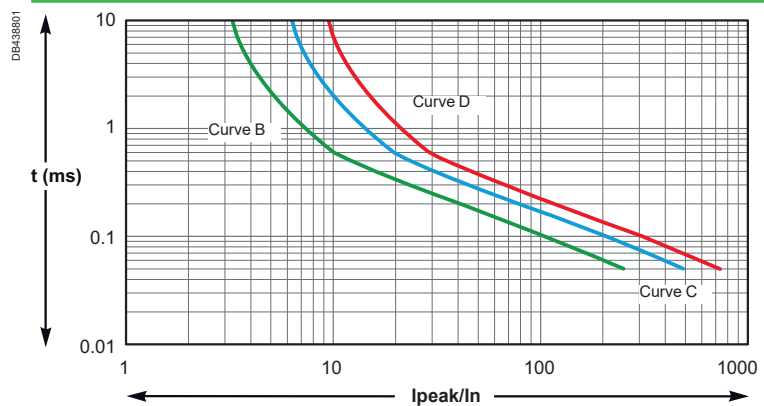

This information allows us to select the most appropriate product, according to the load specifications: curve and rating.

Example

When an C60 is used with a load with current peaks in the order of 200 In during the first 0.1 millisecond, a curve C or D product must be installed.

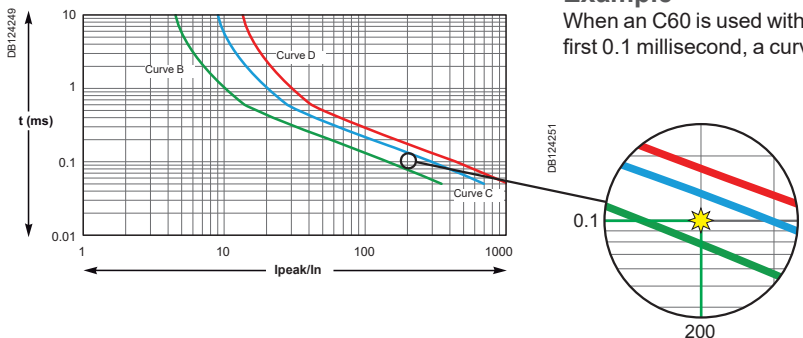

Miniature Circuit Breakers for DC applications up to 380 V DC

This application sheet is intended to provide guidance for selecting the best protection and control components for a given DC system. The scope is DC system supplied by rectifier (AC/DC or DC/DC converter) and/or battery, isolated or connected to earth. The application voltages are 24 V DC, 48 V DC, 110 V DC and 220 V DC.

A. Circuit breaker selection for 24/48 V DC according to the method of earthing

Refer to Tables A of Application Guide CA908061E.

C60BP / C60BPR / C60SP and C60N/H/L circuit breakers follow the wiring rules of iC60N/H/L circuit breakers.

Multi9 C60H-DC circuit breakers follow the wiring rules of Acti9 C60H-DC circuit breakers.

The breaking capacities of these products are available in catalog pages.

B. Circuit breaker selection for 110 V DC according to the method of earthing

Refer to Tables B of Application Guide CA908061E.

Multi9 C60H-DC circuit breakers follow the rules of Acti9 C60H-DC circuit breakers.

Ue = 110 V DC					
Method of earthing	IT	TN	TN	TN	TN
	Isolated from earth + and - conductors protected and disconnected	- (or +) earthed + and - conductors protected and disconnected	Midpoint earthed (not distributed) + and - conductors protected and disconnected	- (or +) earthed + (or -) conductor protected and disconnected	
Breaking capacity Isc ≤ 10 kA (UL Standard)	Rating In ≤ 25 A	 C60SP 4P	 C60BP, C60BPR, C60SP 3P	 C60BP, C60BPR, C60SP 2P <i>Two-pole (1)</i>	 C60BP, C60BPR, C60SP 2P
Isc ≤ 20 kA	In ≤ 63 A	 C60N/H/L 4P	 C60N/H/L 3P	 C60N/H/L 2P <i>Two-pole (1)</i>	 C60N/H/L 2P
Isc ≤ 25 kA	In ≤ 40 A	 C60H/L 4P	 C60H/L 3P	 C60H/L 2P <i>Two-pole (1)</i>	 C60H/L 2P
Isc ≤ 30kA	In ≤ 25 A	 C60L 4P	 C60L 3P	 C60L 2P <i>Two-pole (1)</i>	 C60L 2P

Note: This table is applicable for 125 V DC floating battery voltage.

C. Circuit breaker selection 220 - 380 V DC according to the method of earthing

Refer to Tables C of Application Guide CA908061E.

Multi9 C60H-DC circuit breakers follow the rules of Acti9 C60H-DC circuit breakers.

Influence of ambient temperature

Influence of temperature on the operation

Devices	Characteristics influenced by temperature	Temperature	
		Mini	Maxi
C60BP, C60BPR, C60SP, C60N, C60H, C60L, C60CTRL circuit breakers	Tripping on overload	-30°C	+70°C
N40N circuit breakers	Tripping on overload	-25°C	+70°C
C60H-DC circuit breakers	Tripping on overload	-25°C	+70°C
Circuit breakers with	Vigi AC Type	-5°C	+60°C
	Vigi A-SI Type	-25°C	+60°C
N40 Vigi	Tripping on overload	-5°C	+60°C
GFP A-SI Type	Maximum operating current	-25°C	+60°C
RCCB-ID 125 A	Maximum operating current	-25°C	+40°C
iID B-SI type	Maximum operating current	-25°C	+60°C

Note: the temperature considered is the temperature viewed through the device.

Circuit breakers

High temperatures

- A rise in temperature decreases the tripping current of the thermal protection.
- Protection is still ensured: the tripping threshold remains lower than the current acceptable by the cable (I_2)
- To prevent nuisance tripping, it should be checked that this threshold remains higher than the maximum operating current (I_B) of the circuit, defined by:
 - the rated load currents,
 - the coefficients of expansion and simultaneity of use.

If the temperature is sufficiently high for the tripping threshold to become lower than the operating current I_B , switchboard ventilation should be provided for.

Low temperatures

- A fall in temperature increases the tripping current of the thermal protection.
- There is no risk of nuisance tripping: the threshold remains higher than the maximum operating current of the circuit (I_B) demanded by the loads.
- It should be checked that the cable remains suitably protected, i.e. that its acceptable current (I_2) is higher than the values shown in the following tables (in amperes).

When the ambient temperature could vary within a broad range, both these aspects must be taken into account:

- the difference between the maximum operating current of the circuit (I_B) and the tripping threshold of the circuit breaker for the minimum ambient temperature,
- the difference between the strength of the cable (I_2) and the maximum tripping threshold of the circuit breaker for the maximum ambient temperature.

Influence of ambient temperature (cont.)

Maximum permissible current

- The maximum current allowed to flow through the device depends on the ambient temperature in which it is placed.
- The ambient temperature is the temperature inside the enclosure or switchboard in which the devices are installed.
- The reference temperature is in a halftone colour for the different devices.
- When several devices operating simultaneously are mounted side by side in a small enclosure, a temperature rise in the enclosure results in a reduction in the operating current. A reduction coefficient of 0.8 will then have to be assigned to the rating (already derated, if applicable, depending on the ambient temperature).

■ Example:

Depending on the ambient temperature and the method of installation, the table below shows how to determine, for a C60, the operating currents not to be exceeded for ratings 25 A, 32 A and 40 A (reference temperature 50°C).

Operating current not to be exceeded (A)							
Installation conditions (IEC 60947-2)		C60 alone			Several C60 in the same enclosure (calculate with the reduction coefficient indicated below)		
Ambient temperature (°C)		35 °C	50 °C	65 °C	35 °C	50 °C	65 °C
Type	Nominal rating (A)	Actual rating (A)					
C60	25	26.7	25	23.2	26.7 x 0.8 = 21.4	25 x 0.8 = 20	23.2 x 0.8 = 18.6
	32	34	32	29.9	34 x 0.8 = 27	32 x 0.8 = 25.6	29.9 x 0.8 = 24
	40	42.9	40	36.9	42.9 x 0.8 = 34.3	40 x 0.8 = 32	36.9 x 0.8 = 29.5

Influence of ambient temperature (cont.)

C60BP, C60BPR, C60SP derating table

C60BP, C60BPR, C60SP	Ambient temperature (°C)																			
	Rating	-30	-25	-20	-15	-10	-5	0	+5	+10	+15	+20	+25	+30	+35	+40	+45	+50	+55	+60
0.5A	0.6	0.6	0.6	0.6	0.6	0.6	0.6	0.5	0.5	0.5	0.5	0.5	0.5	0.5	0.5	0.5	0.4	0.4	0.4	0.4
1A	1.4	1.3	1.3	1.3	1.2	1.2	1.2	1.1	1.1	1.1	1.0	1.0	1.0	0.9	0.9	0.8	0.8	0.7	0.7	0.6
2A	2.5	2.5	2.4	2.4	2.3	2.3	2.3	2.2	2.2	2.1	2.1	2.0	1.9	1.9	1.8	1.8	1.7	1.6	1.6	1.4
3A	3.7	3.7	3.6	3.6	3.5	3.4	3.4	3.3	3.2	3.1	3.1	3.0	2.9	2.8	2.8	2.7	2.6	2.5	2.4	2.2
4A	5.0	4.9	4.8	4.8	4.7	4.6	4.5	4.4	4.3	4.2	4.1	4.0	3.9	3.8	3.7	3.6	3.4	3.3	3.2	2.9
5A	6.2	6.1	6.0	5.9	5.8	5.7	5.6	5.5	5.4	5.2	5.1	5.0	4.9	4.8	4.6	4.5	4.3	4.2	4.1	3.7
6A	7.8	7.6	7.5	7.3	7.2	7.0	6.9	6.7	6.5	6.4	6.2	6.0	5.8	5.6	5.4	5.2	5.0	4.8	4.5	4.0
8A	9.9	9.8	9.6	9.5	9.3	9.1	8.9	8.8	8.6	8.4	8.2	8.0	7.8	7.6	7.4	7.2	6.9	6.7	6.5	6.0
10A	12.4	12.2	12.0	11.8	11.6	11.4	11.2	10.9	10.7	10.5	10.2	10.0	9.7	9.5	9.2	9.0	8.7	8.4	8.1	7.4
13A	15.6	15.4	15.2	15.0	14.7	14.5	14.3	14.0	13.8	13.5	13.3	13.0	12.7	12.5	12.2	11.9	11.6	11.3	11.0	10.4
15A	18.1	17.8	17.6	17.3	17.0	16.7	16.5	16.2	15.9	15.6	15.3	15.0	14.7	14.4	14.0	13.7	13.4	13.0	12.7	11.9
16A	18.9	18.6	18.4	18.1	17.9	17.6	17.4	17.1	16.8	16.6	16.3	16.0	15.7	15.4	15.1	14.8	14.5	14.2	13.9	13.2
20A	24.6	24.3	23.9	23.5	23.1	22.7	22.2	21.8	21.4	20.9	20.5	20.0	19.5	19.0	18.5	18.0	17.5	16.9	16.4	15.2
25A	30.1	29.7	29.3	28.8	28.4	27.9	27.5	27.0	26.5	26.0	25.5	25.0	24.5	23.9	23.4	22.8	22.3	21.7	21.1	19.8
30A	38.2	37.6	36.9	36.2	35.5	34.7	34.0	33.2	32.5	31.7	30.8	30.0	29.1	28.2	27.3	26.4	25.4	24.4	23.3	21.0
32A	40.2	39.5	38.8	38.1	37.4	36.7	36.0	35.2	34.4	33.6	32.8	32.0	31.1	30.3	29.4	28.4	27.5	26.5	25.4	23.2
35A	42.5	41.9	41.2	40.6	39.9	39.3	38.6	37.9	37.2	36.5	35.7	35.0	34.2	33.5	32.7	31.8	31.0	30.1	29.2	27.4
40A	48.9	48.1	47.4	46.6	45.9	45.1	44.3	43.4	42.6	41.8	40.9	40.0	39.1	38.2	37.2	36.2	35.2	34.2	33.1	30.9
45A	54.7	53.9	53.1	52.2	51.4	50.5	49.7	48.8	47.8	46.9	46.0	45.0	44.0	43.0	42.0	40.9	39.8	38.7	37.5	35.1
50A	59.8	59.0	58.2	57.3	56.5	55.6	54.7	53.8	52.9	51.9	51.0	50.0	49.0	48.0	47.0	45.9	44.8	43.7	42.6	40.2
63A	80.0	78.6	77.2	75.7	74.2	72.7	71.2	69.6	68.0	66.4	64.7	63.0	61.2	59.4	57.5	55.6	53.5	51.4	49.2	44.5

C60N, C60H, C60L, C60CTRL derating table

C60N, C60H, C60L, C60CTRL	Ambient temperature (°C)																				
	Rating	-30	-25	-20	-15	-10	-5	0	+5	+10	+15	+20	+25	+30	+35	+40	+45	+50	+55	+60	+65
1A	1.31	1.3	1.28	1.27	1.25	1.23	1.21	1.19	1.17	1.15	1.13	1.11	1.09	1.07	1.05	1.02	1	0.98	0.95	0.93	0.91
2A	2.55	2.59	2.56	2.52	2.49	2.45	2.41	2.37	2.34	2.3	2.26	2.22	2.17	2.13	2.09	2.04	2	1.95	1.91	1.88	1.84
3A	3.81	4.04	3.98	3.92	3.85	3.79	3.73	3.66	3.59	3.52	3.45	3.38	3.31	3.23	3.16	3.08	3	2.92	2.83	2.82	2.76
4A	4.9	4.86	4.81	4.76	4.7	4.65	4.59	4.54	4.48	4.42	4.37	4.31	4.25	4.19	4.13	4.06	4	3.94	3.87	3.81	3.74
6A	7.93	7.82	7.71	7.6	7.49	7.38	7.27	7.15	7.03	6.91	6.79	6.66	6.54	6.41	6.27	6.14	6	5.86	5.71	5.56	5.42
10A	13.3	13.2	13	12.8	12.6	12.4	12.2	12	11.8	11.6	11.4	11.2	10.9	10.7	10.5	10.2	10	9.8	9.5	9.2	9
13A	17	16.9	16.6	16.4	16.2	15.9	15.7	15.4	15.2	14.9	14.7	14.4	14.1	13.9	13.6	13.3	13	12.7	12.4	12.1	11.8
16A	20	19.8	19.5	19.3	19.1	18.8	18.6	18.4	18.1	17.9	17.6	17.3	17.1	16.8	16.6	16.3	16	15.7	15.4	15.1	14.8
20A	26.9	26.6	26.2	25.8	25.4	25	24.6	24.2	23.7	23.3	22.9	22.4	22	21.5	21	20.5	20	19.5	18.9	18.4	17.9
25A	32.9	32.5	32.1	31.6	31.1	30.7	30.2	29.7	29.2	28.7	28.2	27.7	27.2	26.7	26.1	25.6	25	24.4	23.8	23.2	22.6
32A	41.5	41.1	40.5	40	39.4	38.9	38.3	37.7	37.1	36.5	35.9	35.3	34.7	34	33.4	32.7	32	31.3	30.6	29.9	29.1
40A	53.7	52.9	52.2	51.4	50.6	49.8	49	48.2	47.3	46.5	45.6	44.7	43.8	42.9	42	41	40	39	37.9	36.9	35.8
50A	65	64.3	63.5	62.6	61.7	60.8	59.9	59	58.1	57.1	56.2	55.2	54.2	53.2	52.1	51.1	50	48.9	47.8	46.7	45.5
63A	85.5	84.6	83.3	82	80.7	79.4	78	76.7	75.3	73.9	72.4	70.9	69.4	67.9	66.3	64.7	63	61.3	59.5	57.8	56

Influence of ambient temperature (cont.)

N40N, N40 vigi derating table

N40N, N40 Vigi	Ambient temperature (°C)																			
	-25	-20	-15	-10	-5	0	+5	+10	+15	+20	+25	+30	+35	+40	+45	+50	+55	+60	+65	+70
1 A	1.66	1.62	1.59	1.55	1.51	1.47	1.43	1.39	1.35	1.3	1.26	1.21	1.16	1.11	1.06	1	0.94	0.88	0.81	0.73
2 A	2.64	2.6	2.56	2.52	2.48	2.44	2.4	2.36	2.32	2.28	2.23	2.19	2.14	2.1	2.05	2	1.95	1.9	1.85	1.79
3 A	3.97	3.91	3.86	3.8	3.74	3.68	3.61	3.55	3.49	3.42	3.36	3.29	3.22	3.15	3.07	3	2.92	2.85	2.77	2.68
4 A	5.19	5.12	5.05	4.98	4.9	4.83	4.75	4.67	4.6	4.52	4.43	4.35	4.27	4.18	4.09	4	3.91	3.81	3.72	3.62
6 A	7.42	7.34	7.25	7.16	7.07	6.98	6.89	6.8	6.7	6.61	6.51	6.41	6.31	6.21	6.11	6	5.89	5.78	5.67	5.56
10 A	12.9	12.7	12.5	12.3	12.2	12	11.8	11.6	11.4	11.2	11	10.8	10.6	10.4	10.2	10	9.8	9.6	9.3	9.1
16 A	20.4	20.1	19.8	19.6	19.3	19	18.7	18.5	18.2	17.9	17.6	17.3	17	16.7	16.3	16	15.7	15.3	15	14.6
20 A	25.7	25.3	25	24.6	24.3	23.9	23.6	23.2	22.8	22.4	22	21.7	21.3	20.8	20.4	20	19.6	19.1	18.7	18.2
25 A	31.6	31.2	30.8	30.4	30	29.6	29.2	28.7	28.3	27.8	27.4	26.9	26.5	26	25.5	25	24.5	24	23.5	22.9
32 A	41.1	40.5	40	39.4	38.9	38.3	37.7	37.1	36.5	35.9	35.3	34.7	34	33.4	32.7	32	31.3	30.6	29.9	29.1
40 A	52	51.3	50.6	49.8	49.1	48.3	47.6	46.8	46	45.2	44.4	43.5	42.7	41.8	40.9	40	39.1	38.1	37.1	36.1

C60H-DC derating table

C60H-DC	Ambient temperature (°C)																			
	-25	-20	-15	-10	-5	0	+5	+10	+15	+20	+25	+30	+35	+40	+45	+50	+55	+60	+65	+70
0.5 A	0.62	0.61	0.6	0.59	0.58	0.56	0.55	0.54	0.53	0.51	0.5	0.49	0.47	0.46	0.44	0.43	0.41	0.39	0.38	0.36
1 A	1.17	1.15	1.14	1.12	1.1	1.09	1.07	1.05	1.04	1.02	1	0.98	0.96	0.94	0.92	0.9	0.88	0.86	0.84	0.82
2 A	2.5	2.45	2.41	2.36	2.31	2.26	2.21	2.16	2.11	2.06	2	1.94	1.88	1.82	1.76	1.7	1.63	1.56	1.48	1.41
3 A	3.71	3.65	3.58	3.51	3.45	3.38	3.3	3.23	3.16	3.08	3	2.92	2.84	2.75	2.66	2.57	2.48	2.38	2.27	2.17
4 A	4.99	4.9	4.81	4.71	4.62	4.52	4.42	4.32	4.22	4.11	4	3.89	3.77	3.65	3.53	3.4	3.27	3.13	2.98	2.83
5 A	5.92	5.83	5.74	5.66	5.57	5.48	5.39	5.29	5.2	5.1	5	4.9	4.8	4.69	4.58	4.47	4.36	4.24	4.12	4
6 A	7.15	7.04	6.94	6.83	6.71	6.6	6.48	6.37	6.25	6.12	6	5.87	5.74	5.61	5.47	5.33	5.19	5.04	4.89	4.73
10 A	12.4	12.2	11.9	11.7	11.5	11.3	11	10.8	10.5	10.3	10	9.7	9.5	9.2	8.9	8.6	8.3	7.9	7.6	7.2
13 A	15.3	15.1	14.9	14.6	14.4	14.2	14	13.7	13.5	13.3	13	12.8	12.5	12.2	12	11.7	11.4	11.1	10.8	10.5
15 A	18.3	18	17.7	17.4	17.1	16.7	16.4	16.1	15.7	15.4	15	14.6	14.3	13.9	13.5	13	12.6	12.2	11.7	11.2
16 A	19.1	18.9	18.6	18.3	18	17.6	17.3	17	16.7	16.3	16	15.7	15.3	14.9	14.6	14.2	13.8	13.4	13	12.5
20 A	23.7	23.4	23	22.7	22.3	21.9	21.6	21.2	20.8	20.4	20	19.6	19.2	18.7	18.3	17.9	17.4	16.9	16.4	15.9
25 A	29.9	29.5	29	28.5	28.1	27.6	27.1	26.6	26.1	25.5	25	24.5	23.9	23.3	22.7	22.1	21.5	20.9	20.2	19.6
30 A	36.7	36.1	35.5	34.9	34.2	33.5	32.9	32.2	31.5	30.7	30	29.2	28.5	27.7	26.8	26	25.1	24.2	23.2	22.3
32 A	37.9	37.4	36.8	36.2	35.7	35.1	34.5	33.9	33.3	32.6	32	31.4	30.7	30	29.3	28.6	27.9	27.1	26.3	25.5
40 A	48.2	47.4	46.7	45.9	45.1	44.3	43.5	42.6	41.8	40.9	40	39.1	38.2	37.2	36.2	35.2	34.2	33.1	32	30.8
50 A	59.1	58.3	57.4	56.5	55.6	54.7	53.8	52.9	52	51	50	49	48	46.9	45.9	44.8	43.6	42.5	41.3	40.1
63 A	76.9	75.6	74.3	73	71.7	70.3	68.9	67.5	66	64.5	63	61.4	59.8	58.2	56.5	54.7	52.9	51.1	49.1	47.1

5

RCCB

■ In all cases, the RCCB are correctly protected against overloads by a circuit breaker with a lower or equal rating, operating at the same ambient temperature.

Dissipated power, Impedance and Voltage drop

Acti9 products

The following table indicates the average dissipated power per pole in W for a current equal to the rating of the device and at the operating voltage.

Rating (A)	0.5	1	1.6	2	2.5	3	4	6	6.3	10	12.5	13	16	20	25	32	40	45	50	63	80	100	125	
RCCB																								
iID 2P														0.8		0.9		2.6			2.6	3	5	
4P															0.7		1.9			1.5	2.6	4.3		

Note: When the enclosure's thermal balance, consider the 4P devices load is only on 3 phases.

Multi9 products

The following table indicates the average dissipated power per pole in W for a current equal to the rating of the device and at the operating voltage.

Rating (A)	0.5	1	2	3	4	5	6	8	10	13	15	16	20	25	30	32	35	40	45	50	63	80	100	125	
Circuit breakers																									
C60BP, C60BPR, C60SP	2.6	1.3	1.7	1.9	2.0	2.2	1.2	1.7	1.9	2.4	2.3	2.6	2.2	3.4	2.5	2.8	3.5	3.6	3.9	4.8	4.8				
C60N, C60H, C60L, C60CTRL		1.3	1.7	1.9	2.0		1.2		1.9	2.4		2.6	2.2	2.7		3.2		3.6		4.8	4.3				
N40N		2.5	1.9	2.1	2.6		2.7		2.7			3.2	4.7	4.7		4.6		5.8							
C60H-DC	2.6	1.3	1.7	1.9	2.0		1.2		1.9	2.4		2.6	2.2	2.7		3.2		3.6		4.8	4.3				
RCCB																									
GFP A-SI Type														1.4				3.6			4.4		18		
ID AC / A-SI Type														1.4				3.6			4.4				
ID B Type														1.2				2.9			7.2	12		28	
RCBO																									
N40 Vigi							4.1		3.2			3.9	4.4	4.5				6.4							
Add-on residual current devices																									
Vigi C60 AC / A-SI Type																					3.0				
Vigi N40 AC / A-SI Type																		2.1							

Note: RCBO dissipated power per pole is the sum of circuit breaker dissipated power per pole + add-on residual current device dissipated power per pole.
 Example: C60N (63 A) + Vigi C60 (63 A) = 4.3 + 3.0 = 7.3 W.

Impedance calculation:

$$Z = P / I^2$$

Z: impedance in Ohms
 P: dissipated power in Watts (table values)
 I: rating in Amperes

Voltage drop calculation:

$$U = P / I$$

U: voltage drop in Volts
 P: dissipated power in Watts (table values)
 I: rating in Amperes

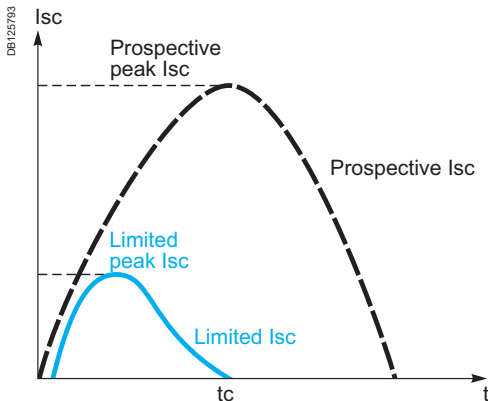

Prospective current and real limit current.

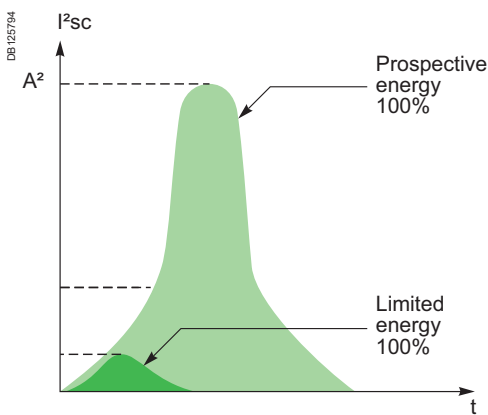

Definition

The limiting capacity of a circuit breaker is its ability to lessen the effects of a short-circuit on an electrical installation by reducing the current amplitude and the dissipated power.

Benefits of limiting

Long installation service life

Thermal effects

Lower temperature rise at the conductor level, hence increased service life for cables and all components that are not self-protected (e.g. switches, contactors, etc.)

Mechanical effects

Lower electrodynamic repulsion forces, hence less risk of deformation or breakage of electrical contacts and busbars.

Electromagnetic effects

Less interference on sensitive equipment located in the vicinity of an electric circuit.

Savings through cascading

Cascading is a technique derived directly from current limiting: downstream of a current-limiting circuit breaker it is possible to use circuit breakers of breaking capacity lower than the prospective short-circuit current (in line with the cascading tables). The breaking capacity is heightened thanks to current limiting by the upstream device. Substantial savings can be achieved in this way on switchgear and enclosures.

Discrimination of protection devices

The circuit breakers' current limiting capacity improves discrimination with the protection devices located upstream: this is because the required energy passing through the upstream protection device is greatly reduced and can be not enough to cause it to trip. Discrimination can thus be natural without having to install a time-delayed protection device upstream.

Short-circuit current limiting (cont.)

Representation: Current limiting curves

The current limiting capacity of a circuit breaker is reflected by 2 curves which give, as a function of the prospective short-circuit current (current which would flow in the absence of a protection device):

- the real peak current (limited)
- the thermal stress (in A²s), this value, multiplied by the resistance of any element through which the short-circuit current passes, gives the power dissipated by this element.

The straight line "10 ms" representing the energy A²s of a prospective short-circuit current of a half-period (10 ms) indicates the energy that would be dissipated by the short-circuit current in the absence of limiting by the protection device (see example).

Example

What is the energy limited by a C60N 25 A circuit breaker for a prospective short-circuit current of 10 kA rms. What is the quality of current limiting?

> as shown in the graph opposite:

- this short-circuit current (10 kA rms) is likely to dissipate up to 1,000 kA²s
- the C60N circuit breaker reduces this thermal stress to: 43 kA²s, which is 23 times less.

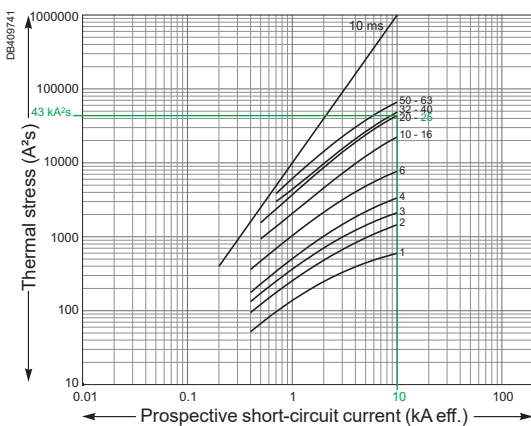

C60N Thermal stress (380-415 V AC)

Example of use: Stresses acceptable by the cables

The following table shows the thermal stresses acceptable by the cables depending on their insulation, their composition (Cu or Al) and their cross section. Cross-section values are expressed in mm² and stresses in A²s.

S (mm ²)		1.5	2.5	4	6	10
PVC	Cu	2.97 x 10 ⁴	8.26 x 10 ⁴	2.12 x 10 ⁵	4.76 x 10 ⁵	1.32 x 10 ⁶
	Al					5.41 x 10 ⁵
PRC	Cu	4.10 x 10 ⁴	1.39 x 10 ⁵	2.92 x 10 ⁵	6.56 x 10 ⁵	1.82 x 10 ⁶
	Al					7.52 x 10 ⁵

S (mm ²)		16	25	35	50
PVC	Cu	3.4 x 10 ⁶	8.26 x 10 ⁶	1.62 x 10 ⁷	3.21 x 10 ⁷
	Al	1.39 x 10 ⁶	3.38 x 10 ⁶	6.64 x 10 ⁶	1.35 x 10 ⁷
PRC	Cu	4.69 x 10 ⁶	1.39 x 10 ⁷	2.23 x 10 ⁷	4.56 x 10 ⁷
	Al	1.93 x 10 ⁶	4.70 x 10 ⁶	9.23 x 10 ⁶	1.88 x 10 ⁷

Example

Is a Cu/PRC cable of cross section 6 mm² protected by a C60N 40 A device?

The above table shows that the acceptable stress is 6.56 x 10⁵ A²s. Any short-circuit current at the point where a C60N 40 A device (I_{cu} = 25 kA) is installed will be limited, with a thermal stress of less than 5.7 x 10⁵ A²s.

The cable is therefore always protected up to the breaking capacity of the circuit breaker.

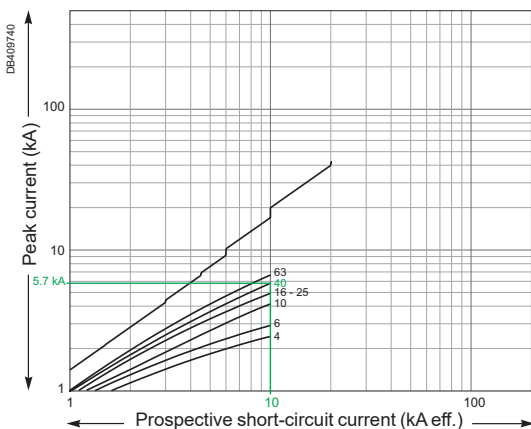

C60N Peak current (380-415 V AC)

Short-circuit current limiting (cont.)

U_e: 380-415 V AC

Limitation curves for network

U_e: 380-415 V AC (Ph/N 220-240 V AC)

C60BP, C60BPR, C60SP

1P / 2P / 3P

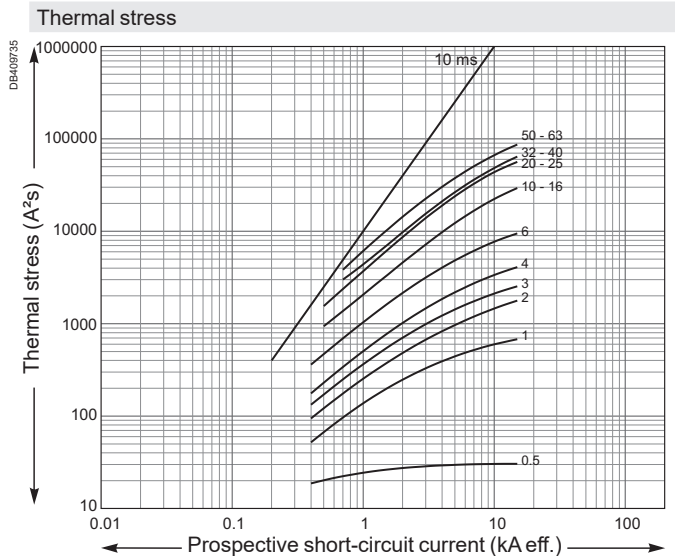
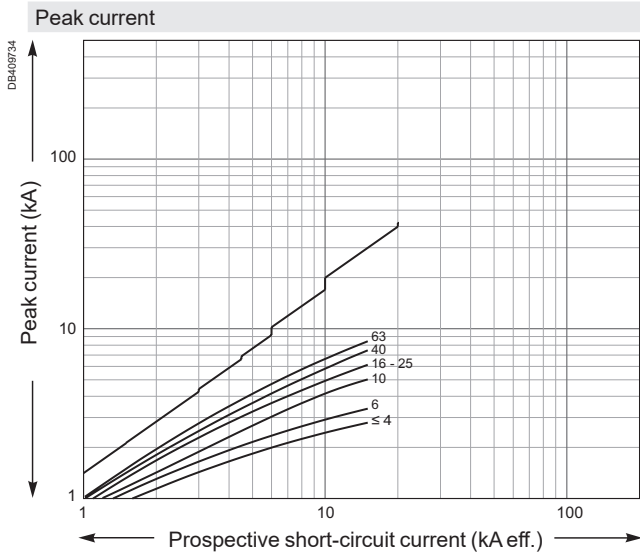

C60N

1P / 2P / 3P / 4P

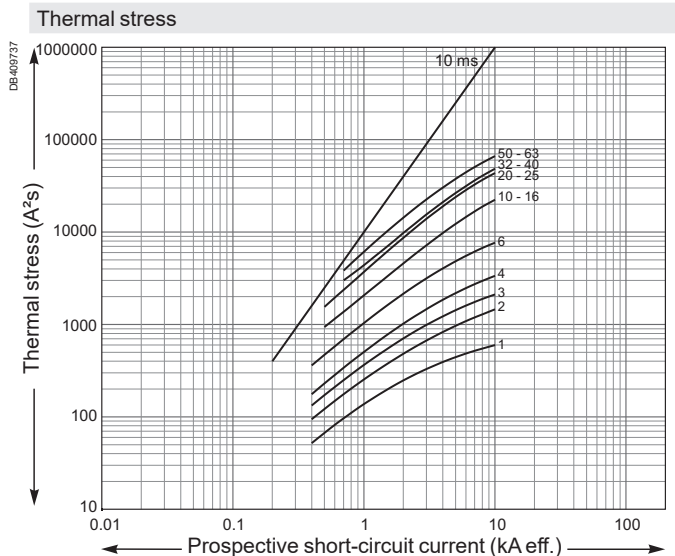
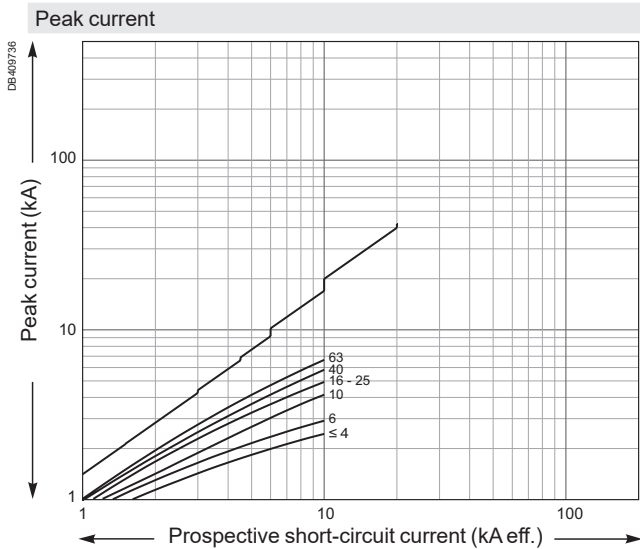

Short-circuit current limiting (cont.)

U_e: 380-415 V AC

Limitation curves for network

U_e: 380-415 V AC (Ph/N 220-240 V AC)

C60H

1P / 2P / 3P / 4P

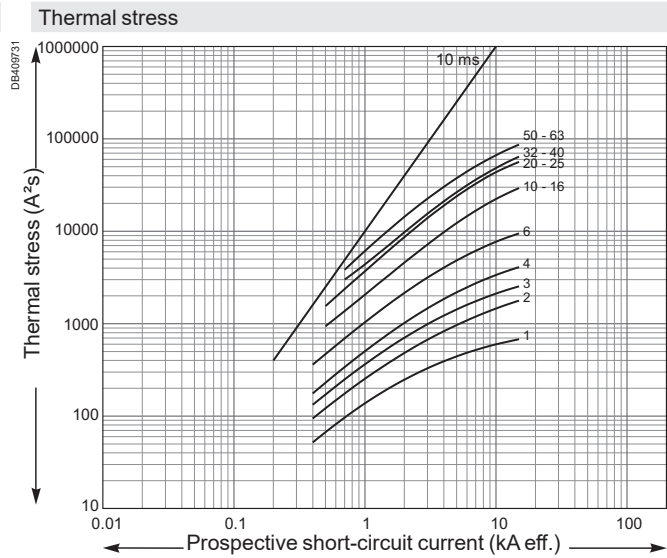
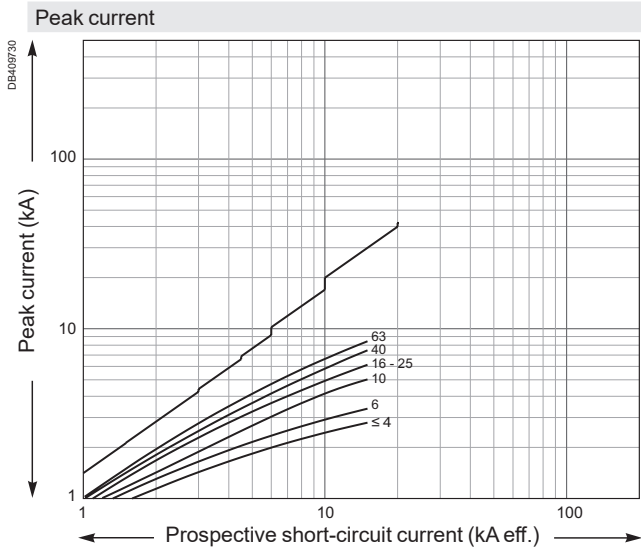

C60L

1P / 2P / 3P / 4P

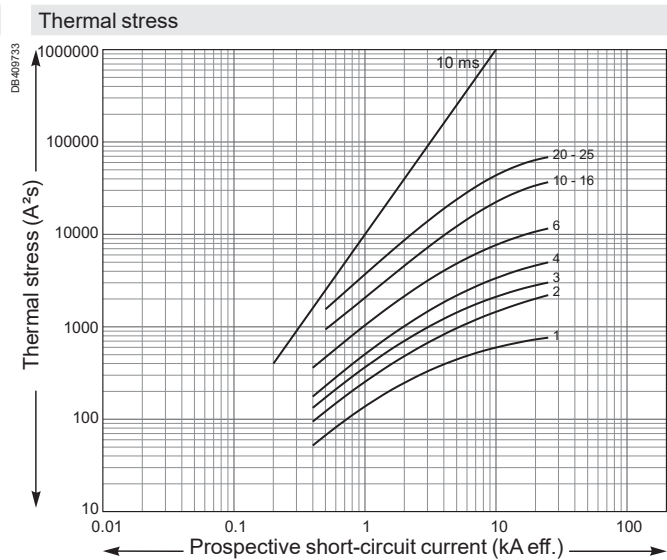
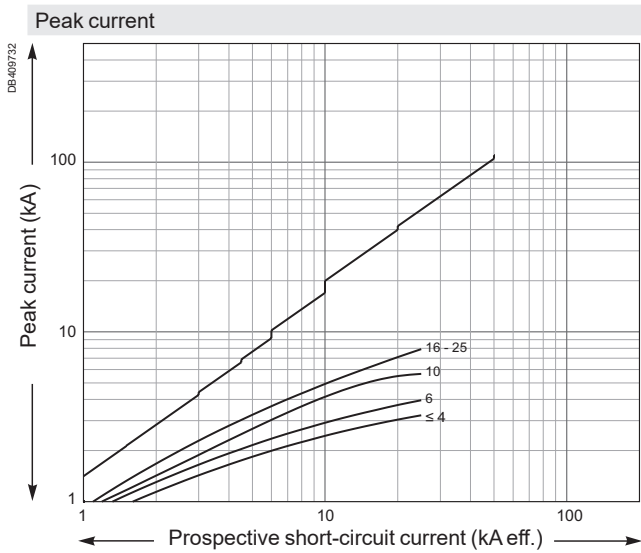

Short-circuit current limiting (cont.)

U_e: 380-415 V AC

Limitation curves for network

U_e: 380-415 V AC (Ph/N 220-240 V AC)

N40N, N40 Vigi

1P+N / 3P+N

Peak current

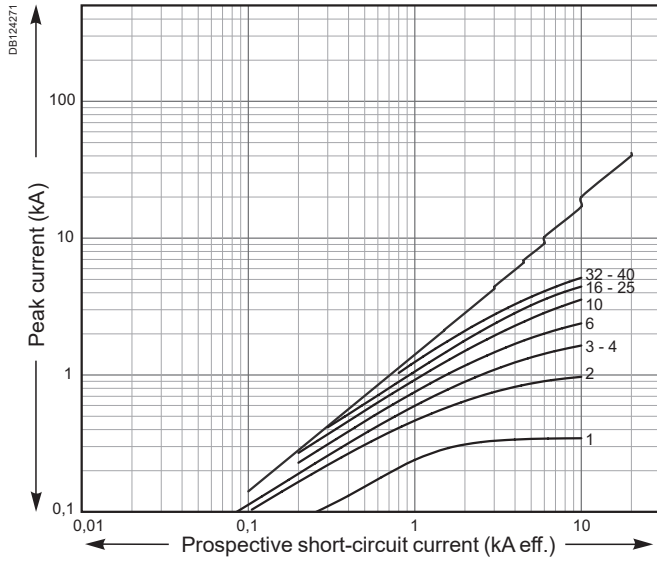

Thermal stress

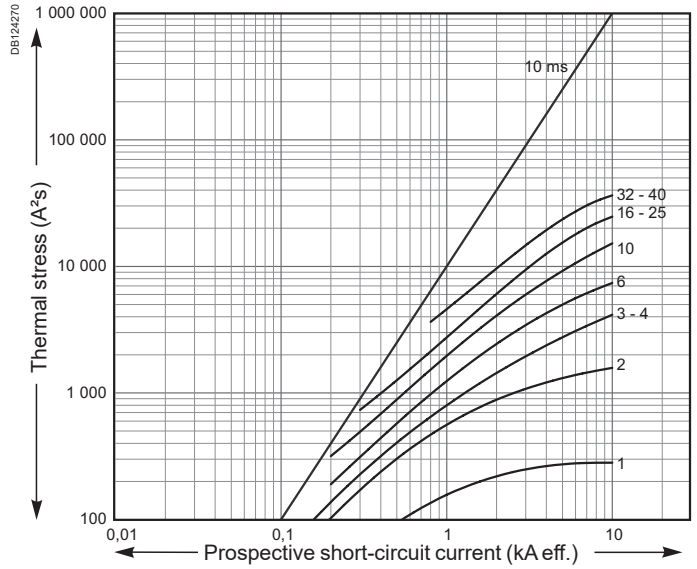

Short-circuit current limiting (cont.)

U_e: 480 V AC 60 Hz

Limitation curves for network

U_e: 480 V AC 60 Hz (Ph/N 277 V AC)

C60BP, C60BPR

1P / 2P / 3P

Peak current

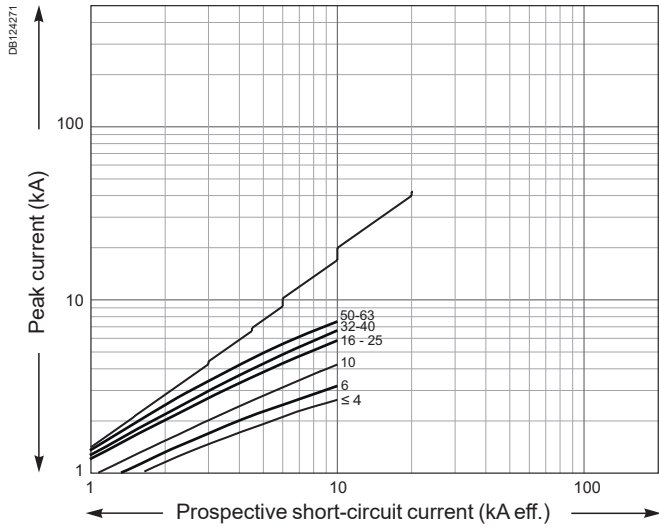

Thermal stress

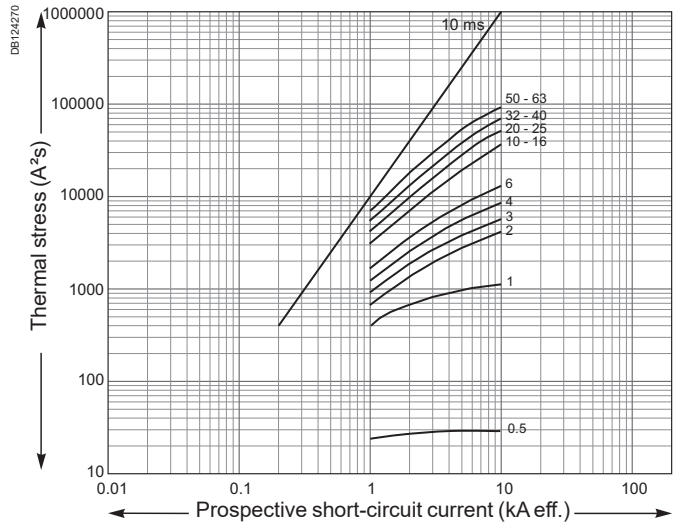

Short-circuit current limiting (cont.)

Direct current network

Limitation curves for direct current network

C60H-DC C curve

1P (250 V DC) - 2P (500 V DC)

Peak current

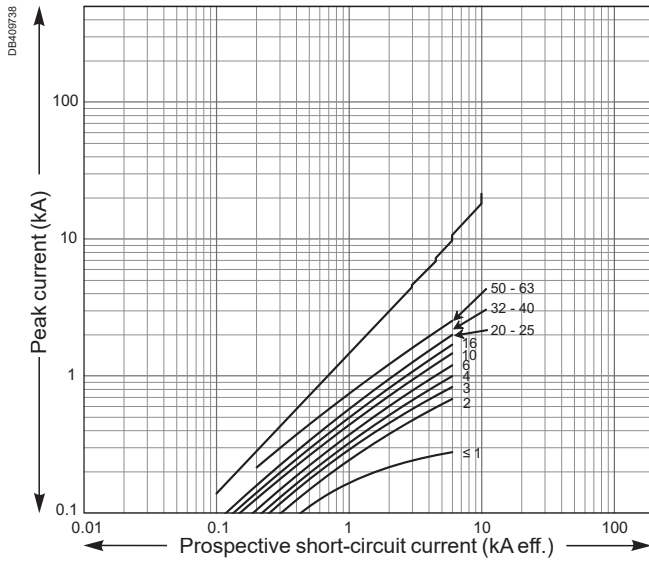

Thermal stress

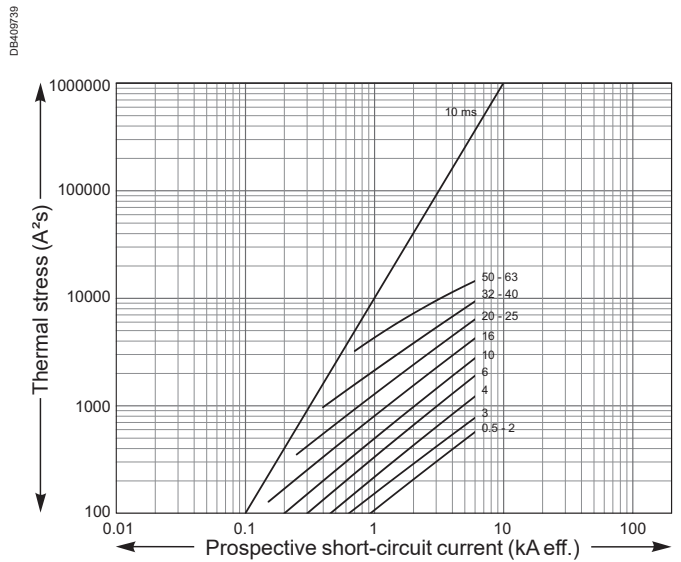

Clearance between device and bare sheet metal

Minimum clearance between device and bare sheet metal (mm / inches)

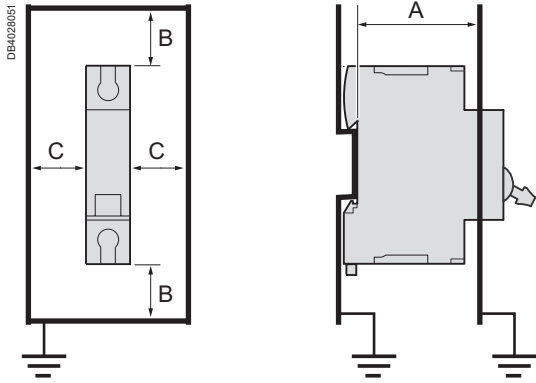





UL/IEC/GB standards				
Products	C60BP	C60BPR	C60SP, C60H-DC	C60N, C60H, C60L, C60CTRL
A	52 mm (2.05 in)	52 mm (2.05 in)	50 mm (1.97 in)	50 mm (1.97 in)
B	10 mm (0.39 in)	10 mm (0.39 in)	20 mm (0.79 in)	20 mm (0.79 in)
C	10 mm (0.39 in)	10 mm (0.39 in)	10 mm (0.39 in)	10 mm (0.39 in)

Details of minimum distances between the product and earthed metal parts for device intended for use without enclosure.

Technical information

Copper Multi-cables connection

Connection

Products	Rating	Copper Multi-cables			Cable stripping length
		Rigid	Flexible without ferrule	Flexible with ferrule	
					
C60BP UL489	≤25A	2x1.5 mm ² or 2x2.5 mm ² or 2x1.5 mm ² +1x2.5 mm ²		2xAWG #16 or 2xAWG #14 or 2xAWG #16+1xAWG #14	14 mm / 0.55 in
	>25A	2x4 mm ² or 2x6 mm ² or 2x1.5 mm ² +1x2.5 mm ²		2xAWG #12 or 2xAWG #10 or 2xAWG #16+1xAWG #14	14 mm / 0.55 in
C60SP UL1077	≤25A	2x1.5 mm ² or 2x2.5 mm ² or 2x1.5 mm ² +1x2.5 mm ²		2xAWG #16 or 2xAWG #14 or 2xAWG #16+1xAWG #14	14 mm / 0.55 in
	>25A	2x4 mm ² or 2x6 mm ² or 2x1.5 mm ² +1x2.5 mm ²		2xAWG #12 or 2xAWG #10 or 2xAWG #16+1xAWG #14	14 mm / 0.55 in
C60H-DC	≤25A	2x1.5 mm ² or 2x2.5 mm ² or 2x1.5 mm ² +1x2.5 mm ²		2xAWG #16 or 2xAWG #14 or 2xAWG #16+1xAWG #14	14 mm / 0.55 in
	>25A	2x4 mm ² or 2x6 mm ² or 2x1.5 mm ² +1x2.5 mm ²		2xAWG #12 or 2xAWG #10 or 2xAWG #16+1xAWG #14	14 mm / 0.55 in
C60N, H, L, C60CTRL	≤25A	2x1.5 mm ² or 2x2.5 mm ² or 2x1.5 mm ² +1x2.5 mm ²		2xAWG #16 or 2xAWG #14 or 2xAWG #16+1xAWG #14	14 mm / 0.55 in
	>25A	2x4 mm ² or 2x6 mm ² or 2x1.5 mm ² +1x2.5 mm ²		2xAWG #12 or 2xAWG #10 or 2xAWG #16+1xAWG #14	14 mm / 0.55 in
N40N	All	2x1.5 mm ² or 2x2.5 mm ² or 2x1.5 mm ² +1x2.5 mm ²		2xAWG #16 or 2xAWG #14 or 2xAWG #16+1xAWG #14	13 mm / 0.5 in
GFP UL1053	All	2x 1.5 mm ² to 10 mm ²		2x AWG #16 to #8	14 mm / 0.55 in
RCCB ID IEC/EN 61008-1	All	2x 1.5 mm ² to 10 mm ²		2x AWG #16 to #8	14 mm / 0.55 in
RCCB-ID 125A	All	2x 1.5 mm ² to 16 mm ²		2x AWG #16 to #6	11 mm / 0.43 in
Vigi C60	All	2x4 mm ² or 2x6 mm ² or 2x1.5 mm ² +1x2.5 mm ²		2xAWG #12 or 2xAWG #10 or 2xAWG #16+1xAWG #14	14 mm / 0.55 in
Vigi N40	All	2x1.5 mm ² or 2x2.5 mm ² or 2x1.5 mm ² +1x2.5 mm ²		2xAWG #16 or 2xAWG #14 or 2xAWG #16+1xAWG #14	13 mm / 0.5 in
N40 Vigi	All	2x1.5 mm ² or 2x2.5 mm ² or 2x1.5mm ² +1x2.5 mm ²		2xAWG #16 or 2xAWG #14 or 2xAWG #16+1xAWG #14	13 mm / 0.5 in

Discover our technical guides collection.

They are dedicated to frequent issues faced when designing an installing a control panel.

How to reduce damage to components through effective thermal management inside an enclosure



Ref.: CPTG001_EN



Click on QR code or scan to download

How to prevent machine malfunctions and electronic damage due to voltage surges

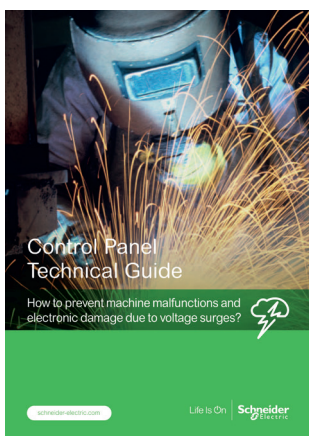

Ref.: CPTG002_EN



Click on QR code or scan to download

How to ensure trouble-free approval of your UL-compliant control panels

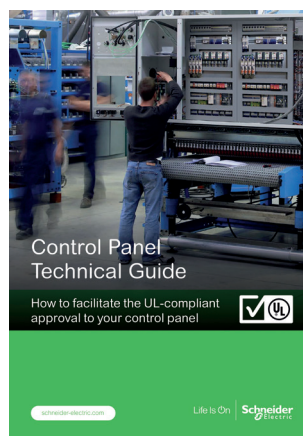

Ref.: CPTG005_EN



Click on QR code or scan to download

Free download on www.se.com with the document reference or from the QR codes.

Discover our technical guides collection.

They are dedicated to frequent issues faced when designing an installing a control panel.

How define the right outdoor enclosure and optimize its durability



Ref.: CPTG006_EN



Click on QR code or scan to download

How to choose the circuit breaker and transfer switch for a generator set



Ref.: CPTG008_EN



Click on QR code or scan to download

How to select the appropriate motor starters for your HVAC equipments



Ref.: CPTG007_EN



Click on QR code or scan to download

How to prevent condensation inside an enclosure



Ref.: UE12MK03EN



Click on QR code or scan to download

Free download on www.se.com with the document reference or from the QR codes.

Discover our technical guides collection.

They are dedicated to frequent issues faced when designing an installing a control panel.

How to choose the contactors for elevator machinery?

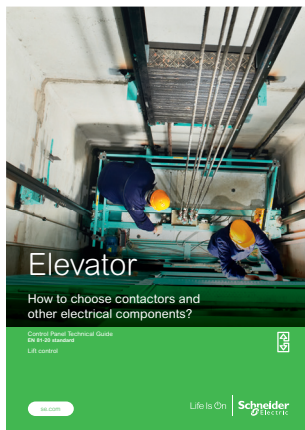

Ref.: CPTG009_EN



Click on QR code or scan to download

How to select the appropriate motor control system for your pump

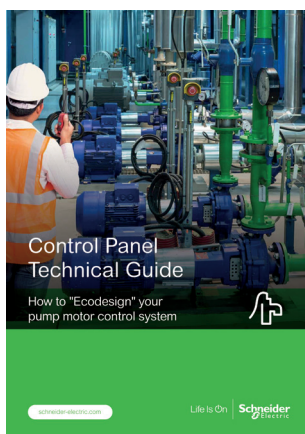

Ref.: CPTG010_EN



Click on QR code or scan to download

Free download on www.se.com with the document reference or from the QR codes.



Schneider Electric SE

35, rue Joseph Monier
92500 Rueil Malmaison
France

RCS Nanterre 542 048 574
Capital social 2 284 371 684 €
www.se.com

02-2023
LVCATM9OEM_EN

© 2023 - Schneider Electric. All Rights Reserved.
All trademarks are owned by Schneider Electric Industries SAS or its affiliated companies.

This document has been
printed on recycled paper



X-ON Electronics

Largest Supplier of Electrical and Electronic Components

Click to view similar products for [Contactors - Electromechanical category](#):

Click to view products by [Schneider manufacturer](#):

Other Similar products are found below :

[686-120111](#) [70-901](#) [70-914](#) [MB-3D-6](#) [MC-22A/4-AC120V](#) [8-1616943-9](#) [8-1672124-5](#) [A701U](#) [AVR743D](#) [B6-40-00-84](#) [B7-40-00-84](#)
[1616017-5](#) [MVDILM](#) [HP-11D-24](#) [CA7-72-00-24Z](#) [90-162](#) [9-1393132-2](#) [2NC4F0222](#) [A275KXXV2-120VAC](#) [ACC338UMM20](#)
[AF80-30-11-13](#) [SZ-B1](#) [3GC2H0M22](#) [3NC1Q0A22](#) [3NC2H0A22](#) [42AF35AG](#) [42CF35AE](#) [42CF35AG](#) [42EF35AFR](#) [45CG10AFA](#)
[45CG10AJA](#) [45CG10EJA](#) [45CG20AF](#) [45CG20AL](#) [45CG20EF](#) [45CG20EG](#) [45CG20EL](#) [45DG10AFA](#) [45DG10AGA](#) [45DG10AJA](#)
[45DG10ALA](#) [45DG10ELA](#) [45DG20AG](#) [45DG20AL](#) [45EG10AFA](#) [45EG10AJA](#) [45EG10ALA](#) [45EG20AF](#) [45EG20AL](#) [45FG10AFA](#)