

Harmony[®] K, Ø 16-22 cam switches

Catalog

March **2015**



How can you fit a 6000-page catalog in your pocket ?

Schneider Electric provides you with the complete set of industrial automation catalogs all on a handy USB key for PC or in an application for tablets



Digi-Cat, a handy USB key for PC



- > Convenient to carry
- > Always up-to-date
- > Environmentally friendly
- > Easy-to-share format



Contact your local representative to get your own Digi-Cat



e-Library, the app for tablets

If you have an iPad®:

- > Go to the App Store and search for e-Library
- > or scan the QR code



If you have an Android tablet:

- > Go to the Google Play Store™ and search for eLibrary
- > or scan the QR code

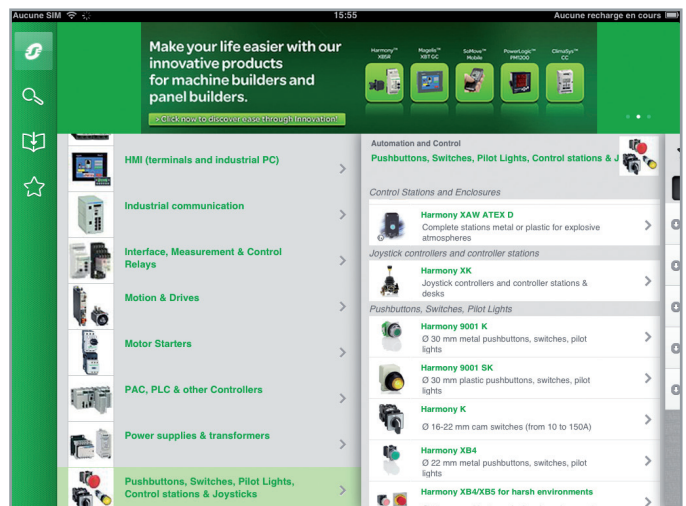

General contents

Selection guide, functions panorama	1
Complete switches, 10 A.....	2
Complete switches, 12 and 20 A	3
Adaptable sub-assemblies, 12 and 20 A	4
Complete switches, 12 A with key operated lock	5
Switches, 10 and 16 A, mounted in plastic enclosure	6
Complete switches, 32 to 150 A.....	7
Index.....	8

Selection guide, functions panorama

Selection guide 1/2

■ **Functions panorama** 1/4

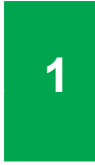

Cam switches

Type K

1

Applications	Used in building control panels and consoles, type K cam switches allow control of processes and utilities in industry and buildings and direct control for simple machines.	
Functions		
Off-On/On-Off switches	1 to 4-pole	1 to 6-pole
Stepping switches	2 to 4-position, 1 and 2-pole	2 to 12-position, 1 to 4-pole
Changeover switches	1 to 4-pole	1 to 5-pole
Measurement switches	Voltmeter and ammeter	Voltmeter and ammeter
Reversing switches	-	2 and 3-pole
Reversing star-delta switches	-	-
Pole change switches	-	2 and 3-speed



Conventional rated thermal current (I_{th})	10 A	12 A
Rated insulation voltage (U_i)	440 V	690 V
Electrical operating characteristics	AC-15 - A300 240 V - 3 A	AC-3 - 3-phase 230 V - 1.1 kW - 4.6 A AC-15 230 V - 3 A
Front plate degree of protection	IP 65	IP 40 IP 65 (with seal)
Product composition	Complete switches	Complete switches Adaptable sub-assemblies Special products (Consult our Customer Care Centre)
Compatibility	Ø 16 and Ø 22 control and signaling units	Ø 22 control and signaling units
Fixing		
Front mounting	Single Ø 16 or Ø 22 hole	Multi-fixing Single Ø 22 hole
Rear mounting	-	Screw fixing, 4 holes on 36 mm/1.42 in. centres
Front plate dimensions (mm)	30 x 30 mm/1.18 x 1.18 in.	45 x 45 mm/1.77 x 1.77 in. 60 x 60 mm/2.36 x 2.36 in. (adaptable sub-assemblies)
Operating heads	Black standard handle Metallic legend, black marking	Black and red standard and long handles Key operator Metallic head Metallic legend with black marking or black legend with white marking
Approvals	cULus EN/IEC 60947-3 EN/IEC 60947-5-1	UL-CSA EN/IEC 60947-3 EN/IEC 60947-5-1
Type	Type K10	Type K1/K2
Cam switch model	K10●	K1●



More technical information on www.schneider-electric.com

Functions		Complete switches 10 A
Switches	with 60° switching angle	See pages
	with 45° switching angle	2/3
	with 90° switching angle	-
	ON-OFF with spring return from 30° to "0" position	-
	OFF-ON with spring return from 30° to "0" position	-
	OFF-ON with spring return from 120° to 90°	-
	OFF-ON with spring return from 30° and from 330° to "0" position	-
	OFF-ON with 45° switching angle	-
	OFF-ON with momentary-contact function	-
	paralleling with "0" position	-
	OFF-ON changeover with spring return from 240° to 270° and from 120° to 90°	-
	Stepping switches	single-pole with or without "0" position
2-pole with or without "0" position		2/4, 2/5
2 to 5 step, single-pole, with or without "0" position		-
2 to 5 step, 2-pole, with or without "0" position		-
2 and 3 step, 3-pole, with or without "0" position		-
2 to 11 step, single-pole, with "0" position		-
2 to 12 step, single-pole, without "0" position		-
2 to 6 step, 2-pole, with or without "0" position		-
2 to 6 step, 3-pole, with or without "0" position		-
2 to 5 step, 4-pole, with or without "0" position		-
2 and 3 step, with "0" position + left-hand position		-
3 step, without "0" position		-
4 step, 4-pole, without "0" position		-
2 step, with "0" position		-
3 step, 2-pole, with "0" position		-
5 step, 2-pole, with "0" position	-	
Changeover switches	spring return to "0" position	2/5
	with or without "0" position	2/6
	1 to 4-pole with "0" position	-
	1 to 4-pole without "0" position	-
	1-pole, 2-pole, 3-pole with "0" position	-
	star-delta and reversing star-delta	-
	pole change	-
Voltmeter switches	with "0" position	2/7
	without "0" position	-
Ammeter switches	with "0" position	2/7
	without "0" position	-
Selector switches	BCD encoded output, with "0" position	-
	BCD encoded output, without "0" position	-
	multi-circuit	-
	star-delta and reversing star-delta	-
Reversing switches	with "0" position	-
	with spring return from 330° and from 30° to "0" position	-
	with spring return from 315° and from 45° to "0" position	-
	with spring return from 240° to 270° and from 120° to 90°	-
	with momentary-contact function	-
Pole change switches	for 2-speed motors	-
	for 3-speed motors	-
Start selector switches	3-position with "0" position	-
	4-position with "0" position	-
Starting switches	star-delta and reversing star-delta	-
	pole change	-

Complete switches, 10 A

- General 2/2
- Front mounting by Ø 16 or 22 mm hole, with 30 x 30 mm front plate 2/3
- Switches and stepping switches 2/3
- Changeover switches 2/5
- Voltmeter and ammeter switches 2/7



Cam switches

Complete switches, 10 A

2

Complete switches

- switches
- stepping switches
- changeover switches
- voltmeter switches
- ammeter switches

The range of K10 cam switches (10 A rating) comprises only complete switches. These products are more specifically designed for process control applications:

- compact size,
- easy to integrate with other $\varnothing 16 \text{ mm}/0.63 \text{ in.}$ and $\varnothing 22 \text{ mm}/0.87 \text{ in.}$ units,
- selection functions.

Front mounting

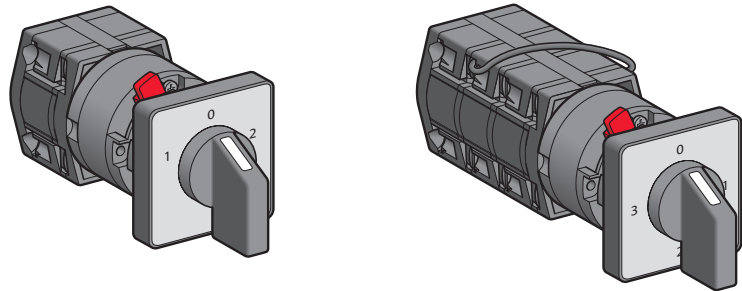

By $\varnothing 16.3 \text{ mm}/0.64 \text{ in.}$ or $\varnothing 22.3 \text{ mm}/0.88 \text{ in.}$ hole

Mounting

$\varnothing 16$ or $\varnothing 22$ hole fixing

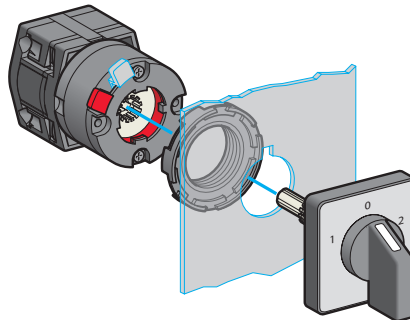

Locking/unlocking of the body-head assembly by spigot

$\varnothing 16$ hole fixing

$\varnothing 22$ hole fixing

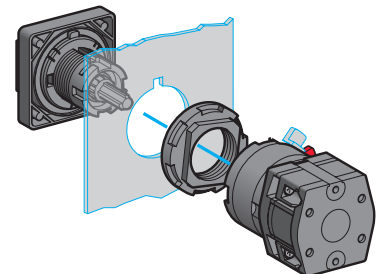
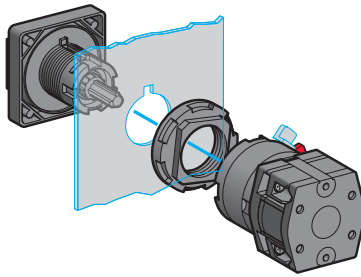

Cam switches

Complete switches, 10 A

Front mounting by Ø 16 or Ø 22 mm hole

With 30 x 30 mm front plate



K10B002ACH

Switches with 60° switching angle

Wiring diagram and switching programme	Marking and switch position	Number of poles	Reference	Weight kg/lb
		1	K10A001ACH	0.030/0.066
		2	K10B002ACH	0.035/0.077
		3	K10C003ACH	0.045/0.099
		4	K10D004ACH	0.045/0.099

Stepping switches, single-pole, with "0" position

Wiring diagram and switching programme	Marking and switch position	Number of steps	Reference	Weight kg/lb
		2 + "0" position	K10B002QCH	0.035/0.077
		3 + "0" position	K10C003QCH	0.045/0.099
		4 + "0" position	K10D004QCH	0.045/0.099



K10D004QCH

Cam switches

Complete switches, 10 A

Front mounting by Ø 16 or Ø 22 mm hole

With 30 x 30 mm front plate

2

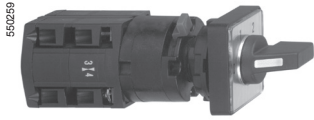

K10D012QCH

Stepping switches, 2-pole, with "0" position

Wiring diagram and switching programme	Marking and switch position	Number of steps	Reference	Weight kg/lb
		2 + "0" position	K10D012QCH	0.045/0.099

		3 + "0" position	K10F013QCH	0.055/0.121
--	--	------------------	-------------------	-------------

Stepping switches, single-pole, without "0" position

		3	K10C003NCH	0.045/0.099
--	--	---	-------------------	-------------

		4	K10D004NCH	0.045/0.099
--	--	---	-------------------	-------------

Cam switches

Complete switches, 10 A

Front mounting by Ø 16 or Ø 22 mm hole

With 30 x 30 mm front plate

Stepping switch, 2-pole, without "0" position

Wiring diagram and switching programme	Marking and switch position	Number of steps	Reference	Weight kg/lb
--	-----------------------------	-----------------	-----------	--------------

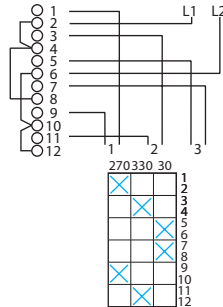

3

K10F013NCH

0.055/0.121



Changeover switch with spring return to "0" position

Wiring diagram and switching programme	Marking and switch position	Number of poles	Reference	Weight kg/lb
--	-----------------------------	-----------------	-----------	--------------

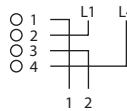

1

K10B006TCH

0.035/0.077



K10B006TCH



2

Cam switches

Complete switches, 10 A

Front mounting by Ø 16 or Ø 22 mm hole

With 30 x 30 mm front plate

2



K10F003UCH

Changeover switches with "0" position

Wiring diagram and switching programme	Marking and switch position	Number of poles	Reference	Weight kg/lb
		1	K10B001UCH	0.035/0.077
		2	K10D002UCH	0.045/0.099
		3	K10F003UCH	0.055/0.121
		4	K10H004UCH	0.065/0.143

Changeover switches without "0" position

		1	K10B011UCH	0.035/0.077
		2	K10D012UCH	0.045/0.099
		3	K10F013UCH	0.055/0.121
		4	K10H014UCH	0.065/0.143

Cam switches

Complete switches, 10 A

Front mounting by Ø 16 or Ø 22 mm hole

With 30 x 30 mm front plate

550262



K10F027MCH

Voltmeter switches

For measurements between 3 phases and between 1 phase and neutral

Wiring diagram and switching programme	Marking and switch position	Reference	Weight kg/lb
--	-----------------------------	-----------	--------------

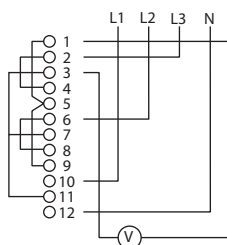

K10F027MCH 0.055/0.121

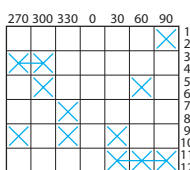

For measurements between 3 phases, with "0" position

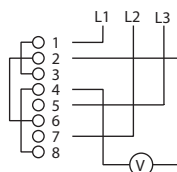

K10D024MCH 0.045/0.099

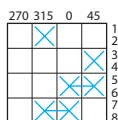

Ammeter switches

For 3 circuits, with "0" position

Wiring diagram and switching programme	Marking and switch position	Reference	Weight kg/lb
--	-----------------------------	-----------	--------------

550263



K10F003MCH

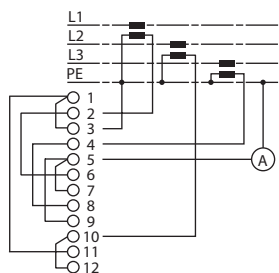

K10F003MCH 0.055/0.121

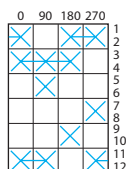

2

Complete switches, 12 and 20 A

- **General**
- Complete switches and adaptable sub-assemblies, 12 and 20 A..... 3/2
- **Front mounting “multi-fixing” or by Ø 22 mm hole, with 45 x 45 mm front plate**
- Switches 3/6
- Stepping switches 3/9
- Reversing and changeover switches 3/15
- Ammeter switches 3/16
- Voltmeter switches 3/18

Cam switches

Complete switches and adaptable sub-assemblies, 12 and 20 A

The cam switch range comprises the equally dimensioned and similar looking products of the K1 (12 A rating) series and K2 (20 A rating) series. Both series feature complete switches and adaptable sub-assemblies for user assembly.

Complete switches

Front mounting

- switches
- stepping switches (2 to 5 step)
- reversing and 1 to 4-pole changeover switches
- ammeter and voltmeter switches

3

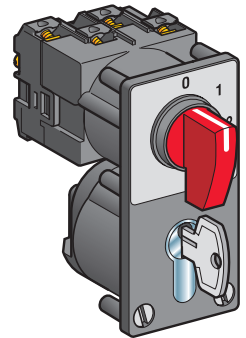
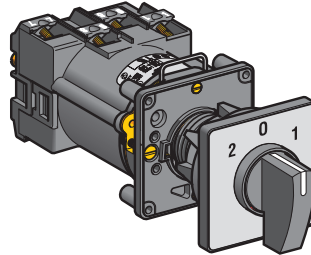
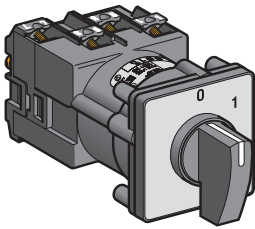

"Multi-fixing"

By Ø 22 mm/0.87 in. hole

Front mounting by 6 screws
Ø 5.2 mm/0.20 in. and
55 x 100 mm/2.16 x 3.94 in.
front plate

K1●●●●●H, K2●●●●●H

See pages 3/6 to 3/13

K1●●●●●H, K2●●●●●H

See pages 3/6 to 3/13

K1●●●●●Z●

See pages 5/2 to 5/7

Switches for user assembly

Front mounting

Body sub-assembly

Head sub-assembly

- With 45 x 45 mm/1.77 x 1.77 in. front plate and 35 mm/1.38 in. handle

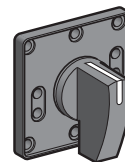
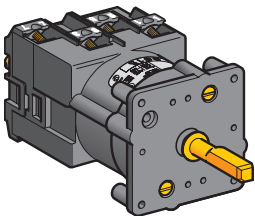

"Multi-fixing"

With blank legend

With marked legend

Without legend

K1●●●●●L, K2●●●●●LL

See pages 4/2 to 4/33

K●G3H

See page 4/34

KCG3H

See page 4/34

KDG3H

See page 4/34

Head sub-assembly

- With 45 x 45 mm/1.77 x 1.77 in. front plate, 35 mm/1.38 in. handle and padlocking device

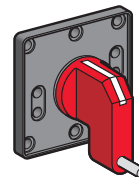

With marked legend

KCG3Y

See page 4/34

Without legend

KDG3Y

See page 4/34

Cam switches

Complete switches and adaptable sub-assemblies, 12 and 20 A

Switches for user assembly (continued)

Front mounting (continued)

Body sub-assembly

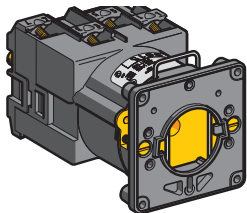

With Ø 22 mm/0.87 in. hole

K1●●●●●●, K2●●●●●●L

See pages 4/2 to 4/33

Head sub-assembly

■ With 45 x 45 mm/ 1.77 x 1.77 in. front plate and 35 mm/1.38 in. handle

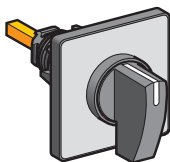

With blank legend

K●C1H

See page 4/34

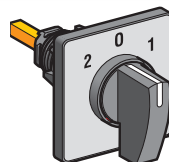

With marked legend (1)

K●C1●●

See page 4/34

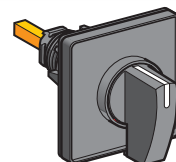

Without legend

KDC1●●

See page 4/34

Head sub-assembly

■ With 45 x 45 mm/1.77 x 1.77 in. front plate and key operator

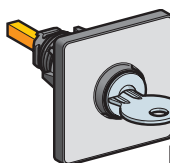

With blank legend

K●C1●

See page 4/34

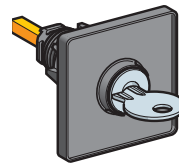

Without legend

KDC1●

See page 4/34

Head sub-assembly

■ With 60 x 60 mm/2.36 x 2.36 in. front plate and 42 mm/1.65 in handle

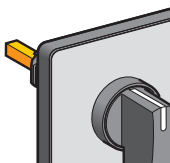

With blank legend

K●D1H

See page 4/34

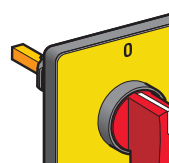

With marked legend

KCD1MH

See page 4/34

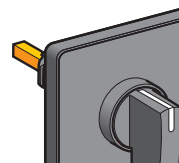

Without legend

KDD1H

See page 4/34

Head sub-assembly

■ With 60 x 60 mm/2.36 x 2.36 in. front plate and key operator

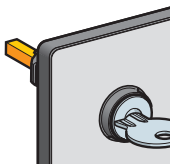

With blank legend

K●D1●

See page 4/35

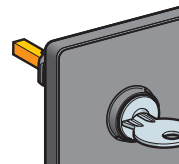

Without legend

KDD1●

See page 4/35

Head sub-assembly

■ Circular with plastic bezel



Key operator

K●A1●

See page 4/35

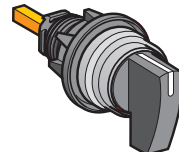

35 mm/1.38 in. handle

K●A1H

See page 4/35

(1) With or without padlocking device.



Cam switches

Complete switches and adaptable sub-assemblies, 12 and 20 A

Switches for user assembly (continued)

Front mounting (continued)

Body sub-assembly

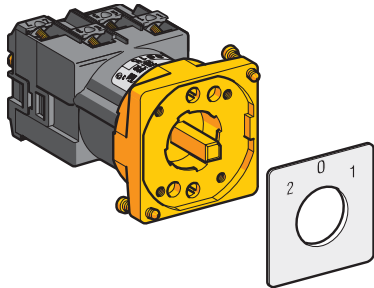

With \varnothing 22 mm/0.87 in. hole and metal mounting plate
K1●●●●●K, K2●●●●●X
 See pages 4/2 to 4/33

Head sub-assembly

- Circular with metal bezel



Standard handle
KAXZ1M1●
 See page 4/35

Long handle
KAXZ1C1●
 See page 4/35

Key operator
KAXZ1S1●●
 See page 4/35

Rear mounting

Body sub-assembly

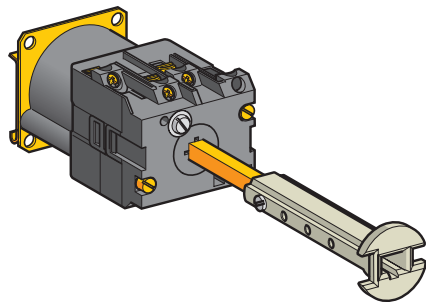

With 4 holes
K1●●●●●, K2●●●●●
 See pages 4/2 to 4/33

Head sub-assembly

- With 45 x 45 mm/1.77 x 1.77 in. front plate and 35 mm/1.38 in. handle

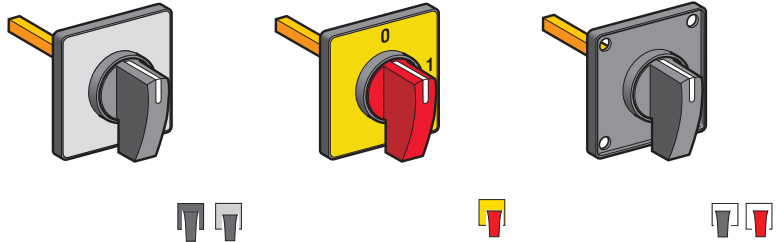

With blank legend
K●E1H
 See page 4/35

With marked legend (1)
KCE1●
 See page 4/35

Without legend
KDE1●
 See page 4/35

Head sub-assembly

- With 60 x 60 mm/2.36 x 2.36 in. front plate and 42 mm/1.65 in handle

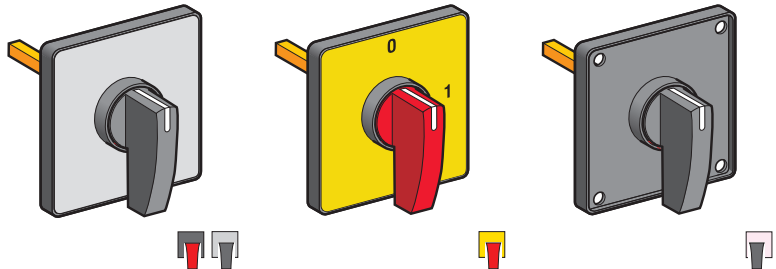

With blank legend
K●F1H
 See page 4/35

With marked legend
KCF1MH
 See page 4/35

Without legend
KDF1H
 See page 4/35

(1) With or without padlocking device.

Accessories

Various accessories complement the K1 - K2 cam switch range: legends, legend holders, terminal covers, seals, etc. See pages 4/36 to 4/41.

Switches with specific schemes

If you cannot find a standard switching programme listed in this catalogue to suit your application, please consult our Customer Care Centre.

Cam switches

Complete switches and adaptable sub-assemblies, 12 and 20 A

The cam switches are available to suit various mounting and fixing methods.

Fixing

Front mounting

By means of "multi-fixing" front plate, using 2 or 4 screws

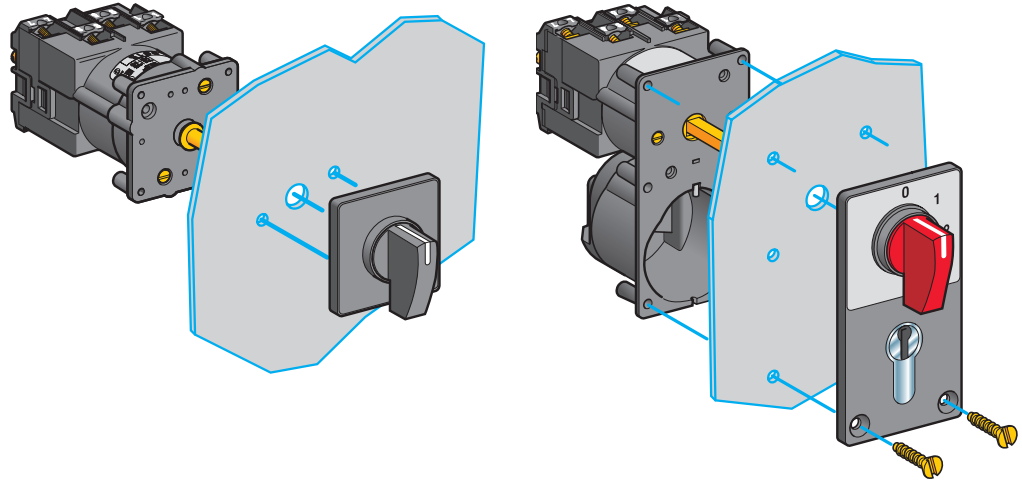
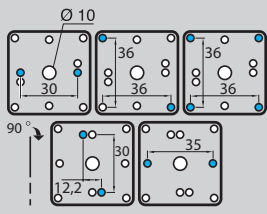

The "multi-fixing" concept enables the switch to be panel mounted using the most commonly used fixing centre dimensions. See drawing to left.

Fixing by 6 screws \varnothing 5.2 mm and 55 x 100 mm front plate.

By means of single \varnothing 22 mm/0.87 in. hole

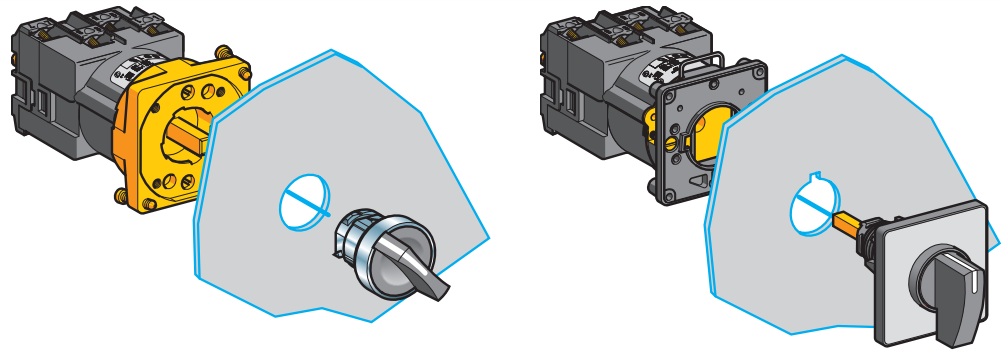

\varnothing 22.5 mm cut-out.
Head attaches to plate using 1/4 turn bayonet locking and secured on panel by 2 needle screws.

\varnothing 22.5 mm cut-out with anti-rotation notch.
Head clips into body and secured on panel by fixing nut.

Rear mounting

By means of 4 holes

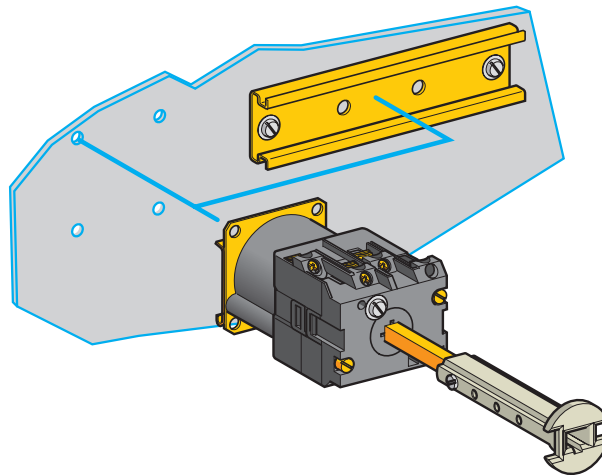

Switch can be directly mounted on backplate using 4 screws.
For DIN rail mounting, an adaptor is available as an accessory. See page 4/41.

Cam switches

Complete switches, 12 and 20 A

Front mounting, "multi-fixing" or by Ø 22 mm hole

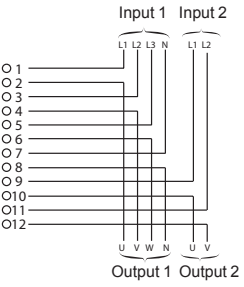
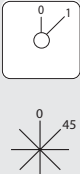
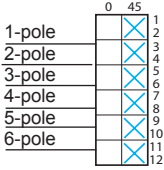
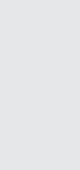

With 45 x 45 mm front plate, 35 mm handle and metallic legend with black marking

Switches with 45° switching angle

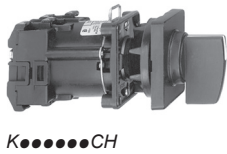
Wiring diagram and switching programme	Marking and switch position	Front mounting method	Number of poles	Thermal current (Ith)	Reference	Weight	
				A			kg/lb
		"Multi-fixing"	1	12	K1A001ALH	0.103/0.227	
				20	K2A001ALH	0.103/0.227	
				2	12	K1B002ALH	0.113/0.249
					20	K2B002ALH	0.113/0.249
				3	12	K1C003ALH	0.133/0.293
					20	K2C003ALH	0.133/0.293
				4	12	K1D004ALH	0.138/0.304
					20	K2D004ALH	0.138/0.304
				5	12	K1E005ALH	0.158/0.348
					20	K2E005ALH	0.158/0.348
				6	12	K1F006ALH	0.168/0.370
					20	K2F006ALH	0.168/0.370
		By Ø 22 mm/ 0.87 in. hole	1	12	K1A001ACH	0.123/0.271	
				20	K2A001ACH	0.123/0.271	
				2	12	K1B002ACH	0.133/0.293
					20	K2B002ACH	0.133/0.293
				3	12	K1C003ACH	0.153/0.337
					20	K2C003ACH	0.153/0.337
				4	12	K1D004ACH	0.158/0.348
					20	K2D004ACH	0.158/0.348
				5	12	K1E005ACH	0.178/0.392
					20	K2E005ACH	0.178/0.392
				6	12	K1F006ACH	0.188/0.414
					20	K2F006ACH	0.188/0.414

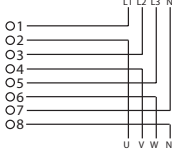

Switches with 90° switching angle

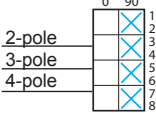
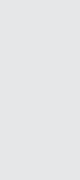
		"Multi-fixing"	2	12	K1B1002HLH	0.130/0.287				
				20	K2B1002HLH	0.130/0.287				
				3	12	K1C003HLH	0.135/0.298			
					20	K2C003HLH	0.135/0.298			
				4	12	K1D004HLH	0.140/0.309			
					20	K2D004HLH	0.140/0.309			
						By Ø 22 mm/ 0.87 in. hole	2	12	K1B1002HCH	0.150/0.331
								20	K2B1002HCH	0.150/0.331
3	12	K1C003HCH	0.155/0.342							
	20	K2C003HCH	0.155/0.342							
4	12	K1D004HCH	0.160/0.353							
	20	K2D004HCH	0.160/0.353							

Cam switches

Complete switches, 12 and 20 A

Front mounting, "multi-fixing" or by Ø 22 mm hole

With 45 x 45 mm front plate, 35 mm handle and metallic legend with black marking

ON-OFF switches with spring return from 30° to "0" position

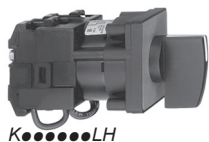

Wiring diagram and switching programme	Marking and switch position	Front mounting method	Number of poles	Thermal current (Ith)	Reference	Weight
				A		kg/lb
		"Multi-fixing"	1	12	K1A002TLH	0.105/0.231
				20	K2A002TLH	0.105/0.231
			By Ø 22 mm/ 0.87 in. hole	12	K1A002TCH	0.125/0.275
				20	K2A002TCH	0.125/0.275

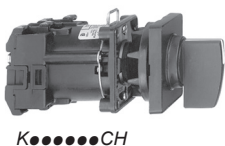

Wiring diagram and switching programme	Marking and switch position	Front mounting method	Number of poles	Thermal current (Ith)	Reference	Weight
		"Multi-fixing"	1	12	K1A001TLH	0.105/0.231
				20	K2A001TLH	0.105/0.231
			By Ø 22 mm/ 0.87 in. hole	12	K1A001TCH	0.125/0.275
				20	K2A001TCH	0.125/0.275

Cam switches

Complete switches, 12 and 20 A

Front mounting, "multi-fixing" or by Ø 22 mm hole

With 45 x 45 mm front plate, 35 mm handle and metallic legend with black marking

OFF-ON switches with spring return from 120° to 90°



Wiring diagram and switching programme	Marking and switch position	Front mounting method	Number of poles	Thermal current (Ith)		Reference	Weight	
				A	kg/lb			
		"Multi-fixing"	1	12		K1B003TLH	0.115/0.253	
				20		K2B003TLH	0.115/0.253	
			By Ø 22 mm/ 0.87 in. hole	1	12		K1B003TCH	0.135/0.298
					20		K2B003TCH	0.135/0.298

3

OFF-ON switches with spring return from 30° and from 330° to "0" position

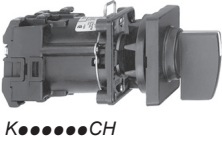

		"Multi-fixing"	1	12		K1B004TLH	0.115/0.253	
				20		K2B004TLH	0.115/0.253	
			By Ø 22 mm/ 0.87 in. hole	1	12		K1B004TCH	0.135/0.298
					20		K2B004TCH	0.135/0.298

Cam switches

Complete switches, 12 and 20 A

Front mounting, "multi-fixing" or by Ø 22 mm hole

With 45 x 45 mm front plate, 35 mm handle and metallic legend with black marking

Stepping switches (2 to 5 step), single-pole, with "0" position



K●●●●●LH

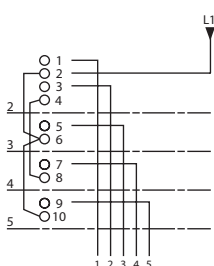

"Multi-fixing"

Thermal current (Ith)	Reference	Weight
12	K1B002QLH	0.115/0.253
20	K2B002QLH	0.115/0.253
12	K1B002QCH	0.135/0.298
20	K2B002QCH	0.135/0.298

By Ø 22 mm/
0.87 in. hole



K●●●●●CH

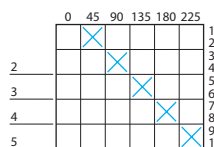

"Multi-fixing"

Thermal current (Ith)	Reference	Weight
12	K1C003QLH	0.135/0.298
20	K2C003QLH	0.135/0.298
12	K1C003QCH	0.155/0.342
20	K2C003QCH	0.155/0.342

By Ø 22 mm/
0.87 in. hole



"Multi-fixing"

Thermal current (Ith)	Reference	Weight
12	K1D004QLH	0.140/0.309
20	K2D004QLH	0.140/0.309
12	K1D004QCH	0.160/0.353
20	K2D004QCH	0.160/0.353

By Ø 22 mm/
0.87 in. hole



"Multi-fixing"

Thermal current (Ith)	Reference	Weight
12	K1E005QLH	0.160/0.353
20	K2E005QLH	0.160/0.353
12	K1E005QCH	0.180/0.397
20	K2E005QCH	0.180/0.397

By Ø 22 mm/
0.87 in. hole









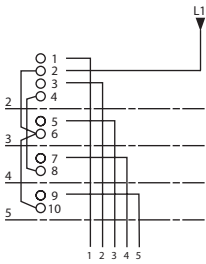

3

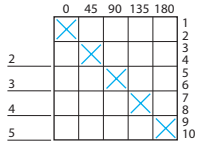
Cam switches

Complete switches, 12 and 20 A

Front mounting, "multi-fixing" or by Ø 22 mm hole

With 45 x 45 mm front plate, 35 mm handle and metallic legend with black marking

Stepping switches (2 to 5 step), single-pole, without "0" position						
Wiring diagram and switching programme	Marking and switch position	Front mounting method	Thermal current (Ith)	Reference	Weight	
			A		kg/lb	
 <p>K●●●●●LH</p>			2 step			
			"Multi-fixing"	12	K1B002NLH	0.115/0.253
				20	K2B002NLH	0.115/0.253
			By Ø 22 mm/ 0.87 in. hole	12	K1B002NCH	0.135/0.298
				20	K2B002NCH	0.135/0.298
			 <p>K●●●●●CH</p>			3 step
"Multi-fixing"	12	K1C003NLH				0.135/0.298
	20	K2C003NLH				0.135/0.298
By Ø 22 mm/ 0.87 in. hole	12	K1C003NCH				0.155/0.342
	20	K2C003NCH				0.155/0.342
						4 step
			"Multi-fixing"	12	K1D004NLH	0.140/0.309
				20	K2D004NLH	0.140/0.309
			By Ø 22 mm/ 0.87 in. hole	12	K1D004NCH	0.160/0.353
				20	K2D004NCH	0.160/0.353
						5 step
"Multi-fixing"	12	K1E005NLH				0.160/0.353
	20	K2E005NLH				0.160/0.353
By Ø 22 mm/ 0.87 in. hole	12	K1E005NCH				0.180/0.397
	20	K2E005NCH				0.180/0.397

3

Cam switches

Complete switches, 12 and 20 A

Front mounting, "multi-fixing" or by Ø 22 mm hole

With 45 x 45 mm front plate, 35 mm handle and metallic legend with black marking

Stepping switches (2 to 5 step), 2-pole, with "0" position



K●●●●●LH

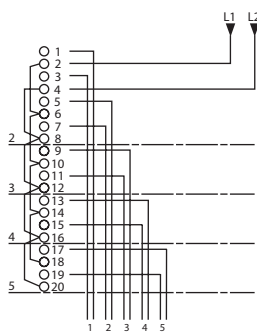

"Multi-fixing"

By Ø 22 mm/
0.87 in. hole

Thermal current (Ith)	Reference	Weight
2 step + "0"		
12	K1D012QLH	0.140/0.309
20	K2D012QLH	0.140/0.309
12	K1D012QCH	0.160/0.353
20	K2D012QCH	0.160/0.353



K●●●●●CH

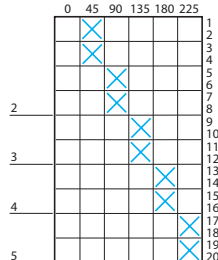

"Multi-fixing"

By Ø 22 mm/
0.87 in. hole

Thermal current (Ith)	Reference	Weight
3 step + "0"		
12	K1F013QLH	0.170/0.374
20	K2F013QLH	0.170/0.374
12	K1F013QCH	0.190/0.419
20	K2F013QCH	0.190/0.419



"Multi-fixing"

By Ø 22 mm/
0.87 in. hole

Thermal current (Ith)	Reference	Weight
4 step + "0"		
12	K1H014QLH	0.195/0.430
20	K2H014QLH	0.195/0.430
12	K1H014QCH	0.215/0.474
20	K2H014QCH	0.215/0.474



"Multi-fixing"

By Ø 22 mm/
0.87 in. hole

Thermal current (Ith)	Reference	Weight
5 step + "0"		
12	K1K015QLH	0.225/0.496
20	K2K015QLH	0.225/0.496
12	K1K015QCH	0.245/0.540
20	K2K015QCH	0.245/0.540







Cam switches

Complete switches, 12 and 20 A

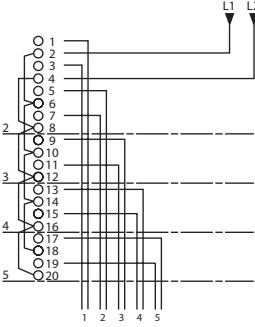
Front mounting, "multi-fixing" or by Ø 22 mm hole

With 45 x 45 mm front plate, 35 mm handle and metallic legend with black marking

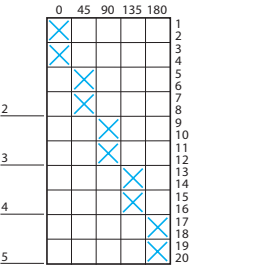
Stepping switches (2 to 5 step), 2-pole, without "0" position

Wiring diagram and switching programme	Marking and switch position	Front mounting method	Thermal current (Ith)		Reference	Weight
			A	kg/lb		
 K...LH 	 	"Multi-fixing" By Ø 22 mm/ 0.87 in. hole	2 step			
			12	K1D012NLH	0.140/0.309	
			20	K2D012NLH	0.140/0.309	
			12	K1D012NCH	0.160/0.353	
			20	K2D012NCH	0.160/0.353	
			3 step			
			12	K1F013NLH	0.170/0.374	
			20	K2F013NLH	0.170/0.374	
			12	K1F013NCH	0.190/0.419	
			20	K2F013NCH	0.190/0.419	
 K...CH 	 	"Multi-fixing" By Ø 22 mm/ 0.87 in. hole	4 step			
			12	K1H014NLH	0.195/0.430	
			20	K2H014NLH	0.195/0.430	
			12	K1H014NCH	0.215/0.474	
			20	K2H014NCH	0.215/0.474	
			5 step			
			12	K1K015NLH	0.225/0.496	
			20	K2K015NLH	0.225/0.496	
			12	K1K015NCH	0.245/0.540	
			20	K2K015NCH	0.245/0.540	

3

Cam switches

Complete switches, 12 and 20 A

Front mounting, "multi-fixing" or by Ø 22 mm hole

With 45 x 45 mm front plate, 35 mm handle and metallic legend with black marking

Stepping switches (2 and 3 step), 3-pole, with "0" position



K.....LH

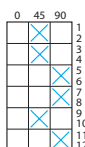
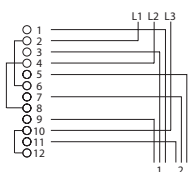

"Multi-fixing"

By Ø 22 mm/
0.87 in. hole

2 step + "0"

Thermal current (Ith)	Reference	Weight
12	K1F022QLH	0.170/0.374
20	K2F022QLH	0.170/0.374
12	K1F022QCH	0.190/0.419
20	K2F022QCH	0.190/0.419



K.....CH

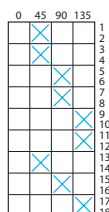
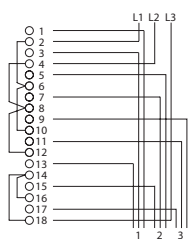

"Multi-fixing"

By Ø 22 mm/
0.87 in. hole

3 step + "0"

Thermal current (Ith)	Reference	Weight
12	K1I023QLH	0.215/0.474
20	K2I023QLH	0.215/0.474
12	K1I023QCH	0.235/0.518
20	K2I023QCH	0.235/0.518



Cam switches

Complete switches, 12 and 20 A

Front mounting, "multi-fixing" or by Ø 22 mm hole

With 45 x 45 mm front plate, 35 mm handle and metallic legend with black marking

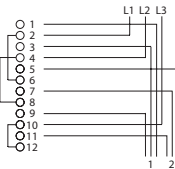
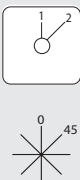
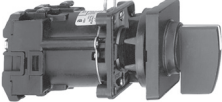
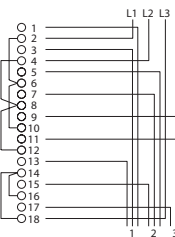
Stepping switches (2 and 3 step), 3-pole, without "0" position

Wiring diagram and switching programme	Marking and switch position	Front mounting method	Thermal current (Ith)	Reference	Weight
			A		
 <p>K●●●●●LH</p>			"Multi-fixing"		
			2 step		
			12	K1F022NLH	0.170/0.374
			20	K2F022NLH	0.170/0.374
			By Ø 22 mm/ 0.87 in. hole		
			12	K1F022NCH	0.190/0.419
 <p>K●●●●●CH</p>			"Multi-fixing"		
			3 step		
			12	K1I023NLH	0.215/0.474
			20	K2I023NLH	0.215/0.474
			By Ø 22 mm/ 0.87 in. hole		
			12	K1I023NCH	0.235/0.518

3

Cam switches

Complete switches, 12 and 20 A

Front mounting, "multi-fixing" or by Ø 22 mm hole

With 45 x 45 mm front plate, 35 mm handle and metallic legend with black marking



K.....LH

Reversing switches with spring return from 315° and from 45° to "0" position						
Wiring diagram and switching programme	Marking and switch position	Front mounting method	Number of poles	Thermal current (Ith)	Reference	Weight
				A		
		"Multi-fixing"	1	12	K1B006TLH	0.115/0.253
				20	K2B006TLH	0.115/0.253
			By Ø 22 mm/ 0.87 in. hole	12	K1B006TCH	0.135/0.298
				20	K2B006TCH	0.135/0.298

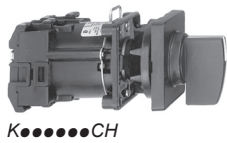

K.....CH

Changeover switches, 1 to 4-pole							
Wiring diagram and switching programme	Marking and switch position	Front mounting method	Number of poles	With "0" position		Weight	
				Thermal current (Ith)	Reference		
		"Multi-fixing"	1	12	K1B001ULH	0.115/0.253	
				20	K2B001ULH	0.115/0.253	
			2	12	K1D002ULH	0.140/0.309	
				20	K2D002ULH	0.140/0.309	
			3	12	K1F003ULH	0.170/0.374	
				20	K2F003ULH	0.170/0.374	
			4	12	K1H004ULH	0.195/0.430	
				20	K2H004ULH	0.195/0.430	
			By Ø 22 mm/ 0.87 in. hole	1	12	K1B001UCH	0.135/0.298
					20	K2B001UCH	0.135/0.298
				2	12	K1D002UCH	0.160/0.353
					20	K2D002UCH	0.160/0.353
				3	12	K1F003UCH	0.190/0.419
					20	K2F003UCH	0.190/0.419
				4	12	K1H004UCH	0.215/0.474
					20	K2H004UCH	0.215/0.474
		"Multi-fixing"	1	Without "0" position		Weight	
				12	K1B011ULH		0.115/0.253
			2	20	K2B011ULH	0.115/0.253	
				12	K1D012ULH	0.140/0.309	
			3	20	K2D012ULH	0.140/0.309	
				12	K1F013ULH	0.170/0.374	
			4	20	K2F013ULH	0.170/0.374	
				12	K1H014ULH	0.195/0.430	
			20	K2H014ULH	0.195/0.430		
				By Ø 22 mm/ 0.87 in. hole	1	12	K1B011UCH
			20			K2B011UCH	0.135/0.298
			2		12	K1D012UCH	0.160/0.353
					20	K2D012UCH	0.160/0.353
			3		12	K1F013UCH	0.190/0.419
					20	K2F013UCH	0.190/0.419
			4		12	K1H014UCH	0.215/0.474
20	K2H014UCH	0.215/0.474					

Cam switches

Complete switches, 12 A

Front mounting, "multi-fixing" or by Ø 22 mm hole

With 45 x 45 mm front plate, 35 mm handle and metallic legend with black marking

Ammeter switches

Wiring diagram and switching programme	Marking and switch position	Front mounting method	Thermal current (Ith)	Reference	Weight
			A		kg/lb

For 3 circuits

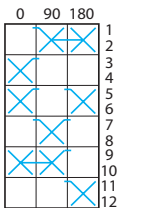
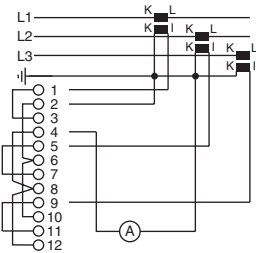
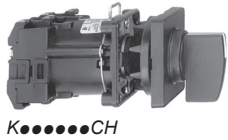
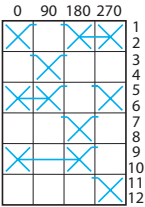
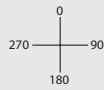
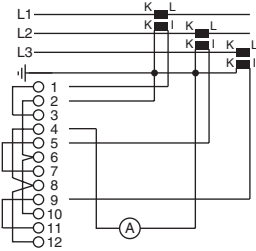

"Multi-fixing"	With "0" position		
	12	K1F003MLH	0.170/0.374

By Ø 22 mm/ 0.87 in. hole	12	K1F003MCH	0.190/0.419
------------------------------	----	-----------	-------------

"Multi-fixing"	Without "0" position		
	12	K1F013MLH	0.170/0.374







By Ø 22 mm/ 0.87 in. hole	12	K1F013MCH	0.190/0.419
------------------------------	----	-----------	-------------

Cam switches

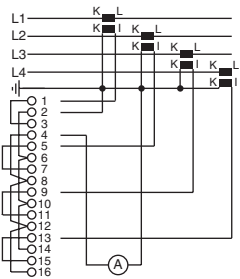
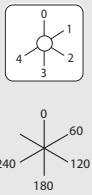
Complete switches, 12 A

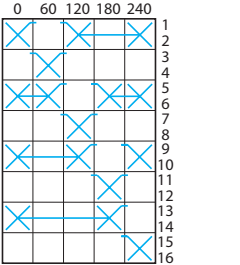
Front mounting, "multi-fixing" or by Ø 22 mm hole

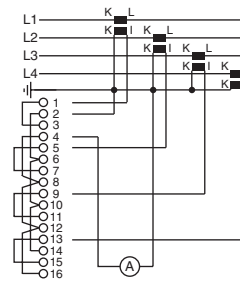
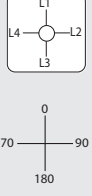
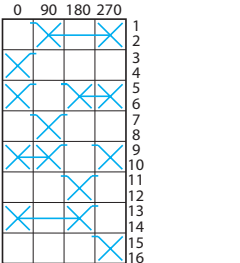
With 45 x 45 mm front plate, 35 mm handle and metallic legend with black marking







Ammeter switches (continued)					
Wiring diagram and switching programme	Marking and switch position	Front mounting method	Thermal current (Ith)	Reference	Weight
			A		kg/lb
For 4 circuits					
 <p>K●●●●●LH</p>			With "0" position		
			"Multi-fixing"	12	K1H004MLH
 <p>K●●●●●CH</p>			By Ø 22 mm/ 0.87 in. hole		
			"Multi-fixing"	12	K1H004MCH
			Without "0" position		
		By Ø 22 mm/ 0.87 in. hole			
		"Multi-fixing"	12	K1H014MLH	0.195/0.430
		By Ø 22 mm/ 0.87 in. hole			
		"Multi-fixing"	12	K1H014MCH	0.215/0.474

Cam switches

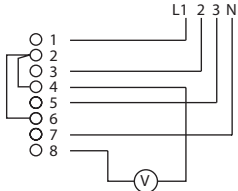
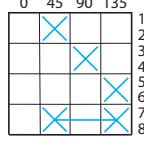
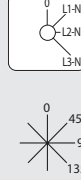
Complete switches, 12 A

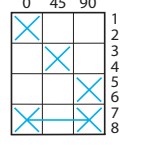
Front mounting, "multi-fixing" or by Ø 22 mm hole

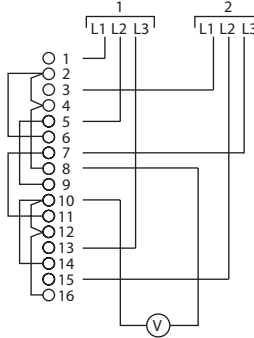
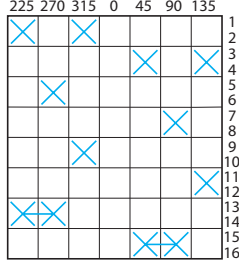
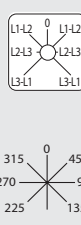
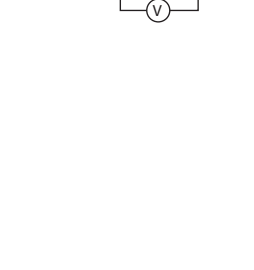
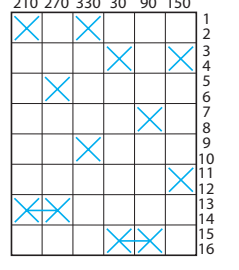
With 45 x 45 mm front plate, 35 mm handle and metallic legend with black marking

Voltmeter switches						
Wiring diagram	Switching programme	Marking and switch position	Front mounting method	Thermal current (Ith)	Reference	Weight
				A		kg/lb
For measurements between 3 phases and neutral						
 <p>K●●●●●LH</p>			With "0" position			
			"Multi-fixing" 12	K1D023MLH	0.140/0.309	
				By Ø 22 mm/ 0.87 in. hole	12	K1D023MCH 0.160/0.353
 <p>K●●●●●CH</p>			Without "0" position			
			"Multi-fixing" 12	K1D033MLH	0.140/0.309	
				By Ø 22 mm/ 0.87 in. hole	12	K1D033MCH 0.160/0.353
For measurements between 3 phases of 2 supplies						
			With "0" position			
			"Multi-fixing" 12	K1H026MLH	0.205/0.452	
				By Ø 22 mm/ 0.87 in. hole	12	K1H026MCH 0.215/0.474
			Without "0" position			
			"Multi-fixing" 12	K1H036MLH	0.205/0.452	
				By Ø 22 mm/ 0.87 in. hole	12	K1H036MCH 0.215/0.474







3

Cam switches

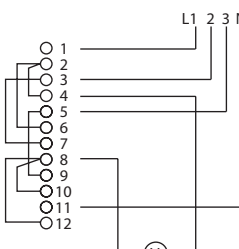
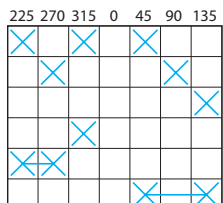
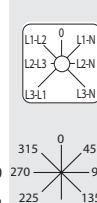
Complete switches, 12 A

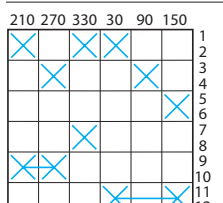
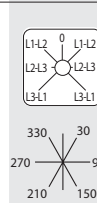
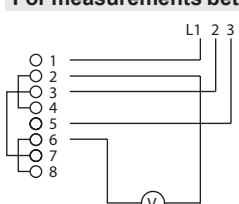
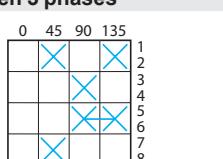
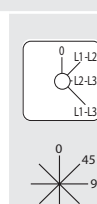
Front mounting, "multi-fixing" or by Ø 22 mm hole

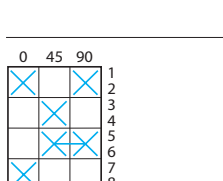
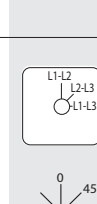
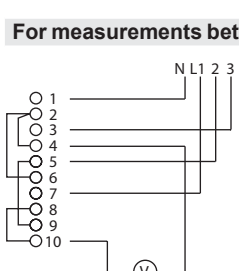
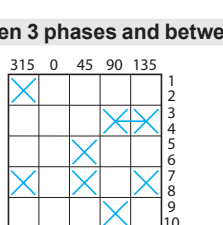
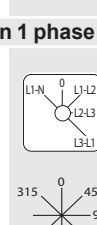
With 45 x 45 mm front plate, 35 mm handle and metallic legend with black marking

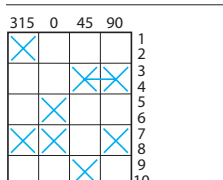
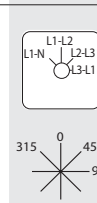
Voltmeter switches (continued)						
Wiring diagram	Switching programme	Marking and switch position	Front mounting method	Thermal current (Ith)	Reference	Weight
				A		kg/lb
For measurements between 3 phases and between each of the 3 phases and neutral						
			"Multi-fixing"	12	K1F027MLH	0.170/0.374
				12	K1F027MCH	0.190/0.419
			"Multi-fixing"	12	K1F037MLH	0.170/0.374
				12	K1F037MCH	0.190/0.419
For measurements between 3 phases						
			"Multi-fixing"	12	K1D024MLH	0.140/0.309
				12	K1D024MCH	0.160/0.353
			"Multi-fixing"	12	K1D034MLH	0.140/0.309
				12	K1D034MCH	0.160/0.353
For measurements between 3 phases and between 1 phase and neutral						
			"Multi-fixing"	12	K1E025MLH	0.160/0.353
				12	K1E025MCH	0.180/0.397
			"Multi-fixing"	12	K1E035MLH	0.160/0.353
				12	K1E035MCH	0.180/0.397



K●●●●●LH



K●●●●●CH

Adaptable sub-assemblies, 12 and 20 A

■ Bodies (contact blocks + fixing plate)

- Switches 4/2
- Changeover switches 4/6
- Reversing switches..... 4/8
- Encoded output switches 4/9
- Paralleling switches 4/12
- Stepping switches..... 4/14
- Ammeter switches 4/24
- Voltmeter switches..... 4/25
- Multi-circuit switches..... 4/28
- Reversing switches..... 4/29
- Star-delta switches and reversing star-delta switches 4/30
- Pole change switches and reversing pole change switches..... 4/31

■ Operating heads

- For “multi-fixing” or Ø 22 mm hole, front mounting bodies 4/34
- For 4 hole, rear mounting bodies 4/35

■ Legends

- For “multi-fixing” heads..... 4/36
- For Ø 22 mm hole mounting heads with plastic bezel 4/37
- For Ø 22 mm hole mounting heads with chromium plated metal bezel..... 4/38
- Legend holders for heads 4/39
- Separate components and accessories 4/40













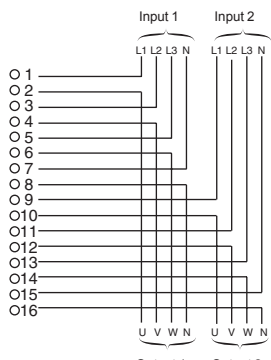

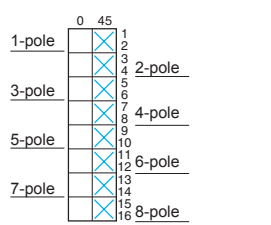

Cam switches

Adaptable sub-assemblies, 12 and 20 A

Bodies (contact blocks + fixing plate)

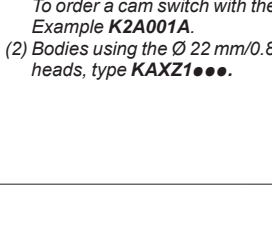
To combine with operating heads:
see page 4/34

Switches with 45° switching angle

Wiring diagram and switching programme	Switch position	Mounting method	Reference to be completed (1)	Weight kg/lb			
		Front	Multi-fixing	K●A001AL	0.091/0.201		
			By Ø 22 mm/0.87 in. hole	K●A001A	0.075/0.165		
		Rear		K●A001AX (2)	0.153/0.337		
				K●A501A	0.115/0.253		
				Front	Multi-fixing	K●B002AL	0.101/0.223
					By Ø 22 mm/0.87 in. hole	K●B002A	0.085/0.187
Rear				K●B002AX (2)	0.163/0.359		
				K●B502A	0.125/0.275		
				Front	Multi-fixing	K●C003AL	0.121/0.267
					By Ø 22 mm/0.87 in. hole	K●C003A	0.105/0.231
		Rear		K●C003AX (2)	0.183/0.403		
				K●C503A	0.140/0.309		
				Front	Multi-fixing	K●D004AL	0.126/0.278
					By Ø 22 mm/0.87 in. hole	K●D004A	0.110/0.242
Rear				K●D004AX (2)	0.188/0.414		
				K●D504A	0.150/0.331		
				Front	Multi-fixing	K●E005AL	0.146/0.322
					By Ø 22 mm/0.87 in. hole	K●E005A	0.130/0.287
		Rear		K●E005AX (2)	0.208/0.458		
				K●E505A	0.165/0.364		
				Front	Multi-fixing	K●F006AL	0.156/0.344
					By Ø 22 mm/0.87 in. hole	K●F006A	0.140/0.309
Rear				K●F006AX (2)	0.218/0.481		
				K●F506A	0.175/0.386		
				Front	Multi-fixing	K●G007AL	0.176/0.388
					By Ø 22 mm/0.87 in. hole	K●G007A	0.160/0.353
		Rear		K●G007A	0.160/0.353		
				K●G507A	0.190/0.419		
				Front	Multi-fixing	K●H008AL	0.181/0.399
					By Ø 22 mm/0.87 in. hole	K●H008A	0.165/0.364
Rear				K●H008A	0.165/0.364		
				K●H508A	0.195/0.430		

(1) To order a cam switch with thermal current $I_{th} = 12$ A, replace the ● in the reference by 1.
Example **K1A001A**.

To order a cam switch with thermal current $I_{th} = 20$ A, replace the ● in the reference by 2.
Example **K2A001A**.

(2) Bodies using the Ø 22 mm/0.87 in. hole mounting method that can be fitted with chromium plated metal bezel operating heads, type **KAXZ1●●●**.







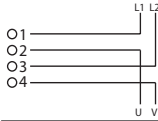

Cam switches

Adaptable sub-assemblies, 12 and 20 A

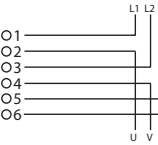
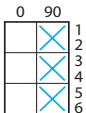
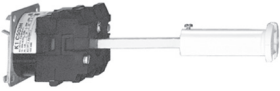
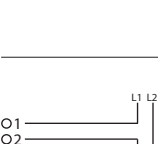
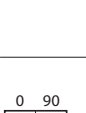
Bodies (contact blocks + fixing plate)

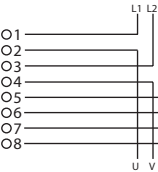
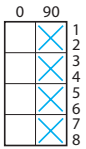
To combine with operating heads:
see page 4/34

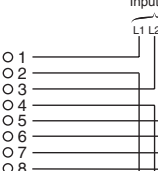
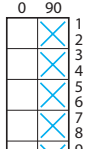
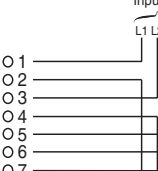
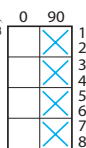
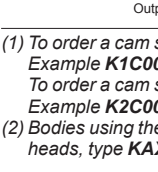
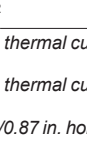
Switches with 90° switching angle

Wiring diagram	Switching programme	Switch position	Mounting method	Reference to be completed (1)	Weight kg/lb	
 K●●0●●●L			2-pole			
			Front	Multi-fixing	K●B1002HL	0.121/0.267
			By Ø 22 mm/0.87 in. hole		K●B1002H	0.105/0.231
			Rear		K●B1002HX (2)	0.183/0.403
 K●C003●●			3-pole			
			Front	Multi-fixing	K●C003HL	0.121/0.267
			By Ø 22 mm/0.87 in. hole		K●C003H	0.105/0.231
			Rear		K●C003HX (2)	0.183/0.403
					K●C503H	0.140/0.309
 K●C023●●			3-pole with neutral wire terminal and Earth terminal			
			Front	Multi-fixing	K●C023HL	0.121/0.267
			By Ø 22 mm/0.87 in. hole		K●C023H	0.105/0.231
			Rear		K●C023HX (2)	0.183/0.403
					K●C523H	0.140/0.309
 K●D004●●			4-pole			
			Front	Multi-fixing	K●D004HL	0.126/0.278
			By Ø 22 mm/0.87 in. hole		K●D004H	0.110/0.242
			Rear		K●D004HX (2)	0.188/0.414
					K●D504H	0.150/0.331
 K●D024●●			4-pole with neutral wire terminal and Earth terminal			
			Front	Multi-fixing	K●D024HL	0.126/0.278
			By Ø 22 mm/0.87 in. hole		K●D024H	0.110/0.242
			Rear		K●D024HX (2)	0.188/0.414
					K●D524H	0.150/0.331
 K●E005●●			5-pole			
			Front	Multi-fixing	K●E005HL	0.146/0.322
			By Ø 22 mm/0.87 in. hole		K●E005H	0.130/0.287
			Rear		K●E005HX (2)	0.208/0.458
					K●E505H	0.165/0.364
 K●E025●●			5-pole with neutral wire terminal and Earth terminal			
			Front	Multi-fixing	K●E025HL	0.146/0.322
			By Ø 22 mm/0.87 in. hole		K●E025H	0.130/0.287
			Rear		K●E525H	0.165/0.364
 K●F006●●			6-pole			
			Front	Multi-fixing	K●F006HL	0.156/0.344
			By Ø 22 mm/0.87 in. hole		K●F006H	0.140/0.309
			Rear		K●F006HX (2)	0.218/0.481
					K●F506H	0.175/0.386
 K●F026●●			6-pole with neutral wire terminal and Earth terminal			
			Front	Multi-fixing	K●F026HL	0.156/0.344
			By Ø 22 mm/0.87 in. hole		K●F026H	0.140/0.309
			Rear		K●F526H	0.175/0.386

(1) To order a cam switch with thermal current $I_{th} = 12 A$, replace the ● in the reference by 1.

Example **K1C003H**.

To order a cam switch with thermal current $I_{th} = 20 A$, replace the ● in the reference by 2.

Example **K2C003H**.

(2) Bodies using the Ø 22 mm/0.87 in. hole mounting method that can be fitted with chromium plated metal bezel operating heads, type **KAXZ1●●●**.

Cam switches

Adaptable sub-assemblies, 12 and 20 A

Bodies (contact blocks + fixing plate)

To combine with operating heads:
see page 4/34

OFF-ON switches with 45° switching angle

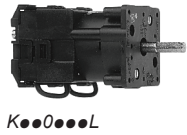

Wiring diagram	Switching programme	Switch position	Mounting method	Reference to be completed (1)	Weight kg/lb
			Front Multi-fixing	K●A001AL	0.091/0.201
			By Ø 22 mm/0.87 in. hole	K●A001A	0.075/0.165
			Rear	K●A001AX (2)	0.153/0.337
				K●A501A	0.115/0.253

OFF-ON switches with spring return from 30° to "0" position



Wiring diagram	Switching programme	Switch position	Mounting method	Reference to be completed (1)	Weight kg/lb
			Front Multi-fixing	K●A001TL	0.091/0.201
			By Ø 22 mm/0.87 in. hole	K●A001T	0.075/0.165
			Rear	K●A001TX (2)	0.153/0.337
				K●A501T	0.115/0.253

ON-OFF switches with spring return from 30° to "0" position

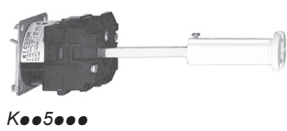

Wiring diagram	Switching programme	Switch position	Mounting method	Reference to be completed (1)	Weight kg/lb
			Front Multi-fixing	K●A002TL	0.091/0.201
			By Ø 22 mm/0.87 in. hole	K●A002T	0.075/0.165
			Rear	K●A002TX (2)	0.153/0.337
				K●A502T	0.115/0.253

OFF-ON switches with spring return from 120° to 90°



Wiring diagram	Switching programme	Switch position	Mounting method	Reference to be completed (1)	Weight kg/lb
			Front Multi-fixing	K●B003TL	0.101/0.223
			By Ø 22 mm/0.87 in. hole	K●B003T	0.085/0.187
			Rear	K●B503T	0.125/0.275

(1) To order a cam switch with thermal current I_{th} = 12 A, replace the ● in the reference by 1.

Example **K1A001A**.

To order a cam switch with thermal current I_{th} = 20 A, replace the ● in the reference by 2.

Example **K2A001A**.

(2) Bodies using the Ø 22 mm/0.87 in. hole mounting method that can be fitted with chromium plated metal bezel operating heads, type **KAXZ1●●●**.

Cam switches

Adaptable sub-assemblies, 12 and 20 A

Bodies (contact blocks + fixing plate)

To combine with operating heads:
see page 4/34

OFF-ON switches with spring return from 30° and from 330° to "0" position



K●●0●●●L

Wiring diagram and switching programme	Switch position	Mounting method	Reference to be completed (1)	Weight kg/lb	
		Front	Multi-fixing	0.101/0.223	
			By Ø 22 mm/0.87 in. hole	K●B004TL	0.085/0.187
		Rear		K●B504T	0.115/0.253

OFF-ON switches with momentary-contact function



K●●0●●●

Wiring diagram and switching programme	Switch position	Mounting method	Reference to be completed (1)	Weight kg/lb	
		Front	Multi-fixing	0.101/0.223	
			By Ø 22 mm/0.87 in. hole	K●B001DL	0.085/0.187
		Rear		K●B001DX (2)	0.163/0.359
			K●B501D	0.125/0.275	

OFF-ON changeover switches with spring return from 240° to 270° and from 120° to 90°



K●●5●●●



K●●0●●●X

Wiring diagram and switching programme	Switch position	Mounting method	Reference to be completed (1)	Weight kg/lb	
		Front	Multi-fixing	0.126/0.278	
			By Ø 22 mm/0.87 in. hole	K●D005TL	0.110/0.242
		Rear		K●D505T	0.150/0.331

(1) To order a cam switch with thermal current I_{th} = 12 A, replace the ● in the reference by 1.

Example K1B004T.

To order a cam switch with thermal current I_{th} = 20 A, replace the ● in the reference by 2.

Example K2B004T.

(2) Bodies using the Ø 22 mm/0.87 in. hole mounting method that can be fitted with chromium plated metal bezel operating heads, type KAXZ1●●●.

Cam switches

Adaptable sub-assemblies, 12 and 20 A

Bodies (contact blocks + fixing plate)

To combine with operating heads:
see page 4/34

Changeover switches with "0" position

Wiring diagram and switching programme	Switch position	Mounting method	Reference to be completed (1)	Weight kg/lb
--	-----------------	-----------------	-------------------------------	--------------

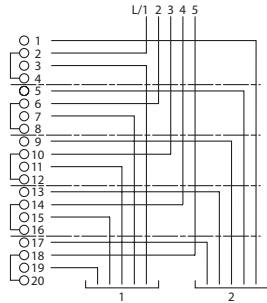
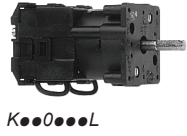

1-pole					
Front	Multi-fixing	By \varnothing 22 mm/0.87 in. hole	K●B001UL	0.101/0.223	
			K●B001U	0.085/0.187	
Rear			K●B001UX (2)	0.163/0.359	
			K●B501U	0.125/0.275	

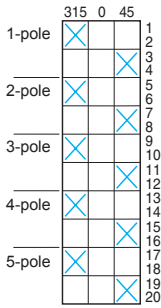

2-pole					
Front	Multi-fixing	By \varnothing 22 mm/0.87 in. hole	K●D002UL	0.126/0.278	
			K●D002U	0.110/0.242	
Rear			K●D002UX (2)	0.188/0.414	
			K●D502U	0.150/0.331	

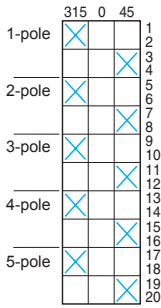
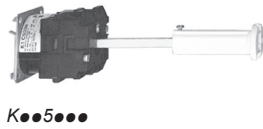

3-pole					
Front	Multi-fixing	By \varnothing 22 mm/0.87 in. hole	K●F003UL	0.156/0.344	
			K●F003U	0.140/0.309	
Rear			K●F003UX (2)	0.218/0.481	
			K●F503U	0.175/0.386	



4-pole					
Front	Multi-fixing	By \varnothing 22 mm/0.87 in. hole	K●H004UL	0.181/0.399	
			K●H004U	0.165/0.364	
Rear			K●H004UX (2)	0.243/0.536	
			K●H504U	0.195/0.430	

5-pole					
Front	Multi-fixing	By \varnothing 22 mm/0.87 in. hole	K●K005UL	0.211/0.465	
			K●K005U	0.195/0.430	
Rear			K●K005UX (2)	0.273/0.602	
			K●K505U	0.210/0.463	

(1) To order a cam switch with thermal current $I_{th} = 12$ A, replace the ● in the reference by 1.
Example **K1B001U**.
To order a cam switch with thermal current $I_{th} = 20$ A, replace the ● in the reference by 2.
Example **K2B001U**.
(2) Bodies using the \varnothing 22 mm/0.87 in. hole mounting method that can be fitted with chromium plated metal bezel operating heads, type **KAXZ1●●●**.

Cam switches

Adaptable sub-assemblies, 12 and 20 A

Bodies (contact blocks + fixing plate)

To combine with operating heads:
see page 4/34

Changeover switches without "0" position

Wiring diagram and switching programme	Switch position	Mounting method	Reference to be completed (1)	Weight kg/lb
	1-pole	Front Multi-fixing By Ø 22 mm/0.87 in. hole	K●B011UL K●B011U K●B011UX (2)	0.101/0.223 0.085/0.187 0.163/0.359
	Rear	K●B511U	0.125/0.275	
	2-pole	Front Multi-fixing By Ø 22 mm/0.87 in. hole	K●D012UL K●D012U K●D012UX (2)	0.126/0.278 0.110/0.242 0.188/0.414
	Rear	K●D512U	0.150/0.331	
	3-pole	Front Multi-fixing By Ø 22 mm/0.87 in. hole	K●F013UL K●F013U K●F013UX (2)	0.156/0.344 0.140/0.309 0.218/0.481
	Rear	K●F513U	0.175/0.386	
	4-pole	Front Multi-fixing By Ø 22 mm/0.87 in. hole	K●H014UL K●H014U K●H014UX (2)	0.181/0.399 0.165/0.364 0.243/0.536
	Rear	K●H514U	0.195/0.430	
	5-pole	Front Multi-fixing By Ø 22 mm/0.87 in. hole	K●K015UL K●K015U K●K015UX (2)	0.211/0.465 0.195/0.430 0.273/0.602
	Rear	K●K515U	0.220/0.485	

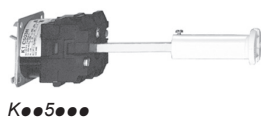
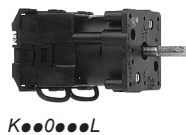

(1) To order a cam switch with thermal current $I_{th} = 12 A$, replace the ● in the reference by 1.

Example **K1B011U**.

To order a cam switch with thermal current $I_{th} = 20 A$, replace the ● in the reference by 2.

Example **K2B011U**.











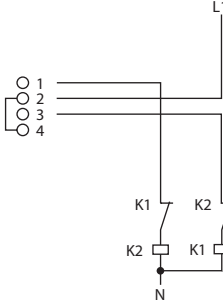

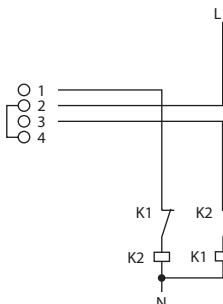

(2) Bodies using the Ø 22 mm/0.87 in. hole mounting method that can be fitted with chromium plated metal bezel operating heads, type **KAXZ1●●●**.

Cam switches

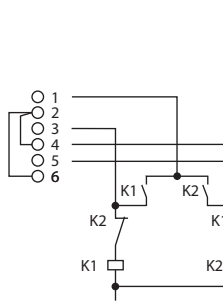
Adaptable sub-assemblies, 12 and 20 A

Bodies (contact blocks + fixing plate)

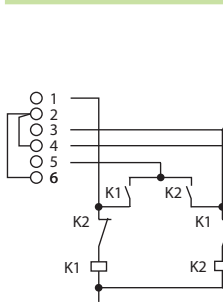
To combine with operating heads:
see page 4/34

Reversing switches with "0" position					
Wiring diagram	Switching programme	Switch position	Mounting method	Reference to be completed (1)	Weight kg/lb
 <p>K●●0●●●L</p> 			Front	Multi-fixing	K●B001UL 0.101/0.223
				By Ø 22 mm/ 0.87 in. hole	K●B001U 0.085/0.187
					K●B001UX (2) 0.163/0.359
			Rear		K●B501U 0.125/0.275
Reversing switches with spring return from 315° and from 45° to "0" position					
Wiring diagram	Switching programme	Switch position	Mounting method	Reference to be completed (1)	Weight kg/lb
 <p>K●●0●●●</p> 			Front	Multi-fixing	K●B006TL 0.101/0.223
				By Ø 22 mm/ 0.87 in. hole	K●B006T 0.085/0.187
					K●B006TX (2) 0.163/0.359
			Rear		K●B506T 0.125/0.275
Reversing switches with momentary-contact function					
Wiring diagram	Switching programme	Switch position	Mounting method	Reference to be completed (1)	Weight kg/lb
 <p>K●●5●●●</p> 			Front	Multi-fixing	K●C002DL 0.121/0.267
				By Ø 22 mm/ 0.87 in. hole	K●C002D 0.105/0.231
					K●C002DX (2) 0.183/0.403
			Rear		K●C502D 0.140/0.309
Reversing switches with spring return from 240° to 270° and from 120° to 90° position					
Wiring diagram	Switching programme	Switch position	Mounting method	Reference to be completed (1)	Weight kg/lb
 <p>K●●0●●●X</p> 			Front	Multi-fixing	K●C007TL 0.121/0.267
				By Ø 22 mm/ 0.87 in. hole	K●C007T 0.105/0.231
					K●C507T 0.140/0.309
			Rear		K●C507T 0.140/0.309

(1) To order a cam switch with thermal current $I_{th} = 12 A$, replace the ● in the reference by 1.
Example **K1B001U**.

To order a cam switch with thermal current $I_{th} = 20 A$, replace the ● in the reference by 2.
Example **K2B001U**.

(2) Bodies using the Ø 22 mm/0.87 in. hole mounting method that can be fitted with chromium plated metal bezel operating heads, type **KAXZ1●●●**.

Cam switches

Adaptable sub-assemblies, 12 A

Bodies (contact blocks + fixing plate)

To combine with operating heads:
see page 4/34

BCD encoded output switches with "0" position

Wiring diagram	Switching programme	Switch position	Mounting method	Reference (1)	Weight kg/lb	
			Front	Multi-fixing By Ø 22 mm/ 0.87 in. hole	K1A001BL K1A001B K1A001BX (2)	0.101/0.223 0.085/0.187 0.163/0.359
			Rear		K1A501B	0.125/0.275
			Front	Multi-fixing By Ø 22 mm/ 0.87 in. hole	K1B002BL K1B002B K1B002BX (2)	0.101/0.223 0.085/0.187 0.163/0.359
			Rear		K1B502B	0.125/0.275
			Front	Multi-fixing By Ø 22 mm/ 0.87 in. hole	K1B003BL K1B003B K1B003BX (2)	0.101/0.223 0.085/0.187 0.163/0.359
			Rear		K1B503B	0.125/0.275
			Front	Multi-fixing By Ø 22 mm/ 0.87 in. hole	K1C004BL K1C004B K1C004BX (2)	0.121/0.267 0.105/0.231 0.183/0.403
			Rear		K1C504B	0.140/0.309
			Front	Multi-fixing By Ø 22 mm/ 0.87 in. hole	K1C005BL K1C005B K1C005BX (2)	0.121/0.267 0.105/0.231 0.183/0.403
			Rear		K1C505B	0.140/0.309
			Front	Multi-fixing By Ø 22 mm/ 0.87 in. hole	K1C006BL K1C006B K1C006BX (2)	0.121/0.267 0.105/0.231 0.183/0.403
			Rear		K1C506B	0.140/0.309
			Front	Multi-fixing By Ø 22 mm/ 0.87 in. hole	K1C007BL K1C007B K1C007BX (2)	0.121/0.267 0.105/0.231 0.183/0.403
			Rear		K1C507B	0.140/0.309
			Front	Multi-fixing By Ø 22 mm/ 0.87 in. hole	K1D008BL K1D008B K1D008BX (2)	0.126/0.278 0.110/0.242 0.188/0.414
			Rear		K1D508B	0.150/0.331

(1) Ith = 12 A.

(2) Bodies using the Ø 22 mm/0.87 in. hole mounting method that can be fitted with chromium plated metal bezel operating heads, type KAXZ1●●●.

Cam switches

Adaptable sub-assemblies, 12 A

Bodies (contact blocks + fixing plate)

To combine with operating heads:
see page 4/34

BCD encoded output switches with "0" position (continued)

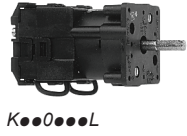

K...0...L

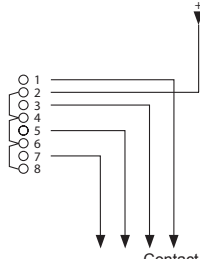

87	65	43	21	0
8	4	2	1	0
1				30
2				60
3				90
4				120
5				150
6				180
7				210
8				240
9				270
10				300
11				330



K...0...

Wiring diagram and switching programme	Switch position	Mounting method	Reference (1)	Weight kg/lb		
	9 decimal	Front	Multi-fixing	K1D009BL	0.126/0.278	
			By Ø 22 mm/0.87 in. hole	K1D009B	0.110/0.242	
	Rear		K1D009BX (2)	0.188/0.414		
			K1D509B	0.150/0.331		
		10 decimal	Front	Multi-fixing	K1D010BL	0.126/0.278
				By Ø 22 mm/0.87 in. hole	K1D010B	0.110/0.242
Rear			K1D010BX (2)	0.188/0.414		
			K1D510B	0.150/0.331		
		11 decimal	Front	Multi-fixing	K1D011BL	0.126/0.278
				By Ø 22 mm/0.87 in. hole	K1D011B	0.110/0.242
	Rear		K1D011BX (2)	0.188/0.414		
			K1D511B	0.150/0.331		

BCD encoded output switches without "0" position



K...5...

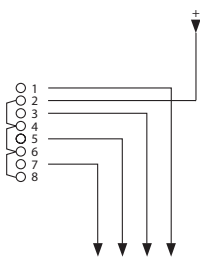

87	65	43	21	0
8	4	2	1	0
1				45
2				90
3				135
4				180
5				225



K...0...X

Wiring diagram and switching programme	Switch position	Mounting method	Reference (1)	Weight kg/lb		
	1 and 2 decimal	Front	Multi-fixing	K1B022BL	0.101/0.223	
			By Ø 22 mm/0.87 in. hole	K1B022B	0.085/0.187	
	Rear		K1B022BX (2)	0.163/0.359		
			K1B522B	0.125/0.275		
		3 decimal	Front	Multi-fixing	K1B023BL	0.101/0.223
				By Ø 22 mm/0.87 in. hole	K1B023B	0.085/0.187
Rear			K1B023BX (2)	0.163/0.359		
			K1B523B	0.125/0.275		
		4 decimal	Front	Multi-fixing	K1C024BL	0.121/0.267
				By Ø 22 mm/0.87 in. hole	K1C024B	0.105/0.231
	Rear		K1C024BX (2)	0.183/0.403		
			K1C524B	0.140/0.309		
		5 decimal	Front	Multi-fixing	K1C025BL	0.121/0.267
				By Ø 22 mm/0.87 in. hole	K1C025B	0.105/0.231
Rear			K1C025BX (2)	0.183/0.403		
			K1C525B	0.140/0.309		
		6 decimal	Front	Multi-fixing	K1C026BL	0.121/0.267
				By Ø 22 mm/0.87 in. hole	K1C026B	0.105/0.231
	Rear		K1C026BX (2)	0.183/0.403		
			K1C526B	0.140/0.309		

(1) lth = 12 A.
(2) Bodies using the Ø 22 mm/0.87 in. hole mounting method that can be fitted with chromium plated metal bezel operating heads, type KAXZ1....





Cam switches

Adaptable sub-assemblies, 12 A

Bodies (contact blocks + fixing plate)

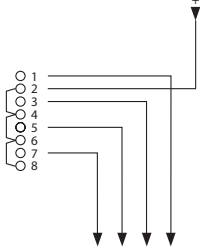
To combine with operating heads:
see page 4/34

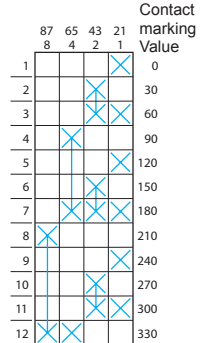
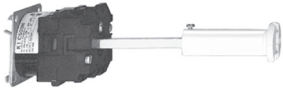
BCD encoded output switches without "0" position (continued)

Wiring diagram and switching programme	Switch position	Mounting method	Reference (1)	Weight kg/lb
 <p>K...0...L</p> 	7 decimal			
	Front	Multi-fixing By Ø 22 mm/0.87 in. hole	K1C027BL K1C027B	0.121/0.267 0.105/0.231
	Rear		K1C027BX (2) K1C527B	0.183/0.403 0.140/0.309
 <p>K...0...</p> 	8 decimal			
	Front	Multi-fixing By Ø 22 mm/0.87 in. hole	K1D028BL K1D028B	0.126/0.278 0.110/0.242
	Rear		K1D028BX (2) K1D528B	0.188/0.414 0.150/0.331
 <p>K...5...</p>	9 decimal			
	Front	Multi-fixing By Ø 22 mm/0.87 in. hole	K1D029BL K1D029B	0.126/0.278 0.110/0.242
	Rear		K1D029BX (2) K1D529B	0.188/0.414 0.150/0.331
 <p>K...0...X</p>	10 decimal			
	Front	Multi-fixing By Ø 22 mm/0.87 in. hole	K1D030BL K1D030B	0.126/0.278 0.110/0.242
	Rear		K1D030BX (2) K1D530B	0.188/0.414 0.150/0.331
	11 decimal			
	Front	Multi-fixing By Ø 22 mm/0.87 in. hole	K1D031BL K1D031B	0.126/0.278 0.110/0.242
	Rear		K1D531B	0.150/0.331
	12 decimal			
	Front	Multi-fixing By Ø 22 mm/0.87 in. hole	K1D032BL K1D032B	0.126/0.278 0.110/0.242
	Rear		K1D532B	0.150/0.331

(1) *l*th = 12 A.









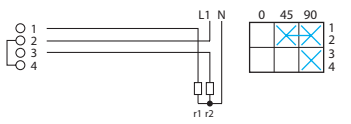

(2) Bodies using the Ø 22 mm/0.87 in. hole mounting method that can be fitted with chromium plated metal bezel operating heads, type **KAXZ1...**

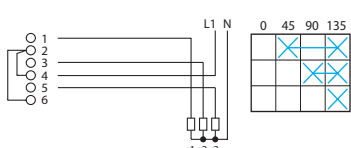
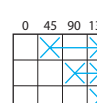
Cam switches

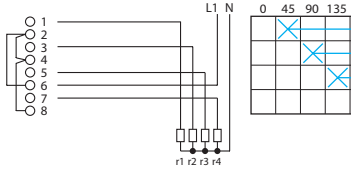
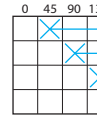
Adaptable sub-assemblies, 12 and 20 A

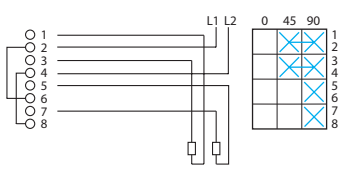
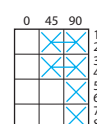
Bodies (contact blocks + fixing plate)

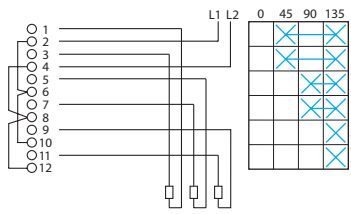
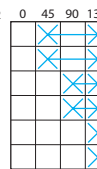
To combine with operating heads:
see page 4/34

Paralleling switches with "0" position					
Wiring diagram	Switching programme	Switch position	Mounting method	Reference to be completed (1)	Weight kg/lb
1-pole for 2 loads					
			Front	Multi-fixing	K●B002GL 0.101/0.223
				By Ø 22 mm/ 0.87 in. hole	K●B002G 0.085/0.187
			Rear		K●B002GX (2) 0.163/0.359
					K●B502G 0.125/0.275
1-pole for 3 loads					
			Front	Multi-fixing	K●C003GL 0.121/0.267
				By Ø 22 mm/ 0.87 in. hole	K●C003G 0.105/0.231
			Rear		K●C003GX (2) 0.183/0.403
					K●C503G 0.140/0.309
1-pole for 4 loads					
			Front	Multi-fixing	K●D004GL 0.126/0.278
				By Ø 22 mm/ 0.87 in. hole	K●D004G 0.110/0.242
			Rear		K●D004GX (2) 0.188/0.414
					K●D504G 0.150/0.331
2-pole for 2 loads					
			Front	Multi-fixing	K●D012GL 0.126/0.278
				By Ø 22 mm/ 0.87 in. hole	K●D012G 0.110/0.242
			Rear		K●D012GX (2) 0.188/0.414
					K●D512G 0.150/0.331
2-pole for 3 loads					
			Front	Multi-fixing	K●F013GL 0.156/0.344
				By Ø 22 mm/ 0.87 in. hole	K●F013G 0.140/0.309
			Rear		K●F013GX (2) 0.218/0.481
					K●F513G 0.175/0.386

(1) To order a cam switch with thermal current $I_{th} = 12$ A, replace the ● in the reference by 1.

Example **K1B002G**.

To order a cam switch with thermal current $I_{th} = 20$ A, replace the ● in the reference by 2.

Example **K2B002G**.

(2) Bodies using the Ø 22 mm/0.87 in. hole mounting method that can be fitted with chromium plated metal bezel operating heads, type **KAXZ1●●●**.

Cam switches

Adaptable sub-assemblies, 12 and 20 A

Bodies (contact blocks + fixing plate)

To combine with operating heads:
see page 4/34

Paralleling switches with "0" position (continued)

Wiring diagram	Switching programme	Switch position	Mounting method	Reference to be completed (1)	Weight kg/lb
----------------	---------------------	-----------------	-----------------	-------------------------------	--------------

2-pole for 4 loads

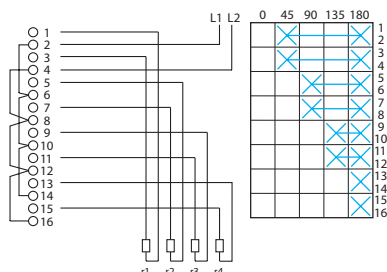
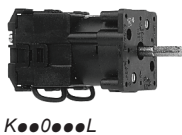

Front	Multi-fixing	K●H014GL	0.181/0.399
	By \varnothing 22 mm/ 0.87 in. hole	K●H014G	0.165/0.364
Rear		K●H014GX (2)	0.243/0.536
		K●H514G	0.195/0.430

3-pole for 2 loads

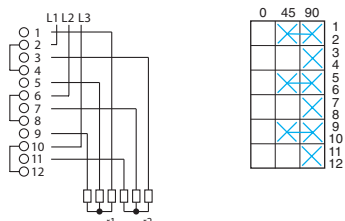

Front	Multi-fixing	K●F022GL	0.156/0.344
	By \varnothing 22 mm/ 0.87 in. hole	K●F022G	0.140/0.309
Rear		K●F022GX (2)	0.218/0.481
		K●F522G	0.175/0.386

3-pole for 3 loads

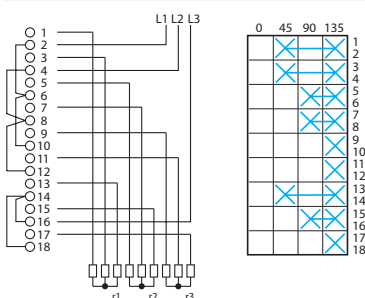
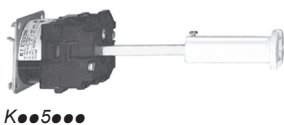

Front	Multi-fixing	K●I023GL	0.201/0.443
	By \varnothing 22 mm/ 0.87 in. hole	K●I023G	0.185/0.408
Rear		K●I023GX (2)	0.263/0.580
		K●I523G	0.215/0.474

3-pole for 4 loads

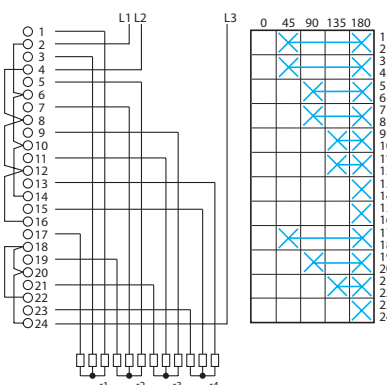

Front	Multi-fixing	K●M024GL	0.241/0.531
	By \varnothing 22 mm/ 0.87 in. hole	K●M024G	0.225/0.496
Rear		K●M024GX (2)	0.303/0.668
		K●M524G	0.245/0.540

(1) To order a cam switch with thermal current $I_{th} = 12$ A, replace the ● in the reference by 1.
Example **K1H014G**.

To order a cam switch with thermal current $I_{th} = 20$ A, replace the ● in the reference by 2.
Example **K2H014G**.

(2) Bodies using the \varnothing 22 mm/0.87 in. hole mounting method that can be fitted with chromium plated metal bezel operating heads, type **KAXZ1●●●**.











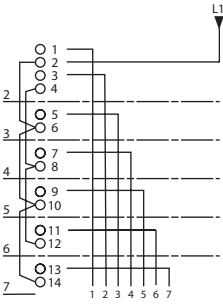

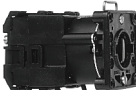
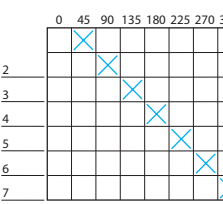

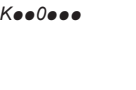
Cam switches

Adaptable sub-assemblies, 12 and 20 A

Bodies (contact blocks + fixing plate)

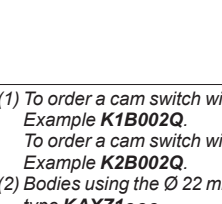
To combine with operating heads:
see page 4/34

Stepping switches (2 to 11 step), single-pole, with "0" position

Wiring diagram and switching programme	Switch position	Mounting method	Reference to be completed (1)	Weight kg/lb
 K●●0●●●L			Front Multi-fixing By Ø 22 mm/0.87 in. hole	K●B002QL 0.101/0.223
			Rear	K●B002Q 0.085/0.187 K●B002QX (2) 0.163/0.359 K●B502Q 0.125/0.275
 K●●0●●●			Front Multi-fixing By Ø 22 mm/0.87 in. hole	K●C003QL 0.121/0.267
			Rear	K●C003Q 0.105/0.231 K●C003QX (2) 0.183/0.403 K●C503Q 0.140/0.309
 K●●0●●●			Front Multi-fixing By Ø 22 mm/0.87 in. hole	K●D004QL 0.126/0.278
			Rear	K●D004Q 0.110/0.242 K●D004QX (2) 0.188/0.414 K●D504Q 0.150/0.331
 K●●5●●●			Front Multi-fixing By Ø 22 mm/0.87 in. hole	K●E005QL 0.146/0.322
			Rear	K●E005Q 0.130/0.287 K●E005QX (2) 0.208/0.458 K●E505Q 0.165/0.364
 K●●5●●●			Front Multi-fixing By Ø 22 mm/0.87 in. hole	K●F006QL 0.156/0.344
			Rear	K●F006Q 0.140/0.309 K●F006QX (2) 0.218/0.481 K●F506Q 0.175/0.386
 K●●0●●●X			Front Multi-fixing By Ø 22 mm/0.87 in. hole	K●G007QL 0.176/0.388
			Rear	K●G007Q 0.160/0.353 K●G007QX (2) 0.238/0.525 K●G507Q 0.190/0.419

(1) To order a cam switch with thermal current I_{th} = 12 A, replace the ● in the reference by 1.
Example **K1B002Q**.
To order a cam switch with thermal current I_{th} = 20 A, replace the ● in the reference by 2.
Example **K2B002Q**.

(2) Bodies using the Ø 22 mm/0.87 in. hole mounting method that can be fitted with chromium plated metal bezel operating heads, type **KAXZ1●●●**.

To combine with operating heads:
see page 4/34

Stepping switches (2 to 11 step), single-pole, with "0" position (continued)



K●●0●●●L

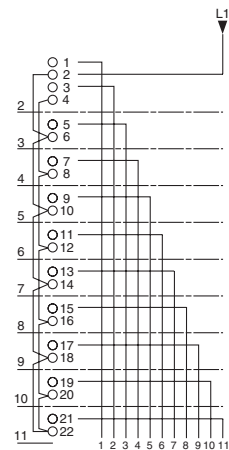

K●●0●●●

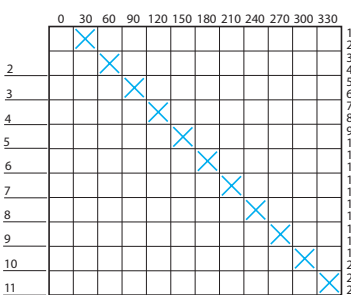

K●●5●●●

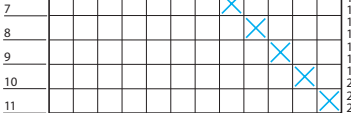

K●●0●●●X

(1) To order a cam switch with thermal current $I_{th} = 12 A$, replace the ● in the reference by 1.
Example **K1H008Q**.
To order a cam switch with thermal current $I_{th} = 20 A$, replace the ● in the reference by 2.
Example **K2H008Q**.
(2) Bodies using the $\varnothing 22 \text{ mm}/0.87 \text{ in.}$ hole mounting method that can be fitted with chromium plated metal bezel operating heads, type **KAXZ1●●●**.

Wiring diagram and switching programme	Switch position	Mounting method	Reference to be completed (1)	Weight kg/lb
8 step + "0"				
	Front	Multi-fixing	K●H008QL	0.181/0.399
	Rear	By $\varnothing 22 \text{ mm}/0.87 \text{ in.}$ hole	K●H008Q K●H008QX (2)	0.165/0.364 0.243/0.536
9 step + "0"				
	Front	Multi-fixing	K●I009QL	0.201/0.443
	Rear	By $\varnothing 22 \text{ mm}/0.87 \text{ in.}$ hole	K●I009Q K●I009QX (2)	0.185/0.408 0.263/0.580
10 step + "0"				
	Front	Multi-fixing	K●K010QL	0.211/0.465
	Rear	By $\varnothing 22 \text{ mm}/0.87 \text{ in.}$ hole	K●K010Q K●K010QX (2)	0.195/0.430 0.273/0.602
11 step + "0"				
	Front	Multi-fixing	K●L011QL	0.231/0.509
	Rear	By $\varnothing 22 \text{ mm}/0.87 \text{ in.}$ hole	K●L011Q K●L011QX (2)	0.215/0.474 0.293/0.646







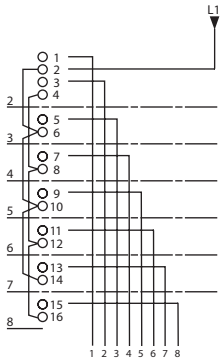

Cam switches

Adaptable sub-assemblies, 12 and 20 A

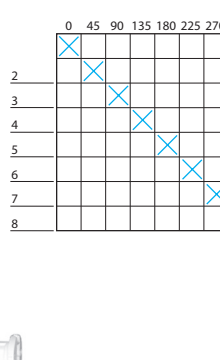
Bodies (contact blocks + fixing plate)

To combine with operating heads:
see page 4/34

Stepping switches (2 to 12 step), single-pole, without "0" position

Wiring diagram and switching programme	Switch position	Mounting method	Reference to be completed (1)	Weight kg/lb
		Front	Multi-fixing By Ø 22 mm/0.87 in. hole	K●B002NL 0.101/0.223 K●B002N 0.085/0.187 K●B002NX (2) 0.163/0.359
		Rear		K●B502N 0.125/0.275
		Front	Multi-fixing By Ø 22 mm/0.87 in. hole	K●C003NL 0.121/0.267 K●C003N 0.105/0.231 K●C003NX (2) 0.183/0.403
		Rear		K●C503N 0.140/0.309
		Front	Multi-fixing By Ø 22 mm/0.87 in. hole	K●D004NL 0.126/0.278 K●D004N 0.110/0.242 K●D004NX (2) 0.188/0.414
		Rear		K●D504N 0.150/0.331
		Front	Multi-fixing By Ø 22 mm/0.87 in. hole	K●E005NL 0.146/0.322 K●E005N 0.130/0.287 K●E005NX (2) 0.208/0.458
		Rear		K●E505N 0.165/0.364
		Front	Multi-fixing By Ø 22 mm/0.87 in. hole	K●F006NL 0.156/0.344 K●F006N 0.140/0.309 K●F006NX (2) 0.218/0.481
		Rear		K●F506N 0.175/0.386
		Front	Multi-fixing By Ø 22 mm/0.87 in. hole	K●G007NL 0.176/0.388 K●G007N 0.160/0.353 K●G007NX (2) 0.238/0.525
		Rear		K●G507N 0.190/0.419
		Front	Multi-fixing By Ø 22 mm/0.87 in. hole	K●H008NL 0.181/0.399 K●H008N 0.165/0.364 K●H008NX (2) 0.243/0.536
		Rear		K●H508N 0.195/0.430

(1) To order a cam switch with thermal current I_{th} = 12 A, replace the ● in the reference by 1.
Example **K1B002N**.

To order a cam switch with thermal current I_{th} = 20 A, replace the ● in the reference by 2.
Example **K2B002N**.

(2) Bodies using the Ø 22 mm/0.87 in. hole mounting method that can be fitted with chromium plated metal bezel operating heads, type **KAXZ1●●●**.

To combine with operating heads:
see page 4/34

Stepping switches (2 to 12 step), single-pole, without "0" position (continued)

Wiring diagram and switching programme	Switch position	Mounting method	Reference to be completed (1)	Weight kg
--	-----------------	-----------------	-------------------------------	-----------

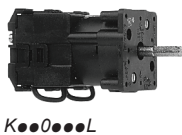

K●●0●●●L

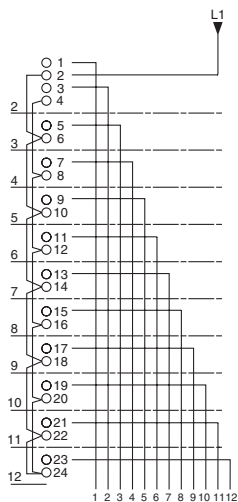

K●●0●●●

9 step

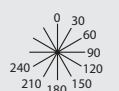

Front	Multi-fixing	K●L009NL	0.201/0.443
	By Ø 22 mm/ 0.87 in. hole	K●L009N	0.185/0.408
Rear		K●L009NX (2)	0.263/0.580
Rear		K●L509N	0.215/0.474

10 step

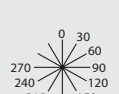

Front	Multi-fixing	K●K010NL	0.211/0.465
	By Ø 22 mm/ 0.87 in. hole	K●K010N	0.195/0.430
Rear		K●K010NX (2)	0.273/0.602
Rear		K●K510N	0.220/0.485

11 step



Front	Multi-fixing	K●L011NL	0.231/0.509
	By Ø 22 mm/ 0.87 in. hole	K●L011N	0.215/0.474
Rear		K●L011NX (2)	0.293/0.646
Rear		K●L511N	0.240/0.529



K●●5●●●

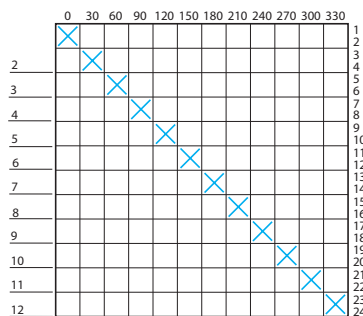

12 step

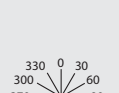

Front	Multi-fixing	K●M021NL	0.241/0.531
	By Ø 22 mm/ 0.87 in. hole	K●M021N	0.225/0.496
Rear		K●M021NX (2)	0.303/0.668
Rear		K●M521N	0.245/0.540



K●●0●●●X

(1) To order a cam switch with thermal current $I_{th} = 12 A$, replace the ● in the reference by 1.
Example **K11009N**.

To order a cam switch with thermal current $I_{th} = 20 A$, replace the ● in the reference by 2.
Example **K21009N**.

(2) Bodies using the Ø 22 mm/0.87 in. hole mounting method that can be fitted with chromium plated metal bezel operating heads, type **KAXZ1●●●**.











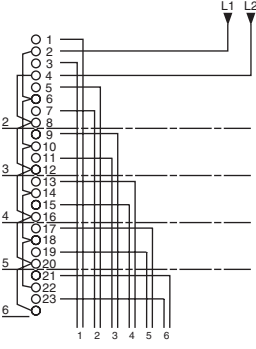

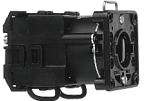
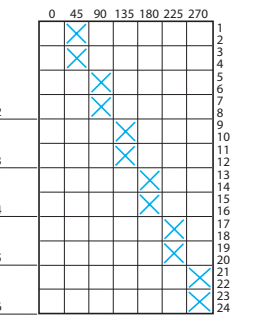
Cam switches

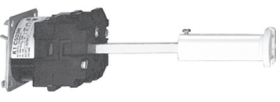
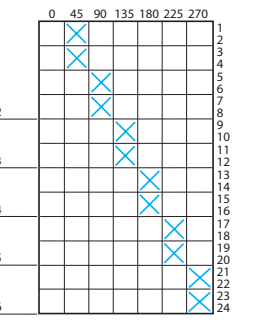
Adaptable sub-assemblies, 12 and 20 A

Bodies (contact blocks + fixing plate)

To combine with operating heads:
see page 4/34

Stepping switches (2 to 6 step), 2-pole, with "0" position

Wiring diagram and switching programme	Switch position	Mounting method	Reference to be completed (1)	Weight kg/lb	
 K●●0●●●L		2 step + "0"			
			Front Multi-fixing By Ø 22 mm/0.87 in. hole	K●D012QL K●D012Q K●D012QX (2)	0.126/0.278 0.110/0.242 0.188/0.414
 K●●0●●●		3 step + "0"			
			Front Multi-fixing By Ø 22 mm/0.87 in. hole	K●F013QL K●F013Q K●F013QX (2)	0.156/0.344 0.140/0.309 0.218/0.481
 K●●5●●●		4 step + "0"			
			Front Multi-fixing By Ø 22 mm/0.87 in. hole	K●H014QL K●H014Q K●H014QX (2)	0.181/0.399 0.165/0.364 0.243/0.536
 K●●0●●●X		5 step + "0"			
			Front Multi-fixing By Ø 22 mm/0.87 in. hole	K●K015QL K●K015Q K●K015QX (2)	0.211/0.465 0.195/0.430 0.273/0.602
 K●●0●●●X		6 step + "0"			
			Front Multi-fixing By Ø 22 mm/0.87 in. hole	K●M016QL K●M016Q K●M016QX (2)	0.241/0.531 0.225/0.496 0.303/0.668
			Rear	K●D512Q K●F513Q K●H514Q K●K515Q K●M516Q	0.150/0.331 0.175/0.386 0.195/0.430 0.220/0.485 0.245/0.540

(1) To order a cam switch with thermal current I_{th} = 12 A, replace the ● in the reference by 1.
Example **K1D012Q**.

To order a cam switch with thermal current I_{th} = 20 A, replace the ● in the reference by 2.
Example **K2D012Q**.

(2) Bodies using the Ø 22 mm/0.87 in. hole mounting method that can be fitted with chromium plated metal bezel operating heads, type **KAXZ1●●●**.







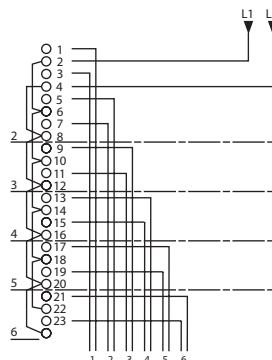

Cam switches

Adaptable sub-assemblies, 12 and 20 A

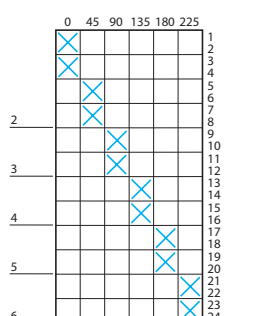
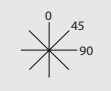
Bodies (contact blocks + fixing plate)

To combine with operating heads:
see page 4/34

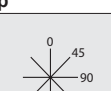
Stepping switches (2 to 6 step), 2-pole, without "0" position

Wiring diagram and switching programme	Switch position	Mounting method	Reference to be completed (1)	Weight kg/lb		
		Front	Multi-fixing By Ø 22 mm/0.87 in. hole	K●D012NL 0.126/0.278 K●D012N 0.110/0.242		
		Rear		K●D012NX (2) 0.188/0.414 K●D512N 0.150/0.331		
			Front	Multi-fixing By Ø 22 mm/0.87 in. hole	K●F013NL 0.156/0.344 K●F013N 0.140/0.309	
			Rear		K●F013NX (2) 0.218/0.481 K●F513N 0.175/0.386	
				Front	Multi-fixing By Ø 22 mm/0.87 in. hole	K●H014NL 0.181/0.399 K●H014N 0.165/0.364
				Rear		K●H014NX (2) 0.243/0.536 K●H514N 0.195/0.430
		Front	Multi-fixing By Ø 22 mm/0.87 in. hole	K●K015NL 0.211/0.465 K●K015N 0.195/0.430		
		Rear		K●K015NX (2) 0.273/0.602 K●K515N 0.220/0.485		
		Front	Multi-fixing By Ø 22 mm/0.87 in. hole	K●M016NL 0.241/0.531 K●M016N 0.225/0.496		
		Rear		K●M016NX (2) 0.303/0.668 K●M516N 0.245/0.540		

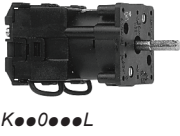

K●0●●●L

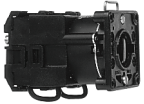

K●0●●●



K●5●●●



K●0●●●X

(1) To order a cam switch with thermal current $I_{th} = 12$ A, replace the ● in the reference by 1.

Example **K1D012N**.

To order a cam switch with thermal current $I_{th} = 20$ A, replace the ● in the reference by 2.

Example **K2D012N**.

(2) Bodies using the Ø 22 mm/0.87 in. hole mounting method that can be fitted with chromium plated metal bezel operating heads, type **KAXZ1●●●**.

Cam switches

Adaptable sub-assemblies, 12 and 20 A

Bodies (contact blocks + fixing plate)

To combine with operating heads:
see page 4/34

Stepping switches (2 to 6 step), 3-pole, with "0" position

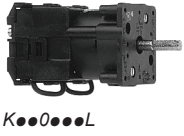

K●0●●●L

Wiring diagram	Switching programme	Switch position	Mounting method	Reference to be completed (1)	Weight kg/lb
			Front Multi-fixing By Ø 22 mm/ 0.87 in. hole	K●F022QL K●F022Q K●F022QX (2)	0.156/0.344 0.140/0.309 0.218/0.481
			Rear	K●F522Q	0.175/0.386



K●0●●●

			Front Multi-fixing By Ø 22 mm/ 0.87 in. hole	K●I023QL K●I023Q K●I023QX (2)	0.201/0.443 0.185/0.408 0.263/0.580
			Rear	K●I523Q	0.215/0.474

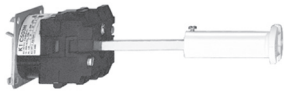

K●5●●●

			Front Multi-fixing By Ø 22 mm/ 0.87 in. hole	K●M024QL K●M024Q K●M024QX (2)	0.241/0.531 0.225/0.496 0.303/0.668
			Rear	K●M524Q	0.245/0.540



K●0●●●X

			Front Multi-fixing By Ø 22 mm/ 0.87 in. hole	K●P025QL K●P025Q K●P025QX (2)	0.286/0.630 0.270/0.595 0.348/0.767
			Rear	K●P525Q	0.285/0.628

			Front Multi-fixing By Ø 22 mm/ 0.87 in. hole	K●S026QL K●S026Q K●S026QX (2)	0.321/0.708 0.305/0.672 0.383/0.844
			Rear	K●S526Q	0.320/0.705

(1) To order a cam switch with thermal current $I_{th} = 12 A$, replace the ● in the reference by 1.
Example **K1F022Q**.

To order a cam switch with thermal current $I_{th} = 20 A$, replace the ● in the reference by 2.
Example **K2F022Q**.

(2) Bodies using the Ø 22 mm/0.87 in. hole mounting method that can be fitted with chromium plated metal bezel operating heads, type **KAXZ1●●●**.









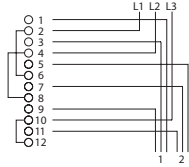
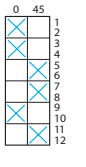

Cam switches

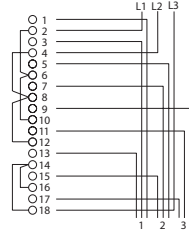
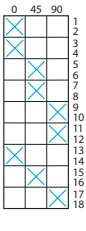
Adaptable sub-assemblies, 12 and 20 A

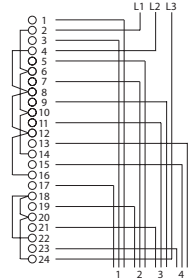
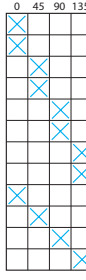
Bodies (contact blocks + fixing plate)

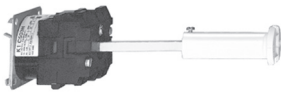
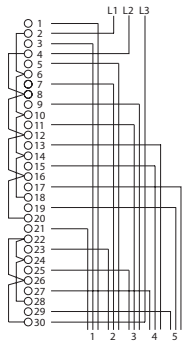
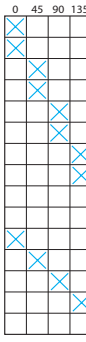
To combine with operating heads:
see page 4/34

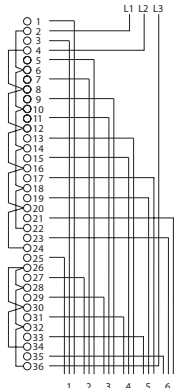
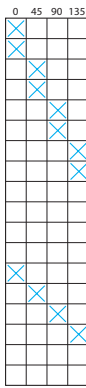
Stepping switches (2 to 6 step), 3-pole, without "0" position

	Wiring diagram	Switching programme	Switch position	Mounting method	Reference to be completed (1)	Weight kg/lb
 K●●0●●●L			2 step 	Front Multi-fixing	K●F022NL	0.156/0.344
				By Ø 22 mm/ 0.87 in. hole	K●F022N	0.140/0.309
				Rear	K●F022NX (2)	0.218/0.481
				Rear	K●F522N	0.175/0.386
			3 step 	Front Multi-fixing	K●I023NL	0.201/0.443
				By Ø 22 mm/ 0.87 in. hole	K●I023N	0.185/0.408
				Rear	K●I023NX (2)	0.263/0.580
				Rear	K●I523N	0.215/0.474
 K●●0●●●			4 step 	Front Multi-fixing	K●M024NL	0.241/0.531
				By Ø 22 mm/ 0.87 in. hole	K●M024N	0.225/0.496
				Rear	K●M024NX (2)	0.303/0.668
				Rear	K●M524N	0.245/0.540
 K●●5●●●			5 step 	Front Multi-fixing	K●P025NL	0.286/0.630
				By Ø 22 mm/ 0.87 in. hole	K●P025N	0.270/0.595
				Rear	K●P025NX (2)	0.348/0.767
				Rear	K●P525N	0.285/0.628
 K●●0●●●X			6 step 	Front Multi-fixing	K●S026NL	0.321/0.708
				By Ø 22 mm/ 0.87 in. hole	K●S026N	0.305/0.672
				Rear	K●S026NX (2)	0.383/0.844
				Rear	K●S526N	0.320/0.705

(1) To order a cam switch with thermal current $I_{th} = 12 A$, replace the ● in the reference by 1.

Example **K1F022N**.

To order a cam switch with thermal current $I_{th} = 20 A$, replace the ● in the reference by 2.

Example **K2F022N**.

(2) Bodies using the Ø 22 mm/0.87 in. hole mounting method that can be fitted with chromium plated metal bezel operating heads, type **KAXZ1●●●**.







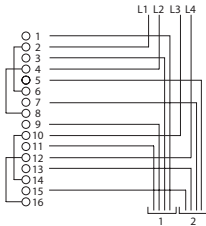
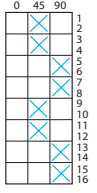

Cam switches

Adaptable sub-assemblies, 12 and 20 A

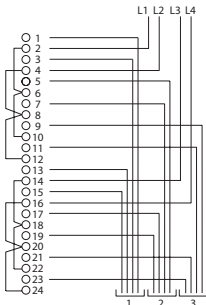
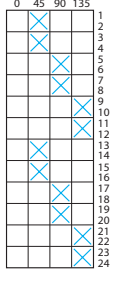
Bodies (contact blocks + fixing plate)

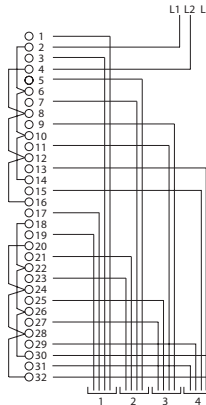
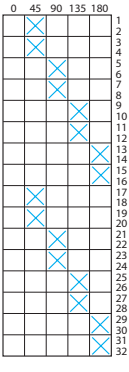
To combine with operating heads:
see page 4/34

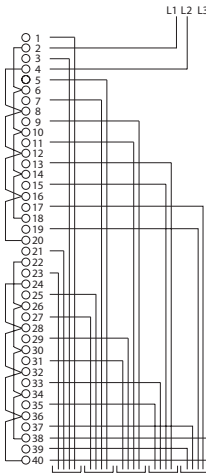
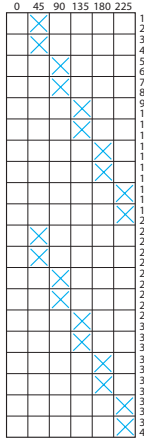
Stepping switches (2 to 5 step), 4-pole, with "0" position

Wiring diagram	Switching programme	Switch position	Mounting method	Reference to be completed (1)	Weight kg/lb	
			Front	Multi-fixing	K●H032QL	0.181/0.399
				By Ø 22 mm/ 0.87 in. hole	K●H032Q	0.165/0.364
			Rear		K●H532Q	0.200/0.441
					K●H532Q	0.195/0.430
			Front	Multi-fixing	K●M033QL	0.241/0.531
				By Ø 22 mm/ 0.87 in. hole	K●M033Q	0.225/0.496
			Rear		K●M533Q	0.245/0.540
					K●M533Q	0.245/0.540
			Front	Multi-fixing	K●Q034QL	0.296/0.653
				By Ø 22 mm/ 0.87 in. hole	K●Q034Q	0.280/0.617
			Rear		K●Q534Q	0.295/0.650
					K●Q534Q	0.295/0.650
			Front	Multi-fixing	K●U035QL	0.351/0.774
				By Ø 22 mm/ 0.87 in. hole	K●U035Q	0.335/0.738
			Rear		K●U535Q	0.345/0.761
					K●U535Q	0.345/0.761

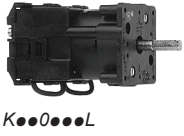

K●0●●●L

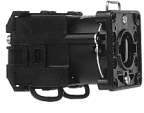

K●0●●●



K●5●●●



K●0●●●X

(1) To order a cam switch with thermal current $I_{th} = 12 A$, replace the ● in the reference by 1.

Example **K1H032Q**.

To order a cam switch with thermal current $I_{th} = 20 A$, replace the ● in the reference by 2.

Example **K2H032Q**.

(2) Bodies using the Ø 22 mm/0.87 in. hole mounting method that can be fitted with chromium plated metal bezel operating heads, type **KAXZ1●●●**.

Cam switches

Adaptable sub-assemblies, 12 and 20 A

Bodies (contact blocks + fixing plate)

To combine with operating heads:
see page 4/34

Stepping switches (2 to 5 step), 4-pole, without "0" position

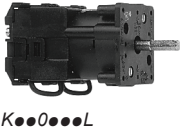

K●0●●●L

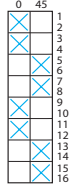
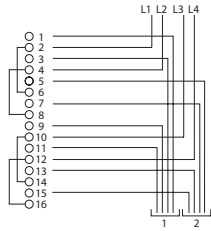

2 step



Mounting method	Reference to be completed (1)	Weight kg/lb
Front Multi-fixing	K●H032NL	0.181/0.399
By Ø 22 mm/ 0.87 in. hole	K●H032N	0.165/0.364
Rear	K●H032NX (2)	0.200/0.441
	K●H532N	0.195/0.430

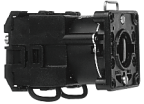

K●0●●●

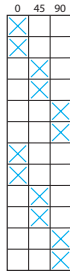
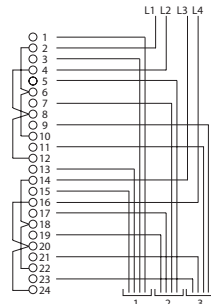

3 step



Mounting method	Reference to be completed (1)	Weight kg/lb
Front Multi-fixing	K●M033NL	0.241/0.531
By Ø 22 mm/ 0.87 in. hole	K●M033N	0.225/0.496
Rear	K●M533N	0.245/0.540



K●5●●●

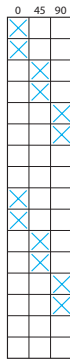
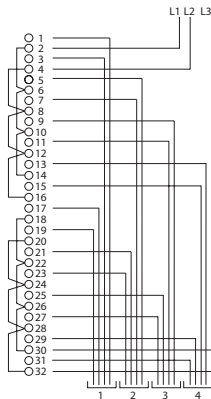

4 step



Mounting method	Reference to be completed (1)	Weight kg/lb
Front Multi-fixing	K●Q034NL	0.296/0.653
By Ø 22 mm/ 0.87 in. hole	K●Q034N	0.280/0.617
Rear	K●Q534N	0.295/0.650



K●0●●●X

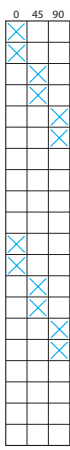
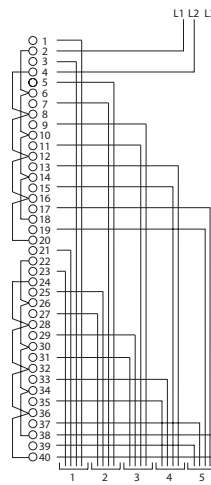

5 step



Mounting method	Reference to be completed (1)	Weight kg/lb
Front Multi-fixing	K●U035NL	0.351/0.774
By Ø 22 mm/ 0.87 in. hole	K●U035N	0.335/0.738
Rear	K●U535N	0.345/0.761

(1) To order a cam switch with thermal current $I_{th} = 12 A$, replace the ● in the reference by 1.

Example **K1H032N**.

To order a cam switch with thermal current $I_{th} = 20 A$, replace the ● in the reference by 2.

Example **K2H032N**.

(2) Bodies using the Ø 22 mm/0.87 in. hole mounting method that can be fitted with chromium plated metal bezel operating heads, type **KAXZ1●●●**.

Cam switches

Adaptable sub-assemblies, 12 and 20 A



Bodies (contact blocks + fixing plate)

To combine with operating heads:
see page 4/34

Ammeter switches with "0" position

Wiring diagram	Switching programme	Switch position	Mounting method	Reference (1)	Weight kg/lb
----------------	---------------------	-----------------	-----------------	---------------	--------------

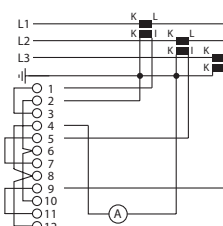
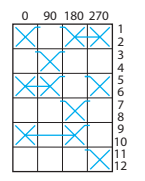
For 3 circuits

Front	Multi-fixing	K1F003ML	0.156/0.344
	By Ø 22 mm/ 0.87 in. hole	K1F003M	0.140/0.309
		K1F003MX (2)	0.218/0.481
Rear		K1F503M	0.175/0.386

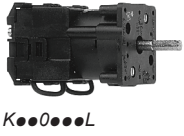

For 4 circuits

Front	Multi-fixing	K1H004ML	0.181/0.399
	By Ø 22 mm/ 0.87 in. hole	K1H004M	0.165/0.364
		K1H004MX (2)	0.243/0.536
Rear		K1H504M	0.195/0.430

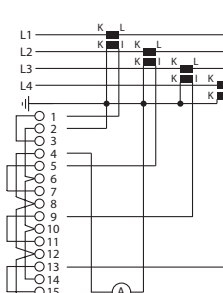
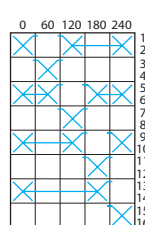
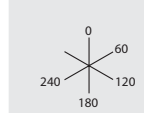

Ammeter switches without "0" position

Wiring diagram	Switching programme	Switch position	Mounting method	Reference (1)	Weight kg/lb
----------------	---------------------	-----------------	-----------------	---------------	--------------

For 3 circuits

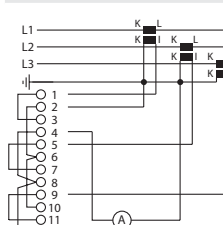
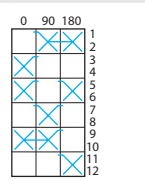
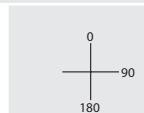
Front	Multi-fixing	K1F013ML	0.156/0.344
	By Ø 22 mm/ 0.87 in. hole	K1F013M	0.140/0.309
		K1F013MX (2)	0.218/0.481
Rear		K1F513M	0.175/0.386

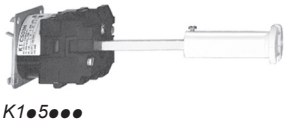

For 4 circuits

Front	Multi-fixing	K1H014ML	0.181/0.399
	By Ø 22 mm/ 0.87 in. hole	K1H014M	0.165/0.364
		K1H014MX (2)	0.243/0.536
Rear		K1H514M	0.195/0.430

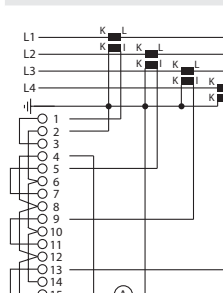
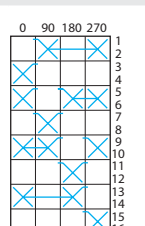
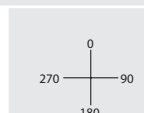

(1) I_{th} = 12 A.

(2) Bodies using the Ø 22 mm/0.87 in. hole mounting method that can be fitted with chromium plated metal bezel operating heads, type **KAXZ1000**.

Cam switches

Adaptable sub-assemblies, 12 and 20 A

Bodies (contact blocks + fixing plate)

To combine with operating heads:
see page 4/34

Voltmeter switches

Wiring diagram	Switching programme	Switch position	Mounting method	Reference (1)	Weight kg/lb
----------------	---------------------	-----------------	-----------------	---------------	--------------

For measurements between 3 phases and neutral

With "0" position

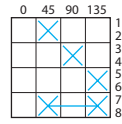
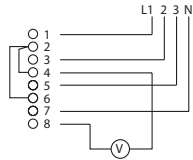
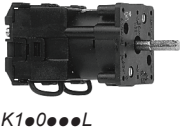

Front	Multi-fixing	K1D023ML	0.126/0.278
	By Ø 22 mm/ 0.87 in. hole	K1D023M	0.110/0.242
Rear		K1D023MX (2)	0.188/0.414
		K1D523M	0.150/0.331

Without "0" position

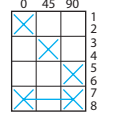

Front	Multi-fixing	K1D033ML	0.126/0.278
	By Ø 22 mm/ 0.87 in. hole	K1D033M	0.110/0.242
Rear		K1D533M	0.150/0.331

For measurements between 3 phases

With "0" position

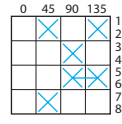
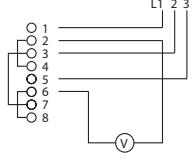
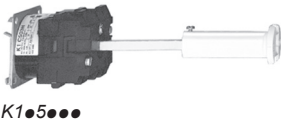

Front	Multi-fixing	K1D024ML	0.126/0.278
	By Ø 22 mm/ 0.87 in. hole	K1D024M	0.110/0.242
		K1D024MX (2)	0.188/0.414
Rear		K1D524M	0.150/0.331

Without "0" position

For measurements between 3 phases and between 1 phase and neutral

With "0" position

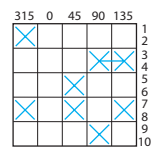
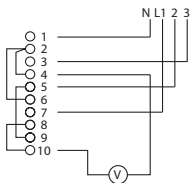

Front	Multi-fixing	K1E025ML	0.146/0.322
	By Ø 22 mm/ 0.87 in. hole	K1E025M	0.130/0.287
		K1E025MX (2)	0.208/0.458
Rear		K1E525M	0.165/0.364

Without "0" position

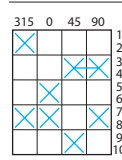

Front	Multi-fixing	K1E035ML	0.146/0.322
	By Ø 22 mm/ 0.87 in. hole	K1E035M	0.130/0.287
		K1E535M	0.165/0.364

(1) I_{th} = 12 A.

(2) Bodies using the Ø 22 mm/0.87 in. hole mounting method that can be fitted with chromium plated metal bezel operating heads, type KAXZ1000.

4

Cam switches

Adaptable sub-assemblies, 12 and 20 A

Bodies (contact blocks + fixing plate)

To combine with operating heads:
see page 4/34

Voltmeter switches (continued)

Wiring diagram	Switching programme	Switch position	Mounting method	Reference (1)	Weight kg/lb
----------------	---------------------	-----------------	-----------------	---------------	--------------

For measurements between 3 phases of 2 supplies

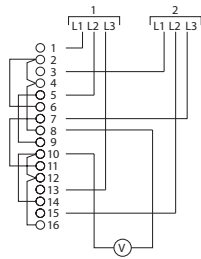
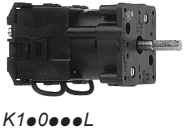

With "0" position

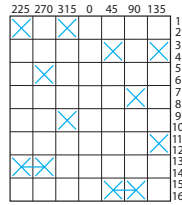

Front	Multi-fixing	K1H026ML	0.181/0.399
	By Ø 22 mm/ 0.87 in. hole	K1H026M	0.165/0.364

Rear		K1H526M	0.195/0.430
------	--	----------------	-------------



Without "0" position

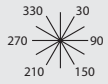
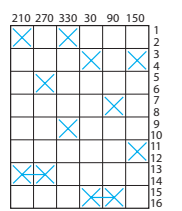

Front	Multi-fixing	K1H036ML	0.181/0.399
	By Ø 22 mm/ 0.87 in. hole	K1H036M	0.165/0.364

Rear		K1H536M	0.195/0.430
------	--	----------------	-------------

4

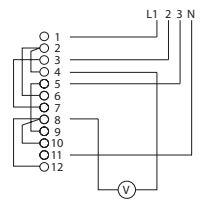
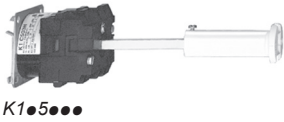

For measurements between 3 phases and between each of the 3 phases and neutral

With "0" position

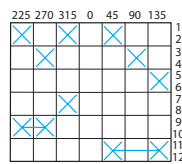

Front	Multi-fixing	K1F027ML	0.156/0.344
	By Ø 22 mm/ 0.87 in. hole	K1F027M	0.140/0.309

Rear		K1F027MX (2)	0.218/0.481
		K1F527M	0.175/0.386



Without "0" position

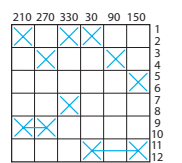

Front	Multi-fixing	K1F037ML	0.156/0.344
	By Ø 22 mm/ 0.87 in. hole	K1F037M	0.140/0.309

Rear		K1F537M	0.175/0.386
------	--	----------------	-------------

(1) Ith = 12 A.

(2) Bodies using the Ø 22 mm/0.87 in. hole mounting method that can be fitted with chromium plated metal bezel operating heads, type KAXZ1000.





Cam switches

Adaptable sub-assemblies, 12 and 20 A

Bodies (contact blocks + fixing plate)

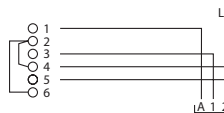
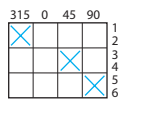
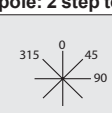
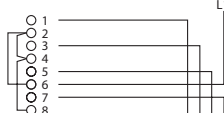
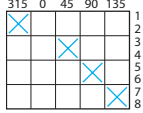
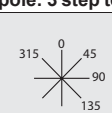
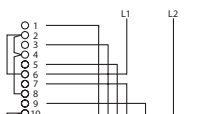
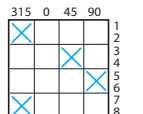
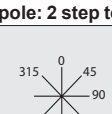
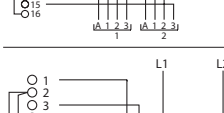
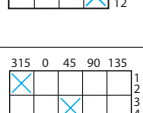
To combine with operating heads:
see page 4/34

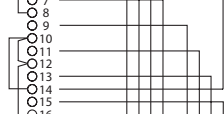
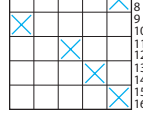
Stepping switches (2 and 3 step), with "0" position + left-hand position

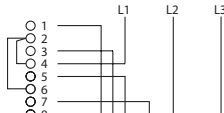
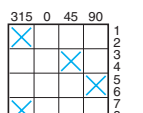
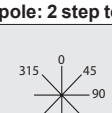
Wiring diagram	Switching programme	Switch position	Mounting method	Reference to be completed (1)	Weight kg/lb
			Front Multi-fixing	K●C002LL	0.121/0.267
			By Ø 22 mm/ 0.87 in. hole	K●C002L	0.105/0.231
			Rear	K●C502L	0.140/0.309
			Front Multi-fixing	K●D003LL	0.126/0.278
			By Ø 22 mm/ 0.87 in. hole	K●D003L	0.110/0.242
			Rear	K●D503L	0.150/0.331
			Front Multi-fixing	K●F012LL	0.156/0.344
			By Ø 22 mm/ 0.87 in. hole	K●F012L	0.140/0.309
			Rear	K●F012LX (2)	0.218/0.481
				K●F512L	0.175/0.386
			Front Multi-fixing	K●H013LL	0.181/0.399
			By Ø 22 mm/ 0.87 in. hole	K●H013L	0.165/0.364
			Rear	K●H013LX (2)	0.243/0.536
				K●H513L	0.195/0.430
			Front Multi-fixing	K●I022LL	0.201/0.443
			By Ø 22 mm/ 0.87 in. hole	K●I022L	0.185/0.408
			Rear	K●I522L	0.210/0.463
			Front Multi-fixing	K●M023LL	0.241/0.531
			By Ø 22 mm/ 0.87 in. hole	K●M023L	0.225/0.496
			Rear	K●M523L	0.245/0.540

(1) To order a cam switch with thermal current $I_{th} = 12$ A, replace the ● in the reference by 1.
Example **K1C022Q**.

To order a cam switch with thermal current $I_{th} = 20$ A, replace the ● in the reference by 2.
Example **K2C022Q**.

(2) Bodies using the Ø 22 mm/0.87 in. hole mounting method that can be fitted with chromium plated metal bezel operating heads, type **KAXZ1●●●**.









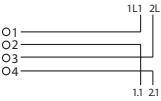
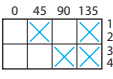

Cam switches

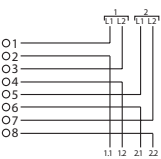
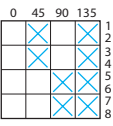
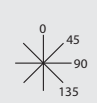
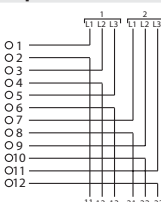
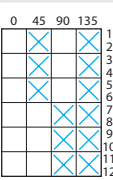
Adaptable sub-assemblies, 12 and 20 A

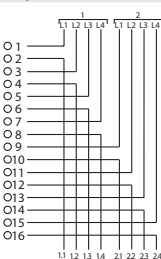
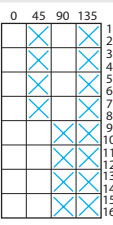
Bodies (contact blocks + fixing plate)

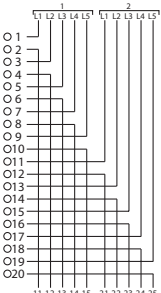
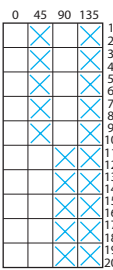
To combine with operating heads:
see page 4/34

Multi-circuit switches						
Wiring diagram	Switching programme	Switch position	Mounting method	Reference to be completed (1)	Weight kg/lb	
			Front	Multi-fixing	K●B001SL	0.101/0.223
				By Ø 22 mm/ 0.87 in. hole	K●B001S	0.085/0.187
			Rear		K●B501S	0.163/0.359
					K●B501S	0.125/0.275
			Front	Multi-fixing	K●D002SL	0.126/0.278
				By Ø 22 mm/ 0.87 in. hole	K●D002S	0.110/0.242
			Rear		K●D002SX (2)	0.188/0.414
					K●D502S	0.150/0.331
			Front	Multi-fixing	K●F003SL	0.156/0.344
				By Ø 22 mm/ 0.87 in. hole	K●F003S	0.140/0.309
			Rear		K●F003SX (2)	0.218/0.481
					K●F503S	0.175/0.386
			Front	Multi-fixing	K●H004SL	0.181/0.399
				By Ø 22 mm/ 0.87 in. hole	K●H004S	0.165/0.364
			Rear		K●H504S	0.195/0.430
			Front	Multi-fixing	K●K005SL	0.211/0.465
				By Ø 22 mm/ 0.87 in. hole	K●K005S	0.195/0.430
			Rear		K●K505S	0.220/0.485



K●●0●●●L



K●●0●●●

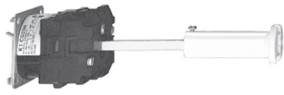

K●●5●●●

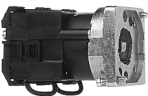

K●●0●●●X

(1) To order a cam switch with thermal current I_{th} = 12 A, replace the ● in the reference by 1.

Example **K1F003S**.

To order a cam switch with thermal current I_{th} = 20 A, replace the ● in the reference by 2.

Example **K2F003S**.

(2) Bodies using the Ø 22 mm/0.87 in. hole mounting method that can be fitted with chromium plated metal bezel operating heads, type **KAXZ1●●●**.

Cam switches

Adaptable sub-assemblies, 12 and 20 A

Bodies (contact blocks + fixing plate)

To combine with operating heads:
see page 4/34

Reversing switches with "0" position

Wiring diagram	Switching programme	Switch position	Mounting method	Reference to be completed (1)	Weight kg/lb
----------------	---------------------	-----------------	-----------------	-------------------------------	--------------

2-pole



K●●0●●●L

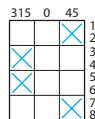
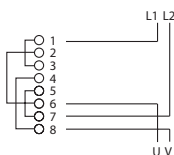

Front	Multi-fixing	K●D002WL	0.126/0.278
	By Ø 22 mm/ 0.87 in. hole	K●D002W	0.110/0.242
Rear		K●D002WX (2)	0.188/0.414
		K●D502W	0.150/0.331

3-pole



K●●0●●●

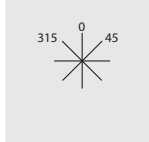
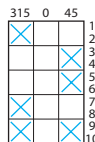
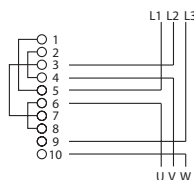

Front	Multi-fixing	K●E003WL	0.146/0.322
	By Ø 22 mm/ 0.87 in. hole	K●E003W	0.130/0.287
Rear		K●E003WX (2)	0.208/0.458
		K●E503W	0.165/0.364

Reversing switches with spring return from 330° and from 30° to "0" position

Wiring diagram	Switching programme	Switch position	Mounting method	Reference to be completed (1)	Weight kg/lb
----------------	---------------------	-----------------	-----------------	-------------------------------	--------------

2-pole



K●●5●●●

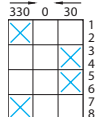
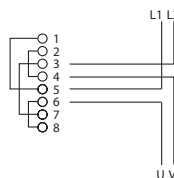

Front	Multi-fixing	K●D022WL	0.126/0.278
	By Ø 22 mm/ 0.87 in. hole	K●D022W	0.110/0.242
Rear		K●D022WX (2)	0.188/0.414
		K●D522W	0.150/0.331

3-pole



K●●0●●●X

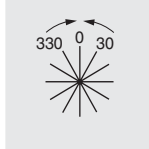
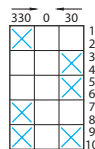
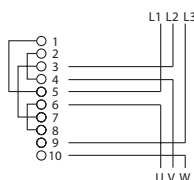

Front	Multi-fixing	K●E023WL	0.146/0.322
	By Ø 22 mm/ 0.87 in. hole	K●E023W	0.130/0.287
Rear		K●E023WX (2)	0.208/0.458
		K●E523W	0.165/0.364

(1) To order a cam switch with thermal current $I_{th} = 12$ A, replace the ● in the reference by 1.
Example **K1D002W**.

To order a cam switch with thermal current $I_{th} = 20$ A, replace the ● in the reference by 2.
Example **K2D002W**.







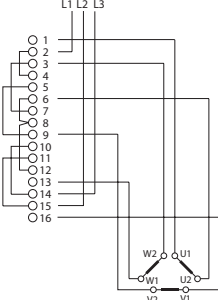

(2) Bodies using the Ø 22 mm/0.87 in. hole mounting method that can be fitted with chromium plated metal bezel operating heads, type **KAXZ1●●●**.

Cam switches

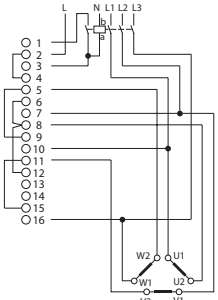
Adaptable sub-assemblies, 12 A

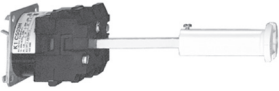
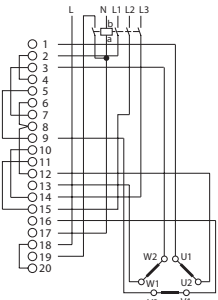
Bodies (contact blocks + fixing plate)

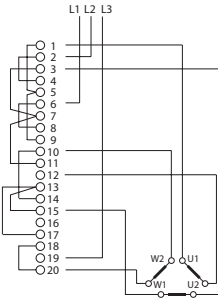
To combine with operating heads:
see page 4/34

Star-delta switches						
Wiring diagram	Switching programme	Switch position	Mounting method	Reference (1)	Weight kg/lb	
 K20000L			Front Multi-fixing	K2H001YL	0.181/0.399	
			By Ø 22 mm/ 0.87 in. hole	K2H001Y	0.165/0.364	
				K2H001YX (2)	0.243/0.536	
			Rear	K2H501Y	0.195/0.430	
With slave contact, without supply disconnection						
 K20000			Front Multi-fixing	K2G003YL	0.176/0.388	
			By Ø 22 mm/ 0.87 in. hole	K2G003Y	0.160/0.353	
				K2G003YX (2)	0.238/0.525	
			Rear	K2G503Y	0.190/0.419	
With slave contact, with supply disconnection						
 K20500			Front Multi-fixing	K2K004YL	0.211/0.465	
			By Ø 22 mm/ 0.87 in. hole	K2K004Y	0.195/0.430	
				K2K004YX (2)	0.273/0.602	
			Rear	K2K504Y	0.220/0.485	
Reversing star-delta switches						
Wiring diagram	Switching programme	Switch position	Mounting method	Reference (1)	Weight kg/lb	
Without slave contact						
 K20000X			Front Multi-fixing	K2K006YL	0.211/0.465	
			By Ø 22 mm/ 0.87 in. hole	K2K006Y	0.195/0.430	
				K2K506Y	0.220/0.485	
			Rear			

(1) Ith = 20 A.

(2) Bodies using the Ø 22 mm/0.87 in. hole mounting method that can be fitted with chromium plated metal bezel operating heads, type **KAXZ1000**.

Cam switches

Adaptable sub-assemblies, 12 and 20 A

Bodies (contact blocks + fixing plate)

To combine with operating heads:
see page 4/34

Reversing star-delta switches (continued)

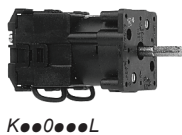

Wiring diagram	Switching programme	Switch position	Mounting method	Reference (2)	Weight kg/lb
With slave contact					
			Front Multi-fixing	K2M007YL	0.241/0.531
			By Ø 22 mm/ 0.87 in. hole	K2M007Y	0.225/0.496
			Rear	K2M507Y	0.245/0.540

Pole change switches for 2-speed motors



Wiring diagram	Switching programme	Switch position	Mounting method	Reference to be completed (1)	Weight kg/lb
For motors with 2 separate windings					
			Front Multi-fixing	K●F001PL	0.156/0.344
			By Ø 22 mm/ 0.87 in. hole	K●F001P	0.140/0.309
			Rear	K●F001PX (3)	0.218/0.481
				K●F501P	0.175/0.386

For motors with 2 separate windings, with centre "0" position

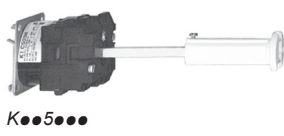

Wiring diagram	Switching programme	Switch position	Mounting method	Reference to be completed (1)	Weight kg/lb
			Front Multi-fixing	K●F002PL	0.156/0.344
			By Ø 22 mm/ 0.87 in. hole	K●F002P	0.140/0.309
			Rear	K●F002PX (3)	0.218/0.481
				K●F502P	0.175/0.386

For motors with tapped "Dahlander" windings



Wiring diagram	Switching programme	Switch position	Mounting method	Reference to be completed (1)	Weight kg/lb
			Front Multi-fixing	K●H004PL	0.181/0.399
			By Ø 22 mm/ 0.87 in. hole	K●H004P	0.165/0.364
			Rear	K●H004PX (3)	0.243/0.536
				K●H504P	0.195/0.430

(1) To order a cam switch with thermal current $I_{th} = 12 A$, replace the ● in the reference by 1.

Example **K1F001P**.

To order a cam switch with thermal current $I_{th} = 20 A$, replace the ● in the reference by 2.

Example **K2F001P**.

(2) $I_{th} = 20 A$.

(3) Bodies using the Ø 22 mm/0.87 in. hole mounting method that can be fitted with chromium plated metal bezel operating heads, type **KAXZ1●●●**.

Cam switches

Adaptable sub-assemblies, 12 and 20 A

Bodies (contact blocks + fixing plate)

To combine with operating heads:
see page 4/34

Pole change switches for 2-speed motors (continued)

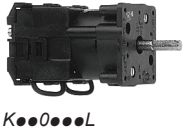

Wiring diagram	Switching programme	Switch position	Mounting method	Reference to be completed (1)	Weight kg/lb
For motors with tapped "Dahlander" windings, with centre "0" position					
			Front Multi-fixing	K●H005PL	0.181/0.399
			By Ø 22 mm/ 0.87 in. hole	K●H005P	0.165/0.364
				K●H005PX (2)	0.243/0.536
			Rear	K●H505P	0.195/0.430

4



Wiring diagram	Switching programme	Switch position	Mounting method	Reference to be completed (1)	Weight kg/lb
Reversing pole change switches for 2-speed motors					
For motors with 2 separate windings, with centre "0" position					
			Front Multi-fixing	K●K008PL	0.211/0.465
			By Ø 22 mm/ 0.87 in. hole	K●K008P	0.195/0.430
			Rear	K●K508P	0.220/0.485

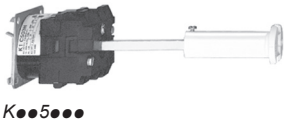

For motors with tapped "Dahlander" windings, with centre "0" position					
			Front Multi-fixing	K●M009PL	0.241/0.531
			By Ø 22 mm/ 0.87 in. hole	K●M009P	0.225/0.496
			Rear	K●M509P	0.245/0.540



(1) To order a cam switch with thermal current $I_{th} = 12 A$, replace the ● in the reference by 1.
Example **K1H005P**.
To order a cam switch with thermal current $I_{th} = 20 A$, replace the ● in the reference by 2.
Example **K2H005P**.

(2) Bodies using the Ø 22 mm/0.87 in. hole mounting method that can be fitted with chromium plated metal bezel operating heads, type **KAXZ1●●●**.

Cam switches

Adaptable sub-assemblies, 12 and 20 A

Bodies (contact blocks + fixing plate)

To combine with operating heads:
see page 4/34

Pole change switches for 3-speed motors

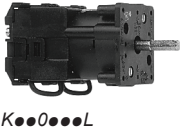

K●●0●●●L

Wiring diagram	Switching programme	Switch position	Mounting method	Reference to be completed (1)	Weight kg/lb	
For motors with open tapped "Dahlander" winding and separate winding for low speed						
			Front	Multi-fixing	K●L010PL	0.231/0.509
				By \varnothing 22 mm/ 0.87 in. hole	K●L010P	0.215/0.474
			Rear		K●L510P	0.240/0.529



K●●0●●●

For motors with open tapped "Dahlander" winding and separate winding for intermediate speed						
			Front	Multi-fixing	K●L011PL	0.231/0.509
				By \varnothing 22 mm/ 0.87 in. hole	K●L011P	0.215/0.474
			Rear		K●L511P	0.240/0.529



K●●5●●●

For motors with open tapped "Dahlander" winding and separate winding for high speed						
			Front	Multi-fixing	K●L012PL	0.231/0.509
				By \varnothing 22 mm/ 0.87 in. hole	K●L012P	0.215/0.474
			Rear		K●L512P	0.240/0.529



K●●0●●●X

(1) To order a cam switch with thermal current $I_{th} = 12$ A, replace the ● in the reference by 1.
Example **K1L010P**.
To order a cam switch with thermal current $I_{th} = 20$ A, replace the ● in the reference by 2.
Example **K2L010P**.

Cam switches

Adaptable sub-assemblies, 12 and 20 A

Operating heads

To combine with bodies: see pages 4/2 to 4/33



KBG3H



KCG3Y

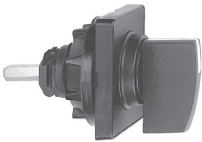

KAC1H

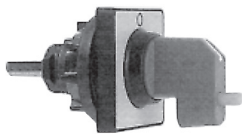

KCC1Y



KBC1

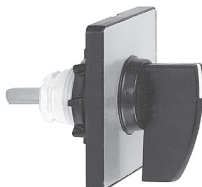

KBD1H

Heads for "multi-fixing" front mounting bodies

Description	Switching angle and marking	Type of operator	Background colour of legend	Padlocking device	Reference	Weight kg/lb
With 45 x 45 mm/1.77 x 1.77 in. front plate and handle						
With blank legend (for engraving by user)	–	Black handle L = 35 mm/1.38 in.	Matt black Metallic	Without Without	KAG3H KBG3H	0.012/0.026 0.012/0.026
With marked legend	90°	Red handle L = 35 mm/1.38 in.	Yellow	Without With	KCG3H KCG3Y	0.012/0.026 0.024/0.053
Without legend (1)	–	Black handle L = 35 mm/1.38 in. Red handle L = 35 mm/1.38 in.	–	Without With	KDG3H KDG3Y	0.010/0.022 0.022/0.048

Heads for Ø 22 mm/0.87 in. hole, front mounting bodies

Description	Switching angle and marking	Type of operator	Background colour of legend	Padlocking device	Reference	Weight kg/lb
With 45 x 45 mm/1.77 x 1.77 in. front plate and handle						
With blank legend (for engraving by user)	–	Black handle L = 35 mm/1.38 in.	Matt black Metallic	Without Without	KAC1H KBC1H	0.048/0.106 0.048/0.106
With marked legend	45°	Black handle L = 35 mm/1.38 in.	Matt black Metallic	Without Without	KAC1H41 KBC1H41	0.012/0.026 0.012/0.026
	45°	Black handle L = 35 mm/1.38 in.	Matt black Metallic	Without Without	KAC1H48 KBC1H48	0.012/0.026 0.012/0.026
	60°	Black handle L = 35 mm/1.38 in.	Matt black Metallic	Without Without	KAC1H61 KBC1H61	0.048/0.106 0.048/0.106
	90°	Red handle L = 35 mm/1.38 in.	Yellow	Without With	KCC1LH KCC1Y	0.048/0.106 0.060/0.132
Without legend (1)	–	Black handle L = 35 mm/1.38 in. Red handle L = 35 mm/1.38 in.	–	Without Without	KDC1H KDC1LH	0.046/0.101 0.046/0.101

With 45 x 45 mm/1.77 x 1.77 in. front plate and key operator (2)

With blank legend (for engraving by user)	45° and 90°	Key (2)	Matt black Metallic	Without Without	KAC1S KBC1S	0.063/0.139 0.063/0.139
	60°	Key (2)	Matt black Metallic	Without Without	KAC1Z KBC1Z	0.063/0.139 0.063/0.139
Without legend (1)	45° and 90°	Key (2)	–	Without	KDC1S	0.061/0.134
	60°	Key (2)	–	Without	KDC1Z	0.061/0.134

With 60 x 60 mm/2.36 x 2.36 in. front plate and handle

With blank legend (for engraving by user)	–	Black handle L = 42 mm/1.65 in.	Matt black Metallic	Without Without	KAD1H KBD1H	0.053/0.117 0.053/0.117
With marked legend	90°	Red handle L = 42 mm/1.65 in.	Yellow	Without	KCD1MH	0.053/0.117
Without legend (1)	–	Black handle L = 42 mm/1.65 in.	–	Without	KDD1H	0.053/0.117

(1) For separate marked legend ordering information, see pages 4/36 to 4/39.

(2) Head supplied with "Ronis" 8R1 key. To order a head with a "Ronis" 455 key, add the suffix **R** to the references listed above. Example: reference for Ø 22 mm/0.87 in. hole, front mounting 45 x 45 mm/1.77 x 1.77 in. operating head with 45° switching angle and matt black legend, becomes **KAC1SR**. For a head with "Ronis" 8R15 key, use the suffix **R1**.

To combine with bodies: see pages 4/2 to 4/33

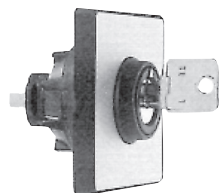

KBD1●



KBA1H



KBA1●



KAXZ1C12



KBE1H

Heads for Ø 22 mm/0.87 in. hole, front mounting bodies (continued)

Description	Switching angle and marking	Type of operator	Background colour of legend	Padlocking device	Reference	Weight kg/lb
With 60 x 60 mm/2.36 x 2.36 in. front plate and key operator (1)						
With blank legend (to be engraved by user)	45° and 90°	Key (1)	Matt black	Without	KAD1S	0.068/0.150
			Metallic	Without	KBD1S	0.068/0.150
	60°	Key (1)	Matt black	Without	KAD1Z	0.068/0.150
			Metallic	Without	KBD1Z	0.068/0.150
Without legend (2)	45° and 90°	Key (1)	–	Without	KDD1S	0.066/0.145
	60°	Key (1)	–	Without	KDD1Z	0.066/0.145

Description	Switching angle and marking	Type of operator	Colour of bezel	Padlocking device	Reference	Weight kg/lb
With Ø 29 mm/1.14 in., metallic finish, plastic bezel and handle or key operator (1)						
Circular heads	–	Black handle L = 35 mm/1.38 in.	Matt black	Without	KAA1H	0.042/0.093
			Metallic	Without	KBA1H	0.042/0.093
	45°	Key (1)	Matt black	Without	KAA1S	0.057/0.126
			Metallic	Without	KBA1S	0.057/0.126
	60°	Key (1)	Matt black	Without	KAA1Z	0.057/0.126
			Metallic	Without	KBA1Z	0.057/0.126

With Ø 38 mm/1.50 in., black, plastic bezel and handle						
Circular head	–	Black handle L = 35 mm/1.38 in.	Matt black	Without	KAA2H	0.048/0.106

With Ø 28.5 mm/1.12 in., chromium plated, metal bezel (3) (2) and standard, handle, long handle or key operator (4)						
Circular heads	–	Standard black handle	Metal	Without	KAXZ1M12	0.040/0.088
		Standard red handle	Metal	Without	KAXZ1M14	0.040/0.088
		Long black handle	Metal	Without	KAXZ1C12	0.040/0.088
		Long red handle	Metal	Without	KAXZ1C14	0.040/0.088
	30°	Key	Metal	Without	KAXZ1S13● (4)	0.065/0.143
	45°	Key	Metal	Without	KAXZ1S14● (4)	0.065/0.143
	60°	Key	Metal	Without	KAXZ1S16● (4)	0.065/0.143
	90°	Key	Metal	Without	KAXZ1S19● (4)	0.065/0.143

Operating heads for 4 hole, rear mounting bodies

Description	Switching angle and marking	Type of operator	Background colour of legend	Padlocking device	Reference	Weight kg/lb
With 45 x 45 mm/1.77 x 1.77 in. front plate and handle						
With blank legend (to be engraved by user)	–	Black handle L = 35 mm/1.38 in.	Matt black	Without	KAE1H	0.029/0.064
			Metallic	Without	KBE1H	0.029/0.064
With marked legend	90°	Red handle L = 35 mm/1.38 in.	Yellow	Without	KCE1LH	0.029/0.064
				With	KCE1Y	0.060/0.132
Without legend (2)	–	Black handle L = 35 mm/1.38 in.	–	Without	KDE1H	0.027/0.059
			Red handle L = 35 mm/1.38 in.	–	Without	KDE1LH
With 60 x 60 mm/2.36 x 2.36 in. front plate and handle						
With blank legend (to be engraved by user)	–	Black handle L = 42 mm/1.65 in	Matt black	Without	KAF1H	0.068/0.150
			Metallic	Without	KBF1H	0.068/0.150
With marked legend	90°	Red handle L = 42 mm/1.65 in	Yellow	Without	KCF1MH	0.068/0.150
Without legend (2)	–	Black handle L = 42 mm/1.65 in	–	Without	KDF1H	0.066/0.145

(1) Head supplied with "Ronis" 8R1 key. To order a head with a "Ronis" 455 key, add the suffix **R** to the references listed above.
Example: reference for operating head with 60 x 60 mm/2.36 x 2.36 in. front plate, key operator, blank legend, 45° switching angle and matt black background, becomes **KAD1SR**. For a head with "Ronis" 8R15 key, use the suffix **R1**.

(2) For separate marked legend ordering information, see pages 4/36 to 4/39.

(3) Heads **only** for use with bodies K●●●●●X, incorporating adaptor plate **KZ127**. See pages 4/2 to 4/32.

(4) To order:

- a head with key n° 455, replace the ● in the reference by 1. Example: **KAXZ1S131**,

- a head with key n° 421, replace the ● in the reference by 2. Example: **KAXZ1S132**,

- a head with key n° 520, replace the ● in the reference by 3. Example: **KAXZ1S133**,

- a head with a special key, replace the ● in the reference by 9. Example: **KAXZ1S139** (state the key number on the order).

Key withdrawal from all positions.

Cam switches

Adaptable sub-assemblies, 12 and 20 A
Legends for **MULTI-FIXING** heads

45 x 45 mm/1.77 x 1.77 in. legends - marked (1)

White text on black background

30°

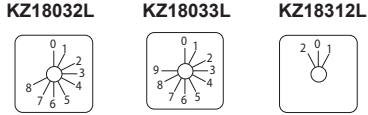

45°

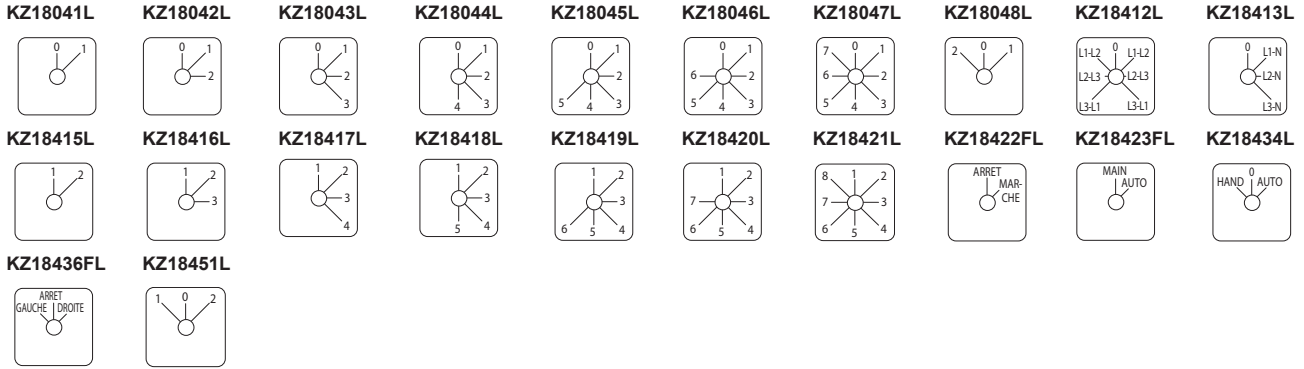

60°

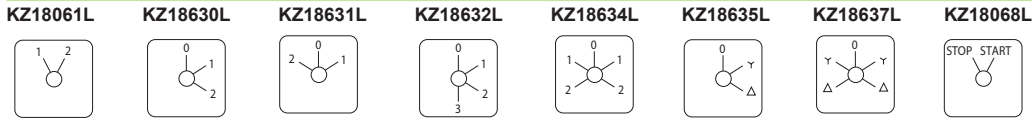

90°

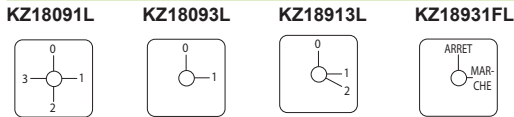

Black text on yellow background

45°

KZ19041L



90°



45 x 45 mm/1.77 x 1.77 in. legends - unmarked

Colour	Sold in lots of	Unit reference	Weight kg/lb
Black	20	KZ17L	0.003/0.007
Metallic	20	KZ18L	0.003/0.007
Yellow	10	KZ19L	0.003/0.007

(1) Weight = 0.003 kg/0.007 lb.

Cam switches

Adaptable sub-assemblies, 12 and 20 A
Legends for $\varnothing 22$ mm HOLE mounting heads with plastic bezel

45 x 45 mm/1.77 x 1.77 in. legends - marked (1)

Black text on metallic background

30°

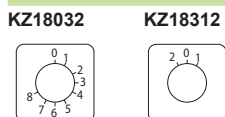

45°

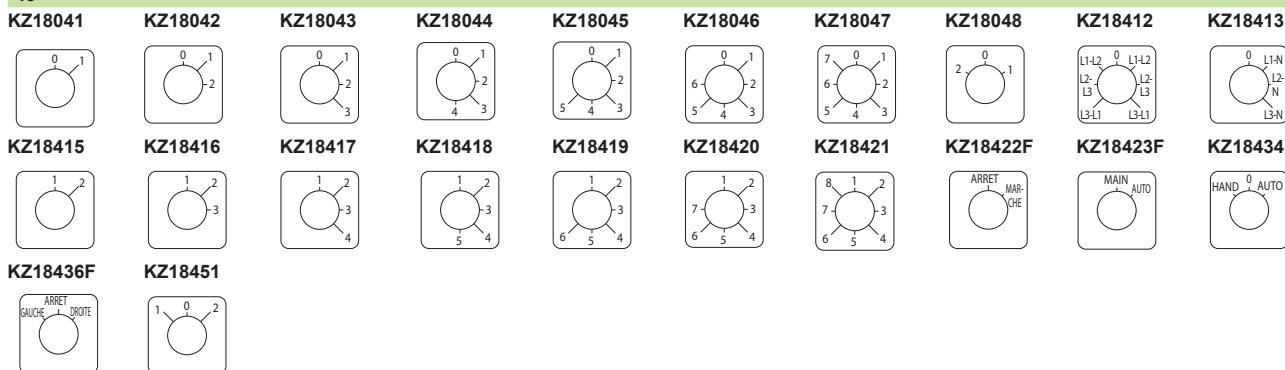

60°

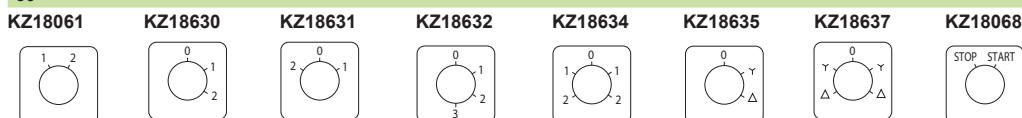

90°

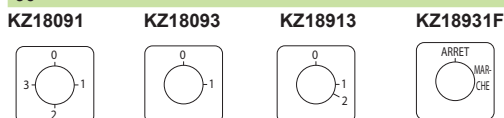

Black text on yellow background

45°

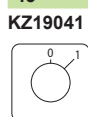

90°

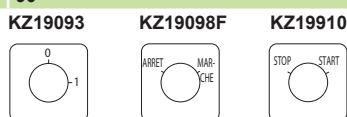

45 x 45 mm/1.77 x 1.77 in.. legends - unmarked

Colour	Sold in lots of	Unit reference	Weight kg/lb
Black	20	KZ17	0.003/0.007
Metallic	20	KZ18	0.003/0.007
Yellow	10	KZ19	0.003/0.007

60 x 60 mm/2.36 x 2.36 in. legends - marked (2)

Black text on metallic background

45°

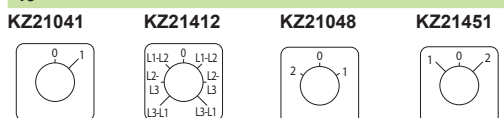

60°

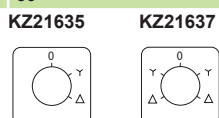

90°

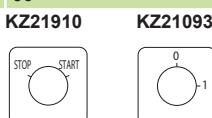

60 x 60 mm/2.36 x 2.36 in. legends - unmarked

Colour	Sold in lots of	Unit reference	Weight kg/lb
Black	20	KZ20	0.003/0.007
Metallic	20	KZ21	0.003/0.007
Yellow	10	KZ22	0.003/0.007

(1) Weight = 0.003 kg/0.007 lb.

(2) Weight = 0.005 kg/0.011 lb.

Cam switches

Adaptable sub-assemblies, 12 and 20 A

Legends for Ø 22 mm HOLE mounting heads with chromium plated metal bezel, type KAXZ1●●●

46 x 46 mm - marked (PVC) (1)

White text on black background

30°

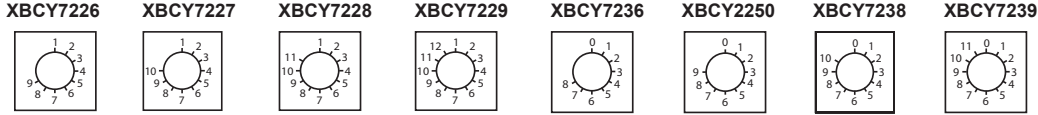

45°

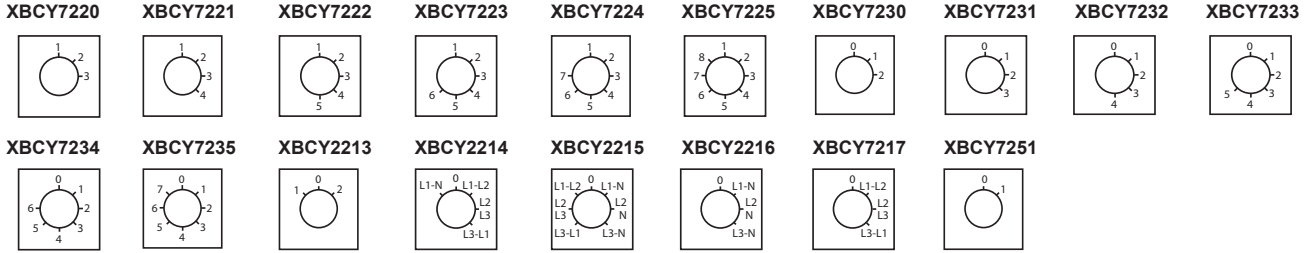

60°

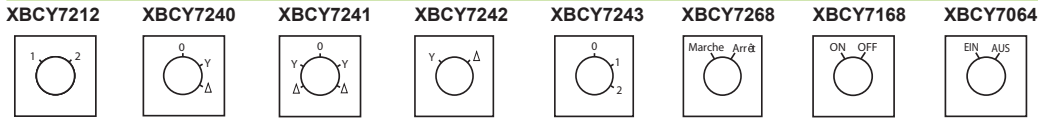

90°

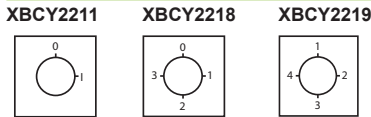

46 x 46 mm legends - unmarked (PVC)

Colour	Sold in lots of	Unit reference	Weight kg/lb
Black/red	10	KZ17X	0.004/0.009
White/yellow	10	KZ19X	0.004/0.009

(1) Weight = 0.004 kg/0.009 lb.

4

Cam switches

Adaptable sub-assemblies, 12 and 20 A Legend holders for heads

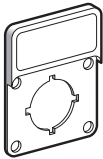

KZ13

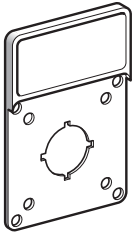

KZ15



KZ01R



KZ2

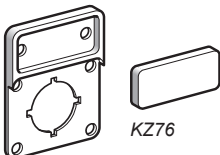

KZ14

KZ76

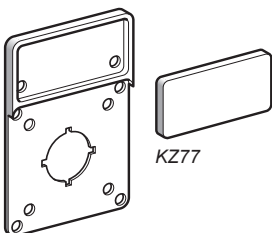

KZ16

KZ77

Legend holders with and without legend					
Description	For use with heads	Legend marking	Sold in lots of	Unit reference	Weight kg/lb
With blank legend	With 45 x 45 mm/1.77 x 1.77 in. front – plate (1)		5	KZ13	0.004/0.009
	With 60 x 60 mm/2.36 x 2.36 in. front plate (1)	–	5	KZ15	0.010/0.022
	Circular, with Ø 29 mm/1.14 in. collar	–	5	KZ01R	0.010/0.022
With marked legend	Circular, with Ø 29 mm/1.14 in. collar	1 2	1	KZ1	0.003/0.007
		2 0 1	5	KZ2	0.003/0.007
Without legend	With 45 x 45 mm/1.77 x 1.77 in. front plate (1)	–	20	KZ14	0.003/0.007
	With 60 x 60 mm/2.36 x 2.36 in. front plate (1)	–	10	KZ16	0.007/0.015
Blank legends (for engraving) for legend holders					
Description	For use with heads		Sold in lots of	Unit reference	Weight kg/lb
Legend for legend holder KZ14 Plastic with metallic finish. Self-adhesive. For engraved markings.	With 45 x 45 mm/1.77 x 1.77 in. front plate (1)		20	KZ76	0.002/0.004
Legend for legend holder KZ16 Plastic with metallic finish. Self-adhesive. For engraved markings.	With 60 x 60 mm/2.36 x 2.36 in. front plate (1)		10	KZ77	0.003/0.007

(1) Operating heads for single Ø 22 mm/0.87 in. hole or 4 hole mounting.

Cam switches

Complete switches, 12 and 20 A
Separate components and accessories



KZ27H

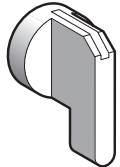

KZ27

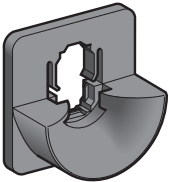

KZ32

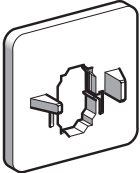

KZ83



KZ127

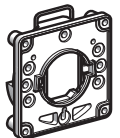

KZ140

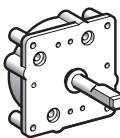

KZ141

Handles					
Description	Colour	Dimensions	Sold in lots of	Unit reference	Weight
		mm/in.			kg/lb
New shape	Black	35/1.38	5	KZ27H	0.007/0.015
		42/1.65	5	KZ28H	0.009/0.020
	Red	35/1.38	5	KZ41H	0.007/0.015
Old shape	Black	34/1.34	5	KZ27	0.007/0.015
		42/1.65	5	KZ28	0.009/0.020

Accessories					
Description	For use with	Dimensions	Sold in lots of	Unit reference	Weight
		mm/in.			kg/lb
Door interlocking plate	Rear mounting switches	45 x 45/ 1.77 x 1.77	5	KZ32	0.010/0.022
Plate with rubber seal	Rear mounting switches. IP 65 between front plate and operating head	60 x 60/ 2.36 x 2.36	5	KZ83	0.018/0.040
Adaptor plate, metal (replacement)	Mounting KAXZ1●●● chromium plated metal bezel heads on front mounting bodies for Ø 22 mm/0.87 in. hole	–	1	KZ127	0.088/0.194
Plastic plate (replacement)	Ø 22 mm/0.87 in. hole, front mounting, clip-in bodies	–	1	KZ140	0.010/0.022
Multi-fixing plate (replacement)	"Multi-fixing", front mounting, – bodies	–	1	KZ141	0.026/0.057

Cam switches

Complete switches, 12 and 20 A

Separate components and accessories

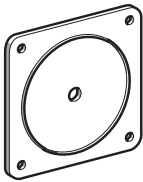

KZ6●

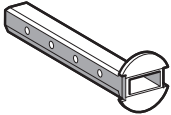

KZ5●

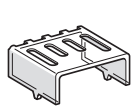

KZ3●

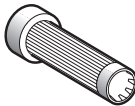

Z01



KZ30



KZ93

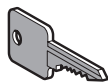

Z18

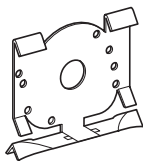

KZ31



KZ95

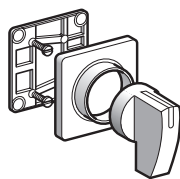

KZ91H

Accessories (continued)

Description	For use with		Sold in lots of	Unit reference	Weight kg/lb
Rubber seals for IP 65 degree of protection	Ø 22 mm/0.87 in. or 4 hole, front mounting, operating heads with 45 x 45 mm/1.77 x 1.77 in. front plate		5	KZ65	0.003/0.007
	Ø 22 mm/0.87 in. or 4 hole, front mounting, operating heads with 60 x 60 mm/2.36 x 2.36 in. front plate		5	KZ66	0.004/0.009
	Multi-fixing operating heads with 45 x 45 mm/1.77 x 1.77 in. front plate		5	KZ73	0.004/0.009
Shaft couplers	Ø 6 mm/0.24 in. shaft	Length = 26 mm/1.02 in.	3	KZ52	0.007/0.015
		Length = 60 mm/2.36 in.	3	KZ50	0.013/0.029
Terminal covers	Contact blocks	4 contacts	1	KZ35	0.010/0.022
		8 contacts	1	KZ36	0.020/0.044
		12 contacts	1	KZ37	0.004/0.009
		16 contacts	1	KZ38	0.040/0.088
		20 contacts	1	KZ39	0.050/0.110
Nut wrench	M22 fixing nuts		5	Z01	0.010/0.022
Fixing nut, M22	Fixing operating heads on panel or in an enclosure		5	KZ30	0.007/0.015
Mounting adaptor	Converting Ø 30.5 mm/1.20 in. fixing hole to Ø 22.5 mm/0.88 in.		50	KZ93	0.003/0.007
Keys	8D1 key lock		2	Z18	0.010/0.022
	"Ronis" 8R1 key lock		2	Z18R1	0.010/0.022
	"Ronis" 455 key lock		2	Z18R	0.010/0.022
	"Ronis" 8R15 key lock		2	Z18R15	0.010/0.022
Quick assembly device	Mounting on 35 mm/1.38 in. rails to DIN 46277. 2 fixing screws included for rear mounting		5	KZ31	0.030/0.066
Fixing screws 3.5 x 16 mm/0.14x 0.63 in.	4 hole fixing operating heads		100	KZ95	0.001/0.066
Cam switch installation kit	Installation of a cam switch on a distribution panel Comprising: - mounting plate, - 45 x 45 mm/1.77 x 1.77 in. front plate, without legend - black handle, length 35 mm/1.38 in. (KZ27H), - 2 fixing screws		1	KZ91H	0.010/0.022

Complete switches, 12 A with key operated lock

- Front mounting by 6 screws Ø 5.2 mm, with 55 x 100mm front plate
- Stepping switches, 2 to 5 step..... 5/2
- Start selector switches changeover switches..... 5/6
- Changeover switches 5/7

Cam switches

Complete switches, 12 A with key operated lock
 Front mounting by 6 screws Ø 5.2 mm
 with 55 x 100 mm front plate

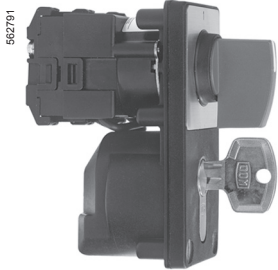

K1C003NZ2

Stepping switches (3 step), without "0" position

Wiring diagram and switching programme	Marking and switch position	Colour of handle	Reference	Weight kg/lb
--	-----------------------------	------------------	-----------	--------------

1-pole				
 		Red	K1C003NZ2	0.170/0.374
		Black	K1C003NZ4	0.170/0.374

2-pole				
 		Red	K1F013NZ2	0.170/0.374
		Black	K1F013NZ4	0.170/0.374

3-pole				
 		Red	K1I023NZ2	0.170/0.374
		Black	K1I023NZ4	0.170/0.374

Cam switches

Complete switches, 12 A with key operated lock
 Front mounting by 6 screws Ø 5.2 mm
 with 55 x 100 mm front plate

Stepping switches (4 step), 4-pole, without "0" position

Wiring diagram and switching programme	Marking and switch position	Colour of handle	Reference	Weight kg/lb
--	-----------------------------	------------------	-----------	--------------

4 step (1)

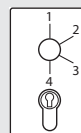
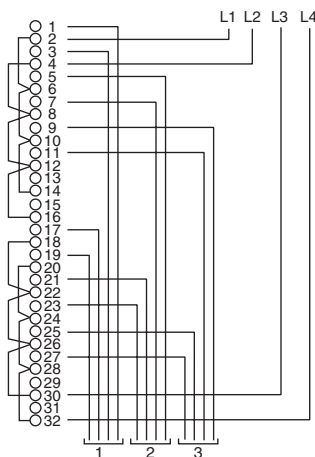

Red **K1Q034NZ2** 0.170/0.374

Black **K1Q034NZ4** 0.170/0.374

4 step with intermediate steps at 30°

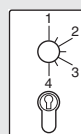
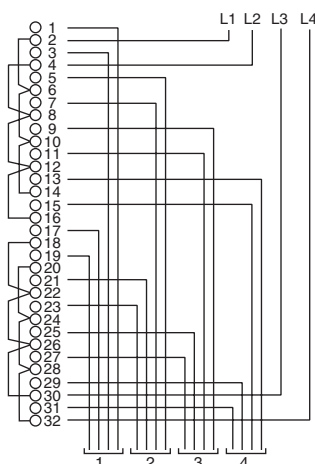

Red **K1Q8621Z1** 0.170/0.374

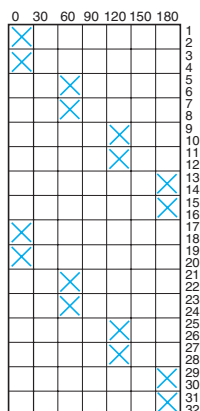

(1) Switching programme identical for 4 step and 4 step with intermediate steps at 30°.

Cam switches

Complete switches, 12 A with key operated lock
 Front mounting by 6 screws Ø 5.2 mm
 with 55 x 100 mm front plate

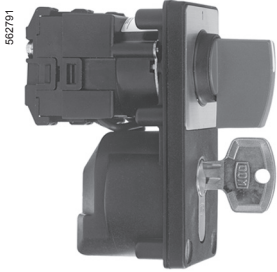

K1D012QZ2

Stepping switches (2 step), with "0" position

Wiring diagram and switching programme	Marking and switch position	Colour of handle	Reference	Weight kg/lb
--	-----------------------------	------------------	-----------	--------------

2-pole

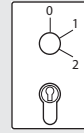
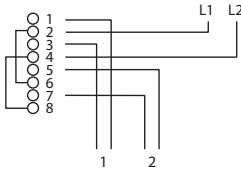

Red **K1D012QZ2** 0.170/0.374

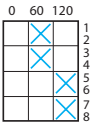

Black **K1D012QZ4** 0.170/0.374

3-pole

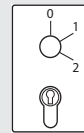
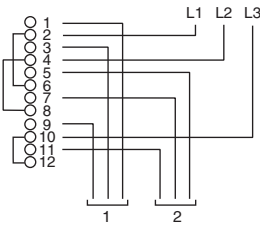

Red **K1F022QZ2** 0.170/0.374

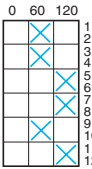

Black **K1F022QZ4** 0.170/0.374

4-pole

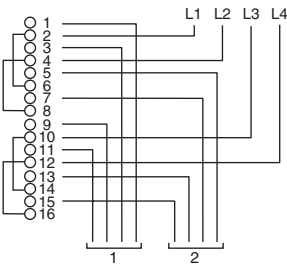

Red **K1H032QZ2** 0.170/0.374

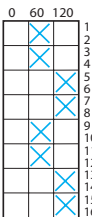

Black **K1H032QZ4** 0.170/0.374

Cam switches

Complete switches, 12 A with key operated lock
 Front mounting by 6 screws Ø 5.2 mm
 with 55 x 100 mm front plate

Stepping switches (3 step), 2-pole, with "0" position

Switching programme	Marking and switch position	Colour of handle	Reference	Weight kg/lb
---------------------	-----------------------------	------------------	-----------	--------------

3 step with intermediate steps at 30°

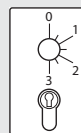
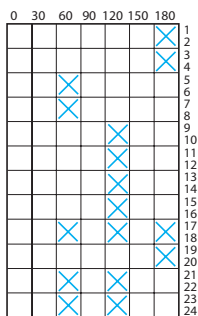

Red **K1M10317Z1** 0.170/0.374

Stepping switches (5 step), 2-pole, with "0" position

Wiring diagram and switching programme	Marking and switch position	Colour of handle	Reference	Weight kg/lb
--	-----------------------------	------------------	-----------	--------------

5 step (1)

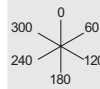
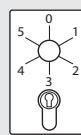
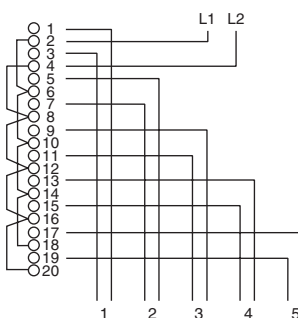

Red **K1K015NZ2** 0.170/0.374

Black **K1K015NZ4** 0.170/0.374

5 step with intermediate steps at 30°

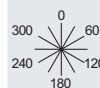
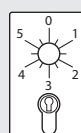
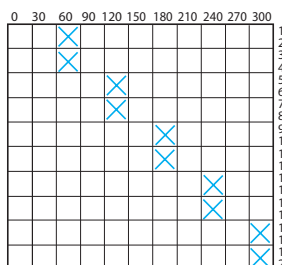

Red **K1K1060Z1** 0.170/0.374

(1) Switching programme identical for 5 step and 5 step with intermediate steps at 30°.



Cam switches

Complete switches, 12 A with key operated lock
 Front mounting by 6 screws Ø 5.2 mm
 with 55 x 100 mm front plate

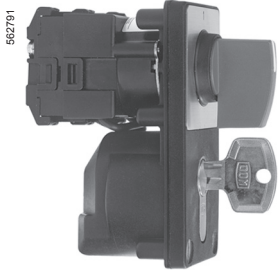

K1D032RZ2

Start selector switches (3-position) with "0" position

Switching programme	Marking and switch position	Colour of handle	Reference	Weight kg/lb
---------------------	-----------------------------	------------------	-----------	--------------

1-pole

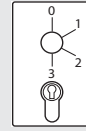
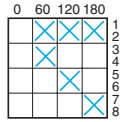

Red **K1D032RZ2** 0.170/0.374



Black **K1D032RZ4** 0.170/0.374

2-pole

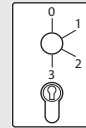
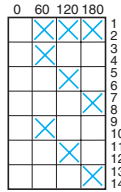

Red **K1G043RZ2** 0.170/0.374



Black **K1G043RZ4** 0.170/0.374

2-pole with intermediate positions at 30°

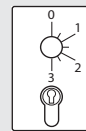
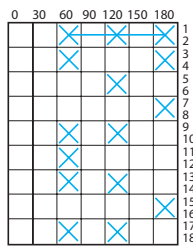

Red **K1I9289Z1** 0.170/0.374



Cam switches

Complete switches, 12 A with key operated lock
 Front mounting by 6 screws Ø 5.2 mm
 with 55 x 100 mm front plate

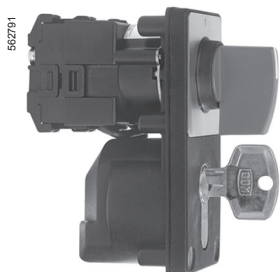

K1B001UZ2

Start selector switches (4-position) with "0" position

Switching programme	Marking and switch position	Colour of handle	Reference	Weight kg/lb
		Red	K1Q10805Z1	0.170/0.374

Changeover switches with "0" position

Wiring diagram and switching programme	Marking and switch position	Colour of handle	Reference	Weight kg/lb
1-pole 		Red	K1B001UZ2	0.170/0.374
		Black	K1B001UZ4	0.170/0.374
2-pole 		Red	K1D002UZ2	0.170/0.374
		Black	K1D002UZ4	0.170/0.374
3-pole 		Red	K1F003UZ2	0.170/0.374
		Black	K1F003UZ4	0.170/0.374



Switches, 10 and 16 A, mounted in plastic enclosure

- Emergency stop switches..... 6/2
- OFF-ON switches..... 6/3

Cam switches

Switches mounted in plastic enclosure,
10 and 16 A



KA●●●●●G

“Emergency stop” switches in enclosure

Specifications

- PVC enclosure.
- 60 x 60 mm/2.36 x 2.36 in. operating head, red handle (without padlocking device) (1) on yellow background. Marking: O I.
- Legend holder with metallic finish blank legend.
- Protection degree (conforming to standard EN/IEC 60529): IP 65.

Composition (2)				Dimensions w x h x d (3)	Thermal current (Ithe) (4)	Reference	Weight
Poles	N	N/O	N/C				
				mm/in.	A		kg/lb
1	-	-	-	74 x 135 x 106/ 2.91 x 5.31 x 4.17	10 16	KA1A050G KA2A050G	0.365/0.805 0.365/0.805
3	-	-	-	74 x 135 x 106/ 2.91 x 5.31 x 4.17	10 16	KA1C051G KA2C051G	0.390/0.860 0.390/0.860
3	1	-	-	74 x 135 x 106/ 2.91 x 5.31 x 4.17	10 16	KA1D052G KA2D052G	0.400/0.882 0.400/0.882
3	-	1	-	74 x 135 x 106/ 2.91 x 5.31 x 4.17	10 16	KA1D053G KA2D053G	0.400/0.882 0.400/0.882
3	-	1	1	105 x 170 x 146/ 4.13 x 6.69 x 5.74	10 16	KA1E054G KA2E054G	0.694/1.530 0.694/1.530
3	-	2	2	105 x 170 x 146/ 4.13 x 6.69 x 5.74	10 16	KA1G055G KA2G055G	0.719/1.585 0.719/1.585
3	1	1	1	105 x 170 x 146/ 4.13 x 6.69 x 5.74	10 16	KA1F056G KA2F056G	0.704/1.552 0.704/1.552
6	-	-	-	105 x 170 x 146/ 4.13 x 6.69 x 5.74	10 16	KA1F057G KA2F057G	0.704/1.552 0.704/1.552
6	1	-	-	105 x 170 x 146/ 4.13 x 6.69 x 5.74	10 16	KA1G058G KA2G058G	0.719/1.585 0.719/1.585
6	-	1	-	105 x 170 x 146/ 4.13 x 6.69 x 5.74	10 16	KA1G059G KA2G059G	0.719/1.585 0.719/1.585
6	-	1	1	105 x 170 x 146/ 4.13 x 6.69 x 5.74	10 16	KA1H060G KA2H060G	0.724/1.596 0.724/1.596
9	-	-	-	105 x 170 x 146/ 4.13 x 6.69 x 5.74	10 16	KA1I061G KA2I061G	0.744/1.640 0.744/1.640
9	1	-	-	105 x 170 x 146/ 4.13 x 6.69 x 5.74	10 16	KA1K062G KA2K062G	0.749/1.651 0.719/1.585
9	-	1 (5)	-	105 x 170 x 146/ 4.13 x 6.69 x 5.74	10 16	KA1K063G KA2K063G	0.719/1.585 0.719/1.585

(1) To order a switch with a red padlockable handle (up to 3 padlocks), replace the letter A (2nd letter) in the references shown above by the letter C.
Example : KA1A050G becomes KC1A050G.

(2) Poles : main contacts

- N/O contact : late make (unballasting contact)
- N/C contact : signaling contact
- Neutral conductor (N) : early make, late break.

(3) Total depth, including operating head.

(4) Permissible power, AC-23 at 400 V :

- K1 switches : 2.2 kW,
- K2 switches : 5.5 kW.

(5) Contact not late make.

Cam switches

Switches mounted in plastic enclosure,
10 and 16 A

KD●●●●●G

OFF-ON switches in enclosure

Specifications

- PVC enclosure.
- 60 x 60 mm/2.36 x 2.36 in. operating head, black handle (without padlocking device) on metallic background. Marking: O I.
- Legend holder with metallic finish blank legend.
- Protection degree (conforming to standard EN/IEC 60529): IP 65.

Composition (1)				Dimensions w x h x d (2)	Thermal current (Ithe) (3)	Reference	Weight
Poles	N	N/O	N/C				
				mm/in.	A		kg/lb
1	-	-	-	74 x 135 x 106/ 2.91 x 5.31 x 4.17	10	KD1A050G	0.365/0.805
					16	KD2A050G	0.365/0.805
3	-	-	-	74 x 135 x 106/ 2.91 x 5.31 x 4.17	10	KD1C051G	0.390/0.860
					16	KD2C051G	0.390/0.860
3	1	-	-	74 x 135 x 106/ 2.91 x 5.31 x 4.17	10	KD1D052G	0.400/0.882
					16	KD2D052G	0.400/0.882
3	-	1	-	74 x 135 x 106/ 2.91 x 5.31 x 4.17	10	KD1D053G	0.400/0.882
					16	KD2D053G	0.400/0.882
3	-	1	1	105 x 170 x 146/ 4.13 x 6.69 x 5.74	10	KD1E054G	0.694/1.530
					16	KD2E054G	0.694/1.530
3	-	2	2	105 x 170 x 146/ 4.13 x 6.69 x 5.74	10	KD1G055G	0.719/1.585
					16	KD2G055G	0.719/1.585
3	1	1	1	105 x 170 x 146/ 4.13 x 6.69 x 5.74	10	KD1F056G	0.704/1.552
					16	KD2F056G	0.704/1.552
6	-	-	-	105 x 170 x 146/ 4.13 x 6.69 x 5.74	10	KD1F057G	0.704/1.552
					16	KD2F057G	0.704/1.552
6	1	-	-	105 x 170 x 146/ 4.13 x 6.69 x 5.74	10	KD1G058G	0.719/1.585
					16	KD2G058G	0.719/1.585
6	-	1	-	105 x 170 x 146/ 4.13 x 6.69 x 5.74	10	KD1G059G	0.719/1.585
					16	KD2G059G	0.719/1.585
6	-	1	1	105 x 170 x 146/ 4.13 x 6.69 x 5.74	10	KD1H060G	0.724/1.596
					16	KD2H060G	0.724/1.596
9	-	-	-	105 x 170 x 146/ 4.13 x 6.69 x 5.74	10	KD1I061G	0.744/1.640
					16	KD2I061G	0.744/1.640
9	1	-	-	105 x 170 x 146/ 4.13 x 6.69 x 5.74	10	KD1K062G	0.749/1.651
					16	KD2K062G	0.749/1.651
9	-	1 (4)	-	105 x 170 x 146/ 4.13 x 6.69 x 5.74	10	KD1K063G	0.749/1.651
					16	KD2K063G	0.749/1.651

(1) Poles : main contacts

- N/O contact : late make (unballasting contact)
- N/C contact : signaling contact
- Neutral conductor (N) : early make, late break.

(2) Total depth, including operating head.

(3) Permissible power, AC-23 at 400 V :

- K1 switches : 2.2 kW.
- K2 switches : 5.5 kW.

(4) Contact not late make.

Complete switches, 32 to 150 A

- General 7/2
- With 64 x 64 mm front plate (32 to 63 A ratings) and
88 x 88 mm front plate (115 and 150 A ratings)
- Switches 7/3
- Changeover switches 7/5
- Star-delta and reversing star-delta switches 7/6
- Pole change and reversing switches 7/7

Cam switches

Complete switches, 32 to 150 A

The range of K30 to K150 cam switches (32 to 150 A ratings) comprises only complete switches. These products are more specifically designed for direct control of simple machines.

Complete switches

- switches
- stepping switches
- changeover switches
- voltmeter switches
- ammeter switches
- starting switches

Front mounting

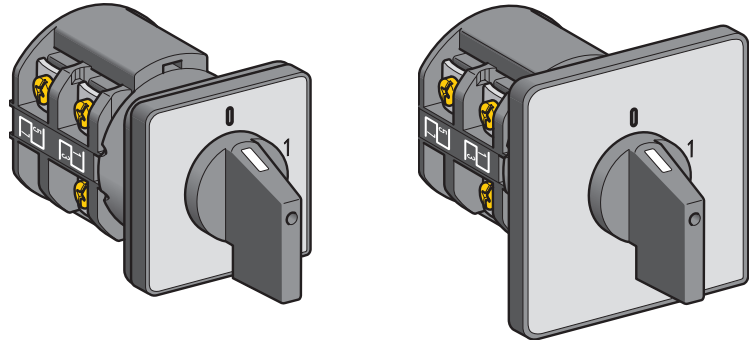

By 4 holes
with 64 x 64 mm/2.52 x 2.52 in. front plate
32 to 63 A ratings
K30, K50 and K63

By 4 holes
with 88 x 88 mm/3.46 x 3.46 in. front plate
115 to 150 A ratings
K115 and K150

"Multi-fixing" mounting

Rear mounting

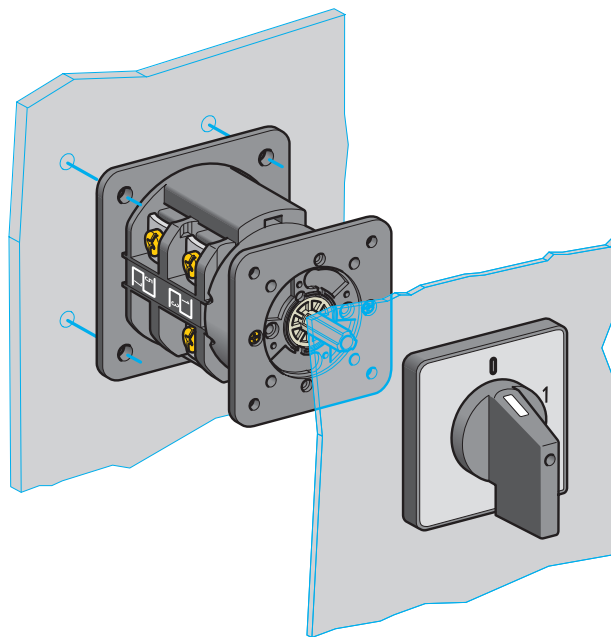

By 4 holes on 48 mm/1.89 in. centres
32 to 63 A ratings
K30, K50 and K63

By 4 holes on 68 mm/2.68 in. centres
115 to 150 A ratings
K115 and K150

Cam switches

Complete switches, 32 to 150 A

With 64 x 64 mm front plate (32 to 63 A ratings)
and 88 x 88 mm front plate (115 and 150 A ratings)



K30C003AP

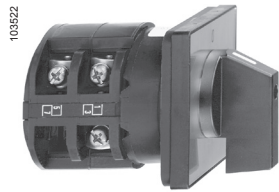

K50C003AP

Switches with 60° switching angle

Front mounting						
Wiring diagram and switching programme	Marking and switch position	Number of poles	Thermal current (Ith)	Reference	Weight	
			A		kg/lb	
		1	32	K30A001AP	0.130/0.287	
			50	K50A001AP	0.175/0.386	
		2	32	K30B002AP	0.170/0.375	
			50	K50B002AP	0.215/0.474	
		3	32	K30C003AP	0.224/0.494	
			50	K50C003AP	0.275/0.606	
			63	K63C003AP	0.345/0.761	
			115	K115C003AP	0.680/1.499	
			150	K150C003AP	0.790/1.742	
		4	32	K30D004AP	0.250/0.551	
			50	K50D004AP	0.305/0.672	
			63	K63D004AP	0.390/0.860	
	115	K115D004AP	0.745/1.642			
	150	K150D004AP	0.880/1.940			
6	32	K30F006AP	0.425/0.937			
	50	K50F006AP	0.530/1.168			
	63	K63F006AP	0.590/1.301			

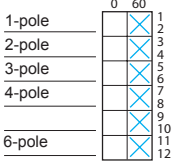

Cam switches

Complete switches, 32 to 150 A
 With 64 x 64 mm front plate (32 to 63 A ratings)
 and 88 x 88 mm front plate (115 and 150 A ratings)

Switches with 90° switching angle

Front mounting



K63C003HP



K150D004HP

Wiring diagram and switching programme	Marking and switch position	Number of poles	Thermal current (Ith)	Reference	Weight
			A		
		3	32	K30C003HP	0.224/0.494
			50	K50C003HP	0.275/0.606
			63	K63C003HP	0.345/0.761
			115	K115C003HP	0.680/1.499
			150	K150C003HP	0.790/1.742
		4	32	K30D004HP	0.250/0.551
			50	K50D004HP	0.305/0.672
			63	K63D004HP	0.390/0.860
			115	K115D004HP	0.745/1.642
			150	K150D004HP	0.880/1.940

Rear mounting

		3	32	K30C503HP	0.250/0.551
			50	K50C503HP	0.300/0.661
			63	K63C503HP	0.370/0.816
			115	K115C503HP	0.720/1.587
			150	K150C503HP	0.830/1.830
		4	32	K30D504HP	0.280/0.617
			50	K50D504HP	0.350/0.772
			63	K63D504HP	0.440/0.970
			115	K115D504HP	0.790/1.742
			150	K150D504HP	0.930/2.050

Cam switches

Complete switches, 32 to 150 A

With 64 x 64 mm front plate (32 to 63 A ratings)
and 88 x 88 mm front plate (115 and 150 A ratings)

103522



K50B001UP

Changeover switches with "0" position

Front mounting

Wiring diagram and switching programme	Marking and switch position	Number of poles	Thermal current (Ith)	Reference	Weight		
			A			kg/lb	
		1	32	K30B001UP	0.170/0.375		
			50	K50B001UP	0.215/0.474		
			150	K150B001UP	0.790/1.742		
		2		2	32	K30D002UP	0.250/0.551
					50	K50D002UP	0.305/0.672
					150	K150D002UP	0.790/1.742
		3		3	32	K30F003UP	0.425/0.937
					50	K50F003UP	0.530/1.168
					63	K63F003UP	0.590/1.301
					115	K115F003UP	0.645/1.422
					150	K150F003UP	0.760/1.675
					300	K300F003UP	1.940/4.290
		4		4	32	K30H004UP	0.485/1.069
					50	K50H004UP	0.610/1.345
					63	K63H004UP	0.680/1.499
115	K115H004UP				0.750/1.653		
150	K150H004UP				0.880/1.940		
300	K300H004UP				2.290/5.050		

501179

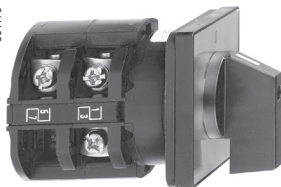

K63F013UP

Changeover switches without "0" position

Front mounting

		3	32	K30F013UP	0.425/0.937
			50	K50F013UP	0.530/1.168
			63	K63F013UP	0.590/1.301
			115	K115F013UP	0.645/1.422
			150	K150F013UP	0.760/1.675
			300	K300F013UP	1.940/4.290
		4	32	K30H014UP	0.485/1.069
			50	K50H014UP	0.610/1.345
			63	K63H014UP	0.680/1.499
			115	K115H014UP	0.750/1.653
			150	K150H014UP	0.880/1.940
			300	K300H014UP	2.290/5.050



Cam switches

Complete switches, 32 to 150 A

With 64 x 64 mm front plate (32 to 63 A ratings)

and 88 x 88 mm front plate (115 and 150 A ratings)

10352



K50H001YP

Star-delta switches

Front mounting

Wiring diagram and switching programme	Marking and switch position	Number of poles	Thermal current (Ith)	Reference	Weight
			A		
		3	32	K30H001YP	0.485/1.069
			50	K50H001YP	0.610/1.345
			63	K63H001YP	0.680/1.499
			115	K115H001YP	0.750/1.653
			150	K150H001YP	0.880/1.940

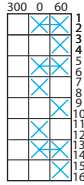

50117

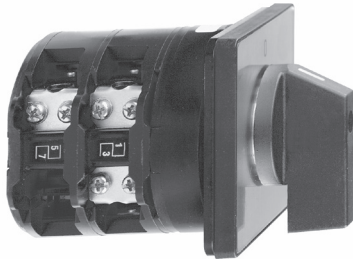

K115K006YP

Reversing star-delta switches

Front mounting

Wiring diagram and switching programme	Marking and switch position	Number of poles	Thermal current (Ith)	Reference	Weight
			A		
		3	32	K30K006YP	0.560/1.235
			50	K50K006YP	0.690/1.521
			63	K63K006YP	0.770/1.697
			115	K115K006YP	0.880/1.940
			150	K150K006YP	0.990/2.183

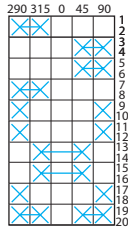

Cam switches

Complete switches, 32 to 150 A

With 64 x 64 mm front plate (32 to 63 A ratings)
and 88 x 88 mm front plate (115 and 150 A ratings)

Accessories

501179

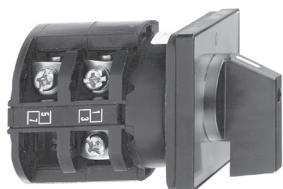

K63H004PP

Pole change switches for 2-speed motors (for motors with tapped "Dahlander" windings)

Front mounting

Wiring diagram and switching programme	Marking and switch position	Number of poles	Thermal current (Ith)	Reference	Weight
			A		
		3	32	K30H004PP	0.485/1.069
			50	K50H004PP	0.610/1.345
			63	K63H004PP	0.680/1.499

501178



K150D002WP

Reversing switches with "0" position

Front mounting

Wiring diagram and switching programme	Marking and switch position	Number of poles	Thermal current (Ith)	Reference	Weight
			A		
		2	32	K30D002WP	0.250/0.551
			50	K50D002WP	0.305/0.672
			63	K63D002WP	0.390/0.860
			115	K115D002WP	0.745/1.642
			150	K150D002WP	0.880/1.940
		3	32	K30E003WP	0.385/0.849
			50	K50E003WP	0.485/1.069
			63	K63E003WP	0.540/1.190
			115	K115E003WP	0.590/1.301
			150	K150E003WP	0.710/1.565

Accessories

Description	For use with	Sold in lots of	Unit reference	Weight kg/lb
Legend holders With blank legend	Square heads 64 x 64 mm/ 2.52 x 2.52 in.	5	KZN15	0.020/0.044
	Square heads 88 x 88 mm/ 3.46 x 3.46 in.	5	KZN103	0.040/0.088
Replacement blank legends for legend holder	KZN15	5	KZ77N	0.025/0.055
	KZN103	5	KZ100N	0.040/0.088
Blank legends for metallic finish front plate	64 x 64	5	KZN21	0.035/0.077
	88 x 88	5	KZN24	0.045/0.099



Index

■ **Product reference index**..... 8/2

K		K1C003NZ2		K1D009BX		K1D529B		K1F027M	
K1A001ACH	3/6	K1C003NZ4	5/2	K1D010B	4/10	K1D530B	4/11	K1F027MCH	4/26
K1A001ALH	3/6	K1C003QCH	3/9	K1D010BL	4/10	K1D531B	4/11	K1F027ML	3/19
K1A001B	4/9	K1C003QLH	3/9	K1D011B	4/10	K1D532B	4/11	K1F027MLH	4/26
K1A001BL	4/9	K1C004B	4/9	K1D011BL	4/10	K1D533M	4/25	K1F027MX	4/26
K1A001BX	4/9	K1C004BL	4/9	K1D012NCH	3/12	K1D534M	4/25	K1F037M	4/26
K1A001TCH	3/7	K1C004BX	4/9	K1D012NLH	3/12	K1E005ACH	3/6	K1F037MCH	3/19
K1A001TLH	3/7	K1C005B	4/9	K1D012QCH	3/11	K1E005ALH	3/6	K1F037ML	4/26
K1A002TCH	3/7	K1C005BL	4/9	K1D012QLH	3/11	K1E005NCH	3/10	K1F037MLH	3/19
K1A002TLH	3/7	K1C005BX	4/9	K1D012QZ2	5/4	K1E005NLH	3/10	K1F503M	4/24
K1A501B	4/9	K1C006B	4/9	K1D012QZ4	5/4	K1E005QCH	3/9	K1F513M	4/24
K1B001UCH	3/15	K1C006BL	4/9	K1D012UCH	3/15	K1E005QLH	3/9	K1F527M	4/26
K1B001ULH	3/15	K1C006BX	4/9	K1D012ULH	3/15	K1E025M	4/25	K1F537M	4/26
K1B001UZ2	5/7	K1C007B	4/9	K1D023M	4/25	K1E025MCH	3/19	K1G043RZ2	5/6
K1B001UZ4	5/7	K1C007BL	4/9	K1D023MCH	3/18	K1E025ML	4/25	K1G043RZ4	5/6
K1B002ACH	3/6	K1C007BX	4/9	K1D023ML	4/25	K1E025MLH	3/19	K1H004M	4/24
K1B002ALH	3/6	K1C024B	4/10	K1D023MLH	3/18	K1E025MX	4/25	K1H004MCH	3/17
K1B002B	4/9	K1C024BL	4/10	K1D023MX	4/25	K1E035M	4/25	K1H004ML	4/24
K1B002BL	4/9	K1C024BX	4/10	K1D024M	4/25	K1E035MCH	3/19	K1H004MLH	3/17
K1B002BX	4/9	K1C025B	4/10	K1D024MCH	3/19	K1E035ML	4/25	K1H004MX	4/24
K1B002NCH	3/10	K1C025BL	4/10	K1D024ML	4/25	K1E035MLH	3/19	K1H004UCH	3/15
K1B002NLH	3/10	K1C025BX	4/10	K1D024MLH	3/19	K1E525M	4/25	K1H004ULH	3/15
K1B002QCH	3/9	K1C026B	4/10	K1D024MX	4/25	K1E535M	4/25	K1H014M	4/24
K1B002QLH	3/9	K1C026BL	4/10	K1D028B	4/11	K1F003M	4/24	K1H014MCH	3/17
K1B003B	4/9	K1C026BX	4/10	K1D028BL	4/11	K1F003MCH	3/16	K1H014ML	4/24
K1B003BL	4/9	K1C027B	4/11	K1D028BX	4/11	K1F003ML	4/24	K1H014MLH	3/17
K1B003BX	4/9	K1C027BL	4/11	K1D029B	4/11	K1F003MLH	3/16	K1H014MX	4/24
K1B003TCH	3/8	K1C027BX	4/11	K1D029BL	4/11	K1F003MX	4/24	K1H014NCH	3/12
K1B003TLH	3/8	K1C504B	4/9	K1D029BX	4/11	K1F003UCH	3/15	K1H014NLH	3/12
K1B004TCH	3/8	K1C505B	4/9	K1D030B	4/11	K1F003ULH	3/15	K1H014QCH	3/11
K1B004TLH	3/8	K1C506B	4/9	K1D030BL	4/11	K1F003UZ2	5/7	K1H014QLH	3/11
K1B006TCH	3/15	K1C507B	4/9	K1D030BX	4/11	K1F003UZ4	5/7	K1H014UCH	3/15
K1B006TLH	3/15	K1C524B	4/10	K1D031B	4/11	K1F006ACH	3/6	K1H014ULH	3/15
K1B011UCH	3/15	K1C525B	4/10	K1D031BL	4/11	K1F006ALH	3/6	K1H026M	4/26
K1B011ULH	3/15	K1C526B	4/10	K1D032B	4/11	K1F013M	4/24	K1H026MCH	3/18
K1B022B	4/10	K1C527B	4/11	K1D032BL	4/11	K1F013MCH	3/16	K1H026ML	4/26
K1B022BL	4/10	K1D002UCH	3/15	K1D032RZ2	5/6	K1F013ML	4/24	K1H026MLH	3/18
K1B022BX	4/10	K1D002ULH	3/15	K1D032RZ4	5/6	K1F013MLH	3/16	K1H032QZ2	5/4
K1B023B	4/10	K1D002UZ2	5/7	K1D033M	4/25	K1F013MX	4/24	K1H032QZ4	5/4
K1B023BL	4/10	K1D002UZ4	5/7	K1D033MCH	3/18	K1F013NCH	3/12	K1H036M	4/26
K1B023BX	4/10	K1D004ACH	3/6	K1D033ML	4/25	K1F013NLH	3/12	K1H036MCH	3/18
K1B502B	4/9	K1D004ALH	3/6	K1D033MLH	3/18	K1F013N2	5/2	K1H036ML	4/26
K1B503B	4/9	K1D004HCH	3/6	K1D034M	4/25	K1F013N4	5/2	K1H036MLH	3/18
K1B522B	4/10	K1D004HLH	3/6	K1D034MCH	3/19	K1F013QCH	3/11	K1H504M	4/24
K1B523B	4/10	K1D004NCH	3/10	K1D034ML	4/25	K1F013QLH	3/11	K1H514M	4/24
K1B1002HCH	3/6	K1D004NLH	3/10	K1D034MLH	3/19	K1F013UCH	3/15	K1H526M	4/26
K1B1002HLH	3/6	K1D004QCH	3/9	K1D508B	4/9	K1F013ULH	3/15	K1H536M	4/26
K1C003ACH	3/6	K1D004QLH	3/9	K1D509B	4/10	K1F022NCH	3/14	K1I023NCH	3/14
K1C003ALH	3/6	K1D008B	4/9	K1D510B	4/10	K1F022NLH	3/14	K1I023NLH	3/14
K1C003HCH	3/6	K1D008BL	4/9	K1D511B	4/10	K1F022QCH	3/13	K1I023QCH	3/13
K1C003HLH	3/6	K1D008BX	4/9	K1D523M	4/25	K1F022QLH	3/13	K1I023QLH	3/13
K1C003NCH	3/10	K1D009B	4/10	K1D524M	4/25	K1F022QZ2	5/4	K1I9289Z1	5/6
K1C003NLH	3/10	K1D009BL	4/10	K1D528B	4/11	K1F022QZ4	5/4	K1K015NCH	3/12

K1K015NLH	3/12	K2D004QCH	3/9	K2K015NCH	3/12	K50A001AP	7/3	K150C503HP	7/4
K1K015NZ2	5/5	K2D004QLH	3/9	K2K015NLH	3/12	K50B001UP	7/5	K150D002WP	7/7
K1K015NZ4	5/5	K2D012NCH	3/12	K2K015QCH	3/11	K50B002AP	7/3	K150D004AP	7/3
K1K015QCH	3/11	K2D012NLH	3/12	K2K015QLH	3/11	K50C003AP	7/3	K150D004HP	7/4
K1K015QLH	3/11	K2D012QCH	3/11	K2K504Y	4/30	K50C003HP	7/4	K150D504HP	7/4
K1K1060Z1	5/5	K2D012QLH	3/11	K2K506Y	4/30	K50C503HP	7/4	K150E003WP	7/7
K1I023NZ2	5/2	K2D012UCH	3/15	K2M007Y	4/31	K50D002UP	7/5	K150F003UP	7/5
K1I023NZ4	5/2	K2D012ULH	3/15	K2M007YL	4/31	K50D002WP	7/7	K150F013UP	7/5
K1M10317Z1	5/5	K2E005ACH	3/6	K2M507Y	4/31	K50D004AP	7/3	K150H001YP	7/6
K1Q034NZ2	5/3	K2E005ALH	3/6	K10A001ACH	2/3	K50D004HP	7/4	K150H004UP	7/5
K1Q034NZ4	5/3	K2E005NCH	3/10	K10B001UCH	2/6	K50D504HP	7/4	K150H014UP	7/5
K1Q8621Z1	5/3	K2E005NLH	3/10	K10B002ACH	2/3	K50E003WP	7/7	K150K006YP	7/6
K1Q10805Z1	5/7	K2E005QCH	3/9	K10B002QCH	2/3	K50F003UP	7/5	KA1A050G	6/2
K2A001ACH	3/6	K2E005QLH	3/9	K10B006TCH	2/5	K50F006AP	7/3	KA1C051G	6/2
K2A001ALH	3/6	K2F003UCH	3/15	K10B011UCH	2/6	K50F013UP	7/5	KA1D052G	6/2
K2A001TCH	3/7	K2F003ULH	3/15	K10C003ACH	2/3	K50H001YP	7/6	KA1D053G	6/2
K2A001TLH	3/7	K2F006ACH	3/6	K10C003NCH	2/4	K50H004PP	7/7	KA1E054G	6/2
K2A002TCH	3/7	K2F006ALH	3/6	K10C003QCH	2/3	K50H004UP	7/5	KA1F056G	6/2
K2A002TLH	3/7	K2F013NCH	3/12	K10D002UCH	2/6	K50H014UP	7/5	KA1F057G	6/2
K2B001UCH	3/15	K2F013NLH	3/12	K10D004ACH	2/3	K50K006YP	7/6	KA1G055G	6/2
K2B001ULH	3/15	K2F013QCH	3/11	K10D004NCH	2/4	K63C003AP	7/3	KA1G058G	6/2
K2B002ACH	3/6	K2F013QLH	3/11	K10D004QCH	2/3	K63C003HP	7/4	KA1G059G	6/2
K2B002ALH	3/6	K2F013UCH	3/15	K10D012QCH	2/4	K63C503HP	7/4	KA1H060G	6/2
K2B002NCH	3/10	K2F013ULH	3/15	K10D012UCH	2/6	K63D002WP	7/7	KA1I061G	6/2
K2B002NLH	3/10	K2F022NCH	3/14	K10D024MCH	2/7	K63D004AP	7/3	KA1K062G	6/2
K2B002QCH	3/9	K2F022NLH	3/14	K10F003MCH	2/7	K63D004HP	7/4	KA1K063G	6/2
K2B002QLH	3/9	K2F022QCH	3/13	K10F003UCH	2/6	K63D504HP	7/4	KA2A050G	6/2
K2B003TCH	3/8	K2F022QLH	3/13	K10F013NCH	2/5	K63E003WP	7/7	KA2C051G	6/2
K2B003TLH	3/8	K2G003Y	4/30	K10F013QCH	2/4	K63F003UP	7/5	KA2D052G	6/2
K2B004TCH	3/8	K2G003YL	4/30	K10F013UCH	2/6	K63F006AP	7/3	KA2D053G	6/2
K2B004TLH	3/8	K2G003YX	4/30	K10F027MCH	2/7	K63F013UP	7/5	KA2E054G	6/2
K2B006TCH	3/15	K2G503Y	4/30	K10H004UCH	2/6	K63H001YP	7/6	KA2F056G	6/2
K2B006TLH	3/15	K2H001Y	4/30	K10H014UCH	2/6	K63H004PP	7/7	KA2F057G	6/2
K2B011UCH	3/15	K2H001YL	4/30	K30A001AP	7/3	K63H004UP	7/5	KA2G055G	6/2
K2B011ULH	3/15	K2H001YX	4/30	K30B001UP	7/5	K63H014UP	7/5	KA2G058G	6/2
K2B1002HCH	3/6	K2H004UCH	3/15	K30B002AP	7/3	K63K006YP	7/6	KA2G059G	6/2
K2B1002HLH	3/6	K2H004ULH	3/15	K30C003AP	7/3	K115C003AP	7/3	KA2H060G	6/2
K2C003ACH	3/6	K2H014NCH	3/12	K30C003HP	7/4	K115C003HP	7/4	KA2I061G	6/2
K2C003ALH	3/6	K2H014NLH	3/12	K30C503HP	7/4	K115C503HP	7/4	KA2K062G	6/2
K2C003HCH	3/6	K2H014QCH	3/11	K30D002UP	7/5	K115D002WP	7/7	KA2K063G	6/2
K2C003HLH	3/6	K2H014QLH	3/11	K30D002WP	7/7	K115D004AP	7/3	KAA1H	4/35
K2C003NCH	3/10	K2H014UCH	3/15	K30D004AP	7/3	K115D004HP	7/4	KAA1S	4/35
K2C003NLH	3/10	K2H014ULH	3/15	K30D004HP	7/4	K115D504HP	7/4	KAA1Z	4/35
K2C003QCH	3/9	K2H501Y	4/30	K30D504HP	7/4	K115E003WP	7/7	KAA2H	4/35
K2C003QLH	3/9	K2I023NCH	3/14	K30E003WP	7/7	K115F003UP	7/5	KAC1H	4/34
K2D002UCH	3/15	K2I023NLH	3/14	K30F003UP	7/5	K115F013UP	7/5	KAC1H41	4/34
K2D002ULH	3/15	K2I023QCH	3/13	K30F006AP	7/3	K115H001YP	7/6	KAC1H48	4/34
K2D004ACH	3/6	K2I023QLH	3/13	K30F013UP	7/5	K115H004UP	7/5	KAC1H61	4/34
K2D004ALH	3/6	K2K004Y	4/30	K30H001YP	7/6	K115H014UP	7/5	KAC1S	4/34
K2D004HCH	3/6	K2K004YL	4/30	K30H004PP	7/7	K115K006YP	7/6	KAC1Z	4/34
K2D004HLH	3/6	K2K004YX	4/30	K30H004UP	7/5	K150B001UP	7/5	KAD1H	4/34
K2D004NCH	3/10	K2K006Y	4/30	K30H014UP	7/5	K150C003AP	7/3	KAD1S	4/35
K2D004NLH	3/10	K2K006YL	4/30	K30K006YP	7/6	K150C003HP	7/4	KAD1Z	4/35

KAE1H	4/35	KD2F056G	6/3	K●B002GL	4/12	K●C003QX	4/14	K●D012U	4/7
KAF1H	4/35	KD2F057G	6/3	K●B002GX	4/12	K●C007T	4/8	K●D012UL	4/7
KAG3H	4/34	KD2G055G	6/3	K●B002N	4/16	K●C007TL	4/8	K●D012UX	4/7
KAXZ1C12	4/35	KD2G058G	6/3	K●B002NL	4/16	K●C023H	4/3	K●D022W	4/29
KAXZ1C14	4/35	KD2G059G	6/3	K●B002NX	4/16	K●C023HL	4/3	K●D022WL	4/29
KAXZ1M12	4/35	KD2H060G	6/3	K●B002Q	4/14	K●C023HX	4/3	K●D022WX	4/29
KAXZ1M14	4/35	KD2I061G	6/3	K●B002QL	4/14	K●C502D	4/8	K●D024H	4/3
KAXZ1S13●	4/35	KD2K062G	6/3	K●B002QX	4/14	K●C502L	4/27	K●D024HL	4/3
KAXZ1S14●	4/35	KD2K063G	6/3	K●B003T	4/4	K●C503A	4/2	K●D024HX	4/3
KAXZ1S16●	4/35	KDC1H	4/34	K●B003TL	4/4	K●C503G	4/12	K●D502S	4/28
KAXZ1S19●	4/35	KDC1LH	4/34	K●B004T	4/5	K●C503H	4/3	K●D502U	4/6
KBA1H	4/35	KDC1S	4/34	K●B004TL	4/5	K●C503N	4/16	K●D502W	4/29
KBA1S	4/35	KDC1Z	4/34	K●B006T	4/8	K●C503Q	4/14	K●D503L	4/27
KBA1Z	4/35	KDD1H	4/34	K●B006TL	4/8	K●C507T	4/8	K●D504A	4/2
KBC1H	4/34	KDD1S	4/35	K●B006TX	4/8	K●C523H	4/3	K●D504G	4/12
KBC1H41	4/34	KDD1Z	4/35	K●B011U	4/7	K●D002S	4/28	K●D504H	4/3
KBC1H48	4/34	KDE1H	4/35	K●B011UL	4/7	K●D002SL	4/28	K●D504N	4/16
KBC1H61	4/34	KDE1LH	4/35	K●B011UX	4/7	K●D002SX	4/28	K●D504Q	4/14
KBC1S	4/34	KDF1H	4/35	K●B501D	4/5	K●D002U	4/6	K●D505T	4/5
KBC1Z	4/34	KDG3H	4/34	K●B501S	4/28	K●D002UL	4/6	K●D512G	4/12
KBD1H	4/34	KDG3Y	4/34	K●B501U	4/6	K●D002UX	4/6	K●D512N	4/19
KBD1S	4/35	K●A001A	4/2	K●B501U	4/8	K●D002W	4/29	K●D512Q	4/18
KBD1Z	4/35	K●A001A	4/4	K●B502A	4/2	K●D002WL	4/29	K●D512U	4/7
KBE1H	4/35	K●A001AL	4/2	K●B502G	4/12	K●D002WX	4/29	K●D522W	4/29
KBF1H	4/35	K●A001AL	4/4	K●B502N	4/16	K●D003L	4/27	K●D524H	4/3
KBG3H	4/34	K●A001AX	4/2	K●B502Q	4/14	K●D003LL	4/27	K●E003W	4/29
KCC1LH	4/34	K●A001AX	4/4	K●B503T	4/4	K●D003LX	4/27	K●E003WL	4/29
KCC1Y	4/34	K●A001T	4/4	K●B504T	4/5	K●D004A	4/2	K●E003WX	4/29
KCD1MH	4/34	K●A001TL	4/4	K●B506T	4/8	K●D004AL	4/2	K●E005A	4/2
KCE1LH	4/35	K●A001TX	4/4	K●B511U	4/7	K●D004AX	4/2	K●E005AL	4/2
KCE1Y	4/35	K●A002T	4/4	K●B1002H	4/3	K●D004G	4/12	K●E005AX	4/2
KCF1MH	4/35	K●A002TL	4/4	K●B1002HL	4/3	K●D004GL	4/12	K●E005H	4/3
KCG3H	4/34	K●A002TX	4/4	K●B1002HX	4/3	K●D004GX	4/12	K●E005HL	4/3
KCG3Y	4/34	K●A501A	4/2	K●C002D	4/8	K●D004H	4/3	K●E005HX	4/3
KD1A050G	6/3	K●A501A	4/4	K●C002DL	4/8	K●D004HL	4/3	K●E005N	4/16
KD1C051G	6/3	K●A501T	4/4	K●C002DX	4/8	K●D004HX	4/3	K●E005NL	4/16
KD1D052G	6/3	K●A502T	4/4	K●C002L	4/27	K●D004N	4/16	K●E005NX	4/16
KD1D053G	6/3	K●B001D	4/5	K●C002LL	4/27	K●D004NL	4/16	K●E005Q	4/14
KD1E054G	6/3	K●B001DL	4/5	K●C002LX	4/27	K●D004NX(2)	4/16	K●E005QL	4/14
KD1F056G	6/3	K●B001DX	4/5	K●C003A	4/2	K●D004Q	4/14	K●E005QX	4/14
KD1F057G	6/3	K●B001S	4/28	K●C003AL	4/2	K●D004QL	4/14	K●E023W	4/29
KD1G055G	6/3	K●B001SL	4/28	K●C003AX	4/2	K●D004QX	4/14	K●E023WL	4/29
KD1G058G	6/3	K●B001SX	4/28	K●C003G	4/12	K●D005T	4/5	K●E023WX	4/29
KD1G059G	6/3	K●B001U	4/6	K●C003GL	4/12	K●D005TL	4/5	K●E025H	4/3
KD1H060G	6/3	K●B001U	4/8	K●C003GX	4/12	K●D012G	4/12	K●E025HL	4/3
KD1I061G	6/3	K●B001UL	4/6	K●C003H	4/3	K●D012GL	4/12	K●E503W	4/29
KD1K062G	6/3	K●B001UL	4/8	K●C003HL	4/3	K●D012GX	4/12	K●E505A	4/2
KD1K063G	6/3	K●B001UX	4/6	K●C003HX	4/3	K●D012N	4/19	K●E505H	4/3
KD2A050G	6/3	K●B001UX	4/8	K●C003N	4/16	K●D012NL	4/19	K●E505N	4/16
KD2C051G	6/3	K●B002A	4/2	K●C003NL	4/16	K●D012NX	4/19	K●E505Q	4/14
KD2D052G	6/3	K●B002AL	4/2	K●C003NX	4/16	K●D012Q	4/18	K●E523W	4/29
KD2D053G	6/3	K●B002AX	4/2	K●C003Q	4/14	K●D012QL	4/18	K●E525H	4/3
KD2E054G	6/3	K●B002G	4/12	K●C003QL	4/14	K●D012QX	4/18	K●F001P	4/31

KoF001PL	4/31	KoF506A	4/2	KoH014QL	4/18	KoK008P	4/32	KoM023L	4/27
KoF001PX	4/31	KoF506H	4/3	KoH014QX	4/18	KoK008PL	4/32	KoM023LL	4/27
KoF002P	4/31	KoF506N	4/16	KoH014U	4/7	KoK010N	4/17	KoM024G	4/13
KoF002PL	4/31	KoF506Q	4/14	KoH014UL	4/7	KoK010NL	4/17	KoM024GL	4/13
KoF002PX	4/31	KoF512L	4/27	KoH014UX	4/7	KoK010NX	4/17	KoM024GX	4/13
KoF003S	4/28	KoF513G	4/12	KoH032N	4/23	KoK010Q	4/15	KoM024N	4/21
KoF003SL	4/28	KoF513N	4/19	KoH032NL	4/23	KoK010QL	4/15	KoM024NL	4/21
KoF003SX	4/28	KoF513Q	4/18	KoH032NX	4/23	KoK010QX	4/15	KoM024NX	4/21
KoF003U	4/6	KoF513U	4/7	KoH032Q	4/22	KoK015N	4/19	KoM024Q	4/20
KoF003UL	4/6	KoF522G	4/13	KoH032QL	4/22	KoK015NL	4/19	KoM024QL	4/20
KoF003UX	4/6	KoF522N	4/21	KoH032QX	4/22	KoK015NX	4/19	KoM024QX	4/20
KoF006A	4/2	KoF522Q	4/20	KoH504P	4/31	KoK015Q	4/18	KoM033N	4/23
KoF006AL	4/2	KoF526H	4/3	KoH504S	4/28	KoK015QL	4/18	KoM033NL	4/23
KoF006AX	4/2	KoG007A	4/2	KoH504U	4/6	KoK015QX	4/18	KoM033Q	4/22
KoF006H	4/3	KoG007AL	4/2	KoH505P	4/32	KoK015U	4/7	KoM033QL	4/22
KoF006HL	4/3	KoG007N	4/16	KoH508A	4/2	KoK015UL	4/7	KoM509P	4/32
KoF006HX	4/3	KoG007NL	4/16	KoH508N	4/16	KoK015UX	4/7	KoM516N	4/19
KoF006N	4/16	KoG007NX	4/16	KoH508Q	4/15	KoK505S	4/28	KoM516Q	4/18
KoF006NL	4/16	KoG007Q	4/14	KoH513L	4/27	KoK505U	4/6	KoM521N	4/17
KoF006NX	4/16	KoG007QL	4/14	KoH514G	4/13	KoK508P	4/32	KoM523L	4/27
KoF006Q	4/14	KoG007QX	4/14	KoH514N	4/19	KoK510N	4/17	KoM524G	4/13
KoF006QL	4/14	KoG507A	4/2	KoH514Q	4/18	KoK510Q	4/15	KoM524N	4/21
KoF006QX	4/14	KoG507N	4/16	KoH514U	4/7	KoK515N	4/19	KoM524Q	4/20
KoF012L	4/27	KoG507Q	4/14	KoH532N	4/23	KoK515Q	4/18	KoM533N	4/23
KoF012LL	4/27	KoH004P	4/31	KoH532Q	4/22	KoK515U	4/7	KoM533Q	4/22
KoF012LX	4/27	KoH004PL	4/31	KoI009N	4/17	KoL010P	4/33	KoP025N	4/21
KoF013G	4/12	KoH004PX	4/31	KoI009NL	4/17	KoL010PL	4/33	KoP025NL	4/21
KoF013GL	4/12	KoH004S	4/28	KoI009NX	4/17	KoL011N	4/17	KoP025NX	4/21
KoF013GX	4/12	KoH004SL	4/28	KoI009Q	4/15	KoL011NL	4/17	KoP025Q	4/20
KoF013N	4/19	KoH004U	4/6	KoI009QL	4/15	KoL011NX	4/17	KoP025QL	4/20
KoF013NL	4/19	KoH004UL	4/6	KoI009QX	4/15	KoL011P	4/33	KoP025QX	4/20
KoF013NX	4/19	KoH004UX	4/6	KoI022L	4/27	KoL011PL	4/33	KoP525N	4/21
KoF013Q	4/18	KoH005P	4/32	KoI022LL	4/27	KoL011Q	4/15	KoP525Q	4/20
KoF013QL	4/18	KoH005PL	4/32	KoI023G	4/13	KoL011QL	4/15	KoQ034N	4/23
KoF013QX	4/18	KoH005PX	4/32	KoI023GL	4/13	KoL011QX	4/15	KoQ034NL	4/23
KoF013U	4/7	KoH008A	4/2	KoI023GX	4/13	KoL012P	4/33	KoQ034Q	4/22
KoF013UL	4/7	KoH008AL	4/2	KoI023N	4/21	KoL012PL	4/33	KoQ034QL	4/22
KoF013UX	4/7	KoH008N	4/16	KoI023NL	4/21	KoL510P	4/33	KoQ534N	4/23
KoF022G	4/13	KoH008NL	4/16	KoI023NX	4/21	KoL511N	4/17	KoQ534Q	4/22
KoF022GL	4/13	KoH008NX	4/16	KoI023Q	4/20	KoL511P	4/33	KoS026N	4/21
KoF022GX	4/13	KoH008Q	4/15	KoI023QL	4/20	KoL511Q	4/15	KoS026NL	4/21
KoF022N	4/21	KoH008QL	4/15	KoI023QX	4/20	KoL512P	4/33	KoS026NX	4/21
KoF022NL	4/21	KoH008QX	4/15	KoI509N	4/17	KoM009P	4/32	KoS026Q	4/20
KoF022NX	4/21	KoH013L	4/27	KoI509Q	4/15	KoM009PL	4/32	KoS026QL	4/20
KoF022Q	4/20	KoH013LL	4/27	KoI522L	4/27	KoM016N	4/19	KoS026QX	4/20
KoF022QL	4/20	KoH013LX	4/27	KoI523G	4/13	KoM016NL	4/19	KoS526N	4/21
KoF022QX	4/20	KoH014G	4/13	KoI523N	4/21	KoM016NX	4/19	KoS526Q	4/20
KoF026H	4/3	KoH014GL	4/13	KoI523Q	4/20	KoM016Q	4/18	KoU035N	4/23
KoF026HL	4/3	KoH014GX	4/13	KoK005S	4/28	KoM016QL	4/18	KoU035NL	4/23
KoF501P	4/31	KoH014N	4/19	KoK005SL	4/28	KoM016QX	4/18	KoU035Q	4/22
KoF502P	4/31	KoH014NL	4/19	KoK005U	4/6	KoM021N	4/17	KoU035QL	4/22
KoF503S	4/28	KoH014NX	4/19	KoK005UL	4/6	KoM021NL	4/17	KoU535N	4/23
KoF503U	4/6	KoH014Q	4/18	KoK005UX	4/6	KoM021NX	4/17	KoU535Q	4/22

KZ1	4/39	KZ18042	4/37	KZ18630L	4/36	XBCY7224	4/38
KZ01R	4/39	KZ18042L	4/36	KZ18631	4/37	XBCY7225	4/38
KZ2	4/39	KZ18043	4/37	KZ18631L	4/36	XBCY7226	4/38
KZ13	4/39	KZ18043L	4/36	KZ18632	4/37	XBCY7227	4/38
KZ14	4/39	KZ18044	4/37	KZ18632L	4/36	XBCY7228	4/38
KZ15	4/39	KZ18044L	4/36	KZ18634	4/37	XBCY7229	4/38
KZ16	4/39	KZ18045	4/37	KZ18634L	4/36	XBCY7230	4/38
KZ17	4/37	KZ18045L	4/36	KZ18635	4/37	XBCY7231	4/38
KZ17L	4/36	KZ18046	4/37	KZ18635L	4/36	XBCY7232	4/38
KZ17X	4/38	KZ18046L	4/36	KZ18637	4/37	XBCY7233	4/38
KZ18	4/37	KZ18047	4/37	KZ18637L	4/36	XBCY7234	4/38
KZ18L	4/36	KZ18047L	4/36	KZ18913	4/37	XBCY7235	4/38
KZ19	4/37	KZ18048	4/37	KZ18913L	4/36	XBCY7236	4/38
KZ19L	4/36	KZ18048L	4/36	KZ18931F	4/37	XBCY7238	4/38
KZ19X	4/38	KZ18061	4/37	KZ18931FL	4/36	XBCY7239	4/38
KZ20	4/37	KZ18061L	4/36	KZ19041	4/37	XBCY7240	4/38
KZ21	4/37	KZ18068	4/37	KZ19041L	4/36	XBCY7241	4/38
KZ22	4/37	KZ18068L	4/36	KZ19093	4/37	XBCY7242	4/38
KZ27	4/40	KZ18091	4/37	KZ19093L	4/36	XBCY7243	4/38
KZ27H	4/40	KZ18091L	4/36	KZ19098F	4/37	XBCY7251	4/38
KZ28	4/40	KZ18093	4/37	KZ19098FL	4/36	XBCY7268	4/38
KZ28H	4/40	KZ18093L	4/36	KZ19910	4/37		
KZ30	4/41	KZ18312	4/37	KZ19910L	4/36	Z	
KZ31	4/41	KZ18312L	4/36	KZ21041	4/37	Z01	4/41
KZ32	4/40	KZ18412	4/37	KZ21048	4/37	Z18	4/41
KZ35	4/41	KZ18412L	4/36	KZ21093	4/37	Z18R	4/41
KZ36	4/41	KZ18413	4/37	KZ21412	4/37	Z18R1	4/41
KZ37	4/41	KZ18413L	4/36	KZ21451	4/37	Z18R15	4/41
KZ38	4/41	KZ18415	4/37	KZ21635	4/37		
KZ39	4/41	KZ18415L	4/36	KZ21637	4/37		
KZ41H	4/40	KZ18416	4/37	KZ21910	4/37		
KZ42H	4/40	KZ18416L	4/36	KZN15	7/7		
KZ50	4/41	KZ18417	4/37	KZN21	7/7		
KZ52	4/41	KZ18417L	4/36	KZN24	7/7		
KZ65	4/41	KZ18418	4/37	KZN103	7/7		
KZ66	4/41	KZ18418L	4/36				
KZ73	4/41	KZ18419	4/37	X			
KZ76	4/39	KZ18419L	4/36	XBCY2211	4/38		
KZ77	4/39	KZ18420	4/37	XBCY2213	4/38		
KZ77N	7/7	KZ18420L	4/36	XBCY2214	4/38		
KZ83	4/40	KZ18421	4/37	XBCY2215	4/38		
KZ91H	4/41	KZ18421L	4/36	XBCY2216	4/38		
KZ93	4/41	KZ18422F	4/37	XBCY2218	4/38		
KZ95	4/41	KZ18422FL	4/36	XBCY2219	4/38		
KZ100N	7/7	KZ18423F	4/37	XBCY2250	4/38		
KZ127	4/40	KZ18423FL	4/36	XBCY7064	4/38		
KZ140	4/40	KZ18434	4/37	XBCY7168	4/38		
KZ141	4/40	KZ18434L	4/36	XBCY7212	4/38		
KZ18032	4/37	KZ18436F	4/37	XBCY7217	4/38		
KZ18032L	4/36	KZ18436FL	4/36	XBCY7220	4/38		
KZ18033L	4/36	KZ18451	4/37	XBCY7221	4/38		
KZ18041	4/37	KZ18451L	4/36	XBCY7222	4/38		
KZ18041L	4/36	KZ18630	4/37	XBCY7223	4/38		

Harmony Innovation



Schneider Electric Industries SAS

Head Office
35, rue Joseph Monier
F-92500 Rueil-Malmaison
France

www.schneider-electric.com/control

The information provided in this documentation contains general descriptions and/or technical characteristics of the performance of the products contained herein. This documentation is not intended as a substitute for and is not to be used for determining suitability or reliability of these products for specific user applications. It is the duty of any such user or integrator to perform the appropriate and complete risk analysis, evaluation and testing of the products with respect to the relevant specific application or use thereof. Neither Schneider Electric nor any of its affiliates or subsidiaries shall be responsible or liable for misuse of the information contained herein.

Design: Schneider Electric
Photos: Schneider Electric

DIA5ED2130604EN

X-ON Electronics

Largest Supplier of Electrical and Electronic Components

Click to view similar products for [schneider](#) manufacturer:

Other Similar products are found below :

[LU9M1](#) [7D](#) [7S](#) [7XA1](#) [FNQR2](#) [8501RS44V24](#) [8501RSD14P14V51](#) [8501XO20V03Y414](#) [9001KXRK](#) [9001SKR9P35RH25](#) [9001SKT35L31](#)
[9003K2C003GA](#) [9007AA1](#) [9007BA1](#) [9007C54D](#) [9007C62A2](#) [9007CA11](#) [9007FA3](#) [9007HA4](#) [9007HA6](#) [9007KA1](#) [9007KB11](#)
[9007MS01S0206](#) [9007MS02S0300](#) [9012GAR4](#) [9012GAW2](#) [9012GBW1](#) [9012GDW5E3](#) [9012GFW1](#) [9012GNG1](#) [9012GNG3](#) [9012GNG6](#)
[9013FHG39J69](#) [9013GHG2J30](#) [9050JCK2F30V14](#) [GV2ME32](#) [GVAN20](#) [GZ1E02](#) [A9F04102](#) [A9F04106](#) [A9F05110](#) [A9F07102](#)
[ABL8RPS24030](#) [DL1BLB](#) [ATS01N206QN](#) [RSL1PRJU](#) [9001KA35](#) [9001KA3G](#) [9001KA4](#) [9001KR1GH5](#)