

Low voltage
Extract from **TeSys** Catalogue | 2022

TeSys Control

Giga High power contactors



Life Is On

Schneider
Electric

Introduction

B9/4

TeSys Giga High power contactors

Type of product	Range		Pages
TeSys Giga High power contactors Advanced version - 3 and 4-poles	3-pole from 115 to 800 A – AC-3 3-pole and 4-pole from 250 to 1050 A – AC-1		B9/10
TeSys Giga High power contactors Standard version - 3 and 4-poles	3-pole from 115 to 800 A – AC-3 3-pole and 4-pole from 250 to 1050 A – AC-1		B9/12
Auxiliary modules, Accessories, Retrofit kits for TeSys Giga High power contactors			B9/14
Spare parts for TeSys Giga High power contactors			B9/20

Technical Data for Designers

B9/23

On-line tools to configure your motor starters

EcoStruxure™ Motor Control Configurator



Scan or click
on the QR code

Build your starter configuration

- Build your motor starter configuration with different solutions
- Complete offer base suited for different countries.

Enhanced customer's journey

- Easy selection, replacing complex paper catalogs
- Covert into Bill of Materials (BoM) by adding the products to the cart.

Answers to customer needs

- Option to save and re-work your configurations
- Direct access to products documentation in one place
- Possibility with unique configurations ID and share.

Product Selector for TeSys Giga



Scan or click
on the QR code

Offer selection

- Easy selection of **TeSys** Giga Contactor or Overload Relays
- Intuitive tool to configure the devices to suit your needs
- Helps to select the right devices for your application.

Configure your motor starter components

- Options to select auxiliaries and accessories
- Configure reversers and changeover contactors with ease
- Get the extensive bill of material, export it in standard format (PDF, XLS), or drop it into the product cart
- Access to technical information and documentations for every item.

EcoStruxure Motor Management Design



Scan or click
on the QR code

Electrical design calculations for high-power motors

Easily perform basic calculations related to transformer size, short-circuit current and voltage drop, comparing direct-on-line, star-delta, soft-starter, and variable speed drive. Verify starting feasibility from mechanical standpoint and ensure power quality objectives are met, for power factor or harmonic levels. Check energy saving potential of using a variable speed drive for centrifugal pumps and fans.

Offer selection and report

Select among latest compatible offers to build a complete motor management solution: circuit breakers, contactors, MCC panels, drives, protection relays, power factor capacitors, active filters, power quality monitoring and services.

Get a summary report with calculations and recommended offers.

Product references – coding principle

> TeSys Giga High power contactors

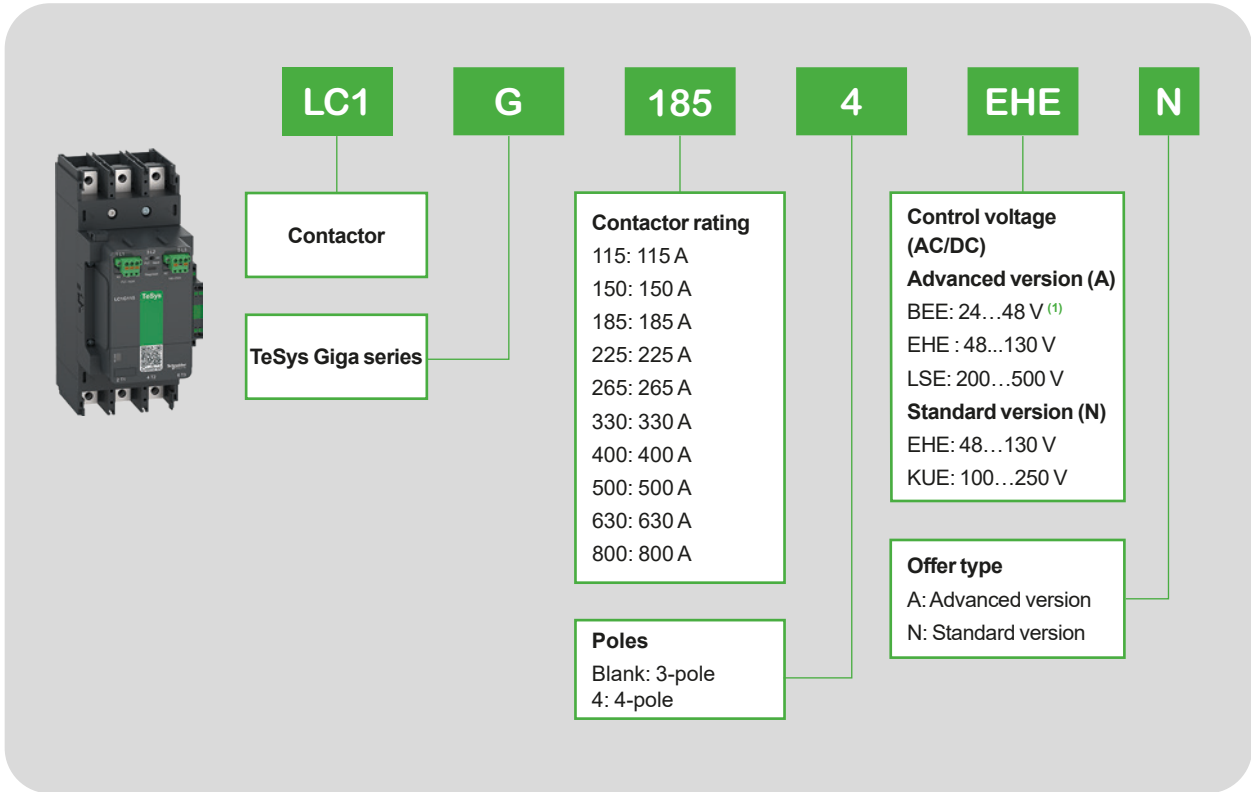

Example:

LC1G400LSEA TeSys Giga Contactor Advanced version 400 A, 3-pole, 200...500 V AC/DC coil, with PLC control.

LC1G1854EHEN TeSys Giga Contactor Standard version 185 A, 4-pole, 48...130 V AC/DC coil, without PLC control.

⁽¹⁾ 24...48 V AC/DC control voltage option is available for LC1G115...LC1G500 ratings.

> Quality and Performance as high priority

TeSys Giga A new Generation series with digital innovation

Over more than 4 decades, the TeSys F range of contactors has built a high reputation for performance, reliability, and quality. The TeSys F range set the industrial standard for high power contactors with an installed base of millions of products. TeSys F contactors were the first choice of many OEMs, control panel builders and industrial users.

But industry requirements have evolved to demand process performance monitoring through data networks and online expert services.

TeSys Giga is Schneider Electric's new range of contactors that answer these evolving needs. TeSys Giga High power contactors support the evolution of processes and offer new services to reduce non-production time to a minimum. Replacing TeSys F Contactors, TeSys Giga High power contactors address a wide range of demanding applications with built-in advanced features and functionalities.



Futuristic ready...

TeSys Giga High power contactors are designed to work with components and accessories with advanced performance. The characteristics of robustness and longevity are maintained, both in the connectors and in the switching.

Continuous local and remote monitoring of contact wear optimizes predictive maintenance by allowing you to replace contacts only when necessary, facilitated by diagnostic visual indicator.

Every customer will benefit from the innovative design and feature, including the compact size, wideband electronic coils, embedded auxiliary contact blocks, ergonomic design, or flexibility in connections.

> Applications



AC-3/AC-3e utilization category



AC-1 utilization category

- TeSys Giga High power contactors provide robust control solutions for AC-3/AC-3e applications up to 800 A and AC-1 applications up to 1050 A.
- TeSys Giga High power contactors can be part of a direct-on-line motor starter, reversing motor starter or a star-delta motor starter and power switching application.
- TeSys Giga High power contactors provide contact wear diagnostic and wideband AC/DC control.
- Suitable for type 2 coordination as per IEC60947-4-1.

> Right choice for a wide range of demanding applications



High power
contactors

TeSys Giga High power contactors' unique design meets the common requirements of demanding high power applications:

- Conform to multi standards to suit global needs
- Long life expectancy in harsh environments
- Suitable for high efficiency motors
- Very good resistance to vibrations
- High uptime thanks to predictive maintenance
- Optimized installation and maintainability.

> Intelligent design for greater advantages



- Interlock location, with knock-out cover
- On/Off switch for PLC input
- Push-in type control terminals enabling quick wiring and assembly
- Diagnosis LED for contact wear & voltage abnormality
- Built-in 1 NO + 1 NC auxiliary contact block
- Unique QR code providing quick access to complete product data
- Mechanical indicator for contactor open and closed status



Higher flexibility

TeSys Giga High power contactors can be mounted in different orientation without derating, providing high flexibility of your panel design. Control wiring, auxiliary contacts and control module are accessible from the front.

High power contactors



Contact wear diagnostic and predictive maintenance

Contact wear is monitored by a dedicated module and shown in the front panel through LED, therefore the, predictive maintenance can be planned for replacing the complete set of switching modules, thus avoiding break-down maintenance. Switching modules ⁽¹⁾ can be replaced quickly and easily thanks to their Plug and Play design.

⁽¹⁾ Refer to page B9/21 for details on switching modules.

> Key features

Advanced contactor control

- The electronic control module provides wideband AC/DC coil control voltage, from 24 V to 500 V, allowing quick adaptation of existing industrial processes as well as new projects.
- The low power consumption of the coils could lead to significant savings on automation equipment. It's now possible to use interface relays with a lower rating, resulting in lower heat emission in the panel.
- The low power consumption of the coils also takes up less space in the panel and simplifies the diagrams by connecting these coils directly to the output cards of the PLCs.

Simplified wiring

- The pole pitch of the power terminals allows direct mounting and connection to TeSys Giga Electronic Overload Relays. Standardization of panel mounting and assembly reduces costs and assembly time.
- Push-in connection for control terminals provides flexibility, ease of connections, and reduced assembly and installation time.

Enhanced durability

- Durability is a top priority. TeSys Giga High power contactors are designed to offer uncompromising robustness and maintenance accessibility to site technicians. The duration of production down-time is reduced, resulting in improved profitability on your investment.

Advanced diagnostic features

- On-board diagnostics is a new feature in our latest generation of high power contactors. Counting the number of operations as well as monitoring duration of use and pole condition provides numerous benefits for the customer and improves reliability and maintenance planning.

Compact size

- Compact size provides easy access to power connections for connecting cables and busbars.

Easy maintenance

- The poles are designed as replaceable switching modules, so the performance of a used contactor can be fully restored. The modular design allows a quick and long-lasting replacement.
- Coils are accessible from the front and maintained with very low down times.

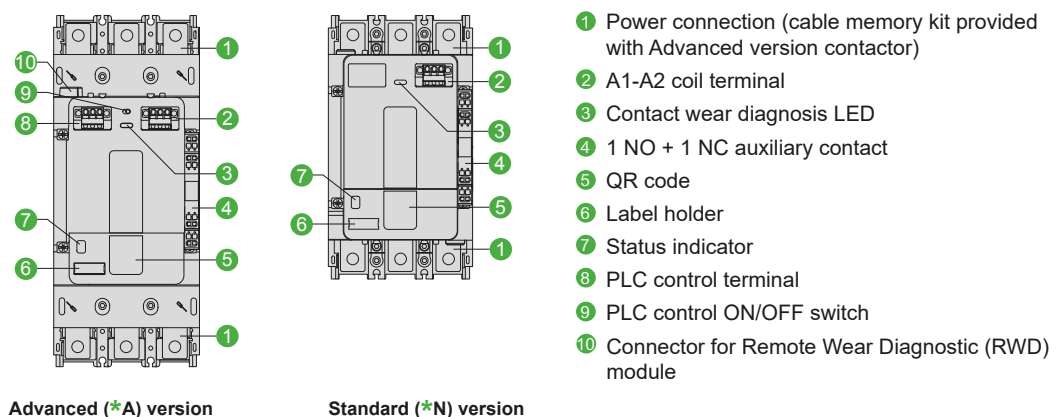

*: contactor references finishing by A or by N.

High power contactors

TeSys Control

Giga High power contactors

Introduction

A comprehensive range of TeSys Giga High power contactors that are available in 'Advanced' and 'Standard' versions, in 3 sizes, covering several ratings.
A common range of auxiliary contacts and accessories, enabling high flexibility and simplicity.

> TeSys Giga High power contactors – Advanced version



115...225 A



265...500 A



630...800 A

Power & control

- 3 or 4 power poles
- 115 to 800 A (AC-3)
- 250 to 1050 A (AC-1)
- Embedded 1 NO + 1 NC auxiliary contacts
- Push-in type terminals for coils & control

Remote control

- 24-48 V, 48-130 V, 200-500 V AC/DC coils
- Low consumption coils
- Wide voltage range coils (direct coil control)
- Digital control input (PLC output digital coil control)
- Embedded surge suppressor

Diagnostic

- Embedded wear diagnostic
- Embedded control voltages diagnostic
- Self diagnosis function
- Local alarm signaling (LED)
- Remote wear diagnostic signaling kit (accessory)

Mounting

- 'Cable memory' adapter enables maintenance without removing power cables and busbar connections.

Standards and Certifications

- Multiple standards
- International certifications

> TeSys Giga High power contactors – Standard version



115...225 A



265...500 A



630...800 A

Power & control

- 3 or 4 power poles
- 115 to 800 A (AC-3)
- 250 to 1050 A (AC-1)
- Embedded 1 NO + 1 NC auxiliary contacts
- Push-in type terminals for coils & control

Remote control

- 48-130 V, 100-250 V AC/DC coils
- Wide voltage range coils (direct coil control)
- Embedded surge-suppressor

Diagnostic

- Embedded wear diagnostic
- Embedded control voltages diagnostic
- Self diagnosis function
- Local alarm signaling (LED)

Certifications

- Multiple standards
- International certifications

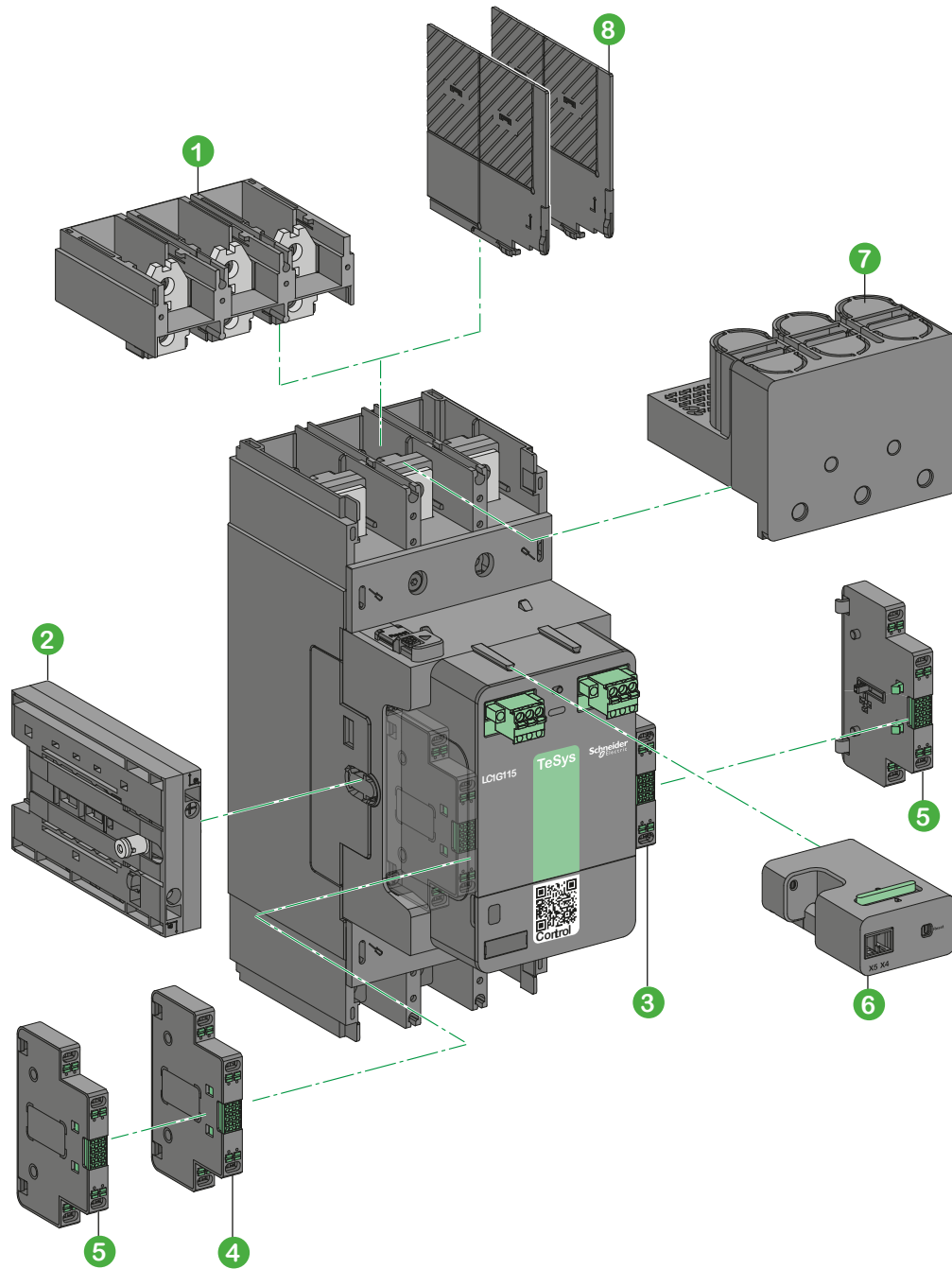

- ① Cable memory kit **LA9G3102**, is always supplied along with Advanced version, and it's an optional accessory for Standard version.
- ② Mechanical interlock **LA9G970**, can be installed on either side of the contactor.
- ③ Auxiliary contact module **LAG8N113P** (1 NO + 1 NC) supplied with LC1G contactor.
- ④ Auxiliary contact modules **LAG8N113P / LAG8N203P**, can be installed on the contactor lateral faces ⁽¹⁾
- ⑤ Auxiliary contact modules **LAG8N113 / LAG8N203**, can be installed on either side as 2nd set of contacts.
- ⑥ Remote Wear Diagnostic (RWD) Module **LA9GRD01 / LA9GRD10**, can be installed and used only in Advanced version.
- ⑦ IP 20 terminal shroud **LA9G3701**.
- ⑧ Phase separators **LA9G3801**, please refer to pages B9/14 to B9/18 for complete details of available accessories.

Note: a maximum of 2 auxiliary contact modules can be mounted on each side of the contactor.
 (1) Does not increase the contactor dimensions when fitted on both sides.

TeSys Control

Giga High power contactors – Advanced – 3-pole and 4-pole

Product references

TeSys Giga 3-pole Advanced contactors – For motor control (115 to 800 A)



Motor ratings (kW) $\theta \leq 60^\circ\text{C}$

AC-3							AC-3e ⁽¹⁾							AC-4						
230 V	400 V	415 V	440 V	500 V	690 V	1000 V	230 V	400 V	415 V	440 V	500 V	690 V	1000 V	230 V	400 V	415 V	440 V	500 V	690 V	1000 V
kW	kW	kW	kW	kW	kW	kW	kW	kW	kW	kW	kW	kW	kW	kW	kW	kW	kW	kW	kW	kW
30	55	55	75	75	75	-	30	55	55	75	75	75	-	30	55	55	65	65	75	-
37	75	75	90	90	90	75	37	75	75	90	90	90	75	37	75	75	80	90	90	75
55	90	90	110	110	110	75	55	90	90	110	110	110	75	55	90	90	100	110	110	75
55	110	110	132	132	160	132	55	110	110	132	132	160	132	55	110	110	129	132	132	110
75	132	132	160	160	200	160	75	132	132	160	160	200	160	75	132	132	150	160	160	160
90	160	160	200	200	220	185	90	160	160	185	200	220	185	90	160	160	185	200	220	185
110	200	200	250	250	315	220	110	200	200	250	250	315	220	110	200	200	220	250	315	220
160	250	250	315	355	355	335	147	250	250	280	315	355	335	150	250	250	295	295	355	280
200	335	375	400	400	500	450	180	315	335	355	375	500	450	180	315	335	355	375	450	355
250	450	450	450	500	560	450	200	335	355	375	425	560	450	200	375	355	375	400	475	400



TeSys Giga 3-pole and 4-pole Advanced contactors for load control only (non motor) – (250 to 1050 A)

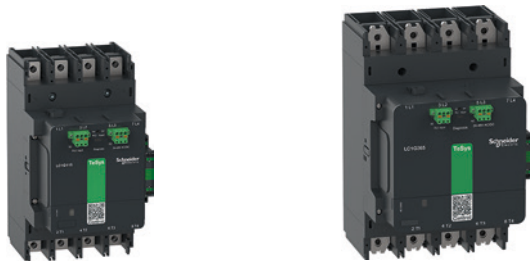

High power contactors

IEC	UL	Reference					
		Advanced version contactors					
		AC/DC coil voltage					
		3-pole			4-pole		
		24...48 V	48...130 V	200...500 V	24...48 V	48...130 V	200...500 V
AC-1							
250	210	LC1G115BEEA	LC1G115EHEA	LC1G115LSEA	LC1G1154BEEA	LC1G1154EHEA	LC1G1154LSEA
275	230	LC1G150BEEA	LC1G150EHEA	LC1G150LSEA	LC1G1504BEEA	LC1G1504EHEA	LC1G1504LSEA
305	250	LC1G185BEEA	LC1G185EHEA	LC1G185LSEA	LC1G1854BEEA	LC1G1854EHEA	LC1G1854LSEA
330	290	LC1G225BEEA	LC1G225EHEA	LC1G225LSEA	LC1G2254BEEA	LC1G2254EHEA	LC1G2254LSEA
385	340	LC1G265BEEA	LC1G265EHEA	LC1G265LSEA	LC1G2654BEEA	LC1G2654EHEA	LC1G2654LSEA
440	390	LC1G330BEEA	LC1G330EHEA	LC1G330LSEA	LC1G3304BEEA	LC1G3304EHEA	LC1G3304LSEA
550	490	LC1G400BEEA	LC1G400EHEA	LC1G400LSEA	LC1G4004BEEA	LC1G4004EHEA	LC1G4004LSEA
700	630	LC1G500BEEA	LC1G500EHEA	LC1G500LSEA	LC1G5004BEEA	LC1G5004EHEA	LC1G5004LSEA
1050	850	-	LC1G630EHEA	LC1G630LSEA	-	LC1G6304EHEA	LC1G6304LSEA
1050	900	-	LC1G800EHEA	LC1G800LSEA	-	LC1G8004EHEA	LC1G8004LSEA

(1) Switching of IE3/IE4 high efficiency squirrel-cage motors.

Coordination tables:
pages A5/7 to A5/42

Characteristics:
pages B9/25 to B9/29

Dimensions:
pages B9/30 to B9/32

Diagrams:
page B9/34

TeSys Control

Giga High power contactors – Advanced – 3-pole and 4-pole

Product references

Motor ratings (HP) UL- 3phase				Reference Advanced version contactors AC/DC coil voltage 3-pole		
200/208 V	230/240 V	460/480 V	575/600 V	24-48 V	48-130 V	200-500 V
30	40	75	100	LC1G115BEEA	LC1G115EHEA	LC1G115LSEA
40	50	100	125	LC1G150BEEA	LC1G150EHEA	LC1G150LSEA
50	60	125	150	LC1G185BEEA	LC1G185EHEA	LC1G185LSEA
60	75	150	150	LC1G225BEEA	LC1G225EHEA	LC1G225LSEA
75	100	200	200	LC1G265BEEA	LC1G265EHEA	LC1G265LSEA
100	125	250	300	LC1G330BEEA	LC1G330EHEA	LC1G330LSEA
125	150	300	400	LC1G400BEEA	LC1G400EHEA	LC1G400LSEA
150	200	400	450	LC1G500BEEA	LC1G500EHEA	LC1G500LSEA
250	300	600	700	-	LC1G630EHEA	LC1G630LSEA
300	350	700	800	-	LC1G800EHEA	LC1G800LSEA

COORD.



High power contactors

TeSys Control

Giga High power contactors – Standard – 3-pole and 4-pole

Product references

TeSys Giga 3-pole Standard contactors – For motor control – (115 to 800 A)



Motor ratings (kW) $\theta \leq 60\text{ }^\circ\text{C}$

IEC																				
AC-3							AC-3e ⁽¹⁾							AC-4						
230 V	400 V	415 V	440 V	500 V	690 V	1000 V	230 V	400 V	415 V	440 V	500 V	690 V	1000 V	230 V	400 V	415 V	440 V	500 V	690 V	1000 V
kW	kW	kW	kW	kW	kW	kW	kW	kW	kW	kW	kW	kW	kW	kW	kW	kW	kW	kW	kW	kW
30	55	55	75	75	75	-	30	55	55	75	75	75	-	30	55	55	65	65	75	-
37	75	75	90	90	90	75	37	75	75	90	90	90	75	37	75	75	80	90	90	75
55	90	90	110	110	110	75	55	90	90	110	110	110	75	55	90	90	100	110	110	75
55	110	110	132	132	160	132	55	110	110	132	132	160	132	55	110	110	129	132	132	110
75	132	132	160	160	200	160	75	132	132	160	160	200	160	75	132	132	150	160	160	160
90	160	160	200	200	220	185	90	160	160	185	200	220	185	90	160	160	185	200	220	185
110	200	200	250	250	315	220	110	200	200	250	250	315	220	110	200	200	220	250	315	220
160	250	250	315	355	355	335	147	250	250	280	315	355	335	150	250	250	295	295	355	280
200	335	375	400	400	500	450	180	315	335	355	375	500	450	180	315	335	355	375	450	355
250	450	450	450	500	560	450	200	335	355	375	425	560	450	200	375	355	375	400	475	400

COORD.



TeSys Giga 3-pole and 4-pole Standard contactors for load control only (non motor) – (250 to 1050 A)

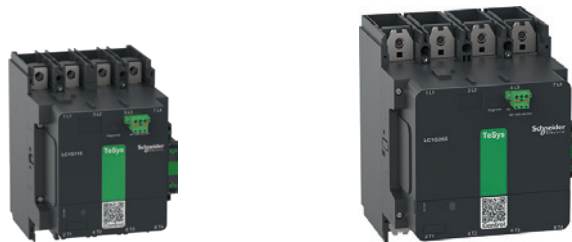

High power contactors

Maximum current (A) ($\theta \leq 40\text{ }^\circ\text{C}$)	General purpose continuous current (A)	Reference			
		Standard version contactors			
		AC/DC coil voltage		4-pole	
IEC	UL	3-pole	3-pole	48...130 V	100...250 V
AC-1					
250	210	LC1G115EHEN	LC1G115KUEH	LC1G1154EHEN	LC1G1154KUEH
275	230	LC1G150EHEN	LC1G150KUEH	LC1G1504EHEN	LC1G1504KUEH
305	250	LC1G185EHEN	LC1G185KUEH	LC1G1854EHEN	LC1G1854KUEH
330	290	LC1G225EHEN	LC1G225KUEH	LC1G2254EHEN	LC1G2254KUEH
385	340	LC1G265EHEN	LC1G265KUEH	LC1G2654EHEN	LC1G2654KUEH
440	390	LC1G330EHEN	LC1G330KUEH	LC1G3304EHEN	LC1G3304KUEH
550	490	LC1G400EHEN	LC1G400KUEH	LC1G4004EHEN	LC1G4004KUEH
700	630	LC1G500EHEN	LC1G500KUEH	LC1G5004EHEN	LC1G5004KUEH
1050	850	LC1G630EHEN	LC1G630KUEH	LC1G6304EHEN	LC1G6304KUEH
1050	900	LC1G800EHEN	LC1G800KUEH	LC1G8004EHEN	LC1G8004KUEH

(1) Switching of IE3/IE4 high efficiency squirrel-cage motors.

Coordination tables:
pages A5/7 to A5/42

Characteristics:
pages B9/25 to B9/29

Dimensions:
pages B9/30 to B9/32

Diagrams:
page B9/34

TeSys Control

Giga High power contactors – Standard – 3-pole and 4-pole

Product references

Motor ratings (HP) UL- 3phase				Reference Standard version contactors AC/DC coil voltage 3-pole	
200/208 V	230/240 V	460/480 V	575/600 V	48-130 V	100-250 V
30	40	75	100	LC1G115EHEN	LC1G115KUEN
40	50	100	125	LC1G150EHEN	LC1G150KUEN
50	60	125	150	LC1G185EHEN	LC1G185KUEN
60	75	150	150	LC1G225EHEN	LC1G225KUEN
75	100	200	200	LC1G265EHEN	LC1G265KUEN
100	125	250	300	LC1G330EHEN	LC1G330KUEN
125	150	300	400	LC1G400EHEN	LC1G400KUEN
150	200	400	450	LC1G500EHEN	LC1G500KUEN
250	300	600	700	LC1G630EHEN	LC1G630KUEN
300	350	700	800	LC1G800EHEN	LC1G800KUEN

COORD.



High power
contactors

TeSys Control

Giga High power contactors – Auxiliary contact modules

Product references



LAG8N113

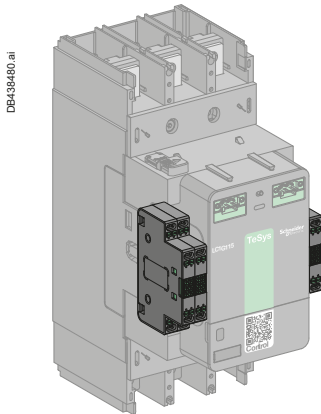

Side mounting – maximum 2 per side

Auxiliary contact modules

Auxiliary contacts give an indication of the contactor status. They can be used for remote visual signaling, alarming, electrical locking, relay activation, etc...

Each contactor is equipped with 1 NO + 1 NC auxiliary contact block as standard.

■ Mechanically linked mirror contacts

The NC contact of the auxiliary contact block is mirror contact in conformity to IEC 60947-4-1 and it is mechanically linked to reliably represent the state of the main power contacts and wherever auxiliary contact state reliability is essential. The main power contacts and the NC of the auxiliary contact can't be closed at the same time.

Types of connections:

■ Push-in type.

Wide contactor compatibility

TeSys Giga auxiliary contact module is compatible with the whole range of TeSys Giga High power contactors .

Each TeSys Giga Contactor can be equipped with up to 4 auxiliary contact modules.

Electrical characteristics

Characteristics

Rated thermal current (A)	10
Minimum load	1 mA at 17 V DC
Contact reliability	Failure rate <10 ⁻⁸

Operational power of contacts conforming to IEC 60947-5-1 - Electrical durability

category AC-15

Operating cycles	V	24	48	115	230	400	500
1 million	VA	60	120	280	560	800	500
2 million	VA	24	48	115	230	400	250
3 million	VA	16	32	80	160	280	150

category DC-13

Operating cycles	V	24	48	125	250	440
0.5 million	W	100	100	105	110	88
1 million	W	48	72	54	54	55
2 million	W	24	36	38	38	39
3 million	W	16	24	25	25	33

Connector characteristics

Push-in connection - Dual input			Min/max c.s.a.
Flexible cable per input	1 conductor with cable end	mm ²	0.75...2.5
	2 conductors with Dual Sleeve	mm ²	0.75...2.5
	Stripping length	mm	10
Solid cable per input	1 conductor	mm ²	0.75...2.5
	Stripping length	mm	12

Auxiliary contact modules

Description	Terminal type	Position	Type of contacts	Sold in lots of	Reference
Auxiliary contact module	Push-in	1 st left or right	1 NO + 1 NC	1	LAG8N113P ⁽¹⁾
			2 NO	1	LAG8N203P
		2 nd left or right	1 NO + 1 NC	1	LAG8N113
			2 NO	1	LAG8N203

⁽¹⁾ Always supplied with TeSys Giga LC1G contactors, fitted to the right side lateral face.

COORD.

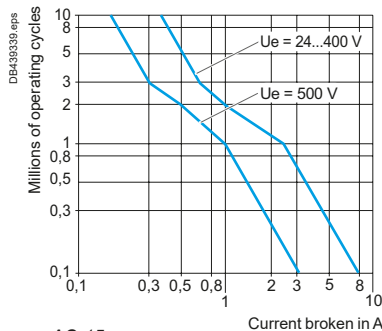

AC-15

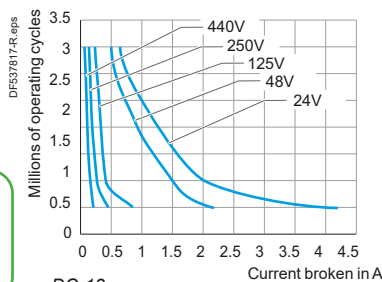

DC-13

High power contactors

Power terminals

‘Cable Memory’ connection blocks

Cables or busbars can be connected to the contactor by means of the optional cable memory connection blocks. When the contactor is removed for maintenance, the cables or busbars remain connected to these connection blocks, making reinstallation faster and easier.



LA9G3101

Cable memory ⁽¹⁾				
Description	Compatible with contactors	Quantity Set of	Reference	
'Cable memory' for 3-pole contactors – for holding cables in place	LC1G115...LC1G225	2	LA9G3101	
	LC1G265...LC1G500	2	LA9G3102	
	LC1G630...LC1G800	2	LA9G3103	
'Cable memory' for 4-pole contactors – for holding cables in place	LC1G115...LC1G225	2	LA9G4101	
	LC1G265...LC1G500	2	LA9G4102	
	LC1G630...LC1G800	2	LA9G4103	

(1) 'Cable memory' connection blocks are always supplied with Advanced contactor version.

Flexible terminal extensions

Flexible connecting bars to connect TeSys Giga High power contactors with MCCBs mounted in the same plane and orientation. These bars can be used along with Advanced or Standard version contactors. They help to get a quick and easy connection between contactor and MCCB with saving in installation time.

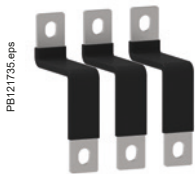

LA9G3111

'Flexible terminal extensions' for MCCBs				
Description	Compatible with contactors	To connect with NSX/NS MCCBs	Quantity Set of	Reference
Flexible terminal extensions 3-pole	LC1G115...LC1G225	NSX100...NSX250	3	LA9G3111
	LC1G265...LC1G500	NSX400...NSX630	3	LA9G3112
	LC1G630...LC1G800	NS800...NS1250	3	LA9G3113
Flexible terminal extensions 4-pole	LC1G115...LC1G225	NSX100...NSX250	4	LA9G4111
	LC1G265...LC1G500	NSX400...NSX630	4	LA9G4112
	LC1G630...LC1G800	NS800...NS1250	4	LA9G4113

Straight terminal extensions



LA9G3601

Description	Suitable for	Compatible with contactors	Quantity Set of	Reference
Straight terminal extension	3P	LC1G115...LC1G225	3	LA9G3601
		LC1G265...LC1G500	3	LA9G3602
		LC1G630...LC1G800	3	LA9G3603
	4P	LC1G115...LC1G225	4	LA9G4601
		LC1G265...LC1G500	4	LA9G4602
		LC1G630...LC1G800	4	LA9G4603

Right angled terminal extensions



LA9G3682

Description	Suitable for	Compatible with contactors	Quantity Set of	Reference
Right angled side terminal extension	3P	LC1G115...LC1G225	3	LA9G3661
		LC1G265...LC1G500	3	LA9G3662
		LC1G630...LC1G800	3	LA9G3663
Right angled large terminal extension	3P	LC1G115...LC1G225	3	LA9G3671
		LC1G265...LC1G500	3	LA9G3672
		LC1G630...LC1G800	3	LA9G3673
Right angled rear terminal extension	3P	LC1G115...LC1G225	3	LA9G3681
		LC1G265...LC1G500	3	LA9G3682
		LC1G630...LC1G800	3	LA9G3683

Edgewise terminal extensions



LA9G3631

Description	Suitable for	Compatible with contactors	Quantity Set of	Reference
Edgewise terminal extension	3P	LC1G115...LC1G225	3	LA9G3631
		LC1G265...LC1G500	3	LA9G3632
		LC1G630...LC1G800	3	LA9G3633
	4P	LC1G115...LC1G225	4	LA9G4631
		LC1G265...LC1G500	4	LA9G4632
		LC1G630...LC1G800	4	LA9G4633



PB121576.eps

LA9G3611

Power terminals

Spreader kits

Description	Suitable for	Compatible with contactors	Increase of Pole pitch	Quantity Set of	Reference
Spreader kits	3P	LC1G115...LC1G225	35 to 45 mm	3	LA9G3611
		LC1G265...LC1G500	45 to 70 mm	3	LA9G3612
	4P	LC1G115...LC1G225	35 to 45 mm	4	LA9G4611
		LC1G265...LC1G500	45 to 70 mm	4	LA9G4612



PB121646.eps

LA9G3613

Terminal extensions for larger power connections

Description	Suitable for	Compatible with contactors	Power connection size	Quantity Set of	Reference
Terminal connections	3P	LC1G400...LC1G500	50 mm width	3	LA9G3613
		LC1G630...LC1G800	80 mm width	3	LA9G3614
	4P	LC1G400...LC1G500	50 mm width	4	LA9G4613
		LC1G630...LC1G800	80 mm width	4	LA9G4614



PB121651.eps

LA9G4711

Spreader kits suitable for box type connectors

Description	Suitable for	Compatible with contactors	Increase of Pole pitch	Suitable for box connectors	Quantity Set of	Reference
Spreader kits for box connectors	3P	LC1G115...LC1G225	35 to 45 mm	DZ2 FJ1/FH1 & AL400	3	LA9G3711
		LC1G265...LC1G500	45 to 70 mm	DZ2 FJ1/FK1 & AL400/AL600	3	LA9G3712
		LC1G630...LC1G800	70 to 80 mm	DZ2 FL1/FK1 & Type S/AL600	3	LA9G3714
	4P	LC1G115...LC1G225	35 to 45 mm	DZ2 FJ1/FH1 & AL400	4	LA9G4711
		LC1G265...LC1G500	45 to 70 mm	DZ2 FJ1/FK1 & AL400/AL600	4	LA9G4712
		LC1G630...LC1G800	70 to 80 mm	DZ2 FL1/FK1 & Type S/AL600	4	LA9G4714

TeSys Control

Giga High power contactors – Power wiring accessories

Product references

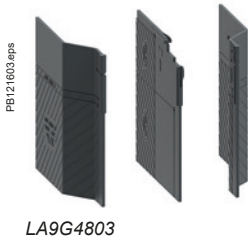

Power terminal accessories

Phase separators

Description	Suitable for	Compatible with contactors	Quantity Set of	Reference
Phase separators ⁽¹⁾	3P	LC1G115...LC1G800	2	LA9G3801
	4P	LC1G115...LC1G800	3	LA9G4801
	3P – with 50/80 mm spreaders	LC1G400...LC1G800	2	LA9G3803 ⁽²⁾
	4P – with 50/80 mm spreaders	LC1G400...LC1G800	3	LA9G4803 ⁽³⁾

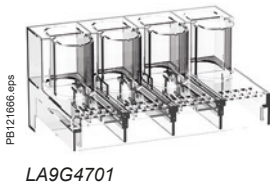

Terminal shrouds

Description	Compatible with contactors	Quantity Set of	Reference	
			3P	4P
IP 20 Terminal shrouds ⁽¹⁾	LC1G115...LC1G225	1	LA9G3701	LA9G4701
	LC1G265...LC1G500	1	LA9G3702	LA9G4702
	LC1G630...LC1G800	1	LA9G3703	LA9G4703



IP20 Lug cover for connection kits ⁽⁴⁾

Lug covers are used along with IP 20 terminal shrouds and star-delta, reverser and changeover connection kit assemblies to improve insulation of the coupling bars and achieve IP 20 for the complete assembly.

IP20 Lug cover for connection kits

Description	Suitable for	Compatible with contactors	Quantity Set of	Reference
IP 20 Lug cover	3P	LC1G115...LC1G800 ⁽⁴⁾	6	LA9G3707
	4P	LC1G115...LC1G800 ⁽⁴⁾	8	LA9G4707



Lugs for cable set

Description	Compatible with contactors	Cable section	Reference	
			Set of 3 for 3P	Set of 4 for 4P
Lugs for cable	LC1G115...LC1G225	120 mm ²	LV429252	LV429256
	LC1G115...LC1G225	150 mm ²	LV429253	LV429257
	LC1G115...LC1G225	185 mm ²	LV429254	LV429258
	LC1G265...LC1G500	240 mm ²	LV432500	LV432501
	LC1G265...LC1G500	300 mm ²	LV432502	LV432503



Star-Delta (Wye-Delta) connection kits ⁽⁵⁾

Description	Suitable for	Compatible for Line (KM2) and Delta (KM3) contactor	+ Star contactor (KM1)	Reference
Connection kit: bars for Line-Delta-Star contactor assembly	3P	LC1G115...LC1G225	LC1G115...LC1G225	LA9GQQ330
		LC1G265...LC1G500	LC1G115...LC1G225	LA9GSQ330
		LC1G265...LC1G500	LC1G265...LC1G500	LA9GSS330
		LC1G630...LC1G800	LC1G265...LC1G500	LA9GTS330
	with cable memory kit	3P	LC1G630...LC1G800	LC1G630...LC1G800
LC1G265...LC1G500			LC1G115...LC1G225	LA9GSQ331
		LC1G630...LC1G800	LC1G265...LC1G500	LA9GTS331

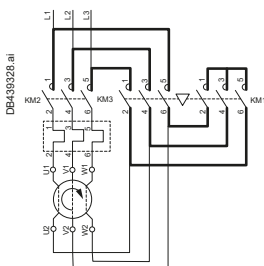

Mechanical interlock

Description	Suitable for	Compatible with contactors		Reference
		Contactor 1	Contactor 2	
Mechanical interlock between contactors ⁽⁶⁾	3P and 4P	LC1G115...225	LC1G115...225	LA9G970
		LC1G265...500	LC1G265...500	LA9G970
		LC1G265...500	LC1G115...225	LA9G971
	3P	LC1G630...800	LC1G265...500	LA9G972
		LC1G630...800	LC1G630...800	LA9G973

Note: RE17RMMWS timer to be used for Star-Delta starter application.

⁽¹⁾ Either phase separators or terminal shrouds can only be mounted. Phase separators or terminal shrouds are mandatory for operational voltage, $U_e \geq 690$ V.

⁽²⁾ To be used with LA9G3613 and LA9G3614.

⁽³⁾ To be used with LA9G4613 and LA9G4614.

⁽⁴⁾ 2 sets of IP20 lug covers are needed for assemblies with LC1G630 and LC1G800 contactors.

⁽⁵⁾ UL listed.

⁽⁶⁾ Maximum 3 auxiliary contacts can be installed between 2 contactors with mechanical interlock kit.

High power contactors

TeSys Control

Giga High power contactors – Power wiring accessories

Product references

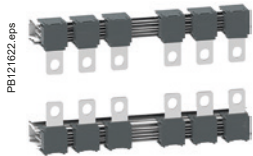

LA9G3760

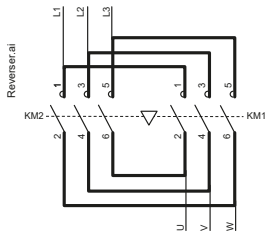

Reverser connection kits

Description	Suitable for	Compatible with contactors	Reference
Connection kit: bars for reverser contactor assembly	3P	LC1G115...LC1G225	LA9G3760
		LC1G265...LC1G500	LA9G3761
		LC1G630...LC1G800	LA9G3762



LA9G3750

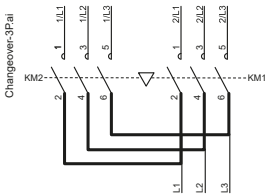

Changeover connection kits

Description	Suitable for	Compatible with contactors	Reference
Connection kit: bars for changeover contactor assembly	3P	LC1G115...LC1G225	LA9G3750
		LC1G265...LC1G500	LA9G3751
		LC1G630...LC1G800	LA9G3752
	4P	LC1G115...LC1G225	LA9G4750
		LC1G265...LC1G500	LA9G4751
		LC1G630...LC1G800	LA9G4752

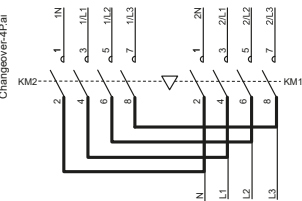

Modular timer relay for star-delta starters

- 8 A, 1 CO, multifunction with spring terminals, 12...240 V AC/DC
- 17.5 mm width same size as a 1-pole circuit breaker
- Covers 0.1 s to 100 h timing
- Transparent cover to protect settings from being tampered
- Multi functional gives flexibility in maintenance

Modular timer relay for star-delta starters

Description	Suitable for	Compatible with contactors	Reference
Harmony, Modular timing relay	3P	LC1G115...LC1G800	RE17RMMWS



RE17RMMWS

High power contactors

TeSys Control

Giga High power contactors – Mounting accessories

Product references

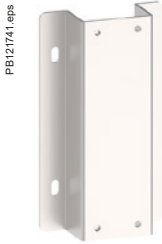

LA9GRFB1

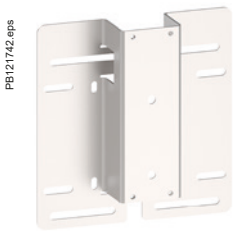

LA9GRFB2

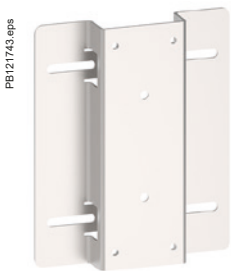

LA9GRFB3

Retrofit bases

- Suitable for 3 pole contactors
- Retrofit bases to replace similar ratings of TeSys F contactors with TeSys Giga High power contactors
- Enables quick and simple replacement in the existing installation
- 3 references to cover ranges from LC1F115 to F800

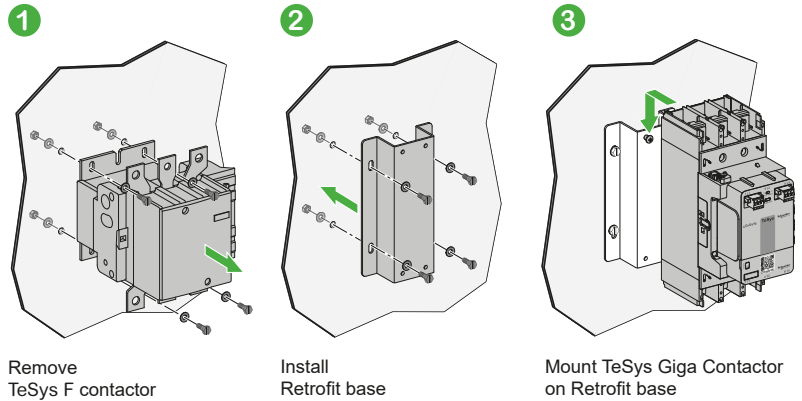

TeSys Giga retrofit bases are designed for integrating new TeSys Giga High power contactors into installations using TeSys F contactors. The retrofit bases help reduce replacement and reinstallation time when you upgrade your system with the new range of contactors. The bases come in two frame sizes.

Retrofit bases

Description		Reference
Accessory used to replace	LC1F115-225 replaced by LC1G115-225	LA9GRFB1
TeSys F contactors	LC1F265-500 replaced by LC1G265-500	LA9GRFB2
	LC1F630-800 replaced by LC1G630-800	LA9GRFB3

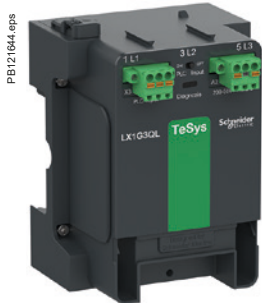

LX1G3QLSEA

Control module

Wide band electronic control
24 V...500 V 50/60 Hz or DC control input
Advanced and standard versions
Accessible from the front for easy and quick replacement

The control module is needed for the operation of the contactor. It performs the following functions:

- proper functioning of contactor based on the input control voltage
- monitoring and diagnostics of the pole condition
- generation of signaling commands.

The range of control modules is organized:

- per contactor size and for each rating,
- per control voltage range.

Each module has connectors for connecting:

- the coil control A1, A2 circuit & PLC output control (advanced version)
- pole status and diagnostic signaling circuits.



Control module replacement on a 3-pole contactor

Control modules					
Description	For contactors	References per voltage range (V AC/DC)	References per voltage range		
			24 - 48	48 - 130	200 - 500
Control modules for Advanced contactors	3-pole	LC1G115...LC1G225	LX1G3QBEEA	LX1G3QEHEA	LX1G3QLSEA
		LC1G265...LC1G330	LX1G3RBEEA	LX1G3REHEA	LX1G3RLSEA
		LC1G400...LC1G500	LX1G3SBEEA	LX1G3SEHEA	LX1G3SLSEA
		LC1G630...LC1G800	-	LX1G3TEHEA	LX1G3TLSEA
Control modules for Advanced contactors	4-pole	LC1G115...LC1G225	LX1G4QBEEA	LX1G4QEHEA	LX1G4QLSEA
		LC1G265...LC1G330	LX1G4RBEEA	LX1G4REHEA	LX1G4RLSEA
		LC1G400...LC1G500	LX1G4SBEEA	LX1G4SEHEA	LX1G4SLSEA
		LC1G630...LC1G800	-	LX1G4TEHEA	LX1G4TLSEA
Control modules for Standard contactors	3-pole	LC1G115...LC1G225	LX1G3QEHEN	LX1G3QKUEN	
		LC1G265...LC1G330	LX1G3REHEN	LX1G3RKUEN	
		LC1G400...LC1G500	LX1G3SEHEN	LX1G3SKUEN	
		LC1G630...LC1G800	LX1G3TEHEN	LX1G3TKUEN	
	4-pole	LC1G115...LC1G225	LX1G4QEHEN	LX1G4QKUEN	
		LC1G265...LC1G330	LX1G4REHEN	LX1G4RKUEN	
		LC1G400...LC1G500	LX1G4SEHEN	LX1G4SKUEN	
		LC1G630...LC1G800	LX1G4TEHEN	LX1G4TKUEN	

Connector for control module		
Description		Reference
Push-in terminal connector for control module		LA9G81

Remote wear diagnostic (RWD) module	
Description	Reference
Remote wear diagnostic module for TeSys Giga Contactor - 1 NO	LA9GRD10 ⁽¹⁾
Remote wear diagnostic module for TeSys Giga Contactor - 1 NC	LA9GRD01 ⁽¹⁾

⁽¹⁾ Remote Wear Diagnostic (RWD) Module, can be installed and used only in Advanced version.



LA9G81



LA9GRD10

PB121588.eps



Switching module kits

Replaceable switching modules

- Innovative contact switching modules for TeSys Giga High power contactors
- Replace worn-out poles with a new switching module in minutes, without having to disassemble the whole product
- No special tools are needed for the replacement.

TeSys Giga - Switching modules for TeSys Giga High power contactors , Advanced and Standard versions

Description	For contactors	Quantity Set of	Reference
3 or 4 switching module kits	3-pole	LC1G115...LC1G225	3 LA9G3QA
		LC1G265...LC1G330	3 LA9G3RA
		LC1G400...LC1G500	3 LA9G3SA
		LC1G630...LC1G800	3 LA9G3TA
	4-pole	LC1G115...LC1G225	4 LA9G4QA
		LC1G265...LC1G330	4 LA9G4RA
		LC1G400...LC1G500	4 LA9G4SA
		LC1G630...LC1G800	4 LA9G4TA

Note: In the event of replacement, replace all switching modules. After replacement, change the position of RESET button on the control module from A to B or B to A.

TeSys Control

Giga High power contactors

Product references

LA9G3101	LA9G3TA	LA9GTT330	LC1G265BEEA	LC1G800LSEA
LA9G3102	LA9G4101	LAG8N113	LC1G265EHEA	LV429252
LA9G3103	LA9G4102	LAG8N113P	LC1G265EHEN	LV429253
LA9G3111	LA9G4103	LAG8N203	LC1G265KUEN	LV429254
LA9G3112	LA9G4111	LAG8N203P	LC1G265LSEA	LV429256
LA9G3113	LA9G4112	LC1G1154BEEA	LC1G3304BEEA	LV429257
LA9G3601	LA9G4113	LC1G1154EHEA	LC1G3304EHEA	LV429258
LA9G3602	LA9G4601	LC1G1154EHEN	LC1G3304EHEN	LV432500
LA9G3603	LA9G4602	LC1G1154KUEN	LC1G3304KUEN	LV432501
LA9G3611	LA9G4603	LC1G1154LSEA	LC1G3304LSEA	LV432502
LA9G3612	LA9G4611	LC1G115BEEA	LC1G330BEEA	LV432503
LA9G3613	LA9G4612	LC1G115EHEA	LC1G330EHEA	LX1G3QBEEA
LA9G3614	LA9G4613	LC1G115EHEN	LC1G330EHEN	LX1G3QEHEA
LA9G3631	LA9G4614	LC1G115KUEN	LC1G330KUEN	LX1G3QEHEN
LA9G3632	LA9G4631	LC1G115LSEA	LC1G330LSEA	LX1G3QKUEN
LA9G3633	LA9G4632	LC1G1504BEEA	LC1G4004BEEA	LX1G3QLSEA
LA9G3650	LA9G4633	LC1G1504EHEA	LC1G4004EHEA	LX1G3RBEEA
LA9G3651	LA9G4701	LC1G1504EHEN	LC1G4004EHEN	LX1G3REHEA
LA9G3652	LA9G4702	LC1G1504KUEN	LC1G4004KUEN	LX1G3REHEN
LA9G3653	LA9G4703	LC1G1504LSEA	LC1G4004LSEA	LX1G3RKUEN
LA9G3661	LA9G4707	LC1G150BEEA	LC1G400BEEA	LX1G3RLSEA
LA9G3662	LA9G4711	LC1G150EHEA	LC1G400EHEA	LX1G3SBEEA
LA9G3663	LA9G4712	LC1G150EHEN	LC1G400EHEN	LX1G3SEHEA
LA9G3671	LA9G4714	LC1G150KUEN	LC1G400KUEN	LX1G3SEHEN
LA9G3672	LA9G4750	LC1G150LSEA	LC1G400LSEA	LX1G3SKUEN
LA9G3673	LA9G4751	LC1G1854BEEA	LC1G5004BEEA	LX1G3SLSEA
LA9G3681	LA9G4752	LC1G1854EHEA	LC1G5004EHEA	LX1G3TEHEA
LA9G3682	LA9G4801	LC1G1854EHEN	LC1G5004EHEN	LX1G3TEHEN
LA9G3683	LA9G4803	LC1G1854KUEN	LC1G5004KUEN	LX1G3TKUEN
LA9G3701	LA9G4QA	LC1G1854LSEA	LC1G5004LSEA	LX1G3TLSEA
LA9G3702	LA9G4RA	LC1G185BEEA	LC1G500BEEA	LX1G4QBEEA
LA9G3703	LA9G4SA	LC1G185EHEA	LC1G500EHEA	LX1G4QEHEA
LA9G3704	LA9G4TA	LC1G185EHEN	LC1G500EHEN	LX1G4QEHEN
LA9G3705	LA9G81	LC1G185KUEN	LC1G500KUEN	LX1G4QKUEN
LA9G3706	LA9G82	LC1G185LSEA	LC1G500LSEA	LX1G4QLSEA
LA9G3707	LA9G970	LC1G2254BEEA	LC1G6304EHEA	LX1G4RBEEA
LA9G3711	LA9G971	LC1G2254EHEA	LC1G6304EHEN	LX1G4REHEA
LA9G3712	LA9G972	LC1G2254EHEN	LC1G6304KUEN	LX1G4REHEN
LA9G3714	LA9G973	LC1G2254KUEN	LC1G6304LSEA	LX1G4RKUEN
LA9G3750	LA9GQQ330	LC1G2254LSEA	LC1G630EHEA	LX1G4RLSEA
LA9G3751	LA9GRD01	LC1G225BEEA	LC1G630EHEN	LX1G4SBEEA
LA9G3752	LA9GRD10	LC1G225EHEA	LC1G630KUEN	LX1G4SEHEA
LA9G3760	LA9GRFB1	LC1G225EHEN	LC1G630LSEA	LX1G4SEHEN
LA9G3761	LA9GRFB2	LC1G225KUEN	LC1G8004EHEA	LX1G4SKUEN
LA9G3762	LA9GRFB3	LC1G225LSEA	LC1G8004EHEN	LX1G4SLSEA
LA9G3801	LA9GSQ330	LC1G2654BEEA	LC1G8004KUEN	LX1G4TEHEA
LA9G3803	LA9GSQ331	LC1G2654EHEA	LC1G8004LSEA	LX1G4TEHEN
LA9G3QA	LA9GSS330	LC1G2654EHEN	LC1G800EHEA	LX1G4TKUEN
LA9G3RA	LA9GTS330	LC1G2654KUEN	LC1G800EHEN	LX1G4TLSEA
LA9G3SA	LA9GTS331	LC1G2654LSEA	LC1G800KUEN	

This document is current.  Click on the product reference to get the most recent availability status (hyperlink to [se.com](https://www.se.com) product datasheet).
If your product variant is no longer available, please consult your distributor or regional sales office.

X-ON Electronics

Largest Supplier of Electrical and Electronic Components

Click to view similar products for [Contactor Accessories](#) category:

Click to view products by [Schneider](#) manufacturer:

Other Similar products are found below :

[3RT1945-5AP61](#) [YC9Z-RHU10A16P](#) [YC9Z-RHU5A1P6](#) [YC9Z-CI6](#) [YC9Z-CNA211M](#) [LR3D06](#) [LR3D08](#) [1SAX351001R1101](#)
[1SBN050100R1002](#) [1SBN050020R1003](#) [022.63](#) [F4-22](#) [EH04-11N](#) [CA4-31E](#) [CAL5X-11](#) [F5-T0](#) [CA5X-22M](#) [YC9Z-LCU38A24](#) [YC9Z-](#)
[RHU5A2P5](#) [49AB20](#) [75D73251A](#) [GHV2501910R0001](#) [022.18.0](#) [DILA-XHI22-PI](#) [LA4DA2U](#) [LA4KA1U](#) [022.33](#) [DILA-XHI40-PI](#)
[11BA135](#) [P1X1011](#) [A9C15915](#) [DILA-XHI20-PI](#) [1SBN082306T2000](#) [DILA-XHI11-PI](#) [SPM-05-11](#) [A9C15914](#) [1SAX531001R1101](#) [022.35](#)
[022.18](#) [DILM32-XHI11-PI](#) [DILM32-XHI22-PI](#) [GHV2501903R0002](#) [DILA-XHI13-PI](#) [1SBN020114R1000](#) [1SBN081306T1000](#) [LAD9V5](#)
[1SAX721001R1101](#) [1SBN020312R1000](#) [1SAX221001R1101](#) [BFX1211](#)