

5 - TeSys contactors and reversing contactors

- Contactors: definitions and comments page 5/2
- Tests according to standard utilisation categories conforming to IEC 60947-4-1 and 5-1 page 5/4
- Current of asynchronous squirrel cage motors at nominal load page 5/5
- TeSys contactors selection guide page 5/6**

TeSys K contactors and reversing contactors

- Selection guide page 5/8**

- Contactors
 - 6 to 16 A in category AC-3 and 6 to 12 A in category AC-4 page 5/14
 - 6 to 12 A in categories AC-3 and AC-4 page 5/15
 - 20 A in category AC-1 page 5/17
- Reversing contactors
 - 6 to 16 A in category AC-3 and 6 to 12 A in category AC-4 page 5/18
 - 6 to 12 A in categories AC-3 and AC-4 page 5/19
 - 20 A in category AC-1 page 5/20
- Auxiliary contact blocks, suppressor modules and accessories page 5/23

TeSys LC1 SK and LP1 SK mini-contactors

- For motor control in categories AC-3 and AC-1 page 5/34
- Instantaneous auxiliary contact blocks and suppressor modules page 5/35

TeSys LC1 SKGC mini-contactors

- For use in modular panels page 5/42
- Suppressor modules page 5/43

TeSys D contactors and reversing contactors

- Selection guide page 5/46**

- Contactors for motor control
 - Up to 75 kW at 400 V, in category AC-3 page 5/62
 - Up to 30 kW at 400 V, in category AC-3 page 5/63
 - From 25 to 200 A, in category AC-1 page 5/64
 - From 20 to 200 A, for the North American market, conforming to UL and CSA standards page 5/71
- Reversing contactors for motor control
 - Up to 75 kW at 400 V, in category AC-3 page 5/72
 - Up to 15 kW at 400 V, in category AC-3 page 5/73
 - From 20 to 200 A, in category AC-1 page 5/74
- Components parts for assembling reversing contactors page 5/76
- Instantaneous auxiliary contact blocks and suppressor modules page 5/79
- Coils for TeSys D contactors page 5/86

TeSys contactors for switching 3-phase capacitor banks

- Contactors used for power factor correction page 5/102

TeSys F contactors and reversing contactors

Selection guide **page 5/104**

- Contactors for motor control
 - 115 to 800 A, in category AC-3 *page 5/114*
 - 200 to 2100 A, in category AC-1 *page 5/115*
- Reversing contactors
 - 115 to 265 A, in category AC-3 *page 5/116*
 - 200 to 350 A, in category AC-1 *page 5/117*
 - Components for assembling reversing contactors *page 5/118*
 - Instantaneous contact blocks and accessories *page 5/123*
- Coils for TeSys F contactors *page 5/130*

High power changeover contactor pairs for distribution

- For customer assembly *page 5/153*

Capacitive delayed opening devices

- For TeSys D contactors *page 5/156*
- For TeSys F contactors *page 5/157*

TeSys LC1 FG shockproof contactors

- Presentation, selection. *page 5/158*
- Characteristics *page 5/166*
- References *page 5/174*
- Dimensions and schemes *page 5/180*

TeSys LC1 B contactors

- 750 to 1800 A, in category AC-3 *page 5/184*
- 800 to 2750 A, in category AC-1 *page 5/185*
- Accessories and spare parts *page 5/186*
- Replacement coils *page 5/188*

Variable composition contactors

Selection guide **page 5/226**

- CV1 B from 80 to 1000 A and CV3 B from 80 to 500 A *page 5/228*

3-pole vacuum contactors and reversing contactors

- LC1 V and CV2 V *page 5/232*

Magnetic latching contactors

- CR1 F and CR1 B *page 5/242*

Modular equipment

Selection guide **page 5/268**

- TeSys GC standard contactor *page 5/278*
- TeSys GF impulse relays *page 5/286*
- TeSys GY "dual tariff" contactors *page 5/292*

Definitions

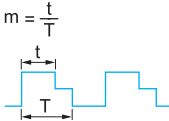
Altitude	<p>The rarefied atmosphere at high altitude reduces the dielectric strength of the air and hence the rated operational voltage of the contactor. It also reduces the cooling effect of the air and hence the rated operational current of the contactor (unless the temperature drops at the same time).</p> <p>No derating is necessary up to 3000 m.</p> <p>Derating factors to be applied above this altitude for main pole operational voltage and current (a.c. supply) are as follows.</p> <table border="1"> <thead> <tr> <th>Altitude</th> <th>3500 m</th> <th>4000 m</th> <th>4500 m</th> <th>5000 m</th> </tr> </thead> <tbody> <tr> <td>Rated operational voltage</td> <td>0,90</td> <td>0,80</td> <td>0,70</td> <td>0,60</td> </tr> <tr> <td>Rated operational current</td> <td>0,92</td> <td>0,90</td> <td>0,88</td> <td>0,86</td> </tr> </tbody> </table>		Altitude	3500 m	4000 m	4500 m	5000 m	Rated operational voltage	0,90	0,80	0,70	0,60	Rated operational current	0,92	0,90	0,88	0,86
Altitude	3500 m	4000 m	4500 m	5000 m													
Rated operational voltage	0,90	0,80	0,70	0,60													
Rated operational current	0,92	0,90	0,88	0,86													
Ambient air temperature	<p>The temperature of the air surrounding the device, measured near to the device.</p> <p>The operating characteristics are given :</p> <ul style="list-style-type: none"> - with no restriction for temperatures between - 5 and + 55 °C, - with restrictions, if necessary, for temperatures between - 50 and + 70 °C. 																
Rated operational current (Ie)	<p>This is defined taking into account the rated operational voltage, operating rate and duty, utilisation category and ambient temperature around the device.</p>																
Rated conventional thermal current (Ith) (1)	<p>The current which a closed contactor can sustain for a minimum of 8 hours without its temperature rise exceeding the limits given in the standards.</p>																
Permissible short time rating	<p>The current which a closed contactor can sustain for a short time after a period of no load, without dangerous overheating.</p>																
Rated operational voltage (Ue)	<p>This is the voltage value which, in conjunction with the rated operational current, determines the use of the contactor or starter, and on which the corresponding tests and the utilisation category are based. For 3-phase circuits it is expressed as the voltage between phases.</p> <p>Apart from exceptional cases such as rotor short-circuiting, the rated operational voltage Ue is less than or equal to the rated insulation voltage Ui.</p>																
Rated control circuit voltage (Uc)	<p>The rated value of the control circuit voltage, on which the operating characteristics are based. For a.c. applications, the values are given for a near sinusoidal wave form (less than 5% total harmonic distortion).</p>																
Rated insulation voltage (Ui)	<p>This is the voltage value used to define the insulation characteristics of a device and referred to in dielectric tests determining leakage paths and creepage distances. As the specifications are not identical for all standards, the rated value given for each of them is not necessarily the same.</p>																
Rated impulse withstand voltage (Uimp)	<p>The peak value of a voltage surge which the device is able to withstand without breaking down.</p>																
Rated operational power (expressed in kW)	<p>The rated power of the standard motor which can be switched by the contactor, at the stated operational voltage.</p>																
Rated breaking capacity (2)	<p>This is the current value which the contactor can break in accordance with the breaking conditions specified in the IEC standard.</p>																
Rated making capacity (2)	<p>This is the current value which the contactor can make in accordance with the making conditions specified in the IEC standard.</p>																
On-load factor (m)	$m = \frac{t}{T}$ 	<p>This is the ratio between the time the current flows (t) and the duration of the cycle (T)</p> <p>Cycle duration: duration of current flow + time at zero current</p>															
Pole impedance	<p>The impedance of one pole is the sum of the impedance of all the circuit components between the input terminal and the output terminal.</p> <p>The impedance comprises a resistive component (R) and an inductive component ($X = L\omega$).</p> <p>The total impedance therefore depends on the frequency and is normally given for 50 Hz.</p> <p>This average value is given for the pole at its rated operational current.</p>																
Electrical durability	<p>This is the average number of on-load operating cycles which the main pole contacts can perform without maintenance. The electrical durability depends on the utilisation category, the rated operational current and the rated operational voltage.</p>																
Mechanical durability	<p>This is the average number of no-load operating cycles (i.e. with zero current flow through the main poles) which the contactor can perform without mechanical failure.</p>																

(1) Conventional thermal current, in free air, conforming to IEC standards.

(2) For a.c. applications, the breaking and making capacities are expressed by the rms value of the symmetrical component of the short-circuit current. Taking into account the maximum asymmetry which may exist in the circuit, the contacts therefore have to withstand a peak asymmetrical current which may be twice the rms symmetrical component.

Note : these definitions are extracted from standard IEC 60947-1.

Contactor utilisation categories conforming to IEC 60947-4

The standard utilisation categories define the current values which the contactor must be able to make or break.

These values depend on:

- the type of load being switched : squirrel cage or slip ring motor, resistors,
- the conditions under which making or breaking takes place: motor stalled, starting or running, reversing, plugging.

a.c. applications

Category AC-1	<p>This category applies to all types of a.c. load with a power factor equal to or greater than 0.95 ($\cos \varphi \geq 0.95$).</p> <p>Application examples: heating, distribution.</p>
Category AC-2	<p>This category applies to starting, plugging and inching of slip ring motors.</p> <ul style="list-style-type: none"> □ On closing, the contactor makes the starting current, which is about 2.5 times the rated current of the motor. □ On opening, it must break the starting current, at a voltage less than or equal to the mains supply voltage.
Category AC-3	<p>This category applies to squirrel cage motors with breaking during normal running of the motor.</p> <ul style="list-style-type: none"> □ On closing, the contactor makes the starting current, which is about 5 to 7 times the rated current of the motor. □ On opening, it breaks the rated current drawn by the motor; at this point, the voltage at the contactor terminals is about 20% of the mains supply voltage. Breaking is light. <p>Application examples: all standard squirrel cage motors: lifts, escalators, conveyor belts, bucket elevators, compressors, pumps, mixers, air conditioning units, etc... .</p>
Category AC-4	<p>This category covers applications with plugging and inching of squirrel cage and slip ring motors. The contactor closes at a current peak which may be as high as 5 or 7 times the rated motor current. On opening it breaks this same current at a voltage which is higher, the lower the motor speed. This voltage can be the same as the mains voltage. Breaking is severe</p> <p>Application examples: printing machines, wire drawing machines, cranes and hoists, metallurgy industry.</p>

d.c. applications

Category DC-1	<p>This category applies to all types of d.c. load with a time constant (L/R) of less than or equal to 1 ms.</p>
Category DC-3	<p>This category applies to starting, counter-current braking and inching of shunt motors. Time constant ≤ 2 ms.</p> <ul style="list-style-type: none"> □ On closing, the contactor makes the starting current, which is about 2.5 times the rated motor current. □ On opening, the contactor must be able to break 2.5 times the starting current at a voltage which is less than or equal to the mains voltage. The slower the motor speed, and therefore the lower its back e.m.f., the higher this voltage. <p>Breaking is difficult.</p>
Category DC-5	<p>This category applies to starting, counter-current braking and inching of series wound motors. Time constant ≤ 7.5 ms.</p> <p>On closing, the contactor makes a starting current peak which may be as high as 2.5 times the rated motor current. On opening, the contactor breaks this same current at a voltage which is higher, the lower the motor speed. This voltage can be the same as the mains voltage. Breaking is severe.</p>

Utilisation categories for auxiliary contacts & control relays conforming to IEC 60947-5

a.c. applications

Category AC-14 (1)	<p>This category applies to the switching of electromagnetic loads whose power drawn with the electromagnet closed is less than 72 VA.</p> <p>Application example: switching the operating coil of contactors and relays.</p>
Category AC-15 (1)	<p>This category applies to the switching of electromagnetic loads whose power drawn with the electromagnet closed is more than 72 VA.</p> <p>Application example: switching the operating coil of contactors.</p>

d.c. applications

Category DC-13 (2)	<p>This category applies to the switching of electromagnetic loads for which the time taken to reach 95 % of the steady state current ($T = 0.95$) is equal to 6 times the power P drawn by the load (with $P \leq 50$ W).</p> <p>Application example: switching the operating coil of contactors without economy resistor.</p>
---------------------------	---

(1) Replaces category AC-11.

(2) Replaces category DC-13.

Technical information

Tests according to standard utilisation categories conforming to IEC 60947-4-1 and 5-1 based on rated operational current I_e and rated operational voltage U_e

Contactor

		Electrical durability: making and breaking conditions						Occasional duty: making and breaking conditions					
a.c. supply													
Typical applications	Utilisation category	Making			Breaking			Making			Breaking		
		I	U	cos φ	I	U	cos φ	I	U	cos φ	I	U	cos φ
Resistors, non inductive or slightly inductive loads	AC-1	I_e	U_e	0.95	I_e	U_e	0.95	$1.5 I_e$	$1.05 U_e$	0.8	$1.5 I_e$	$1.05 U_e$	0.8
Motors													
Slip ring motors: starting, breaking.	AC-2	$2.5 I_e$	U_e	0.65	$2.5 I_e$	U_e	0.65	$4 I_e$	$1.05 U_e$	0.65	$4 I_e$	$1.05 U_e$	0.65
Squirrel cage motors: starting, breaking whilst motor running.	AC-3	$I_e \leq (1)$	U_e	0.65	$1 I_e$	$0.17 U_e$	0.65	$10 I_e$	$1.05 U_e$	0.45	$8 I_e$	$1.05 U_e$	0.45
		$I_e > (2)$	U_e	0.35	$1 I_e$	$0.17 U_e$	0.35	$10 I_e$	$1.05 U_e$	0.35	$8 I_e$	$1.05 U_e$	0.35
Squirrel cage motors: starting, reversing, inching	AC-4	$I_e \leq (1)$	U_e	0.65	$6 I_e$	U_e	0.65	$12 I_e$	$1.05 U_e$	0.45	$10 I_e$	$1.05 U_e$	0.45
		$I_e > (2)$	U_e	0.35	$6 I_e$	U_e	0.35	$12 I_e$	$1.05 U_e$	0.35	$10 I_e$	$1.05 U_e$	0.35
d.c. supply													
Typical applications	Utilisation category	Making			Breaking			Making			Breaking		
		I	U	L/R (ms)	I	U	L/R (ms)	I	U	L/R (ms)	I	U	L/R (ms)
Resistors, non inductive or slightly inductive loads	DC-1	I_e	U_e	1	I_e	U_e	1	$1.5 I_e$	$1.05 U_e$	1	$1.5 I_e$	$1.05 U_e$	1
Shunt wound motors: starting, reversing, inching	DC-3	$2.5 I_e$	U_e	2	$2.5 I_e$	U_e	2	$4 I_e$	$1.05 U_e$	2.5	$4 I_e$	$1.05 U_e$	2.5
Series wound motors: starting, reversing, inching	DC-5	$2.5 I_e$	U_e	7.5	$2.5 I_e$	U_e	7.5	$4 I_e$	$1.05 U_e$	15	$4 I_e$	$1.05 U_e$	15

Control relays and auxiliary contacts

		Electrical durability: making and breaking conditions						Occasional duty: making and breaking conditions					
a.c. supply													
Typical applications	Utilisation category	Making			Breaking			Making			Breaking		
		I	U	cos φ	I	U	cos φ	I	U	cos φ	I	U	cos φ
Electromagnets													
≤ 72 VA	AC-14	–	–	–	–	–	–	$6 I_e$	$1.1 U_e$	0.7	$6 I_e$	$1.1 U_e$	0.7
> 72 VA	AC-15	$10 I_e$	U_e	0.7	I_e	U_e	0.4	$10 I_e$	$1.1 U_e$	0.3	$10 I_e$	$1.1 U_e$	0.3
d.c. supply													
Typical applications	Utilisation category	Making			Breaking			Making			Breaking		
		I	U	L/R (ms)	I	U	L/R (ms)	I	U	L/R (ms)	I	U	L/R (ms)
Electromagnets	DC-13	I_e	U_e	6 P (3)	I_e	U_e	6 P (3)	$1.1 I_e$	$1.1 U_e$	6 P (3)	$1.1 I_e$	$1.1 U_e$	6 P (3)

(1) $I_e \leq 17 A$ for electrical durability, $I_e \leq 100 A$ for occasional duty.

(2) $I_e > 17 A$ for electrical durability, $I_e > 100 A$ for occasional duty.

(3) The value 6 P (in watts) is based on practical observations and is considered to represent the majority of d.c. magnetic loads up to the maximum limit of $P = 50$ W i.e. $6 P = 300 \text{ ms} = L/R$.

Above this, the loads are made up of smaller loads in parallel. The value 300 ms is therefore a maximum limit whatever the value of current drawn.

Technical information

Current of asynchronous squirrel cage motors at nominal load

3-phase 4-pole motors				
Current values for power in kW				
Rated operational power (1)	Indicative rated operational current values at:			
	230 V	400 V	500 V	690 V
kW	A	A	A	A
0.06	0.35	0.2	0.16	0.12
0.09	0.52	0.3	0.24	0.17
0.12	0.7	0.44	0.32	0.23
0.18	1	0.6	0.48	0.35
0.25	1.5	0.85	0.68	0.49
0.37	1.9	1.1	0.88	0.64
0.55	2.6	1.5	1.2	0.87
0.75	3.3	1.9	1.5	1.1
1.1	4.7	2.7	2.2	1.6
1.5	6.3	3.6	2.9	2.1
2.2	8.5	4.9	3.9	2.8
3	11.3	6.5	5.2	3.8
4	15	8.5	6.8	4.9
5.5	20	11.5	9.2	6.7
7.5	27	15.5	12.4	8.9
11	38	22	17.6	12.8
15	51	29	23	17
18.5	61	35	28	21
22	72	41	33	24
30	96	55	44	32
37	115	66	53	39
45	140	80	64	47
55	169	97	78	57
75	230	132	106	77
90	278	160	128	93
110	340	195	156	113
132	400	230	184	134
160	487	280	224	162
200	609	350	280	203
250	748	430	344	250
315	940	540	432	313
355	1061	610	488	354
400	1200	690	552	400
500	1478	850	680	493
560	1652	950	760	551
630	1844	1060	848	615
710	2070	1190	952	690
800	2340	1346	1076	780
900	2640	1518	1214	880
1000	2910	1673	1339	970

Current values for power in hp							
Rated operational power (2)	Indicative rated operational current values at:						
	110 - 120 V	200 V	208 V	220 - 240 V	380 - 415 V	440 - 480 V	550 - 600 V
hp	A	A	A	A	A	A	A
1/2	4.4	2.5	2.4	2.2	1.3	1.1	0.9
3/4	6.4	3.7	3.5	3.2	1.8	1.6	1.3
1	8.4	4.8	4.6	4.2	2.3	2.1	1.7
1 1/2	12	6.9	6.6	6	3.3	3	2.4
2	13.6	7.8	7.5	6.8	4.3	3.4	2.7
3	19.2	11	10.6	9.6	6.1	4.8	3.9
5	30.4	17.5	16.7	15.2	9.7	7.6	6.1
7 1/2	44	25.3	24.2	22	14	11	9
10	56	32.2	30.8	28	18	14	11
15	84	48.3	46.2	42	27	21	17
20	108	62.1	59.4	54	34	27	22
25	136	78.2	74.8	68	44	34	27
30	160	92	88	80	51	40	32
40	208	120	114	104	66	52	41
50	260	150	143	130	83	65	52
60	–	177	169	154	103	77	62
75	–	221	211	192	128	96	77
100	–	285	273	248	165	124	99
125	–	359	343	312	208	156	125
150	–	414	396	360	240	180	144
200	–	552	528	480	320	240	192
250	–	–	–	604	403	302	242
300	–	–	–	722	482	361	289
350	–	–	–	828	560	414	336
400	–	–	–	954	636	477	382
450	–	–	–	1030	–	515	412
500	–	–	–	1180	786	590	472

(1) Values conforming to standard IEC 60072-1 (at 50 Hz).

(2) Values conforming to standard UL 508 (at 60 Hz).

Nota : These values are given as a guide. They may vary depending on the type of motor, its polarity and the manufacturer.

Applications	Equipment based on standard contactors					Equipment requiring low consumption contactors which can be switched directly from solid state outputs	
							
Rated operational current AC-3 AC-1	6 A 12 A	6...0.16 A 20 A	9...150 A 25...200 A	115...800 A 200...2100 A	750...1800 A 800...2750 A	6...12 A 20 A	9...25 A 20...40 A
Rated operational voltage	690 V	690 V	690 V	1000 V	1000 V	690 V	690 V
Number of poles	2 or 3	3 or 4	3 or 4	2, 3 or 4	1...4	3 or 4	3
Contactor type references	LC1 SK LP1 SK	LC1 K LC7 K LP1 K	LC1 D	LC1 F	LC1 B	LP4 K	LC1 D
Pages	5/8 and 5/9		5/46 and 5/47	5/104 and 5/105		5/15	5/48 and 5/49

5

Equipment requiring magnetic latching contactors

Motors, resistive circuits, rotor short-circuiting devices, electro lifting magnets, hoisting, mines, $\overline{\text{---}}$ motors, high operating rates. Variable composition bar mounted contactors.

Induction heating, heating of metal or of a metal part in a channel or crucible furnace by induction of a. c. currents. Contactors for induction heating applications.

Applications conforming to "NATO" specifications and references. Shockproof contactors



150...1800 A	80...1800 A	–	12...630 A
250...2750 A	80...2750 A	80...16 300 A	25...850 A
1000 V	\sim 1000 V $\overline{\text{---}}$ 440 or 1500 V	3000 V	690 V or 1000 V
1...4	1...6	1...8	3 or 4
CR1 F CR1 B	CV●	CE● CS●	LC1 D●G LP1 D●G LC1 FG●●●
5/250 to 5/259	5/226 and 5/227	Please consult your Regional Sales Office	

5

Applications

Simple automation systems



Rated operational current	le max AC-3 (Ue ≤ 440 V)
	le AC-1 (θ ≤ 40 °C)

6 A
12 A

6 A
–

Rated operational voltage

690 V

Number of poles

2 or 3

3

Rated operational power in category AC-3	220/240 V
	380/400 V
	415/440 V
	500 V
	660/690 V
	1000 V

1.1 kW
2.2 kW
2.2 kW
–
–
–

1.5 kW
2.2 kW
2.2/3 kW
3 kW
3 kW
–

Add-on auxiliary contact blocks	Front
	Side
	Front time delay
	Front dust and damp protected

Up to 2 N/C or N/O
–
–
–

Up to 4 N/C or N/O
–
1 N/C
–

Associated manual-auto thermal overload relays	Class 10 A
	Class 20 A

–
–

0.11...16 A
–

Suppressor modules

Varistor or diode

Varistor, diode + Zener diode or RC circuit

Contactors type references	~
	≡

LC1 SK
LP1 SK

LC1 or LC7 K06
LP1 K06

Reversing contactor with mechanical interlock type references	~
	≡

–
–

LC2 or LC8 K06
LP2 K06

Pages	Contactors
	Reversing contactors

5/34 and 5/35
–

5/14 to 5/17
5/18 to 5/21

5



9 A
20 A

12 A
–

16 A
–

3 or 4

2.2 kW
4 kW
4 kW
4 kW
4 kW
–

3 kW
5.5 kW
5.5 kW
4 kW
4 kW
–

3 kW
7.5 kW
7.5 kW
5.5 kW
4 kW
–

5

LC1 or LC7 K09
LP1 K09

LC1 or LC7 K12
LP1 K12

LC1 K16
–

LC2 or LC8 K09
LP2 K09

LC2 or LC8 K12
LP2 K12

LC2 K16
–

Environment characteristics

Conforming to standards			IEC 60947, NF C 63-110, VDE 0660, BS 5424		
Product certifications	LC● and LP● K06 to K12		UL, CSA		
Operating positions			<p>Without derating Without derating Possible positions for LC● K only. Contactor pull-in voltage: 0.85 U_c</p>		
Connection			Min.	Max.	Max. to IEC 60947
Screw clamp terminals	Solid conductor	mm ²	1 x 1.5	2 x 4	1 x 4 + 1 x 2.5
	Flexible conductor without cable end	mm ²	1 x 0.75	2 x 4	2 x 2.5
	Flexible conductor with cable end	mm ²	1 x 0.34	1 x 1.5 + 1 x 2.5	1 x 1.5 + 1 x 2.5
Spring terminals	Solid conductor	mm ²	1 x 0.75	1 x 1.5	2 x 1.5
	Flexible conductor without cable end	mm ²	1 x 0.75	1 x 1.5	2 x 1.5
Faston connectors	Clip	mm	2 x 2.8 or 1 x 6.35		
Solder pins for printed circuit board	With locating device between power and control circuits		4 mm x 35 microns		
Tightening torque	Philips head n° 2 and Ø 6	N.m	0.8		
Terminal referencing	Conforming to standards EN 50005 and EN 50012		Up to 5 contacts, depending on model		
Rated insulation voltage (U_i)	Conforming to IEC 60947	V	690		
	Conforming to VDE 0110 gr C	V	750		
	Conforming to BS 5424, NF C 20-040	V	690		
	Conforming to CSA 22-2 n° 14, UL 508	V	600		
Rated impulse withstand voltage (U_{imp})		kV	8		
Protective treatment	Conforming to IEC 60068 (DIN 50016)		"TC" (Klimafest, Climateproof)		
Degree of protection	Conforming to VDE 0106		Protection against direct finger contact		
Ambient air temperature around the device	Storage	°C	- 50...+ 80		
	Operation	°C	- 25...+ 50		
Maximum operating altitude	Without derating	m	2000		
Vibration resistance 5 ... 300 Hz	Contacteur open		2 gn		
	Contacteur closed		4 gn		
Flame resistance	Conforming to UL 94		Self-extinguishing materials V1		
	Conforming to NF F 16-101 and 16-102		Conforming to requirement 2		
Shock resistance (1/2 sine wave, 11 ms)	Contacteur open		On X axis: 6 gn On Y and Z axes: 10 gn		
	Contacteur closed		On X axis: 10 gn On Y and Z axes: 15 gn		
Safe separation of circuits	Conforming to VDE 0106 and IEC 60536		SELV (Safety Extra Low Voltage), up to 400 V		

Pole characteristics							
Type	LC● or LP●		K06	K09	K12	K16	
Conventional thermal current (I _{th})	For ambient temperature ≤ 50 °C	A	20				
Rated operational frequency		Hz	50/60				
Frequency limits of the operational current		Hz	Up to 400				
Rated operational voltage (U _e)		V	690				
Rated making capacity	I rms conforming to NF C 63 110 and IEC 60947	A	110	110	144	160	
Rated breaking capacity	I rms conforming to NF C 63 110 and IEC 60947	220/230 V	A	110	110	–	–
		380/400 V	A	110	110	–	–
		415 V	A	110	110	–	–
		440 V	A	110	110	110	110
		500 V	A	80	80	80	80
		660/690 V	A	70	70	70	70
Permissible short time rating	In free air for a time "t" from cold state (θ ≤ 50 °C)	1 s	A	90	90	115	115
		5 s	A	85	85	105	105
		10 s	A	80	80	100	100
		30 s	A	60	60	75	75
		1 min	A	45	45	55	55
		3 min	A	40	40	50	50
		≥ 15 min	A	20	20	25	25
Short-circuit protection	gG fuse U ≤ 440 V (aM fuse, see page 6/12)	A	25				
Average impedance per pole	At I _{th} and 50 Hz	mΩ	3				
Use in category AC-1 resistive circuits, heating, lighting (U _e ≤ 440 V)	Maximum rated operational current for a temperature ≤ 50 °C	A	20				
		A	16 for U _e only				
	Rated operational current limits in relation to the on-load factor and operating frequency	On-load factor		90 %	60 %	30 %	
		A	300 operating cycles/hour	13	15	18	
		A	120 operating cycles/hour	15	18	19	
	A	30 operating cycles/hour	19	20	20		
Increase in rated operational current by paralleling of poles	Apply the following coefficients to the above currents; these coefficients take into account an often unbalanced distribution of current between the poles						
	2 poles in parallel: K = 1.60						
	3 poles in parallel: K = 2.25						
	4 poles in parallel: K = 2.80						
Use in category AC-3 squirrel cage motors	Operational power according to the voltage. Voltage 50 or 60 Hz	115 V single-ph.	kW	0.37	0.55	–	–
		220 V single-ph.	kW	0.75	1.1	–	–
		220/230 V 3-ph.	kW	1.5	2.2	3	4
		380/415 V 3-ph.	kW	2.2	4	5.5	7.5
		440/480 V 3-ph.	kW	3	4	5.5/4 (480)	5.5/4 (480)
		500/600 V 3-ph.	kW	3	4	4	4
		660/690 V 3-ph.	kW	3	4	4	4
		Maximum operating rate (in operating cycles/hour in relation to % of rated power)		Op. cycles/h	600	900	1200
			Power	100 %	75 %	50 %	

Control circuit characteristics										
Type		LC1	LC2	LC7	LC8	LP1	LP2	LP4	LP5	
Rated control circuit voltage (Uc)	V	~ 12...690 (1)		~ 24...240 (1)		~ 12...250 (1)		~ 12...120		
Control voltage limits (≤ 50 °C) single voltage coil	Operation	0.8...1.15 Uc (2)		0.85...1.1 Uc		0.8...1.15 Uc		0.7...1.30 Uc		
	Drop-out	≥ 0.20 Uc		≥ 0.10 Uc		≥ 0.10 Uc		≥ 0.10 Uc		
Average consumption at 20 °C and at Uc	Inrush	30 VA		3 VA		3 W		1.8 W		
	Sealed	4.5 VA		3 VA		3 W		1.8 W		
Heat dissipation	W	1.3		3		3		1.8		
Operating time at 20 °C and at Uc	Between coil energisation and:									
	- opening of the N/C contacts	ms	5...15		25...35		25...35		25...35	
	- closing of the N/O contacts	ms	10...20		30...40		30...40		30...40	
	Between coil de-energisation and:									
- opening of the N/O contacts	ms	10...20		30		10		10...20		
- closing of the N/C contacts	ms	15...25		40		15		15...25		
Maximum immunity to microbreaks	ms	2		2		2		2		
Maximum operating rate	In operating cycles per hour	3600		3600		3600		3600		
Mechanical durability at Uc In millions of operating cycles	50/60 Hz coil	10	5	10	5	-	-	-	-	
	~ coil	-	-	-	-	10	5	-	-	
	Wide range coil, Low consumption	-	-	-	-	-	-	30	5	

(1) For mains supplies with a high level of interference (voltage surge > 800 V), use a suppressor module LA4 KE1FC (50...129 V) or LA4 KE1UG (130...250 V), see page 5/24.

(2) LC1 K16: 0.85...1.15 Uc.

Auxiliary contact characteristics of contactors and instantaneous contact blocks

Number of auxiliary contacts	On LC● K or LP● K 3-pole		1	
	On LA1 K		2 or 4	
Rated operational voltage (Ue) Up to		V	690	
Rated insulation voltage (Ui)	Conforming to BS 5424	V	690	
	Conforming to IEC 60947	V	690	
	Conforming to VDE 0110 group C	V	750	
	Conforming to CSA C 22-2 n° 14	V	600	
Conventional thermal current (Ith)	For ambient temperature ≤ 50 °C	A	10	
Frequency of the operational current		Hz	Up to 400	
Minimum switching capacity	U min (DIN 19 240)	V	17	
	I min	mA	5	
Short-circuit protection	Conforming to IEC 60947 and VDE 0660, gG fuse	A	10	
Rated making capacity	Conforming to IEC 60947 I rms	A	110	
Short-time rating	Permissible for	1 s	A	80
		500 ms	A	90
		100 ms	A	110
Insulation resistance		MΩ	> 10	
Non-overlap distance	LA1 K: linked contacts conforming to INRS, BIA and CNA specifications	mm	0.5 (see schemes pages 5/27 and 5/29)	

Operational power of contacts conforming to IEC 60947

a.c. supply, category AC-15

Electrical durability (valid for up to 3600 operating cycles/hour) on an inductive load such as the coil of an electromagnet: making current (cos φ 0.7) = 10 times the power broken (cos φ 0.4).

V	24	48	110/127	220/230	380/400	440	600/690
VA	48	96	240	440	800	880	1200
VA	17	34	86	158	288	317	500
VA	7	14	36	66	120	132	200
VA	1000	2050	5000	10 000	14 000	13 000	9000

1 million operating cycles
3 million operating cycles
10 million operating cycles
Occasional making capacity

d.c. supply, category DC-13

Electrical durability (valid for up to 1200 operating cycles/hour) on an inductive load such as the coil of an electromagnet, without economy resistor, the time constant increasing with the load.

V	24	48	110	220	440	600
W	120	80	60	52	51	50
W	55	38	30	28	26	25
W	15	11	9	8	7	6
W	720	600	400	300	230	200

Power broken in VA

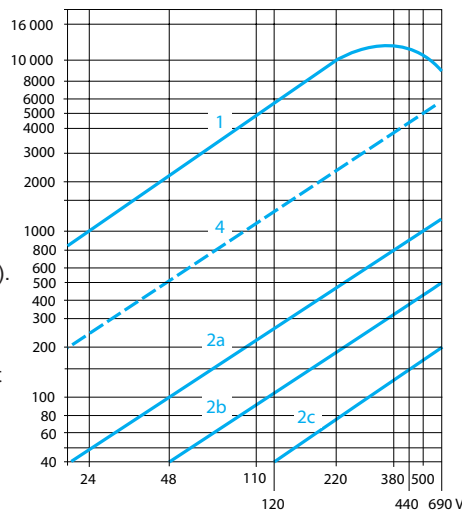

Power broken in W

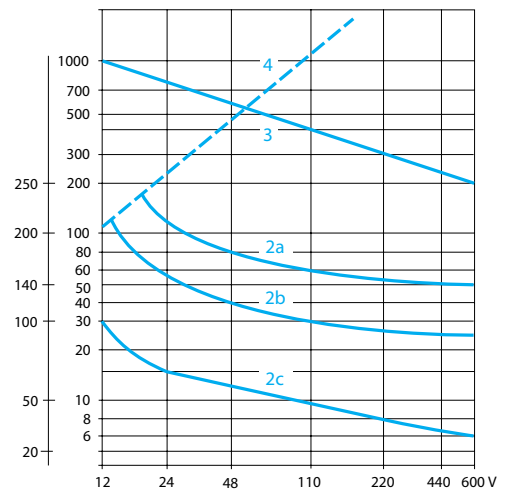

1 Breaking limit of contacts valid for:
- maximum of 50 operating cycles at 10 s intervals (power broken = making current x cos φ 0.7).

2 Electrical durability of contacts for:
- 1 million operating cycles (2a)
- 3 million operating cycles (2b)
- 10 million operating cycles (2c).

3 Breaking limit of contacts valid for:
- maximum of 20 operating cycles at 10 s intervals with current passing for 0.5 s per operating cycle.

4 Thermal limit.



TeSys contactors

Contactors for motor control,
6 to 16 A in category AC-3 and 6 to 12 A
in category AC-4

Control circuit: a.c.



LC1 K0910●●



LC1 K09103●●



LC1 K09107●●



LC1 K09105●●



LC7 K0910●●

Contactor selection according to utilisation category, see pages 5/194 to 5/197 and 5/200 to 5/203.

Mounting on 35 mm rail or Ø 4 screw fixing.

Screws in the open "ready-to-tighten" position.

Add-on auxiliary contact blocks and accessories, see pages 5/22 to 5/25.

3-pole contactors for standard applications

Standard power ratings of 3-phase motors 50-60 Hz in category AC-3				Rated operational current in category AC-3 440 V up to	Instantaneous auxiliary contacts	Basic reference, to be completed by adding the voltage code (1) (2)	Weight
220 V	380 V	440/500 V	230 V				
kW	kW	kW	A				kg
Screw clamp connections							
1.5	2.2	3	6	1	–	LC1 K0610●●	0.180
				–	1	LC1 K0601●●	0.180
2.2	4	4	9	1	–	LC1 K0910●●	0.180
				–	1	LC1 K0901●●	0.180
3	5.5	4 (> 440)	12	1	–	LC1 K1210●●	0.180
		5.5 (440)		–	1	LC1 K1201●●	0.180
4	7.5	4 (> 440)	16	1	–	LC1 K1610●●	0.180
		5.5 (440)		–	1	LC1 K1601●●	0.180

Spring terminal connections

For 6 to 12 A ratings only, in the references selected above, insert a figure 3 before the voltage code.

Example: LC1 K0610●● becomes LC1 K06103●●.

Faston connectors, 1 x 6.35 or 2 x 2.8

For 6 to 16 A ratings, in the references selected above, insert a figure 7 before the voltage code.

Example: LC1 K0610●● becomes LC1 K06107●●.

Solder pins for printed circuit boards

For 6 to 16 A ratings, in the references selected above, insert a figure 5 before the voltage code.

Example: LC1 K0610●● becomes LC1 K06105●●.

3-pole silent contactors

Recommended for use in areas sensitive to noise, high interference mains supplies, etc.

Coil with rectifier incorporated, suppressor fitted as standard.

Screw clamp connections

1.5	2.2	3	6	1	–	LC7 K0610●●	0.225
				–	1	LC7 K0601●●	0.225
2.2	4	4	9	1	–	LC7 K0910●●	0.225
				–	1	LC7 K0901●●	0.225
3	5.5	4 (> 440)	12	1	–	LC7 K1210●●	0.225
		5.5 (440)		–	1	LC7 K1201●●	0.225

Faston connectors, 1 x 6.35 or 2 x 2.8

In the references selected above, insert a figure 7 before the voltage code.

Example: LC7 K0610●● becomes LC7 K06107●●.

Solder pins for printed circuit boards

In the references selected above, insert a figure 5 before the voltage code.

Example: LC7 K0610●● becomes LC7 K06105●●.

(1) Standard control circuit voltages (for other voltages, please consult your Regional Sales Office):

a.c. supply

Contactors LC1 K (0.8...1.15 Uc) (0.85...1.1 Uc)

Volts	12	20	24 (2)	36	42	48	110	115	120	127	200/208	220/230	230	230/240
50/60 Hz	J7	Z7	B7	C7	D7	E7	F7	FE7	G7	FC7	L7	M7	P7	U7
Volts	256	277	380/400	400	400/415	440	480	500	575	600	660/690			
50/60 Hz	W7	UE7	Q7	–	V7	N7	R7	T7	S7	SC7	X7	Y7	–	–

Up to and including 240 V, coil with integral suppression device available: add 2 to the code required. Example: J72.

Contactors LC7 K (0.85...1.1 Uc)

Volts	24	42	48	110	115	220	230/240
50/60 Hz	B7	D7	E7	F7	FE7	M7	U7

(2) For mains supplies with a high level of interference (voltage surge > 800 V), use a suppressor module LA4 KE1FC (50...129 V) or LA4 KE1UG (130...250 V), see page 5/24

TeSys contactors

Contactors for motor control,
6 to 12 A in categories AC-3 and AC-4
Control circuit: d.c. or low consumption



LP1 K0910●●



LP1 K09103●●



LP1 K09107●●



LP1 K09105●●



LP4 K0910●●

Contactors selection according to utilisation category, see pages 5/194 to 5/197 and 5/200 to 5/203.
Mounting on 35 mm rail or Ø 4 screw fixing.
Screws in the open "ready-to-tighten" position.
Add-on auxiliary contact blocks and accessories, see pages 5/22 to 5/25

3-pole contactors, d.c. supply

Standard power ratings of 3-phase motors 50-60 Hz in category AC-3				Rated operational current in category AC-3 440 V up to	Instan- taneous auxiliary contacts 	Basic reference, to be completed by adding the voltage code (1) (2)	Weight
220 V	380 V	440/500 V	660/690 V				
kW	kW	kW	A				kg
Screw clamp connections							
1.5	2.2	3	6	1	–	LP1 K0610●●	0.225
				–	1	LP1 K0601●●	0.225
2.2	4	4	9	1	–	LP1 K0910●●	0.225
				–	1	LP1 K0901●●	0.225
3	5.5	4 (> 440)	12	1	–	LP1 K1210●●	0.225
		5.5 (440)		–	1	LP1 K1201●●	0.225

Spring terminal connections

In the references selected above, insert a figure 3 before the voltage code.
Example: LP1 K0610●● becomes LP1 K06103●●.

Faston connectors, 1 x 6.35 or 2 x 2.8

In the references selected above, insert a figure 7 before the voltage code.
Example: LP1 K0610●● becomes LP1 K06107●●.

Solder pins for printed circuit boards

In the references selected above, insert a figure 5 before the voltage code.
Example: LP1 K0610●● becomes LP1 K06105●●.

3-pole low consumption contactors

Compatible with programmable controller outputs.
LED indicator incorporated (except models LP4 K●●●FW3 and LP4 K●●●GW3).
Wide range coil (0.7...1.30 Uc), suppressor fitted as standard, consumption 1.8 W.

Screw clamp connections							
1.5	2.2	3	6	1	–		0.235
				–	1	LP4 K0601●●	0.235
2.2	4	4	9	1	–	LP4 K0910●●	0.235
				–	1	LP4 K0901●●	0.235
3	5.5	4 (> 440)	12	1	–	LP4 K1210●●	0.235
		5.5 (440)		–	1	LP4 K1201●●	0.235

Spring terminal connections

In the references selected above, insert a figure 3 before the voltage code.
Example: LP4 K0610●● becomes LP4 K06103●●.

Faston connectors, 1 x 6.35 or 2 x 2.8

In the references selected above, insert a figure 7 before the voltage code.
Example: LP4 K0610●● becomes LP4 K06107●●.

Solder pins for printed circuit boards

In the references selected above, insert a figure 5 before the voltage code.
Example: LP4 K0610●● becomes LP4 K06105●●.

(1) Standard control circuit voltages (for other voltages, please consult your Regional Sales Office):

d.c. supply (contactors LP1 K: 0.8*1.15 Uc)																	
Volts	12	20	24 (2)	36	48	60	72	100	110	125	155	174	200	220	230	240	250
Code	JD	ZD	BD	CD	ED	ND	SD	KD	FD	GD	PD	QD	LD	MD	MPD	MUD	UD

Coil with integral suppression device available: add 3 to the code required. Example: JD3

Low consumption (contactors LP4 K: 0.7*130 Uc)

Volts	12	20	24	48	72	110	120
Code	JW3	ZW3	BW3	EW3	SW3	FW3	GW3

(2) For LP1 K only, when connecting an electronic sensor or timer in series with the contactor coil, select a 20 V coil (~ control circuit voltage code Z7, --- control circuit voltage code ZD) so as to compensate for the incurred voltage drop.

TeSys contactors

Contactors for control in category AC-1, 20 A
Control circuit: a.c.

Contactor selection according to utilisation category, see pages 5/198 and 5/199.

Mounting on 35 mm rail or Ø 4 screw fixing.

Screws in the open "ready-to-tighten" position.

Add-on auxiliary contact blocks and accessories, see pages 5/22 to 5/25.



LC1 K09004●●



LC1 K09103●●



LC1 K09107●●



LC1 K09004●●

3 or 4-pole contactors for standard applications (1)

Non-inductive loads Category AC-1 Maximum current at $\theta \leq 50^\circ\text{C}$	Number of poles	Instantaneous auxiliary contacts	Basic reference, to be completed by adding the voltage code (2) (3)	Weight		
Screw clamp connections				kg		
20	3	-	1	LC1 K0910●●	0.180	
				or LC1 K1210●●	0.180	
	3	-	-	1	LC1 K0901●●	0.180
				or LC1 K1201●●	0.180	
	4	-	-	-	LC1 K09004●●	0.180
				or LC1 K12004●●	0.180	
	2	2	-	-	LC1 K09008●●	0.180

Spring terminal connections

In the references selected above, insert a figure 3 before the voltage code.

Example: LC1 K0910●● becomes LC1 K09103●●.

Faston connectors, 1 x 6.35 or 2 x 2.8

In the references selected above, insert a figure 7 before the voltage code.

Example: LC1 K0910●● becomes LC1 K09107●●.

Solder pins for printed circuit boards

In the references selected above, insert a figure 5 before the voltage code.

Example: LC1 K0910●● becomes LC1 K09105●●.

3 or 4-pole silent contactors (1)

Recommended for use in areas sensitive to noise, high interference mains supplies, etc.

Coil with rectifier incorporated, suppressor fitted as standard.

Screw clamp connections

20	3	-	1	-	LC7 K0910●●	0.225
					or LC7 K1210●●	0.225
	3	-	-	1	LC7 K0901●●	0.225
					or LC7 K1201●●	0.225
	4	-	-	-	LC7 K09004●●	0.225
					or LC7 K12004●●	0.225
	2	2	-	-	LC7 K09008●●	0.225

Faston connectors, 1 x 6.35 or 2 x 2.8

In the references selected above, insert a figure 7 before the voltage code.

Example: LC7 K0910●● becomes LC7 K09107●●.

Solder pins for printed circuit boards

In the references selected above, insert a figure 5 before the voltage code.

Example: LC7 K0910●● becomes LC7 K09105●●.

(1) Selection between 9 and 12 A ratings according to number of operating cycles, see AC-1 curve on page 5/198.

(2) Standard control circuit voltages (for other voltages, please consult your Regional Sales Office):

a.c. supply

Contactors LC1 K (0.8...1.15 Uc) (0.85...1.1 Uc)

Volts	12	20	24 (3)	36	42	48	110	115	120	127	200/208	220/230	230	230/240
50/60 Hz	J7	Z7	B7	C7	D7	E7	F7	FE7	G7	FC7	L7	M7	P7	U7
Volts	256	277	380/400	400	400/415	440	480	500	575	600	660/690			
50/60 Hz	W7	UE7	Q7		V7	N7		R7	T7	S7	SC7	X7	Y7	

Up to and including 240 V, coil with integral suppression device available: add 2 to the code required. Example: J72.

Contactors LC7 K (0.8...1.1 Uc)

Volts	24	42	48	110	115	220	230/240
50/60 Hz	B7	D7	E7	F7	FE7	M7	U7

(3) For mains supplies with a high level of interference (voltage surge > 800 V), use a suppressor module LA4 KE1FC (50...129 V) or LA4 KE1UG (130...250 V), see page 5/24.

TeSys contactors

Contactors for control in category AC-1, 20 A
Control circuit: d.c. or low consumption

Contactor selection according to utilisation category, see pages 5/198 and 5/199.
Mounting on 35 mm rail or Ø 4 screw fixing.
Screws in the open "ready-to-tighten" position.
Add-on auxiliary contact blocks and accessories, see pages 5/22 to 5/25.



LC1 K09004●●



LC1 K09103●●



LC1 K09105●●



LC1 K09004●●

3 and 4-pole contactors, d.c. supply (1)						
Non-inductive loads Category AC-1 Maximum current at $\theta \leq 50^\circ\text{C}$	Number of poles		Instantaneous auxiliary contacts		Basic reference, to be completed by adding the voltage code (2) (3)	Weight
A						kg
Screw clamp connections						
20	3	–	1	–	LP1 K0910●● or LP1 K1210●●	0.225 0.225
	3	–	–	1	LP1 K0901●● or LP1 K1201●●	0.225 0.225
	4	–	–	–	LP1 K09004●● or LP1 K12004●●	0.225 0.225
	2	2	–	–	LP1 K09008●●	0.225

Spring terminal connections

In the references selected above, insert a figure 3 before the voltage code.
Example: LP1 K0910●● becomes LP1 K09103●●.

Faston connectors, 1 x 6.35 or 2 x 2.8

In the references selected above, insert a figure 7 before the voltage code.
Example: LP1 K0910●● becomes LP1 K09107●●.

Solder pins for printed circuit boards

In the references selected above, insert a figure 5 before the voltage code.
Example: LP1 K0910●● becomes LP1 K09105●●.

3 or 4-pole low consumption contactors (1)

Compatible with programmable controller outputs.
LED indicator incorporated (except models LP4 K●●●●FW3 and LP4 K●●●●GW3).
Wide range coil (0.7...1.30 Uc), suppressor fitted as standard, consumption 1.8 W.

Screw clamp connections						
20	3	–	1	–	LP4 K0910●●●● or LP4 K1210●●●●	0.235 0.235
	3	–	–	1	LP4 K0901●●●● or LP4 K1201●●●●	0.235 0.235
	4	–	–	–	LP4 K09004●●●● or LP4 K12004●●●●	0.235 0.235
	2	2	–	–	LP4 K09008●●●●	0.235

Spring terminal connections

In the references selected above, insert a figure 3 before the voltage code.
Example: LP4 K0910●● becomes LP4 K09103●●.

Faston connectors, 1 x 6.35 or 2 x 2.8

In the references selected above, insert a figure 7 before the voltage code.
Example: LP4 K0910●● becomes LP4 K09107●●.

Solder pins for printed circuit boards

In the references selected above, insert a figure 5 before the voltage code.
Example: LP4 K0910●● becomes LP4 K09105●●.

(1) Selection between 9 and 12 A ratings according to number of operating cycles, see AC-1 curve on page 5/198.
(2) Standard control circuit voltages (for other voltages, please consult your Regional Sales Office):

d.c. supply (contactors LP1 K: 0.8*1.15 Uc)																	
Volts ---	12	20	24 (3)	36	48	60	72	100	110	125	155	174	200	220	230	240	250
Code	JD	ZD	BD	CD	ED	ND	SD	KD	FD	GD	PD	QD	LD	MD	MPD	MUD	UD

Coil with integral suppression device available: add 3 to the code required. Example: JD3.

Low consumption (contactors LP4 K: 0.7*130 Uc)

Volts ---	12	20	24	48	72	110	120
Code	JW3	ZW3	BW3	EW3	SW3	FW3	GW3

(3) For LP1 K only, when connecting an electronic sensor or timer in series with the contactor coil, select a 20 V coil (~ control circuit voltage code Z7, --- control circuit voltage code ZD) so as to compensate for the incurred voltage drop.



TeSys contactors

Reversing contactors for motor control, 6 to 16 A in category AC-3 and 6 to 12 A in category AC-4
Control circuit: a.c.

Reversing contactor selection according to utilisation category, see pages 5/194 to 5/197 and 5/200 to 5/203. Integral mechanical interlock.

It is essential to link the contacts of the electrical interlock.

Pre-wired power circuit connections as standard on screw clamp versions.

Mounting on 35 mm rail or Ø 4 screw fixing. Screws in the open "ready-to-tighten" position.

Add-on auxiliary contact blocks and accessories, see pages 5/22 to 5/25.

5/1147

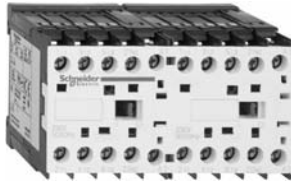

LC2 K0910●●

5/1148



LC2 K09105●●

3-pole reversing contactors for standard applications

Standard power ratings of 3-phase motors 50/60 Hz in category AC-3			Rated operational current in category AC-3 440V up to	Instantaneous auxiliary contacts per contactor	Basic reference, to be completed by adding the voltage code (1) (2)		Weight
220 V	380 V	440/500 V					
230 V	415 V	660/690 V					
kW	kW	kW	A				kg
Screw clamp connections							
1.5	2.2	3	6	1 –	LC2 K0610●●		0.390
				– 1	LC2 K0601●●		0.390
2.2	4	4	9	1 –	LC2 K0910●●		0.390
				– 1	LC2 K0901●●		0.390
3	5.5	4 (> 440)	12	1 –	LC2 K1210●●		0.390
		5.5 (440)		– 1	LC2 K1201●●		0.390
4	7.5	4 (> 440)	16	1 –	LC2 K1610●●		0.390
		5.5 (440)		– 1	LC2 K1601●●		0.390

Spring terminal connections

For 6 to 12 A ratings only, in the references selected above, insert a figure 3 before the voltage code.

Example: LC2 K0610●● becomes LC2 K06103●●.

Faston connectors, 1 x 6.35 or 2 x 2.8

For 6 to 16 A ratings, in the references selected above, insert a figure 7 before the voltage code.

Example: LC2 K0610●● becomes LC2 K06107●●.

Solder pins for printed circuit boards

For 6 to 16 A ratings, in the references selected above, insert a figure 5 before the voltage code.

Example: LC2 K0610●● becomes LC2 K06105●●.

3-pole silent reversing contactors

Recommended for use in areas sensitive to noise, high interference mains supplies, etc.

Coil with rectifier incorporated, suppressor fitted as standard.

Screw clamp connections

1.5	2.2	3	6	1 –	LC8 K0610●●	0.480
				– 1	LC8 K0601●●	0.480
2.2	4	4	9	1 –	LC8 K0910●●	0.480
				– 1	LC8 K0901●●	0.480
3	5.5	4 (> 440)	12	1 –	LC8 K1210●●	0.480
		5.5 (440)		– 1	LC8 K1201●●	0.480

Faston connectors, 1 x 6.35 or 2 x 2.8

In the references selected above, insert a figure 7 before the voltage code.

Example: LC8 K0610●● becomes LC8 K06107●●.

Solder pins for printed circuit boards

In the references selected above, insert a figure 5 before the voltage code.

Example: LC8 K0610●● becomes LC8 K06105●●.

(1) Standard control circuit voltages (for other voltages, please consult your Regional Sales Office):

a.c. supply

Reversing contactors LC2 K (0.8...1.15 Uc) (0.85...1.1 Uc)

Volts	12	20	24 (2)	36	42	48	110	115	120	127	200/208	220/230	230	230/240
50/60 Hz	J7	Z7	B7	C7	D7	E7	F7	FE7	G7	FC7	L7	M7	P7	U7
Volts	256	277	380/400	400	400/415	440	480	500	575	600	660/690			
50/60 Hz	W7	UE7	Q7		V7	N7		R7	T7	S7	SC7	X7	Y7	

Up to and including 240 V, coil with integral suppression device available: add 2 to the code required. Example: J72

Reversing contactors LC8 K (0.8...1.1 Uc)

Volts	24	42	48	110	115	220	230/240	
50/60 Hz	B7		D7	E7	F7	FE7	M7	U7

(2) For mains supplies with a high level of interference (voltage surge > 800 V), use a suppressor module LA4 KE1FC (50...129 V) or LA4 KE1UG (130...250 V), see page 5/24.

TeSys contactors

Reversing contactors for motor control, 6 to 12 A in categories AC-3 and AC-4

Control circuit: d.c. or low consumption

Reversing contactor selection according to utilisation category, see pages 5/194 to 5/197 and 5/200 to 5/203. Integral mechanical interlock.

It is essential to link the contacts of the electrical interlock.

Pre-wired power circuit connections as standard on screw clamp versions.

Mounting on 35 mm U_T rail or \varnothing 4 screw fixing.

Screws in the open "ready-to-tighten" position.

Add-on auxiliary contact blocks and accessories, see pages 5/22 to 5/25

3-pole reversing contactors, d.c. supply						Weight
Standard power ratings of 3-phase motors 50-60 Hz in category AC-3			Rated operational current in category AC-3 440V up to	Instan- taneous auxiliary contacts per contactor	Basic reference, to be completed by adding the voltage code (1) (2)	
220 V	380 V	440/500 V				A
230 V	415 V	660/690 V				
kW	kW	kW				
Screw clamp connections						
1.5	2.2	3	6	1 –	LP2 K0610●●	0.480
				– 1	LP2 K0601●●	0.480
2.2	4	4	9	1 –	LP2 K0910●●	0.480
				– 1	LP2 K0901●●	0.480
3	5.5	4 (> 440)	12	1 –	LP2 K1210●●	0.480
		5.5 (440)		– 1	LP2 K1201●●	0.480

Spring terminal connections

In the references selected above, insert a figure 3 before the voltage code.

Example: LP2 K0610●● becomes LP2 K06103●●.

Faston connectors, 1 x 6.35 or 2 x 2.8

In the references selected above, insert a figure 7 before the voltage code.

Example: LC2 K0610●● becomes LC2 K06107●●.

Solder pins for printed circuit boards

For 6 to 16 A ratings, in the references selected above, insert a figure 5 before the voltage code.

Example: LC2 K0610●● becomes LC2 K06105●●.

3-pole low consumption reversing contactors

Compatible with programmable controller outputs.

LED indicator incorporated (except models LP5-K●●●●FW3 and LP5-K●●●●GW3).

Wide range coil (0.7...1.30 Uc), suppressor fitted as standard, consumption 1.8 W.

Screw clamp connections						
1.5	2.2	3	6	1 –	LP5 K0610●●	0.490
				– 1	LP5 K0601●●	0.490
2.2	4	4	9	1 –	LP5 K0910●●	0.490
				– 1	LP5 K0901●●	0.490
3	5.5	4 (> 440)	12	1 –	LP5 K1210●●	0.490
		5.5 (440)		– 1	LP5 K1201●●	0.490

Spring terminal connections

In the references selected above, insert a figure 3 before the voltage code.

Example: LP5 K0610●● becomes LP5 K06103●●.

Faston connectors, 1 x 6.35 or 2 x 2.8

In the references selected above, insert a figure 7 before the voltage code.

Example: LP5 K0610●● becomes LP5 K06107●●.

Solder pins for printed circuit boards

In the references selected above, insert a figure 5 before the voltage code.

Example: LP5 K0610●● becomes LP5 K06105●●.

(1) Standard control circuit voltages (for other voltages, please consult your Regional Sales Office):

d.c. supply

Reversing contactors LP2 K (0.8...1.15 Uc)

Volts	12	20	24 (3)	36	48	60	72	100	110	125	155	174	200	220	230	240	250
Code	JD	ZD	BD	CD	ED	ND	SD	KD	FD	GD	PD	QD	LD	MD	MPD	MUD	UD

Coil with integral suppression device available: add 3 to the code required. Example: JD3.

Low consumption

Reversing contactors LP5 K (0.7...1.30 Uc)

Volts	12	20	24	48	72	110	120
Code	JW3	ZW3	BW3	EW3	SW3	FW3	GW3

(2) For LP2 K only, when connecting an electronic sensor or timer in series with the contactor coil, select a 20 V coil (\sim control circuit voltage code Z7, --- control circuit voltage code ZD) so as to compensate for the incurred voltage drop.

TeSys contactors

Reversing contactors for control
in category AC-1, 20 A
Control circuit: a.c.

Warning: reversing contactors LC2 K0910●● and LC2 K0901●● are pre-wired for reverse motor operation as standard.
Reversing contactor selection according to utilisation category, see pages 5/198 and 5/199.
Integral mechanical interlock.

It is essential to link the contacts of the electrical interlock.

Mounting on 35 mm rail or Ø 4 screw fixing.

Screws in the open "ready-to-tighten" position.

Add-on auxiliary contact blocks and accessories, see pages 5/22 to 5/25.



LC2 K0910●●

3 or 4-pole reversing contactors for standard applications (1)

Non-inductive loads Category AC-1 Maximum current at $\theta \leq 50^\circ\text{C}$	Number of poles	Instantaneous auxiliary contacts per contactor	Basic reference, to be completed by adding the voltage code (2) (3)	Weight	
Screw clamp connections				kg	
20	3	-	1 -	LC2 K0910●●	0.390
			or	LC2 K1210●●	0.390
	3	-	- 1	LC2 K0901●●	0.390
			or	LC2 K1201●●	0.390
4	-	- -	LC2 K09004●●	0.380	
		or	LC2 K12004●●	0.380	

Spring terminal connections

In the references selected above, insert a figure 3 before the voltage code.

Example: LC2 K0910●● becomes LC2 K09103●●.

Faston connectors, 1 x 6.35 or 2 x 2.8

In the references selected above, insert a figure 7 before the voltage code.

Example: LC2 K0910●● becomes LC2 K09107●●.

Solder pins for printed circuit boards

In the references selected above, insert a figure 5 before the voltage code.

Example: LC2 K0910●● becomes LC2 K09105●●.



LC2 K09105●●

3 or 4-pole silent reversing contactors (1)

Recommended for use in areas sensitive to noise, high interference mains supplies, etc.

Coil with rectifier incorporated, suppressor fitted as standard.

Screw clamp connections

20	3	-	1 -	LC8 K0910●●	0.480
			or	LC8 K1210●●	0.480
	3	-	- 1	LC8 K0901●●	0.480
			or	LC8 K1201●●	0.480
4	-	- -	LC8 K09004●●	0.470	
		or	LC8 K12004●●	0.470	

Faston connectors, 1 x 6.35 or 2 x 2.8

In the references selected above, insert a figure 7 before the voltage code.

Example: LC8 K0910●● becomes LC8 K09107●●.

Solder pins for printed circuit boards

In the references selected above, insert a figure 5 before the voltage code.

Example: LC8 K0910●● becomes LC8 K09105●●.

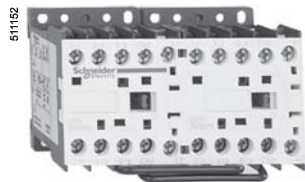

LC2 K09004●●

(1) Selection between 9 and 12 A ratings according to number of operating cycles, see AC-1 curve on page 5/198.

(2) Standard control circuit voltages (for other voltages, please consult your Regional Sales Office):

a.c. supply

Reversing contactors LC2 K (0.8...1.15 Uc) (0.85...1.1 Uc)

Volts	12	20	24 (3)	36	42	48	110	115	120	127	200/208	220/230	230	230/240
50/60 Hz	J7	Z7	B7	C7	D7	E7	F7	FE7	G7	FC7	L7	M7	P7	U7
Volts	256	277	380/400	400	400/415	440	480	500	575	600	660/690			
50/60 Hz	W7	UE7	Q7	V7	N7	R7	T7	S7	SC7	X7	Y7			

Up to and including 240 V, coil with integral suppression device available: add 2 to the code required. Example: J72.

Reversing contactors LC8 K (0.8...1.1 Uc)

Volts	24	42	48	110	115	220	230/240
50/60 Hz	B7	D7	E7	F7	FE7	M7	U7

(3) For mains supplies with a high level of interference (voltage surge > 800 V), use a suppressor module LA4 KE1FC (50...129 V) or LA4 KE1UG (130...250 V), see page 5/24.

TeSys contactors

Reversing contactors for control in category AC-1, 20 A

Control circuit: d.c. or low consumption

Warning: reversing contactors LP2 K0910●● and LP2 K0901●● are pre-wired for reverse motor operation as standard.

Reversing contactor selection according to utilisation category, see pages 5/198 and 5/199.

Integral mechanical interlock.



It is essential to link the contacts of the electrical interlock.

Mounting on 35 mm $\underline{\hspace{0.5cm}}$ rail or \varnothing 4 screw fixing.

Screws in the open "ready-to-tighten" position.

Add-on auxiliary contact blocks and accessories, see pages 5/22 to 5/25.

3 or 4-pole reversing contactors, d.c. supply (1)

Non-inductive loads Category AC-1 Maximum current at $\theta \leq 50^\circ\text{C}$	Number of poles	Instantaneous auxiliary contacts per contactor	Basic reference, to be completed by adding the voltage code (2) (3)	Weight
				
A				kg
Screw clamp connections				
20	3	–	1 –	LP2 K0910●● 0.480
				or LP2 K1210●● 0.480
	3	–	– 1	LP2 K0901●● 0.480
				or LP2 K1201●● 0.480
	4	–	– –	LP2 K09004●● 0.480
				or LP2 K12004●● 0.480

Spring terminal connections

In the references selected above, insert a figure 3 before the voltage code.

Example: LP2 K0910●● becomes LP2 K09103●●.

Faston connectors, 1 x 6.35 or 2 x 2.8

In the references selected above, insert a figure 7 before the voltage code.

Example: LP2 K0910●● becomes LP2 K09107●●.

Solder pins for printed circuit boards

In the references selected above, insert a figure 5 before the voltage code.

Example: LP2 K0910●● becomes LP2 K09105●●.

3 or 4-pole low consumption reversing contactors (1)

Compatible with programmable controller outputs.

LED indicator incorporated (except models LP5 K●●●●FW3 and LP5 K●●●●GW3).

Wide range coil (0.7...1.30 Uc), suppressor fitted as standard, consumption 1.8 W.

Screw clamp connections

20	3	–	1 –	LP5 K0910●●● 0.490
				or LP5 K1210●●● 0.490
	3	–	– 1	LP5 K0901●●● 0.490
				or LP5 K1201●●● 0.490
	4	–	– –	LP5 K09004●●● 0.490
				or LP5 K12004●●● 0.490

Spring terminal connections

In the references selected above, insert a figure 3 before the voltage code.

Example: LP5 K0910●● becomes LP5 K09103●●.

Faston connectors, 1 x 6.35 or 2 x 2.8

In the references selected above, insert a figure 7 before the voltage code.

Example: LP5 K0910●● becomes LP5 K09107●●.

Solder pins for printed circuit boards

In the references selected above, insert a figure 5 before the voltage code.

Example: LP5 K0910●● becomes LP5 K09105●●.

(1) Selection between 9 and 12 A ratings according to number of operating cycles, see AC-1 curve on page 5/198.

(2) Standard control circuit voltages (for other voltages, please consult your Regional Sales Office):

d.c. supply (reversing contactors LP2 K: 0.8...1.15 Uc)

Volts ---	12	20	24 (3)	36	48	60	72	100	110	125	155	174	200	220	230	240	250
Code	JD	ZD	BD	CD	ED	ND	SD	KD	FD	GD	PD	QD	LD	MD	MPD	MUD	UD

Coil with integral suppression device available: add 3 to the code required. Example: JD3.

Low consumption (reversing contactors LP5 K: 0.7...130 Uc)

Volts ---	12	20	24	48	72	110	120
Code	JW3	ZW3	BW3	EW3	SW3	FW3	GW3

(3) For LP2 K only, when connecting an electronic sensor or timer in series with the contactor coil, select a 20 V coil (~ control circuit voltage code Z7, --- control circuit voltage code ZD) so as to compensate for the incurred voltage drop.

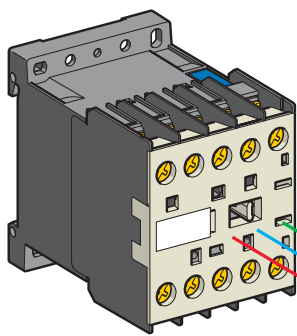

LC1, LC7, LP1 K

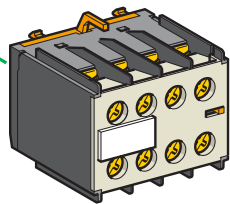

LA1 KN●●M

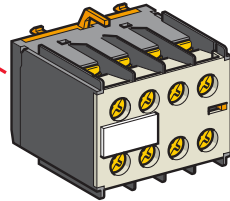

LA1 KN●●

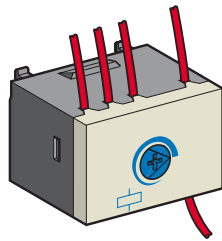

LA2 KT2●

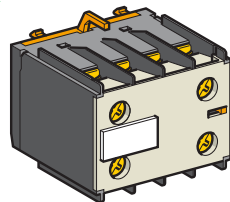

LA1 KN●●P

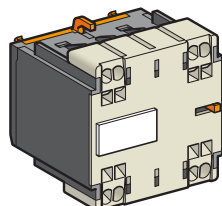

LA1 KN●●3

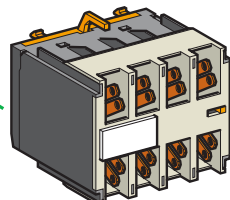

LA1 KN●●7

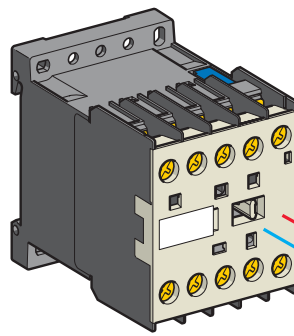

LP4

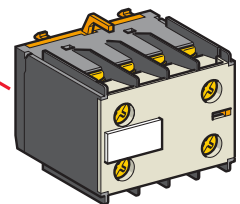

LA1 KN●●

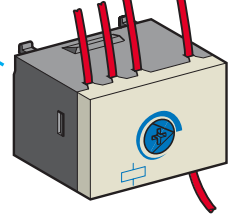

LA2 KT2●

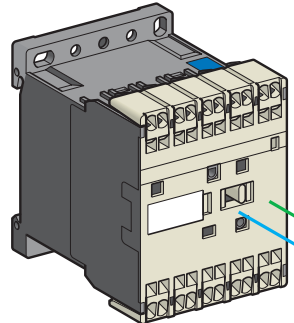

LP4

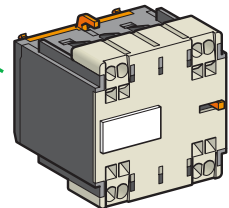

LA1 KN●●3

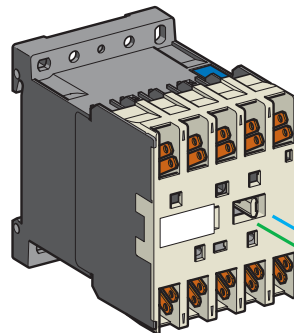

LP4

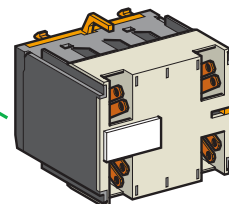

LA1 KN●●7

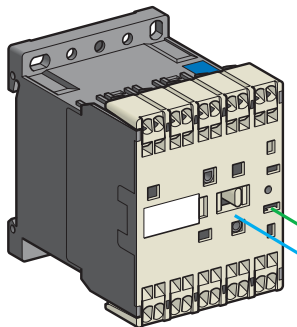

LC1, LP1 K

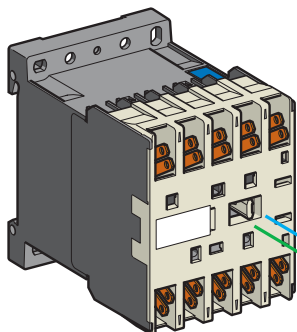



LC1, LC7, LP1 K



TeSys contactors

TeSys K contactors and reversing contactors Auxiliary contact blocks

Instantaneous auxiliary contact blocks					
Recommended for standard applications. Clip-on front mounting, 1 block per contactor					
Connection	For use on contactors	Composition		Reference	Weight
					kg
Screw clamp terminals	All products with screw clamp terminals	2	–	LA1 KN20	0.045
		–	2	LA1 KN02	0.045
		1	1	LA1 KN11	0.045
	All products with screw clamp terminals except low consumption	4	–	LA1 KN40	0.045
		3	1	LA1 KN31	0.045
		2	2	LA1 KN22	0.045
		1	3	LA1 KN13	0.045
–	4	LA1 KN04	0.045		
Spring terminals	All products with spring terminals	2	–	LA1 KN203	0.045
		–	2	LA1 KN023	0.045
		1	1	LA1 KN113	0.045
	All products with spring terminals except low consumption	4	–	LA1 KN403	0.045
		3	1	LA1 KN313	0.045
		2	2	LA1 KN223	0.045
		1	3	LA1 KN133	0.045
		–	4	LA1 KN043	0.045
		–	4	LA1 KN047	0.045
Faston connectors, 1 x 6.35 or 2 x 2.8	All products with Faston connectors	2	–	LA1 KN207	0.045
		–	2	LA1 KN027	0.045
		1	1	LA1 KN117	0.045
	All products with Faston connectors except low consumption	4	–	LA1 KN407	0.045
		3	1	LA1 KN317	0.045
		2	2	LA1 KN227	0.045
		1	3	LA1 KN137	0.045
		–	4	LA1 KN047	0.045
		–	4	LA1 KN047	0.045

With terminal referencing to standard EN 50012. Clip-on front mounting, 1 block per contactor					
Screw clamp terminals with referencing conforming to standard EN 50012	All 3-pole + N/O products with screw clamp terminals except LP4 and LP5 K12	–	2	LA1 KN02M	0.045
		1	1	LA1 KN11M	0.045
	All 3-pole + N/O products with screw clamp terminals except LP4 or LP5 K06, K09 and K12	3	1	LA1 KN31M	0.045
		2	2	LA1 KN22M	0.045
		1	3	LA1 KN13M	0.045
All 4-pole products with screw clamp terminals except LP4 or LP5 K12	1	1	LA1 KN11P	0.045	
All 4-pole products with screw clamp terminals except LP4 or LP5 K09 and K12	2	2	LA1 KN22P	0.045	

Electronic time delay auxiliary contact blocks

Relay output with common point changeover contact, ~ or – 240 V, 2 A maximum.
 Control voltage 0.85...1.1 Uc.
 Maximum switching capacity 250 VA or 150 W.
 Operating temperature -10...+60 °C.
 Reset time: 1.5 s during the time delay period, 0.5 s after the time delay period.

Clip-on front mounting, 1 block per contactor					
Voltage	Type	Timing range	Composition	Reference	Weight
					kg
V		s			kg
~ or – 24...48	On-delay	1...30	1	LA2 KT2E	0.040
~ 110...240	On-delay	1...30	1	LA2 KT2U	0.040

TeSys contactors

TeSys K contactors and reversing contactors
Suppressor modules incorporating LED indicator

965016

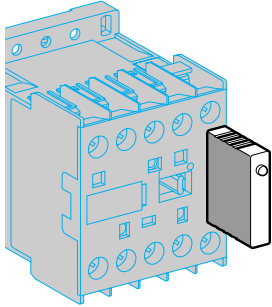

LA4 K●●●

References

Mounting and connection	Type	For voltages	Sold in lots of	Unit reference	Weight kg
Clip-on fixing on the front of contactors LC1 and LP1, with locating device. No tools required.	Varistor (1)	~ and ≐ 12...24 V	5	LA4 KE1B	0.010
		~ and ≐ 32...48 V	5	LA4 KE1E	0.010
		~ and ≐ 50...129 V	5	LA4 KE1FC	0.010
		~ and ≐ 130...250 V	5	LA4 KE1UG	0.010
	Diode + Zener diode (2)	≐ 12...24 V	5	LA4 KC1B	0.010
		≐ 32...48 V	5	LA4 KC1E	0.010
	RC (3)	~ 110...250 V	5	LA4 KA1U	0.010

(1) Protection provided by limiting the transient voltage to 2 Uc max.

Maximum reduction of transient voltage peaks.

Slight increase in drop-out time (1.1 to 1.5 times the normal time).

(2) No overvoltage or oscillating frequency.

Polarised component.

Slight increase in drop-out time (1.1 to 1.5 times the normal time).

(3) Protection by limiting the transient voltage to 3 Uc max. and limitation of the oscillating frequency.

Slight increase in drop-out time (1.2 to 2 times the normal time).

TeSys contactors

TeSys K contactors and reversing contactors

Accessories

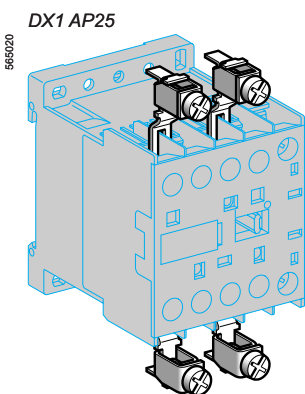
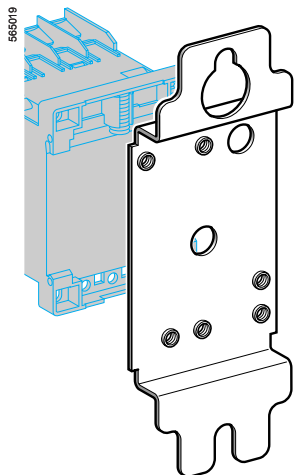

DX1 AP25

LA9 E01

Mounting and marking accessories

Description	Application		Sold in lots of	Unit reference	Weight kg
Mounting plates (1)	For fixing on 1 \perp rail	Clip-on	1	LA9 D973	0.025
	For fixing on 2 \perp rails	110/120 mm fixing centres	10	DX1 AP25	0.065
Marker holder	Clip-on	Onto front of contactor	100	LA9 D90	0.001
Clip-in markers	4 maximum per contactor	Strips of 10 identical numbers 0...9	25	AB1 P● (2)	0.002
		Strips of 10 identical letters A...Z	25	AB1 G● (2)	0.002

Connection accessories

Description	Application		Sold in lots of	Unit preference	Weight kg
Paralleling links	For 2 poles	With screw clamps	4	LA9 E01	0.010
	For 4 poles	With screw clamps	2	LA9 E02	0.015
Set of 6 power connections	For 3-pole reversing contactors for motor control	For contactors with screw clamp terminals	100	LA9 K0969	0.010
Set of 4 power connections	For 4-pole changeover contactor pairs	For contactors with screw clamp terminals	100	LA9 K0970	0.010

(1) Order 1 mounting plate for fixing a contactor and 2 mounting plates for fixing a reversing contactor.
 (2) Complete the reference by replacing the dot with the required character.

Contactors

LC1 K, LC7 K, LP1 K, LP4 K

On panel

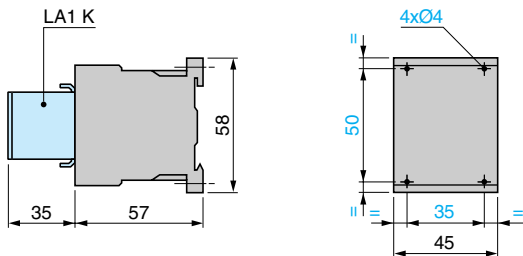

On mounting rail AM1 DP200 or AM1 DE200 (└ 35 mm)

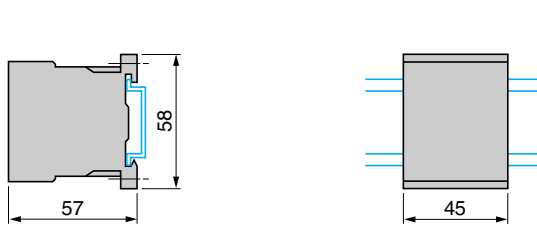

LA9 D973

On one asymmetrical rail DZ5 MB with clip-on mounting plates

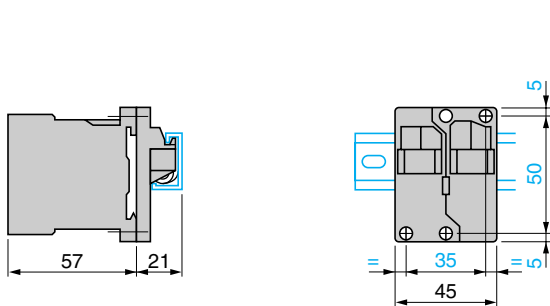

DX1 AP25

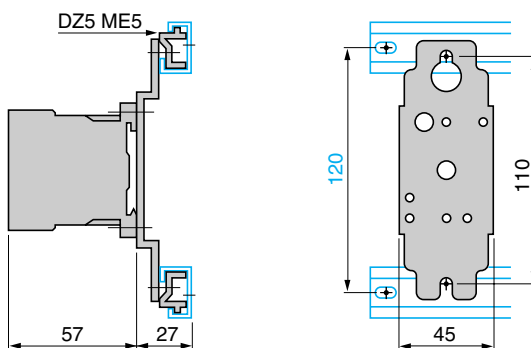

5

On printed circuit board

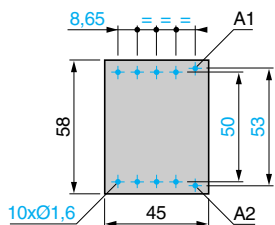

Electronic time delay contact blocks

LA2 KT

On contactor

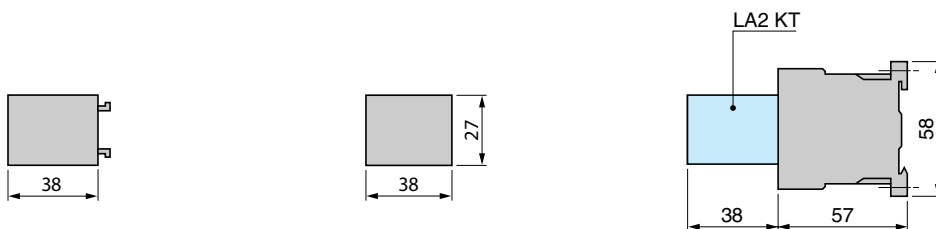

Suppressor modules

LA4 K●

On contactor LC1 K or LP1 K

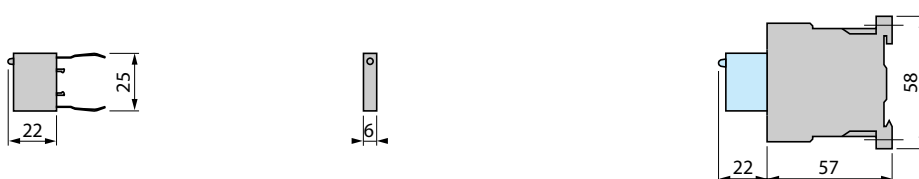

3-pole contactors

3 P + N/O

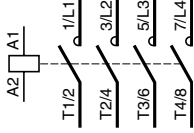

3 P + N/C

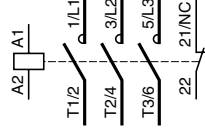

With integral suppression device

LC7 K

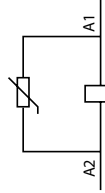

LP4 K

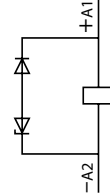

4-pole contactors

4 P

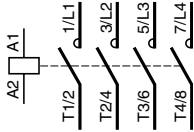

2 P N/O + 2 P N/C

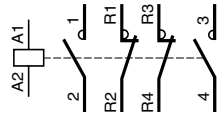

With integral suppression device

LC7 K

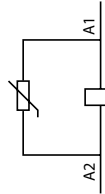

LP4 K

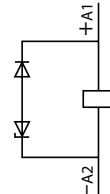

Instantaneous auxiliary contacts LA1 K

LA1 KN20, KN207, KN203



LA1 KN02, KN027, KN023



LA1 KN11, KN117, KN113

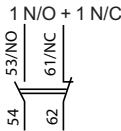

LA1 KN40, KN407, KN403

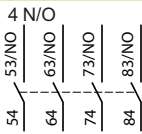

LA1 KN31, KN317, KN313

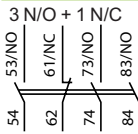

LA1 KN22, KN227, KN223

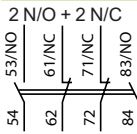

LA1 KN13, KN137, KN133

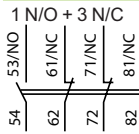

LA1 KN04, KN047, KN043

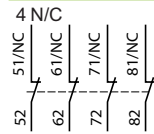

Terminal referencing conforming to standard EN 50012

LA1 KN02M

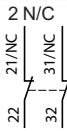

LA1 KN11M

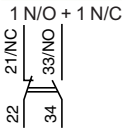

LA1 KN31M

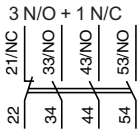

LA1 KN22M

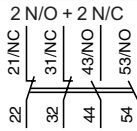

LA1 KN13M

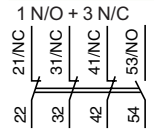

LA1 KN11P

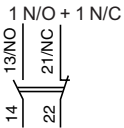

LA1 KN22P

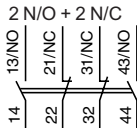

Electronic time delay contact blocks

LA2 KT

1 C/O

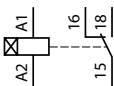

Suppressor modules

LA4 KC

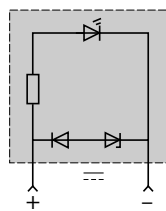

LA4 KE

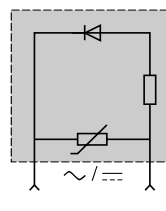

Reversing contactors

LC2 K, LC8 K, LP2 K, LP5 K

On panel

On mounting rail AM1 DP200 or AM1 DE200 (└ 35 mm)

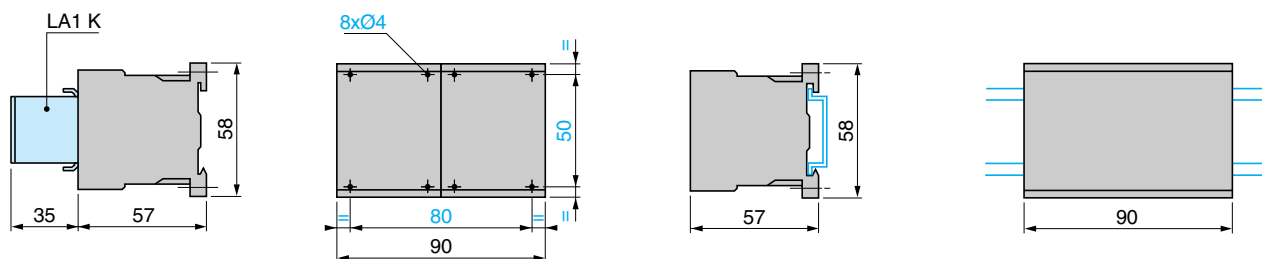

2 x LA9 D973

On one asymmetrical mounting rail DZ5 MB with 2 clip-on mounting plates LA9 D973 or on 2 mounting plates DX1 AP25.

2 x DX1 AP25

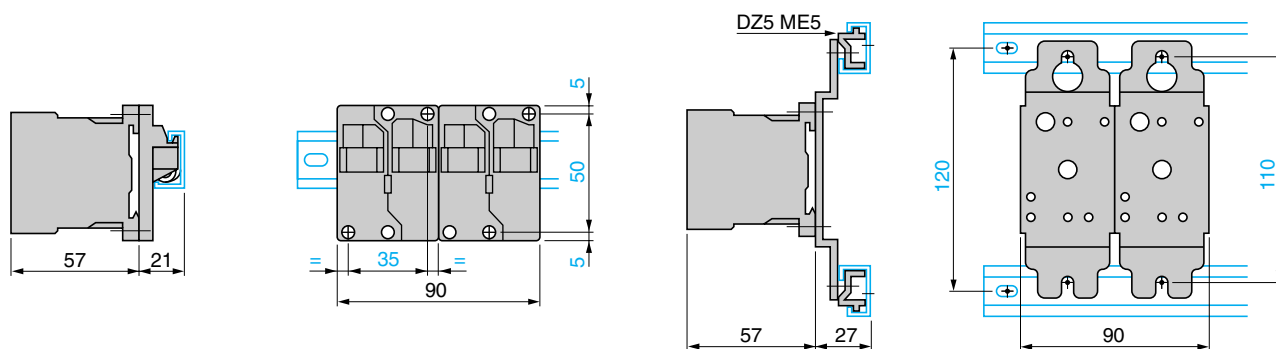

On printed circuit board for reversing contactors or 2 contactors mounted side by side

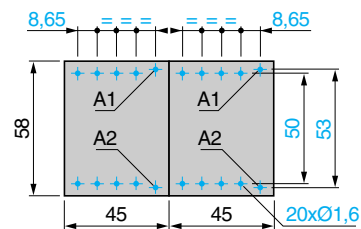

Electronic time delay contact blocks

LA2 KT

On reversing contactors

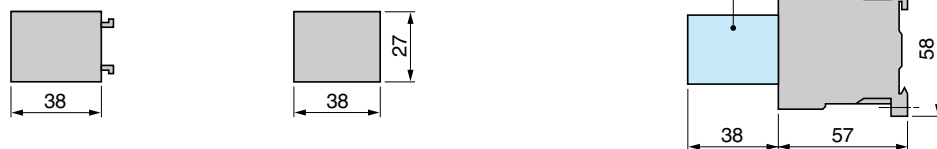

Suppressor modules

LA4 K

On reversing contactors LC2 K or LP2 K



3-pole reversing contactors

With screw clamp connections

3 P + N/O

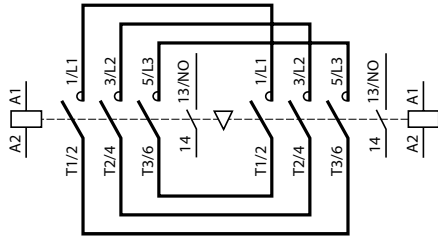

3 P + N/C

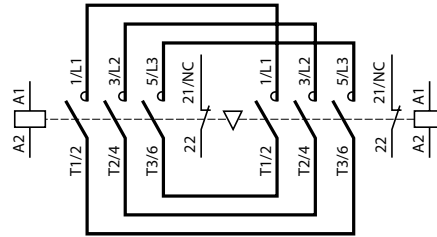

With integral suppression device

LC8 K

LP5 K

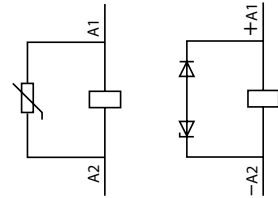

With Faston connectors or solder pins (printed circuit board)

3 P + N/O

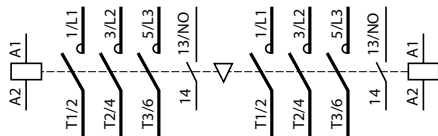

3 P + N/C

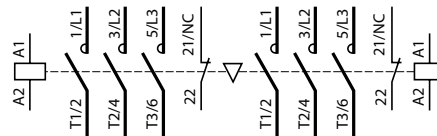

4-pole reversing contactors

With screw clamp connections

4 P

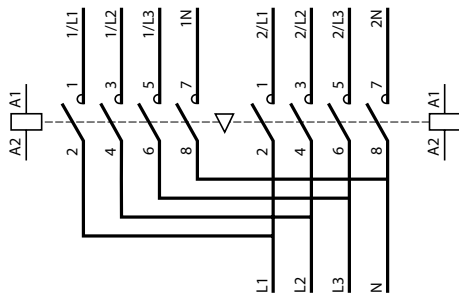

With Faston connectors or solder pins (printed circuit board)

4 P

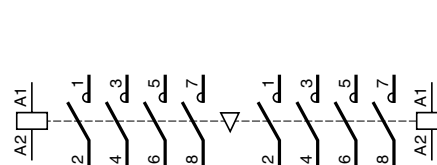

Integral suppression device

LC8 K

LP5 K

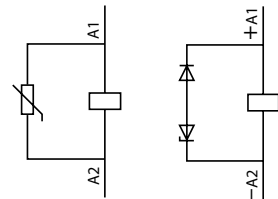

Instantaneous auxiliary contacts LA1 K

Terminal referencing conforming to standard EN 50012

LA1 KN20, KN207, KN203

2 N/O



LA1 KN02, KN027, KN023

2 N/C

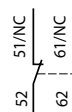

LA1 KN11, KN117, KN113

1 N/O + 1 N/C

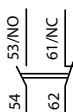

LA KN02M

2 N/C



LA1 KN11M

1 N/O + 1 N/C

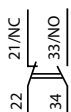

LA1 KN11P

1 N/O + 1 N/C



LA1 KN40, KN407, KN403

4 N/O



LA1 KN31, KN317, KN313

3 N/O + 1 N/C



LA1 KN22, KN227, KN223

2 N/O + 2 N/C



LA KN13, KN137, KN133

1 N/O + 3 N/C

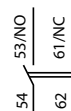

LA1 KN04, KN047, KN043

4 N/C



Electronic time delay contact blocks

LA2 KT

1 C/O

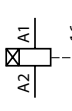

Suppressor modules

LA4 KC

LA4 KE

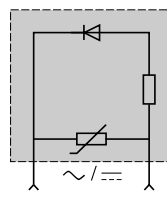
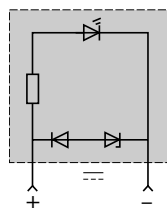

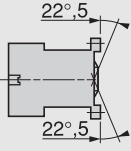
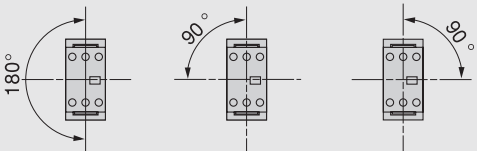
Environment															
Rated insulation voltage (Ui)	Conforming to 60947, VDE 0110 gr C, BS 5424, CSA 22-2 n° 14, UL 508	V	690												
Conforming to standards			IEC 60947, NF C 63-110, VDE 0660, BS 5424												
Approvals			UL, CSA												
Protective treatment	Conforming to IEC 60068 (DIN 50015)		"TC" (Klimafest, Climateproof)												
Degree of protection	Conforming to VDE 0106		Protection against direct finger contact												
Ambient air temperature around the device	Storage	°C	- 50...+ 70												
	Operation	°C	- 20...+ 50												
Maximum operating altitude	Without derating	m	2000												
Operating position			<div style="display: flex; justify-content: space-around;"> <div style="text-align: center;"> <p>Vertical axis</p>  <p>Without derating</p> </div> <div style="text-align: center;"> <p>Horizontal axis</p>  <p>Without derating</p> </div> </div>												
Cabling, screw clamp terminals			<table border="1" style="width: 100%; border-collapse: collapse;"> <thead> <tr> <th style="width: 30%;"></th> <th style="width: 35%;">Min</th> <th style="width: 35%;">Max</th> </tr> </thead> <tbody> <tr> <td>Solid conductor</td> <td>mm² 1 x 1.5 or 2 x 1.5</td> <td>1 x 6 or 2 x 4</td> </tr> <tr> <td>Flexible cable without cable end</td> <td>mm² 1 x 0.5 or 2 x 0.35</td> <td>1 x 6 or 2 x 2.5</td> </tr> <tr> <td>Flexible cable with cable end</td> <td>mm² 1 x 0.35 or 2 x 0.35</td> <td>1 x 6 or 2 x 1.5</td> </tr> </tbody> </table>		Min	Max	Solid conductor	mm² 1 x 1.5 or 2 x 1.5	1 x 6 or 2 x 4	Flexible cable without cable end	mm² 1 x 0.5 or 2 x 0.35	1 x 6 or 2 x 2.5	Flexible cable with cable end	mm² 1 x 0.35 or 2 x 0.35	1 x 6 or 2 x 1.5
		Min	Max												
	Solid conductor	mm² 1 x 1.5 or 2 x 1.5	1 x 6 or 2 x 4												
	Flexible cable without cable end	mm² 1 x 0.5 or 2 x 0.35	1 x 6 or 2 x 2.5												
Flexible cable with cable end	mm² 1 x 0.35 or 2 x 0.35	1 x 6 or 2 x 1.5													
Tightening torque	Pozidriv n° 1 head	N.m	0.8												
Terminal referencing			Conforming to standards En 50005												

Pole characteristics			
Conventional thermal current (I_{th})	For ambient temperature ≤ 55 °C	A	12
Rated operational frequency		Hz	50/60
Frequency limits of the operational current		Hz	Up to 400
Rated operational voltage (U_e)		V	690
Rated making capacity	I rms conforming to NF C 63-110 and IEC 60947	A	66
Rated breaking capacity (for U_e ≤ 400 V)	Conforming to NF C 63-110 and IEC 60947 (I rms)	A	52
Short time rating	In free air for a time "t" from cold state (θ ≤ 55 °C)	A	50
Short-circuit protection	gl fuse U ≤ 440 V	A	16
Average impedance per pole	At I _{th} and 50 Hz	mΩ	4
Maximum rated operational current		A	
For a temperature ≤ 55 °C	AC-3 (1) (U _e ≤ 400 V)	A	6
	AC-1	A	12
Utilisation in category AC-1 resistive circuits, heating, lighting (U_e ≤ 440 V)	Increase in operational current by paralleling of poles	A	20

Auxiliary contact characteristics of add-on blocks			
Rated operational voltage (U_e)	Up to	V	690
Rated insulation voltage (U_i)	Conforming to IEC 60947, BS 5424, VDE 0110 group C, CSA C 22-2 n° 14	V	690
Conventional thermal current (I_{th})	For ambient temperature ≤ 55 °C	A	10
Frequency of operational current		Hz	Up to 400
Short-circuit protection	Conforming to IEC 60947 and VDE 0660, gl fuse	A	10

Operational power of contacts conforming to IEC 60947

	a.c. supply, category AC-15						d.c. supply, category DC-13						
	V	24	48	110/127	220/230	380/400	440	V	24	48	110	220	440
1 million operating cycles	VA	48	96	240	440	800	880	W	120	80	60	52	51
3 million operating cycles	VA	17	34	86	158	288	317	W	55	38	30	28	26
10 million operating cycles	VA	7	14	36	66	120	132	W	15	11	9	8	7
Occasional making capacity	VA	1000	2050	5000	10000	14000	13000	W	720	600	400	300	230

(1) For LC1 contactors.

Control circuit characteristics				
Type		LC1 SK06	LP1 SK06	
Rated control circuit voltage (Uc)	V	~ 24...400	--- 12...72	
Control voltage limits (θ ≤ 50 °C)	For operation	0.85...1.1 Uc	0.85...1.1 Uc	
	For drop-out	≥ 0.20 Uc	≥ 0.10 Uc	
Average coil consumption at 20 °C and at Uc	Inrush	16 VA	2.2 W	
	Sealed	4.2 VA	2.2 W	
Heat dissipation	W	1.4	2.2	
Operating time at 20 °C and at Uc	Between coil energisation and	opening of the N/C contacts	ms 8...16	10...18
		closing of the N/O contacts	ms 7...14	8...12
	Between coil de-energisation and	opening of the N/O contacts	ms 6...8	4...6
		closing of the N/C contacts	ms 8...10	6...8
Maximum operating rate	In operating cycles per hour	1200	1200	
Mechanical durability at Uc In millions of operating cycles	50/60 Hz coil	10	–	
	--- coil	–	10	

Use in category AC-3 ($U_e \leq 440$ V)

Control of 3-phase asynchronous squirrel cage motors with breaking whilst running.
The current broken (I_c) in category AC-3 is equal to the rated operational current (I_e) of the motor.

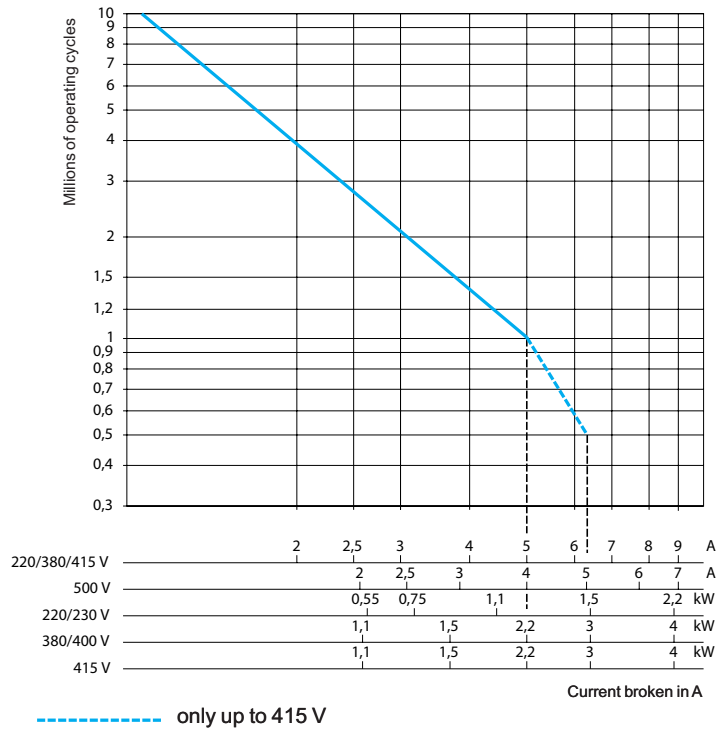

Use in category AC-1 ($U_e \leq 440$ V)

Control of resistive circuits ($\cos \varphi \geq 0.95$).
The current broken (I_c) in category AC-1 is equal to the current (I_e) normally drawn by the load.

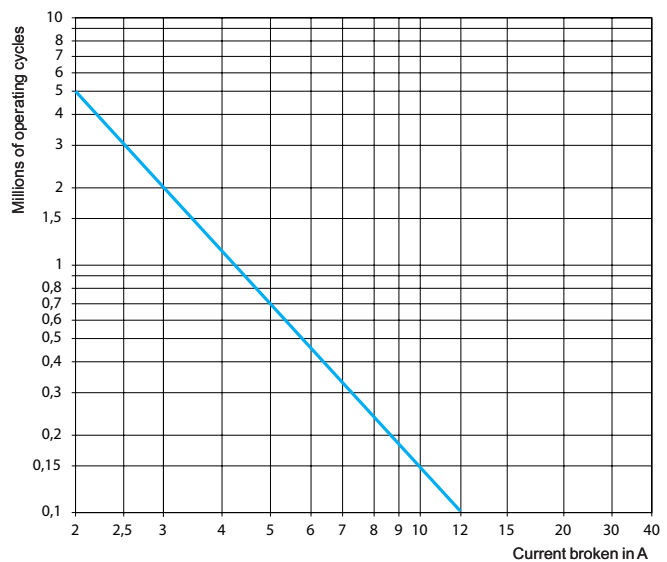

- Width of contactor 27 mm.
- Mounting on 35 mm rail.
- Screw clamp terminals.



LC1 SK06



LA1 SK10

Mini-contactors for motor in category AC-3							
Standard power ratings of 3-phase motors 50/60 Hz in category AC-3 (1)			Rated operational voltage in AC-3 up to 400 V	Number of poles	Instantaneous auxiliary contacts	Basic reference. Complete with code indicating control circuit voltage (2)	Weight
220 V	380 V	660 V		2	-	LC1 SK0600●●	0.132
230 V	415 V	690 V					
kW	kW	kW	A				kg
1.1	2.2	2.2	6				

Mini-contactors for motor in category AC-1					
Non inductive loads maximum current ($\theta \leq 55^\circ\text{C}$) utilisation category AC-1	Control circuit supply	Number of poles	Instantaneous auxiliary contacts	Basic reference. Complete with code indicating control circuit voltage (2)	Weight
		2	-	LC1 SK0600●●	0.132
	a.c.	2	-	LP1 SK0600●●	0.132
	d.c.	2	-		
A					kg

Add-on block with 1 power pole (for 3-phase circuits)					
For use on contactor	Number of poles	Instantaneous auxiliary contacts	Reference	Weight	
LC1 SK06	1	1	LA1 SK10	0.022	
clip-on front mounting	1	-	LA1 SK01	0.022	

Nota : Auxiliary contact blocks and coil suppressor module, see next page.

- (1) For use in AC-3 category and 3-phase circuits, an LA1 SK●● auxiliary contact block should be ordered separately for mounting on the contactor.
 (2) Standard control circuit voltages (variable delivery times, please consult your Regional Sales Office):

Mini-contactors LC1 SK									
Volts ~ 50/60 Hz	24	48	110	120	220	230	240	380	400
Code	B7	E7	F7	G7	M7	P7	U7	Q7	V7
Mini-contactors LP1 SK									
Volts ---	12	24	36	48	72				
Code	JD	BD	CD	ED	SD				

TeSys contactors

Mini-contactors TeSys LC1 SK and LP1 SK
Instantaneous auxiliary contacts and coil suppressor modules



LA1 SK11



LA4 SK1

Instantaneous auxiliary contact blocks

Clip-on front mounting

For use on contactor	Maximum number of blocks per contactor	Composition	Reference	Weight
LC1 SK06	1		LA1 SK20	0.022
			LA1 SK02	0.022
			LA1 SK11	0.022

Coil suppressor modules

Clip-on fixing and electrical connection on right-hand side, without use of tools

For use on contactors	Type	For voltages	Sold in lots of	Unit reference	Weight
LC1 SK06 and LP1 SK06	Varistor (1)	~ and --- 24 V...48 V	10	LA4 SKE1E	0.003
		~ and --- 110 V...250 V	10	LA4 SKE1U	0.003
	Diode (2)	--- 24 V...250 V	10	LA4 SKC1U	0.003

(1) Protection provided by limiting the transient voltage to $2 U_c$ max. Maximum reduction of transient voltage peaks. Slight increase in drop-out time (1.1 to 1.5 times the normal time).

(2) No overvoltage or oscillating frequency.

Slight increase in drop-out time (1.1 to 1.5 times the normal time).

Dimensions

Mini-contactors

LC1 and LP1 SK06

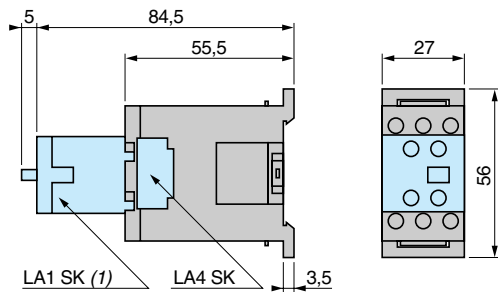

(1) Only on LC1 SK06.

Mounting

Mini-contactors

LC1 and LP1 SK06

On mounting rail AM1 DP200 or AM1 DE200 (└ 35 mm)

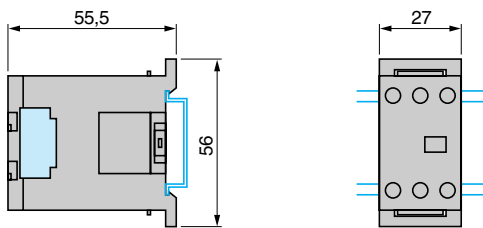

Schemes

2-pole mini-contactors

LC1 and LP1 SK06

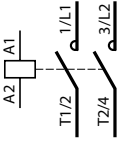

Add-on power pole block

1 pole + 1 "N/O" aux.

1 pole + 1 "N/C" aux.

LA1 SK10

LA1 SK01

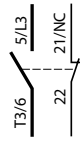

Instantaneous auxiliary contacts

2 "N/O"

2 "N/C"

1 "N/O" + 1 "N/C"

LA1 SK20

LA1 SK02

LA1 SK11

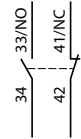
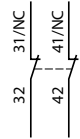
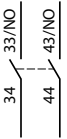

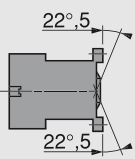
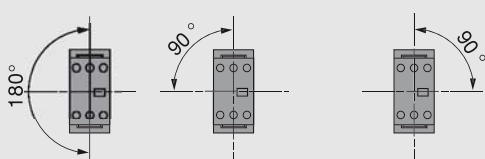
Environment						
Rated insulation voltage (Ui)	Conforming to IEC 60947, VDE 0110 gr C, BS 5424, CSA 22-2 n° 14, UL 508	V	690			
Conforming to standards			IEC 60947, NF C 63-110, VDE 0660, BS 5424			
Product certifications			UL, CSA			
Protective treatment	Conforming to IEC 60068 (DIN 50015)		"TC" (Klimafest, Climateproof)			
Degree of protection	Conforming to VDE 0106		Protection against direct finger contact			
Ambient air temperature around the device	Storage	°C	- 50...+ 70			
	Operation	°C	- 20...+ 50			
Maximum operating altitude	Without derating	m	2000			
Operating position			<div style="display: flex; justify-content: space-around;"> <div style="text-align: center;"> <p>Vertical axis</p>  <p>Without derating</p> </div> <div style="text-align: center;"> <p>Horizontal axis</p>  <p>Without derating</p> </div> </div>			
Cabling, connectors	Solid conductor	mm ²	Min.	1 x 1.5 or 2 x 1.5	Max.	1 x 6 or 2 x 4
	Flexible cable without cable end		1 x 0.5 or 2 x 0.35	1 x 6 or 2 x 2.5		
	Flexible cable with cable end	mm ²	1 x 0.35 or 2 x 0.35	1 x 6 or 2 x 1.5		
Tightening torque	Pozidriv n° 1 head	N.m	0.8			
Terminal referencing			Conforming to standards En 50005			

5

Pole characteristics					
Mini-contactor type			LC1 SKGC2	LC1 SKGC3 and LC1 SKGC4	
Conventional thermal current (I _{th})	For ambient temperature ≤ 55 °C	A	20	20	
Rated operational frequency		Hz	50/60		
Frequency limit of the operational current		Hz	up to 400		
Rated operational voltage (U _e)		V	690		
Rated making capacity	I _{rms} conforming to NF C 63-110 and IEC 60947	A	50	85	
Rated breaking capacity (for U _e ≤ 400 V)	Conforming to NF C 63-110 and IEC 60947 (I _{rms})	A	40	68	
Permissible short time rating	In free air for a time "t" from cold state (q ≤ 55 °C)	A	40	60	
Short-circuit protection	gl fuse U ≤ 440 V	A	20	20	
Average impedance per pole	At I _{th} and 50 Hz	mΩ	4	4	
Maximum rated operational current	For temperature ≤ 55 °C	AC-3 (U _e ≤ 400 V)	A	5	9
		AC-1	A	20	20
Use in category AC-1 resistive circuits, heating, lighting (U _e ≤ 440 V)	Increase in rated operational current by paralleling of 2 poles	A	32	32	

Auxiliary contact characteristics of mini-contactors				
Rated operational voltage (U _e)	Up to	V	690	
Rated insulation voltage (U _i)	Conforming to IEC 60947, BS 5424, VDE 0110 group C, CSA C 22-2 n° 14	V	690	
Conventional thermal current (I _{th})	For ambient temperature ≤ 55 °C	A	10	
Frequency of the operational current		Hz	Up to 400	
Short-circuit protection	Conforming to IEC 60947 and VDE 0660, gl fuse	A	10	

Operational power of contacts conforming to IEC 60947	a.c. supply, category AC-15	d.c. supply, category DC-13
	Electrical durability (valid for up to 3600 operating cycles/hour) on an inductive load such as the coil of an electromagnet: making current (cos φ 0.7) = 10 times the power broken (cos φ 0.4).	Electrical durability (valid for up to 1200 operating cycles/hour) on an inductive load such as the coil of an electromagnet, without economy resistor, the time constant increasing with the load.

	V	24	48	110/ 127	220/ 230	380/ 400	440	V	24	48	110	220	440
1 million operating cycles	VA	48	96	240	440	800	880	W	120	80	60	52	51
3 million operating cycles	VA	17	34	86	158	288	317	W	55	38	30	28	26
10 million operating cycles	VA	7	14	36	66	120	132	W	15	11	9	8	7
Occasional making capacity	VA	1000	2050	5000	10000	14000	13000	W	720	600	400	300	230

Control circuit characteristics				
Mini-contactor type			LC1 SKGC2	LC1 SKGC3 and LC1 SKGC4
Rated control circuit voltage (Uc)		V	~ 24...400	
Control voltage limits (θ ≤ 55 °C)			0.85...1.1 Uc	
	Operation		≥ 0.20 Uc	
	For drop-out			
Average coil consumption at 20 °C and at Uc				
	Inrush	VA	16	23
	Sealed	VA	4.2	4.9
Heat dissipation		W	1.4	1.5
Operating time at 20 °C and at Uc				
Between coil energisation and	opening of the N/C contacts	ms	8...16	
	closing of the N/O contacts	ms	7...14	
Between coil de-energisation and	opening of the N/O contacts	ms	6...8	
	closing of the N/C contacts	ms	8...10	
Maximum operating rate	In operating cycles per hour		1200	
Mechanical durability at Uc in millions of operating cycles	50/60 Hz coil		10	

Use in category AC-3 ($U_e \leq 440$ V)

Control of 3-phase asynchronous squirrel cage motors with breaking whilst running. The current broken (I_c) in category AC-3 is equal to the rated operational current of the motor.

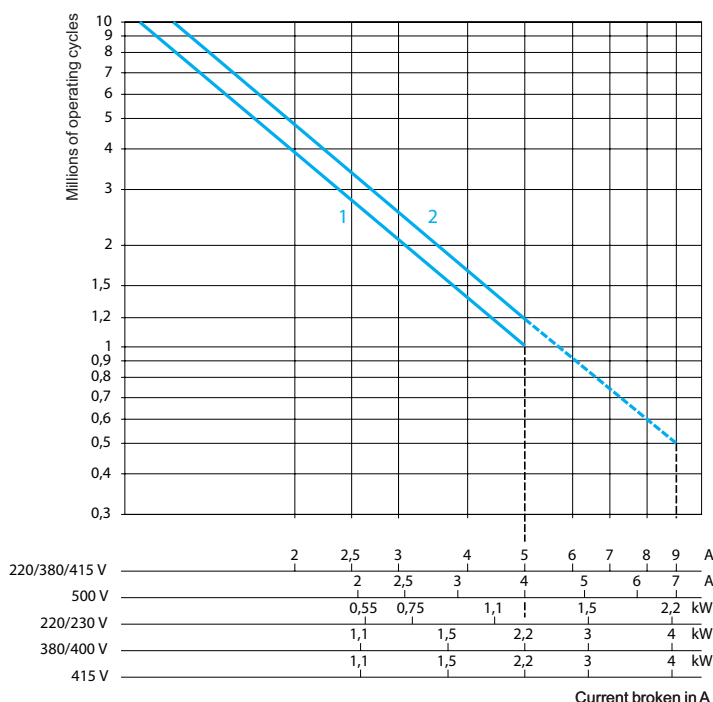

- 1 LC1 SKGC2
- 2 LC1 SKGC3 and SKGC4
- only up to 415 V

Use in category AC-1 ($U_e \leq 440$ V)

Control of resistive circuits ($\cos \varphi \geq 0.95$). The current broken (I_c) in category AC-1 is equal to the current (I_e) normally drawn by the load.

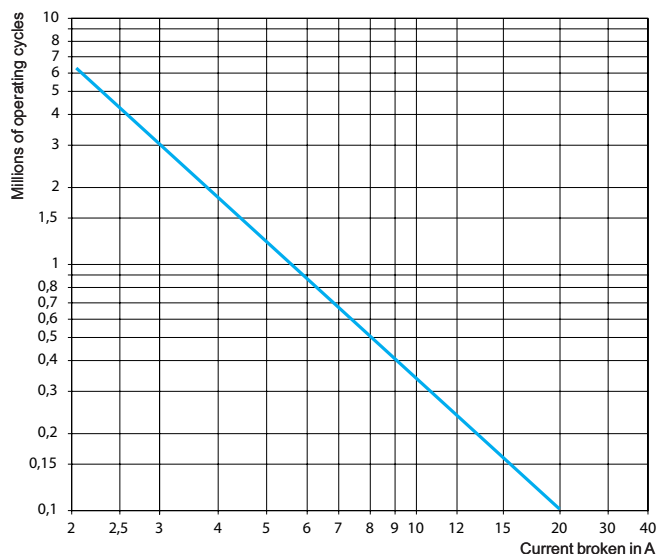

TeSys contactors

Mini-contactors TeSys LC1 SKGC, for use in modular panels

- Mounting on 35 mm rail or fixing by four Ø 4 screws, except for LC1 SKGC200.
- Connection by connectors.
- Mini-contactor fitted with transparent, sealable protective cover to prevent front face access.

511135



LC1 SKGC200

Mini-contactors, width 27 mm									
Standard power ratings of 3-phase motors 50/60 Hz in category AC-3			Rated operational current in AC-3 up to 400 V	Non inductive loads category AC-1 maximum current $\theta \leq 50^\circ\text{C}$	No. of poles			Basic reference, to be completed by adding the voltage code (1)	Weight
220 V	380 V	660 V			2	3	4		
kW	kW	kW	A	A					kg
-	-	-	5	20	2	-	-	LC1 SKGC200●●	0.132

511136



LC1 SKGC400

Mini-contactors, width 45 mm									
Standard power ratings of 3-phase motors 50/60 Hz in category AC-3			Rated operational current in AC-3 up to 400 V	Non inductive loads category AC-1 maximum current $\theta \leq 50^\circ\text{C}$	No. of poles			Basic reference, to be completed by adding the voltage code (1)	Weight
220 V	380 V	660 V			3	1	4		
kW	kW	kW	A	A					kg
1.1	4	4	9	20	3	1	-	LC1 SKGC310●●	0.175
					3	-	1	LC1 SKGC301●●	0.175
					4	-	-	LC1 SKGC400●●	0.175

(1) Standard control circuit voltages (for other voltages, please consult your Regional Sales Office)

Volts ~ 50/60 Hz	24	48	110	120	220	230	240	380	400
Code	B7	E7	F7	G7	M7	P7	U7	Q7	V7

TeSys contactors

Mini-contactors TeSys LC1 SKGC,
for use in modular panels
Suppressor modules

511134



LA4 SK●1●

Suppressor modules

Connection without need for tools by clipping onto right-hand side of contactor

For use on contactors	Type	For voltages	Sold in lots of	Unit reference	Weight kg
LC1 SKGC	Varistor (1)	~ and ≍ 24...48 V	10	LA4 SKE1E	0.003
		~ and ≍ 110...250 V	10	LA4 SKE1U	0.003
	Diode (2)	≍ 24...250 V	10	LA4 SKC1U	0.003

(1) Protection provided by limiting the transient voltage to 2 Uc max.
Maximum reduction of transient voltage peaks.
Slight increase in drop-out time (1.1 to 1.5 times the normal time).
(2) No overvoltage or oscillating frequency.
Slight increase in drop-out time (1.1 to 1.5 times the normal time).

TeSys contactors

Mini-contactors TeSys LC1 SKGC,
for use in modular panels

Dimensions

Mini-contactors LC1 SKGC2

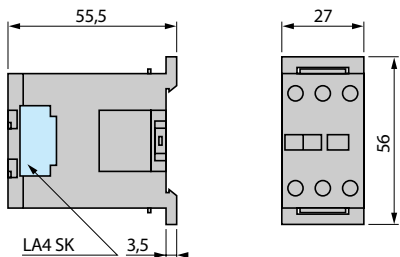

Mounting

On mounting rail AM1 DP200 or AM1 DE200 (└ 35 mm)

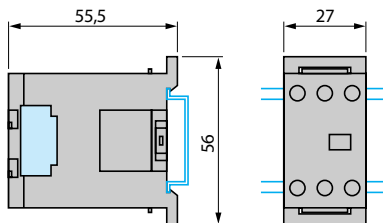

Dimensions

Mini-contactors LC1 SKGC3 and SKGC4

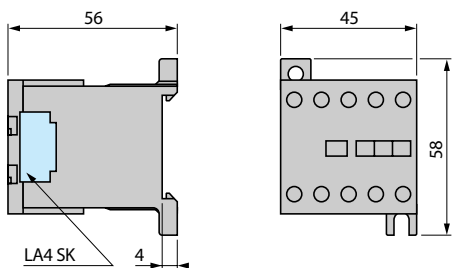

Mounting

On panel

On mounting rail AM1 DP200 or AM1 DE200 (└ 35 mm)

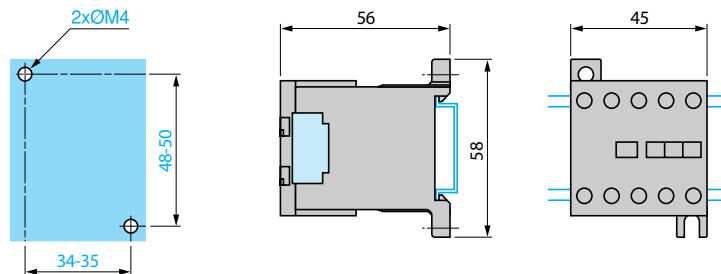

2-pole mini-contactors

LC1 SKGC2

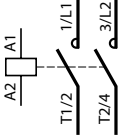

3-pole mini-contactors

LC1 SKGC310

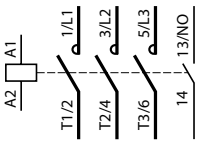

LC1 SKGC301

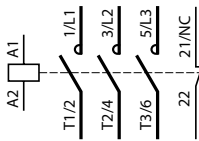

4-pole mini-contactors

LC1 SKGC400

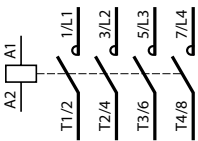

Applications

All types of control system



Rated operational current	le max AC-3 ($U_e \leq 440$ V)
	le AC-1 ($\theta \leq 60$ °C)

9 A	12 A	18 A	25 A	32 A	38 A
20/25 A		25/32 A	25/40 A	50 A	

Rated operational voltage	690 V on \sim and $\overline{\text{---}}$
----------------------------------	---

Number of poles	3 or 4
------------------------	--------

3 or 4	3 or 4	3 or 4	3 or 4	3	
--------	--------	--------	--------	---	--

Rated operational power in AC-3	220/240 V
	380/400 V
	415/440 V
	500 V
	660/690 V
	1000 V

2.2 kW	3 kW	4 kW	5.5 kW	7.5 kW	9 kW
4 kW	5.5 kW	7.5 kW	11 kW	15 kW	18.5 kW
4 kW	5.5 kW	9 kW	11 kW	15 kW	18.5 kW
5.5 kW	7.5 kW	10 kW	15 kW	18.5 kW	18.5 kW
5.5 kW	7.5 kW	10 kW	15 kW	18.5 kW	18.5 kW
–	–	–	–	–	–

Auxiliary contacts	
---------------------------	--

1 N/C and 1 N/O instantaneous incorporated in the contactors, with add-on blocks common to the whole range comprising up to 4 N/C or N/O instantaneous, up to 1 N/O + 1 N/C time delay and up to 2 N/O or 2 N/C protected contacts and 2 screen continuity terminals.

Thermal overload relays manual-auto compatible	Class 10 A
	Class 20

0.10...10 A	0.10...13 A	0.10...18 A	0.10...32 A	0.10...38 A	0.10...38 A
2.5...10 A	2.5...13 A	2.5...18 A	2.5...32 A		

Suppressor modules ($\overline{\text{---}}$ and low consumption contactors are fitted with a built-in bidirectional peak limiting diode suppressor as standard)	Varistor
	Diode
	RC circuit
	Bidirectional peak limiting diode

•	•	•	•	•	•
–	–	–	–	–	–
•	•	•	•	•	•
•	•	•	•	•	•

Interfaces	Relay output
	Relay interface with manual override switch
	Solid state

•	•	•	•	•	•
•	•	•	•	•	•
•	•	•	•	•	•

Contactor type references	\sim or $\overline{\text{---}}$ 3 pole
	\sim 4 pole
	$\overline{\text{---}}$ 4 pole

LC1 D09	LC1 D12	LC1 D18	LC1 D25	LC1 D32	LC1 D38
LC1 DT20/	LC1 DT25/	LC1 DT32/	LC1 DT40/	–	–
LC1 D098	LC1 D128	LC1 D188	LC1 D258	–	–

Reversing contactor type references	\sim 3 pole
	$\overline{\text{---}}$ 3 pole
	\sim 4 pole
	$\overline{\text{---}}$ 4 pole

LC2 D09	LC2 D12	LC2 D18	LC2 D25	LC2 D32	LC2 D38
LC2 D09	LC2 D12	LC2 D18	LC2 D25	LC2 D32	LC2 D38
LC2 DT20	LC2 DT25	LC2 DT32	LC2 DT40	–	–
LC2 DT20	LC2 DT25	LC2 DT32	LC2 DT40	–	–

Pages	Contactors
	Reversing contactors

5/62 to 5/67
5/72 to 5/75



40 A	50 A	65 A	80 A	95 A	115 A	150 A
60 A	80 A		125 A		200 A	

690 V ~ or ---	1000 V on ~ supply, 690 V on --- supply
----------------	---

3	4	3	3	4	3	4	3	4	3
11 kW	15 kW	18.5 kW	22 kW	25 kW	30 kW	40 kW	11 kW	15 kW	18.5 kW
18.5 kW	22 kW	30 kW	37 kW	45 kW	55 kW	75 kW	18.5 kW	22 kW	30 kW
22 kW	25/30 kW	37 kW	45 kW	45 kW	59 kW	80 kW	22 kW	25/30 kW	37 kW
22 kW	30 kW	37 kW	55 kW	55 kW	75 kW	90 kW	22 kW	30 kW	37 kW
30 kW	33 kW	37 kW	45 kW	45 kW	80 kW	100 kW	30 kW	33 kW	37 kW
-	-	-	45 kW	45 kW	75 kW	90 kW	-	-	-

1 N/C and 1 N/O instantaneous incorporated in the contactors, with add-on blocks common to the whole range comprising up to 4 N/C or N/O instantaneous, up to 1 N/O + 1 N/C time delay and up to 2 N/O or 2 N/C protected contacts and 2 screen continuity terminals.

13...40 A	13...50 A	13...65 A	17...104 A	17...104 A	60...150 A	60...150 A
13...40 A	13...50 A	13...65 A	17...80 A		60...150 A	60...150 A

•	•	•	•	•	•	•	•	•	•
•	•	•	•	•	•	•	•	•	•
•	•	•	•	•	•	•	•	•	•
•	•	•	•	•	•	•	•	•	•

•	•	•	•	•	•	•	•	•	•
•	•	•	•	•	•	•	•	•	•
•	•	•	•	•	•	•	•	•	•

LC1 D40A	LC1 D50A	LC1 D65A	LC1 D80	LC1 D95	LC1 D115	LC1 D150
LC1 DT60A	-	LC1 DT80A	LC1 D80	-	LC1 D115	-
LC1 DT60A	-	LC1 DT80A	LC1 D80	-	LC1 D115	-

LC2 D40A	LC2 D50A	LC2 D65A	LC2 D80	LC2 D95	LC2 D115	LC2 D150
LC2 D40A	LC2 D50A	LC2 D65A	-	-	-	-
-	-	-	LC2 D80	-	LC2 D115	-
-	-	-	-	-	-	-

5/62 to 5/67
5/72 to 5/75

Applications

Automation systems



Rated operational current	le max AC-3 ($U_e \leq 440$ V)
	le AC-1 ($\theta \leq 60$ °C)

9 A
20/25 A

12 A
20/25 A

18 A
25/32 A

Rated operational voltage	690 V
---------------------------	-------

Number of poles	3 or 4
-----------------	--------

3 or 4

3 or 4

3 or 4

Rated operational power in AC-3	220/240 V
	380/400 V
	415/440 V
	500 V
	660/690 V

2.2 kW
4 kW
4 kW
5.5 kW
5.5 kW

3 kW
5.5 kW
5.5 kW
7.5 kW
7.5 kW

4 kW
7.5 kW
9 kW
10 kW
10 kW

Coil consumption	2.4 W (100 mA - 24 V)
------------------	-----------------------

Operating ranges	0.7...1.25 U_c
------------------	------------------

Operating time at 20 °C and at U_c	Closing	70 ms
	Opening	25 ms

70 ms
25 ms

Auxiliary contact block modules	1 N/C and 1 N/O instantaneous contacts incorporated in the contactors, with add-on blocks common to the whole range, comprising up to 2 N/C or 2 N/O instantaneous standard contacts
---------------------------------	--

Interference suppression	Built-in suppression as standard, by bi-directional peak limiting diode
--------------------------	---

Contactor type	3-pole
	4-pole

LC1 D09
LC1 DT20/D098

LC1 D12
LC1 DT25/D128

LC1 D18
LC1 DT32/D188

Reversing contactor type	3-pole
	4-pole

LC2 D09
LC2 DT20

LC2 D12
LC2 DT25

LC2 D18
LC2 DT32

Pages	Contactors	5/62 to 5/67
	Reversing contactors	5/72 to 5/75

5/62 to 5/67
5/72 to 5/75

(1) With low consumption kit **LA4 DBL** (see page 5/83).
 (2) With 2 low consumption kits **LA4 DBL** (see page 5/83).

5



25 A	32 A	38 A	40 A	50 A	65 A
25/40 A	50 A	50 A	60 A	–	80 A
690 V			690 V		
3 or 4	3	3	3	3	3
5.5 kW	7.5 kW	9 kW	11 kW	15 kW	18.5 kW
11 kW	15 kW	18.5 kW	18.5 kW	22 kW	30 kW
11 kW	15 kW	18.5 kW	22 kW	25/30 kW	37 kW
15 kW	18.5 kW	18.5 kW	22 kW	30 kW	37 kW
15 kW	18.5 kW	18.5 kW	30 kW	33 kW	37 kW
2.4 W (100 mA - 24 V)			0.6 W (25 mA - 24 V) for relay LA4 DFB + the power consumed by the contactor coil		
0.7...1.25 U _c			–	–	–
70 ms			–	–	–
25 ms			–	–	–

1 N/C and 1 N/O instantaneous contacts incorporated in the contactors, with add-on blocks common to the whole range, comprising up to 2 N/C or 2 N/O instantaneous standard contacts

Built-in suppression as standard, by bi-directional peak limiting diode

LC1 D25	LC1 D32	LC1 D38	LC1 D40A (1)	LC1 D50A (1)	LC1 D65A (1)
LC1 DT40/D258			–	–	–
LC2 D25	LC2 D32	LC2 D38	LC2 D40A (2)	LC2 D50A (2)	LC2 D65A (2)
LC2 DT40					

5/62 to 5/67

5/72 to 5/75

Contactor type	LC1	D09...D18 DT20 and DT25	D25...D38 DT32 and DT40	D40A...D65A DT60A and DT80A	D80...D95	D115 and D150	
Environment							
Rated insulation voltage (U_i)	Conforming to IEC 60947-4-1, overvoltage category III, degree of pollution: 3	V	690			1000	
	Conforming to UL, CSA	V	600				
Rated impulse withstand voltage (U_{imp})	Conforming to IEC 60947	kV	6			8	
Conforming to standards			IEC/EN 60947-4-1, IEC/EN 60947-5-1, UL 508, CSA C22.2 n°14.				
Product certifications			UL, CSA (1), CCC, GOST GL, DNV, RINA, BV, LROS (pending for contactors LC1 D40A to D65A)				
Degree of protection (2) (front face only)	Conforming to VDE 0106 and IEC 60529						
	Power circuit connections		Protection against direct finger contact IP 2X				
	Coil connection		Protection against direct finger contact IP 2X				
Protective treatment	Conforming to IEC 60068-2-30		"TH"				
Ambient air temperature around the device	Storage	°C	- 60...+ 80				
	Operation	°C	- 5...+ 60				
	Permissible	°C	- 40...+ 70, for operation at U _c				
Maximum operating altitude	Without derating	m	3000				
Operating positions (3)	Without derating in the following positions						
	Positions that are not permissible		For \sim contactors LC1 D09 to LC1 D65A. 				
Flame resistance	Conforming to UL 94		V1				
	Conforming to IEC 60695-2-1	°C	850				
Shock resistance (4) 1/2 sine wave = 11 ms	Contactor open		10 gn	8 gn	10 gn	8 gn	6 gn
	Contactor closed		15 gn	15 gn	15 gn	10 gn	15 gn
Vibration resistance (4) 5...300 Hz	Contactor open		2 gn				
	Contactor closed		4 gn	4 gn	4 gn	3 gn	4 gn

(1) Contactor LC1 D95 with d.c. coil is not UL/CSA certified.

(2) Protection provided for the cabling c.s.a.'s indicated on the next page and for connection by cable.

(3) When mounting on a vertical rail, use a stop.

(4) Without modifying the contact states, in the most unfavourable direction (coil energised at U_e).

Contactor type		LC1	D09 and D12 DT20 and DT25	D18 (3P)	D25 (3P)	D32	D38	D18 and D25 (4P) DT32 and DT40	D40A to D65A DT60A and DT80A (1)	D80 and D95	D115 and D150
Power circuit connections											
Screw clamp terminal connections											
Tightening			Screw clamp terminals					Connector 2 inputs	Screw clamp terminals	Connector 1 input	Connector 2 inputs
Flexible cable without cable end	1 conductor	mm ²	1...4	1.5...6	2.5...10			2.5...10	1...35	4...50	10...120
	2 conductors	mm ²	1...4	1.5...6	2.5...10			2.5...10	1...25 and 1...35	4...25	10...120 + 10...50
Flexible cable with cable end	1 conductor	mm ²	1...4	1...6	1...10			2.5...10	1...35	4...50	10...120
	2 conductors	mm ²	1...2.5	1...4	1.5...6			2.5...10	1...25 and 1...35	4...16	10...120 + 10...50
Solid cable without cable end	1 conductor	mm ²	1...4	1.5...6	1.5...10			2.5...16	1...35	4...50	10...120
	2 conductors	mm ²	1...4	1.5...6	2.5...10			2.5...16	1...25 and 1...35	4...25	10...120 + 10...50
Screwdriver	Philips		N° 2	N° 2	N° 2			N° 2	–	–	–
	Flat screwdriver Ø		Ø 6	Ø 6	Ø 6			Ø 6	–	Ø 6...Ø 8	–
Hexagonal key			–	–	–			–	4	4	4
Tightening torque		N.m	1.7	1.7	2.5			1.8	5: ≤ 25 mm ² 8: 35 mm ²	9	12
Spring terminal connections (2)											
Flexible cable without cable end	1 conductor	mm ²	2.5 (4: DT25)	4	4	4	–	10	–	–	–
	2 conductors	mm ²	2.5 (except DT25)	4	4	4	–	–	–	–	–
Connection by bars or lugs											
Bar c.s.a.			–	–	–	–	–	–	–	3 x 16	5 x 25
Lug external Ø		mm	8	8	10	10	8	16.5	17	25	–
Ø of screw		mm	M3.5	M3.5	M4	M4	M3.5	M6	M6	M8	–
Screwdriver	Philips		N° 2	N° 2	N° 2	N° 2	N° 2	–	–	–	–
	Flat screwdriver Ø		Ø 6	Ø 6	Ø 6	Ø 6	Ø 6	–	Ø 8	–	–
Key for hexagonal headed screw			–	–	–	–	–	10	10	13	–
Tightening torque		N.m	1.7	1.7	2.5	2.5	1.8	6	9	12	–
Control circuit connections											
Connection by cable (tightening via screw clamps)											
Flexible cable without cable end	1 conductor	mm ²	1...4	1...4	1...4	1...4	1...4	1...4	1...4	1...4	1...2.5
	2 conductors	mm ²	1...4	1...4	1...4	1...4	1...4	1...4	1...4	1...4	1...2.5
Flexible cable with cable end	1 conductor	mm ²	1...4	1...4	1...4	1...4	1...4	1...4	1...4	1...2.5	1...2.5
	2 conductors	mm ²	1...2.5	1...2.5	1...2.5	1...2.5	1...2.5	1...2.5	1...2.5	1...2.5	1...2.5
Solid cable without cable end	1 conductor	mm ²	1...4	1...4	1...4	1...4	1...4	1...4	1...4	1...4	1...2.5
	2 conductors	mm ²	1...4	1...4	1...4	1...4	1...4	1...4	1...4	1...4	1...2.5
Screwdriver	Philips		N° 2	N° 2	N° 2	N° 2	N° 2	N° 2	N° 2	N° 2	N° 2
	Flat screwdriver Ø		Ø 6	Ø 6	Ø 6	Ø 6	Ø 6	Ø 6	Ø 6	Ø 6	Ø 6
Tightening torque		N.m	1.7	1.7	1.7	1.7	1.7	1.7	1.7	1.2	1.2
Spring terminal connections (2)											
Flexible cable without cable end	1 conductor	mm ²	2.5	2.5	2.5	2.5	–	2.5	0.75...2.5	–	–
	2 conductors	mm ²	2.5	2.5	2.5	2.5	–	2.5	0.75...2.5	–	–
Connection by bars or lugs											
Lug external Ø		mm	8	8	8	8	8	8	8	8	8
Ø of screw		mm	M3.5	M3.5	M3.5	M3.5	M3.5	M3.5	M3.5	M3.5	M3.5
Screwdriver	Philips		N° 2	N° 2	N° 2	N° 2	N° 2	N° 2	N° 2	N° 2	N° 2
	Flat screwdriver Ø		Ø 6	Ø 6	Ø 6	Ø 6	Ø 6	Ø 6	Ø 6	Ø 6	Ø 6
Tightening torque		N.m	1.7	1.7	1.7	1.7	1.7	1.7	1.7	1.2	1.2

(1) BTR screws: hexagon socket head. In accordance with local electrical wiring regulations, a size 4 insulated Allen key must be used (reference LAD ALLEN4, see page 5/85).

(2) If cable ends are used, choose the next size down (example: for 2.5 mm², use 1.5 mm²) and square crimp the cable ends using a special tool.

Contactor type	LC1	D09 (3P)	DT20 D098	D12 (3P)	DT25 D128	D18 (3P)	DT32 D188	D25 (3P)	DT40 D258	
Pole characteristics										
Rated operational current (Ie) (Ue ≤ 440 V)	In AC-3, θ ≤ 60 °C	A	9	12	18	25				
	In AC-1, θ ≤ 60 °C	A	25 (1)	20	25 (1)	25	32 (1)	32	40 (1)	40
Rated operational voltage (Ue)	Up to	V	690	690	690	690				
Frequency limits	Of the operational current	Hz	25...400	25...400	25...400	25...400				
Conventional thermal current (Ith)	θ ≤ 60 °C	A	25 (1)	20	25 (1)	25	32 (1)	32	40 (1)	40
Rated making capacity (440 V)	Conforming to IEC 60947	A	250	250	300	450				
Rated breaking capacity (440 V)	Conforming to IEC 60947	A	250	250	300	450				
Permissible short time rating No current flowing for preceding 15 minutes with θ ≤ 40 °C	For 1 s	A	210	210	240	380				
	For 10 s	A	105	105	145	240				
	For 1 min	A	61	61	84	120				
	For 10 min	A	30	30	40	50				
Fuse protection against short-circuits (U ≤ 690 V)	Without thermal overload relay, gG fuse	type 1	A	25	40	50	63			
		type 2	A	20	25	35	40			
	With thermal overload relay	A	See pages 6/20 to 6/22, for aM or gG fuse ratings corresponding to the associated thermal overload relay							
Average impedance per pole	At Ith and 50 Hz	mΩ	2.5	2.5	2.5	2				
Power dissipation per pole for the above operational currents	AC-3	W	0.20	0.36	0.8	1.25				
	AC-1	W	1.56	1.56	2.5	3.2				

Control circuit characteristics, a.c. supply

Rated control circuit voltage (Uc)	50/60 Hz	V	12...690			
Control voltage limits						
50 or 60 Hz coils	Operation		–			
	Drop-out		–			
50/60 Hz coils	Operation		0.8...1.1 Uc on 50 Hz and 0.85...1.1 Uc on 60 Hz at 60 °C			
	Drop-out		0.3...0.6 Uc at 60 °C			
Average consumption at 20 °C and at Uc	~ 50 Hz	Inrush	50 Hz coil	VA	–	
			Cos φ		0.75	
		Sealed	50 Hz coil	VA	70	
			Cos φ		0.3	
		~ 60 Hz	Inrush	50/60 Hz coil	VA	7
				Cos φ		0.75
	Sealed		60 Hz coil	VA	–	
			Cos φ		0.3	
	50/60 Hz coil		VA	7.5		
			Cos φ		0.3	
	Heat dissipation	50/60 Hz	W	2...3		
	Operating time (2)	Closing "C"	ms	12...22		
Opening "O"		ms	4...19			
Mechanical durability in millions of operating cycles	50 or 60 Hz coil		–			
	50/60 Hz coil on 50 Hz		15			
Maximum operating rate at ambient temperature ≤ 60 °C	In operating cycles per hour		3600			

(1) Versions with spring terminal connections:

16 A for LC1 D093 and LC1 D123 (20 A possible with 2 x 2.5 mm² in parallel),

25 A for LC1 D183 to LC1 D323 (32 A possible for LC1 D183 connected with 2 x 4 mm² cables in parallel; 40 A possible for LC1 D253 and LC1 D323 connected with 2 x 4 mm² in parallel).

(2) The closing time "C" is measured from the moment the coil supply is switched on to closure of the main poles. The opening time "O" is measured from the moment the coil supply is switched off to the moment the main poles separate.

D32	D38	D40A	DT60A	D50A	D65A	DT80A	D80	D95	D115	D150	
32	38	40	–	50	65	–	80	95	115	150	
50 (1)	50	60	60	80	80	80	125	125	200	200	
690	690	690	690	690	690	690	1000	1000	1000	1000	
25...400	25...400	25...400	25...400	25...400	25...400	25...400	25...400	25...400	25...400	25...400	
50	50	60	60	80	80	80	125	125	200	200	
550	550	800	800	900	1000	1000	1100	1100	1260	1660	
550	550	800	800	900	1000	1000	1100	1100	1100	1400	
430	430	720	720	810	900	900	990	1100	1100	1400	
260	310	320	320	400	520	520	640	800	950	1200	
138	150	165	165	208	260	260	320	400	550	580	
60	60	72	72	84	110	110	135	135	250	250	
63	63	80	80	100	125	125	200	200	250	315	
63	63	80	80	100	125	125	160	160	200	250	
See pages 6/20 to 6/22 for aM or gG fuse ratings corresponding to the associated thermal overload relay											
2	2	1.5	1.6	1.5	1.5	1.6	0.8	0.8	0.6	0.6	
2	3	2.4	–	3.7	6.3	–	5.1	7.2	7.9	13.5	
5	5	5.4	5.8	9.6	9.6	10.2	12.5	12.5	24	24	
12...690		12...690							24...500		
–		–							0.85...1.1 Uc at 55 °C		
–		–							0.3...0.6 Uc at 55 °C		0.3...0.5 Uc at 55 °C
0.8...1.1 Uc on 50 Hz and 0.85...1.1 Uc on 60 Hz at 60 °C		0.8...1.1 Uc on 50 Hz and 0.85...1.1 Uc on 60 Hz at 60 °C							0.8...1.1 Uc on 50 Hz and 0.85...1.1 Uc on 60 Hz at 55 °C		0.8...1.15 Uc on 50/60 Hz at 55 °C
0.3...0.6 Uc at 60 °C		0.3...0.6 Uc at 60 °C							0.3...0.6 Uc at 55 °C		0.3...0.5 Uc at 55 °C
–		–							200		300
0.75		0.75							0.75		0.8
70		160							245		280...350
–		–							20		22
0.3		0.3							0.3		0.3
7		15							26		2...18
–		–							220		300
0.75		0.75							0.75		0.8
70		140							245		280...350
–		–							22		22
0.3		0.3							0.3		0.3
7.5		13							26		2...18
2...3		4...5							6...10		3...8
12...22		12...26		12...26		12...26		20...35		20...35	
4...19		4...19		4...19		4...19		6...20		6...20	
–		–							10		8
15		6		6		6		4		4	
3600		3600		3600		3600		3600		3600	
										2400	
										1200	

Contactor type			LC1 D09...D38 LC1 DT20...DT40	LC1 D40A...D65A LC1 DT60A and DT80A	LC1 or LP1 D80 LC1 D95	LC1 D115 and LC1 D150	
d.c. control circuit characteristics							
Rated control circuit voltage (Uc)	---	V	12...440	12...440		24...440	
Rated insulation voltage	Conforming to IEC 60947-1	V	690				
	Conforming to UL, CSA	V	600				
Control voltage limits	Operation	Standard coil	0.7...1.25 Uc at 60 °C	0.75...1.25 Uc at 60 °C	0.85...1.1 Uc at 55 °C	0.75...1.2 Uc at 55 °C	
		Wide range coil	–	–	0.75...1.2 Uc at 55 °C	–	
	Drop-out		0.1...0.25 Uc at 60 °C	0.1...0.3 Uc at 60 °C	0.1...0.3 Uc at 55 °C	0.15...0.4 Uc at 55 °C	
Average consumption at 20 °C and at Uc	---	Inrush	W	5.4	19	22	270...365
		Sealed	W	5.4	7.4	22	2.4...5.1
Operating time (1) average at Uc	Closing	"C"	ms	63 ± 15 %	50 ± 15%	95...130	20...35
	Opening	"O"	ms	20 ± 20 %	20 ± 20%	20...35	40...75
			Note: The arcing time depends on the circuit switched by the poles. For all normal 3-phase applications, the arcing time is less than 10 ms. The load is isolated from the supply after a time equal to the sum of the opening time and the arcing time.				
Time constant (L/R)		ms	28	34	75	25	
Mechanical durability at Uc	In millions of operating cycles		30	10	10	8	
Maximum operating rate at ambient temperature ≤ 60 °C	In operating cycles per hour		3600	3600	3600	1200	
Low consumption control circuit characteristics							
Rated insulation voltage	Conforming to IEC 60947-1	V	690	–			
	Conforming to UL, CSA	V	600	–			
Maximum voltage	Of the control circuit on ---	V	250	–			
Average consumption d.c. at 20 °C and at Uc	Wide range coil (0.7...1.25 Uc)	Inrush	W	2.4	–		
		Sealed	W	2.4	–		
Operating time (1) at Uc and at 20 °C	Closing	"C"	ms	77 ± 15 %	–		
	Opening	"O"	ms	25 ± 20 %	–		
Voltage limits (θ ≤ 60 °C) of the control circuit	Operation			0.8 to 1.25 Uc	–		
	Drop-out			0.1...0.3 Uc	–		
Time constant (L/R)		ms	40	–			
Mechanical durability	In millions of operating cycles		30	–			
Maximum operating rate at ambient temperature ≤ 60 °C	In operating cycles per hour		3600	–			

(1) The operating times depend on the type of contactor electromagnet and its control mode.

The closing time "C" is measured from the moment the coil supply is switched on to initial contact of the main poles.

The opening time "O" is measured from the moment the coil supply is switched off to the moment the main poles separate

Characteristics of auxiliary contacts incorporated in the contactor

Mechanically linked contacts	Conforming to IEC 60947-5-1		Each contactor has 2 N/O and N/C contacts mechanically linked on the same movable contact holder
Mirror contact	Conforming to IEC 60947-4-1		The N/C contact on each contactor represents the state of the power contacts and can be connected to a PREVENTA safety module
Rated operational voltage (U_e)	Up to	V	690
Rated insulation voltage (U_i)	Conforming to IEC 60947-1	V	690
	Conforming to UL, CSA	V	600
Conventional thermal current (I_{th})	For ambient temperature ≤ 60 °C	A	10
Frequency of the operational current		Hz	25...400
Minimum switching capacity λ = 10⁻⁸	U min	V	17
	I min	mA	5
Short-circuit protection	Conforming to IEC 60947-5-1		gG fuse: 10 A
Rated making capacity	Conforming to IEC 60947-5-1, I _{rms}	A	~: 140, ---: 250
Short-time rating	Permissible for	1 s	A 100
		500 ms	A 120
		100 ms	A 140
Insulation resistance		MΩ	> 10
Non-overlap time	Guaranteed between N/C and N/O contacts	ms	1.5 (on energisation and on de-energisation)

Operational power of contacts
conforming to IEC 60947-5-1

a.c. supply, categories AC-14 and AC-15
Electrical durability (valid for up to 3600 operating cycles/hour) on an inductive load such as the coil of an electromagnet: making current (cos φ 0.7) = 10 times the power broken (cos φ 0.4).

d.c. supply, category DC-13
Electrical durability (valid for up to 1200 operating cycles/hour) on an inductive load such as the coil of an electromagnet, without economy resistor, the time constant increasing with the load.

1 million operating cycles	
3 million operating cycles	
10 million operating cycles	

V	24	48	115	230	400	440	600
VA	60	120	280	560	960	1050	1440
VA	16	32	80	160	280	300	420
VA	4	8	20	40	70	80	100

V	24	48	125	250	440
W	96	76	76	76	44
W	48	38	38	32	-
W	14	12	12	-	-

AC-15

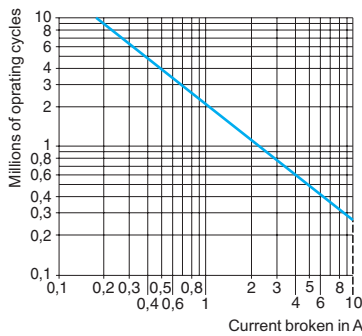

DC-13

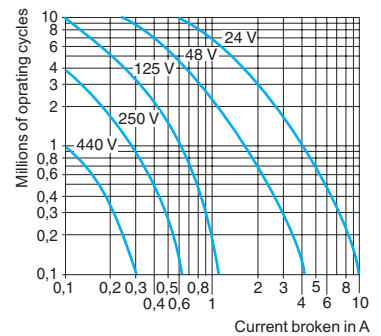

TeSys contactors

Auxiliary contact blocks without dust and damp protected contacts for TeSys D contactors

Contact block type		LAD N or LAD C	LAD T and LAD S	LAD R	LAD 8	
Environment						
Conforming to standards		IEC 60947-5-1, NF C 63-140, VDE 0660, BS 4794, EN 60947-5-1				
Product certifications		UL, CSA				
Protective treatment	Conforming to IEC 60068	"TH"				
Degree of protection	Conforming to VDE 0106	Protection against direct finger contact IP 2X				
Ambient air temperature around the device	Storage	°C	- 60...+ 80			
	Operation	°C	- 5...+ 60			
	Permissible for operation at Uc	°C	- 40...+ 70			
Maximum operating altitude	Without derating	m	3000			
Connection by cable	Phillips N° 2 and Ø 6 mm Flexible or solid cable with or without cable end	mm²	Min: 1 x 1; max: 2 x 2.5			
Spring terminal connections	Flexible or solid cable without cable end	mm²	Max: 2 x 2.5			
Instantaneous and time delay contact characteristics						
Number of contacts			1, 2 or 4	2	2	2
Rated operational voltage (Ue)	Up to	V	690			
Rated insulation voltage (Ui)	Conforming to IEC 60947-5-1	V	690			
	Conforming to UL, CSA	V	600			
Conventional thermal current (Ith)	For ambient temperature ≤ 60 °C	A	10			
Frequency of the operational current		Hz	25...400			
Minimum switching capacity	U min	V	17			
	I min	mA	5			
Short-circuit protection	Conforming to IEC 60947-5-1 and VDE 0660. gG fuse	A	10			
Rated making capacity	Conforming to IEC 60947-5-1	A	~: 140; ∴: 250			
Short-time rating	Permissible for	1 s	A	100		
		500 ms	A	120		
		100 ms	A	140		
Insulation resistance		MΩ	> 10			
Non-overlap time	Guaranteed between N/C and N/O contacts	ms	1.5 (on energisation and on de-energisation)			
Overlap time	Guaranteed between N/C and N/O contacts on LAD C22	ms	1.5	–	–	–
Time delay (LADT, R and S contact blocks) Accuracy only valid for setting range indicated on the front face	Ambient air temperature for operation	°C	–	- 40...+ 70	- 40...+ 70	–
	Repeat accuracy		–	± 2 %	± 2 %	–
	Drift up to 0.5 million operating cycles		–	+ 15 %	+ 15 %	–
	Drift depending on ambient air temperature		–	0.25 % per °C	0.25 % per °C	–
Mechanical durability	In millions of operating cycles		30	5	5	30
Operational power of contacts			See page 5/58			

5

Contact block type			LA1 DX	LA1 DZ		LA1 DY
				Protected	Non protected	
Environment						
Conforming to standards			IEC60947-5-1, VDE0660			
Product certifications			UL, CSA			
Protective treatment	Conforming to IEC 60068		"TH"			
Degree of protection	Conforming to VDE 0106		Protection against direct finger contact IP 2X			
Ambient air temperature	Storage and operation	°C	- 25...+ 70			
Cabling	Phillips N° 2 and Ø 6 mm Flexible or solid conductor with or without cable end	mm ²	Min: 1 x 1; max: 2 x 2.5			
Number of contacts			2	2	2	2
Contact characteristics						
Rated operational voltage (U _e)	Up to	V	50	50	690	24
Rated insulation voltage (U _i)	Conforming to IEC 60947-5-1	V	250	250	690	250
	Conforming to UL, CSA	V	–	–	600	–
Conventional thermal current (I _{th})	For ambient temperature ≤ 40 °C	A	–	–	10	–
Maximum operational current (I _e)		mA	500	500	–	50
Frequency of the operational current		Hz	–	–	25...400	–
Minimum switching capacity	U min	V	3	3	3	3
	I min	mA	0.3	0.3	0.3	0.3
Short-circuit protection	Conforming to IEC 60947-5-1 gG fuse	A	–	–	10	–
Rated making capacity	Conforming to IEC 60947-5-1	I rms	A	–	–	~:140; ∴: 250
Short-time rating	Permissible for	1 s	A	–	–	100
		500 ms	A	–	–	120
		100 ms	A	–	–	140
Insulation resistance		MΩ	> 10	> 10	> 10	> 10
Mechanical durability	In millions of operating cycles		5	5	30	5
Materials and technology used for dust and damp protected contacts			Silver - Single break	Silver - Single break	–	Gold - Single break with crossed bars

Rated operational power of contacts (conforming to IEC 60947-5-1)

a.c. supply, categories AC-14 and AC-15

Electrical durability (valid for up to 3600 operating cycles/hour) on an inductive load such as the coil of an electromagnet: making current ($\cos \varphi 0.7$) = 10 times the power broken ($\cos \varphi 0.4$).

	V	24	48	115	230	400	440	600
1 million operating cycles	VA	60	120	280	560	960	1050	1440
3 million operating cycles	VA	16	32	80	160	280	300	420
10 million operating cycles	VA	4	8	20	40	70	80	100

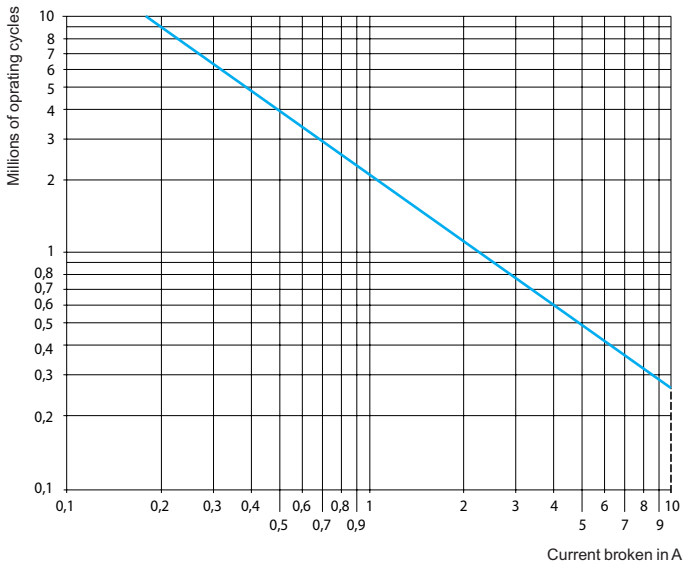

d.c. supply, category DC-13

Electrical durability (valid for up to 1200 operating cycles/hour) on an inductive load such as the coil of an electromagnet, without economy resistor, the time constant increasing with the load.

	V	24	48	125	250	440
1 million operating cycles	W	120	90	75	68	61
3 million operating cycles	W	70	50	38	33	28
10 million operating cycles	W	25	18	14	12	10

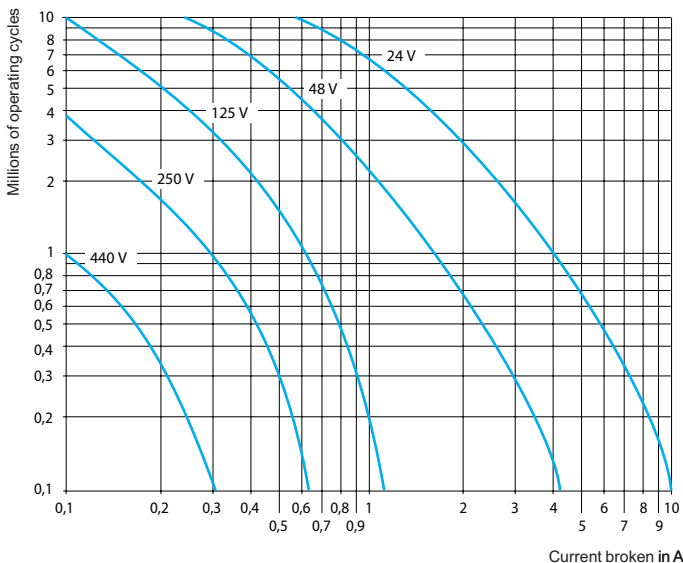

Environment			
Conforming to standards			IEC 60947-5-1
Product certifications			UL, CSA
Protective treatment	Conforming to IEC 60068		"TH"
Degree of protection	Conforming to VDE 0106		Protection against direct finger contact IP 2X
Ambient air temperature around the device	Storage	°C	-40...+80
	Operation	°C	-25...+55
	Permissible for operation at U _c	°C	-25...+70

Suppressor modules						
Module type			LA4 DA, LAD 4RC, LAD 4RC3	LA4 DB, LAD 4T, LAD 4T3	LA4 DC, LAD 4D3	LA4 DE, LAD 4V, LAD 4V3
Type of protection			RC circuit	Bidirectional peak limiting diode	Diode	Varistor
Rated control circuit voltage (U _c)		V	~ 24...415	~ or --- 24...440	--- 12...250	~ or --- 24...250
Maximum peak voltage			3 U _c	2 U _c	U _c	2 U _c
Natural RC frequency	24/48 V	Hz	400	–	–	–
	50/127 V	Hz	200	–	–	–
	110/240 V	Hz	100	–	–	–
	380/415 V	Hz	150	–	–	–

Mechanical latch blocks (1)						
Mechanical latch block type			LAD 6K10		LA6 DK20	
For use on contactor			LC1 D09...D65A DT20...DT80A		LC1 D80...D150 LP1 D80 and LC1 D115	
Product certifications			UL, CSA		UL, CSA	
Rated insulation voltage	Conforming to IEC 60947-5-1	V	690		690	
Rated control circuit voltage	~ 50/60 Hz and ---	V	24...415		24...415	
Power required	For unlatching	~	VA	25		25
		---	W	30		30
Maximum operating rate	In operating cycles/hour		1200		1200	
On-load factor			10 %		10 %	
Mechanical durability at U _c	In millions of operating cycles		0.5		0.5	

(1) Unlatching can be manually operated or electrically controlled (pulsed).
 The LA6 DK or LAD 6K latch coil and the LC1 D operating coil must not be energised simultaneously.
 The duration of the LA6 DK or LAD 6K and LC1 D control signals must be ≥ 100 ms.

Module type		LA4 DT (On-delay)	
Environment			
Conforming to standards		IEC 60255-5	
Product certifications		UL, CSA	
Protective treatment	Conforming to IEC 60068		"TH"
Degree of protection	Conforming to VDE 0106		Protection against direct finger contact IP 2X
Ambient air temperature around the device	Storage	°C	- 40...+ 80
	Operation	°C	- 25...+ 55
	For operation at U _c	°C	- 25...+ 70
Rated insulation voltage (U_i)	Conforming to IEC 60947-1	V	250
Cabling	Phillips n° 2 and Ø 6 mm Flexible or solid conductor with or without cable end	mm²	Min: 1 x 1; max: 2 x 2.5
Control circuit characteristics			
Built-in protection	Of the input		By varistor
	Contactors coil suppression		By varistor
Rated control circuit voltage (U_c)		V	~ or --- : 24...250
Permissible variation			0.8...1.1 U _c
Type of control			By mechanical contact only
Timing characteristics			
Timing ranges		s	0.1...2; 1.5...30; 25...500
Repeat accuracy	0...40 °C		± 3 % (10 ms minimum)
Reset time	During time delay period	ms	150
	After time delay period	ms	50
Immunity to microbreaks	During time delay period	ms	10
	After time delay period	ms	2
Minimum control pulse duration		ms	-
Time delay signalling	By LED		Illuminates during time delay period
Switching characteristics (solid state type)			
Maximum power dissipated		W	2
Leakage current		mA	< 5
Residual voltage		V	3.3
Overvoltage protection			3 kV; 0.5 joule
Electrical durability	In millions of operating cycles		30
Function diagram			
Electronic on-delay timer LA4 DT			

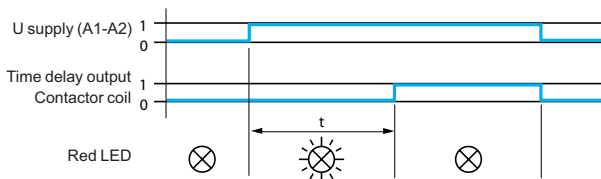

Environment						
Conforming to standards			IEC 60255-5			
Product certifications			UL, CSA			
Protective treatment	Conforming to IEC 60068		"TH"			
Degree of protection	Conforming to VDE 0106		Protection against direct finger contact IP 2X			
Ambient air temperature around the device	Storage	°C	-40...+80			
	Operation	°C	-25...+55			
	Permissible for operation at U _c	°C	-25...+70			
Other characteristics						
Module type			LA4 DFB With relay	LA4 DWB Solid state		
Conventional thermal current (I _{th})	For ambient temperature ≤ 50 °C	A	8			
Rated insulation voltage	Conforming to IEC 60947-5-1	V	250			
Rated operational voltage	Conforming to IEC 60947-5-1	V	250			
Indication of input state			By integral LED which illuminates when the contactor coil is energised			
Input signals	Control voltage (E1-E2)	V	~ 24	~ 24		
	Permissible variation	V	17...30	5...30		
	Current consumption at 20 °C	mA	25	8.5 for 5 V 15 for 24 V		
	State "0" guaranteed for U	V	< 2.4	< 2.4		
	I	mA	< 2	< 2		
State "1" guaranteed for U	V	17	5			
Built-in protection	Against reversed polarity		By diode			
	Of the input		By diode			
Electrical durability at 220 A/240 V	In millions of operating cycles		10	20		
Maximum immunity to microbreaks		ms	4	1		
Power dissipated	At 20 °C	W	0.6	0.4		
Direct mounting on contactor	With coil	~ 24...250 V	LC1 D80...D150	-		
		~ 100...250 V	-	LC1 D80...D115		
		~ 380...415 V	-	-		
Mounting with cabling adapter LAD 4BB	With coil	~ 24...250 V	LC1 D09...D38, LC1 DT20...DT40	LC1 D09...D38, LC1 DT20...DT40		
		~ 380...415 V	-	-		
Mounting with cabling adapter LAD 4BB3	With coil	~ 24...250 V	LC1 D40A...D65A	LC1 D40A...D65A		
		~ 380...415 V	LC1 D40A...D65A	LC1 D40A...D65A		
Total operating time at U _c (of the contactor)	The operating times depend on the type of contactor electromagnet and its control mode. The closing time "C" is measured from the moment the coil supply is switched on to initial contact of the main poles. The opening time "O" is measured from the moment the coil supply is switched off to the moment the main poles separate.					
			LC1 D09...D38, LC1 DT20...DT40	LC1 D40A...D65A	LC1 D80 and D95	
	With LA4 DFB	"C"	ms	20...30	28...34	28...43
		"O"	ms	16...24	20...24	18...32
Cabling	Phillips N° 2 and Ø 6 mm Flexible or solid cable with or without cable end	mm ²	Min: 1 x 1; max: 2 x 2.5			

TeSys contactors

TeSys D contactors for motor control
up to 75 kW at 400 V, in category AC-3
For connection by screw clamp terminals and lugs



LC1 D09●●



LC1 D25●●



LC1 D65A●●



LC1 D95●●



LC1 D115●●

3-pole contactors

Standard power ratings of 3-phase motors 50-60 Hz in category AC-3 ($\theta \leq 60^\circ\text{C}$)							Rated oper- ational current in AC-3 440 V up to	Instan- taneous auxiliary contacts	Basic reference, to be completed by adding the control voltage code (2)	Weight (3)
220 V	380 V	415 V	440 V	500 V	660 V	1000 V	9 12 18 25 32 38	1 1 1 1 1 1	Fixing (1)	
230 V	400 V			690 V						

kW	kW	kW	kW	kW	kW	kW	A				kg
----	----	----	----	----	----	----	---	--	--	--	----

Connection by screw clamp terminals

2.2	4	4	4	5.5	5.5	-	9	1	1	LC1 D09●●	0.320
3	5.5	5.5	5.5	7.5	7.5	-	12	1	1	LC1 D12●●	0.325
4	7.5	9	9	10	10	-	18	1	1	LC1 D18●●	0.330
5.5	11	11	11	15	15	-	25	1	1	LC1 D25●●	0.370
7.5	15	15	15	18.5	18.5	-	32	1	1	LC1 D32●●	0.375
9	18.5	18.5	18.5	18.5	18.5	-	38	1	1	LC1 D38●●	0.380

Power connections by EverLink® BTR screw connectors (4) and control by spring terminals

11	18.5	22	22	22	30	-	40	1	1	LC1 D40A●● (5)	0.850
15	22	25	30	30	33	-	50	1	1	LC1 D50A●● (5)	0.855
18.5	30	37	37	37	37	-	65	1	1	LC1 D65A●● (5)	0.860

Connection by screw clamp terminals or connectors

22	37	45	45	55	45	45	80	1	1	LC1 D80●●	1.590
25	45	45	45	55	45	45	95	1	1	LC1 D95●●	1.610
30	55	59	59	75	80	65	115	1	1	LC1 D115●●	2.500
40	75	80	80	90	100	75	150	1	1	LC1 D150●●	2.500

Connection by lugs or bars

In the references selected above, insert a figure 6 before the voltage code.
Example: LC1 D09●● becomes LC1 D096●●.

Separate components

Auxiliary contact blocks and add-on modules: see pages 5/78 to 5/85

- (1) LC1 D09 to D65A: clip-on mounting on 35 mm rail AM1 DP or screw fixing.
LC1 D80 to D95: clip-on mounting on 35 mm rail AM1 DP or 75 mm rail AM1 DL or screw fixing.
LC1 D80 to D95: clip-on mounting on 75 mm rail AM1 DL or screw fixing.
LC1 D115 and D150: clip-on mounting on 2 x 35 mm rails AM1 DP or screw fixing.
- (2) Standard control circuit voltages (for other voltages, please consult your Regional Sales Office):

a.c. supply													
Volts	24	42	48	110	115	220	230	240	380	400	415	440	500

LC1 D09...D150 (D115 and D150 coils with built-in suppression as standard, by bi-directional peak limiting diode).

50/60 Hz	B7	D7	E7	F7	FE7	M7	P7	U7	Q7	V7	N7	R7	S7
----------	----	----	----	----	-----	----	----	----	----	----	----	----	----

LC1 D80...D115

50 Hz	B5	D5	E5	F5	FE5	M5	P5	U5	Q5	V5	N5	R5	S5
-------	----	----	----	----	-----	----	----	----	----	----	----	----	----

60 Hz	B6	-	E6	F6	-	M6	-	U6	Q6	-	-	R6	-
-------	----	---	----	----	---	----	---	----	----	---	---	----	---

d.c. supply

Volts	12	24	36	48	60	72	110	125	220	250	440
-------	----	----	----	----	----	----	-----	-----	-----	-----	-----

LC1 D09...D65A (coils with integral suppression device fitted as standard)

U 0.75...1.25 Uc	JD	BD	CD	ED	ND	SD	FD	GD	MD	UD	RD
------------------	----	----	----	----	----	----	----	----	----	----	----

LC1 D80...D95

U 0.85...1.1 Uc	JD	BD	CD	ED	ND	SD	FD	GD	MD	UD	RD
-----------------	----	----	----	----	----	----	----	----	----	----	----

U 0.75...1.2 Uc	JW	BW	CW	EW	-	SW	FW	-	MW	-	-
-----------------	----	----	----	----	---	----	----	---	----	---	---

LC1 D115 and D150 (coils with integral suppression device fitted as standard)

U 0.75...1.2 Uc	-	BD	-	ED	ND	SD	FD	GD	MD	UD	RD
-----------------	---	----	---	----	----	----	----	----	----	----	----

Low consumption

Volts	5	12	20	24	48	110	220	250
-------	---	----	----	----	----	-----	-----	-----

LC1 D09...D38 (coils with integral suppression device fitted as standard)

U 0.8...1.25 Uc	AL	JL	ZL	BL	EL	FL	ML	UL
-----------------	----	----	----	----	----	----	----	----

For other voltages between 5 and 690 V, see pages 5/86 to 5/91.

(3) The weights indicated are for contactors with a.c. control circuit. For d.c. or low consumption control circuit, add 0.160 kg from LC1 D09 to D38, 0.075 kg from LC1 D40A to D65A and 1 kg for LC1 D80 and D95.

(4) BTR screws: hexagon socket head. In accordance with local electrical wiring regulations, a size 4 insulated Allen key must be used (reference LAD ALLEN4, see page 5/85).

(5) For low consumption kit LA4 DBL (see page 5/83).

TeSys contactors

TeSys D contactors for motor control up to 30 kW at 400 V, in category AC-3
For connection by spring terminals

536221



LC1 D123●●

536222



LC1 D65A3●●

3-pole contactors

Standard power ratings of 3-phase motors 50-60 Hz in category AC-3 ($\theta \leq 60^\circ\text{C}$)							Rated operational current in AC-3 440 V up to	Instan-taneous auxiliary contacts	Basic reference, to be completed by adding the control voltage code (2)	Weight (3)	
220 V	380 V	415 V	440 V	500 V	660 V	1000 V					
230 V	400 V				690 V						
kW	kW	kW	kW	kW	kW	kW	A		Fixing (1)	kg	
Power and control connections by spring terminals											
2.2	4	4	4	5.5	5.5		9	1	1	LC1 D093●●	0.320
3	5.5	5.5	5.5	7.5	7.5		12	1	1	LC1 D123●●	0.325
4	7.5	9	9	10	10		18	1	1	LC1 D183●●	0.330
5.5	11	11	11	15	15		25	1	1	LC1 D253●●	0.370
7.5	15	15	15	18.5	18.5		32 (4)	1	1	LC1 D323●●	0.375

Power connections by EverLink® BTR screw connectors (5) and control by spring terminals

11	18.5	22	22	22	30		40	1	1	LC1 D40A3●● (6)	0.850
15	22	25	30	30	33		50	1	1	LC1 D50A3●● (6)	0.855
18.5	30	37	37	37	37		65	1	1	LC1 D65A3●● (6)	0.860

Connection by Faston connectors

These contactors are fitted with Faston connectors: 2 x 6.35 mm on the power poles and 1 x 6.35 mm on the coil and auxiliary terminals.

For contactors LC1 D09 and LC1 D12 only, replace the figure 3 with a 9 in the references selected above.

Example: LC1 D093●● becomes LC1 D099●●.

Separate components

Auxiliary contact blocks and add-on modules: see pages 5/78 to 5/85.

(1) LC1 D09 to D32: clip-on mounting on 35 mm rail AM1 DP or screw fixing.

(2) Standard control circuit voltages (for other voltages, please consult your Regional Sales Office):

a.c. supply

Volts	24	42	48	110	115	220	230	240	380	400	415	440
-------	----	----	----	-----	-----	-----	-----	-----	-----	-----	-----	-----

LC1 D09...D65A

50/60 Hz	B7	D7	E7	F7	FE7	M7	P7	U7	Q7	V7	N7	R7
----------	----	----	----	----	-----	----	----	----	----	----	----	----

d.c. supply

Volts	12	24	36	48	60	72	110	125	220	250	440
-------	----	----	----	----	----	----	-----	-----	-----	-----	-----

LC1 D09...D65A (coils with built-in suppression as standard, by bi-directional peak limiting diode)

U 0.75...1.25 Uc	JD	BD	CD	ED	ND	SD	FD	GD	MD	UD	RD
------------------	----	----	----	----	----	----	----	----	----	----	----

Low consumption

Volts ---	5	12	20	24	48	110	220	250
-----------	---	----	----	----	----	-----	-----	-----

LC1 D09...D32 (coils with integral suppression device fitted as standard)

U 0.8...1.25 Uc	AL	JL	ZL	BL	EL	FL	ML	UL
-----------------	----	----	----	----	----	----	----	----

For other voltages between 5 and 690 V, see pages 5/86 to 5/91.

(3) The weights indicated are for contactors with a.c. control circuit.

For d.c. or low consumption control circuit, add 0.160 kg from LC1 D09 to D32 and 0.075 kg from LC1 D40A to D65A.

(4) Must be wired with 2 x 4 mm² cables in parallel on the upstream side. On the downstream side, outgoing terminal block LAD 331 may be used (Quickfit technology, see page 1/197). When wired with a single cable, the product is limited to 25 A (11 kW/400 V motors).

(5) BTR screws: hexagon socket head. In accordance with local electrical wiring regulations, a size 4 insulated Allen key must be used (reference LAD ALLEN4, see page 5/85).

(6) For low consumption kit LA4 DBL (see page 5/83).

TeSys contactors

TeSys D, 3-pole contactors

for control in category AC-1, from 25 to 200 A

526230



LC1 D09●●

526231



LC1 D65A●●

5

3-pole contactors

Non inductive loads maximum current ($\theta \leq 60^\circ\text{C}$) utilisation category AC-1	Number of poles	Instantaneous auxiliary contacts	Basic reference, to be completed by adding the control voltage code (1)	Weight (3)
			Fixing (2)	

A					kg
Connection by screw clamp terminals					
25	3	1	1	LC1 D09●● or LC1 D12●●	0.320 0.325
32	3	1	1	LC1 D18●●	0.330
40	3	1	1	LC1 D25●●	0.370
50	3	1	1	LC1 D32●● or LC1 D38●●	0.375 0.380

Connection by EverLink®, BTR screw connectors (4)					
60	3	1	1	LC1 D40A●● (7)	0.850
80	3	1	1	LC1 D50A●● (7) or LC1 D65A●● (5) (7)	0.855 0.860

Connection by screw clamp terminals or connectors					
125	3	1	1	LC1 D80●● or LC1 D95●● (5)	1.590 1.610
200	3	1	1	LC1 D115●● or LC1 D150●● (6)	2.500 2.500

3-pole contactors for connection by lugs

In the references selected above, insert a figure 6 before the voltage code.
Example: LC1 D09●● becomes LC1 D096●●.

(1) Standard control circuit voltages (for other voltages, please consult your Regional Sales Office):

a.c. supply													
Volts	24	42	48	110	115	220	230	240	380	400	415	440	500
LC1 D09...D150 (coils D115 and D150 fitted with integral suppression device as standard)													
50/60 Hz	B7	D7	E7	F7	FE7	M7	P7	U7	Q7	V7	N7	R7	-
LC1 D80...D150													
50 Hz	B5	D5	E5	F5	FE5	M5	P5	U5	Q5	V5	N5	R5	S5
60 Hz	B6	-	E6	F6	-	M6	-	U6	Q6	-	-	R6	-
d.c. supply													
Volts	12	24	36	48	60	72	110	125	220	250	440		
LC1 D09...D65A (coils with integral suppression device fitted as standard)													
U 0.7...1.25 Uc	JD	BD	CD	ED	ND	SD	FD	GD	MD	UD	RD		
LC1 or LP1 D80 and D95													
U 0.85...1.1 Uc	JD	BD	CD	ED	ND	SD	FD	GD	MD	UD	RD		
U 0.75...1.2 Uc	JW	BW	CW	EW	-	SW	FW	-	MW	-	-		
LC1 D115 and D150 (coils with integral suppression device fitted as standard)													
U 0.75...1.2 Uc	-	BD	-	ED	ND	SD	FD	GD	MD	UD	RD		
Low consumption													
Volts	5	12	20	24	48	110	220	250					
LC1 D09...D38 (coils with integral suppression device fitted as standard)													
U 0.8...1.25 Uc	AL	JL	ZL	BL	EL	FL	ML	UL					

For other voltages between 5 and 690 V, see pages 5/86 to 5/91.

(2) LC1 D09 to D65A: clip-on mounting on 35 mm rail AM1 DP or screw fixing.

LC1 D80 and D95: clip-on mounting on 35 mm rail AM1 DP or 75 mm rail AM1 DL or screw fixing.

LC1 or LP1 D80 to D95: clip-on mounting on 75 mm rail AM1 DL or screw fixing.

LC1 D115 and D150: clip-on mounting on 2 x 35 mm rails AM1 DP or screw fixing.

(3) The weights indicated are for contactors with a.c. control circuit. For d.c. or low consumption control circuit, add 0.160 kg from LC1 D09 to D38, 0.075 kg from LC1 D40A to D65A and 1 kg for LC1 D80 and D95.

(4) BTR screws: hexagon socket head. In accordance with local electrical wiring regulations, a size 4 insulated Allen key must be used (reference LAD ALLEN4, see page 5/85).

(5) Selection according to the number of operating cycles, see AC-1 curve, page 5/198.

(6) 32 A with 2 x 4 mm² cables connected in parallel.

(7) For low consumption kit LA4 DBL (see page 5/83).

TeSys contactors

TeSys D, 3-pole contactors

For control in category AC-1, 25 to 200 A



LC1 D123●●



LC1 D65A3●●

3-pole contactors for connection by Faston connectors

These contactors are fitted with Faston connectors: 2 x 6.35 mm on the power poles and 1 x 6.35 mm on the coil terminals. For contactors LC1 D09 and LC1 D12 only, in the references selected from the previous page, insert a figure 9 before the voltage code. Example: **LC1 D09●●** becomes **LC1 D099●●**.

3-pole contactors

Non inductive loads maximum current ($\theta \leq 60^\circ\text{C}$) utilisation category AC-1	Number of poles	Instantaneous auxiliary contacts	Basic reference, to be completed by adding the control voltage code (1)	Weight (3)
			Fixing (2)	
A				kg
Connection by spring terminals				
16	3	1	1	LC1 D093●● (4) 0.320 or LC1 D123●● (4) 0.325
25	3	1	1	LC1 D183●● (5) 0.335 or LC1 D253●● (6) 0.325 or LC1 D323●● (6) 0.325
Power connections by EverLink® BTR screw connectors (7) and control by spring terminals				
60	3	1	1	LC1 D40A3●● (9) 0.850
80	3	1	1	LC1 D50A3●● (8) (9) 0.855 or LC1 D65A3●● (8) (9) 0.860

Separate components

Auxiliary contact blocks and add-on modules: see pages 5/78 to 5/85.

(1) Standard control circuit voltages (for other voltages, please consult your Regional Sales Office):

a.c. supply														
Volts	24	42	48	110	115	220	230	240	380	400	415	440	500	
LC1 D09...D65A														
50/60 Hz	B7	D7	E7	F7	FE7	M7	P7	U7	Q7	V7	N7	R7	S7	
d.c. supply														
Volts	12	24	36	48	60	72	110	125	220	250	440			
LC1 D09...D65A (coils with integral suppression device fitted as standard)														
U 0.75...1.25 U _c	JD	BD	CD	ED	ND	SD	FD	GD	MD	UD	RD			
Low consumption														
Volts	5	12	20	24	48	110	220	250						
LC1 D09...D38 (coils with integral suppression device fitted as standard)														
U 0.8...1.25 U _c	AL	JL	ZL	BL	EL	FL	ML	UL						

For other voltages between 5 and 690 V, see pages 5/86 to 5/91.

(2) **LC1 D09** to **D65A**: clip-on mounting on 35 mm rail **AM1 DP** or screw fixing.

(3) The weights indicated are for contactors with a.c. control circuit. For d.c. or low consumption control circuit, add 0.160 kg from **LC1 D09** to **D38** and 0.075 kg from **LC1 D40A** to **D65A**.

(4) 20 A with 2 x 2.5 mm² cables connected in parallel.

(5) 32 A with 2 x 4 mm² cables connected in parallel.

(6) 40 A with 2 x 4 mm² cables connected in parallel.

(7) BTR screws: hexagon socket head. In accordance with local electrical wiring regulations, a size 4 insulated Allen key must be used (reference **LAD ALLEN4**, see page 5/85).

(8) Selection according to the number of operating cycles, see AC-1 curve, page 5/198.

(9) For low consumption kit **LA4 DBL** (see page 5/83).

TeSys contactors

TeSys D, 4-pole contactors

For control in category AC-1, 25 to 200 A

506227



LC1 DT20●●

506228



LC1 DT80A●●

506229



LC1 D65008●●

4-pole contactors for connection by screw clamp terminals or connectors					Weight (3)
Non inductive loads maximum current (θ ≤ 60 °C) utilisation category AC-1	Number of poles	Instantaneous auxiliary contacts	Basic reference, to be completed by adding the control voltage code (1)		
			Fixing (2)		

A					kg
Connection by screw clamp terminals					
20	4	–	1	1	LC1 DT20●● 0.365
	2	2	1	1	LC1 D098●● 0.365
25	4	–	1	1	LC1 DT25●● 0.365
	2	2	1	1	LC1 D128●● 0.365
32	4	–	1	1	LC1 DT32●● 0.425
	2	2	1	1	LC1 D188●● 0.425
40	4	–	1	1	LC1 DT40●● 0.425
	2	2	1	1	LC1 D258●● 0.425
Connection by EverLink®, BTR screw connectors					
60	4	–	1	1	LC1 DT60A●● 1.090
80	4	–	1	1	LC1 DT80A●● 1.150
Connection by screw clamp terminals or connectors					
60	2	2	–	–	LC1 D40008●● 1.440
					or LP1 D40008●● 2.210
80	2	2	–	–	LC1 D65008●● 1.450
					or LP1 D65008●● 2.220
125	4	–	–	–	LC1 D80004●● 1.760
					or LP1 D80004●● 2.685
	2	2	–	–	LC1 D80008●● 1.840
					or LP1 D80008●● 2.910
200	4	–	–	–	LC1 D115004●● 2.860

4-pole contactors for connection by lugs or bars

In the references selected above, insert a figure 6 before the voltage code.
 Example: LC1 DT20●● becomes LC1 DT206●●.

(1) Standard control circuit voltages (for other voltages, please consult your Regional Sales Office):

a.c. supply													
Volts	24	42	48	110	115	220	230	240	380	400	415	440	500
LC1 D09...D150 and LC1 DT20...DT80A (coils D115 and D150 fitted with integral suppression device as standard)													
50/60 Hz	B7	D7	E7	F7	FE7	M7	P7	U7	Q7	V7	N7	R7	–
LC1 D80...D115													
50 Hz	B5	D5	E5	F5	FE5	M5	P5	U5	Q5	V5	N5	R5	S5
60 Hz	B6	–	E6	F6	–	M6	–	U6	Q6	–	–	R6	–
d.c. supply													
Volts	12	24	36	48	60	72	110	125	220	250	440		
LC1 D09...D65A and LC1 DT20...DT80A (coils with integral suppression device fitted as standard)													
U 0.7...1.25 Uc	JD	BD	CD	ED	ND	SD	FD	GD	MD	UD	RD		
LC1 or LP1 D80													
U 0.85...1.1 Uc	JD	BD	CD	ED	ND	SD	FD	GD	MD	UD	RD		
U 0.75...1.2 Uc	JW	BW	CW	EW	–	SW	FW	–	MW	–	–		
LC1 D115 (coils with integral suppression device fitted as standard)													
U 0.75...1.2 Uc	–	BD	–	ED	ND	SD	FD	GD	MD	UD	RD		
Low consumption													
Volts	5	12	20	24	48	110	220	250					
LC1 D09...D38 and LC1 DT20...DT40 (coils with integral suppression device fitted as standard)													
U 0.8...1.25 Uc	AL	JL	ZL	BL	EL	FL	ML	UL					

For other voltages between 5 and 690 V, see pages 5/86 to 5/91.

(2) LC1 D09 to D38 and LC1 DT20 to DT80A: clip-on mounting on 35 mm rail AM1 DP or screw fixing.

LC1 D80 ~: clip-on mounting on 35 mm rail AM1 DP or 75 mm rail AM1 DL or screw fixing.

LC1 or LP1 D80 ---: clip-on mounting on 75 mm rail AM1 DL or screw fixing.



LC1 D115 and D150: clip-on mounting on 2 x 35 mm rails AM1 DP or screw fixing.

(3) The weights indicated are for contactors with a.c. control circuit. For d.c. or low consumption control circuit, add 0.160 kg from LC1 D09 to D38, 0.075 kg from LC1 DT60A and D80A and 1 kg for LC1 D80.

TeSys contactors

TeSys D, 4-pole contactors

For control in category AC-1, 25 to 200 A

4-pole contactors						
Non inductive loads maximum current ($\theta \leq 60^\circ\text{C}$) utilisation category AC-1	Number of poles	Instan- taneous auxiliary contacts		Basic reference, to be completed by adding the voltage code (1)	Weight (3)	
					Fixing (2)	kg
A						
Connection by spring terminals						
20	4	–	1	1	LC1 DT203●●	0.380
	2	2	1	1	LC1 D0983●●	0.380
25	4	–	1	1	LC1 DT253●●	0.380
	2	2	1	1	LC1 D1283●●	0.380
32	4	–	1	1	LC1 DT323●●	0.425
	2	2	1	1	LC1 D1883●●	0.425
40	4	–	1	1	LC1 DT403●●	0.425
	2	2	1	1	LC1 D2583●●	0.425
Connection by by EverLink®, BTR screw connectors and control circuit by spring terminals						
60	4	–	1	1	LC1 DT60A3●●	1.090
80	4	–	1	1	LC1 DT80A3●●	1.150

Separate components

Auxiliary contact blocks and add-on modules: see pages 5/78 to 5/85.

(1) Standard control circuit voltages (for other voltages, please consult your Regional Sales Office):

a.c. supply													
Volts	24	42	48	110	115	220	230	240	380	400	415	440	500
LC1 D09...D25 and LC1 DT20...DT80A (coils with integral suppression device fitted as standard)													
50/60 Hz	B7	D7	E7	F7	FE7	M7	P7	U7	Q7	V7	N7	R7	–
d.c. supply													
Volts	12	24	36	48	60	72	110	125	220	250	440		
LC1 D09...D25 and LC1 DT20...DT80A (coils with integral suppression device fitted as standard)													
U 0.7...1.25 Uc	JD	BD	CD	ED	ND	SD	FD	GD	MD	UD	RD		
Low consumption													
Volts $\overline{\text{---}}$	5	12	20	24	48	110	220	250					
LC1 D09...D25 and LC1 DT20...DT40 (coils with integral suppression device fitted as standard)													
U 0.8...1.25 Uc	AL	JL	ZL	BL	EL	FL	ML	UL					

For other voltages between 5 and 690 V, see pages 5/86 to 5/91.

(2) LC1 D09 to D38 and LC1 DT20 to DT80A: clip-on mounting on 35 mm \perp rail AM1DP or screw fixing.

(3) The weights indicated are for contactors with a.c. control circuit. For d.c. or low consumption control circuit, add 0.160 kg from LC1 D09 to D38, 0.075 kg for LC1 DT60A and DT80A.

TeSys contactors

for the North American market,
conforming to UL and CSA

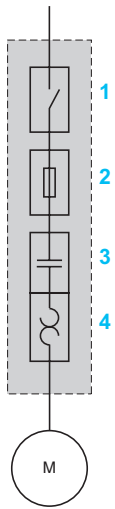

- 1 Motor Disconnect (Disconnect switch)
- 2 Motor Branch Circuit Protection (Short-circuit protection)
- 3 Motor Controller (Contactor)
- 4 Motor Overload Protection (Thermal overload relay)

Starters for the North American market

In recent years, the North American market has started to harmonise UL, CSA and ANCE standards, as well as the industrial installation codes provided by national regulations (NEC for the United States, CEC for Canada and MEC for Mexico). (1)

Major improvements, carried out by the Canena (2) are aimed at harmonising product requirements based on IEC (3) standards.

However, the North American codes use specific terminology for defining the functions of a starter.

These functions can be fulfilled by standard IEC products, accompanied by appropriate certifications.

Combination Starters

Combination Starters are the most common type of packaged motor starter. They are called "Combination" because of their structure and their combined functions.

The figure opposite shows the four combined functions that constitute a complete motor starter circuit, defined as a "Motor branch circuit" by the NEC (US National Electric Code) in article 430. Standard UL508 currently gives different types of combination starter that meet the requirements of a "Motor branch circuit".

Type E, called "**self-protected combination starter**", covers all these functions and can be controlled manually (thermal-magnetic circuit-breaker) or remotely (starter-controller). Type E starters withstand faults within their declared nominal rating without sustaining damage, after which they can be put back into service. In addition, they can withstand more severe short-circuit and durability performance tests without welding or excessive wear of the contact tips.

Type F, called "**Combination motor starter**", consists of a type E manual starter (thermal-magnetic circuit-breaker) combined with a contactor. These starters are evaluated by means of basic short-circuit tests, but are not considered as "self-protected".

For this combination, the type E starter must be marked "Combination Motor Controller when used with ...", followed by the reference of the load side contactor.

(1) **UL**: Underwriters Laboratories, **CSA**: Canadian Standards Association, **ACNE**: Association of Standardization and Certification, **NEC**: National Electric Code, **CEC**: Canadian Electrical Code, **MEC**: Mexican Electrical Code.

(2) **Canena**: Council for Harmonization of Electrotechnical Standardization of North America.

(3) **IEC**: International Electrotechnical Commission.

Control panels

To help users properly coordinate their motor control equipment with their distribution system in the event of a fault, article 409 of the 2005 NEC requires panel builders to list the short-circuit withstand rating of their motor control panels.

According to standard UL508A, manufacturers must use the short-circuit withstand value of the lowest rated device as the nominal withstand rating of the panel, unless the devices have been tested together for a higher coordinated rating.

The minimum “**short-circuit current rating**” (SCCR), on motor control components for horsepower ratings of 50 hp or below is 5 000 A.

Using a **type E** or **type F** combination starter eliminates the coordination problems of using individual components for the “motor branch circuit protection”, “motor controller” and “motor overload protection” functions.

The panel builder uses the declared short-circuit current rating for the combination starter. This value is generally higher than 5 000 A.

This makes it easier to list the short-circuit current ratings and to check the compatibility of a UL508A motor control panel within a given distribution system.

TeSys contactors

for the North American market,
conforming to UL and CSA

Group protection

Article 430.53 of the NEC allows a single short-circuit protection device to be used for more than one motor circuit if the components used are marked and listed for such use.

Components suitable for use in group protection, known as “**motor group installations**”, can be marked in one of the following two ways:

Case n° 1

The contactor and the motor overload relay are both listed as suitable for group installation.

An inverse time circuit-breaker can be used as the short-circuit protection device if it is also listed as suitable for group installation.

The panel builder must therefore make sure that the short-circuit protection device selected (fuses or inverse time circuit-breaker) does not exceed the value allowed by article 430.40 for the smallest overload relay used in the circuit.

Once these conditions have been met, the panel builder can reduce the size of the conductor connecting the short-circuit protection device to the individual motor contactor/overload relay, to one third of the size of the upstream circuit conductor supplying the protection device.

The panel builder must limit the length of the motor starter conductor (connecting the short-circuit protection device to the motor contactor/overload relay) to a maximum of 7.6 m (25 feet).

Case n° 2

The motor contactor and overload relay are listed as suitable for “**tap conductor protection**” in group installations.

This category allows the panel designer to reduce the size of the conductor connecting the short-circuit protection device to the individual motor contactor/overload relay, to one tenth of the size of the upstream circuit conductor supplying the protection device.

The designer must limit the length of this conductor to a maximum of 3.05 m (10 feet).

In both cases, the supply circuits must not be less than 125 % of the connected motor FLA (Full Load Amps) rating.

For panel builders, using **type F** combination starters in group installations simplifies group motor considerations.

Each starter is a fully coordinated motor branch circuit.

The panel builder follows the same NEC requirements for sizing the supply conductors as those required for single motor branch circuits.

The size of the supply conductors can be reduced in accordance with the specifications of article 430.28.

This allows the same flexibility in conductor sizing as that offered in article 430.53 (D), without a requirement to check the short-circuit protection rating marked on the components and the overload relay limit.

A UL508A panel does not need a short-circuit protection device when each motor starter installed is a **type F**.

The upstream short-circuit protection device supplying the starter protects the panel. The panel builder only has to consider the panel/enclosure disconnect requirements specified by the NEC or local codes.

TeSys contactors

for the North American market,
conforming to UL and CSA standards, 20 to 200 A



LC1 D09●●



LC1 D25●●



LC1 D65A●●



LC1 D95●●

Standard power ratings of motors 50/60 Hz						Size	Associated cable type 75 °C-Cu	Continuous current	Type of contactor required Basic reference, to be completed (1)
Single-phase 1 Ø		3-phase 3 Ø							
115 V	230 V	200 V	230 V	460 V	575 V				Fixing, connection (2)
	240 V	208 V	240 V	480 V	600 V				
HP	HP	HP	HP	HP	HP		A		

Connection by screw clamp terminals									
0,5	1	2	2	5	7.5	00	AWG10	20	LC1 D09●●
1	2	3	3	7.5	10	0	AWG10	25	LC1 D12●●
1	3	5	5	10	15	0	AWG8	32	LC1 D18●●
2	3	5	7.5	15	20	1	AWG6	40	LC1 D25●●
2	5	7.5	10	20	30	1	AWG6	50	LC1 D32●●

Power connections by EverLink® BTR screw connectors (4) and control by spring terminals									
3	5	10	10	30	30	2	AWG3	60	LC1 D40A●●
3	7.5	15	15	40	40	2	AWG3	70	LC1 D50A●●
5	10	20	20	40	50	2	AWG3	80	LC1 D65A●●

Connection by screw clamp terminals or connectors									
7.5	15	20	25	60	60	2	AWG2	110	LC1 D80●●
7.5	15	20	25	60	60	2	AWG2	110	LC1 D95●●
-	-	30	40	75	100	3	AWG2/0	175	LC1 D115●●
-	-	40	50	100	125	4	AWG3/0	200	LC1 D150●●

Applications with High-Fault Short-Circuit ratings

For contactors **LC1 D40A** to **LC1 D65A**, the High-Fault Short-Circuit ratings are 50 kA at 480 V and 25 kA at 600 V. If these contactors are used, stick the **LAD UL1** warning sticker on the enclosure door..

Description	Language	Sold in lots of	Reference
Warning sticker	English, Spanish, French	10	LAD UL1

Application example	
For a 15 HP-230 V motor	Select a contactor type LC1 D50A . Information: the contactor rating selected corresponds to "size 2", the associated cable is type AWG3 75 °C-Cu.

(1) Standard control circuit voltages (for other voltages, please consult your Regional Sales Office):

a.c. supply													
Volts	24	42	48	110	115	220	230	240	380	400	415	440	500
LC1 D09...D150 (D115 and D150 coils with integral suppression device fitted as standard)													
50/60 Hz	B7	D7	E7	F7	FE7	M7	P7	U7	Q7	V7	N7	R7	S7
LC1 D80...D115													
50 Hz	B5	D5	E5	F5	FE5	M5	P5	U5	Q5	V5	N5	R5	S5
60 Hz	B6	-	E6	F6	-	M6	-	U6	Q6	-	-	R6	-
d.c. supply													
Volts	12	24	36	48	60	72	110	125	220	250	440		
LC1 D09...D65A (coils with integral suppression device fitted as standard)													
U 0.7...1.25 Uc	JD	BD	CD	ED	ND	SD	FD	GD	MD	UD	RD		
LC1 D80 and D95													
U 0.85...1.1 Uc	JD	BD	CD	ED	ND	SD	FD	GD	MD	UD	RD		
U 0.75...1.2 Uc	JW	BW	CW	EW	-	SW	FW	-	MW	-	-		
LC1 D115 and D150 (coils with integral suppression device fitted as standard)													
U 0.75...1.2 Uc	-	BD	-	ED	ND	SD	FD	GD	MD	UD	RD		
Low consumption													
Volts ---	5	12	20	24	48	110	220	250					
LC1 D09...D38 (coils with integral suppression device fitted as standard)													
U 0.7...1.25 Uc	AL	JL	ZL	BL	EL	FL	ML	UL					

(2) **LC1 D09** to **D65A**: clip-on mounting on 35 mm L rail **AM1 DP** or screw fixing.
LC1 D80 and **LC1 D95**: clip-on mounting on 35 mm L rail **AM1 DP** or 75 mm L rail **AM1 DL** or screw fixing.
LC1 D115 and **D150**: clip-on mounting on 2 x 35 mm L rails **AM1 DP** or screw fixing.



TeSys contactors

TeSys D, 3-pole reversing contactors for motor control up to 75 kW at 400 V, in category AC-3
Horizontally mounted, pre-assembled

526172



LC2 D12●●

526173



LC2 D65A●●

526175



LC2 D115●●

3-pole reversing contactors for connection by screw clamp terminals

Pre-wired power connections.

Standard power ratings of 3-phase motors 50-60 Hz in category AC-3 ($\theta \leq 60^\circ\text{C}$)							Rated operational current in AC-3 440 V up to	Instantaneous auxiliary contacts per contactor	Contactors supplied with coil Basic reference, to be completed by adding the control voltage code (2)	Weight (3)
220 V	380 V	415 V	440 V	500 V	660 V	1000 V				
230 V	400 V				690 V				Fixing (1)	

kW	kW	kW	kW	kW	kW	kW	kW	A				kg
With mechanical interlock, without electrical interlocking, for connection by screw clamp terminals or connectors												
2.2	4	4	4	5.5	5.5	–	–	9	1	1	LC2 D09●● (4)	0.687
3	5.5	5.5	5.5	7.5	7.5	–	–	12	1	1	LC2 D12●● (4)	0.697
4	7.5	9	9	10	10	–	–	18	1	1	LC2 D18●● (4)	0.707
5.5	11	11	11	15	15	–	–	25	1	1	LC2 D25●● (4)	0.787
7.5	15	15	15	18.5	18.5	–	–	32	1	1	LC2 D32●● (4)	0.797
9	18.5	18.5	18.5	18.5	18.5	–	–	38	1	1	LC2 D38●● (4)	0.807
11	18.5	22	22	22	30	–	–	40	1	1	LC2 D40A●● (5)	1.870
15	22	25	30	30	33	–	–	50	1	1	LC2 D50A●● (5)	1.880
18.5	30	37	37	37	37	–	–	65	1	1	LC2 D65A●● (5)	1.890
22	37	45	45	55	45	–	–	80	1	1	LC2 D80●●	3.200
25	45	45	45	55	45	–	–	95	1	1	LC2 D95●●	3.200

With mechanical interlock and electrical interlocking, for connection by screw clamp terminals or connectors

30	55	59	59	75	80	65	–	115	1	1	LC2 D115●●	6.350
40	75	80	80	90	100	75	–	150	1	1	LC2 D150●●	6.400

Connection by lugs or bars

For reversing contactors LC2 D09 to LC2 D38, LC2 D115 and LC2 D150, in the references selected above, insert a figure 6 before the voltage code. Example: **LC2 D09●●** becomes **LC2 D096●●**.

To build a 40 to 65 A reversing contactor, for connection by lugs, order 2 contactors **LC1 D●●A6** and mechanical interlock **LAD 4CM** (see page 5/76).

Component parts

Auxiliary contact blocks and add-on modules: see pages 5/78 to 5/85.

- (1) LC2 D09 to D65A: clip-on mounting on 35 mm rail **AM1 DP** or screw fixing.
LC2 D80 and D95: clip-on mounting on 35 mm rail **AM1 DP** or 75 mm rail **AM1 DL** or screw fixing.
LC2 D115 and D150: clip-on mounting on 35 mm rail **AM1 DP** or screw fixing.

(2) Standard control circuit voltages (for other voltages between 16 and 690 V, please consult your Regional Sales Office):

a.c. supply													
Volts	24	42	48	110	115	220	230	240	380	400	415	440	500
LC2 D09...D150 (D115 and D150 coils with integral suppression device fitted as standard))													
50/60 Hz	B7	D7	E7	F7	FE7	M7	P7	U7	Q7	V7	N7	R7	S7
LC2 D80...D115													
50 Hz	B5	D5	E5	F5	FE5	M5	P5	U5	Q5	V5	N5	R5	S5
60 Hz	B6	–	E6	F6	–	M6	–	U6	Q6	–	–	R6	–
d.c. supply													
Volts	12	24	36	48	60	72	110	125	220	250	440		
LC2 D09...D65A (coils with integral suppression device fitted as standard)													
U 0.75...1.25 U _c	JD	BD	CD	ED	ND	SD	FD	GD	MD	UD	RD		
Low consumption													
Volts	5	12	20	24	48	110	220	250					
LC2 D09...D38 (coils with integral suppression device fitted as standard)													
U 0.8...1.25 U _c	AL	JL	ZL	BL	EL	FL	ML	UL					

For other voltages between 5 and 690 V, see pages 5/86 to 5/91.

(3) The weights indicated are for contactors with a.c. control circuit. For d.c. or low consumption control circuit, add 0.330 kg for **LC2 D09** to **D38**, 0.150 kg for **LC1 D40A** to **D65A**.

(4) For reversing contactors with electrical interlocking pre-wired at the factory, add suffix **V** to the references selected above. Example: **LC2 D09P7** becomes **LC2 D09P7V**.

(5) For low consumption kit **LA4 DBL** (see page 5/83).

Note: when assembling a reversing contactor, it is good practice to incorporate a 50 ms time delay.

TeSys contactors

TeSys D, 3-pole reversing contactors for motor control up to 15 kW at 400 V, in category AC-3
Horizontally mounted, pre-assembled

528174



LC2 D123●●

3-pole reversing contactors, for connection by spring terminals

Pre-wired power connections.
Mechanical interlock without electrical interlocking.

Standard power ratings of 3-phase motors 50-60 Hz in category AC-3 ($\theta \leq 60^\circ\text{C}$)							Rated operational current in AC-3 440 V up to	Instantaneous auxiliary contacts per contactor	Contactors supplied with coil Basic reference, to be completed by adding the voltage code (2)	Weight (3)
220 V	380 V	415 V	440 V	500 V	660 V					
230 V	400 V				690 V					
kW	kW	kW	kW	kW	kW	A			Fixing (1)	kg
For connection by spring terminals										
2.2	4	4	4	5.5	5.5	9	1	1	LC2 D093●●	0.687
3	5.5	5.5	5.5	7.5	7.5	12	1	1	LC2 D123●●	0.697
4	7.5	9	9	10	10	18	1	1	LC2 D183●●	0.707
5.5	11	11	11	15	15	25	1	1	LC2 D253●●	0.787
7.5	15	15	15	18.5	18.5	32 (4)	1	1	LC2 D323●●	0.797

Power connection by EverLink®, BTR screw connectors (5) and control by spring terminals

11	18.5	22	22	22	30	40	1	1	LC2 D40A3●● (6)	1.870
15	22	25	30	30	33	50	1	1	LC2 D50A3●● (6)	1.880
18.5	30	37	37	37	37	65	1	1	LC2 D65A3●● (6)	1.890

For connection by Faston connectors

All power connections are to be made by the customer.
These contactors are fitted with Faston connectors: 2 x 6.35 mm on the power poles and 1 x 6.35 mm on the coil terminals.

For reversing contactors LC2 D09 and LC2 D12 only, in the references selected above, replace the figure 3 before the voltage code with a figure 9.

Example: LC2 D093●● becomes LC2 D099●●.

Component parts

Auxiliary contact blocks and add-on modules: see pages 5/78 to 5/85.

(1) LC2 D09 to D32: clip-on mounting on 35 mm rail AM1 DP or screw fixing.

(2) Standard control circuit voltages (for other voltages, please consult your Regional Sales Office):

a.c. supply														
Volts	24	42	48	110	115	220	230	240	380	400	415	440	500	
LC2 D09...D65A														
50/60 Hz		B7	D7	E7	F7	FE7	M7	P7	U7	Q7	V7	N7	R7	S7
d.c. supply														
Volts	12	24	36	48	60	72	110	125	220	250	440			
LC2 D09...D65A (coils with integral suppression device fitted as standard)														
U 0.75...1.25 Uc		JD	BD	CD	ED	ND	SD	FD	GD	MD	UD	RD		
Low consumption														
Volts ---	5	12	20	24	48	110	220	250						
LC2 D09...D38 (coils with integral suppression device fitted as standard)														
U 0.8...1.25 Uc		AL	JL	ZL	BL	EL	FL	ML	UL					

For other voltages between 5 and 690 V, see pages 5/86 to 5/91.

(3) The weights indicated are for reversing contactors with a.c. control circuit. For d.c. or low consumption control circuit, add 0.330 kg for LC2 D09 to D38, 0.150 kg for LC1 D40A to D65A.

(4) Must be wired with 2 x 4 mm² cables in parallel on the upstream side. On the downstream side, outgoing terminal block LAD 331 may be used (Quickfit technology, see page 1/197). When wired with a single cable, the product is limited to 25 A (11 kW/400 V motors).

(5) BTR screws: hexagon socket head. In accordance with local electrical wiring regulations, a size 4 insulated Allen key must be used (reference LAD ALLEN4, see page 5/85).

(6) For low consumption kit LA4 DBL (see page 5/83).

TeSys contactors

TeSys D, 4-pole changeover contactor pairs for control in category AC-1, 20 to 200 A

526176



LC2 DT20●●

Pre-assembled. Pre-wired power connections.

For connection by screw clamp terminals or connectors

LC2 DT20 to LC2 DT40: mechanical interlock without electrical interlocking.

LC2 D80004: order separately 2 auxiliary contact blocks LAD N●1 to obtain electrical interlocking between the 2 contactors (see page 5/79). For electrical interlocking incorporated in the mechanical interlock, please consult your Regional Sales Office.

LC2 D115004: mechanical interlock with integral, pre-wired electrical interlocking.

Utilisation category AC-1 Non-inductive loads Maximum rated operational current ($\theta \leq 60^\circ\text{C}$)	Instantaneous auxiliary contacts per contactor		Contactors supplied with coil	Weight kg
			Basic reference, to be completed by adding the voltage code (1) Fixing (2)	
A				kg
20	1	1	LC2 DT20●●	0.730
25	1	1	LC2 DT25●●	0.730
32	1	1	LC2 DT32●●	0.850
40	1	1	LC2 DT40●●	0.850
125	–	–	LC2 D80004●●	3.200
200	–	–	LC2 D115004●●	7.400

For connection by lugs or bars

20	1	1	LC2 DT206●●	0.730
25	1	1	LC2 DT256●●	0.730
32	1	1	LC2 DT326●●	0.850
40	1	1	LC2 DT406●●	0.850

For customer assembly.

For connection by screw clamp terminals or connectors

60	1	1	LC1 DT60A●● (3)	–
80	1	1	LC1 DT80A●● (3)	–

For connection by lugs or bars

60	1	1	LC1 DT60A6●● (3)	–
80	1	1	LC1 DT80A6●● (3)	–

Accessories

Auxiliary contact blocks and add-on modules: see pages 5/78 to 5/85.

(1) See note (1) on next page.

(2) LC2 DT20 to LC2 DT80: clip-on mounting on 35 mm \perp rail AM1 DP or screw fixing.

LC2 D80: clip-on mounting on 35 mm \perp rail AM1 DP or 75 mm \perp rail AM1 DL or screw fixing.

LC2 D115: clip-on mounting on 2 x 35 mm \perp rails AM1 DP or screw fixing.

(3) For these operational currents, order 2 identical contactors and a mechanical interlock LAD 4CM (see page 5/76).

Note: when assembling changeover contactor pairs, it is good practice to incorporate a 50 ms time delay.

TeSys contactors

TeSys D, 4-pole changeover contactor pairs for control in category AC-1, 20 A

Pre-assembled. Pre-wired power connections.			
For connection by spring terminals.			
Utilisation category AC-1 Non-inductive loads Maximum rated operational current ($\theta \leq 60^\circ\text{C}$)	Instantaneous auxiliary contacts per contactor		Weight
		Contactors supplied with coil Basic reference, to be completed by adding the control voltage code (1) Fixing (2)	
A			kg
20	1	1	LC2 DT203●● 0.760

For customer assembly.			
Power connection by EverLink®, BTR screw connectors (3) and control by spring terminals			
60	1	1	LC1 DT60A3●● (4) –
80	1	1	LC1 DT80A3●● (4) –

Separate components

Auxiliary contact blocks and add-on modules: see pages 5/78 to 5/85.

(1) Standard control circuit voltages (for other voltages, please consult your Regional Sales Office):

a.c. supply													
Volts	24	42	48	110	115	220	230	240	380	400	415	440	500
LC2 DT20...DT40, LC1 DT60...DT80													
50/60 Hz	B7	D7	E7	F7	FE7	M7	P7	U7	Q7	V7	N7	R7	–
LC2 D80004...D115004													
50 Hz	B5	D5	E5	F5	FE5	M5	P5	U5	Q5	V5	N5	R5	S5
60 Hz	B6	–	E6	F6	–	M6	–	U6	Q6	–	–	R6	–
d.c. supply													
Volts	12	24	36	48	60	72	110	125	220	250	440		
LC2 DT20...DT40, LC1 DT60...DT80 (coils with integral suppression device fitted as standard)													
U 0.7...1.25 Uc	JD	BD	CD	ED	ND	SD	FD	GD	MD	UD	RD		
Low consumption													
Volts	5	12	20	24	48	110	220	250					
LC2 DT20...DT40 (coils with integral suppression device fitted as standard)													
U 0.8...1.25 Uc	AL	JL	ZL	BL	EL	FL	ML	UL					

For other voltages between 5 and 690 V, see pages 5/86 to 5/91

(2) Clip-on mounting on 35 mm rail AM1 DP or screw fixing.

(3) BTR screws: hexagon socket head. In accordance with local electrical wiring regulations, a size 4 insulated Allen key must be used (reference LAD ALLEN4, see page 5/85).

(4) For these operational currents, order 2 identical contactors and a mechanical interlock LAD 4CM (see page 5/76).



TeSys contactors

Component parts for assembling reversing contactors for motor control, low-speed/high-speed starters and star-delta starters

537729

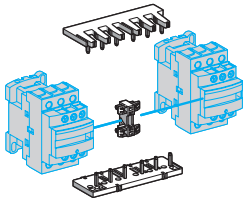

LAD 9R1

537730

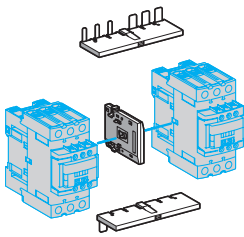

LAD 9R3

537731

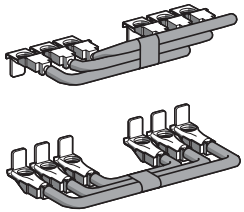

LA9 D8069

For 3-pole reversing contactors for motor control

Contactors with screw clamp terminals or connectors. Horizontally mounted, assembled by customer

Description	For contactors (1) (2 identical contactors)	Reference	Weight kg
Kits for assembly of reversing contactors			
Kit comprising: ■ a mechanical interlock LAD 9V2 with electrical interlocking LAD 9V1 . ■ a set of power connections LAD 9V5 (parallel) and LAD 9V6 (reversing)	LC1 D09 to D38	LAD 9R1V	0.045
Kit comprising: ■ a mechanical interlock LAD 9V2 without electrical interlocking ■ a set of power connections LAD 9V5 (parallel) and LAD 9V6 (reversing)	LC1 D09 to D38	LAD 9R1	0.045
Kit comprising: ■ a mechanical interlock LAD 4CM , ■ a set of power connections LA9 D65A69 .	LC1 D40A to D65A	LAD 9R3	0.170
Mechanical interlocks			
Mechanical interlock with integral electrical interlocking	LC1 D80 and D95 (~)	LA9 D4002	0.170
	LC1 D80 and D95 (---)	LA9 D8002	0.170
	LC1 D115 and D150	LA9 D11502	0.290
Mechanical interlock without integral electrical interlocking	LC1 D09 to D38	LAD 9V2	0.040
	LC1 D40A to D65A	LAD 4CM	0.040
	LC1 D80 and D95 (~)	LA9 D50978	0.170
	LC1 D80 and D95 (---)	LA9 D80978	0.170
Sets of power connections			
Comprising: ■ a set of parallel bars, ■ a set of reverser bars.	LC1 D09 to D38 with screw clamp terminals or connectors	LAD 9V5 + LAD 9V6	–
	LC1 D09...D32 with spring terminal connections	LAD 9V12 + LAD 9V13 (2)	–
	LC1 D40A to D65A	LA9 D65A69	0.130
	LC1 D80 and D95 (~)	LA9 D8069	0.490
	LC1 D80 and D95 (---)	LA9 D8069	0.490
	LC1 D115 and D150	LA9 D11569	1.450

For low-speed/high-speed starter

Description	For contactors with connection type	Reference	Weight kg
Connection kit enabling reversing of low and high speed directions using a reversing contactor and a 2N/O + 2N/C main pole contactor	Screw clamps or connectors	LAD 9PVG V	0.016
	Power connection module with spring terminal connections	LAD 3PVG V	0.034
	Outgoing terminal block with spring terminal connections	LAD 3PVG V10	0.034

For star-delta starter

Description	For contactors	Reference	Weight kg
Mounting kit comprising: ■ 1 time delay contact block LAD S2 (LC1 D09...D80), ■ power circuit connections (LC1 D09...D80), ■ hardware required for fixing the contactors onto the mounting plate (LC1 D80).	LC1 D09 and D12	LAD 91217	0.180
	LC1 D18 to D32	LAD 93217	0.310
	LC1 D40A and D50A	LAD 9SD3	0.380
	LC1 D80	LA9 D8017	0.680
Equipment mounting plates	LC1 D09, D12 and D18	LA9 D12974	0.150
	LC1 D32	LA9 D32974	0.180
	LC1 D40A and D50A	–	–
	LC1 D80	LA9 D80973	0.300

(1) To order the 2 contactors: see pages 5/65 and 5/72.

(2) To assemble a reversing contactor with spring terminal connections, the following components must be ordered:

- 1 mechanical interlock **LAD 9V2**,

- 1 upstream power connection kit and 1 downstream power connection kit.

Upstream power connection kit **LAD 9V10**: installed in the Quickfit system with power connection module **LAD 34**.

(If module **LAD 34** is not used, replace **LAD 9V10** with **LAD 9V12**).

Downstream power connection kit **LAD 9V11**: installed in the Quickfit system with outgoing terminal block **LAD 331**.

(If **LAD 331** is not used, replace **LAD 9V11** with **LAD 9V13**).

TeSys contactors

Component parts for assembling changeover contactor pairs

For 4-pole changeover contactor pairs (3-phase distribution + neutral)

Contactors with screw clamp terminals or connectors. Horizontally mounted, assembled by customer.

Description	For contactors (1) (2 identical contactors)	Reference	Weight kg
Kits for assembly of changeover contactor pairs			
Kit comprising: ■ a mechanical interlock LAD 9V2 with electrical interlocking LAD 9V1 , ■ a set of power connections (changeover) LAD 9V7 .	LC1 DT20 to DT40 with screw clamps or connectors	LAD T9R1V	0.045
Kit comprising: ■ a mechanical interlock LAD 9V2 without electrical interlocking, ■ a set of power connections (changeover) LAD 9V7 .	LC1 DT20 to DT40 with screw clamps or connectors	LAD T9R1	0.045
Mechanical interlocks			
With integral electrical interlocking	LC1 D80004	LA9 D4002	0.170
	LP1 D80004	LA9 D8002	0.170
	LC1 D115004	LA9 D11502	0.280
Without integral electrical interlocking	LC1 DT20 to DT40 with screw clamps or connectors	LAD 9V2 (2)	0.040
	LC1 DT203 to DT403 with spring terminals	LAD 9V2 (2)	0.040
	LC1 DT60A and DT80A	LAD 4CM	0.040
	LC1 D80004	LA9 D50978	0.155
	LP1 D80004	LA9 D80978	0.180
Sets of power connections			
Comprising a set of parallel bars	LC1 DT60A and DT80A	LA9 D65A70 ▲	0.150
	LC1 D80004	LA9 D8070	0.280
	LP1 D80004	LA9 D8070	0.280
	LC1 D115004	LA9 D11570	1.100
	LC1 DT203 to DT403 with spring terminals	LAD 9V9	0.100
	LC1 D80004	LA9 D8070 (2)	–
	LP1 D80004	LA9 D8070 (2)	–

537733

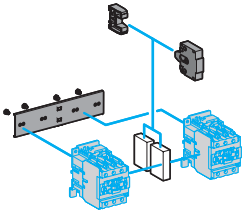

LA9 D50978

537734

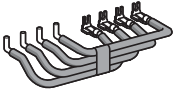

LA9 D6570

537735

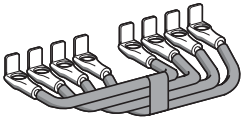

LA9 D8070

For 3-pole changeover contactor pairs

Contactors with screw clamp terminals or connectors. Horizontally mounted, assembled by customer.

Description	For contactors (1) (2 identical contactors)	Reference	Weight kg
Mechanical interlocks			
Without integral electrical interlocking	LC1 D40A...D65A	LAD 9R3S	0.105
With integral electrical interlocking	LC1 D115 and D150	LA9 D11502	0.280
Sets of power connections			
Comprising a set of parallel bars,	LC1 D115 and D150	LA9 D11571	0.960

(1) To order the 2 contactors: see pages 5/65 and 5/72.

(2) Order 2 contact blocks **LAD N•1** to build the electrical interlock, see page 5/79.

▲ Available 1st quarter 2010.

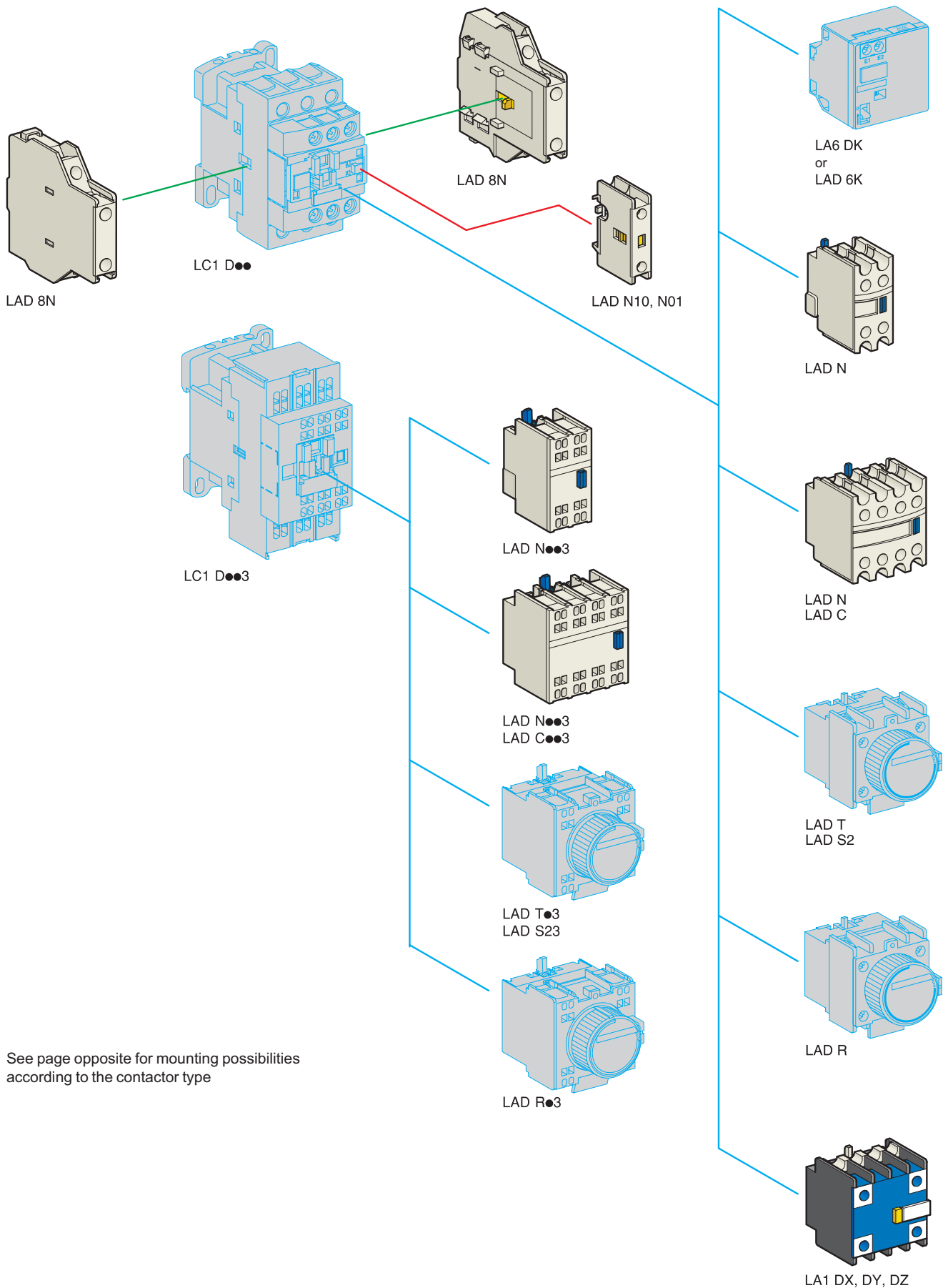

See page opposite for mounting possibilities according to the contactor type





TeSys contactors

TeSys D contactors and reversing contactors Instantaneous auxiliary contact blocks

Instantaneous auxiliary contact blocks for connection by screw clamp terminals

For use in normal operating environments

In order to mount an LAD 8N on an LC1 D80 to D95, a set of shims must be ordered separately, see page 5/85

Clip-on mounting (1)	Number of contacts per block	Composition					Reference	Weight kg
								
Front	1	-	-	-	1	-	LAD N10	0.020
		-	-	-	-	1	LAD N01	0.020
	2	-	-	-	1	1	LAD N11	0.030
		-	-	-	2	-	LAD N20	0.030
		-	-	-	-	2	LAD N02	0.030
		-	-	-	2	2	LAD N22	0.050
	4	-	-	-	1	3	LAD N13	0.050
		-	-	-	4	-	LAD N40	0.050
		-	-	-	-	4	LAD N04	0.050
		-	-	-	3	1	LAD N31	0.050
	4 incl. 1 N/O & 1 N/C make before break	-	-	-	2	2	LAD C22	0.050
Side	2	-	-	-	1	1	LAD 8N11	0.030
		-	-	-	2	-	LAD 8N20	0.030
		-	-	-	-	2	LAD 8N02	0.030

For terminal referencing conforming to EN 50012

Front on 3P contactors and 4P contactors 20 to 80 A	2	-	-	-	1	1	LAD N11G	0.030
	4	-	-	-	2	2	LAD N22G	0.050
Front on 4P contactors 125 to 200 A	2	-	-	-	1	1	LAD N11P	0.030
	4	-	-	-	2	2	LAD N22P	0.050

With dust and damp protected contacts, for use in particularly harsh industrial environments

Front	2	-	2	-	-	-	LA1 DX20	0.040
		1	1	-	-	-	LA1 DX11	0.040
		2	-	-	-	-	LA1 DX02	0.040
		-	2	2	-	-	LA1 DY20 (2)	0.040
		-	2	-	2	-	LA1 DZ40	0.050
	4	-	2	-	1	1	LA1 DZ31	0.060

Instantaneous auxiliary contact blocks for connection by lugs

This type of connection is not possible for blocks with 1 contact or blocks with dust and damp protected contacts. For all other instantaneous auxiliary contact blocks, add the figure 6 to the end of the references selected above. Example: LAD N11 becomes LAD N116.

Instantaneous auxiliary contact blocks for connection by spring terminals

This type of connection is not possible for LAD 8, LAD N with 1 contact or blocks with dust and damp protected contacts. For all other contact blocks, add the figure 3 to the end of the references selected above. Example: LAD N11 becomes LAD N113.

Instantaneous auxiliary contact blocks for connection by Faston connectors

This type of connection is not possible for LAD 8, LAD N with 1 contact or blocks with dust and damp protected contacts. For all other contact blocks, add the figure 9 to the end of the references selected above. Example: LAD N11 becomes LAD N119.

(1) Maximum number of auxiliary contacts that can be fitted:

Contactors	Instantaneous auxiliary contacts		Time delay Front mounted							
				Type	Number of poles and size	Side mounted	Front mounted			
							1 contact	2 contacts	4 contacts	
~	3P	LC1 D09...D38	1 on LH side	and	-	1	or 1	or 1	or 1	
			1 on LH or 1 on RH side	and	-	1	or 1	or 1	or 1	
			1 on each side	or	2	and 1	or 1	or 1	or 1	
			1 on each side	and	2	and 1	or 1	or 1	or 1	
			1 on LH side	and	-	1	or 1	or 1	or 1	
	4P	LC1 DT20...DT40	1 on LH side	and	-	1	or 1	or 1	or 1	
			1 on LH or 1 on RH side	and	-	1	or 1	or 1	or 1	
			1 on each side	or	1	or 1	or 1	or 1	or 1	
			1 on each side	and	1	or 1	or 1	or 1	or 1	
			1 on each side	and	1	or 1	or 1	or 1	or 1	
---	3P	LC1 D09...D38	-	-	-	1	or 1	or 1	or 1	
			-	-	-	1	or 1	or 1	or 1	
			-	-	1	or 1	or 1	or 1	or 1	
			1 on LH side	and	-	1	or 1	or 1	or 1	
			1 on LH side	and	-	1	or 1	or 1	or 1	
	4P	LC1 DT20...DT40	-	-	-	1	or 1	or 1	or 1	
			-	-	-	1	or 1	or 1	or 1	
			-	-	2	and 1	or 1	or 1	or 1	
			1 on each side	-	-	and 1	or 1	or 1	or 1	
			1 on each side	-	-	and 1	or 1	or 1	or 1	
BC (3)	3P	LC1 D09...D38	-	-	-	1	-	-	-	
	4P	LC1 DT20...DT40	-	-	-	1	-	-	-	

(2) Device fitted with 4 earth screen continuity terminals.

(3) LC: low consumption.

TeSys contactors

TeSys D contactors and reversing contactors

Time delay auxiliary contact blocks

Mechanical latch blocks

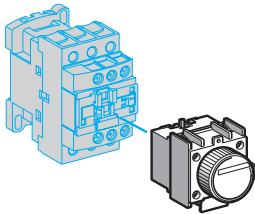

LAD T●

Time delay auxiliary contact blocks for connection by screw clamp terminals

Maximum number of auxiliary contact blocks that can be fitted per contactor, see page 5/79.

Sealing cover to be ordered separately, see page 5/85.

LAD T0 and LAD R0: with extended scale from 0.1 to 0.6 s.

LAD S2: with switching time of 40 ms ± 15 ms between opening of the N/C contact and closing of the N/O contact.

Clip-on mounting	Number of contacts	Time delay		Reference	Weight kg
		Type	Setting range		
Front	1 N/O + 1 N/C	On-delay	0.1...3 s	LAD T0	0.060
			0.1...30 s	LAD T2	0.060
			10...180 s	LAD T4	0.060
			1...30 s	LAD S2	0.060
		Off-delay	0.1...3 s	LAD R0	0.060
			0.1...30 s	LAD R2	0.060
			10...180 s	LAD R4	0.060

Time delay auxiliary contact blocks for connection by lugs

Add the figure 6 to the end of the references selected above. Example: LAD T0 becomes LAD T06.

Time delay auxiliary contact blocks for connection by spring terminals

Add the figure 3 to the end of the references selected above. Example: LAD T0 becomes LAD T03

Time delay auxiliary contact blocks for connection by Faston connectors

Add the figure 9 to the end of the references selected above. Example: LAD T0 becomes LAD T09.

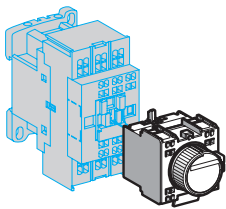

LAD T●3

Mechanical latch blocks (1)

Clip-on mounting	Unlatching control	For use on contactor	Basic reference, to be completed by adding the control voltage code (2)	Weight kg
Front	Manual or electric	LC1 D09...D38 (~ or ---)	LAD 6K10●	0.070
		LC1 DT20...DT40 (~ or ---)	LAD 6K10●	0.070
		LC1 D40A...D65A (3 P ~ or ---) LC1 DT60A and DT80A (4 P ~ or ---)	LAD 6K10●	0.090
		LC1 D80...D150 (3 P ~) LC1 D80 and D115 (3 P ---) LC1 D80 (4 P ~) LC1 D80 and D115 (4 P ~) LP1 D80 and LC1 D115 (4 P ---)	LA6 DK20●	0.090

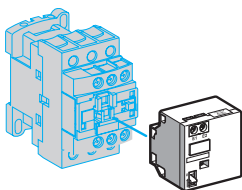

LAD 6K10●

(1) The mechanical latch block must not be powered up at the same time as the contactor.
The duration of the control signal for the mechanical latch block and the contactor should be:
≥ 100 ms for a contactor operating on an a.c. supply,
≥ 250 ms for a contactor operating on a d.c. supply.
Maximum impulse duration for the LAD 6K10● mechanical latch block: 10 seconds.

(2) Standard control circuit voltages (for other voltages, please consult your Regional Sales Office).

Volts 50/60 Hz, ---	24	32/36	42/48	60/72	100	110/127	220/240	256/277	380/415
Code	B	C	E	EN	K	F	M	U	Q

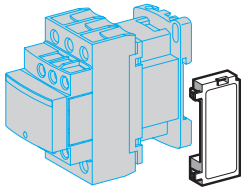

LAD 4●●

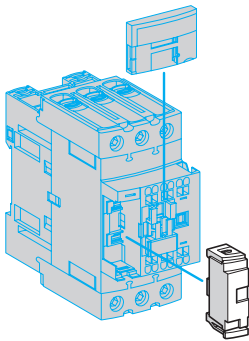

LAD 4RC3●, LAD 4V3●,
LAD 4D3U, LAD 4T3●

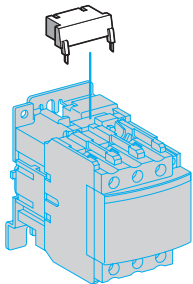

LA4 D●●

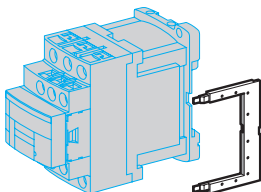

LAD 4DDL or LAD 4T●DL

RC circuits (Resistor-Capacitor)

Effective protection for circuits highly sensitive to "high frequency" interference. For use only in cases where the voltage is virtually sinusoidal. i.e. less than 5% total harmonic distortion. Voltage limited to 3 Uc max. and oscillating frequency limited to 400 Hz max. Slight increase in drop-out time (1.2 to 2 times the normal time).

Mounting	For use with contactor (1) Rating	Type		Reference	Weight kg
		V~	V-		
Clip-on side mounting (3)	D09...D38 (3P) DT20...DT40	24...48	-	LAD 4RCE	0.012
		50...127	-	LAD 4RCG	0.012
		110...250	-	LAD 4RCU	0.012
Clip-on front mounting (3)	D40A...D65A (3P) DT60A...DT80A (4P)	24...48	-	LAD 4RC3E	0.020
		50...127	-	LAD 4RC3G	0.020
		110...240	-	LAD 4RC3U	0.020
		380...415	-	LAD 4RC3N	0.040
Screw fixing (4)	D80...D150 (3P) D40...D115 (4P)	24...48	-	LA4 DA2E	0.018
		50...127	-	LA4 DA2G	0.018
		110...240	-	LA4 DA2U	0.018
		380...415	-	LA4 DA2N	0.018

Varistors (peak limiting)

Protection provided by limiting the transient voltage to 2 Uc max. Maximum reduction of transient voltage peaks. Slight increase in drop-out time (1.1 to 1.5 times the normal time).

Clip-on side mounting (3)	D09...D38 (3P) DT20...DT40	24...48	-	LAD 4VE	0.012
		50...127	-	LAD 4VG	0.012
		110...250	-	LAD 4VU	0.012
Clip-on front mounting (3)	D40A...D65A (3P) DT60A...DT80A (4P)	24...48	24...48	LAD 4V3E	0.020
		50...127	50...127	LAD 4V3G	0.020
		110...250	110...250	LAD 4V3U	0.020
		380...415	-	LAD 4V3N	0.040
Screw fixing (4)	D80...D115 (3P) D80...D115 (4P) D80...D95 (3P) D80 (4P)	24...48	-	LA4 DE2E	0.018
		50...127	-	LA4 DE2G	0.018
		110...250	-	LA4 DE2U	0.018
		-	24...48	LA4 DE3E	0.018
		-	50...127	LA4 DE3G	0.018
-	110...250	LA4 DE3U	0.018		

Flywheel diodes

No overvoltage or oscillating frequency. Increase in drop-out time (6 to 10 times the normal time). Polarised component.

Clip-on side mounting (5)	D09...D38 (3P), DT20...DT40	-	24...250	LAD 4DDL	0.012
Clip-on front mounting (5)	D40A...D65A (3P), DT60A...DT80A (4P)	-	24...250	LAD 4D3U	0.020
Screw fixing (4)	D80 and D95 (3P), D40...D80 (4P)	-	24...250	LA4 DC3U	0.018

Bidirectional peak limiting diodes

Protection provided by limiting the transient voltage to 2 Uc max. Maximum reduction of transient voltage peaks.

Clip-on side mounting (3) (5)	D09...D38 (3P) DT20...DT40 (4P) (2)	24	-	LAD 4TB	0.012
		-	24	LAD 4TBDL	0.012
		72	-	LAD 4TS	0.012
		-	72	LAD 4TSDL	0.012
		-	125	LAD 4TGDL	0.012
Clip-on front mounting (3)	D40A...D65A (3P) DT60A...DT80A (4P) (2)	-	250	LAD 4TUDL	0.012
		-	600	LAD 4TXDL	0.012
		12...24	12...24	LAD 4T3B	0.020
		25...72	25...72	LAD 4T3S	0.020
		73...125	73...125	LAD 4T3G	0.020
Screw fixing (4)	D80...D95 (3P) D40...D80 (4P)	126...250	126...250	LAD 4T3U	0.020
		251...440	251...440	LAD 4T3R	0.020
		12...24	12...24	LA4 DB2B	0.018
		25...72	25...72	LA4 DB2S	0.018
		-	24	LA4 DB3B	0.018
-	72	LA4 DB3S	0.018		

(1) For satisfactory protection, a suppressor module must be fitted across the coil of each contactor.

(2) From D09 to D65A and from LC1 DT20 to DT80A, d.c. and low consumption 3-pole contactors are fitted with a built-in bidirectional peak limiting diode suppressor as standard. This bidirectional peak limiting diode is removable and can therefore be replaced by the user. (See reference above). If a d.c. or low consumption contactor is used without suppression, the standard suppressor should be replaced with a blanking plug (reference LAD 9DL for LC1 D09 to D38 and LC1 DT20 to DT40; reference LAD 9DL3 for LC1 D40A to D65A and LC1 DT60A to DT80A).

(3) Clipping-on makes the electrical connection. The overall size of the contactor remains unchanged.

(4) Mounting at the top of the contactor on coil terminals A1 and A2.

(5) In order to install these accessories, the existing suppression device must first be removed.

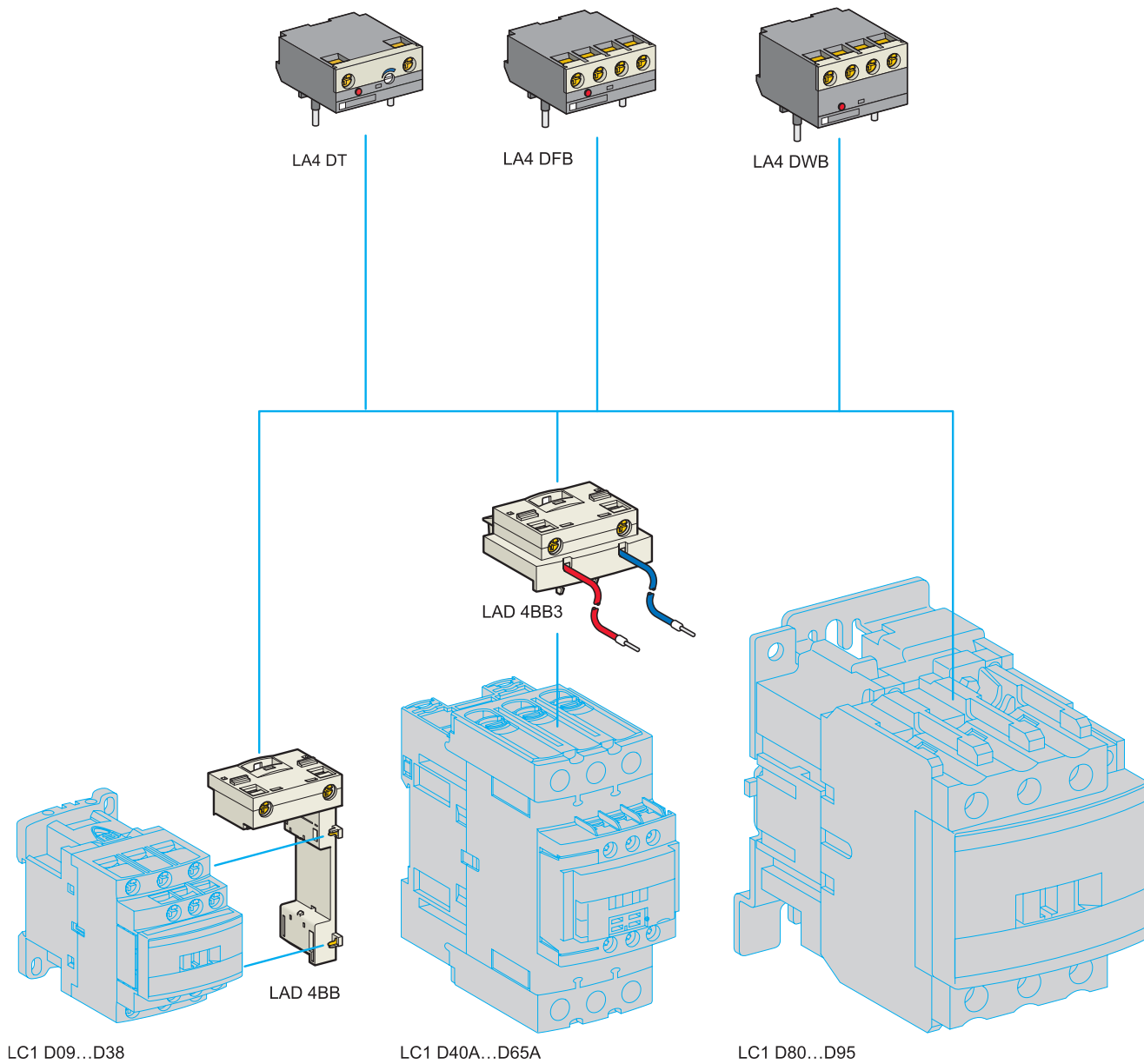

See page opposite for mounting possibilities according to the contactor type

Electronic serial timer modules (1)

- 3-pole contactors LC1 D09 to D38: mounted using adapter LAD 4BB, to be ordered separately, see below.
- 3-pole contactors LC1 D40A to D65A: mounted using adapter LAD 4BB3, to be ordered separately, see below.
- 3-pole contactors LC1 D80 to D150 and 4-pole contactors LC1 D40 to D115: mounted directly across terminals A1 and A2 of the contactor.

On-delay type		Time delay	Reference	Weight kg
Operational voltage ~				
24...250 V	100...250 V			
LC1 D09...D65A (3P)	LC1 D80...D150 (3P)	0.1...2 s	LA4 DT0U	0.040
		1.5...30 s	LA4 DT2U	0.040
		25...500 s	LA4 DT4U	0.040

Interface modules

- 3-pole contactors LC1 D09 to D38: mounted using adapter LAD 4BB, to be ordered separately, see below.
- 3-pole contactors LC1 D40A to D65A: mounted using adapter LAD4 BB3, to be ordered separately, see below.

Relay interface		Supply voltage E1-E2 (---)	Reference	Weight kg
Operational voltage ~				
24...250 V				
LC1 D09...D150 (3P)		24 V	LA4 DFB	0.050

Relay interface with "AUTO-I" manual override switch (output forced "ON"), solid state type

Operational voltage ~		Supply voltage E1-E2 (---)	Reference	Weight kg
24...250 V	100...250 V			
LC1 D09...D65A (3P)	LC1 D80...D115 (3P)	24 V	LA4 DWB	0.045

Low consumption kit

For use on contactors	Composition	Reference	Weight kg
LC1 D40A...D65A (3P) (2)	Kit comprising: <ul style="list-style-type: none"> ■ a retrofit coil LAD 4BB3. ■ a relay interface module LA4 DFB. 	LA4 DBL	0.077

Retrofit: coil for 3-pole contactor

For adapting existing wiring to a new product		Reference	Weight kg	
For use on contactors				
LC1 D09...D38	Without coil suppression	LAD 4BB	0.019	
	With coil suppression	~ 24...48 V	LAD 4BBVE	0.014
		~ 50...127 V	LAD 4BBVG	0.014
		~ 110...250 V	LAD 4BBVU	0.014
LC1 D40A...65A	Without coil suppression	LAD 4BB3	0.027	

(1) For 24 V operation, the contactor must be fitted with a 21 V coil (code Z). See pages 5/86 to 5/91.

(2) The kit is compatible with a coil voltage of ~ 24 V to ~ 250 V (B7 to U7) and --- 24 V to --- 250 V (BD to UD).

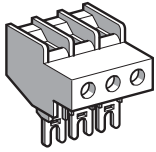

LA9 D3260

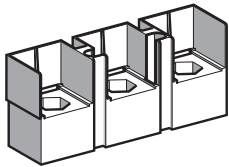

LA9 D11550

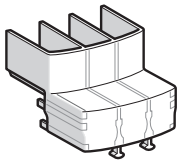

LAD 96570

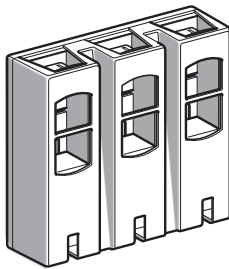

LA9 D11560

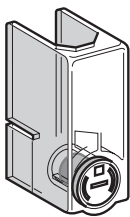

LA9 D11570

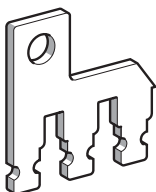

LA9 D80962

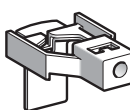

LA9 D11567

Accessories for main pole and control connections

Description	For use with contactors LC1		Sold in lots of	Unit reference	Weight kg	
	~	---				
Connectors for cable, size (1 connector)	4-pole 10 mm ²	DT20, DT25	DT20, DT25	1	LAD 92560	0.030
	3-pole 25 mm ²	D09...D38	D09...D38	1	LA9 D3260	0.040
EverLink® terminal block	3-pole	D40A...D65A	D40A...D65A	1	LAD 96560	0.087
Connectors for cables (2 connectors)	3-pole 120 mm ²	D115, D150	D115, D150	1	LA9 D115603	0.560
	4-pole 120 mm ²	D115	D115	1	LA9 D115604	0.740
Connectors for lug type terminals (2 connectors)	3-pole	D1156, D1506	D1156, D1506	1	LA9 D115503	0.300
	4-pole	D1156	D1156	1	LA9 D115504	0.360
Protective covers for connectors for lug type terminals	3-pole	D40A6...D65A6	D40A6...D65A6	1	LAD 96570	0.021
		D1156, D1506	D1156, D1506	1	LA9 D115703 (1)	0.250
	4-pole	D60A6...D80A6	D60A6...D80A6	1	LAD 96580	0.027
		D1156, D1506	D1156, D1506	1	LA9 D115704	0.300
IP 20 covers for lug type terminals (for mounting with circuit-breakers GV3 P●●6 and GV3 L●●6)	3 poles	D40A6...D65A6	D40A6...D65A6	1	LAD 96575	0.010
Links for parallel connection of	2 poles	D09...D38	D09...D38	10	LA9 D2561	0.060
		DT20, DT25 (4P)	DT20, DT25 (4P)	10	LA9 D1261	0.012
		DT32, DT40 (4P)	DT32, DT40 (4P)	10	LAD 96061	0.060
		D40A...D65A	D40A...D65A	1	LAD 9P32	0.021
	3 poles	D80, D95	D80	2	LA9 D80961	0.060
		D09...D38	D09...D38	10	LAD 9P3 (2)	0.005
		D40A...D65A	D40A...D65A	1	LAD 9P33	0.021
		D80, D95	D80, D95	1	LA9 D80962	0.080
4 poles	DT20, DT25	DT20, DT25	2	LA9 D1263	0.024	
	D80, D95	D80	2	LA9 D80963	0.100	
Staggered coil connection	–	D80	10	LA9 D09966	0.006	
Control circuit take-off from main pole	D80, D95	D80, D95	10	LA9 D8067	0.010	
	D115, D150	D115, D150	10	LA9 D11567	0.014	
Spreaders for increasing the pole pitch to 45 mm	D115, D150	D115, D150	3	GV7 AC03	0.180	

(1) For 3-pole contactors: 1 set of 6 covers, for 4-pole contactors: 1 set of 8 covers.
 (2) Separate connecting bar for connecting 2 poles in parallel.

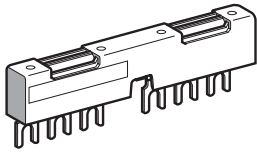

GV2 G245

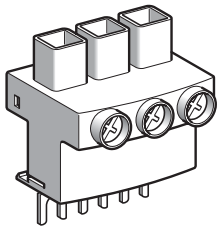

GV1 G09

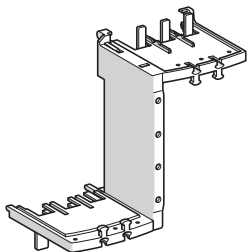

GV3 S

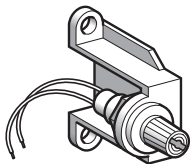

LA9 D941

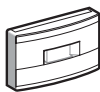

LAD 9ET●

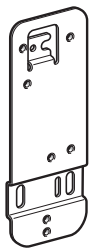

LAD 7X3

Sets of contacts and arc chambers

Description	For contactor		Reference	Weight kg
Sets of contacts	3-pole	LC1 D115	LA5 D1158031	0.260
		LC1 D150	LA5 D150803	0.260
	4-pole	LC1 D115004	LA5 D115804	0.330
Arc chambers	3-pole	LC1 D115	LA5 D11550	0.395
		LC1 D150	LA5 D15050	0.395
	4-pole	LC1 D115004	LA5 D115450	0.470

Power connection accessories

Terminal block	For supply to one or more GV2 G busbar sets		GV1 G09	0.040
Set of 63 A busbars for parallelling of contactors	2 contactors LC1 D09...D18 or D25...D38		GV2 G245	0.036
	4 contactors LC1 D09...D18 or D25...D38		GV2 G445	0.077
Set of 115 A busbars for parallelling of contactors	2 contactors LC1 D40A...D65A		GV3 G264	0.150
	3 contactors LC1 D40A...D65A		GV3 G364 (1)	0.250
Set of S-shape busbars	For circuit-breakers GV3 P●● and GV3 L●● and contactors LC1 D40A...D65A		GV3 S	0.111

Protection accessories

Description	Use	Sold in lots of	Reference	Weight kg
Miniature control circuit fuse holder	5 x 20 with 4 A-250 V fuse	1	LA9 D941	0.025
Sealing cover	For LAD T, LAD R	1	LA9 D901	0.005
Safety cover preventing access to the moving contact carrier	LC1 D09...D65A and DT20...DT80A	1	LAD 9ET1	0.026
	LC1 D80 and D95	1	LAD 9ET3	0.004
	LC1 D115 and D150	1	LAD 9ET4	0.004

Marking accessories

Description	Use	Sold in lots of	Unit reference	Weight kg
Sheet of 64 blank legends, self-adhesive, 8 x 33 mm (2)	Contactors (except 4P) LC1 D80...D115, LAD N (4 contacts), LA6 DK	10	LAD 21	0.020
Sheet of 112 blank legends, self-adhesive, 8 x 12 mm (2)	LAD N (2 contacts), LAD T, LAD R, LRD	10	LAD 22	0.020
Sheet of 64 blank legends for marking using plotter or 8 x 33 mm engraver	Contactors (except 4P) LC1 D80...D115, LAD (4 contacts), LA6 DK	10	LAD 23	0.050
Sheet of 440 blank legends for marking using plotter or 8 x 12 mm engraver	All products	35	LAD 24	0.200
Marker holder snap-in, 8 x 22 mm	4-pole contactors, LC1 D80...D115, LA6 DK	100	LA9 D92	0.001
Marker holder snap-in, 8 x 18 mm	LC1 D09...D65A, LC1 DT20...DT80A, LAD N (4 contacts), LAD T, LAD R	100	LAD 90	0.001
Bag of 300 blank legends self-adhesive, 7 x 21 mm	On holder LA9 D92	1	LA9 D93	0.001
"SIS Label" labelling software supplied on CD-Rom	Multi-language version: English, French, German, Italian, Spanish	1	XBY 2U	0.100

Mounting accessories

Retrofit plate for screw fixing	For replacement of LC1 D40 to D65 with LC1 D40A to D65A	1	LAD 7X3	0.150
Mounting plate	For replacement of LC1 F115 or F150 with LC1 D115 or D150	1	LA9 D730	0.360
Set of shims	For fitting side mounting blocks LAD 8N on LC1 D80 and D95	1	LA9 D511	0.020
Size 4 Allen key, insulated, 1000 V	For use on contactors LC1 D40A to LC1 D150	5	LAD ALLEN4	0.026

(1) With this set of busbars, any one contactor can be supplied directly by its EverLink® double cage power terminal block. The other two contactors are supplied by the busbar set. The 115 A limitation is therefore applied to these two contactors. Example: 1 LC1 D65A supplied directly + 1 contactor LC1 D65A and 1 contactor LC1 D50 A supplied via the busbar set = 115 A. This combination is compatible with busbar set GV3 G364.

(2) These legends are for sticking onto the safety cover of the contactors or add-on block, if fitted.

TeSys contactors

a.c. coils

for TeSys D, 3 or 4-pole contactors

For ~ contactors LC1 D09...D38 and LC1 DT20...DT40

Specifications

Average consumption at 20 °C:

- inrush ($\cos \varphi = 0.75$) 70 VA,- sealed ($\cos \varphi = 0.3$) 50 Hz: 7 VA, 60 Hz: 7.5 VAOperating range ($\theta \leq 60$ °C): 50 Hz: 0.8...1.1 Uc, 60 Hz: 0.85...1.1 Uc.

Control circuit voltage Uc	Average resistance at 20 °C ± 10 %	Inductance of closed circuit	Reference (1)	Weight
V	Ω	H	50/60 Hz	kg
12	1.33	0.05	LXD 1J7	0.070
21 (2)	4.17	0.17	LXD 1Z7	0.070
24	5.37	0.22	LXD 1B7	0.070
32	10.1	0.39	LXD 1C7	0.070
36	12.8	0.49	LXD 1CC7	0.070
42	17	0.67	LXD 1D7	0.070
48	21.7	0.87	LXD 1E7	0.070
60	34.6	1.4	LXD 1EE7	0.070
100	100.4	3.8	LXD 1K7	0.070
110	124.1	4.6	LXD 1F7	0.070
115	129.8	5	LXD 1FE7	0.070
120	150.6	5.4	LXD 1G7	0.070
127	158.5	6.1	LXD 1FC7	0.070
200	410.7	15	LXD 1L7	0.070
208	430.4	16	LXD 1LE7	0.070
220	515.4	18	LXD 1M7 (3)	0.070
230	538.6	20	LXD 1P7	0.070
240	562.3	22	LXD 1U7	0.070
277	800.7	29	LXD 1W7	0.070
380	1551	55	LXD 1Q7 (4)	0.070
400	1633	60	LXD 1V7	0.070
415	1694	65	LXD 1N7	0.070
440	1993	73	LXD 1R7	0.070
480	2398	87	LXD 1T7	0.070
500	2499	95	LXD 1S7	0.070
575	3294	125	LXD 1SC7	0.070
600	3810	136	LXD 1X7	0.070
660	4656	165	LXD 1YC7	0.070
690	5020	180	LXD 1Y7	0.070

(1) The last 2 digits in the reference represent the voltage code.

(2) Voltage for special coils fitted in contactors with serial timer modules, with 24 V supply.

(3) Suitable for use on 230 V / 50 Hz. In this case, apply a coefficient of 0.6 to the mechanical durability of the contactor (see pages 5/52 and 5/53).

(4) Suitable for use on 400 V / 50 Hz. In this case, apply a coefficient of 0.6 to the mechanical durability of the contactor (see pages 5/52 and 5/53).

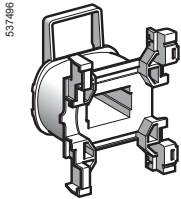

LXD 1●●

TeSys contactors

a.c. coils
for TeSys D, 3 or 4-pole contactors

For ~ contactors LC1 D40A...D65A, LC1 DT60A and LC1 DT80A

Specifications

Average consumption at 20 °C:

- inrush ($\cos \varphi = 0.75$) 160 VA.

- sealed ($\cos \varphi = 0.3$) 50 Hz: 15 VA, 60 Hz: 15 VA

Operating range ($\theta \leq 60$ °C): 50 Hz: 0.8...1.1 Uc, 60 Hz: 0.85...1.1 Uc.

Control circuit voltage Uc	Average resistance at 20 °C \pm 10%	Inductance of closed circuit	Reference (1)	Weight
V	Ω	H	50/60 Hz	kg
12	0.49	0.03	LXD 3J5 (2)	0.070
24	1.98	0.12	LXD 3B7	0.070
32	3.76	0.22	LXD 3C7	0.070
42	6.18	0.37	LXD 3D7	0.070
48	7.97	0.48	LXD 3E7	0.070
100	37.63	2.07	LXD 3K7	0.070
110	42.28	2.50	LXD 3F7	0.070
115	48.76	2.74	LXD 3FE7	0.070
120	37.63	2.07	LXD 3G7	0.070
127	60.29	3.34	LXD 3FC7	0.070
200	149	8.27	LXD 3L7	0.070
208	105	6.22	LXD 3LE7	0.070
220	182	10	LXD 3M7 (3)	0.070
230	192	10.9	LXD 3P7	0.070
240	202	11.9	LXD 3U7	0.070
277	193	11	LXD 3W7	0.070
380	512	29.9	LXD 3Q7 (4)	0.070
400	607	33.1	LXD 3V7	0.070
415	635	35.6	LXD 3N7	0.070
440	682	40.1	LXD 3R7	0.070
480	607	33.1	LXD 3T7	0.070
500	878	51.7	LXD 3S7	0.070
575	1238	68.4	LXD 3SC7	0.070
600	1304	74.5	LXD 3X7	0.070
660	1593	90.1	LXD 3YC7	0.070
690	1683	98.5	LXD 3Y7	0.070

(1) The last 2 digits in the reference represent the voltage code.

(2) This coil can only be used on 50 Hz.

(3) Suitable for use on 230 V / 50 Hz. In this case, apply a coefficient of 0.6 to the mechanical durability of the contactor (see pages 5/52 and 5/53).

(4) Suitable for use on 400 V / 50 Hz. In this case, apply a coefficient of 0.6 to the mechanical durability of the contactor (see pages 5/52 and 5/53).

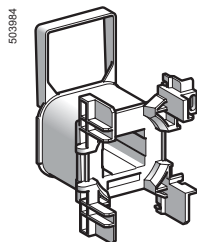

LXD 3●●

TeSys contactors

a.c. coils
for TeSys D, 3 or 4-pole contactors

For 3 or 4-pole contactors LC1D40, D50, D65, D80, D95

Specifications

Average consumption at 20 °C:
 - inrush ($\cos \varphi = 0.75$) 50 Hz: 200 VA, 60 Hz: 220 VA,
 - sealed ($\cos \varphi = 0.3$) 50 Hz: 20 VA, 60 Hz: 22 VA
 Operating range ($\theta \leq 55$ °C): 0.85...1.1 Uc.

Control circuit voltage Uc	Average resistance at 20°C ± 10 %	Inductance of closed circuit	Reference (1)	Average resistance at 20°C ± 10 %		Inductance of closed circuit		Weight
				Ω	H	Ω	H	
V	Ω	H						kg
			50 Hz			60 Hz		
24	1.4	0.09	LX1 D6B5	1.05	0.06	LX1 D6B6	0.280	
32	2.6	0.16	LX1 D6C5	–	–	–	0.280	
42	4.4	0.27	LX1 D6D5	–	–	–	0.280	
48	5.5	0.35	LX1 D6E5	4.2	0.23	LX1 D6E6	0.280	
110	31	1.9	LX1 D6F5	22	1.2	LX1 D6F6	0.280	
115	31	1.9	LX1 D6FE5	–	–	–	0.280	
120	–	–	–	28	1.5	LX1 D6G6	0.280	
127	41	2.4	LX1 D6G5	–	–	–	0.280	
208	–	–	–	86	4.3	LX1 D6L6	0.280	
220	–	–	–	98	4.8	LX1 D6M6	0.280	
220/230	127	7.5	LX1 D6M5	–	–	–	0.280	
230	133	8.1	LX1 D6P5	–	–	–	0.280	
240	152	8.7	LX1 D6U5	120	5.7	LX1 D6U6	0.280	
256	166	10	LX1 D6W5	–	–	–	0.280	
277	–	–	–	157	8	LX1 D6W6	0.280	
380	–	–	–	300	14	LX1 D6Q6	0.280	
380/400	381	22	LX1 D6Q5	–	–	–	0.280	
400	411	25	LX1 D6V5	–	–	–	0.280	
415	463	26	LX1 D6N5	–	–	–	0.280	
440	513	30	LX1 D6R5	392	19	LX1 D6R6	0.280	
480	–	–	–	480	23	LX1 D6T6	0.280	
500	668	38	LX1 D6S5	–	–	–	0.280	
575	–	–	–	675	33	LX1 D6S6	0.280	
600	–	–	–	775	36	LX1 D6X6	0.280	
660	1220	67	LX1 D6Y5	–	–	–	0.280	

Specifications

Average consumption at 20 °C:
 - inrush ($\cos \varphi = 0.75$) 50/60 Hz: 245 VA at 50 Hz,
 - sealed ($\cos \varphi = 0.3$) 50/60 Hz: 26 VA at 50 Hz.
 Operating range ($\theta \leq 55$ °C): 0.85...1.1 Uc.

Control circuit voltage Uc	Average resistance at 20°C ± 10 %	Inductance of closed circuit	Reference (1)	Average resistance at 20°C ± 10 %		Inductance of closed circuit		Weight
				Ω	H	Ω	H	
24	–	–	–	1.22	0.08	LX1 D6B7	0.280	
42	–	–	–	3.5	0.25	LX1 D6D7	0.280	
48	–	–	–	5	0.32	LX1 D6E7	0.280	
110	–	–	–	26	1.7	LX1 D6F7	0.280	
115	–	–	–	–	–	LX1 D6FE7	0.280	
120	–	–	–	32	2	LX1 D6G7	0.280	
220/230 (2)	–	–	–	102	6.7	LX1 D6M7	0.280	
230	–	–	–	115	7.7	LX1 D6P7	0.280	
230/240 (3)	–	–	–	131	8.3	LX1 D6U7	0.280	
380/400 (4)	–	–	–	310	20	LX1 D6Q7	0.280	
400	–	–	–	349	23	LX1 D6V7	0.280	
415	–	–	–	390	24	LX1 D6N7	0.280	
440	–	–	–	410	27	LX1 D6R7	0.280	

(1) The last 2 digits in the reference represent the voltage code.

(2) For use on 230 V / 50 Hz, apply a coefficient of 0.6 to the mechanical durability of the contactor, see pages 5/52 and 5/53. This coil can be used on 240 V at 60 Hz.

(3) This coil can be used on 220/240 V at 50 Hz and on 240 V only at 60 Hz.

(4) For use on 400 V / 50 Hz, apply a coefficient of 0.6 to the mechanical durability of the contactor, see pages 5/52 and 5/53.

537497

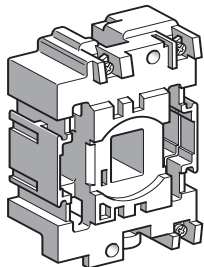

LX1 D6●●

TeSys contactors

a.c. coils
for TeSys D, 3 or 4-pole contactors

For 3 or 4-pole contactors LC1 D115

Specifications

Average consumption at 20 °C:
 - inrush ($\cos \varphi = 0.8$) 50 or 60 Hz: 300 VA,
 - sealed ($\cos \varphi = 0.3$) 50 or 60 Hz: 22 VA
 Operating range ($\theta \leq 55$ °C): 0.85...1.1 Uc.

Control circuit voltage Uc	Average resistance at 20°C ± 10 %	Inductance of closed circuit	Reference (1)	Average resistance at 20°C ± 10 %		Reference (1)	Weight
				Ω	H		
V	Ω	H		Ω	H		kg
			50 Hz			60 Hz	
24	1.24	0.09	LX1 D8B5	0.87	0.07	LX1 D8B6	0.260
32	2.14	0.17	LX1 D8C5	–	–	–	0.260
42	3.91	0.28	LX1 D8D5	–	–	–	0.260
48	4.51	0.36	LX1 D8E5	3.91	0.28	LX1 D8E6	0.260
110	26.53	2.00	LX1 D8F5	19.97	1.45	LX1 D8F6	0.260
115	26.53	2.00	LX1 D8FE5	–	–	–	0.260
120	–	–	–	24.02	1.70	LX1 D8G6	0.260
127	32.75	2.44	LX1 D8FC5	–	–	–	0.260
208	–	–	–	67.92	5.06	LX1 D8L6	0.260
220	104.77	7.65	LX1 D8M5	79.61	5.69	LX1 D8M6	0.260
230	104.77	8.29	LX1 D8P5	–	–	–	0.260
240	125.25	8.89	LX1 D8U5	97.04	6.75	LX1 D8U6	0.260
277	–	–	–	125.75	8.89	LX1 D8W6	0.260
380	338.51	22.26	LX1 D8Q5	243.07	17.04	LX1 D8Q6	0.260
400	368.43	25.55	LX1 D8V5	–	–	–	0.260
415	368.43	27.65	LX1 D8N5	–	–	–	0.260
440	441.56	30.34	LX1 D8R5	338.51	22.26	LX1 D8R6	0.260
480	–	–	–	368.43	25.55	LX1 D8T6	0.260
500	566.62	38.12	LX1 D8S5	–	–	–	0.260

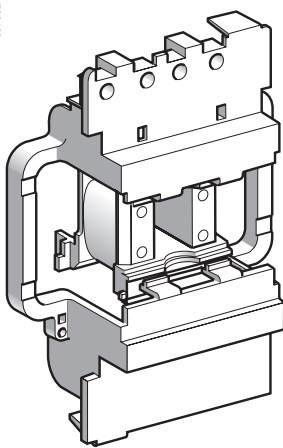

LX1 D8●●

For 3 or 4-pole contactors LC1 D115, LC1 D150

Specifications

Average consumption at 20 °C:
 - inrush: $\cos \varphi = 0.9$ - 280 to 350 VA,
 - sealed: $\cos \varphi = 0.9$ - 2 to 18 VA.
 Operating range ($\theta \leq 55$ °C): 0.8...1.15 Uc.
 Coils with integral suppression device fitted as standard, class B.

Control circuit voltage Uc	Average resistance at 20°C ± 10 %	Inductance of closed circuit	Reference (1)	Average resistance at 20°C ± 10 %		Reference (1)	Weight
				Ω	H		
V	Ω	H		Ω	H		kg
						50/60 Hz	
24	–	–	–	147	3.03	LX1 D8B7	0.290
32	–	–	–	301	8.28	LX1 D8C7	0.290
42	–	–	–	498	13.32	LX1 D8D7	0.290
48	–	–	–	1061	24.19	LX1 D8E7	0.290
110	–	–	–	4377	109.69	LX1 D8F7	0.290
115	–	–	–	4377	109.69	LX1 D8FE7	0.290
120	–	–	–	4377	109.69	LX1 D8G7	0.290
127	–	–	–	6586	152.65	LX1 D8FC7	0.290
208	–	–	–	10 895	260.15	LX1 D8LE7	0.290
220	–	–	–	9895	210.72	LX1 D8M7	0.290
230	–	–	–	9895	210.72	LX1 D8P7	0.290
240	–	–	–	9895	210.72	LX1 D8U7	0.290
277	–	–	–	21 988	533.17	LX1 D8UE7	0.290
380	–	–	–	21 011	482.42	LX1 D8Q7	0.290
400	–	–	–	21 011	482.42	LX1 D8V7	0.290
415	–	–	–	21 011	482.42	LX1 D8N7	0.290
440	–	–	–	21 501	507.47	LX1 D8R7	0.290
480	–	–	–	32 249	938.41	LX1 D8T7	0.290
500	–	–	–	32 249	938.41	LX1 D8S7	0.290

(1) The last 2 digits in the reference represent the voltage code.

TeSys contactors

d.c. coils
for TeSys D, 3 or 4-pole contactors

For 3-pole contactors LC1 D80 or 4-pole contactors LP1 D80

Specifications

Average consumption: 22 W.
Operating range: 0.85...1.1 Uc.

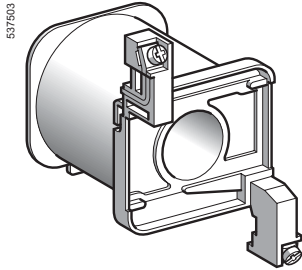

LX4 D7●D

Control circuit voltage Uc	Average resistance at 20 °C ± 10%	Inductance of closed circuit	Reference (1)	Weight
V	Ω	H		kg
12	6.6	0.46	LX4 D7JD	0.680
24	27	1.89	LX4 D7BD	0.680
36	57	4	LX4 D7CD	0.680
48	107	7.5	LX4 D7ED	0.680
60	170	11.9	LX4 D7ND	0.680
72	230	16.1	LX4 D7SD	0.680
110	564	39.5	LX4 D7FD	0.680
125	718	50.3	LX4 D7GD	0.680
220	2215	155	LX4 D7MD	0.680
250	2850	200	LX4 D7UD	0.680
440	9195	640	LX4 D7RD	0.680

(1) The last 2 digits in the reference represent the voltage code.

TeSys contactors

d.c. coils for TeSys D, 3 or 4-pole contactors

For contactors LC1 D115, D150

Specifications

Consumption: inrush 270 to 365 W, sealed 2.4 to 5.1 W.
Operating range: 0.75...1.2 U_c.
Coils with integral suppression device fitted as standard, class B.

Control circuit voltage U _c V	Average resistance at 20 °C ± 10 % Ω	Inductance of closed circuit H	Reference (1)	Weight kg
24	147	3.03	LX4 D8BD	0.300
48	1061	24.19	LX4 D8ED	0.300
60	1673	38.44	LX4 D8ND	0.300
72	2500	56.27	LX4 D8SD	0.300
110	4377	109.69	LX4 D8FD	0.300
125	6586	152.65	LX4 D8GD	0.300
220	9895	210.72	LX4 D8MD	0.300
250	18 022	345.40	LX4 D8UD	0.300
440	21 501	684.66	LX4 D8RD	0.300

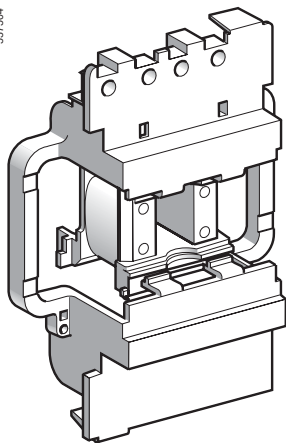

LX4 D8D

For 3-pole contactors LC1 D80 or 4-pole contactors LP1 D80

Specifications

Wide range coils for specific applications
Average consumption: 23 W.
Operating range: 0.75 to 1.2 U_c.
Coils with "TH" treatment as standard.

Control circuit voltage U _c V	Average resistance at 20 °C ± 10 % Ω	Inductance of closed circuit H	Reference (1)	Weight kg
12	6.2	0.49	LX4 D7JW	0.680
24	23.5	1.75	LX4 D7BW	0.680
36	51.9	4.18	LX4 D7CW	0.680
48	94.2	7	LX4 D7EW	0.680
72	204	15.7	LX4 D7SW	0.680
110	483	36	LX4 D7FW	0.680
220	1922	144	LX4 D7MW	0.680

(1) The last 2 digits in the reference represent the voltage code.

TeSys contactors

TeSys D contactors

Control circuit: a.c.

LC1 D09...D18 (3-pole)

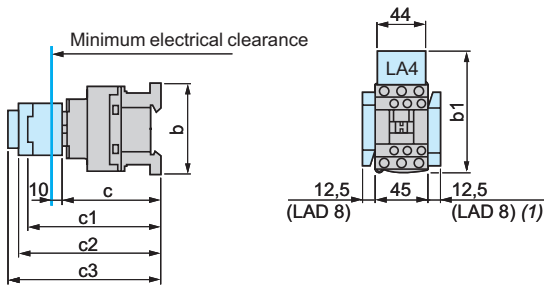

LC1 D25...D38 (3-pole), LC1 DT20...DT40 (4-pole)

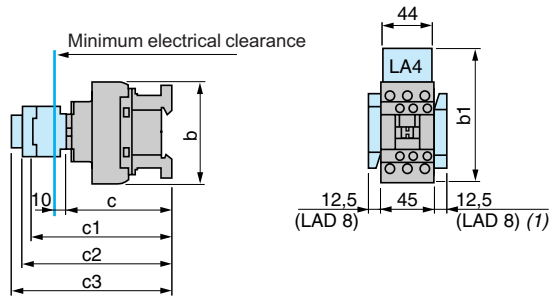

LC1	D09...D18	D093... D123	D099... D129	D25... D38	D183... D323	D098, D128, DT20 and DT25	DT203 and DT253	DT32 and DT40	D188, D258, DT323 and DT403
b without add-on blocks	77	99	80	85	99	85	99	91	105
b1 with LAD 4BB	94	107	95,5	98	107	98	-	-	-
with LA4 D●2	110 (1)	123 (1)	111,5 (1)	114 (1)	123 (1)	114	-	-	-
with LA4 DF, DT	119 (1)	132 (1)	120,5 (1)	123 (1)	132 (1)	129	-	-	-
with LA4 DW, DL	126 (1)	139 (1)	127,5 (1)	130 (1)	139 (1)	190	-	-	-
c without cover or add-on blocks	84	84	84	90	90	90	90	97	97
with cover, without add-on blocks	86	86	86	92	92	92	92	99	99
c1 with LAD N or C (2 or 4 contacts)	117	117	117	123	123	123	123	131	131
c2 with LA6 DK10, LAD 6K10	129	129	129	135	135	135	135	143	143
c3 with LAD T, R, S	137	137	137	143	143	143	143	151	151
with LAD T, R, S and sealing cover	141	141	141	147	147	147	147	155	155

(1) Including LAD 4BB.

LC1 D40A...D65A (3-pole), LC1 DT60A...DT80A (4-pole)

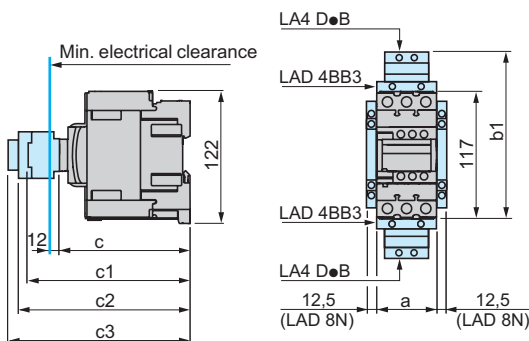

LC1 D80 and D95 (3-pole), LC1 D80004 and D80008 (4-pole), D40008 and D65008 (4-pole)

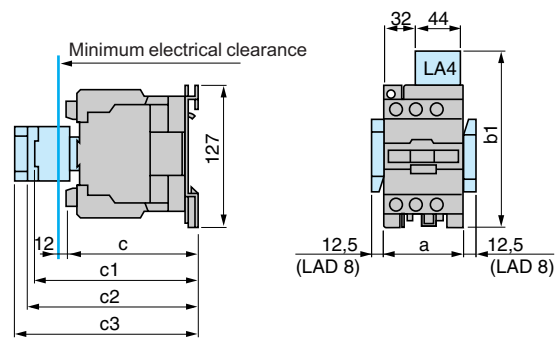

LC1	D40A...D65A	DT60A...DT80A	D40008	D80	D95, D65008	D80004	D80008
a	55	70	85	85	85	96	96
b1 with LA4 D●2	-	-	135	135	135	135	135
with LA4 DB3 or LAD 4BB3	136	-	-	135	-	-	-
with LA4 DF, DT	157	-	142	142	142	142	142
with LA4 DM, DW, DL	166	-	150	150	150	150	150
c without cover or add-on blocks	118	118	125	125	125	125	140
with cover, without add-on blocks	120	120	-	130	130	-	-
c1 with LAD N (1 contact)	-	-	139	150	150	150	150
with LAD N or C (2 or 4 contacts)	150	150	147	158	158	158	158
c2 with LAD 6K10 or LA6 DK	163	163	159	170	170	170	170
c3 with LAD T, R, S	171	171	167	178	178	178	178
with LAD T, R, S and sealing cover	175	175	171	182	182	182	182

LC1 D115 and D150 (3-pole), LC1 D115004 (4-pole)

LC1	D115, D150	D115004	D1150046
a	120	150	155
b1 with LA4 DA2	174	174	174
with LA4 DF, DT	185	185	185
with LA4 DM, DL	188	188	188
with LA4 DW	188	188	188
c without cover or add-on blocks	132	132	115
with cover, without add-on blocks	136	-	-
c1 with LAD N or C (2 or 4 contacts)	150	150	150
c2 with LA6 DK20	155	155	155
c3 with LAD T, R, S	168	168	168
with LAD T, R, S and sealing cover	172	172	172

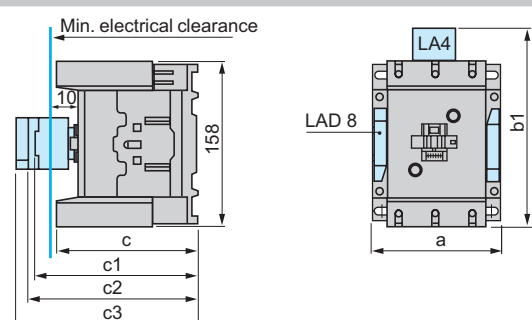

TeSys contactors

TeSys D contactors

Control circuit: d.c. or low consumption

LC1 D09...D18 (3-pole)

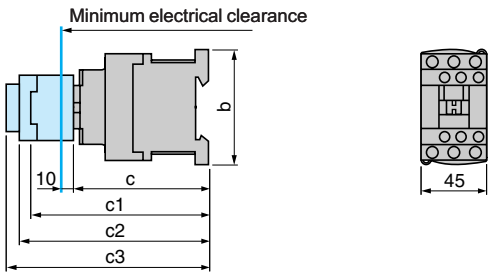

LC1 D25...D38 (3-pole)

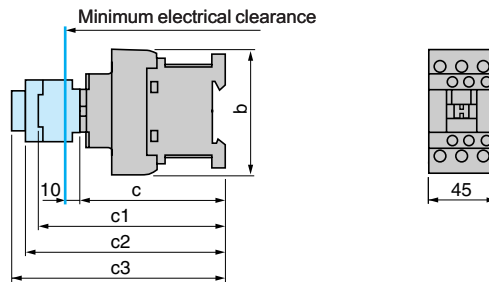

LC1	D09...D18	D093...D123	D099...D129	D25...D38	D183...D323
b	77	99	80	85	99
c without cover or add-on blocks	93	93	93	99	99
c with cover, without add-on blocks	95	95	95	101	101
c1 with LAD N or C (2 or 4 contacts)	126	126	126	132	132
c2 with LA6 DK10	138	138	138	144	144
c3 with LAD T, R, S	146	146	146	152	152
c3 with LAD T, R, S and sealing cover	150	150	150	156	156

LC1 DT20...DT40 (4-pole)

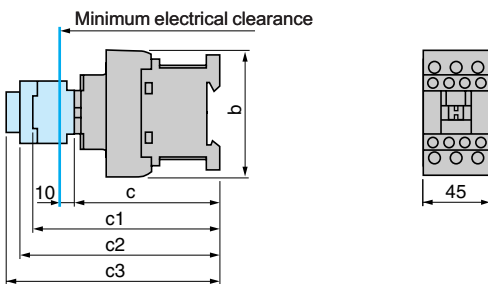

LC1	DT20 and DT25 D098 and D128	DT203 and DT253 D0983 and D1283	DT32 and DT40 D188...D258	DT323 and DT403 D1883 and D2583
b	85	99	91	105
c with cover	99	99	107	107
c1 with LAD N or C (2 or 4 contacts)	123	123	131	131
c2 with LA6 DK10	135	135	143	143
c3 with LAD T, R, S	143	143	151	151
c3 with LAD T, R, S and sealing cover	147	147	155	155

LC1 D40A...D65A (3-pole), LC1 DT60A...DT80A (4-pole)

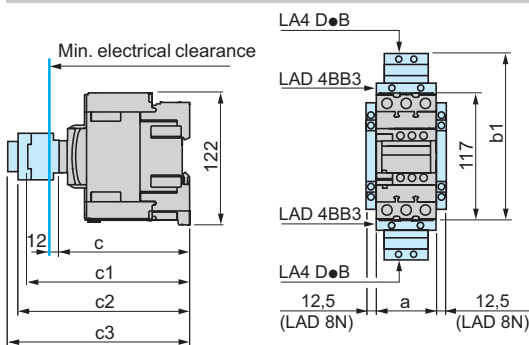

LC1 D80 and D95 (3-pole), LP1 D80004, LP1 D80008 (4-pole), LP1 D40008 and D65008 (4-pole)

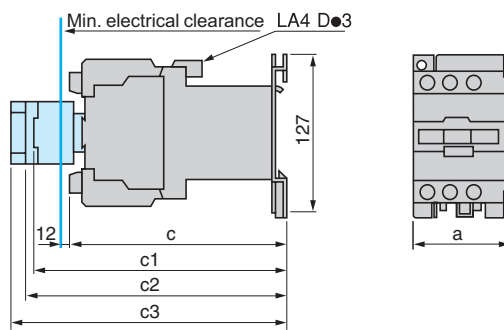

	LC1 D40A ... D65A	LC1 DT60A...DT80A	LP1 D40008 and D65008	LC1 D80 and D95	LP1 D80004	LP1 D80008
a	55	70	85	85	96	96
b1 with LAD 4BB3	136	136	-	-	-	-
with LA4 DF, DT	157	157	-	-	-	-
c without cover or add-on blocks	118	118	182	181	181	196
c with cover, without add-on blocks	120	120	-	186	-	-
c1 with LAD N (1 contact)	-	-	196	204	204	204
with LAD N or C (2 or 4 contacts)	150	150	202	210	210	210
c2 with LA6 DK10	163	163	213	221	221	221
c3 with LAD T, R, S	171	171	221	229	229	229
c3 with LAD T, R, S and sealing cover	175	175	225	233	233	233

LC1 D115●●● and LC1 D150●●● with ∴ coil: see page 5/92

LC1 D09...D38, DT20...DT40

On mounting rail AM1 DP200, DR200 or AM1 DE200 (width 35 mm)

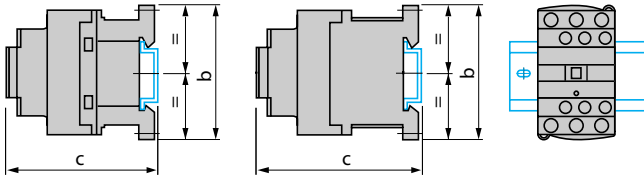

Control circuit: a.c.

LC1	D09... D18	D25... D38	DT20 and DT25	DT32 and DT40
b	77	85	85	100
c (AM1 DP200 or DR200) (1)	88	94	94	109
c (AM1 DE200) (1)	96	102	102	117

Control circuit: d.c.

LC1	D09... D18	D25... D38	DT20 and DT25	DT32 and DT40
b	77	85	94	109
c (AM1 DP200 or DR200) (1)	97	103	103	118
c (AM1 DE200) (1)	105	110	111	1236

(1) with safety cover.

LC1 D40A...D65A, LC1 DT60A and DT80A, LC1 D80 and D95, LC1 D40008 and D65008

On mounting rail AM1 DL200 or DL201 (width 75 mm)

On mounting rail AM1 ED●●● or AM1 DE200 (width 35 mm)

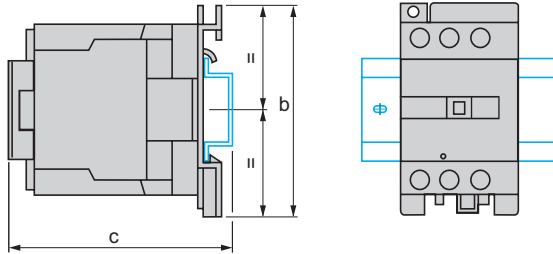

Control circuit: a.c.

LC1	D40A...D65A DT60A...DT80A	D80 and D95	D40008 and D65008
b	122	127	127
c (AM1 DL200) (1)	–	147	143
c (AM1 DL201) (1)	–	137	133
c (AM1 ED●●● or DE200) (1)	128	137	133

Control circuit: d.c.

LC1	D40A...D65A DT60A...DT80A	D80 and D95	D40008 and D65008
c (AM1 DL200) (1)	–	205	200
c (AM1 DL201) (1)	–	195	190
c (AM1 ED●●● or DE200) (1)	128	128	190

(1) with safety cover.

LC1 D80 and D95, LP1 D80

On 2 mounting rails DZ5 MB on 120 mm centres

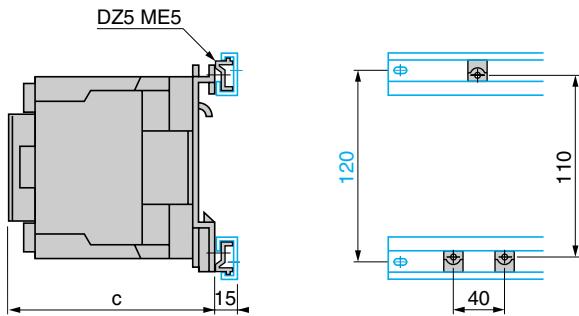

Control circuit: a.c.

LC1	D80 and D95
c with cover	130

Control circuit: d.c.

LC1	D80 and D95
c with cover	186

LP1

LP1	D80
c	181

LC1 D115, D150

On 2 mounting rails DZ5 MB on 120 mm centres

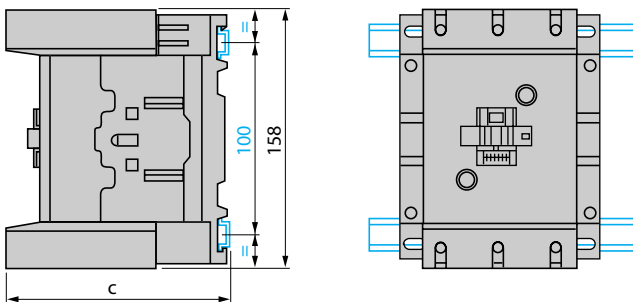

Control circuit: a.c. or d.c.

LC1	D115 and D150	D1156 and D1506
c (AM1 DP200 or DR200)	134,5	117,5
c (AM1 DE200 or ED●●●)	142,5	125,5

LC1 D09...D38 and LC1 DT20...DT40

On 2 mounting rails DZ5 MB

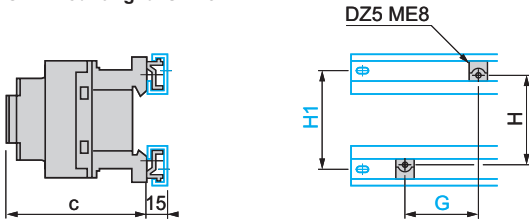

Control circuit:	a.c.		d.c.	
	D09...D18	D25...D38	D09...D18	D25...D38
LC1				
c with cover	86	92	95	101
G	35	35	35	35
H	60	60	70	70
H1	70	70	70	70

4-pole contactors

LC1	DT20 and DT25	DT32 and DT40	DT20 and DT25	DT32 and DT40
	c	92	100	101
G	35	35	35	35
H	60	60	70	70
H1	70	70	70	70

LC1 D09...D38 and LC1 DT20...DT40

On pre-slotted mounting plate AM1 PA, PB, PC

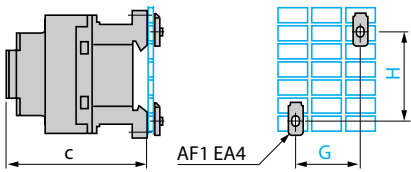

LC1 D40A...D65A, LC1 DT60A...DT80A

On pre-slotted mounting plate AM1 PA, PB, PC and panel mounted

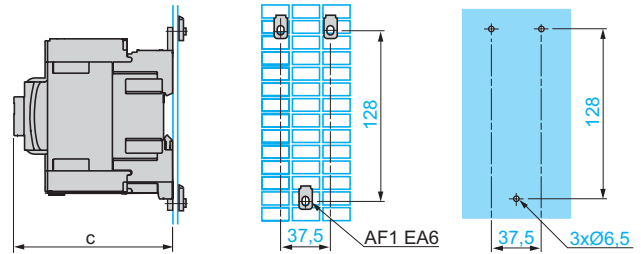

Control circuit:	a.c.		d.c.	
	D40A...65A, DT60A...DT80A	D40A...65A, DT60A...DT80A	D40A...65A, DT60A...DT80A	D40A...65A, DT60A...DT80A
LC1				
c with cover	120	120	120	120

Control circuit:	a.c.		d.c.	
	D09...D18	D25...D38	D09...D18	D25...D38
LC1				
c with cover	86	92	95	101
G	35	35	35	35
H	60/70	60/70	70	70
LC1	DT20 and DT25	DT32 and DT40	DT20 and DT25	DT32 and DT40
c with cover	80	93	118	132
G	35	35	35	35
H	60	60	70	70

LC1 D09...D38, LC1 DT20...DT40

Panel mounted

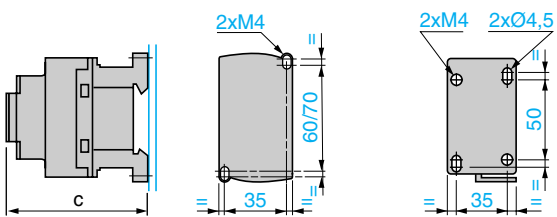

LC1 D80 and D95, LC1 D40008 and D65008, LP1 D80

On pre-slotted mounting plate AM1 PA, PB, PC and panel mounted

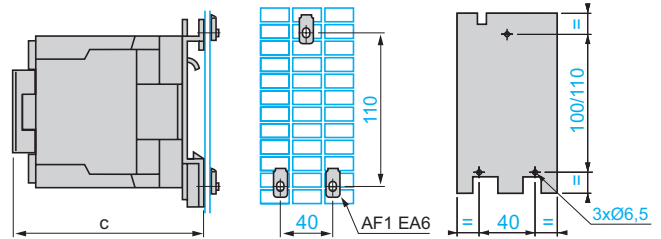

Control circuit:	a.c.		d.c.	
	D80 and D95, D40008 and D65008	D80 and D95, D40008 and D65008	D80 and D95, D40008 and D65008	D80 and D95, D40008 and D65008
LC1				
c with cover	130	130	186	186
LP1	–	–	D80	
c without cover	–	–	181	

Control circuit:	a.c.		d.c.	
	D09...D18	D25...D38	D09...D18	D25...D38
LC1				
c with cover	86	92	95	101
4-pole contactors				
LC1	DT20 and DT25	DT32 and DT40	DT20 and DT25	DT32 and DT40
c with cover	90	98	90	98

LC1 D115, D150

Panel mounted

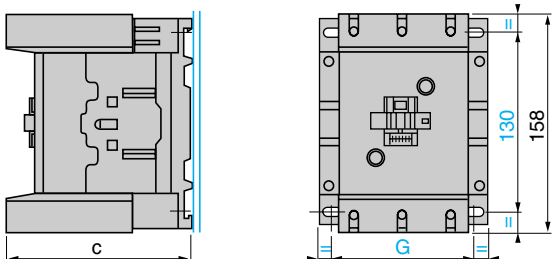

LC1	D115	D1156	D150	D1506
c	132	115	132	115
G (3-pole)	96/110	96/110	96/110	96/110
G (4-pole)	130/144	130/144	–	–

Selection: pages 5/194 to 5/225

Characteristics: pages 5/50 to 5/55

References: pages 5/62 to 5/67

Schemes: pages 5/96 and 5/97

Contactors

3-pole contactors (References: pages 5/62 to 5/65)

LC1 D09 to D150

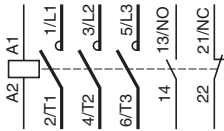

4-pole contactors (References: pages 5/66 and 5/67)

LC1 DT20 to DT80A

LC1 D115004

LC1 D098 to D258

LC1 and LP1 D40008 to D80008

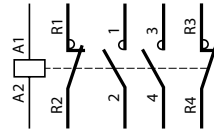
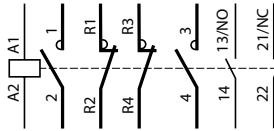
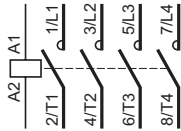
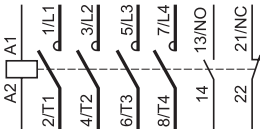

Front mounting add-on contact blocks

Instantaneous auxiliary contacts (References: page 5/79)

1 N/O LAD N10 (1)

1 N/C LAD N01 (1)

1 N/O + 1 N/C LAD N11

2 N/O LAD N20

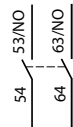
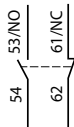
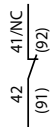
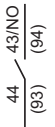

2 N/C LAD N02

2 N/O + 2 N/C LAD N22

1 N/O + 3 N/C LAD N13

4 N/O LAD N40

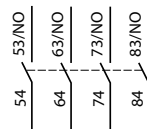
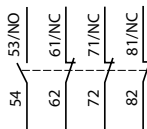
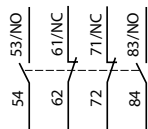
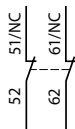

4 N/C LAD N04

2 N/O + 2 N/C including 1 N/O + 1 N/C make before break LAD C22

3 N/O + 1 N/C LAD N31

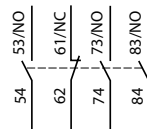
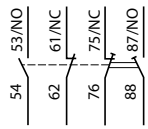
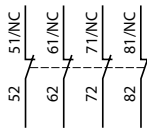

Instantaneous auxiliary contacts conforming to standard EN 50012 (References: page 5/79)

1 N/O + 1 N/C LAD N11G

1 N/O + 1 N/C LAD N11P

2 N/O + 2 N/C LAD N22G

2 N/O + 2 N/C LAD N22P

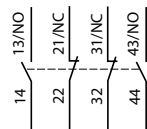
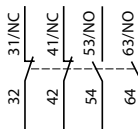
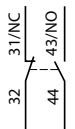

3 N/O + 1 N/C LAD N31G

3 N/O + 1 N/C LAD N31P

1 N/O + 3 N/C LAD N13G

1 N/O + 3 N/C LAD N13P

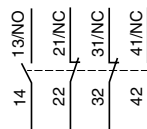
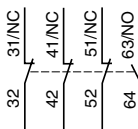
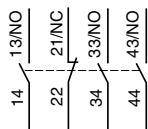
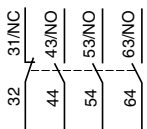

(1) Items in brackets refer to blocks mounted on right-hand side of contactor.

Front mounting add-on contact blocks

Dust and damp protected instantaneous auxiliary contacts (References: page 5/79)

2 N/O (24-50 V) LA1 DX20	2 N/C (24-50 V) LA1 DX02	2 N/O (5-24 V) LA1 DY20	2 N/O protected (24-50 V) 2 N/O standard LA1 DZ40	2 N/O protected (24-50 V) + 1 N/O + 1 N/C standard LA1 DZ31
-----------------------------	-----------------------------	----------------------------	--	--

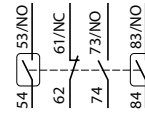
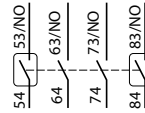
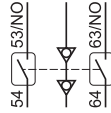
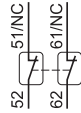
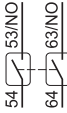

Time delay auxiliary contacts (References: page 5/80)

On-delay 1 N/O + 1 N/C LAD T	Off-delay 1 N/O + 1 N/C LADR	On-delay 1 N/C + 1 N/O break before make LAD S
------------------------------	------------------------------	--

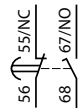
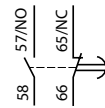
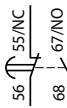

Mechanical latch blocks (References: page 5/80)

LAD 6K10 and LA6 DK20

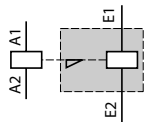

Side mounting add-on contact blocks

Instantaneous auxiliary contacts (References: page 5/79)

1 N/O + 1 N/C LAD 8N11 (1)	2 N/O LAD 8N20 (1)	2 N/O LAD 8N02 (1)
----------------------------	--------------------	--------------------

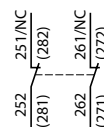
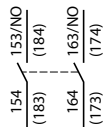
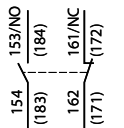

(1) Items in brackets refer to blocks mounted on right-hand side of contactor.

Electronic serial timer modules

On-delay LA4 DT●U

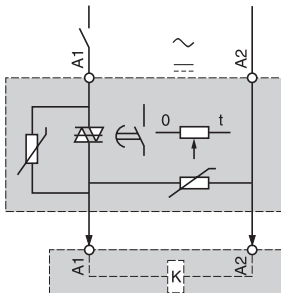

Interface modules

Relay output

LA4 DFB

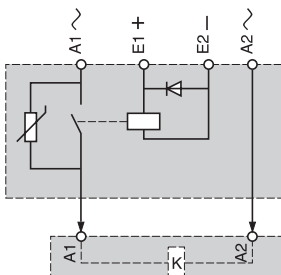

Solid state

LA4 DWB

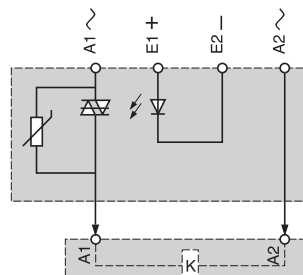

References: page 5/83.

LC2 D09 to D38

2 x LC1 D09 to D38

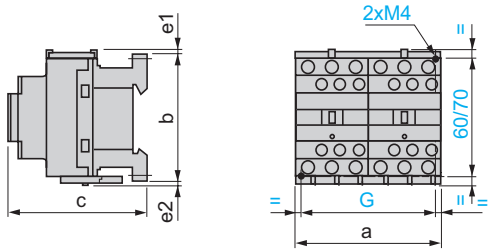

LC2 DT20 to DT40

2 x LC1 DT20 to DT40

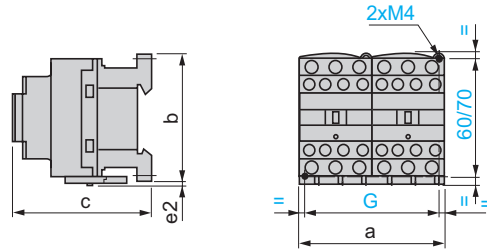

LC2 or 2 x LC1	a	b	c (1)	e1	e2	G
D09 to D18 ~	90	77	86	4	1.5	80
D093 to D123 ~	90	99	86	-	-	80
D09 to D18 ...	90	77	95	4	1.5	80
D093 to D123 ...	90	99	95	-	-	80
D25 to D38 ~	90	85	92	9	5	80
D183 to D383 ~	90	99	92	-	-	80
D25 to D32 ...	90	85	101	9	5	80
D183 to D383 ...	90	99	101	-	-	80

e1 and e2: including cabling.

(1) With safety cover, without add-on block.

LC2 or 2 x LC1	a	b	c	G
DT20 and DT25	90	85	90	80
DT32 and DT40	90	91	98	80

c, e: including cabling.

LC2 D40A to D65A

2 x LC1 D40A to D65A

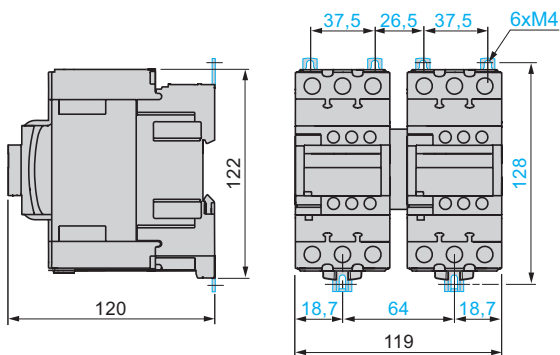

5

LC2 D80 and D95

2 x LC1 D80 and D95 ~

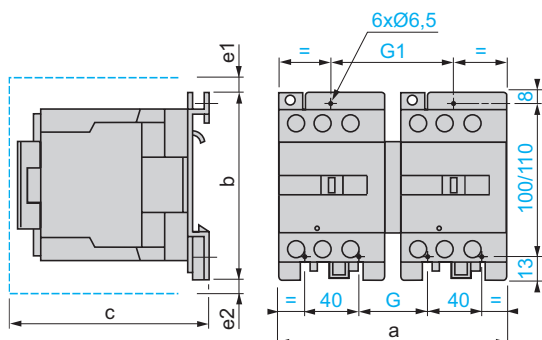

2 x LC1 D80 and D95 ...

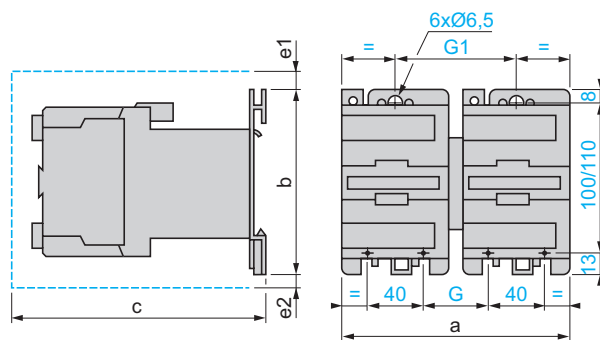

LC2 or 2 x LC1	a	b	c	e1	e2	G	G1
D80 and D95 ~	182	127	158	13	-	57	96
D80004 ~	207	127	158	-	20	71	111

c, e1 and e2: including cabling.

2 x LC1	a	b	c	e1	e2	G	G1
D80 and D95	207	127	215	13	20	96	111

c, e1 and e2: including cabling.

LC2 D115 and D150

2 x LC1 D115 and D150

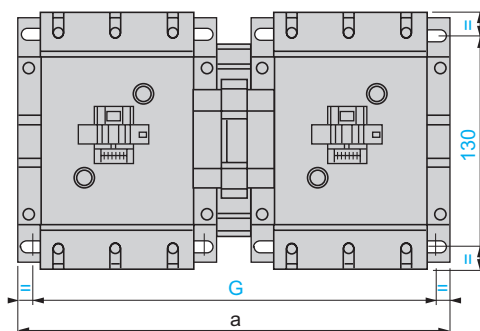
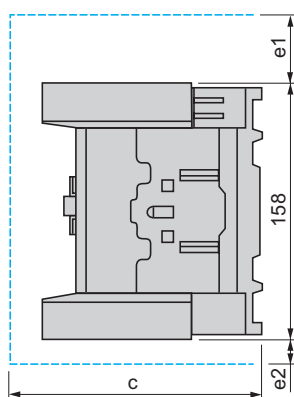

LC2 or 2 x LC1	a	c	e1	e2	G
D115 and D150	266	148	56	18	242/256
D115004	334	148	-	60	310/324

c, e1 and e2: including cabling.

Reversing contactors for motor control

LC2 D09...D150

Horizontally mounted

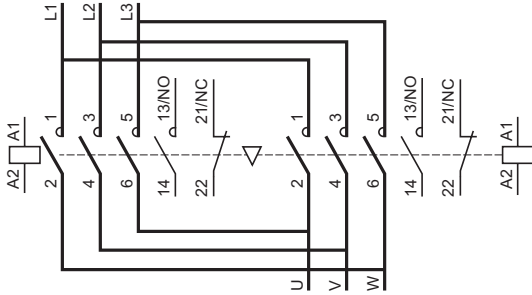

LAD 9R1V

With integral electrical interlocking

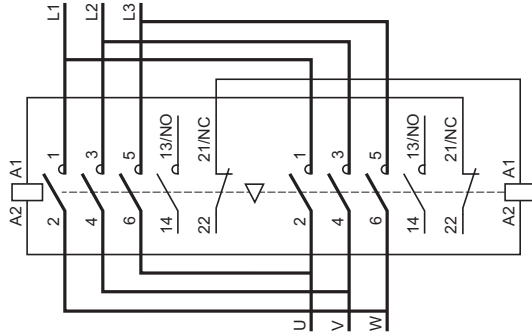

Changeover contactor pairs

LC2 DT20...DT40

Horizontally mounted

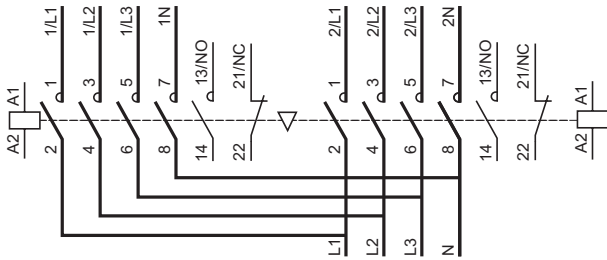

LAD T9R1V

With integral electrical interlocking

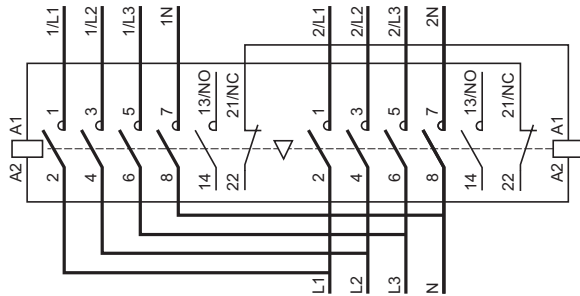

5

Electrical interlocking of reversing contactors fitted with:

Mechanical interlock with integral electrical contacts

LA9 D4002, LA9 D8002 and LA9 D11502

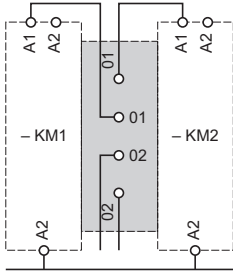

Mechanical interlock without integral electrical contacts

LAD 9V2, LAD 4CM, LA9 D50978 and LA9 D80978

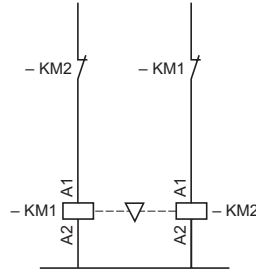

Low speed-High speed cabling kit, screw clamp terminals

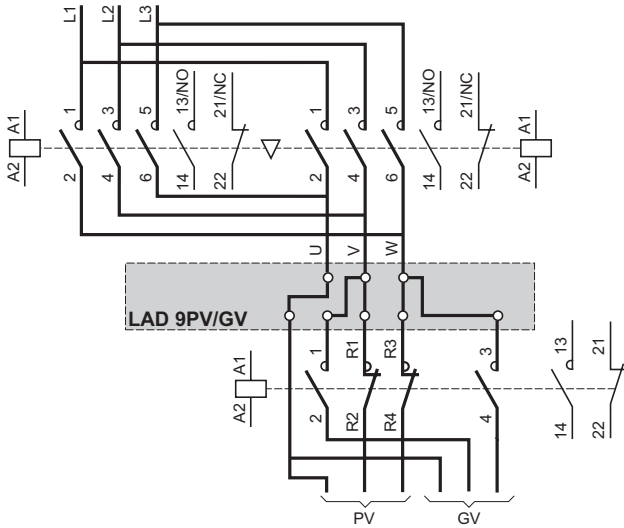

Low speed-High speed cabling kit, spring terminals

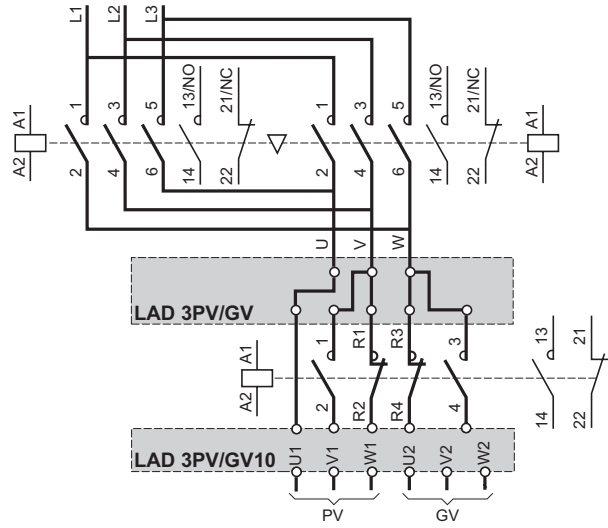

TeSys contactors

For switching 3-phase capacitor banks, used for power factor correction,

Direct connection without choke inductors

Special contactors

Special contactors **LC1 D●K** are designed for switching 3-phase, single or multiple-step capacitor banks; they conform to standards IEC 60070 and 60831, NFC 54-100, VDE 0560, UL and CSA.

Contactor applications

Specification

Contactors fitted with a block of early make poles and damping resistors, limiting the value of the current on closing to 60 In max.

This current limitation increases the life of all the components of the installation, in particular that of the fuses and capacitors.

The patented design of the add-on block (n° 90 119-20) ensures safety and long life of the installation.

Operating conditions

There is no need to use choke inductors for either single or multiple-step capacitor banks.

Short-circuit protection must be provided by gl type fuses rated at 1.7...2 In.

Maximum operational power

The power values given in the selection table below are for the following operating conditions:

Prospective peak current at switch-on	LC1 D●K	200 In
Maximum operating rate	LC1 DFK, DGK, DLK, DMK, DPK	240 operating cycles/hour
	LC1 DTK, DWK	100 operating cycles/hour
Electrical durability at nominal load	All contactor ratings	400 V 300 000 operating cycles
		690 V 200 000 operating cycles

Operational power at 50/60 Hz (1) $\theta \leq 55^\circ\text{C}$ (2)			Instantaneous auxiliary contacts		Tightening torque on cable end	Basic reference, to be completed by adding the voltage code (3)	Weight
220 V	400 V	660 V	N/O	N/C	N.m		kg
240 V	440 V	690 V					
kVAR	kVAR	kVAR					
6.7	12.5	18	1	1	1.2	LC1 DFK11●●	0.430
			–	2	1.2	LC1 DFK02●●	0.430
8.5	16.7	24	1	1	1.7	LC1 DGK11●●	0.450
			–	2	1.7	LC1 DGK02●●	0.450
10	20	30	1	1	1.9	LC1 DLK11●●	0.600
			–	2	1.9	LC1 DLK02●●	0.600
15	25	36	1	1	2.5	LC1 DMK11●●	0.630
			–	2	2.5	LC1 DMK02●●	0.630
20	33.3	48	1	2	5	LC1 DPK12●●	1.300
25	40	58	1	2	5	LC1 DTK12●●	1.300
40	60	92	1	2	9	LC1 DWK12●●	1.650

Switching of multiple-step capacitor banks (with equal or different power ratings)

The correct contactor for each step is selected from the above table, according to the power rating of the step to be switched.

Example: 50 kVAR 3-step capacitor bank. Temperature: 50 °C and U = 400 V or 440 V.

One 25 kVAR step: contactor LC1 DMK, one 15 kVAR step: contactor LC1 DGK, and one 10 kVAR step: contactor LC1 DFK.

(1) Operational power of the contactor according to the scheme on the page opposite.

(2) The average temperature over a 24-hour period, in accordance with standards IEC 60070 and 60831 is 45 °C.

(3) Standard control circuit voltages (for other voltages, please consult your Regional Sales Office):

Volts	24	42	48	110	115	220	230	240	380	400	415	440
50/60 Hz	B7	D7	E7	F7	FE7	M7	P7	U7	Q7	V7	N7	R7

For other voltages between 24 and 440 V, please consult your Regional Sales Office

511555



LC1 DFK11●●

511556



LC1 DPK12●●

5

Dimensions

LC1 DFK, DGK

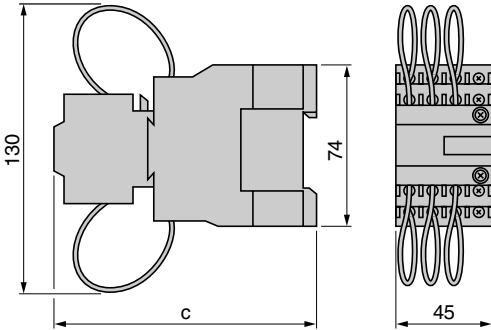

LC1 DPK, DTK

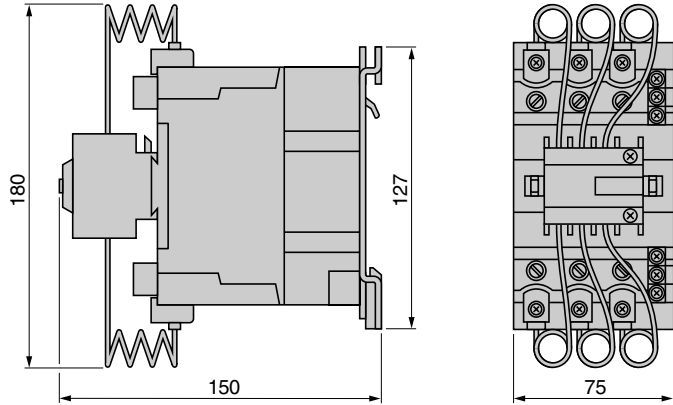

LC1	c	Type of fixing
DFK	117	LC1 D12 See page 5/94
DGK	122	LC1 D18 See page 5/94

LC1	Type of fixing
DPK	LC1 D40 See page 5/94
DTK	LC1 D50 See page 5/94

LC1 DLK, DMK

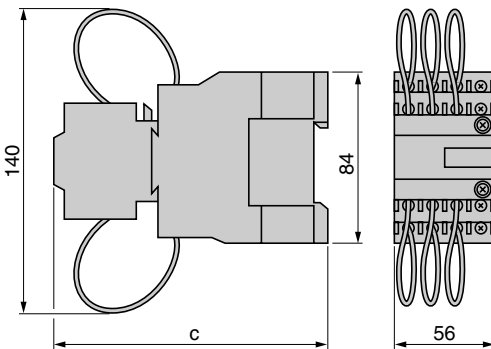

LC1 DWK

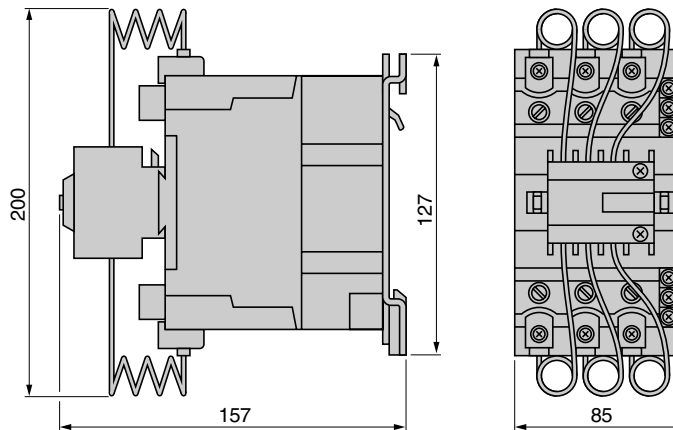

LC1	c	Type of fixing
DLK	117	LC1 D25 See page 5/94
DMK	122	LC1 D32 See page 5/94

LC1	Type of fixing
DWK	LC1 D80 See page 5/94

Schemes

LC1 D•K

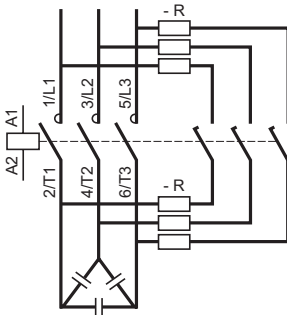

R = Pre-wired resistor connections.

Cabling (maximum permissible c.s.a.)

Contactor type LC1	DFK	DGK	DLK	DMK	DPK, DTK	DWK
Number of conductors	1	2	1	2	1	2
Flexible cable with cable end (mm ²)	2.5	1.5	4	2.5	4	4
Solid cable with cable end (mm ²)	4	4	6	6	10	6

Applications

Control of all types of motor for standard or severe duty applications
Control of resistive, inductive and capacitive circuits:
heating, lighting, cos φ rectification, transformers, normal-standby



Rated operational current Ie max. AC-3 (Ue ≤ 440 V)
Ie max. AC-1 (θ ≤ 40 °C)

115 A	150 A	185 A	225 A	265 A	330 A
200 A	250 A	275 A	315 A	350 A	400 A

Rated operational voltage

1000 V	1000 V	1000 V	1000 V	1000 V	1000 V
--------	--------	--------	--------	--------	--------

Number of poles

3 or 4	3 or 4	3 or 4	3 or 4	3 or 4	3 or 4
--------	--------	--------	--------	--------	--------

Rated operational power in category AC-3

220/240 V
380/400 V
415 V
440 V
500 V
660/690 V
1000 V

30 kW	40 kW	55 kW	63 kW	75 kW	100 kW
55 kW	75 kW	90 kW	110 kW	132 kW	160 kW
59 kW	80 kW	100 kW	110 kW	140 kW	180 kW
59 kW	80 kW	100 kW	110 kW	140 kW	200 kW
75 kW	90 kW	110 kW	129 kW	160 kW	200 kW
80 kW	100 kW	110 kW	129 kW	160 kW	220 kW
65 kW	65 kW	100 kW	100 kW	147 kW	160 kW

Add-on auxiliary contact blocks

Front mounting, identical to those used on LC1 D contactors (contacts: instantaneous LA1 DN●●, time delay LA2 DT or LA3 DR, dust and damp protected LA1 DX or DY or DZ)

Associated thermal overload relays and controllers

Manual-auto
Electronic

LR9 F
TeSys T

Interfaces

Specific
Universal

LA4 FWB
With or without, depending on the control circuit

Contactor type

LC1 F115	LC1 F150	LC1 F185	LC1 F225	LC1 F265	LC1 F330
----------	----------	----------	----------	----------	----------

Reversing contactor type

LC2 F115	LC2 F150	LC2 F185	LC2 F225	LC2 F265	For customer assembly
----------	----------	----------	----------	----------	-----------------------

Pages

Contactors
Reversing contactors

5/114 and 5/115	5/114 and 5/115
5/116 and 5/117	5/118 to 5/121

5

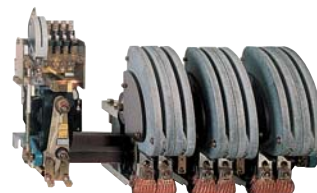

400 A	500 A	630 A	780 A	800 A	–	–	750 A	1000 A	1500 A	1800 A
500 A	700 A	1000 A	1600 A	1000 A	1700 A	2100 A	800 A	1250 A	2000 A	2750 A
1000 V	1000 V	1000 V	1000 V	1000 V	1000 V	1000 V	1000 V	1000 V	1000 V	1000 V
2, 3 or 4	2, 3 or 4	2, 3 or 4	3 or 4	3	3	3	1 to 4	1 to 4	1 to 4	1 to 4
110 kW	147 kW	200 kW	220 kW	250 kW	–	–	220 kW	280 kW	425 kW	500 kW
200 kW	250 kW	335 kW	400 kW	450 kW	–	–	400 kW	500 kW	750 kW	900 kW
220 kW	280 kW	375 kW	425 kW	450 kW	–	–	425 kW	530 kW	800 kW	900 kW
250 kW	295 kW	400 kW	425 kW	450 kW	–	–	450 kW	560 kW	800 kW	900 kW
257 kW	355 kW	400 kW	450 kW	450 kW	–	–	500 kW	600 kW	700 kW	900 kW
280 kW	335 kW	450 kW	475 kW	475 kW	–	–	560 kW	670 kW	750 kW	900 kW
185 kW	335 kW	450 kW	450 kW	450 kW	–	–	530 kW	530 kW	670 kW	750 kW

Front mounting, identical to those used on LC1 D contactors (contacts: instantaneous LA1 DN●●, time delay LA2 DT or LA3 DR, dust and damp protected LA1 DX or DY or DZ)

4 instantaneous contact compositions: 2 N/C + 2 N/O, 3 N/O + 1 N/C, 1 N/O + 3 N/C or 4 N/O

LR9 F	–	–	LR9 F
TeSys T	–	–	TeSys T
LA4 FWB	–	–	–
With or without, depending on the control circuit	–	–	–

LC1 F400	LC1 F500	LC1 F630	LC1 F780	LC1 F800	LC1 F1700	LC1 F2100	LC1 BL	LC1 BM	LC1 BP	LC1 BR
----------	----------	----------	----------	----------	-----------	-----------	--------	--------	--------	--------



For customer assembly

5/114 and 5/115	5/184 and 5/185
5/118 to 5/117	5/186

TeSys contactors



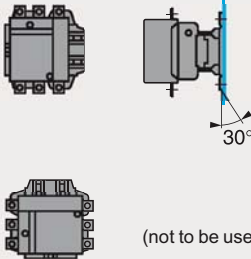
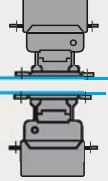

TeSys F contactors (115 to 2100 A)

Control circuit: a.c. or d.c.

Environment					
Contactor type					
Rated insulation voltage (Ui)	Conforming to IEC 60947-4-1	V	LC1 F115 1000	LC1 F150 1000	LC1 F185 1000
	Conforming to VDE 0110 gr C	V	1500	1500	1500
Rated impulse withstand voltage (Uimp)	Coil not connected to the power circuit	kV	8	8	8
Conforming to standards			EN 60947-1, EN 60947-4-1, IEC 60947-1, IEC 60947-4-1, JEM 1038		
Product certifications			CSA, UL, BV, GL, DNV, RINA, RMROS, LROS, CCC		
Degree of protection	Conforming to IEC 60529		IP 2X front face with shrouds LA9 F		
	Conforming to VDE 0106		Front face protected against direct finger contact with shrouds LA9 F		
Protective treatment	Standard version		"TH"		
Ambient air temperature around the device	Storage	°C	- 60... + 80		
	Operation	°C	- 5... + 55		
	Permissible at Uc (1)	°C	- 40... + 70		
Maximum operating altitude	Without derating	m	3000		
Operating positions	Without derating		 <p>(not to be used for LC1 F780, F1700 and F2100)</p>		
			 <p>Apply the following derating coefficients: 0.75 on the pull-in voltage, 0.9 on the drop-out voltage and 0.8 on the operational current in AC-1</p> <p>Apply the following derating coefficients: 1.15 on the pull-in voltage, 1.1 on the drop-out voltage and 0.8 on the operational current in AC-1</p> <p>In either case: neither the making and breaking capacities nor the electrical and mechanical durabilities can be assured.</p>		
	Not to be used				
Shock resistance (2) 1/2 sine wave = 11 ms	Contactor open		9 gn	9 gn	7 gn
	Contactor closed		15 gn	15 gn	15 gn
Vibration resistance (2) 5...300 Hz	Contactor open		2 gn	2 gn	2 gn
	Contactor closed		6 gn	6 gn	5 gn

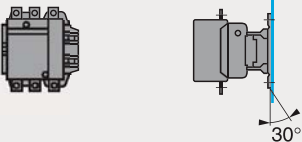
(1) In these conditions, it is recommended that LX9 F coils be used for contactor sizes F115 to F225.

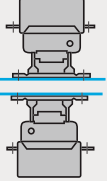
(2) In the least favourable direction, without change of contact state (coil at Uc). Where higher resistance to mechanical shock is required, select shock-proof contactors. Please consult your Regional Sales Office.

LC1 F225	LC1 F265	LC1 F330	LC1 F400	LC1 F500	LC1 F630	LC1 F780	LC1 F800	LC1 F1700	LC1 F2100
1000	1000	1000	1000	1000	1000	1000	1000	1000	1000
1500	1500	1500	1500	1500	1500	1500	1500	1500	1500
8	8	8	8	8	8	8	8	8	8
EN 60947-1, EN 60947-4-1, IEC 60947-1, IEC 60947-4-1, JEM 1038									
CSA, UL, BV, GL, DNV, RINA, RMROS, LROS, CCC							UL, CSA, GL, LROS	UL, CSA, CCC (pending)	
IP 20 front face with shrouds LA9 F								-	
Front face protected against direct finger contact with shrouds LA9 F								-	
"TH"									
- 60...+ 80							- 60...+ 80	- 60...+ 80	
- 5...+ 55							- 5...+ 55	- 5...+ 40	
- 40...+ 70							- 5...+ 55	- 40...+ 60	
3000									
  (not to be used for LC1 F780, F1700 and F2100)									
 Apply the following derating coefficients: 0.75 on the pull-in voltage, 0.9 on the drop-out voltage and 0.8 on the operational current in AC-1. Apply the following derating coefficients: 1.15 on the pull-in voltage, 1.1 on the drop-out voltage and 0.8 on the operational current in AC-1. In either case: neither the making and breaking capacities nor the electrical and mechanical durabilities can be assured								Not to be used	
									
7 gn	6 gn	6 gn	6 gn	9 gn	6 gn	5 gn	6 gn	6 gn	6 gn
15 gn	15 gn	15 gn	15 gn	15 gn	15 gn	15 gn	15 gn	15 gn	15 gn
2 gn	2 gn	2 gn	1.5 gn	2 gn	2 gn	2.5 gn	2 gn	2 gn	2 gn
5 gn	5 gn	5 gn	5 gn	4 gn	4 gn	5.5 gn	4 gn	4 gn	4 gn

Pole characteristics						
Contactor type			LC1 F115	LC1 F150	LC1 F185	
Number of poles			3 or 4	3 or 4	3 or 4	
Rated operational current (I _e)(U _e ≤ 440 V)	In AC-3, θ ≤ 55 °C	A	115	150	185	
	In AC-1, θ ≤ 40 °C	A	200	250	275	
Rated operational voltage (U _e)	Up to	V	1000	1000	1000	
Frequency limits	Of the operational current (1)	Hz	16 ^{2/3} ...200	16 ^{2/3} ...200	16 ^{2/3} ...200	
Conventional thermal current	θ ≤ 40 °C	A	200	250	275	
Rated making capacity	I _{rms} conforming to IEC 60947-4-1	A	Making current: 10 x I in AC-3 or 12 x I in AC-4			
Rated breaking capacity	I _{rms} conforming to IEC 60947-4-1	A	Making and breaking current: 8 x I in AC-3 or 10 x I in AC-4			
Maximum permissible current No current flowing for previous 60 minutes, at θ ≤ 40 °C	For 10 s	A	1100	1200	1500	
	For 30 s	A	640	700	920	
	For 1 min	A	520	600	740	
	For 3 min	A	400	450	500	
	For 10 min	A	320	350	400	
Short-circuit protection by fuses U ≤ 440 V	Motor circuit (type aM)	A	125	160	200	
	With thermal overload relay (type gG)	A	200	200	315	
	gG fuses	A	200	250	315	
Average impedance per pole	At I _{th} and 50 Hz	mΩ	0.37	0.35	0.33	
Power dissipation per pole for the above operational currents	AC-3	W	5	8	12	
	AC-1	W	15	22	25	
Connection	Bar		Maximum c.s.a.			
	Number of bars		2	2	2	
		Bar	mm	20 x 3	25 x 3	25 x 3
	Cable with lug		mm ²	95	120	150
	Cable with connector		mm ²	95	120	150
Bolt diameter		mm	Ø 6	Ø 8	Ø 8	
Tightening torque	Power circuit connections	N.m	10	18	18	

(1) Sine wave without interference. Above these values, please consult your Regional Sales Office.

(2) With set of right-angled connectors **LA9 F2100** (see page 5/125).

(3) Paralleling of poles must be carried out only in accordance with the fuse manufacturer's recommendations.

LC1 F225	LC1 F265	LC1 F330	LC1 F400	LC1 F500	LC1 F630	LC1 F780	LC1 F800	LC1 F1700	LC1 F2100
3 or 4	3 or 4	3 or 4	2, 3 or 4	2, 3 or 4	2, 3 or 4	3 or 4	3	3	3
225	265	330	400	500	630	780	800	–	–
315	350	400	500	700	1000 1250	1600	1000	1700	2100 (2)
1000	1000	1000	1000	1000	1000	1000	1000	1000	1000
16 ^{2/3} ...200	16 ^{2/3} ...200	16 ^{2/3} ...200	16 ^{2/3} ...200	16 ^{2/3} ...200	16 ^{2/3} ...200	16 ^{2/3} ...200	16 ^{2/3} ...200	16 ^{2/3} ...200	16 ^{2/3} ...200
315	350	400	500	700	1000 1250	1600	1000	1700	2100 (2)
Making current: 10 x I in AC-3 or 12 x I in AC-4								Making current: 1.5 x I in AC-1	
Making and breaking current: 8 x I in AC-3 or 10 x I in AC-4								Making and breaking current: 1.5 x I in AC-1	
1800	2200	2650	3600	4200	5050	6250	5500	–	–
1000	1230	1800	2400	3200	4400	5600	4600	–	–
850	950	1300	1700	2400	3400	4600	3600	–	–
560	620	900	1200	1500	2200	3000	2600	–	–
440	480	750	1000	1200	1600	2200	1700	–	–
250	315	400	400	500	630	800	800	–	–
315	500	500	630	800	800	1000	1000	–	–
315	400	500	500	800	1000	2 x 800 (3)	1000	2 x 800 (3)	2 x 1000 (3)
0.32	0.3	0.28	0.26	0.18	0.12	0.10	0.12	0.10	0.10
16	21	31	42	45	48	60	77	–	–
32	37	44	65	88	120	250	120	200	200
2	2	2	2	2	2 3	2	2	3	4
32 x 4	32 x 4	30 x 5	30 x 5	40 x 5	60 x 5 60 x 5	100 x 5	60 x 5	100 x 5	100 x 5
185	240	240	2 x 150	2 x 240	–	–	–	–	–
185	240	–	–	–	–	–	–	–	–
∅10	∅10	∅10	∅10	∅10	∅12	2 x ∅12	∅12	∅12 (∅10 with set of right-angled connectors LA9 F2100)	
35	35	35	35	35	58	58	58	58 (35 with set of right-angled connectors LA9 F2100)	

Control circuit characteristics with LX1 or LX9 coil					
Contactor type			LC1 F115	LC1 F150	LC1 F185
Rated control circuit voltage (Uc)	50 or 60 Hz	V	24...1000		
Control voltage limits ($\theta \leq 55^\circ\text{C}$)					
50 or 60 Hz coils	Operation		0.85...1.1 Uc		
	Drop-out		0.35...0.55 Uc		
40...400 Hz coils	Operation		-		
	Drop-out		-		
Average consumption at 20 °C and at Uc					
~ 50 Hz Inrush	50 Hz coil	VA	550	550	805
	40...400 Hz coil	VA	-	-	-
	Cos φ		0.3	0.3	0.3
Sealed	50 Hz coil	VA	45	45	55
	40...400 Hz coil	VA	-	-	-
	Cos φ		0.3	0.3	0.3
~ 60 Hz Inrush	60 Hz coil	VA	660	660	970
	40...400 Hz coil	VA	-	-	-
	Cos φ		0.3	0.3	0.3
Sealed	60 Hz coil	VA	55	55	66
	40...400 Hz coil	VA	-	-	-
	Cos φ		0.3	0.3	0.3
Heat dissipation		W	12...16	12...16	18...24
Operating time (1)	Closing "C"	ms	23...35	23...35	20...35
	Opening "O"	ms	5...15	5...15	7...15
Mechanical durability at Uc	In millions of operating cycles		10	10	10
Maximum operating rate at ambient temperature $\leq 55^\circ\text{C}$	In operating cycles per hour		2400	2400	2400
Connection					
Flexible cable without cable end	1 or 2 conductors	mm ²	Min/max c.s.a. 1/4	1/4	1/4
	1 conductor	mm ²	1/4	1/4	1/4
Flexible cable with cable end	2 conductors	mm ²	1/2.5	1/2.5	1/2.5
	1 or 2 conductors	mm ²	1/4	1/4	1/4
Solid cable without cable end	1 or 2 conductors	mm ²	1/4	1/4	1/4
Tightening torque		N.m	1.2	1.2	1.2
Mechanical latching	Mechanical latch blocks LA6 DK must not be fitted on LC1 F contactors. For similar type of operation, use magnetic latching contactors CR1 F. See pages 5/240 to 5/267				

(1) The closing time "C" is measured from the moment the coil supply is switched on to initial contact of the main poles. The opening time "O" is measured from the moment the coil supply is switched off to the moment the main poles separate.

(2) Control circuit characteristics with LX1 coil.

LC1 F225	LC1 F265	LC1 F330	LC1 F400	LC1 F500	LC1 F630	LC1 F780	LC1 F800	LC1 F1700	LC1 F2100
24...1000			48...1000		48...1000	110...500	110...400	110...500 (2)	110...500 (2)
0.85...1.1 Uc	-								
0.35...0.55 Uc	-								
-	0.85...1.1 Uc	0.85...1.1 Uc			0.85...1.1 Uc	0.85...1.1 Uc	0.85...1.1 Uc	0.85...1.1 Uc	0.85...1.1 Uc
-	0.35...0.55 Uc	0.3...0.5 Uc			0.25...0.5 Uc	0.2...0.4 Uc	0.3...0.5 Uc	0.3...0.5 Uc	0.3...0.5 Uc
805	-	-	-	-	-	-	-	-	-
-	650	650	1075	1100	1650	2100	1700	2200	2200
0.3	0.9	0.9	0.9	0.9	0.9	0.9	0.9	0.9	0.9
55	-	-	-	-	-	-	-	-	-
-	10	10	15	18	22	50	12	36	36
0.3	0.9	0.9	0.9	0.9	0.9	0.9	-	0.9	0.9
970	-	-	-	-	-	-	-	-	-
-	650	650	1075	1100	1650	2100	1700	2200	2200
0.3	0.9	0.9	0.9	0.9	0.9	0.9	0.9	0.9	0.9
66	-	-	-	-	-	-	-	-	-
-	10	10	15	18	22	50	12	36	36
0.3	0.9	0.9	0.9	0.9	0.9	0.9	-	0.9	0.9
18...24	8	8	14	18	20	2 x 22	25	2 x 18	2 x 18
20...35	40...65	40...65	40...75	40...75	40...80	40...80	60...80	40...75	40...75
7...15	100...170	100...170	100...170	100...170	100...200	130...230	150...180	100...170	100...170
10	10	10	10	10	5	5	5	5	5
2400	2400	2400	2400	2400	1200	600	600	600	600
Min/max c.s.a.									
1/4	1/4	1/4	1/4	1/4	1/4	1/4	1/4	1/4	1/4
1/4	1/4	1/4	1/4	1/4	1/4	1/4	1/4	1/4	1/4
1/2.5	1/2.5	1/2.5	1/2.5	1/2.5	1/2.5	1/2.5	1/2.5	1/2.5	1/2.5
1/4	1/4	1/4	1/4	1/4	1/4	1/4	1/4	1/4	1/4
1.2	1.2	1.2	1.2	1.2	1.2	1.2	1.2	1.2	1.2
Mechanical latch blocks LA6 DK must not be fitted on LC1 F contactors. For similar type of operation, use magnetic latching contactors CR1 F. See pages 5/240 to 5/267.									

Control circuit characteristics with LX4 coil

Contactor type			LC1 F115	LC1 F150	LC1 F185	
Rated control circuit voltage (Uc)	---	V	24...460	24...460	24...460	
Control voltage limits (θ ≤ 55 °C)	Operation		0.85...1.1 Uc	0.85...1.1 Uc	0.85...1.1 Uc	
	Drop-out		0.15...0.2 Uc	0.15...0.2 Uc	0.15...0.2 Uc	
Average consumption at 20 °C and at Uc	---	Inrush	W	560	560	800
		Sealed	W	4.5	4.5	5
Average operating time at Uc (1)	Closing "C"	ms	30...40	30...40	30...40	
	Opening "O"	ms	30...50	30...50	30...50	
<i>Note: The arcing time depends on the circuit switched by the poles. For all normal 3-phase applications, the arcing time is less than 10 ms. The load is isolated from the supply after a time equal to the sum of the opening time and the arcing time.</i>						
Mechanical durability at Uc	In millions of operating cycles		10	10	10	
Maximum operating rate at ambient temperature ≤ 55 °C	In operating cycles per hour		2400	2400	2400	
Cabling						
Flexible cable without cable end	1 conductor	mm²	Min/max c.s.a. 1/4	1/4	1/4	
	2 conductors	mm²	1/4	1/4	1/4	
Flexible cable with cable end	1 conductor	mm²	1/4	1/4	1/4	
	2 conductors	mm²	1/2.5	1/2.5	1/2.5	
Solid cable without cable end	1 conductor	mm²	1/4	1/4	1/4	
	2 conductors	mm²	1/4	1/4	1/4	
Tightening torque		N.m	1.2	1.2	1.2	
Mechanical latching						
Mechanical latch blocks LA6 DK must not be fitted on LC1 F contactors. For similar type of operation, use magnetic latching contactors CR1 F. See pages 5/240 to 5/267.						

(1) The operating times depend on the type of contactor electromagnet and its control mode. The closing time "C" is measured from the moment the coil supply is switched on to initial contact of the main poles. The opening time "O" is measured from the moment the coil supply is switched off to the moment the main poles separate.

LC1 F225	LC1 F265	LC1 F330	LC1 F400	LC1 F500	LC1 F630	LC1 F780	LC1 F800	LC1 F1700	LC1 F2100
24...460	24...460	24...460	48...440	48...440	48...440	110...440	110...400	110...440	110...440
0.85...1.1 Uc	0.85...1.1 Uc	0.85...1.1 Uc	0.85...1.1 Uc	0.85...1.1 Uc	0.85...1.1 Uc	0.85...1.1 Uc	0.85...1.1 Uc	0.85...1.1 Uc	0.85...1.1 Uc
0.15...0.2 Uc	0.15...0.2 Uc	0.15...0.2 Uc	0.2...0.35 Uc	0.2...0.35 Uc	0.2...0.35 Uc	0.2...0.4 Uc	0.3...0.5 Uc	0.2...0.35 Uc	0.2...0.35 Uc
800	750	750	1000	1100	1600	2 x 1000	1900	2100	2100
5	5	5	6	6	9	2 x 21	12	10	10
30...40	40...50	40...50	50...60	50...60	60...70	70...80	60...80	50...60	50...60
30...50	40...65	40...65	45...60	45...60	40...50	100...130	40...50	45...60	45...60
Note: The arcing time depends on the circuit switched by the poles. For all normal 3-phase applications, the arcing time is less than 10 ms. The load is isolated from the supply after a time equal to the sum of the opening time and the arcing time.									
10	10	10	10	10	5	5	5	5	5
2400	2400	2400	2400	2400	1200	600	600	600	600
Min/max c.s.a.									
1/4	1/4	1/4	1/4	1/4	1/4	1/4	1/4	1/4	1/4
1/4	1/4	1/4	1/4	1/4	1/4	1/4	1/4	1/4	1/4
1/4	1/4	1/4	1/4	1/4	1/4	1/4	1/4	1/4	1/4
1/2.5	1/2.5	1/2.5	1/2.5	1/2.5	1/2.5	1/2.5	1/2.5	1/2.5	1/2.5
1/4	1/4	1/4	1/4	1/4	1/4	1/4	1/4	1/4	1/4
1/4	1/4	1/4	1/4	1/4	1/4	1/4	1/4	1/4	1/4
1.2	1.2	1.2	1.2	1.2	1.2	1.2	1.2	1.2	1.2
Mechanical latch blocks LA6 DK must not be fitted on LC1 F contactors. For similar type of operation, use magnetic latching contactors CR1 F. See pages 5/240 to 5/267.									

TeSys contactors

TeSys F contactors for motor control in utilisation category AC-3 (115 to 800 A)

Control circuit: a.c. or d.c.



LC1 F225



LC1 F630

3-pole contactors

Standard power ratings of 3-phase motors 50-60 Hz in category AC-3								Rated operational current in AC-3	Basic reference, to be completed by adding the voltage code (2)	Weight
220 V	380 V	440 V	660 V	440 V	660 V	1000 V	up to	A	Screw fixing, cabling (1)	kg
kW	kW	kW	kW	kW	kW	kW				
30	55	59	59	75	80	65		115	LC1 F115●●	3.430
40	75	80	80	90	100	65		150	LC1 F150●●	3.430
55	90	100	100	110	110	100		185	LC1 F185●●	4.650
63	110	110	110	129	129	100		225	LC1 F225●●	4.750
75	132	140	140	160	160	147		265	LC1 F265●●	7.440
100	160	180	200	200	220	160		330	LC1 F330●●	8.600
110	200	220	250	257	280	185		400	LC1 F400●●	9.100
147	250	280	295	355	335	335		500	LC1 F500●●	11.350
200	335	375	400	400	450	450		630	LC1 F630●●	18.600
220	400	425	425	450	475	450		780	LC1 F780●●	39.500
250	450	450	450	450	475	450		800	LC1 F800●●	18.750

Note: auxiliary contact blocks, modules and accessories: see pages 5/122 to 5/127.

(1) Power terminals can be protected against direct finger contact by the addition of shrouds, to be ordered separately, except on contactors LC1 F780 (see page 5/126).

(2) Standard control circuit voltages (for other voltages, please consult your Regional Sales Office).

Volts ~	24	48	110	115	120	208	220	230	240	380	400	415	440
LC1 F115...F225													
50 Hz (coil LX1)	B5	E5	F5	FE5	-	-	M5	P5	U5	Q5	V5	N5	-
60 Hz (coil LX1)	-	E6	F6	-	G6	L6	M6	-	U6	Q6	-	-	R6
40...400 Hz (coil LX9)	-	E7	F7	FE7	G7	L7	M7	P7	U7	Q7	V7	N7	R7
LC1 F265...F330													
40...400 Hz (coil LX1)	B7	E7	F7	FE7	G7	L7	M7	P7	U7	Q7	V7	N7	R7
LC1 F400...F630													
40...400 Hz (coil LX1)	-	E7	F7	FE7	G7 (3)	L7	M7	P7	U7	Q7	V7	N7	R7
LC1 F780													
40...400 Hz (coil LX1)	-	-	F7	FE7	F7	L7	M7	P7	U7	Q7	V7	N7	R7
LC1 F800													
40...400 Hz (coil LX4) (4)	-	-	FW	FW	FW	-	MW	MW	MW	QW	QW	QW	-

Volts ---	24	48	110	125	220	230	250	400	440
LC1 F115...F330									
(coil LX4 F)	BD	ED	FD	GD	MD	MD	UD	-	RD
LC1 F400...F630									
(coil LX4 F)	-	ED	FD	GD	MD	-	UD	-	RD
LC1 F780									
(coil LX4 F)	-	-	FD	GD	MD	-	UD	-	RD
LC1 F800									
(coil LX4 F)	-	-	FW	FW	MW	MW	-	QW	-

(3) F7 for LC1 F630.

(4) Coil LX4 F8●● + rectifier DR5TE●●.

TeSys contactors

TeSys F contactors for control in category AC-1,
(200 to 2100 A)

Control circuit: a.c. or d.c.



LC1 F1854



LC1 F4004



LC1 F6304



LC1 F1700



LC1 F2100

2, 3 or 4-pole contactors

Maximum current in AC-1 ($\theta \leq 40^\circ\text{C}$)	Number of poles	Basic reference, to be completed by adding the voltage code (2) Screw fixing, cabling (1)	Weight
A			kg
200	3	LC1 F115●●	3.430
	4	LC1 F1154●●	3.830
250	3	LC1 F150●●	3.430
	4	LC1 F1504●●	3.830
275	3	LC1 F185●●	4.650
	4	LC1 F1854●●	5.450
315	3	LC1 F225●●	4.750
	4	LC1 F2254●●	5.550
350	3	LC1 F265●●	7.440
	4	LC1 F2654●●	8.540
400	3	LC1 F330●●	8.600
	4	LC1 F3304●●	9.500
500	2	LC1 F4002●●	8.000
	3	LC1 F400●●	9.100
	4	LC1 F4004●●	10.200
700	2	LC1 F5002●●	9.750
	3	LC1 F500●●	11.350
	4	LC1 F5004●●	12.950
1000	2	LC1 F6302●●	15.500
	3	LC1 F630●●	18.600
	4	LC1 F6304●●	21.500
1250	2	LC1 F6302●●S011	15.500
	3	LC1 F630●●S011	18.600
	4	LC1 F6304●●S011	21.500
1600	3	LC1 F780●●	39.500
	4	LC1 F7804●●	48.000
1700	3	LC1 F1700	30.000
2100 (3)	3	LC1 F2100	31.000

Note: auxiliary contact blocks, modules and accessories: see pages 5/122 to 5/127

(1) Power terminals can be protected against direct finger contact by the addition of shrouds, to be ordered separately (except **LC1 F780**, **LC1 F1700** and **LC1 F2100**), see page 5/126 .

(2) Standard control circuit voltages, see previous page.

(3) With set of right-angled connectors **LA9 F2100** (see page 5/125).

TeSys contactors

TeSys F reversing contactors for motor control in utilisation category AC-3 (115 to 265 A), pre-assembled

Control circuit: a.c. or d.c.

523097



LC2 F115

3-pole reversing contactors (horizontally mounted) (1)

Pre-wired power connections

Standard power ratings of 3-phase motors 50/60 Hz in category AC-3							Operational current in AC-3	Maximum operational voltage	Contactors supplied without coil (2) Complete reference	Weight
220 V 380 V 230 V 400 V 415 V 440 V 500 V 575 V 690 V 1000 V							440 V up to		Fixing, cabling (3)	kg
kW	kW	kW	kW	kW	kW	kW	A	V		
30	55	59	59	75	80	65	115	1000	LC2 F115	7.560
40	75	80	80	90	100	65	150	1000	LC2 F150	7.560
55	90	100	100	110	110	100	185	1000	LC2 F185	10.100
63	110	110	110	129	129	100	225	1000	LC2 F225	14.200
75	132	140	140	160	160	147	265	1000	LC2 F265	16.480

Accessories (to be ordered separately)

Description	For reversing contactors	Quantity required	Reference	Weight kg
Power terminal protection shrouds	LC2 F115	2	LA9 F701	0.250
	LC2 F150, F185	2	LA9 F702	0.250
	LC2 F225, F265	2	LA9 F703	0.250
Auxiliary contact blocks and add-on modules	–	–	See pages 5/122 to 5/127	

(1) Fitted with a mechanical interlock without electrical interlocking. Order separately 2 auxiliary contact blocks **LAD No1** to obtain electrical interlocking between the 2 contactors, see page 5/123 For accessories, see pages 5/124 to 5/127

(2) Coils to be ordered separately:
 - a.c. supply, see pages 5/130 and 5/131,
 - d.c. supply, see page 5/133

(3) Screw fixing.
 Power terminals can be protected against direct finger contact by the addition of shrouds, to be ordered separately, see above.

TeSys contactors

TeSys F changeover contactor pairs for control in utilisation category AC-1 (200 to 350 A), pre-assembled

Control circuit: a.c. or d.c.

5200988



LC2 F1854

4-pole changeover contactor pairs (horizontally mounted) (1)

Pre-wired power connections

Utilisation category AC-1 Non inductive loads Maximum operational current $\theta < 40\text{ }^{\circ}\text{C}$	Maximum operational voltage	Contactors supplied without coil (2) Complete reference Fixing, cabling (3)	Weight
A	V		kg
200	1000	LC2 F1154	8.860
250	1000	LC2 F1504	8.860
275	1000	LC2 F1854	12.100
315	1000	LC2 F2254	15.200
350	1000	LC2 F2654	19.480

Accessories (to be ordered separately)

Description	For changeover pairs	Quantity required	Reference	Weight kg
Power terminal protection shrouds	LC2 F1154	2	LA9 F706	0.250
	LC2 F1504, F1854	2	LA9 F707	0.250
	LC2 F2254, F2654	2	LA9 F708	0.250
Auxiliary contact blocks and add-on modules	–	–	See pages 5/122 to 5/127	

(1) Fitted with a mechanical interlock without electrical interlocking. Order separately 2 auxiliary contact blocks **LAD N•1** to obtain electrical interlocking between the 2 contactors, see page 5/123 For accessories, see pages 5/124 to 5/127

(2) Coils to be ordered separately:

- a.c. supply, see page 5/130,
- d.c. supply, see page 5/136.

(3) Screw fixing.

Power terminals can be protected against direct finger contact by the addition of shrouds, to be ordered separately, see above.

TeSys contactors

TeSys F reversing contactors and changeover contactor pairs

Components for assembling 3-pole reversing contactors and changeover contactor pairs, for customer assembly

Horizontally mounted

Reversers assembled using 2 contactors of identical rating, type :

- LC1 F115
- LC1 F150
- LC1 F185
- LC1 F225
- LC1 F265
- LC1 F330
- LC1 F400
- LC1 F500
- LC1 F630
- LC1 F800

Mechanical interlocks

LA9 F●●970 (2)

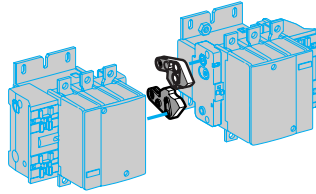

Sets of power connections

Reversing contactors

LA9 F●●●76 (2)

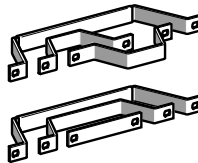
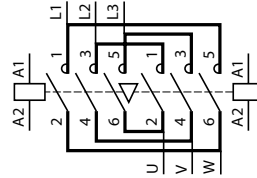

3-pole changeover contactor pairs (1)

LA9 F●●●82 (2)

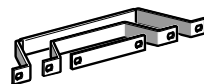
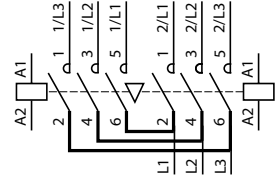

Vertically mounted

Reversers assembled using 2 contactors of identical rating, type :

- LC1 F115
- LC1 F150
- LC1 F185
- LC1 F225
- LC1 F265
- LC1 F330
- LC1 F400
- LC1 F500
- LC1 F630
- LC1 F800

Reversers assembled using 2 contactors of different ratings, see page 5/120

Mechanical interlocks

LA9 FF4F
LA9 FG4G

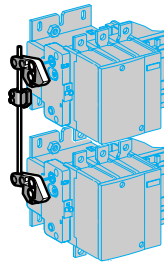

LA9 FH4H
LA9 FJ4J
LA9 FK4K
LA9 FL4L

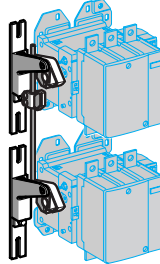

LC1 F780

LA9 FX970

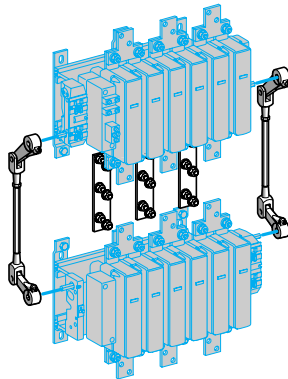

(1) For 4-pole changeover contactor pairs, see pages 5/120 and 5/121

(2) Complete references: see page 5/119.

TeSys contactors

TeSys F reversing contactors and changeover pairs
Components for assembling 3-pole reversing contactors and changeover contactor pairs, for customer assembly
Control circuit: a.c. or d.c.

Reversers assembled using 2 contactors of identical rating				
Contactor type (1)	Set of power connections		Mechanical interlock	
	Reference	Weight kg	Kit reference	Weight kg
For assembly of 3-pole reversing contactors for motor control				
Horizontally mounted				
LC1 F115	LA9 FF976	0.600	LA9 FF970	0.060
LC1 F150	LA9 F15076	0.600	LA9 FF970	0.060
LC1 F185	LA9 FG976	0.780	LA9 FG970	0.060
LC1 F225	LA9 F22576	1.500	LA9 FG970	0.060
LC1 F265	LA9 FH976	1.500	LA9 FJ970	0.140
LC1 F330	LA9 FJ976	2.100	LA9 FJ970	0.140
LC1 F400	LA9 FJ976	2.100	LA9 FJ970	0.140
LC1 F500	LA9 FK976	2.350	LA9 FJ970	0.140
LC1 F630 or F800	LA9 FL976	3.800	LA9 FL970	0.150
Vertically mounted				
LC1 F115 or F150	(2)	–	LA9 FF4F	0.345
LC1 F185	(2)	–	LA9 FG4G	0.350
LC1 F225	(2)	–	LA9 FG4G	0.350
LC1 F265 or F330	(2)	–	LA9 FH4H	1.060
LC1 F400	(2)	–	LA9 FJ4J	1.200
LC1 F500	(2)	–	LA9 FK4K	1.200
LC1 F630 or F800	(2)	–	LA9 FL4L	1.220
LC1 F780	(3)	–	LA9 FX970 (3)	6.100
For assembly of 3-pole changeover contactor pairs (4)				
Horizontally mounted				
LC1 F115	LA9 FF982	0.460	LA9 FF970	0.060
LC1 F150	LA9 F15082	0.460	LA9 FF970	0.060
LC1 F185	LA9 FG982	0.610	LA9 FG970	0.060
LC1 F225	LA9 F22582	1.200	LA9 FG970	0.060
LC1 F265	LA9 FH982	1.200	LA9 FJ970	0.140
LC1 F330	LA9 FJ982	1.800	LA9 FJ970	0.140
LC1 F400	LA9 FJ982	1.800	LA9 FJ970	0.140
LC1 F500	LA9 FK982	2.300	LA9 FJ970	0.140
LC1 F630 or F800	LA9 FL982	3.400	LA9 FL970	0.150
Vertically mounted				
LC1 F115 or F150	(2)	–	LA9 FF4F	0.345
LC1 F185	(2)	–	LA9 FG4G	0.350
LC1 F225	(2)	–	LA9 FG4G	0.350
LC1 F265 or F330	(2)	–	LA9 FH4H	1.060
LC1 F400	(2)	–	LA9 FJ4J	1.200
LC1 F500	(2)	–	LA9 FK4K	1.200
LC1 F630 or F800	(2)	–	LA9 FL4L	1.220
LC1 F780	(3)	–	LA9 FX970 (3)	7.800

(1) To order the 2 contactors: see pages 5/114 and 5/115. For the 2 auxiliary contact blocks **LAD No1** required to obtain electrical interlocking between the 2 contactors, see page 5/123
For accessories, see pages 5/124 to 5/127

(2) With the exception of contactors **LC1 F780**, all power connections are to be made by the customer.

(3) Double mechanical interlock mechanism with 2 interlock connecting rods and 3 power connecting links.

(4) For assembly of 4-pole changeover contactor pairs, see pages 5/120 and 5/121

TeSys contactors

TeSys F changeover contactor pairs

Components for assembling 3 and 4-pole changeover contactor pairs, for customer assembly

Horizontally mounted

Contactors pairs assembled using 2 contactors of identical rating, type :

- LC1 F1154
- LC1 F1504
- LC1 F1854
- LC1 F2254
- LC1 F2654
- LC1 F3304
- LC1 F4004
- LC1 F5004
- LC1 F6304

Mechanical interlocks

LA9 F●970

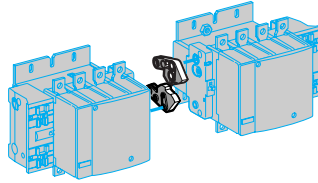

Sets of power connections

4-pole changeover contactor pairs (1)

LA9 F●●77

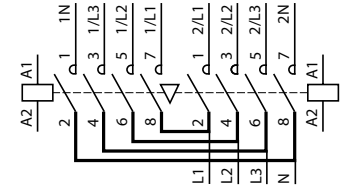
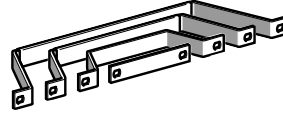

Vertically mounted

Contactors pairs assembled using 2 contactors of identical rating, type :

- LC1 F1154
- LC1 F1504
- LC1 F1854
- LC1 F2254
- LC1 F2654
- LC1 F3304
- LC1 F4004
- LC1 F5004
- LC1 F6304

Mechanical interlocks

Assembly A

LA9 FF4F
LA9 FG4G

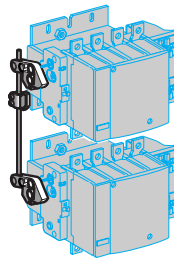

Assembly B

LA9 FH4H
LA9 FJ4J
LA9 FK4K
LA9 FL4L

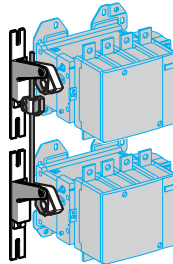

Assembly C

LA9 FX971

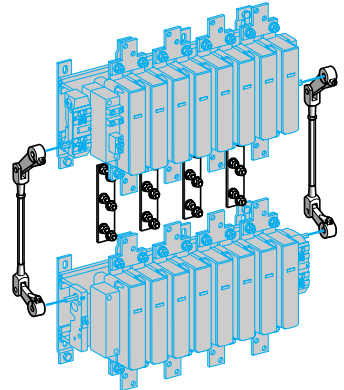

5

Contactors pairs assembled using 2 contactors of different ratings, type :

- LC1 F115 or F1154
- LC1 F150 or F1504
- LC1 F185 or F1854
- LC1 F225 or F2254
- LC1 F265 or F2654
- LC1 F330 or F3304
- LC1 F400 or F4004
- LC1 F500 or F5004
- LC1 F630 or F6304
- LC1 F800

Assembly A

LA9 FG4F

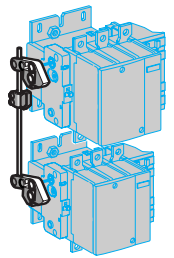

Assembly B

LA9 FH4F, LA9 FH4G
LA9 FJ4F, LA9 FJ4G
LA9 FK4F, LA9 FK4G
LA9 FL4F, LA9 FL4G

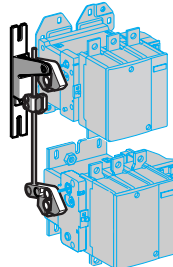

Assembly C

LA9 FJ4H
LA9 FK4H, LA9 FK4J
LA9 FL4H, LA9 FL4J and LA9 FL4K

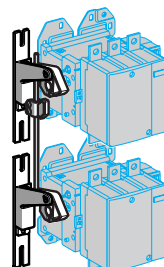

Contactors pairs assembled using 3 contactors of identical or different ratings, type :

- LC1 F115 or F1154
- LC1 F150 or F1504
- LC1 F185 or F1854
- LC1 F225 or F2254
- LC1 F265 or F2654
- LC1 F330 or F3304
- LC1 F400 or F4004
- LC1 F500 or F5004
- LC1 F630 or F6304
- LC1 F800

LA9 F●4●4● : see pages 5/128 and 5/129

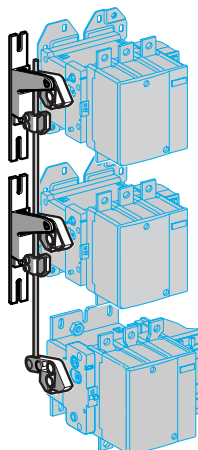

Important: the contactor ratings must be in decreasing size from top to bottom.

(1) For 3-pole changeover contactor pairs, see pages 5/118 and 5/119.

TeSys contactors

TeSys F changeover contactor pairs

Components for assembling 3 and 4-pole changeover contactor pairs, for customer assembly

Control circuit: a.c. or d.c.

Contactor pairs assembled using 2 contactors of identical rating

For assembly of 4-pole changeover contactor pairs ⁽¹⁾

Contactor type ⁽²⁾	Set of power connections		Mechanical interlock	
	Reference	Weight kg	Kit reference	Weight kg
Horizontally mounted				
LC1 F1154	LA9 FF977	0.460	LA9 FF970	0.060
LC1 F1504	LA9 F15077	0.460	LA9 FF970	0.060
LC1 F1854	LA9 FG977	0.610	LA9 FG970	0.060
LC1 F2254	LA9 F22577	1.200	LA9 FG970	0.060
LC1 F2654	LA9 FH977	1.200	LA9 FJ970	0.140
LC1 F3304	LA9 FJ977	1.800	LA9 FJ970	0.140
LC1 F4004	LA9 FJ977	1.800	LA9 FJ970	0.140
LC1 F5004	LA9 FK977	2.300	LA9 FJ970	0.140
LC1 F6304	LA9 FL977	3.400	LA9 FL970	0.150
Vertically mounted				
LC1 F1154 or F1504	⁽³⁾	–	LA9 FF4F	0.345
LC1 F1854	⁽³⁾	–	LA9 FG4G	0.350
LC1 F2254	⁽³⁾	–	LA9 FG4G	0.350
LC1 F2654 or F3304	⁽³⁾	–	LA9 FH4H	1.060
LC1 F4004	⁽³⁾	–	LA9 FJ4J	1.200
LC1 F5004	⁽³⁾	–	LA9 FK4K	1.200
LC1 F6304	⁽³⁾	–	LA9 FL4L	1.220
LC1 F7804	⁽⁴⁾	–	LA9 FX971 ⁽⁴⁾	7.800

Contactor pairs assembled using 2 contactors of different ratings

For assembly of 3 or 4-pole changeover contactor pairs

Contactor type ⁽¹⁾	Set of power connections		Mechanical interlock	
	At bottom	At top	Kit reference	Weight kg
Vertically mounted				
LC1 F115 or F1154 or LC1 F150 or F1504	LC1 F185 or F1854	LA9 FG4F	0.350	
	LC1 F225 or F2254	LA9 FG4F	0.350	
	LC1 F265 or F2654	LA9 FH4F	0.870	
	LC1 F330 or F3304	LA9 FH4F	0.870	
	LC1 F400 or F4004	LA9 FJ4F	0.930	
	LC1 F500 or F5004	LA9 FK4F	0.940	
LC1 F185 or F1854 or LC1 F225 or F2254	LC1 F630, F6304 or F800	LA9 FL4F	0.940	
	LC1 F265 or F2654	LA9 FH4G	0.860	
	LC1 F330 or F3304	LA9 FH4G	0.860	
	LC1 F400 or F4004	LA9 FJ4G	0.940	
	LC1 F500 or F5004	LA9 FK4G	0.940	
	LC1 F630, F6304 or F800	LA9 FL4G	0.950	
LC1 F265 or F2654 or LC1 F330 or F3304	LC1 F400 or F4004	LA9 FJ4H	1.130	
	LC1 F500 or F5004	LA9 FK4H	1.130	
	LC1 F630, F6304 or F800	LA9 FL4H	1.140	
LC1 F400 or F4004	LC1 F500 or F5004	LA9 FK4J	1.200	
	LC1 F630 or F6304 or F800	LA9 FL4J	1.210	
LC1 F500 or F5004	LC1 F630 or F6304 or F800	LA9 FL4K	1.210	

For assembly of reversers using 3 contactors, vertically mounted

See pages 5/128 and 5/129.

⁽¹⁾ For assembly of 3-pole changeover contactor pairs, see pages 5/118 and 5/120

⁽²⁾ To order the 2 contactors: see pages 5/114 and 5/115. For the 2 auxiliary contact blocks **LAD No1** required to obtain electrical interlocking between the 2 contactors, see page 5/123. For accessories, see pages 5/124 to 5/127

⁽³⁾ All power connections are to be made by the customer.

⁽⁴⁾ Double mechanical interlock mechanism with 2 interlock connecting rods and 4 power connecting links.

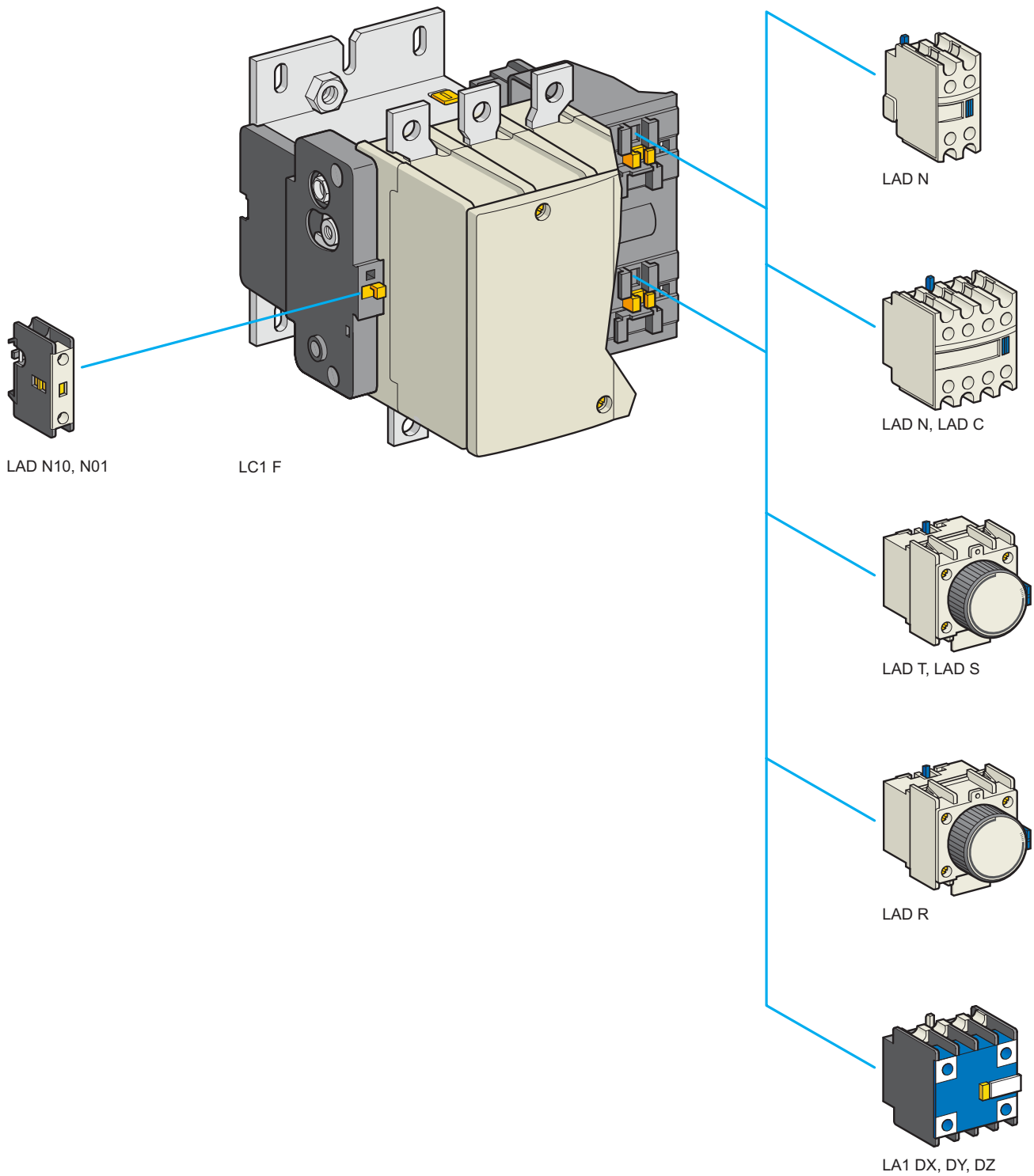





TeSys contactors

TeSys F contactors

Auxiliary contact blocks

Instantaneous auxiliary contact blocks

For use in normal operating environments

Number of contacts	Maximum number of blocks per contactor Clip-on mounting	Composition				Reference	Weight kg
							
1	1	-	-	1	-	LAD N10	0.020
		-	-	-	1	LAD N01	0.020
2	2	-	-	1	1	LAD N11	0.030
		-	-	2	-	LAD N20	0.030
		-	-	-	2	LAD N02	0.030
4	2	-	-	2	2	LAD N22	0.050
		-	-	1	3	LAD N13	0.050
		-	-	4	-	LAD N40	0.050
		-	-	-	4	LAD N04	0.050
		-	-	3	1	LAD N31	0.050
		-	-	2	2 (1)	LAD C22	0.050

With terminal referencing conforming to EN 50012





2	2	-	-	1	1	LAD N11P	0.030
		-	-	1	1	LAD N11G	0.030
4	2	-	-	2	2	LAD N22P	0.050
		-	-	2	2	LAD N22G	0.050

Instantaneous auxiliary contact blocks for connection by lugs

This type of connection is not possible for blocks with 1 contact or blocks with dust and damp protected contacts. For all other instantaneous auxiliary contact blocks, add the figure 6 to the end of the references selected above. Example: LAD N11 becomes LAD N116.

Instantaneous auxiliary contact blocks with dust and damp protected contacts

Recommended for use in particularly harsh industrial environments

Number of contacts	Maximum number of blocks per contactor Clip-on mounting	Composition				Reference	Weight kg
							
2	2	2	-	-	-	LA1 DX20	0.040
		2	2 (2)	-	-	LA1 DY20	0.040
4	2	2	-	2	-	LA1 DZ40	0.050
		2	-	1	1	LA1 DZ31	0.050

Time delay auxiliary contact blocks

Number of contacts	Maximum number of blocks per contactor Clip-on mounting	Time delay		Reference	Weight kg
		Type	Range s		
1 N/O + 1 N/C	2	On-delay	0.1...3 (3)	LAD T0	0.060
			0.1...30	LAD T2	0.060
		Off-delay	10...180	LAD T4	0.060
			1...30 (4)	LAD S2	0.060
		Off-delay	0.1...3 (3)	LAD R0	0.060
			0.1...30	LAD R2	0.060
			10...180	LAD R4	0.060

Interface for PLC control

Type of I/O	Reference	Weight kg
Inputs: $\bar{\bar{}}$ 24 V - 100 mA Outputs: \sim 480 V - 25 A	LA4 FSRE ▲	-

(1) Including 1 N/O + 1 N/C make before break

(2) Device fitted with 4 earth screen continuity terminals.

(3) With extended scale from 0.1 to 0.6 s.

(4) With switching time of 40 ms \pm 15 ms between opening of the N/C contact and closing of the N/O contact.

▲ Available 2nd half 2009.

TeSys contactors

TeSys F contactors

Suppressor blocks

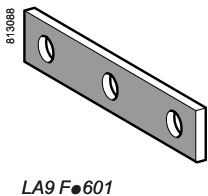
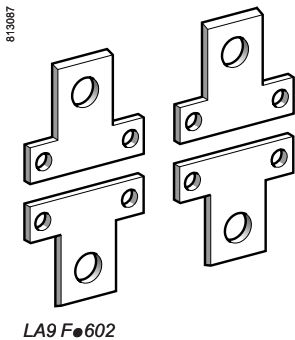
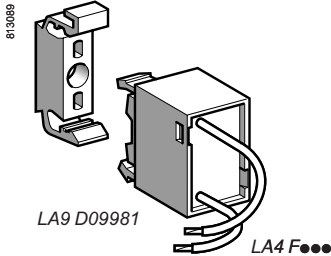

Suppressor blocks

RC circuits (resistor-capacitor)

- Effective protection for circuits highly sensitive to "high frequency" interference. For use only in cases where the voltage is virtually sinusoidal, i.e. less than 5% total harmonic distortion.
- Voltage limited to 3 Uc max. and oscillating frequency limited to 400 Hz max.
- Slight increase in drop-out time (1.1 to 1.3 times the normal time).

Mounting	Uc		Reference	Weight kg
Clip-on mounting on all ratings and all a.c. coils.	~	24...48 V	LA4 FRCE	0.040
		50...110 V	LA4 FRCF	0.040
		127...240 V	LA4 FRCP	0.040
		265...415 V	LA4 FRCV	0.040
Suppressor block bracket			LA9 D09981	0.010

Varistors (peak limiting)

- Protection provided by limiting the transient voltage to 2 Uc max.
- Maximum reduction of transient voltage peaks.

Clip-on mounting on all ratings and all coils.	~ or ---	24...48 V	LA4 FVE	0.040
		50...110 V	LA4 FVF	0.040
		127...240 V	LA4 FVP	0.040
		265...415 V	LA4 FVV	0.040

Diodes

- No overvoltage or oscillating frequencies.
- Increase in drop-out time (3 to 4 times the normal time).
- Polarised component.

Clip-on mounting on all ratings and all d.c. coils.	---	24...48 V	LA4 FDE	0.040
		55...110 V	LA4 FDF	0.040
		125...250 V	LA4 FDP	0.040
		280...440 V	LA4 FDV	0.040

Bidirectional peak limiting diodes (transil)

- Protection provided by limiting the transient voltage to between 2 and 2.5 times Uc max.
- Maximum reduction of transient voltage peaks.

Clip-on mounting on all ratings and all coils.	~ or ---	24...48 V	LA4 FTE	0.040
		50...110 V	LA4 FTF	0.040
		127...240 V	LA4 FTP	0.040
		265...415 V	LA4 FTV	0.040

Connection accessories

For use on 4-pole contactors	Set of 4 links	Weight kg
	Set reference	

Links for parallel connection of poles (in pairs)

LC1 F1154	LA9 FF602	0.200
LC1 F1504, F1854	LA9 FG602	0.350
LC1 F2254, F2654, F3304, F4004	LA9 FH602	1.000
LC1 F5004	LA9 FK602	1.750
LC1 F6304	LA9 FL602	3.000

Links for "star" connection of 3 poles

LC1 F115	LA9 FF601	0.035
LC1 F150, F185	LA9 FG601	0.050
LC1 F225, F265, F330, F400	LA9 FH601	0.120
LC1 F500	LA9 FK601	0.180
LC1 F630, F800	LA9 FL601	0.550

Control circuit voltage take-off from power terminals

For use with contactors	Mounted on bolt size	Sold in lots of	Unit reference	Weight kg
LC1 F115	M6	10	DZ3 FA3	0.004
LC1 F150, F185	M8	10	DZ3 GA3	0.004
LC1 F225...F500	M10	10	DZ3 HA3	0.006
LC1 F630, F800	M12	10	DZ3 JA3	0.009

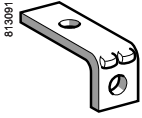

LA9 F●981

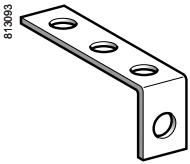

LA9 F●979

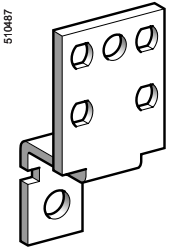

LA9 FL980

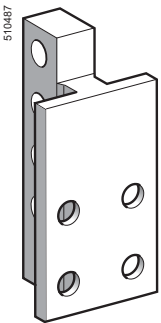

LA9 F2100

Right-angled connectors

For contactors or thermal overload relays

For use with		With connector plates		Set of 3 connectors	
Contactors	Thermal overload relays (1)	Width	Type	Set reference	Weight kg
LC1 F115	LR9 F5●67, LR9 F67	15 mm	Rear	LA9 FF981	0.060
			Side	LA9 FF979	0.240
			Large surface area	LA9 FF980	0.150
LC1 F150, F185	LR9 F5●69, F5●71, LR9 F69, F71	20 mm	Rear	LA9 FG981	0.080
			Side	LA9 FG979	0.350
			Large surface area	LA9 FG980	0.200
LC1 F225, F265, F330, F400	LR9 F7●75, LR9 F75	25 mm	Rear	LA9 FJ981	0.430
			Side	LA9 FJ979	0.750
			Large surface area	LA9 FJ980	0.490
LC1 F500	LR9 F7●79, F7●81, LR9 F79, F81	30 mm	Rear	LA9 FK981	0.480
			Side	LA9 FK979	0.920
			Large surface area	LA9 FK980	0.800
LC1 F630, F800	LR9 F7●81, LR9 F81	40 mm	Rear	LA9 FL981	1.210
			Side	LA9 FL979	2.570
			Large surface area	LA9 FL980	3.190

For use with		With connector plates		Set of 6 connectors	
Contactors	Thermal overload relays (1)	Width	Type	Set reference	Weight kg
LC1 F1700, F2100	–	60 mm	Rear	LA9 F2100	9.550

Connection accessories

For reversing contactors or "star-delta" contactors combined with a thermal overload relay

For use with		Width of connector plates		Set of 3 busbars	
Contactors	Thermal overload relays (1)	Width	Type	Set reference	Weight kg
LC1 F115	LR9 F5●57, F5●63 LR9 F5●67, F5●69 LR9 F69, F71	15 mm		LA7 F401	0.110
LC1 F150 and F185	LR9 F5●57, F5●63	20 mm		LA7 F402	0.110
LC1 F185	LR9 F5●71, LR9 F71	25 mm		LA7 F407	0.160
LC1 F225 and F265	LR9 F5●71, LR9 F71	25 mm		LA7 F403	0.160
	LR9 F7●75, F7●79 LR9 F75, F79	25 mm		LA7 F404	0.160
LC1 F330 and F400	LR9 F7●75, F7●79 LR9 F75, F79	25 mm		LA7 F404	0.160
LC1 F400	LR9 F7●81, LR9 F81	25 mm		LA7 F404	0.160
LC1 F500	LR9 F7●75, F7●79 LR9 F7●81 LR9 F75, F79, F81	30 mm		LA7 F405	0.270
LC1 F630, F800	LR9 F7●81, LR9 F81	40 mm		LA7 F406	0.600

(1) For protection relays class 10, replace the ● with a 3 and for class 20, replace the ● with a 5.

813064

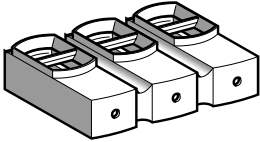

LA9 F103

813065

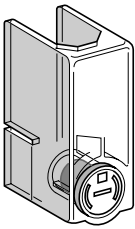

LA9 F701

Insulated terminal blocks

For use on 3-pole contactors	Connection	Tightening tool	Set of 2 blocks Set reference	Weight kg
LC1 F115, F150, F185	1 x 16...150 mm ² or 2 x 16...95 mm ²	4 mm hexagonal socket key	LA9 F103	0.560

Power terminal protection shrouds

For use on 2, 3 and 4-pole contactors	Number of shrouds per set	Set reference	Weight kg
LC1 F115	6	LA9 F701	0.250
LC1 F150, F185	6	LA9 F702	0.250
LC1 F225, F265, F330, F400 and F4002 F500 and F5002	6	LA9 F703	0.250
LC1 F630, F6302 and F800	6	LA9 F704	0.250
LC1 F1154	8	LA9 F706	0.300
LC1 F1504 and F1854	8	LA9 F707	0.300
LC1 F2254, F2654, F3304, F4004, F5004	8	LA9 F708	0.300
LC1 F6304	8	LA9 F709	0.300

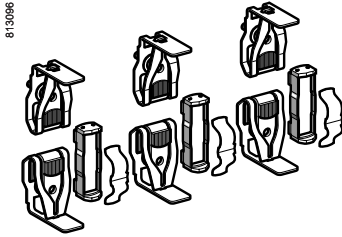

LA5 FG431

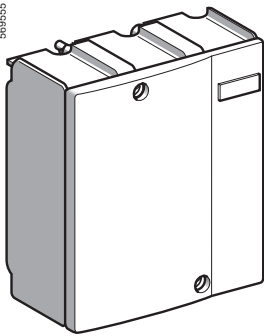

LA5 F40050

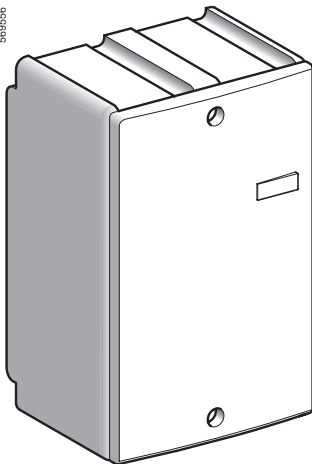

LA5 F210050

Sets of contacts

Per pole: 2 fixed contacts, 1 moving contact, 2 deflectors, 1 back-plate, clamping screws and washers.

For contactor	Type	Replacement for	Reference	Weight kg
2-pole	LC1 F4002	2 poles	LA5 F400802	1.350
	LC1 F5002	2 poles	LA5 F500802	1.950
	LC1 F6302	2 poles	LA5 F630802	4.700
	LC1 F6302S011	2 poles	LA5 F630802S011	4.800
3-pole	LC1 F115, F150	3 poles	LA5 FF431	0.270
	LC1 F185, F225	3 poles	LA5 FG431	0.350
	LC1 F265	3 poles	LA5 FH431	0.660
	LC1 F330, F400	3 poles	LA5 F400803	2.000
	LC1 F500	3 poles	LA5 F500803	2.950
	LC1 F630	3 poles	LA5 F630803	6.100
	LC1 F780	1 pole	LA5 F780801 (1)	4.700
		3 poles	LA5 F780803	13.200
	LC1 F800	3 poles	LA5 F800803	6.100
	LC1 F630S011	3 poles	LA5 F630803S011	6.200
4-pole	LC1 F1504, F1154	4 poles	LA5 FF441	0.360
	LC1 F1854, F2254	4 poles	LA5 FG441	0.465
	LC1 F2654	4 poles	LA5 FH441	0.880
	LC1 F3304, F4004	4 poles	LA5 F400804	2.700
	LC1 F5004	4 poles	LA5 F500804	3.900
	LC1 F6304	4 poles	LA5 F630804	8.150
	LC1 F7804	1 pole	LA5 F780801 (1)	4.700
		4 poles	LA5 F780804	17.300
	LC1 F6304S011	4 poles	LA5 F630804S011	8.400

Arc chambers

For contactor	Type	Replacement for	Reference	Weight kg
2-pole	LC1 F4002	2 poles	LA5 F400250	0.870
	LC1 F5002	2 poles	LA5 F500250	1.250
	LC1 F6302	2 poles	LA5 F630250	2.100
	LC1 F6302S011	2 poles	LA5 F630250	2.100
3-pole	LC1 F115	3 poles	LA5 F11550	0.490
	LC1 F150	3 poles	LA5 F15050	0.490
	LC1 F185	3 poles	LA5 F18550	0.670
	LC1 F225	3 poles	LA5 F22550	0.670
	LC1 F265	3 poles	LA5 F26550	0.920
	LC1 F330	3 poles	LA5 F33050	1.300
	LC1 F400	3 poles	LA5 F40050	1.300
	LC1 F500	3 poles	LA5 F50050	1.850
	LC1 F630	3 poles	LA5 F63050	3.150
	LC1 F780	1 pole	LA5 F780150 (1)	2.100
	LC1 F800	3 poles	LA5 F80050	3.150
	LC1 F630S011	3 poles	LA5 F63050	3.150
	LC1 F1700	6 poles	LA5 F170050 (2)	3.750
	LC1 F2100	6 poles	LA5 F210050 (2)	3.750
4-pole	LC1 F1154	4 poles	LA5 F115450	0.660
	LC1 F1504	4 poles	LA5 F150450	0.660
	LC1 F1854	4 poles	LA5 F185450	0.910
	LC1 F2254	4 poles	LA5 F225450	1.000
	LC1 F2654	4 poles	LA5 F265450	1.220
	LC1 F3304	4 poles	LA5 F330450	1.740
	LC1 F4004	4 poles	LA5 F400450 (3)	1.740
	LC1 F5004	4 poles	LA5 F500450 (3)	2.500
	LC1 F6304	4 poles	LA5 F630450 (4)	4.200
	LC1 F7804	1 pole	LA5 F780150 (1)	2.100
LC1 F6304S011	4 poles	LA5 F630450	4.200	

(1) Comprising 2 identical items per pole.

(2) Comprising three 2-pole arc chambers.

(3) Comprising two 2-pole arc chambers.

(4) Comprising single-pole arc chambers.

TeSys contactors

TeSys F contactors

Accessories for assembly of reversing contactors and changeover contactor pairs using 3 contactors, vertically mounted - for customer assembly

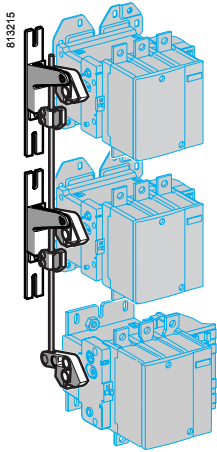

LA9 F•4•4•

Closing of one of the 3 contactors prevents closing of the other 2.

Mechanical interlock kits				
Contactor type (1)			Mechanical interlock (2)	
Top	Middle	Bottom	Kit reference (3)	Weight kg
LC1 F115, F150, F1154 or F1504	LC1 F115, F150, F1154 or F1504	LC1 F115, F150, F1154 or F1504	LA9 FF4F4F	0.554
LC1 F185, F225, F1854 or F2254	LC1 F115, F150, F1154 or F1504	LC1 F115, F150, F1154 or F1504	LA9 FG4F4F	0.559
		LC1 F185, F225, F1854 or F2254	LA9 FG4G4F	0.559
LC1 F185, F225, F1854 or F2254	LC1 F115, F150, F1154 or F1504	LC1 F115, F150, F1154 or F1504	LA9 FG4G4G	0.562
		LC1 F185, F225, F1854 or F2254	LA9 FG4G4G	0.562
LC1 F265, F330, F2654 or F3304	LC1 F115, F150, F1154 or F1504	LC1 F115, F150, F1154 or F1504	LA9 FH4F4F	1.350
		LC1 F185, F225, F1854 or F2254	LA9 FH4G4F	1.375
LC1 F185, F225, F1854 or F2254	LC1 F115, F150, F1154 or F1504	LC1 F115, F150, F1154 or F1504	LA9 FH4G4G	1.375
		LC1 F185, F225, F1854 or F2254	LA9 FH4G4G	1.375
LC1 F265, F330, F2654 or F3304	LC1 F115, F150, F1154 or F1504	LC1 F115, F150, F1154 or F1504	LA9 FH4H4F	1.524
		LC1 F185, F225, F1854 or F2254	LA9 FH4H4G	1.527
LC1 F265, F330, F2654 or F3304	LC1 F115, F150, F1154 or F1504	LC1 F115, F150, F1154 or F1504	LA9 FH4H4H	1.684
		LC1 F265, F330, F2654 or F3304	LA9 FH4H4H	1.684
LC1 F400, F4002 or F4004	LC1 F115, F150, F1154 or F1504	LC1 F115, F150, F1154 or F1504	LA9 FJ4F4F	1.421
		LC1 F185, F225, F1854 or F2254	LA9 FJ4G4F	1.424
LC1 F185, F225, F1854 or F2254	LC1 F115, F150, F1154 or F1504	LC1 F115, F150, F1154 or F1504	LA9 FJ4G4G	1.428
		LC1 F185, F225, F1854 or F2254	LA9 FJ4G4G	1.428
LC1 F265, F330, F2654 or F3304	LC1 F115, F150, F1154 or F1504	LC1 F115, F150, F1154 or F1504	LA9 FJ4H4F	1.595
		LC1 F185, F225, F1854 or F2254	LA9 FJ4H4G	1.598
LC1 F265, F330, F2654 or F3304	LC1 F115, F150, F1154 or F1504	LC1 F115, F150, F1154 or F1504	LA9 FJ4H4H	1.755
		LC1 F265, F330, F2654 or F3304	LA9 FJ4H4H	1.755
LC1 F400, F4002 or F4004	LC1 F115, F150, F1154 or F1504	LC1 F115, F150, F1154 or F1504	LA9 FJ4J4F	1.666
		LC1 F185, F225, F1854 or F2254	LA9 FJ4J4G	1.669
LC1 F185, F225, F1854 or F2254	LC1 F115, F150, F1154 or F1504	LC1 F115, F150, F1154 or F1504	LA9 FJ4J4H	1.829
		LC1 F265, F330, F2654 or F3304	LA9 FJ4J4J	1.890
LC1 F400, F4002 or F4004	LC1 F115, F150, F1154 or F1504	LC1 F115, F150, F1154 or F1504	LA9 FJ4J4J	1.890
		LC1-F400, F4002 or F4004	LA9 FJ4J4J	1.890
LC1 F500, F5002 or F5004 (continued on page 5/129)	LC1 F115, F150, F1154 or F1504	LC1 F115, F150, F1154 or F1504	LA9 FK4F4F	1.421
		LC1 F185, F225, F1854 or F2254	LA9 FK4G4F	1.424
LC1 F185, F225, F1854 or F2254	LC1 F115, F150, F1154 or F1504	LC1 F115, F150, F1154 or F1504	LA9 FK4G4G	1.428
		LC1 F185, F225, F1854 or F2254	LA9 FK4G4G	1.428
LC1 F265, F330, F2654 or F3304	LC1 F115, F150, F1154 or F1504	LC1 F115, F150, F1154 or F1504	LA9 FK4H4F	1.595
		LC1 F185, F225, F1854 or F2254	LA9 FK4H4G	1.598
LC1 F265, F330, F2654 or F3304	LC1 F115, F150, F1154 or F1504	LC1 F115, F150, F1154 or F1504	LA9 FK4H4H	1.755
		LC1 F265, F330, F2654 or F3304	LA9 FK4H4H	1.755
LC1 F400, F4002 or F4004	LC1 F115, F150, F1154 or F1504	LC1 F115, F150, F1154 or F1504	LA9 FK4J4F	1.666
		LC1 F185, F225, F2654 or F3304	LA9 FK4J4G	1.669
LC1 F185, F225, F2654 or F3304	LC1 F115, F150, F1154 or F1504	LC1 F115, F150, F1154 or F1504	LA9 FK4J4H	1.829
		LC1 F265, F330, F2654 or F3304	LA9 FK4J4J	1.896
LC1 F400, F4002 or F4004	LC1 F115, F150, F1154 or F1504	LC1 F115, F150, F1154 or F1504	LA9 FK4J4J	1.896
		LC1 F400, F4002 or F4004	LA9 FK4J4J	1.896
LC1 F500, F5002 or F5004	LC1 F115, F150, F1154 or F1504	LC1 F115, F150, F1154 or F1504	LA9 FK4K4F	1.666

(1) To order the 3 contactors, see pages 5/114 and 5/115. For auxiliary contact blocks LAD N02 used for electrical locking, see page 5/123. For accessories, see pages 5/124 to 5/127

(2) Minimum distances between contactors, see page 5/129.

(3) The kit contains the lever arms, the 2 x Ø 8 mm rods and all parts required for assembly.

TeSys contactors

TeSys F contactors

Accessories for assembly of reversing contactors and changeover contactor pairs using 3 contactors, vertically mounted - for customer assembly

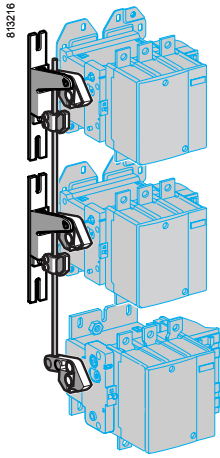

LA9 F444

Mechanical interlock kits (continued)

Contactor type (1)			Mechanical interlock (2)	
Top	Middle	Bottom	Kit reference (3)	Weight kg
LC1 F500, F5002 or F5004 (continued)	LC1 F500, F5002 or F5004	LC1 F185, F225, F1854 or F2254	LA9 FK4K4G	1.669
		LC1 F265, F330, F2654 or F3304	LA9 FK4K4H	1.825
		LC1 F400, F4002 or F4004	LA9 FK4K4J	1.896
		LC1-F500, F5002 or F5004	LA9 FK4K4K	1.896
LC1 F630, F800, F6302 or F6304	LC1 F115, F150, F1154 or F1504	LC1 F115, F150, F1154 or F1504	LA9 FL4F4F	1.428
		LC1 F185, F225, F1854 or F2254	LA9 FL4G4F	1.431
		LC1 F185, F225, F1854 or F2254	LA9 FL4G4G	1.436
	LC1 F265, F330, F2654 or F3304	LC1 F115, F150, F1154 or F1504	LA9 FL4H4F	1.602
		LC1 F185, F225, F1854 or F2254	LA9 FL4H4G	1.606
		LC1 F265, F330, F2654 or F3304	LA9 FL4H4H	1.751
	LC1 F400, F4002 or F4004	LC1 F115, F150, F1154 or F1504	LA9 FL4J4F	1.673
		LC1 F185, F225, F1854 or F2254	LA9 FL4J4G	1.676
		LC1 F265, F330, F2654 or F3304	LA9 FL4J4H	1.832
		LC1 F400, F4002 or F4004	LA9 FL4J4J	1.903
	LC1-F500, F5002 or F5004	LC1 F115, F150, F1154 or F1504	LA9 FK4K4F	1.666
		LC1 F185, F225, F1854 or F2254	LA9 FK4K4G	1.669
LC1 F265, F330, F2654 or F3304		LA9 FK4K4H	1.825	
LC1 F400, F4002 or F4004		LA9 FK4K4J	1.896	
LC1-F500, F5002 or F5004		LA9 FK4K4K	1.896	
LC1 F630, F800, F6302 or F6304		LC1 F115, F150, F1154 or F1504	LA9 FL4L4F	1.680
	LC1 F185, F225, F1854 or F2254	LA9 FL4L4G	1.683	
	LC1 F265, F330, F2654 or F3304	LA9 FL4L4H	1.910	
	LC1 F400, F4002 or F4004	LA9 FL4L4J	1.896	
	LC1 F500, F5002 or F5004	LA9 FL4L4K	1.896	
	LC1 F630, F800, F6302, or F6304	LA9 FL4L4L	1.920	

(1) To order the 3 contactors, see pages 5/114 and 5/115. For auxiliary contact blocks LAD N02 used for electrical locking, see page 5/123. For accessories, see pages 5/124 to 5/127.

(2) Minimum distances between contactors.

This is the distance, in mm, between the centres of two adjacent contactors (between the top and middle contactors or between the middle and bottom contactors).

Contactor Bottom or top	Middle					
	LC1 F115 or F150	LC1 F185 or F225	LC1 F265 or F330	LC1 F400	LC1 F500	LC1 F630 or F800
LC1 F115 or F150	200	210	240	250	270	320
LC1 F185 or F225	210	220	250	250	270	330
LC1 F265 or F330	240	250	250	260	280	350
LC1 F400	250	250	260	260	280	320
LC1 F500	270	270	280	280	300	340
LC1 F630 or F800	320	330	350	320	340	380

(3) The kit contains the lever arms, the 2 x Ø 8 mm rods and all parts required for assembly.

TeSys contactors

TeSys F contactors

a.c. 50/60 Hz supply coils

813181

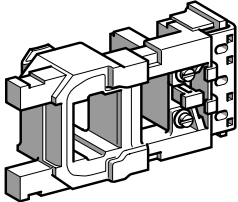

LX1 FF●●●

5

813182

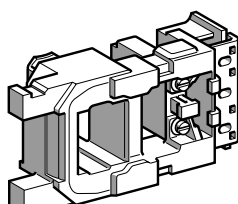

LX1 FG●●●

References

Maximum ambient air temperature: 55 °C. Above this, use an LX9 F coil, see page 5/135.
 Operating cycles/hour ($\theta \leq 55 \text{ °C}$): ≤ 2400 .

Control circuit voltage	Average resistance at 20 °C ± 10 %		Inductance of closed circuit	Voltage code	Reference	Weight
	Uc - 50 Hz	Uc - 60 Hz				
V	V	Ω	H			kg
For contactors LC1 F115 and LC1 F150						
24	–	0.27	0.04	B5	LX1 FF024	0.430
42	–	0.94	0.13	D5	LX1 FF042	0.430
–	48	0.78	0.11	E6	LX1 FF040	0.430
48	–	1.17	0.16	E5	LX1 FF048	0.430
–	110	4.55	0.59	F6	LX1 FF092	0.430
–	120	4.77	0.64	G6	LX1 FF095	0.430
110	–	6.38	0.86	F5	LX1 FF110	0.430
115	–	6.38	0.86	FE5	LX1 FF110	0.430
127/132	–	9.14	1.15	G5	LX1 FF127	0.430
–	200/208	14.5	1.87	L6	LX1 FF162	0.430
–	220	18.4	2.38	M6	LX1 FF184	0.430
–	240	18.9	2.5	U6	LX1 FF187	0.430
220	265/277	28.1	3.44	M5	LX1 FF220	0.430
230	–	28.1	3.44	P5	LX1 FF220	0.430
240	–	31.1	4.1	U5	LX1 FF240	0.430
–	380	57.2	7.05	Q6	LX1 FF316	0.430
–	440	72.6	9.21	R6	LX1 FF360	0.430
380	460/480	86.9	10.3	Q5	LX1 FF380	0.430
400	–	86.9	10.3	V5	LX1 FF380	0.430
415	–	95.1	12	N5	LX1 FF415	0.430
500	–	141	17	S5	LX1 FF500	0.430
–	660	172	20.3	Y6	LX1 FF550	0.430
660/690	–	254	28.9	Y5	LX1 FF660	0.430
–	1000	414	48.9	–	LX1 FF850	0.430
1000	–	610	68.5	–	LX1 FF1000	0.430

Specifications

Average consumption at 20 °C:
 - inrush 50Hz: 550VA; 60Hz: 660 VA,
 - sealed 50Hz: 45VA; 60 Hz: 55 VA, $\cos \varphi = 0.3$.
 Heat dissipation: 12...16 W.
 Operating time at Uc: closing = 23...35 ms, opening = 5...15 ms.

For contactors LC1 F185 and LC1 F225

24	–	0.18	0.03	B5	LX1 FG024	0.550
42	–	0.57	0.09	–	LX1 FG042	0.550
–	48	0.47	0.08	E6	LX1 FG040	0.550
48	–	0.71	0.12	E5	LX1 FG048	0.550
–	110	2.74	0.44	F6	LX1 FG092	0.550
–	115/120	2.87	0.49	G6	LX1 FG095	0.550
110	–	4.18	0.65	F5	LX1 FG110	0.550
115	–	4.18	0.65	FE5	LX1 FG110	0.550
127/132	–	5.35	0.86	G5	LX1 FG127	0.550
–	200/208	8.8	1.41	L6	LX1 FG162	0.550
–	220	11.1	1.8	M6	LX1 FG184	0.550
–	240	11.4	1.87	U6	LX1 FG187	0.550
220	265/277	16.5	2.59	M5	LX1 FG220	0.550
230	–	16.5	2.59	P5	LX1 FG220	0.550
240	–	20.1	3.09	U5	LX1 FG240	0.550
–	380	34	5.32	Q6	LX1 FG316	0.550
–	440	43.5	6.94	R6	LX1 FG360	0.550
380	460/480	51.3	7.75	Q5	LX1 FG380	0.550
400	–	51.3	7.75	V5	LX1 FG380	0.550
415	–	62.3	9.06	N5	LX1 FG415	0.550
500	–	82.7	12.8	S5	LX1 FG500	0.550
–	660	103	15.3	Y6	LX1 FG550	0.550
660/690	–	154	21.8	Y5	LX1 FG660	0.550
–	1000	249	36.6	–	LX1 FG850	0.550
1000	–	370	51.6	–	LX1 FG1000	0.550

Specifications

Average consumption at 20 °C:
 - inrush 50 Hz: 805 VA; 60 Hz: 970 VA,
 - sealed 50 Hz: 55 VA; 60 Hz: 66 VA, $\cos \varphi = 0.3$.
 Heat dissipation: 18...24 W.
 Operating time at Uc: closing = 20...35 ms, opening = 7...15 ms.

TeSys contactors

TeSys F contactors

a.c. 40 to 400 Hz supply coils

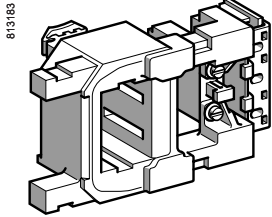

LX1 FH●●●2

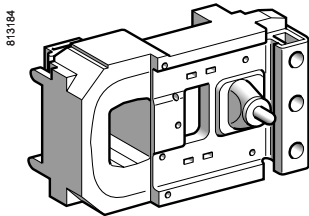

LX1 FJ●●●

References

Low sealed consumption.
Operate on networks with harmonic numbers ≤ 7 .
Operating cycles/hour ($\theta \leq 55^\circ\text{C}$): ≤ 2400 .

Control circuit voltage U_c	Average resistance at $20^\circ\text{C} \pm 10\%$		Inductance of closed circuit	Voltage code	Reference	Weight
	Inrush	Sealed				
V	Ω	Ω	H			kg
For contactors LC1 F265 and LC1 F330						
24	0.8	20	(1)	B7	LX1 FH0242	0.750
48	2.96	67	(1)	E7	LX1 FH0482	0.750
110	18.7	440	(1)	F7	LX1 FH1102	0.750
115	18.7	440	(1)	FE7	LX1 FH1102	0.750
120/127	22.9	536	(1)	G7	LX1 FH1272	0.750
200/208	58.4	1366	(1)	L7	LX1 FH2002	0.750
220	70.6	1578	(1)	M7	LX1 FH2202	0.750
230	70.6	1578	(1)	P7	LX1 FH2202	0.750
240	87.94	1968	(1)	U7	LX1 FH2402	0.750
277	113	2444	(1)	W7	LX1 FH2772	0.750
380	217	4631	(1)	Q7	LX1 FH3802	0.750
400	217	4631	(1)	V7	LX1 FH3802	0.750
415	217	4631	(1)	N7	LX1-FH3802	0.750
440	265	6731	(1)	R7	LX1 FH4402	0.750
480/500	329	8543	(1)	S7	LX1 FH5002	0.750
600/660	296	10 245	(1)	X7	LX1 FH6002	0.750
1000	696	25 880	(1)	-	LX1 FH10002	0.750

Specifications

Average consumption at 20°C for 50 or 60 Hz and $\cos \varphi = 0.9$:
- inrush: 600...700 VA,
- sealed: 8...10 VA.

Heat dissipation: 8 W.

Operating time at U_c : closing = 40...65 ms, opening = 100...170 ms.

For contactor LC1 F400

48	1.6	29.5	0.18	E7	LX1 FJ048	1.000
110/120	9.8	230	1.35	F7	LX1 FJ110	1.000
115	9.8	230	1.35	FE7	LX1 FJ110	1.000
120/127	12.8	280	1.75	G7	LX1 FJ127	1.000
200/208	30	815	4.1	L7	LX1 FJ200	1.000
220	37	1030	5.1	M7	LX1 FJ220	1.000
230	37	1030	5.1	P7	LX1 FJ220	1.000
240	47.5	1320	6.4	U7	LX1 FJ240	1.000
265/277	61	1700	8.1	W7	LX1 FJ280	1.000
380	120	3310	15.8	Q7	LX1 FJ380	1.000
400	120	3310	15.8	V7	LX1 FJ380	1.000
415	145	4070	19.4	N7	LX1 FJ415	1.000
440	145	4070	19.4	R7	LX1 FJ415	1.000
500	190	4980	25.5	S7	LX1 FJ500	1.000
550/600	243	6310	27.4	X7	LX1 FJ600	1.000
1000	720	19 420	84.6	-	LX1 FJ1000	1.000

Specifications

Average consumption at 20°C for 50 or 60 Hz and $\cos \varphi = 0.9$:

- inrush: 1000...1150 VA,

- sealed: 12...18 VA.

Heat dissipation: 14 W.

Operating time at U_c : closing = 40...75 ms, opening = 100...170.

(1) Please consult your Regional Sales Office.

TeSys contactors

TeSys F contactors

a.c. 40 to 400 Hz supply coils

813186

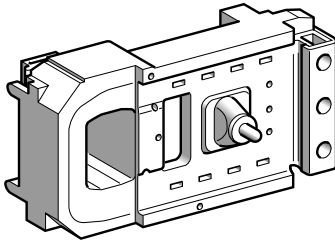

LX1 FK●●●

5

813187

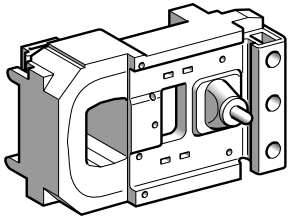

LX1 FL●●●

References (continued)

Low sealed consumption.
Operate on networks with harmonic numbers ≤ 7 .

Control circuit voltage U_c	Average resistance at 20 °C \pm 10 %		Inductance of closed circuit	Voltage code	Reference	Weight
	Inrush	Sealed				
V	Ω	Ω	H			kg
For contactor LC1 F500						
48	1.9	33.5	0.19	E7	LX1 FK048	1.150
110/120	9.55	260	1.25	F7	LX1 FK110	1.150
115	9.55	260	1.25	FE7	LX1 FK110	1.150
120/127	11.5	315	1.5	G7	LX1 FK127	1.150
200/208	29	735	3.75	L7	LX1 FK200	1.150
220	35.5	915	4.55	M7	LX1 FK220	1.150
230	35.5	915	4.55	P7	LX1 FK220	1.150
240	44.5	1160	5.75	U7	LX1 FK240	1.150
265/277	56.5	1490	7.3	W7	LX1 FK280	1.150
380	112	2980	14.7	Q7	LX1 FK380	1.150
400	112	2980	14.7	V7	LX1 FK380	1.150
415	143	3730	18.4	N7	LX1 FK415	1.150
440	143	3730	18.4	R7	LX1 FK415	1.150
500	172	4590	22.8	S7	LX1 FK500	1.150
550/600	232	5660	23.9	X7	LX1 FK600	1.150
1000	679	16 960	72	–	LX1 FK1000	1.150

Specifications

Average consumption at 20 °C for 50 or 60 Hz, $\cos \varphi = 0.9$:
 - inrush: 1050...1150 VA,
 - sealed: 16...20 VA.

Operating cycles/hour ($\theta \leq 55$ °C): ≤ 2400 .

Heat dissipation: 18 W.

Operating time at U_c : closing = 40...75 ms, opening = 100...170 ms.

For contactor LC1 F630

48	1.1	17.1	0.09	E7	LX1 FL048	1.500
110/120	6.45	165	1.85	F7	LX1 FL110	1.500
115	6.45	165	1.85	FE7	LX1 FL110	1.500
127	8.1	205	1.05	G7	LX1 FL127	1.500
200/208	20.5	605	2.65	L7	LX1 FL200	1.500
220	25.5	730	3.35	M7	LX1 FL220	1.500
230	25.5	730	3.35	P7	LX1 FL220	1.500
240	25.5	730	3.35	U7	LX1 FL220	1.500
265/277	31	900	4.1	W7	LX1 FL260	1.500
380	78	2360	10.5	Q7	LX1 FL380	1.500
400	78	2360	10.5	V7	LX1 FL380	1.500
415	96	2960	13	N7	LX1 FL415	1.500
440	96	2960	13	R7	LX1 FL415	1.500
500	120	3660	16.5	S7	LX1 FL500	1.500
550/600	155	4560	19.5	X7	LX1 FL600	1.500
1000	474	12 880	56.2	–	LX1 FL1000	1.500

Specifications

Average consumption at 20 °C for 50 or 60 Hz, $\cos \varphi = 0.9$:
 - inrush: 1500...1730 VA,
 - sealed: 20...25 VA.

Operating cycles/hour ($\theta \leq 55$ °C): 1200.

Heat dissipation: 20 W.

Operating time at U_c : closing = 40...80 ms, opening = 100...200 ms.

TeSys contactors

TeSys F contactors

a.c. 40 to 400 Hz supply coils

References (continued)

Low sealed consumption.

Operate on networks with harmonic numbers ≤ 7 .

Control circuit voltage Uc	Average resistance at 20 °C \pm 10 %		Inductance of closed circuit	Voltage code	Reference	Weight
	Inrush	Sealed				
V	Ω	Ω	H			kg
For contactor LC1 F780						
110/120	4.95 (2)	230 (2)	0.21	F7	LX1 FX110 (1)	3.000
115	4.95 (2)	230 (2)	0.21	FE7	LX1 FX110 (1)	3.000
127	6.1 (2)	280 (2)	0.26	G7	LX1 FX127 (1)	3.000
200/208	15.5 (2)	750 (2)	0.66	L7	LX1 FX200 (1)	3.000
220	19.5 (2)	920 (2)	0.82	M7	LX1 FX220 (1)	3.000
230	19.5 (2)	920 (2)	0.82	P7	LX1 FX220 (1)	3.000
240	19.5 (2)	920 (2)	0.82	U7	LX1 FX220 (1)	3.000
265/277	29.8 (2)	1330 (2)	1.25	W7	LX1 FX280 (1)	3.000
380	60.9 (2)	2780 (2)	2.3	Q7	LX1 FX380 (1)	3.000
400	60.9 (2)	2780 (2)	2.3	V7	LX1 FX380 (1)	3.000
415/480	74.3 (2)	3340 (2)	2.8	N7	LX1 FX415 (1)	3.000
440	74.3 (2)	3340 (2)	2.8	R7	LX1 FX415 (1)	3.000
500	92 (2)	4180 (2)	3.5	S7	LX1 FX500 (1)	3.000

Specifications

Average consumption at 20 °C for 50 or 60 Hz, $\cos \varphi = 0.9$:

- inrush: 1900...2300 VA, sealed: 44...55 VA.

Operating cycles/hour ($\theta \leq 55$ °C): 600.

Heat dissipation: 2 x 22 W.

Operating time at Uc: closing = 40...80 ms, opening = 130...230 ms.

For contactor LC1 F800

Control circuit voltage Uc	Voltage code	Rectifier Reference (3)	Coil Reference	Weight
V				kg
110/127	FE7	DR5 TE4U	LX4 F8FW	1.650
220/240	P7	DR5 TE4U	LX4 F8MW	1.650
380/440	V7	DR5 TE4S	LX4 F8QW	1.650

Specifications

Operating cycles/hour ($\theta \leq 55$ °C): 600.

Average consumption at 20 °C for 50 or 60 Hz, $\cos \varphi = 0.8$:

- inrush: 1700 VA, sealed: 12 VA

Operating time at Uc: closing = 60...80 ms, opening = 160...180 ms.

Control circuit voltage Uc	Average resistance at 20 °C \pm 10 %		Inductance of closed circuit	Voltage code	Reference	Weight
	Inrush	Sealed				
V	Ω	Ω	H			kg
For contactors LC1 F1700 and LC1 F2100						
110	5.92	106	0.72	F7	LX1 FK065 (4)	1.150
120	5.92	106	0.72	G7	LX1 FK070 (4)	1.150
220	9.55	260	1.25	M7	LX1 FK110 (4)	1.150
230	9.55	260	1.25	P7	LX1 FK110 (4)	1.150
240	11.5	315	1.50	U7	LX1 FK127 (4)	1.150
277	16.5	420	2.25	W7	LX1 FK140 (4)	1.150
380	29	735	3.75	Q7	LX1 FK200 (4)	1.150
400	29	735	3.75	V7	LX1 FK200 (4)	1.150
415	35.5	915	4.55	N7	LX1 FK220 (4)	1.150
440	35.5	915	4.55	R7	LX1 FK220 (4)	1.150
500	44.5	1160	5.75	S7	LX1 FK240 (4)	1.150

Specifications

Average consumption at 20 °C for 50 or 60 Hz, $\cos \varphi = 0.9$:

- inrush: 1600...2400 VA, sealed: 29...37 VA.

Operating cycles/hour ($\theta \leq 55$ °C): 600.

Heat dissipation: 2 x 18 W.

Operating time at Uc: closing = 40...75 ms, opening = 100...170 ms.

(1) Reference of set of 2 identical coils, to be connected in series.

(2) Value for the 2 coils in series.

(3) Rectifier to be ordered separately: 0.100 kg.

(4) Order 2 coils and connect them in series.

TeSys contactors

TeSys F contactors

a.c. 40 to 400 Hz supply coils
for specific applications (1)

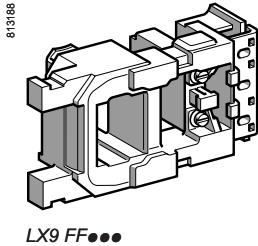

LX9 FF●●●

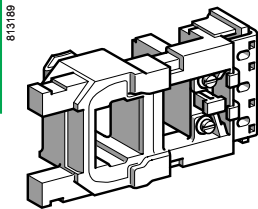

LX9 FG●●●

References

Low sealed consumption.
High tolerance to inrush voltage drops.
Immune to micro-breaks (mains supply or contact chain).
Operate on networks with harmonic numbers ≤ 7 .

Control circuit voltage U _c	Average resistance at 20 °C ± 10 %		Inductance of closed circuit	Voltage code	Reference	Weight
	Inrush	Sealed				
V	Ω	Ω	H			kg
For contactors LC1 F115 and LC1 F150						
48	3.03	80.2	0.3	E7	LX9 FF048	0.430
110	14.8	579	2.08	F7	LX9 FF110	0.430
115	14.8	579	2.08	FE7	LX9 FF110	0.430
120/127	19	746	2.65	G7	LX9 FF127	0.430
208	45	1788	5.95	L7	LX9 FF200	0.430
220	59.4	2190	7.7	M7	LX9 FF220	0.430
230	59.4	2190	7.7	P7	LX9 FF220	0.430
240	73.5	2750	9.68	U7	LX9 FF240	0.430
380	173	6540	23	Q7	LX9 FF380	0.430
400	173	6540	23	V7	LX9 FF380	0.430
415	218	8460	30	N7	LX9 FF415	0.430
440	218	8460	30	R7	LX9 FF415	0.430
500	262	10 300	36	S7	LX9 FF500	0.430

Specifications

Average consumption at 20 °C: inrush: 690...855 VA, sealed: 6.6...8.1 VA.
Heat dissipation: 5.9...7.2 W.
Operating cycles/hour ($\theta \leq 55$ °C): < 2400.
Operating time at U_c: closing = 35 ms, opening = 130 ms.

For contactors LC1 F185 and LC1 F225						
48	2.2	60	0.23	E7	LX9 FG048	0.550
110	10.4	411	1.46	F7	LX9 FG110	0.550
115	10.4	411	1.46	FE7	LX9 FG110	0.550
120/127	13	520	1.85	G7	LX9 FG127	0.550
208	33	1339	4.9	L7	LX9 FG200	0.550
220	42.1	1680	5.84	M7	LX9 FG220	0.550
230	42.1	1680	5.84	P7	LX9 FG220	0.550
240	50.6	2060	7.22	U7	LX9 FG240	0.550
380	128	4730	16.4	Q7	LX9 FG380	0.550
400	128	4730	16.4	V7	LX9 FG380	0.550
415	157	5930	20.6	N7	LX9 FG415	0.550
440	157	5930	20.6	R7	LX9 FG415	0.550
500	194	7550	26.3	S7	LX9 FG500	0.550

Specifications

Average consumption at 20 °C: inrush: 950...1180 VA, sealed: 8.9...10.9 VA.
Heat dissipation: 8...9.8 W.
Operating cycles/hour ($\theta \leq 55$ °C): < 2400.
Operating time at U_c: closing = 35 ms, opening = 130 ms.

For contactors LC1 F265 and LC1 F330						
48	2.96	72	(2)	–	LX9 FH0482	0.750
110/115	18.7	415	(2)	–	LX9 FH1102	0.750
120/127	22.9	156	(2)	–	LX9 FH1272	0.750
220/230	71.6	1621	(2)	–	LX9 FH2202	0.750
240	88	1968	(2)	–	LX9 FH2402	0.750
380/415	222	5075	(2)	–	LX9 FH3802	0.750
500	345	7990	(2)	–	LX9 FH5002	0.750

Specifications

Average consumption at 20 °C: inrush: 560...660 VA, sealed: 8...10 VA.
Heat dissipation: 8.4...10.4 W.
Operating cycles/hour ($\theta \leq 55$ °C): < 3600.
Operating time at U_c: closing = 45 ms, opening = 25 ms.

(1) Application examples: hoisting (inching, high operating rates), Main-Standby (unstable mains supplies). These coils are particularly suited for use at higher operating temperatures (mounting in non-ventilated compartments, enclosures, etc.).

(2) Please consult your Regional Sales Office.

TeSys contactors

TeSys F contactors
a.c. 40 to 400 Hz supply coils
for specific applications

References (continued)

Coils with short operating times (at U_c):
- N/O: 60 ms,
- N/C: 50 ms (~ side); 20 ms (--- side).

Coils with high operating rates ($\theta \leq 70$ °C):
- 3600 operating cycles/hour,
- 1800 for LC1 F630.

Coils with low inrush consumption.

Control circuit voltage U_c	Average resistance at 20 °C ± 10 %		Inductance of closed circuit	Rectifier Reference (1)	Coil Reference	Weight
	Inrush	Sealed				
V	Ω	Ω	H			kg
For contactor LC1 F400						
48	4.03	43	0.22	DR5 TF4V	LX9 FJ917	0.970
110	25.7	246	1.3	DR5 TE4U	LX9 FJ925	0.970
127	32.3	302	1.7	DR5 TE4U	LX9 FJ926	0.970
220/230	99.5	919	5	DR5 TE4U	LX9 FJ931	0.970
380/415	311	3011	15	DR5 TE4S	LX9 FJ936	0.970
440	386	3690	19	DR5 TE4S	LX9 FJ937	0.970
500	478	4380	23	DR5 TE4S	LX9 FJ938	0.970

Specifications

Average consumption:

- inrush: 500 VA,
- sealed: 23 VA

Heat dissipation: 11.4...13.9 W.

For contactor LC1 F500						
48	3.73	30.7	0.18	DR5 TF4V	LX9 FK917	1.080
110	24	204	1.1	DR5 TE4U	LX9 FK925	1.080
127	29.8	250	1.4	DR5 TE4U	LX9 FK926	1.080
220/230	89.9	770	4	DR5 TE4U	LX9 FK931	1.080
380/415	274	2075	12	DR5 TE4S	LX9 FK936	1.080
440	361	3060	16	DR5 TE4S	LX9 FK937	1.080
500	448	3750	19	DR5 TE4S	LX9 FK938	1.080

Specifications

Average consumption:

- inrush: 550 VA,
- sealed: 31 VA

Heat dissipation: 15...18.3 W.

For contactor LC1 F630						
48	2.81	20.8	0.17	DR5 TF4V	LX9 FL917	1.450
110	13.5	114	0.77	DR5 TE4U	LX9 FL924	1.450
127	20.8	167	1.2	DR5 TE4U	LX9 FL926	1.450
220	52	425	2.9	DR5 TE4U	LX9 FL930	1.450
220/240	64.5	518	3.6	DR5 TE4U	LX9 FL931	1.450
380/400	163	1360	8.8	DR5 TE4S	LX9 FL935	1.450
415/440	204	1670	11	DR5 TE4S	LX9 FL936	1.450
500	312	2510	17	DR5 TE4S	LX9 FL938	1.450

Specifications

Average consumption:

- inrush: 830 VA,
- sealed: 47 VA

Heat dissipation: 22.8...27.8 W.

(1) Rectifier to be ordered separately: 0.100 kg.

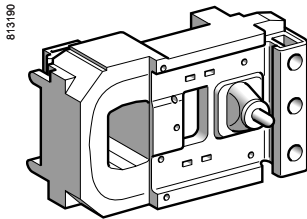

LX9 FJ●●●

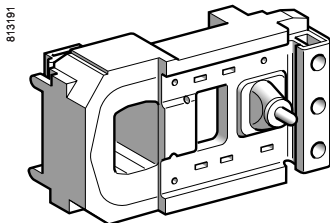

LX9 FK●●●

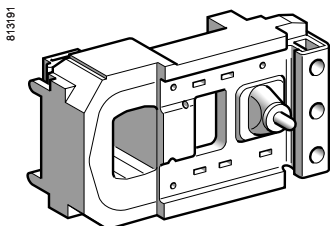

LX9 FL●●●

TeSys contactors

TeSys F contactors

d.c. supply coils

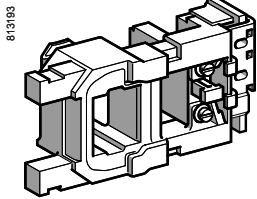

813193

LX4 FF●●●

References

Low sealed consumption.

Operating cycles/hour ($\theta \leq 55^\circ\text{C}$): ≤ 2400 .

Control circuit voltage Uc	Average resistance at 20 °C ± 10 %		Inductance of closed circuit	Voltage code	Reference	Weight
	Inrush	Sealed				
V	Ω	Ω	H			kg
For contactors LC1 F115 and LC1 F150						
24	1.12	177	11	BD	LX4 FF024	0.430
48	4.52	715	42.7	ED	LX4 FF048	0.430
110	21.7	2940	179	FD	LX4 FF110	0.430
125	26.8	3560	223	GD	LX4 FF125	0.430
220/230	84	11 100	704	MD	LX4 FF220	0.430
250	105	13 000	868	UD	LX4 FF250	0.430
440/460	301	48 200	4000	RD	LX4 FF440	0.430

Specifications

Average consumption:

- inrush: 543...665 W,
- sealed: 3.94...4.83 W.

Operating time at Uc: closing = 30...40 ms, opening = 30...50 ms.

For contactors LC1 F185 and LC1 F225

24	0.79	169	14.9	BD	LX4 FG024	0.550
48	3.2	662	55.3	ED	LX4 FG048	0.550
110	14.9	2810	241	FD	LX4 FG110	0.550
125	19	3320	289	GD	LX4 FG125	0.550
220/230	57.7	10 200	890	MD	LX4 FG220	0.550
250	76	12 400	1140	UD	LX4 FG250	0.550
440/460	223	39 700	4210	RD	LX4 FG440	0.550

Specifications

Average consumption:

- inrush: 737...902 W,
- sealed: 4.13...5.07 W.

Operating time at Uc: closing = 30...40 ms, opening = 30...50 ms.

For contactors LC1 F265 and LC1 F330

24	0.9	192	26.3	BD	LX4 FH024	0.740
48	3.49	707	92.9	ED	LX4 FH048	0.740
110	16.8	3180	424	FD	LX4 FH110	0.740
125	20.8	3840	530	GD	LX4 FH125	0.740
220/230	65.7	11 500	1590	MD	LX4 FH220	0.740
250	84	13 900	1910	UD	LX4 FH250	0.740
440/460	255	44 000	7570	RD	LX4 FH440	0.740

Specifications

Average consumption:

- inrush: 655...803 W,
- sealed: 3.68...4.53 W.

Operating time at Uc: closing = 40...50 ms, opening = 40...65 ms.

For contactor LC1 F400

48	2.5	558	56	ED	LX4 FJ048	0.970
110	12.7	2660	270	FD	LX4 FJ110	0.970
125	15.8	3130	330	GD	LX4 FJ125	0.970
220	47	8820	910	MD	LX4 FJ220	0.970
250	61	10 500	1200	UD	LX4 FJ250	0.970
440	236	33 750	4435	RD	LX4 FJ440	0.970

Specifications

Average consumption:

- inrush: 920...1140 W,
- sealed: 4...7.5 W.

Operating time at Uc: closing = 50...60 ms, opening = 45...60 ms.

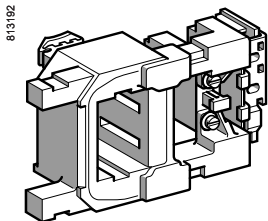

813192

LX4 FH●●●

TeSys contactors

TeSys F contactors

d.c. supply coils

813184

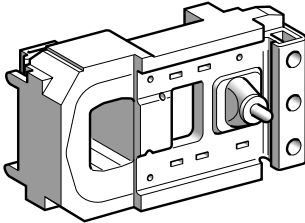

LX4 FK●●●

References (continued)

Low sealed consumption.

Control circuit voltage U _c	Average resistance at 20 °C ± 10 %		Inductance of closed circuit	Voltage code	Reference	Weight
	Inrush	Sealed				
V	Ω	Ω	H			kg
For contactor LC1 F500						
48	2.35	515	67	ED	LX4 FK048	1.080
110	11.5	2450	280	FD	LX4 FK110	1.080
125	15	2930	400	GD	LX4 FK125	1.080
220	44	8150	1080	MD	LX4 FK220	1.080
250	56	9650	1350	UD	LX4 FK250	1.080
440	225	31 300	5270	RD	LX4 FK440	1.080

Specifications

Average consumption:

- inrush: 990...1220 W,
- sealed: 4.54...8 W.

Operating cycles/hour ($\theta \leq 55$ °C): 2400.Operating time at U_c: closing = 50...60 ms, opening = 45...60 ms.

For contactor LC1 F630

48	1.7	353	40.5	ED	LX4 FL048	1.450
110	8.1	1680	180	FD	LX4 FL110	1.450
125	10	2110	230	GD	LX4 FL125	1.450
220	31	5160	650	MD	LX4 FL220	1.450
250	38	6080	815	UD	LX4 FL250	1.450
440	152	23 120	2910	RD	LX4 FL440	1.450

Specifications

Average consumption:

- inrush: 1420...1920 W,
- sealed: 6.5...12.5 W.

Operating cycles/hour ($\theta \leq 55$ °C): 1200.Operating time at U_c: closing = 60...70 ms, opening = 40...50 ms.

For contactor LC1 F780

110	6.1 (2)	280 (2)	0.26	FD	LX4 FX110 (1)	3.000
125	7.7 (2)	410 (2)	0.33	GD	LX4 FX125 (1)	3.000
220	24.6 (2)	1100 (2)	1	MD	LX4 FX220 (1)	3.000
250	29.8 (2)	1330 (2)	1.25	UD	LX4 FX250 (1)	3.000
440	92 (2)	4180 (2)	3.5	RD	LX4 FX440 (1)	3.000

Specifications

Average consumption:

- inrush: 1960...2420 W,
- sealed: 42...52 W.

Operating cycles/hour ($\theta \leq 55$ °C): 600.Operating time at U_c: closing = 70...80 ms, opening = 100...130 ms.

For contactor LC1 F800

110/120	-	-	-	FW	LX4 F8FW	1.650
220/240	-	-	-	MW	LX4 F8MW	1.650
380/400	-	-	-	QW	LX4 F8QW	1.650

Specifications

Heat dissipation: 25 W.

Operating time at U_c: closing = 60...80 ms, opening = 40...50 ms.

For contactors LC1 F1700 and LC1 F2100

110	2.94	734	98	FD	LX4 FK055 (3)	1.080
125	3.73	916	122	GD	LX4 FK065 (3)	1.080
220	11.5	2450	280	MD	LX4 FK110 (3)	1.080
250	15	2930	400	UD	LX4 FK125 (3)	1.080
440	44	8150	1080	RD	LX4 FK220 (3)	1.080

Specifications

Average consumption:

- inrush: 2000...2200 W,
- sealed: 8...10 W.

Operating cycles/hour ($\theta \leq 55$ °C): 600.Operating time at U_c: closing = 50...60 ms, opening = 45...60 ms.

(1) Reference of set of 2 identical coils, to be connected in series.

(2) Value for the 2 coils in series.

(3) Order 2 coils and connect them in series.

TeSys contactors

TeSys F contactors

d.c. supply coils

for specific applications

References

Coils with short operating times (at U_c) :

- N/O: 60 ms,
- N/C: 20 ms.

Coils with high operating rates ($q \leq 70$ °C):

- 3600 operating cycles/hour,
- 1800 for LC1 F630.

Coils with low inrush consumption.

Control circuit voltage U_c	Average resistance at 20 °C ± 10 %		Inductance of closed circuit	Resistor (1)		Coil Reference	Weight
	Inrush	Sealed		Qty required	Reference		
V	Ω	Ω	H				kg
For contactor LC1 F400							
48	5.11	99	0.27	1	DR2 SC0047	LX9 FJ918	0.970
110	32.3	632	1.7	1	DR2 SC0330	LX9 FJ926	0.970
125	39.4	760	2	1	DR2 SC0390	LX9 FJ927	0.970
220	123	2320	6.1	1	DR2 SC1200	LX9 FJ932	0.970
440/460	478	9080	23	1	DR2 SC4700	LX9 FJ938	0.970

Specifications

Average consumption:

- inrush: 430 W,
- sealed: 22 W.

For contactor LC1 F500

48	4.67	76.7	0.22	1	DR2 SC0039	LX9 FK918	1.080
110	29.8	470	1.4	1	DR2 SC0220	LX9 FK926	1.080
125	37.4	637	1.7	1	DR2 SC0330	LX9 FK927	1.080
220	115	1935	5.1	1	DR2 SC1000	LX9 FK932	1.080
440/460	448	7050	19	1	DR2 SC3300	LX9 FK938	1.080

Specifications

Average consumption:

- inrush: 470 W,
- sealed: 29 W.

For contactor LC1 F630

48	3.43	52.9	0.20	2	DR2 SC0047	LX9 FL918	1.450
110	17.2	272	0.98	2	DR2 SC0270	LX9 FL925	1.450
125	20.8	333	1.2	2	DR2 SC0330	LX9 FL926	1.450
220	64.5	1018	3.6	2	DR2 SC1000	LX9 FL931	1.450
440/460	260	4010	14	2	DR2 SC3900	LX9 FL937	1.450

Specifications

Average consumption:

- inrush: 733 W,
- sealed: 48 W.

(1) Resistor to be ordered separately, weight of resistor: 0.030 kg.

813194

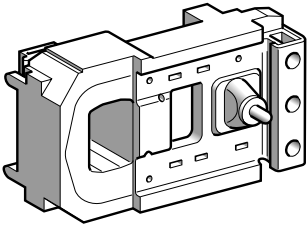

LX9 FJ●●●

813196

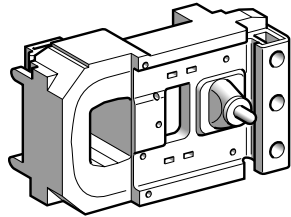

LX9 FK●●●

813195

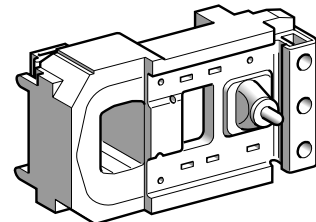

LX9 FL●●●

TeSys contactors

TeSys F contactors

Wide range d.c. supply coils for specific applications

819186

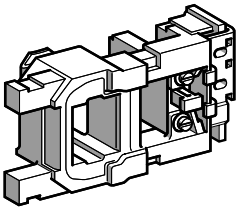

LX4 FF●●●

819187

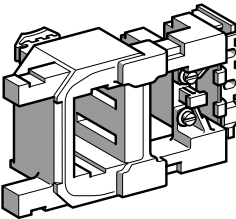

LX4 FH●●●

References (continued)

Wide range coils: 0.7...1.25 Uc.
 Operating cycles/hour: ≤ 60 (1).
 Ambient temperature (operation): - 55 to + 70 °C.

Control circuit voltage Uc	Average resistance at 20 °C ± 10 %		Inductance of closed circuit	Reference	Weight
	Inrush	Sealed			
V	Ω	Ω	H		kg
For contactors LC1 F115 and LC1 F150					
24	0.71	120	7.4	LX4 FF020	0.430
48	2.86	392	27	LX4 FF040	0.430
72	7.05	1055	66	LX4 FF060	0.430
110	13.2	1970	121	LX4 FF090	0.430
125	16.9	2340	149	LX4 FF100	0.430

Specifications

Average consumption:
 - inrush: 415...1300 W,
 - sealed: 3...9 W.

For contactors LC1 F185 and LC1 F225					
24	0.52	112	9.3	LX4 FG020	0.550
48	2	359	34.4	LX4 FG040	0.550
72	5.07	984	85	LX4 FG060	0.550
110	9.66	1840	157	LX4 FG090	0.550
125	12	2230	196	LX4 FG100	0.550

Specifications

Average consumption:
 - inrush: 580...1820 W,
 - sealed: 3.1...9.5 W.

For contactors LC1 F265 and LC1 F330					
24	0.58	129	17.3	LX4 FH020	0.740
48	2.19	400	59.5	LX4 FH040	0.740
72	5.58	1110	149	LX4 FH060	0.740
110	11	2120	287	LX4 FH090	0.740
125	13.8	2520	353	LX4 FH100	0.740

Specifications

Average consumption:
 - inrush: 515...1600 W,
 - sealed: 2.7...8.5 W.

Oper- ational voltage	Average resistance at 20 °C ± 10 %	Induc- tance of closed circuit	Coil		Economy resistor Resistors in //		Reference of the assembly (2)	Weight
			Reference	No. Ω	Reference			
V	Ω	H					kg	
For contactor LC1 F400								
24	1.05	0.049	LX2 FJW11	3	56	DR2 SC0056	LX5 FJW11	0.970
48	4.8	0.22	LX2 FJW18	3	220	DR2 SC0220	LX5 FJW18	0.970
72	9.6	0.44	LX2 FJW21	3	470	DR2 SC0470	LX5 FJW21	0.970

Specifications

Average consumption:
 - inrush: 290...860 W,
 - sealed: 16...47 W.

(1) The mechanical durability of the contactor is limited to 1 million operating cycles.
 (2) The set comprises: 1 coil LX2 FJ and 3 resistors DR2 SC.



LC1 F115 to F330

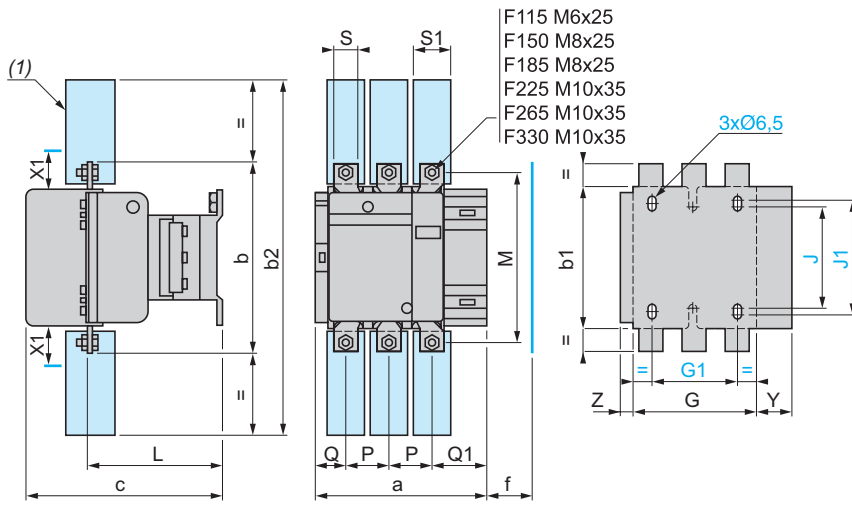

X1 (mm) = Minimum electrical clearance according to operating voltage and breaking capacity.

LC1	200...500 V	600...1000 V
F115, F150	10	15
F185	10	15
F225, F265	10	15
F330	10	15

(1) Power terminal protection shroud (see page 5/126).

LC1		a	b	b1	b2	c	f	G	G1	J	J1	L	M	P	Q	Q1	S	S1	Y	Z
F115	3P	163.5	162	137	265	171	131	106	80	106	120	107	147	37	29.5	60	20	26	44	13.5
	4P	200.5	162	137	265	171	131	143	80	106	120	107	147	37	29.5	60	20	26	44	13.5
F150	3P	163.5	170	137	301	171	131	106	80	106	120	107	150	40	26	57.5	20	34	44	13.5
	4P	200.5	170	137	301	171	131	143	80	106	120	107	150	40	26	55.5	20	34	44	13.5
F185	3P	168.5	174	137	305	181	130	111	80	106	120	113.5	154	40	29	59.5	20	34	44	13.5
	4P	208.5	174	137	305	181	130	151	80	106	120	113.5	154	40	29	59.5	20	34	44	13.5
F225	3P	168.5	197	137	364	181	130	111	80	106	120	113.5	172	48	21	51.5	25	44.5	44	13.5
	4P	208.5	197	137	364	181	130	151	80	106	120	113.5	172	48	17	47.5	25	44.5	44	13.5
F265	3P	201.5	203	145	375	213	147	142	96	106	120	141	178	48	39	66.5	25	44.5	38	21.5
	4P	244.5	203	145	375	213	147	190	96	106	120	141	178	48	34	66.5	25	44.5	38	21.5
F330	3P	213	206	145	375	219	147	154.5	96	106	120	145	181	48	43	74	25	44.5	38	20.5
	4P	261	206	145	375	219	147	202.5	96	106	120	145	181	48	43	74	25	44.5	38	20.5

f = minimum distance required for coil removal.

LC1 F400 and F500

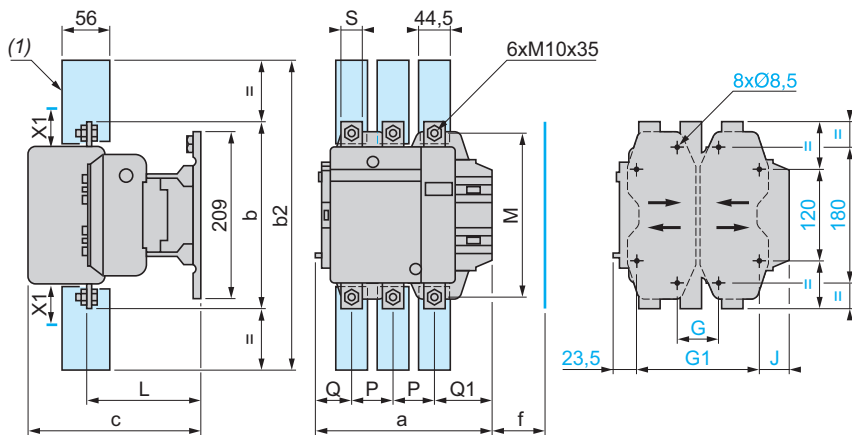

X1 (mm) = Minimum electrical clearance according to operating voltage and breaking capacity.

LC1	200...500 V	600...1000 V
F400	15	20
F500	15	20

(1) Power terminal protection shroud (see page 5/126).

LC1		a	b	b2	c	f	G	G	G	G1	G1	G1	J	L	M	P	Q	Q1	S
F400	2P	213	206	375	219	146	80	66	102	170	156	192	19.5	145	181	48	69	96	25
	3P	213	206	375	219	146	80	66	102	170	156	192	19.5	145	181	48	43	74	25
	4P	261	206	375	219	146	80	66	150	170	156	240	67.5	145	181	48	43	74	25
F500	2P	233	238	400	232	150	80	66	120	170	156	210	39.5	146	208	55	76	102	30
	3P	233	238	400	232	150	80	66	120	170	156	210	39.5	146	208	55	46	77	30
	4P	288	238	400	232	150	140	66	175	230	156	265	34.5	146	208	55	46	77	30

f = minimum distance required for coil removal.

LC1 F630 and F800

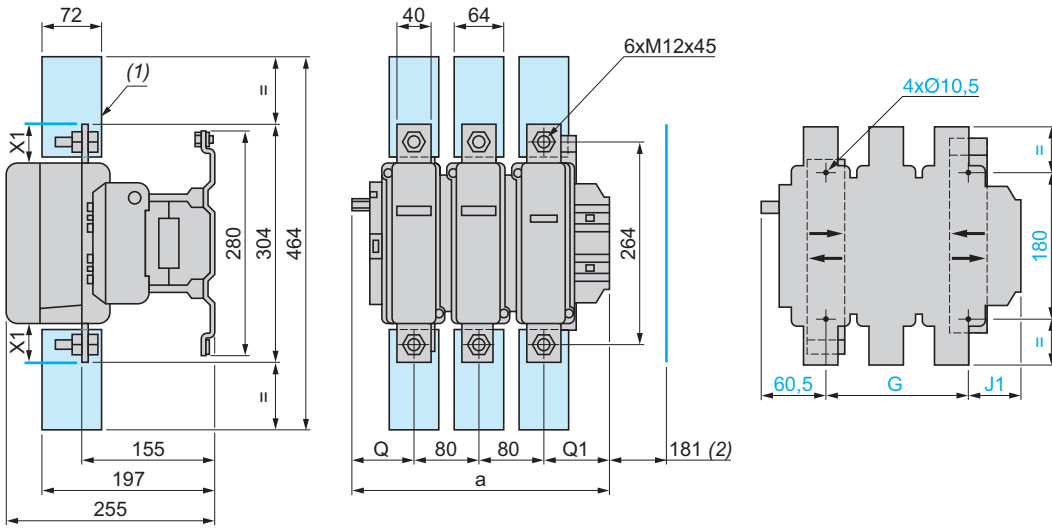

X1 (mm) = Minimum electrical clearance according to operating voltage and breaking capacity.

LC1		a	G supplied	G min.	G max.	J1	Q	Q1
F630	2P	309	180	100	195	68.5	102	127
F630, F800	3P	309	180	100	195	68.5	60	89
F630	4P	389	240	150	275	68.5	60	89

Voltage	200...500 V	690...1000 V	200...690 V	1000 V
---------	-------------	--------------	-------------	--------

LC1 F630	20	30	-	-
LC1 F800	-	-	10	20

(1) Power terminal protection shroud (see page 5/126).
 (2) Minimum distance required for coil removal.

LC1 F780

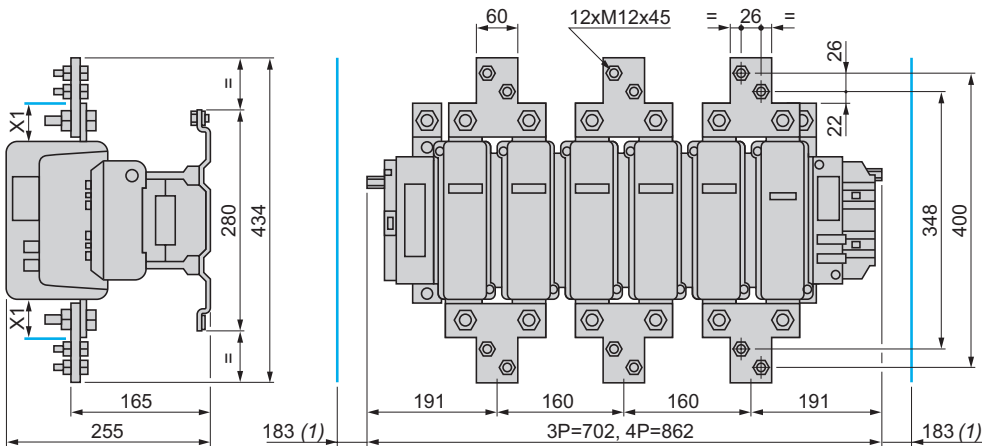

X1 (mm) = Minimum electrical clearance according to operating voltage and breaking capacity.

Voltage	200...500 V	690...1000 V
X1 (mm)	30	35

(1) Minimum distance required for coil removal.

Fixing centres of LC1 F7804

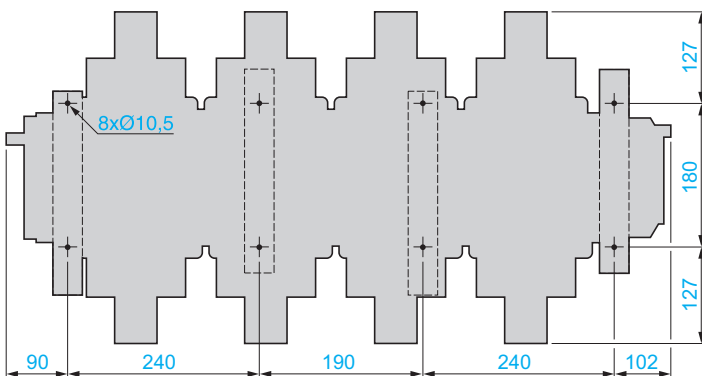

Fixing centres of LC1 F780

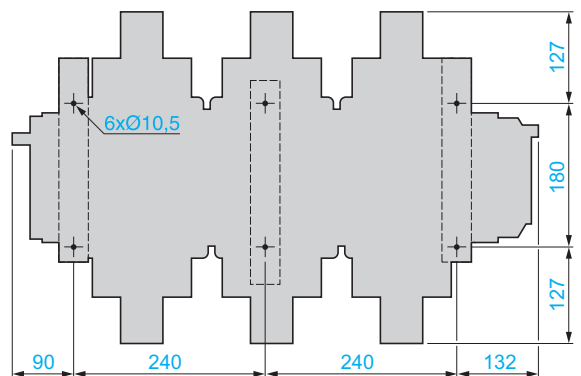

Selection :
pages 5/194 to 5/217

Characteristics :
pages 5/106 to 5/113

References :
pages 5/114 to 5/117

Schemes :
page 5/146

LC1 F1700 and LC1 F2100

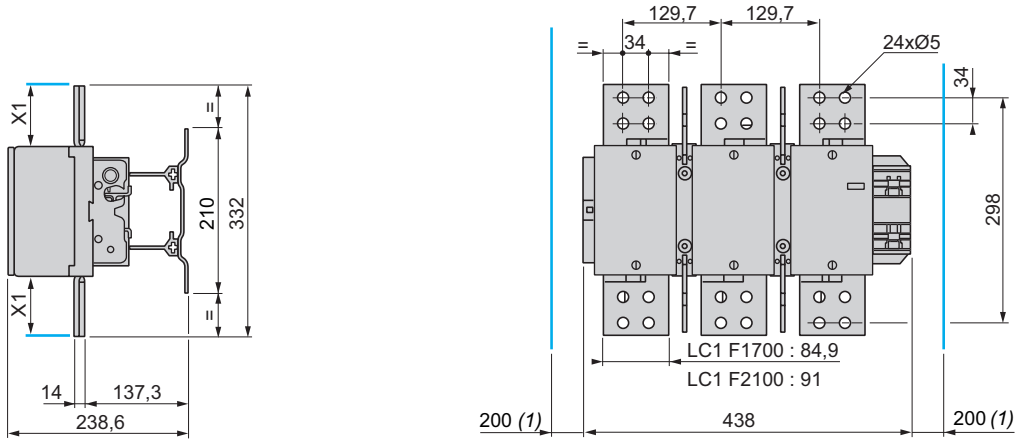

X1 (mm) = Minimum electrical clearance according to operating voltage and breaking capacity.

Voltage	200...500 V	690...1000 V
X1 (mm)	90	100

(1) Minimum distance required for coil removal.

Fixing centres of LC1 F1700 and 2100

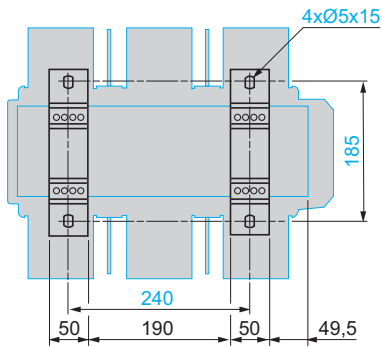

5

Right-angled connectors LA9 F●981 (set of 3) for rear connection

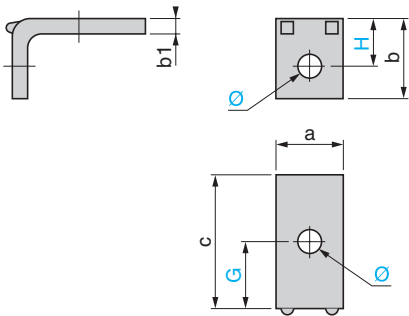

LA9	FF981	FG981	FJ981	FK981	FL981
a	15	20	25	30	40
b	18	23	29	35	48
b1	3	3	4	5	8
c	42	45	55	52	86
G	24	26	32.5	26	45
H	10.5	13	16.5	20	28
Ø	6.5	9	11	11	13

Right-angled connectors LA9 F●979 (set of 3) for side connection

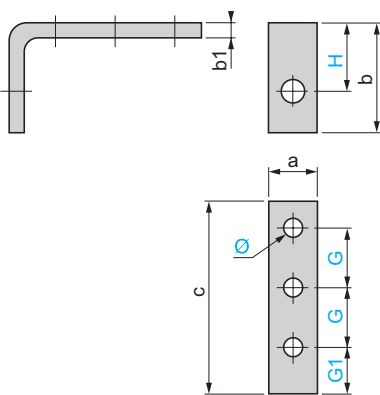

LA9	FF979	FG979	FJ979	FK979	FL979
a	15	20	25	30	40
b	54	58	63.5	68	117
b1	5	5	6	6	10
c	80	92	120	120	130
G	24	28	37	37	37.5
G1	20	22	29	29	35
H	36	39	41	42	76
Ø	6.5	9	11	11	13

Right-angled connectors LA9 F●980 with large surface area (set of 3)

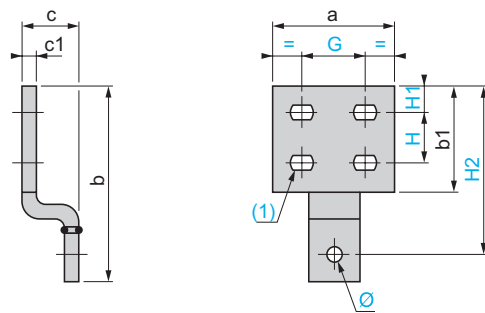

LA9	FF980	FG980	FJ980	FK980	FL980
a	35	40	50	60	100
b	70.5	82.5	98.5	114	154
b1	40	45	55	65	85
c	29	29	33	33	43
c1	3	3	5	5	10
G	18	20	25	29	53
H	18	20	22	26	40
H1	10	12	14	17	20
H2	60.5	72.5	84.5	97	132
Ø	6.5	9	11	11	13
(1)	Ø 7 x 10	Ø 9 x 12	Ø 11 x 14	Ø 12.5 x 15	Ø 12.5 x 15

Right-angled connectors LA9 F2100 (set of 6) for rear connection

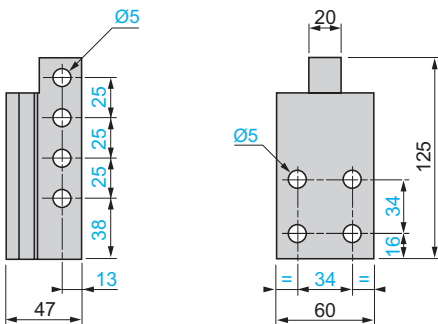

Paralleling links (set of 4)

LA9 FF602, FG602, FH602

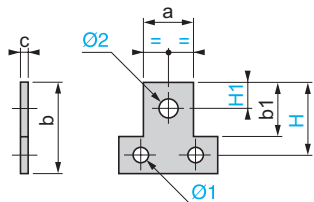

LA9 FK602, FL602

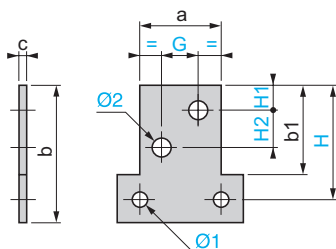

LA9	FF602	FG602	FH602	FK602	FL602
a	25	30	40	50	60
b	45	55	60	85	100
b1	30	35	40	55	65
c	4	5	8	10	10
G	–	–	–	22	26
H	37.5	45	52.5	70	85
H1	12.5	15	15	14	17
H2	–	–	–	22	26
Ø1	6.5	9	11	11	13
Ø2	11	11	13	11	14

Links for "star" connection of 3 poles

LA9 F●601

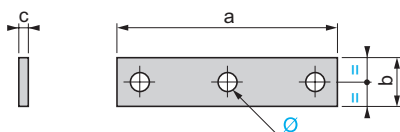

LA9	FF601	FG601	FH601	FK601	FL601
a	69	100	121	140	200
b	15	20	20	30	40
c	3	3	5	5	8
Ø	6.5 x 8.5	8.5 x 10.5	10.5 x 13	11	13

LC1 F115 to F330

On panel

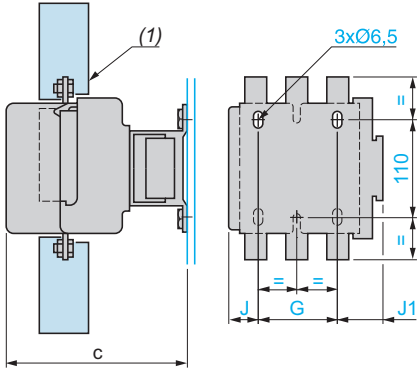

On pre-slotted mounting plate AM1 PA, PB, PC

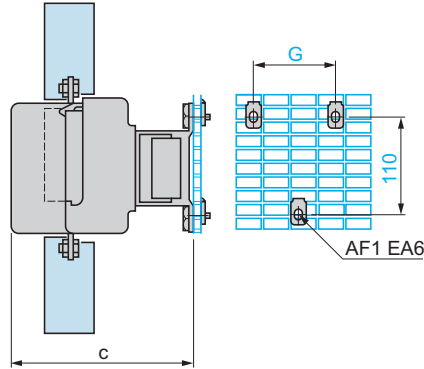

On rails DZ5 MB on 120 mm centres

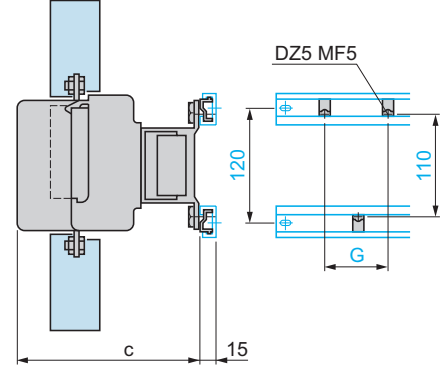

LC1	F115 F150	F185 F225	F265	F330
c (2)	3P 171	181	213	219
	4P 171	181	213	219
G	3P 80	80	96	96
	4P 80	80	96	96
J	3P 26.5	29	44.5	44.5
	4P 45	49	68.5	68.5
J1	3P 57	59.5	61.5	61.5
	4P 75.5	79.5	85.5	85.5

LC1	F115 F150	F185 F225	F265	F330
c (2)	3P 171	181	213	219
	4P 171	181	213	219
G	3P 80	80	96	96
	4P 80	80	96	96

LC1	F115 F150	F185 F225	F265	F330
c (2)	3P 171	181	213	219
	4P 171	181	213	219
G	3P 80	80	96	96
	4P 80	80	96	96

LC1 F

On 2 notched rails AM1 EC●●●

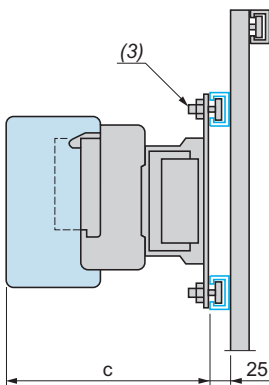

LC1 F115 to F330

LC1 F400 to F800

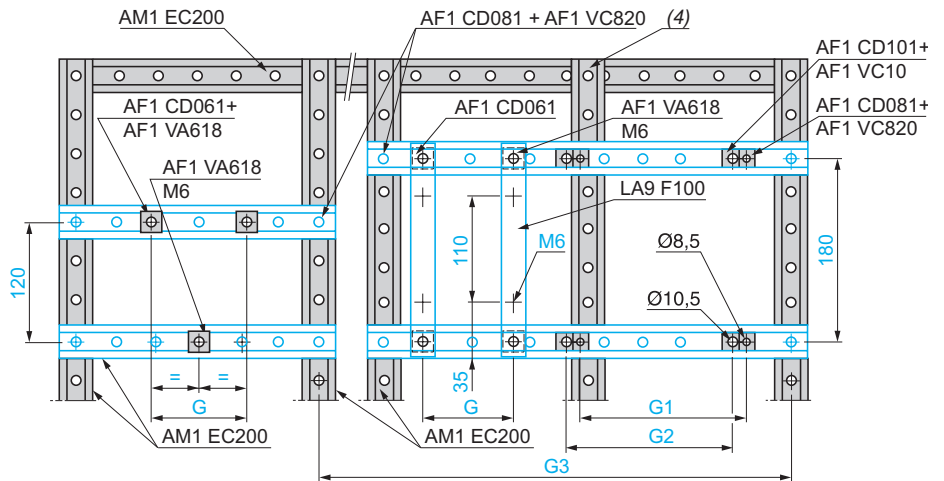

LC1	F115, F150	F185, F225	F265	F330	F400	F500	F630	F780	F800
c	3P 165 (5)	176	207	213	219	232	255	255	255
	4P 165 (5)	176	207	213	219	232	255	255	-
G (M6)	3P 80	80	96	96	-	-	-	-	-
	4P 80	80	96	96	-	-	-	-	-
G1 (Ø 8.5)	3P -	-	-	-	80	80	-	-	-
	4P -	-	-	-	80	140	-	-	-
G2 (Ø 10.5)	3P -	-	-	-	-	-	180	See page 5/141	180
	4P -	-	-	-	-	-	240	-	-

(1) Power terminal protection shroud (see page 5/126).

(2) See X1 (minimum electrical clearance) pages 5/140 and 5/141.

(3) AF1 CD●●● and AF1 VA●●●.

(4) This AM1 EC200 upright is required when G2 or G3 is greater than 700 mm (please consult your Regional Sales Office).

(5) + 6 mm with time-delay block on LC1 F.

Contactors

2, 3 and 4-pole contactors

LC1 F115 to F630
(coil LX1 F ~)

LC1 F115 to F630 (coil LX4 F ~)
 LC1 F115 to F265 (coil LX9 F ~)
 LC1 F800 (coil LX8 F ~)

LC1 F780 ~ or ~

LC1 F1700 ~ or ~
 LC1 F2100 ~ or ~

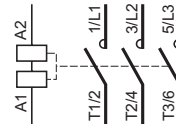
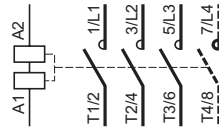
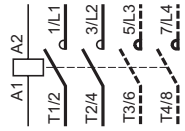
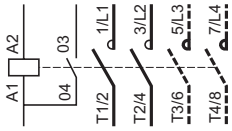

Coils

Standard ~ coils

LX1 FF, FG, FJ...FL
LX1 FH0422...FH3802

LX1 FH0202...FH0362
LX1 FH4402...FH10002
LX1 F8●

LX1 FX
Rectifier supplied and fixed on the contactor

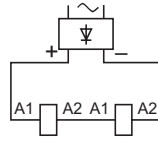
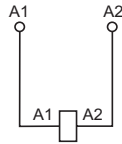
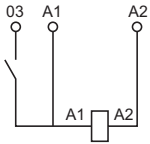

Standard ~ coils

LX4 FF, FG, FH, FJ, FK, FL, FX (1), LX4 F8●

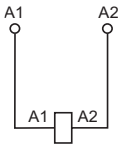

(1) 2 coils in series.

Special ~ coils

LX9 FF, FG

LX9 FH●●●2

LX9 FJ, FK, FL

LX4 F8●

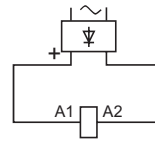
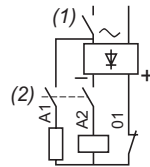
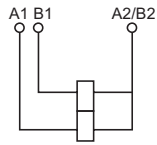
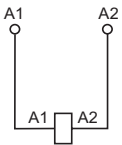

(1) Breaking on ~ side.
Drop-out time 50 ms.
(2) Breaking on ~ side.
Drop-out time 20 ms.

5

Add-on blocks

Instantaneous auxiliary contacts

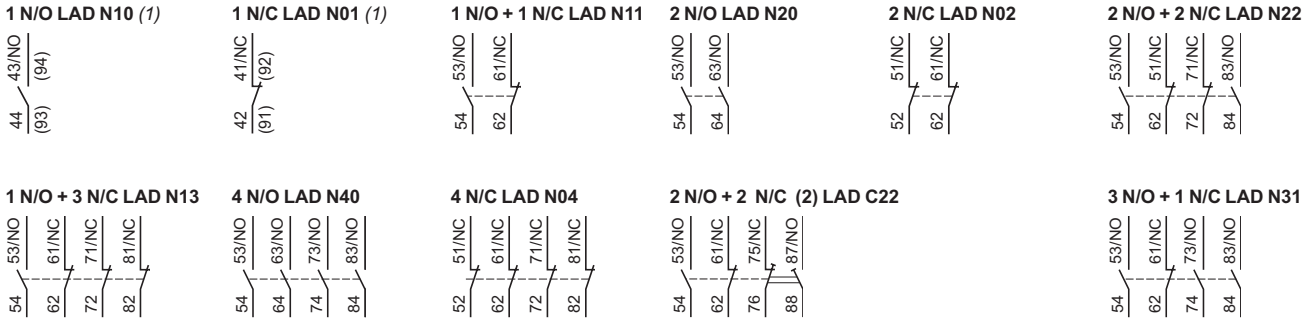

(1) Items in brackets: See "TeSys D contactors".

(2) 1 N/O + 1 N/C make before break.

Instantaneous auxiliary contacts with terminal referencing conforming to standard EN 50012 (References: pages 5/122 and 5/123)

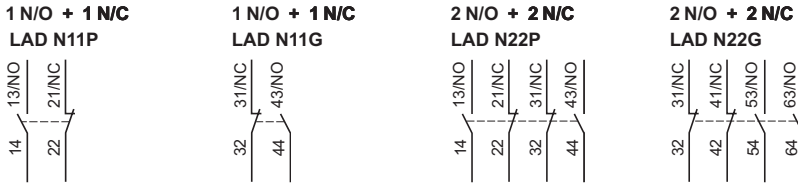

Dust and damp protected instantaneous auxiliary contacts

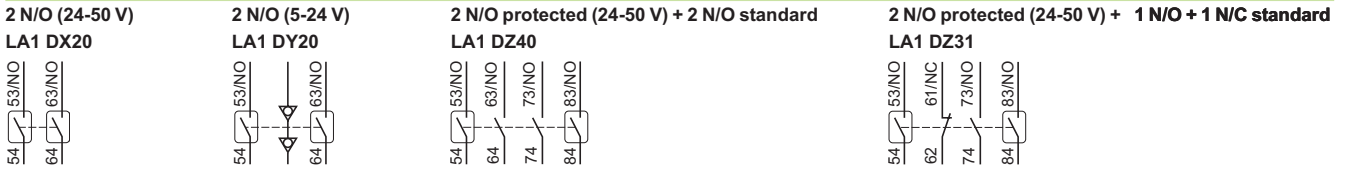

Time delay auxiliary contacts

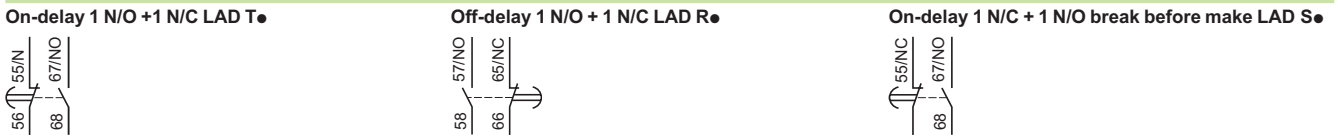

TeSys contactors

TeSys F reversing contactors and changeover contactor pairs

Horizontally mounted

Pre-assembled

LC2 F115 to F265 (reverser supplied on 2 bars which can be used for fixing the device)

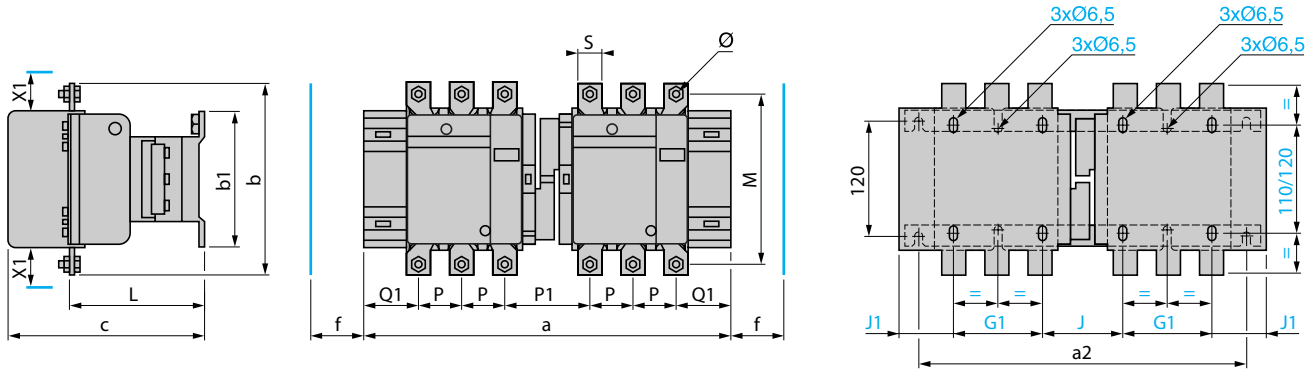

f - Minimum distance required for coil removal.

Bar fixing centres
Vertical: 120 mm
Horizontal: a2 see table

X1 (mm) = Minimum electrical clearance according to operating voltage and breaking capacity.

LC1	200...500 V	660...1000 V
F115, F150	10	15
F185	10	15
F225, F265	10	15

5

LC2		a	a2	b	b1	c	G1	J	J1	L	M	P	P1	Q1	S	f	Ø
F115	3P	345	317	162	137	171	80	71	57	107	147	37	77	60	20	131	M6
	4P	419	378	162	137	171	80	108	75.5	107	147	37	77	60	20	131	M6
F150	3P	345	317	170	137	171	80	71	57	107	150	40	71	57	20	131	M8
	4P	422	381	170	137	171	80	111	75.5	107	150	40	71	55.5	20	131	M8
F185	3P	357	326	174	137	181	80	78	59.5	113.5	154	40	78	59.5	20	130	M8
	4P	437	390	174	137	181	80	118	79.5	113.5	154	40	78	59.5	20	130	M8
F225	3P	357	326	197	137	181	80	78	59.5	113.5	172	48	62	51.5	25	130	M10
	4P	437	390	197	137	181	80	118	79.5	113.5	172	48	54	47.5	25	130	M10
F265	3P	425	386	203	145	213	96	109	61.5	141	178	48	100	66.5	25	147	M10
	4P	521	464	203	145	213	96	157	85.5	141	178	48	100	66.5	25	147	M10

TeSys contactors

TeSys F reversing contactors and changeover contactor pairs
Horizontally mounted

For customer assembly, fixing recommended on AM1 EC uprights, please consult your Regional Sales Office.

2 x LC1 F115 to F330

2 x LC1 F400, F500, F630, F800

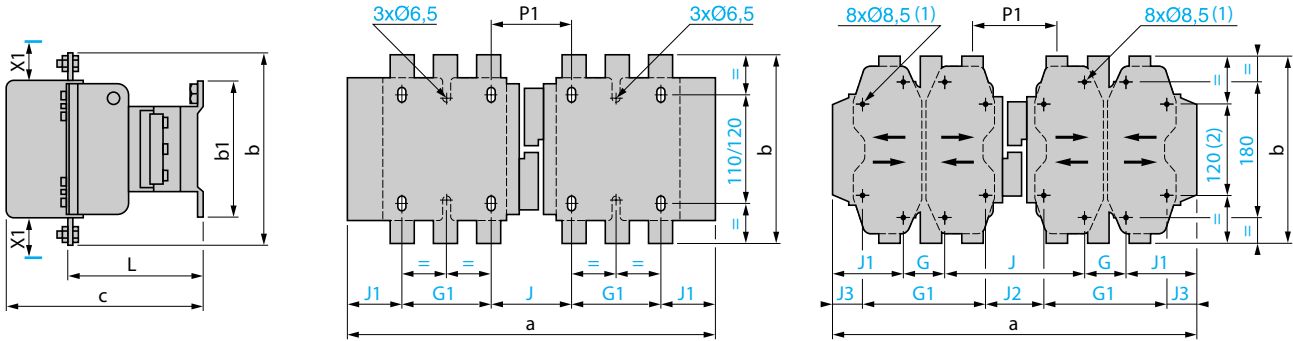

X1 (mm) = Minimum electrical clearance according to operating voltage and breaking capacity.

LC1	200...500 V	660...1000 V	200...690 V	1000 V
F115, F150	10	15	–	–
F185	10	15	–	–
F225, F265	10	15	–	–
F330	10	15	–	–
F400	15	20	–	–
F500	15	20	–	–
F630	20	30	–	–
F800	–	–	10	20

2 x LC1		a	b	b1	c	G	G1	J	J1	J2	J3	L	P1
F115	3P	345	162	137	171	–	80	71	57	–	–	107	77
	4P	419	162	137	171	–	80	108	75.5	–	–	107	77
F150	3P	345	170	137	171	–	80	71	57	–	–	107	71
	4P	422	170	137	171	–	80	111	75.5	–	–	107	71
F185	3P	357	174	137	181	–	80	78	59.5	–	–	113.5	78
	4P	437	174	137	181	–	80	118	79.5	–	–	113.5	78
F225	3P	357	197	137	181	–	80	78	59.5	–	–	113.5	62
	4P	437	197	137	181	–	80	118	79.5	–	–	113.5	54
F265	3P	425	203	145	213	–	96	109	61.5	–	–	141	100
	4P	521	203	145	213	–	96	157	85.5	–	–	141	100
F330	3P	447	206	145	219	–	96	124	65.5	–	–	145	107
	4P	543	206	145	219	–	96	172	89.5	–	–	145	107
F400	3P	446	206	209	219	80	170	157	64.5	67	19.5	145	107
	4P	542	206	209	219	80	170	157	112.5	67	67.5	145	107
F500	3P	485	238	209	232	80	170	156	84.5	66	39.5	146	112
	4P	595	238	209	232	140	230	156	79.5	66	34.5	146	112
F630	3P	636	304	280	255	180	–	139	68.5	–	–	155	137
	4P	796	304	280	255	240	–	139	88.5	–	–	155	137
F800	3P	636	304	280	255	180	–	139	68.5	–	–	155	137

(1) Except LC1 F630 and F800 : 4 x Ø 10.5.

(2) Except LC1 F630 and F800.

For other dimensions: see pages 5/140 and 5/141.

TeSys contactors

TeSys F reversing contactors and changeover contactor pairs

Vertically mounted

For customer assembly, with mechanical interlock (MI) LA9 F, fixing recommended on AM1 EC uprights (please consult your Regional Sales Office).
 2 x LC1 identical or different ratings (LC1 F115 to F630 and F800). See pages 5/118 to 5/121

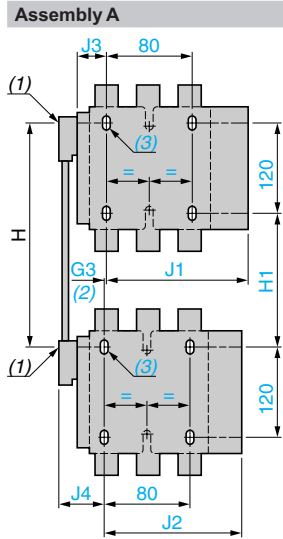

- (1) Mechanical interlock shaft.
- (2) For assembly of contactors of different ratings only.
- (3) 4 x Ø6.5 for LC1 F115 to F225.

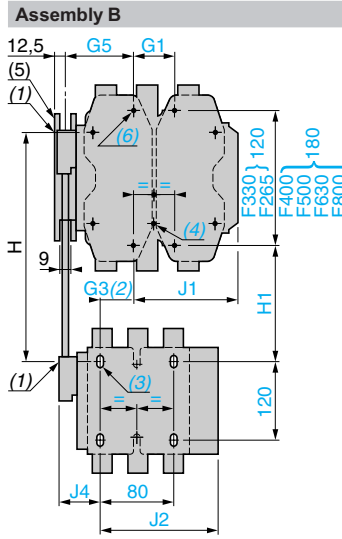

- (4) 4 x Ø6.5 for LC1 F265.
- (5) Mechanical interlock guide bracket.

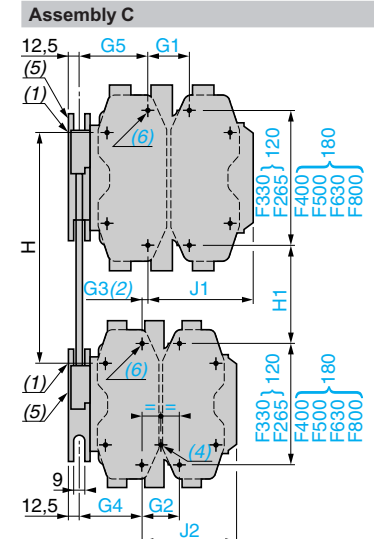

- (6) 4 x Ø8.5 for LC1 F400, F500 or 4 x Ø10.5 for LC1 F630 and F800.

Assembly A (7) - Mechanical interlock reference

	G3 3P	G3 4P	H min.	H max.	H1 min.	H1 max.	J1 3P	J1 4P
LA9 FF4F	0	0	200	310	80	190	137	155.5
LA9 FG4F	3	4	210	300	90	180	139.5	159.5
LA9 FG4G	0	0	220	310	100	190	139.5	159.5

	J2 3P	J2 4P	J3 3P	J3 4P	J4 3P	J4 4P
LA9 FF4F	137	155.5	48.5	67	48.5	67
LA9 FG4F	137	155.5	53	73	54	69
LA9 FG4G	139.5	159.5	53	73	53	73

Assembly B (7) - Mechanical interlock reference

	G1 3P	G1 4P	G3 3P	G3 4P	G5 3P	G5 4P	H min.	H max.
LA9 FH4F	96	96	21	27	60	83	240	380
LA9 FJ4F	80	80	45	26	83	83	250	380
LA9 FK4F	80	140	45	26	83	83	270	380
LA9 FL4F	180	240	35	17	74	74	310	380
LA9 FH4G	96	96	19	23	60	83	250	380
LA9 FJ4G	80	80	42	22	83	83	250	380
LA9 FK4G	80	140	42	22	83	83	270	380
LA9 FL4G	180	240	33	13	74	74	310	380

	H1 min.	H1 max.	J1 3P	J1 4P	J2 3P	J2 4P	J4 3P	J4 4P
LA9 FH4F	110	250	157.5	181.5	137	155.5	48.5	67
LA9 FJ4F	80	210	144.5	192.5	137	155.5	48.5	67
LA9 FK4F	100	210	164.5	219.5	137	155.5	48.5	67
LA9 FL4F	140	210	248.5	328.5	137	155.5	48.5	67
LA9 FH4G	120	250	157.5	181.5	139.5	159.5	53	73
LA9 FJ4G	90	220	144.5	192.5	139.5	159.5	53	73
LA9 FK4G	110	220	164.5	219.5	139.5	159.5	53	73
LA9 FL4G	150	220	248.5	328.5	139.5	159.5	53	73

For customer assembly, fixing recommended on AM1 EC uprights, please consult your Regional Sales Office
 2 x LC1 F780

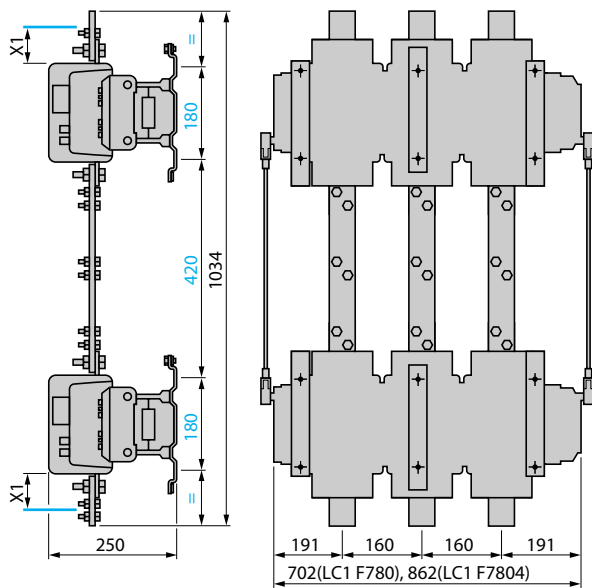

Assembly C (7)

	G1 3P	G1 4P	G2 3P	G2 4P	G3 3P	G3 4P	G4 3P	G4 4P	G5 3P	G5 4P
LA9 FH4H	96	96	96	96	0	0	60	83	60	83
LA9 FJ4H	80	80	96	96	23	0	60	83	83	83
LA9 FK4H	80	140	96	96	23	0	60	83	83	83
LA9 FL4H	180	240	96	96	14	9 (8)	60	83	74	74
LA9 FJ4J	80	80	80	80	0	0	83	83	83	83
LA9 FK4J	80	140	80	80	0	0	83	83	83	83
LA9 FL4J	180	240	80	80	9 (8)	9 (8)	83	83	74	74
LA9 FK4K	80	140	80	140	0	0	83	83	83	83
LA9 FL4K	180	240	80	140	9 (8)	9 (8)	83	83	74	74
LA9 FL4L	180	240	180	240	0	0	74	74	74	74

	H min.	H max.	H1 min.	H1 max.	J1 3P	J1 4P	J2 3P	J2 4P
LA9 FH4H	250	380	130	260	157.5	181.5	157.5	181.5
LA9 FJ4H	260	380	110	230	144.5	192.5	157.5	181.5
LA9 FK4H	280	380	130	230	164.5	219.5	157.5	181.5
LA9 FL4H	330	380	170	220	248.5	328.5	157.5	181.5
LA9 FJ4J	260	380	60	200	144.5	192.5	144.5	192.5
LA9 FK4J	280	380	100	200	164.5	219.5	144.5	192.5
LA9 FL4J	325	380	140	195	248.5	329.5	144.5	192.5
LA9 FK4K	300	380	120	200	164.5	329.5	164.5	219.5
LA9 FL4K	345	380	160	195	248.5	328.5	164.5	219.5
LA9 FL4L	380	380	200	200	248.5	328.5	248.5	328.5

X1 and fixings, see page 5/141.

(7) Only 3P for F800.

(8) In this case, G4 is greater than G5.

Reversing contactors for motor control LC2 F

2 x LC1 F

Horizontally mounted

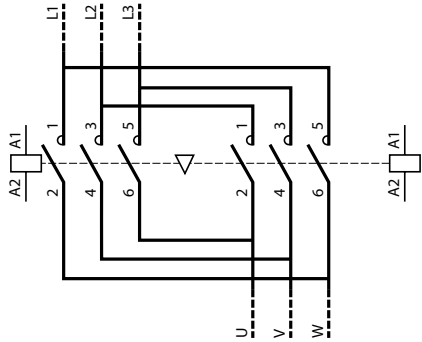

2 x LC1 F

Vertically mounted

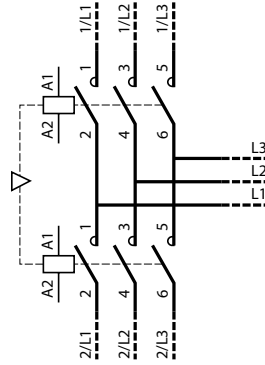

Changeover contactor pairs for distribution LC2 F

2 x LC1 F

Horizontally mounted

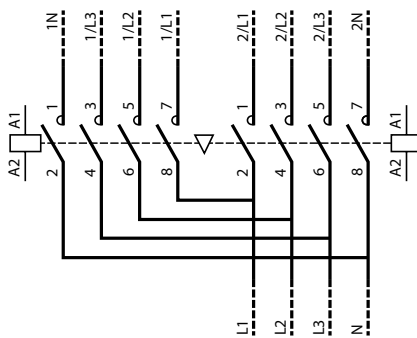

2 x LC1 F

Vertically mounted

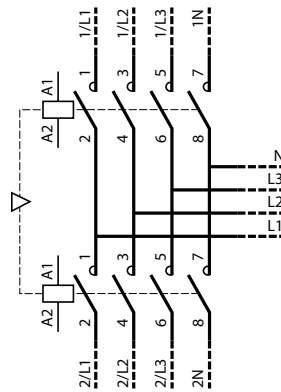

Electrical interlocking of reversers fitted with mechanical interlock without integral electrical contacts

LA9 F

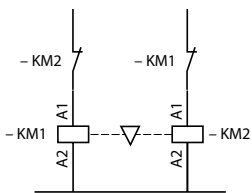

TeSys contactors

High power changeover contactor pairs for distribution

Control circuit: a.c. or d.c.

General

A changeover contactor pair ensures continuity of operation of an installation and energy management.

It switches between:

- a power supply source M (main) which normally supplies the installation,
- and a power supply source S (standby) which may be an incoming line from an additional network or a generating set.

The supply sources may be 3-phase or 3-phase + neutral.

Supply - 3-phase

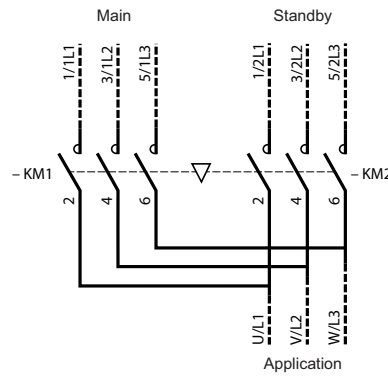

Supply 3-phase + neutral

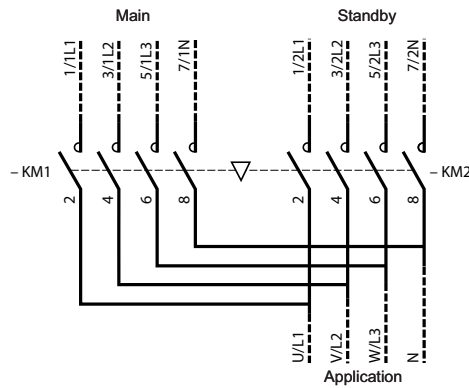

The 2 contactors must be mechanically and electrically interlocked to prevent any paralleling, even transitory, of the two supplies.

TeSys contactors

High power changeover contactor pairs for distribution

Control circuit: a.c. or d.c.

Changeover contactor pairs for customer assembly: 3-phase

Vertically mounted.

Maximum operational voltage: 1000 V

Utilisation category: AC-1

Maximum temperature in the vicinity of the devices: 40 °C

Maximum operational current		Contactors (1)		Mechanical interlock (2)
Main	Standby	Main	Standby	Reference
3-phase	3-phase	Reference	Reference	Reference
1600 A	1000 A	LC1 F780	LC1 F6309	LA9 FX970

1600 A	1600 A	LC1 F780	LC1 F780	LA9 FX970
--------	--------	----------	----------	-----------

Changeover contactor pairs for customer assembly: 3-phase + neutral

Vertically mounted.

Maximum operational voltage: 1000 V

Utilisation category: AC-1

Maximum temperature in the vicinity of the devices: 40 °C

Maximum operational current		Contactors (1)		Mechanical interlock (2)
Main	Standby	Main	Standby	Reference
3-phase + N	3-phase + N	Reference	Reference	Reference
1600 A + 1000 A	1000 A + 1000 A	LC1 F78041	LC1 F63049	LA9 FX970 (3)

1600 A + 1000 A	1600 A + 1000 A	LC1 F78041	LC1 F78040	LA9 FX970 (3)
-----------------	-----------------	------------	------------	---------------

1600 A + 1600 A	1000 A + 1000 A	LC1 F7804	LC1 F63049	LA9 FX971
-----------------	-----------------	-----------	------------	-----------

1600 A + 1600 A	1600 A + 1600 A	LC1 F7804	LC1 F7804	LA9 FX971
-----------------	-----------------	-----------	-----------	-----------

(1) Coils to be ordered separately, see pages 5/132 to 5/137.

(2) Double mechanical interlock mechanism with 2 interlock connecting rods and 4 power connecting links. To order the the 2 auxiliary contact blocks **LAD N●1** required to obtain electrical interlocking between the 2 contactors: see page 5/123.

(3) Neutral connecting link not supplied (to be ordered separately).

813221

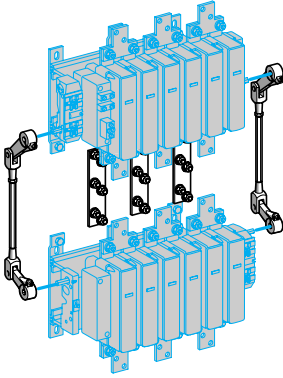

LA9 FX970

813222

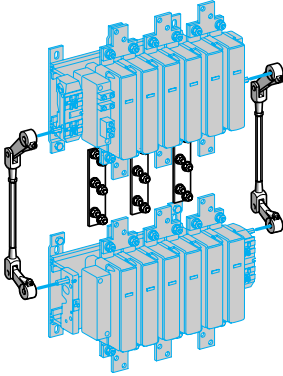

LA9 FX971

TeSys contactors

High power changeover contactor pairs for distribution

Dimensions

Contactor used to assemble high power changeover contactor pairs LC1 F780: see page 5/141

Common side view

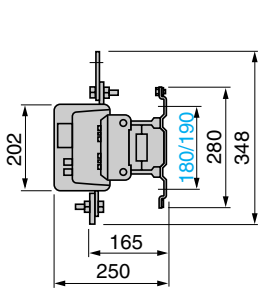

LC1 F6309

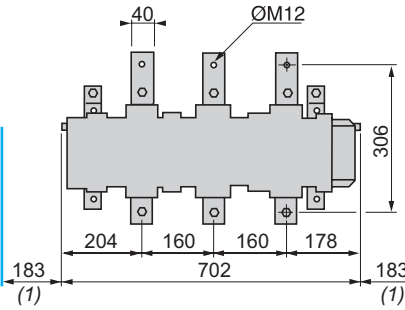

LC1 F63049

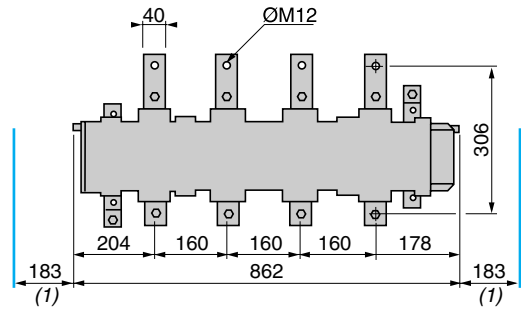

Common side view

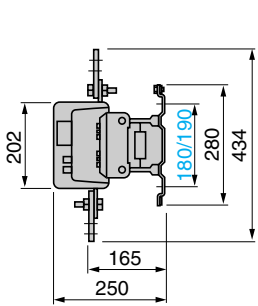

LC1 F78040

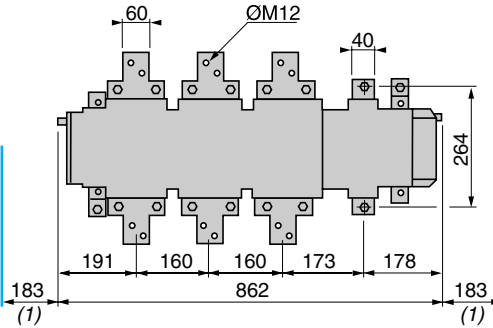

LC1 F78041

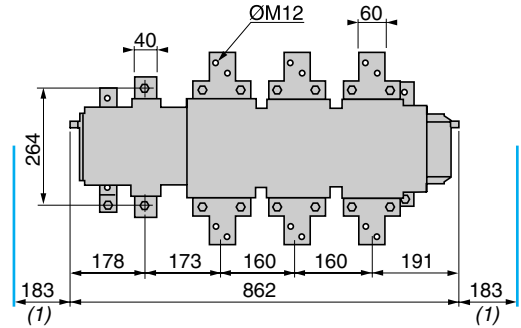

(1) Minimum distance required for removal of each coil.

3-phase changeover contactor pairs

LC1 F780 + LC1 F780 + LA9 FX970: see page 5/150

LC1 F780 + LC1 F6309 + LA9 FX970

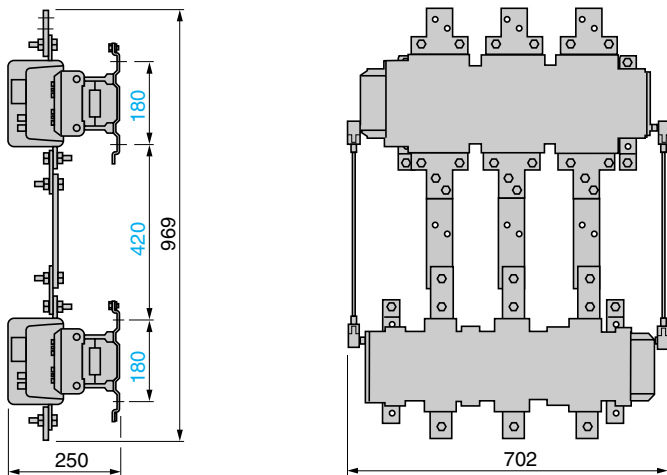

Dimensions (continued)

3-phase + neutral changeover contactor pairs

LC1 F78041 + LC1 F63049 + LA9 FX970

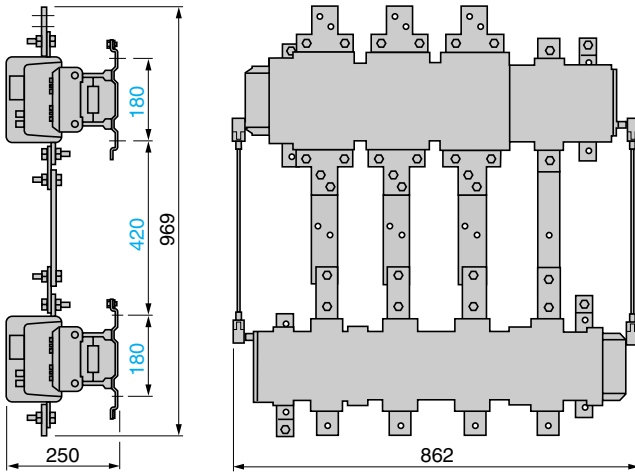

LC1 F78041 + LC1 F78040 + LA9 FX970

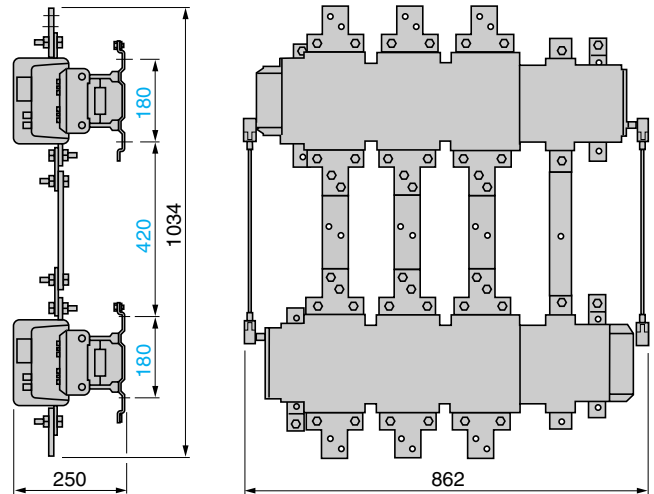

LC1 F7804 + LC1 F63049 + LA9 FX971

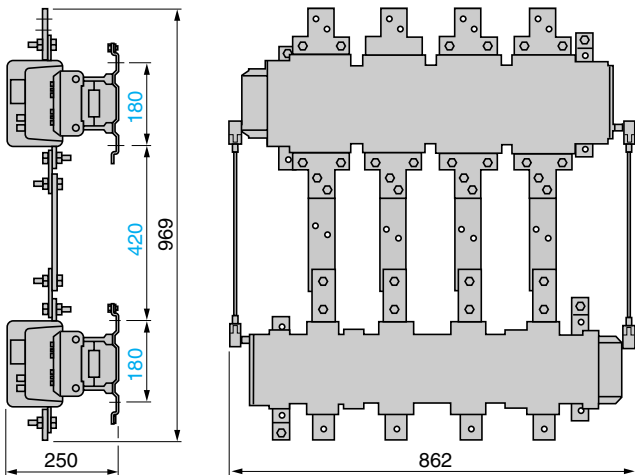

LC1 F7804 + LC1 F7804 + LA9 FX971

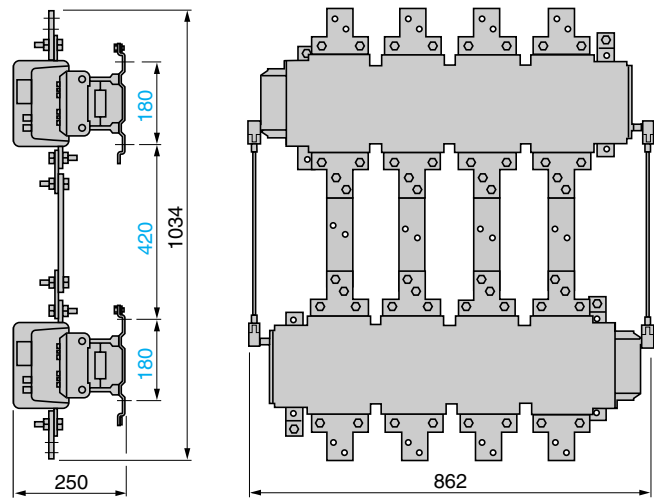

5

Schemes

3-phase changeover contactor pairs

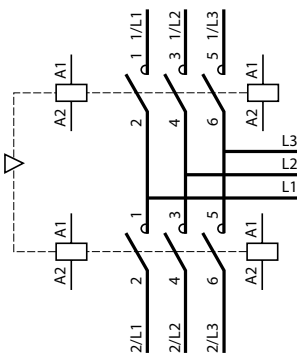

3-phase + neutral changeover contactor pairs

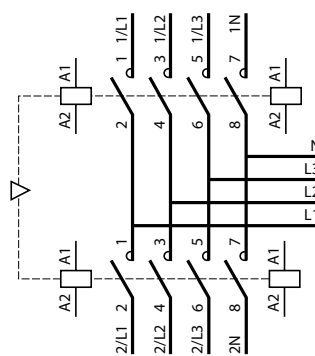

TeSys contactors

Capacitive delayed opening devices

For TeSys D contactors

References

These devices prevent inadvertent opening of a contactor in the event of a brief volt drop or momentary supply failure.



LAZ R90F



LAZ R91F

Control circuit : d.c. supply

For use with contactor		Corresponding delayed opening device			
Type (1)	Contactor reference to be completed (2)	Supply voltage 50/60 Hz	Non-adjustable delay time (Tr)	Reference	Weight
		V	s		kg
LC1 D09,	LC1 D●●PD	110...115	1.5...5	LAZ R90F	0.215
LC1 D12,	LC1 D●●QD	120...127	2.5...5	LAZ R90F	0.215
LC1 D18,	LC1 D●●TD	220	4...8	LAZ R90M	0.215
LC1 D25,	LC1 D●●VD	240	5...10	LAZ R90M	0.215
LC1 D32	LC1 D●●WD	380	4...8	LAZ R90Q	0.215
or					
LC1 D38	LC1 D●●XD	415...440	5.5...13	LAZ R90Q	0.215
LC1 D40,	LC1 D●●PD	110...115	0.5...1	LAZ R90F	0.215
LC1 D50	LC1 D●●QD	120...127	0.5...1.5	LAZ R90F	0.215
or					
LC1 D65	LC1 D●●TD	220...240	1...2.5	LAZ R90M	0.215
	LC1 D●●WD	380	1...2.5	LAZ R90Q	0.215
	LC1 D●●XD	415...440	1...3	LAZ R90Q	0.215
LC1 D80	LC1 D●●PD	110...120	0.4...1	LAZ R90F	0.215
	LC1 D●●QD	120...127	0.5...1	LAZ R90F	0.215
	LC1 D●●TD	220	0.5...2	LAZ R90M	0.215
	LC1 D●●VD	240	1...2.5	LAZ R90M	0.215
	LC1 D●●WD	380	1...2	LAZ R90Q	0.215
	LC1 D●●XD	415...440	1...2.5	LAZ R90Q	0.215

Add-on blocks for delayed opening devices

Application	For use with delayed opening device	Operational voltage	Non-adjustable delay time	Reference	Weight
		V	s		kg
To double the delay time	LAZ R90F	110...127	Tr x 2	LAZ R91F	0.165
	LAZ R90M	220...240	Tr x 2	LAZ R91M	0.165
	LAZ R90Q	380...440	Tr x 2	LAZ R91Q	0.165

(1) These contactors can be supplied as standard for this application or can be adapted by replacing the coil (except for contactors LC1 D09●●●● to LC1 D38●●●● on which the coil is not replaceable).

(2) Reference to be completed : see page 5/62.

Dimensions

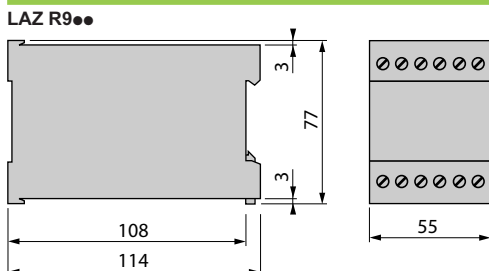

Schemes

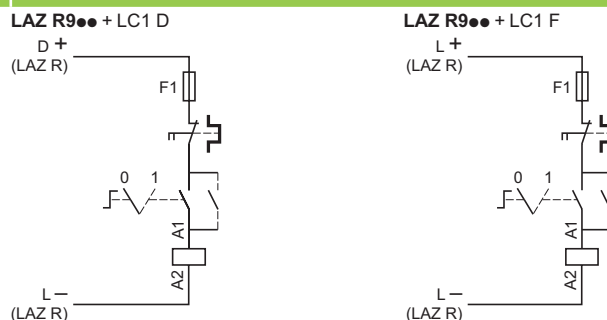

Other versions

Delayed opening devices for use with other types of contactor. Please consult your Regional Sales Office.

TeSys contactors

Capacitive delayed opening devices

For TeSys F contactors

References

These devices prevent inadvertent opening of a contactor in the event of a brief volt drop or momentary supply failure.

Control circuit : d.c. supply (1)

For use with contactor		Corresponding delayed opening device			
Type	With coil	Supply voltage 50/60 Hz	Non- adjustable delay time (Tr)	Reference	Weight
		V	s		kg
LC1 F115 or LC1 F150	LX4 FF110	110	2...5	LAZ R90F	0.215
	LX4 FF125	127	2...5	LAZ R90F	0.215
	LX4 FF220	220	2...5	LAZ R90M	0.215
	LX4 FF250	240	2...5	LAZ R90M	0.215
	LX4 FF375	380...415	2...5	LAZ R90Q	0.215
LC1 F185 or LC1 F225	LX4 FG110	110	2...5	LAZ R90F	0.215
	LX4 FG125	127	2...5	LAZ R90F	0.215
	LX4 FG220	220	2...5	LAZ R90M	0.215
	LX4 FG250	240	2...5	LAZ R90M	0.215
	LX4 FG375	380...415	2...5	LAZ R90Q	0.215
LC1 F265 or LC1 F330	LX4 FH110	110	2...5	LAZ R90F	0.215
	LX4 FH125	127	2...5	LAZ R90F	0.215
	LX4 FH220	220	2...5	LAZ R90M	0.215
	LX4 FH250	240	2...5	LAZ R90M	0.215
	LX4 FH375	380...415	2...5	LAZ R90Q	0.215
LC1 F400	LX4 FJ110	110	1...2	LAZ R90F	0.215
	LX4 FJ125	127	1...2	LAZ R90F	0.215
	LX4 FJ220	220	1...2	LAZ R90M	0.215
	LX4 FJ250	240	1...2	LAZ R90M	0.215
	LX4 FJ375	380	1...2	LAZ R90Q	0.215
	LX4 FJ400	415	1...2	LAZ R90Q	0.215
LC1 F500	LX4 FJ440	440	1...2	LAZ R90Q	0.215
	LX4 FK110	110	1...2	LAZ R90F	0.215
	LX4 FK125	127	1...2	LAZ R90F	0.215
	LX4 FK220	220	1...2	LAZ R90M	0.215
	LX4 FK250	240	1...2	LAZ R90M	0.215
	LX4 FK375	380	1...2	LAZ R90Q	0.215
LC1 F630	LX4 FK400	415	1...2	LAZ R90Q	0.215
	LX4 FK440	440	1...2	LAZ R90Q	0.215
	LX4 FL110	110	1...2	LAZ R90F	0.215
	LX4 FL125	127	1...2	LAZ R90F	0.215
	LX4 FL220	220	1...2	LAZ R90M	0.215
	LX4 FL250	240	1...2	LAZ R90M	0.215
LC1 F630	LX4 FL375	380	1...2	LAZ R90Q	0.215
	LX4 FL400	415	1...2	LAZ R90Q	0.215
	LX4 FL440	440	1...2	LAZ R90Q	0.215

Add-on blocks for delayed opening devices (1)

Application	For use with delayed opening device	Operational voltage	Non- adjustable delay time	Reference	Weight
		V	s		kg
To double the delay time	LAZ R90F	110...127	Tr x 2	LAZ R91F	0.165
	LAZ R90M	220...240	Tr x 2	LAZ R91M	0.165
	LAZ R90Q	380...440	Tr x 2	LAZ R91Q	0.165

(1) Dimensions and schemes: see page 5/156.

Other versions

Delayed opening devices for use with other types of contactor. Please consult your Regional Sales Office.

PF537334



LC1 FG150

PF537336



LC1 FG265

Presentation

In an environment subject to severe mechanical shocks, unwanted closing of a contactor's poles and the serious consequences of this, is not permissible.

Shockproof contactors **LC1 FG150** to **FG630** are equipped with an auxiliary electromechanical device which ensures that the contactor is mechanically locked in the "open" position when it's main electromagnet is not energised.

If the contactor is subjected to mechanical impact, from back to front or from front to back, accidental closing of the poles is then impossible.

In addition, accidental opening of the poles (when the contactor is in the "on" position), is virtually impossible due to the significant pull-in force characteristic of these contactors.

Applications

- **Marine:** on-board equipment, windlasses, capstans, winches, etc...
- **Military equipment :** land, sea, launching silos.
- **Heavy mechanical handling systems:** travelling cranes, cranes, gantries.
- **Conveying and handling:** lifts, hoists, conveyors.
- **Equipment for power stations.**
- **Distribution boards.**

Description of shockproof device

Shockproof contactors **LC1 FG●●●** are equipped with:

- A lever **1** that is rotated by the core of the contactor's electromagnet.
- An auxiliary electromagnet (EV) for the locking function.
- An RC circuit (Resistor-Capacitor) to limit overvoltage.

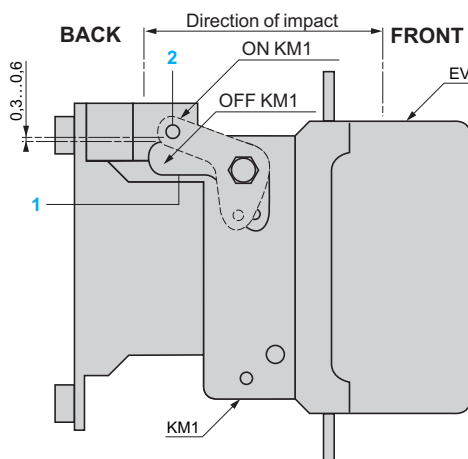

Operation

- In the 'off' position (contactor open and not energised) the core **2** of the electromagnet (EV) locks the lever **1** and therefore the contactor.
- The coils (KM1) and (EV) are energised simultaneously, the core **2** releases the lever **1** and allows the contactor to close.
- De-energisation of the locking electromagnet (EV) is achieved by an auxiliary contact within the contactor. The core **2** rests freely in lever **1**.
- On de-energisation of coil KM1, the moving contact drops out. Core **2**, under spring pressure, once again locks lever **1**.

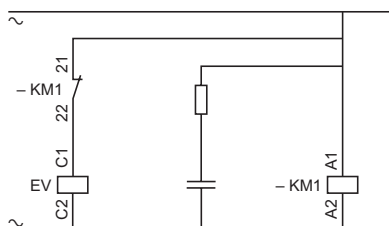

TeSys contactors

3-pole shockproof contactors LC1 FG

a.c. supply

According to the utilisation category and required electrical durability

Use in category AC-3 ($U_e \leq 440$ V)

Operational current and power ($\theta \leq 55$ °C)

Contactors		LC1 FG150	LC1 FG185	LC1 FG265	LC1 FG400	LC1 FG500	LC1 FG630
Operational current	A	150	185	265	400	500	630
Operational power Standard power ratings of motors)	220/230 V	kW 40 <i>hp</i> 54	55 75	75 100	110 150	147 200	200 270
	380/400 V	kW 75 <i>hp</i> 100	90 185	132 180	200 270	250 340	335 450
415 V	kW	80	100	140	220	280	375
	<i>hp</i>	110	136	180	300	380	500
440 V	kW	80	100	140	250	295	400
	<i>hp</i>	110	136	190	340	400	545
500 V	kW	90	110	160	257	355	400
	<i>hp</i>	125	150	220	350	480	545
660/690 V	kW	100	110	160	280	335	450
	<i>hp</i>	136	150	220	380	450	600
1000 V	kW	65	100	147	185	335	450
	<i>hp</i>	85	136	200	250	450	610

Maximum operating rate (operating cycles/hour) (1)

On-load factor	Operational power	LC1 FG150	LC1 FG185	LC1 FG265	LC1 FG400	LC1 FG500	LC1 FG630
≤ 85 %	P	750	750	750	500	500	500
≤ 85 %	0.5 P	2000	2000	2000	1200	1200	1200
≤ 25 %	P	1200	1200	1200	1200	1200	1200

(1) Depending on the operational power and the on-load factor ($\theta \leq 55$ °C)

Electrical durability in utilisation category AC-3 ($U_e \leq 440$ V)

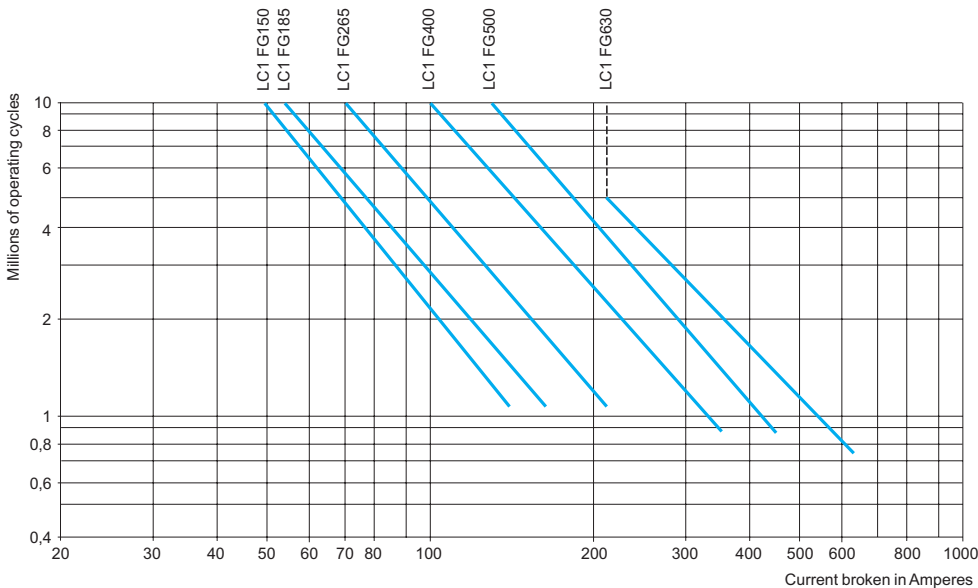

Control of 3-phase asynchronous squirrel cage motors with breaking whilst running.
The current broken (I_e) in category AC-3 is equal to the rated operational current of the motor.

Example:

Asynchronous motor with $P = 55$ kW - $U_e = 380$ V - $I_e = 105$ A
4 million operating cycles required.

The above selection curves show the contactor rating needed: **LC1 FG265**.

TeSys contactors

3-pole shockproof contactors LC1 FG

a.c. supply

According to the utilisation category and required electrical durability

Use in category AC-1 ($U_e \leq 440$ V)

Contactors				LC1 FG150	LC1 FG185	LC1 FG265	LC1 FG400	LC1 FG500	LC1 FG630
Connection	Cable	C.s.a.	mm ²	120	150	240	–	–	–
	Bar	Number		–	–	–	2	2	2
		C.s.a.	mm	–	–	–	30 x 5	40 x 5	60 x 5
Maximum operating rate in operating cycles/hour				600	600	600	600	600	600
Operational current AC-1		≤ 40 °C	A	250	270	350	500	700	1000
		≤ 55 °C	A	220	240	300	430	580	850
		≤ 70 °C (1)	A	170	180	250	340	500	700

(1) Only for operation with coil supplied at U_c .

Increase in operational current by parallel connection of poles

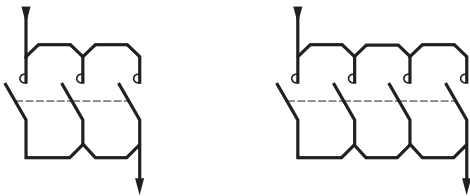

Apply the following multiplying factors to the current values given above. The factors take into account the often unbalanced current distribution between the 2 poles:

- 2 poles in parallel: K = 1.6
- 3 poles in parallel: K = 2.25
- 4 poles in parallel: K = 2.8

Recommended connection scheme to equalise the currents in each pole (see opposite).

Electrical durability in utilisation category AC-1 ($U_e \leq 440$ V)

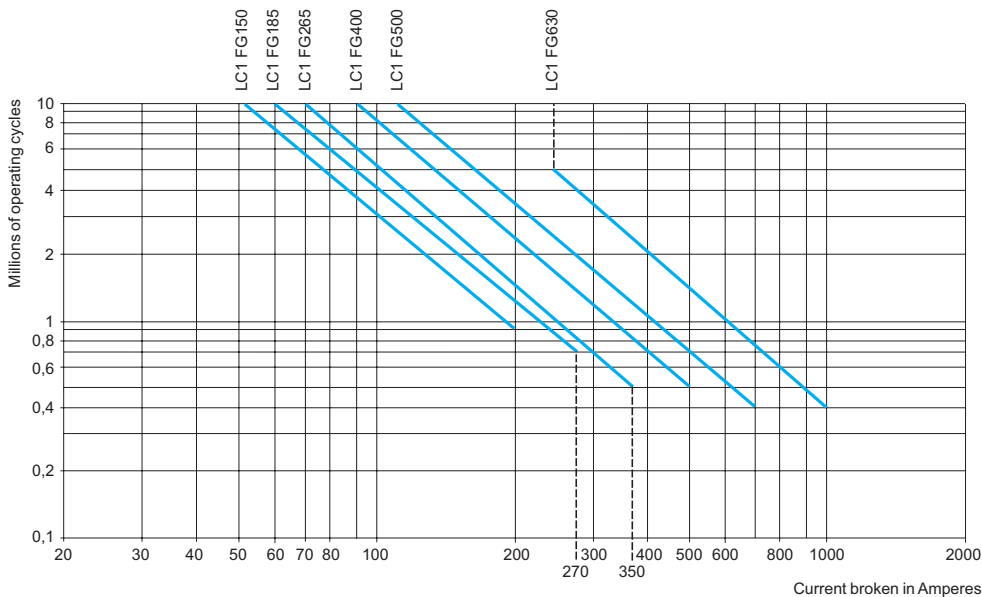

Example:

Control of resistive circuits ($\cos \varphi \geq 0.95$).

The current broken (I_c) in category AC-1 is equal to the current (I_e) normally drawn by the load.

$U_e = 220$ V - $I_c = I_e = 300$ A - $\theta = 40$ °C.

1 million operating cycles required.

The above selection curves show the contactor rating needed: **LC1 FG400**.

TeSys contactors

3-pole shockproof contactors LC1 FG

a.c. supply

According to the utilisation category and required electrical durability

Thermal limits in utilisation categories AC-2/AC-4

Thermal limit zone	Operating cycles/hour (1) and on-load factor	Maximum current broken according to the duty requirements (thermal limit, ambient temperature ≤ 55 °C)					
Contactors		LC1 FG150	LC1 FG185	LC1 FG265	LC1 FG400	LC1 FG500	LC1 FG630
A	From 150 and 15 % to 300 and 10 %	310	380	560	780	1100	1400
B	From 150 and 20 % to 600 and 10 %	280	350	500	700	950	1250
C	From 150 and 30 % to 1200 and 10 %	240	300	400	600	750	950
D	From 150 and 55 % to 2400 and 10 %	190	240	320	450	600	720
E	From 150 and 85 % to 3600 and 10 %	145	170	230	350	500	660

(1) Do not exceed the maximum limit for the mechanical operating cycles.

Counter current braking (plugging)

The current varies from the maximum plug-braking current to the rated motor current.

The current made must be compatible with the making and breaking capacities of the contactor.

In most cases, breaking occurs at a current value close to the locked rotor current and contactor selection can therefore be made using the criteria for utilisation categories AC-2 and AC-4.

Electrical durability in utilisation categories AC-2/AC-4 (U_e ≤ 440 V)

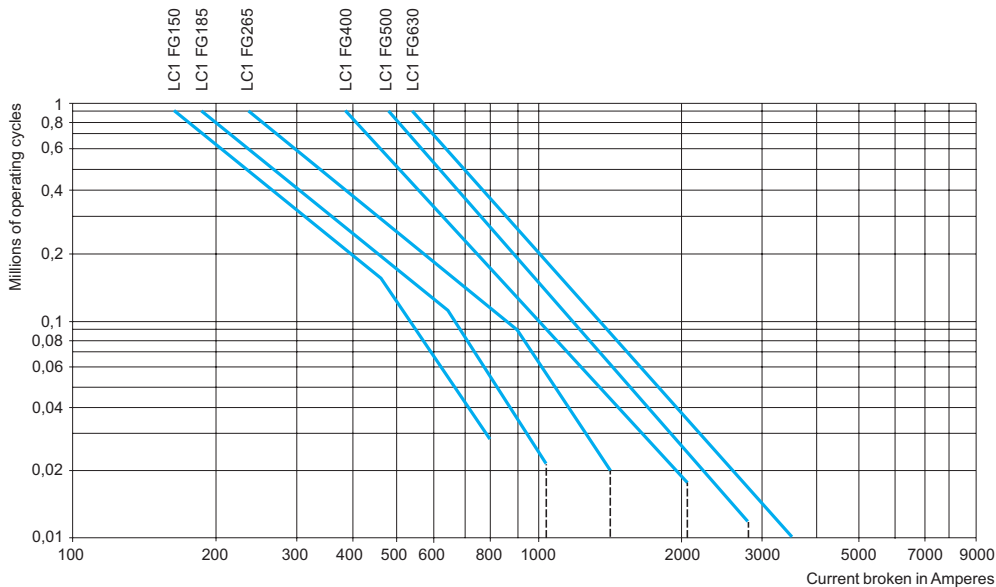

Example: Contactor selection

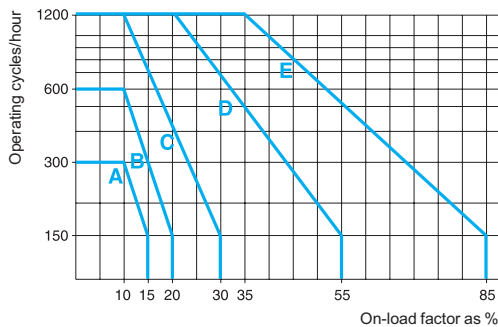

For an on-load factor of 10 % at 400 operating cycles per hour, the curve on the left indicates zone B. If the current broken is 600 A, the above table leads to selection of an **LC1 FG400** contactor. Referring to the electrical durability curves, it can be seen that the contactor will be able to perform 350 000 operating cycles. Where a higher value of electrical durability is required, 1 million operating cycles for example, an **LC1 FG630** contactor would be recommended.

TeSys contactors

For switching 3-phase capacitor banks,
used for power factor correction

Switching the primaries of 3-phase transformers (LV/LV)

Switching 3-phase capacitors

Capacitors, together with the circuits to which they are connected, form oscillatory circuits which can, at the moment of switch-on, give rise to high transient currents (> 180 In) at high frequencies (1 to 15 kHz).

The contactors are used for direct switching. The values of peak current at switch-on must not exceed the values indicated below.

An inductor or an early break resistor may be inserted in each of the three phases supplying the capacitors to reduce the peak current, if necessary. This must be done when switching multiple step capacitor banks.

Inductance values are determined according to the selected operating temperature: please refer to our "Motor starter solutions - Control and protection components" catalogue.

In addition, in accordance with standards IEC 60070, NF C 54 100, VDE 0560, the switching contactor must be able to withstand a continuous current of 1.43 times the rated current of the capacitor bank step being switched.

The rated operational powers given in table the below take this overload into account.

Short-circuit protection is normally provided by g1 fuses rated at 1.3 to 1.6 In.

Maximum operational power of contactors

Maximum operating rate: 120 operating cycles/hour.

Electrical durability at maximum load: 100 000 operations.

With choke inductors connected, where necessary.

Operational power at 50/60 Hz						Maximum peak current	Contactor to be used
$\theta \leq 40\text{ }^\circ\text{C}$			$\theta \leq 55\text{ }^\circ\text{C}$				
220 V	400 V	600 V	220 V	400 V	600 V	A	
240 V	440 V	660 V	240 V	440 V	660 V		
kvar	kvar	kvar	kvar	kvar	kvar		
60	100	135	40	85	90	3200	LC1 FG150
70	125	160	50	100	100	3500	LC1 FG185
90	160	225	75	125	125	5000	LC1 FG265
125	220	300	100	160	200	8000	LC1 FG400
180	300	400	125	220	300	10 000	LC1 FG500
250	400	600	190	350	500	12 000	LC1 FG630

Switching the primaries of 3-phase transformers (LV/LV)

When a transformer is switched on, there is generally an initial current surge which can reach 20 to 40 times the rated current for the power ratings shown below.

This current reaches its peak value almost instantaneously and then decreases in a largely exponential manner, quickly dropping back down to its steady state value.

Contactor selection

Operating rate less than 120 operating cycles/hour.

Maximum operational voltages: 1000 V 50/60 Hz.

The value of the peak magnetising current must be lower than the values indicated below.

Maximum ambient temperature: 55 °C.

Contactor		LC1 FG150	LC1 FG185	LC1 FG265	LC1 FG400	LC1 FG500	LC1 FG630
Maximum permissible current peak at switch-on	A	1700	2800	3500	5500	6800	9000
Maximum operational power (1)	220 V	kVA 25	40	50	75	100	140
	380 V	kVA 50	75	90	130	170	225
	415/440 V	kVA 55	80	100	140	190	250
	500 V	kVA 65	95	110	170	225	280
	660 V	kVA 80	120	140	200	270	315
	1000 V	kVA 100	150	200	250	375	470

(1) Maximum operational power corresponding to a current peak at switch-on of 30 In.

TeSys contactors

3-pole shockproof contactors LC1 FG

d.c. supply

Selection guide for utilisation categories DC-1 to DC-5

Use in category DC-1 (resistive loads; time constant L/R ≤ 1 ms)

Rated operational current I_e

Operational voltage (U _e)	Number of poles to be wired in series	Contactors					
		LC1 FG150	LC1 FG185	LC1 FG265	LC1 FG400	LC1 FG500	LC1 FG630
V		A	A	A	A	A	A
24	1	160	220	300	400	600	850
	2	160	220	300	400	600	850
	3	160	220	300	400	600	850
	4	160	220	300	400	600	850
48/75	1	160	220	300	400	600	850
	2	160	220	300	400	600	850
	3	160	220	300	400	600	850
	4	160	220	300	400	600	850
125	1	–	–	–	–	–	–
	2	130	170	300	400	550	850
	3	130	170	300	400	600	850
	4	130	170	300	400	600	850
225	1	–	–	–	–	–	–
	2	100	150	250	350	450	700
	3	130	170	300	400	600	850
	4	130	170	300	400	600	850
300	3	100	150	250	350	450	700
	4	130	170	300	400	600	850
460	4	100	150	250	350	450	700

Use in category DC-2 to DC-5 (inductive loads; time constant L/R ≤ 15 ms)

Rated operational current I_e

Operational voltage (U _e)	Number of poles to be wired in series	Contactors					
		LC1 FG150	LC1 FG185	LC1 FG265	LC1 FG400	LC1 FG500	LC1 FG630
V		A	A	A	A	A	A
24	1	140	180	280	350	550	850
	2	140	180	280	350	550	850
	3	140	180	280	350	550	850
	4	140	180	280	350	550	850
48/75	1	140	180	280	350	550	850
	2	140	180	280	350	550	850
	3	140	180	280	350	550	850
	4	140	180	280	350	550	850
125	1	–	–	–	–	–	–
	2	100	140	250	350	550	850
	3	120	160	280	350	550	850
	4	120	160	280	350	550	850
225	1	–	–	–	–	–	–
	2	80	100	200	280	450	700
	3	100	140	250	350	550	850
	4	120	160	280	350	550	850
300	3	80	100	200	280	450	700
	4	120	160	280	350	550	850
460	4	80	100	200	280	450	700

Electrical durability

Utilisation categories DC-1 to DC-5

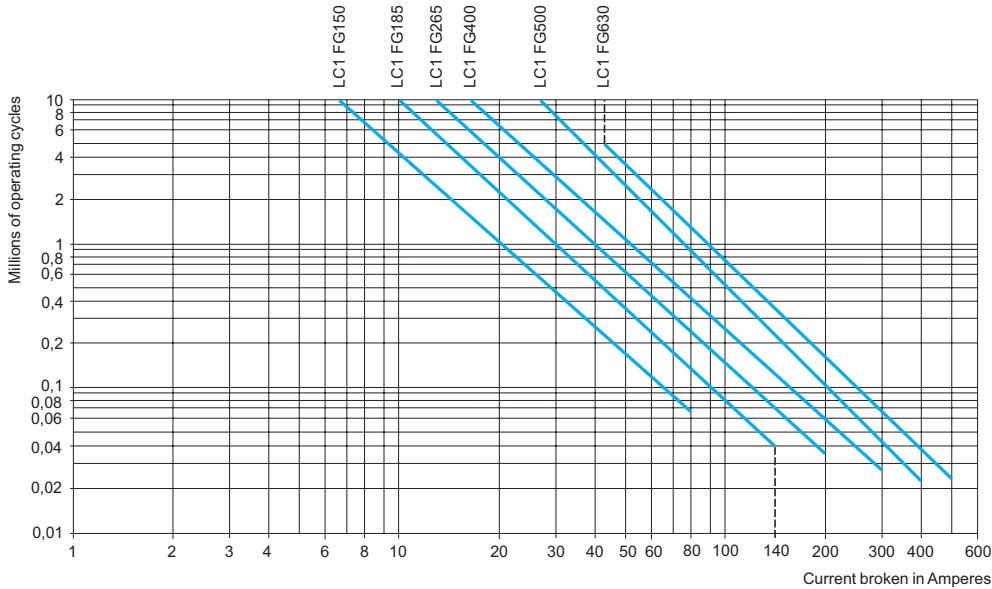

Determining the electrical durability

The electrical durability can be read directly from the curve above, having previously calculated the power broken P_c . The following table gives, for each utilisation category, the value of P_c according to the operational current I_e and the operational voltage U_e .

Utilisation categories	P_c (Power broken)
DC-1 Non-inductive loads	$P_c = U_e \times I_e$
DC-2 Shunt motors, breaking whilst running	$P_c = 0.1 U_e \times I_e$
DC-3 Shunt motors, reversing	$P_c = U_e \times 2.5 I_e$
DC-4 Series wound motors, breaking whilst running	$P_c = 0.3 U_e \times I_e$
DC-5 Series wound motors, reversing	$P_c = U_e \times 2.5 I_e$
Counter current braking (plugging)	$P_c = 1.5 U_e \times 1.5 I_e$

Example:

Series wound motor, breaking whilst motor running, category DC-4.

$P = 50 \text{ kW}$, $U_e = 200 \text{ V}$, $I_e = 250 \text{ A}$.

Select contactor **LC1 FG265** with 3 poles in series.

The power broken is: $P_c = 0.3 U_e \times I_e = 0.3 \times 200 \times 250 = 15 \text{ kW}$.





The electrical durability read from the curve is 8 million operating cycles.

Maximum operating rate

The following operating rate used at I_e must not be exceeded: 120 operating cycles/hour.

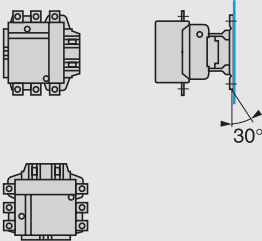
Use of poles in parallel

The electrical durability is equal to the number of operating cycles performed by a pole, multiplied by the number of poles in parallel, multiplied by a coefficient of 0.70.

Environment			
Contactor type		LC1 FG150	LC1 FG185
Rated insulation voltage (Ui)	Conforming to IEC 60947-4-1	V	1000
	Conforming to VDE 0110 gr C	V	1500
Rated impulse withstand voltage (Uimp)	Coil not connected to the power circuit	kV	8
Conforming to standards			EN 60947-1, EN 60947-4-1, IEC 60947-1, IEC 60947-4-1
Product certifications			N.A.T.O.
Degree of protection	Conforming to IEC 60529		IP 20 front face with shrouds LA9 F
	Conforming to VDE 0106		Front face protected against direct finger contact with shrouds LA9 F
Protective treatment	Standard version		"TH"
Ambient air temperature around the device	Storage	°C	- 60...+ 80
	Operation	°C	- 5...+ 55
	Permissible at Uc (1)	°C	- 40...+ 70
Maximum operating altitude	Without derating	m	3000
Operating positions	Without derating		
	With derating (3)		<p>Fixing A</p>  <p>Fixing B</p> 
Not to be used			
Shock resistance (2)			12 g, 50 ms on the three axes: X, Y, Z
			15 g, 11 ms on the three axes: X, Y, Z



(1) In these conditions, it is recommended that coils LX9F be used for contactor sizes FG150 to FG265.

(2) In the least favourable direction, without change of contact state (coil at Uc).

(3) Horizontal fixing:

- The operational current AC-1 is equivalent to 80% of the value indicated in the catalogue
- Breaking and making capacities not guaranteed
- Mechanical and electrical durabilities not guaranteed

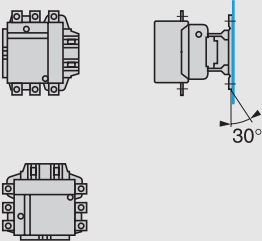
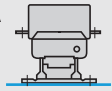
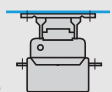
Derating of pull-in and drop-out voltage		FG150	FG185	FG265	FG400	FG500	FG630
Fixing A	Pull-in	75%	75%	75%	80%	80%	80%
	Drop-out	105%	105%	105%	110%	110%	110%
Fixing B	Pull-in	115%	115%	115%	120%	120%	120%
	Drop-out	90%	90%	90%	95%	95%	95%

LC1 FG265	LC1 FG400	LC1 FG500	LC1 FG630
1000			
1500			
8			
EN 60947-1, EN 60947-4-1, IEC 60947-1, IEC 60947-4-1			
N.A.T.O.			
IP 20 front face with shrouds LA9 F			
Front face protected against direct finger contact with shrouds LA9 F			
"TH"			
- 60...+ 80			
- 5...+ 55			
- 40...+ 70			
3000			
			
A 			
B 			
			
12 g, 50 ms on the three axes: X, Y, Z			
15 g, 11 ms on the three axes: X, Y, Z			

Pole characteristics				
Contactor type			LC1 FG150	LC1 FG185
Number of poles			3	3
Rated operational current (Ie) (Ue ≤ 440 V)	In AC-3, θ ≤ 70 °C	A	150/150	185/180
	In AC-1, θ ≤ 55 °C	A	220/170	240/180
Rated operational voltage (Ue)	Up to	V	1000	1000
Frequency limits	Of the operational current (1)	Hz	25 to 200	25 to 200
Conventional thermal current	θ ≤ 40	°C	250	275
Rated making capacity	I rms conforming to IEC 60947-4-1	A	Making current: 10 x I in AC-3	
Rated breaking capacity	I rms conforming to IEC 60947-4-1	A	Making and breaking current: 8 x I in cat. AC-3	
Permissible short time rating No current flowing for preceding 60 minutes with θ ≤ 40 °C	For 1.5 or 10 s	A	1200	1500
	For 30 s	A	700	920
	For 1 mn	A	600	740
	For 3 mn	A	450	500
	For 10 mn	A	350	400
Fuse protection against short-circuits (U ≤ 440 V)	Motor circuit (type aM)	A	160	200
	With thermal overload relay (type gG)	A	200	315
	gG fuses	A	250	315
Average impedance per pole	At Ith and 50 Hz	mΩ	0.35	0.33
Power dissipation per pole for the above operational currents	AC-3	W	8	12
	AC-1	W	22	25
Cabling Minimum c.s.a.	Bar	No. of bars	2	2
		Bar	mm	25 x 3
	Cable with lug	mm²	120	150
	Cable with connector	mm²	120	150
	Bolt diameter	mm	Ø 8	Ø 8
Tightening torque	Power circuit connections	N.m	18	18

(1) Sine wave without interference. Above these values, please consult your Regional Sales Office.

LC1 FG265	LC1 FG400	LC1 FG500	LC1 FG630
3	3	3	3
265/250	400/340	500/500	630/630
300/250	430/340	580/500	850/700
1000	1000	1000	1000
25 to 200	25 to 200	25 to 200	25 to 200
350	500	700	1000
Making current: 10 x I in AC-3			
Making and breaking current: 8 x I in AC-3			
2200	3600	4200	5050
1230	2400	3200	4400
950	1700	2400	3400
620	1200	1500	2200
480	1000	1200	1600
315	400	500	630
500	630	800	800
400	500	800	1000
0.3	0.26	0.18	0.12
21	42	45	48
37	65	88	120
2	2	2	2
32 x 4	30 x 5	40 x 5	60 x 5
240	2 x 150	2 x 240	–
240	–	–	–
Ø 10	Ø 10	Ø 10	Ø 12
35	35	35	58

5

Control circuit characteristics with LX1 coil						
Contactor type				LC1 FG150	LC1 FG185	
Rated control circuit voltage (Uc)	50 or 60 Hz		V	48...440		
Control voltage limits ($\theta \leq 55\text{ }^\circ\text{C}$)	50 or 60 Hz coils	Operation		0.85...1.1 Uc		
		Drop-out		0.35...0.55 Uc		
	40...400 Hz coils	Operation		–		
		Drop-out		–		
Average consumption at 20 °C and at Uc	~ 50 Hz	Inrush	50 Hz coil	VA	550	805
			40...400 Hz coil	VA	–	–
			Cos φ		0.3	0.3
		Sealed	50 Hz coil	VA	45	55
			40...400 Hz coil	VA	–	–
			Cos φ		0.3	0.3
	~ 60 Hz	Inrush	60 Hz coil	VA	660	970
			40...400 Hz coil	VA	–	–
			Cos φ		0.3	0.3
		Sealed	60 Hz coil	VA	55	66
			40...400 Hz coil	VA	–	–
			Cos φ		0.3	0.3
Heat dissipation			W	12...16	18...24	
Operating time (1)	Closing "C"		ms	23...35	20...35	
	Opening "O"		ms	5...15	7...15	
Mechanical durability at Uc	In millions of operating cycles			10	10	
Maximum operating rate at ambient temperature $\leq 55\text{ }^\circ\text{C}$	In operating cycles per hour			2400	2400	
Cabling Min/max c.s.a.	Flexible cable without cable end	1 or 2 conductors	mm²	1/4	1/4	
		1 conductor	mm²	1/4	1/4	
	Flexible cable with cable end	1 conductor	mm²	1/2.5	1/2.5	
		2 conductors	mm²	1/2.5	1/2.5	
Solid cable without cable end	1 or 2 conductors	mm²	1/4	1/4		
Tightening torque			N.m	1.2	1.2	

Characteristics of the locking electromagnet (shockproof device)					
Contactor type				LC1 FG150	LC1 FG185
Control circuit voltage 50/60 Hz			V	48...440	48...440
Inrush consumption			VA	100	100
Maximum energisation time at Uc			ms	20	20
Maximum operating rate				2400	2400
Mechanical durability at Uc				1 x 10 ⁶	1 x 10 ⁶

(1) The closing time "C" is measured from the moment the coil supply is switched on to initial contact of the main poles. The opening time "O" is measured from the moment the coil supply is switched off to the moment the main poles separate.

LC1 FG265	LC1 FG400	LC1 FG500	LC1 FG630
48...440	110...440	110...440	110...440
-	-	-	-
-	-	-	-
0.85...1.1 Uc	0.85...1.1 Uc	0.85...1.1 Uc	0.85...1.1 Uc
0.35...0.55 Uc	0.3...0.5 Uc	0.3...0.5 Uc	0.25...0.5 Uc
-	-	-	-
650	1075	1100	1650
0.9	0.9	0.9	0.9
-	-	-	-
10	15	18	22
0.9	0.9	0.9	0.9
-	-	-	-
650	1075	1100	1650
0.9	0.9	0.9	0.9
-	-	-	-
10	15	18	22
0.9	0.9	0.9	0.9
8	14	18	20
40...65	40...75	40...75	40...80
100...170	100...170	100...170	100...200
10	10	10	10
2400	2400	2400	1200
1/4	1/4	1/4	1/4
1/4	1/4	1/4	1/4
1/2.5	1/2.5	1/2.5	1/2.5
1/4	1/4	1/4	1/4
1.2	1.2	1.2	1.2
LC1 FG265	LC1 FG400	LC1 FG500	LC1 FG630
48...440	110...440	110...440	110...440
100	100	100	100
20	20	20	20
2400	2400	2400	1200
1 x 10 ⁶	1 x 10 ⁶	1 x 10 ⁶	1 x 10 ⁶

TeSys contactors

Auxiliary contact blocks

for 3-pole shockproof contactors LC1 FG

Environment				
Contact block type		LAD N	LAD T and LAD S	LAD R
Conforming to standards		IEC 60947-5-1, NF C 63-140, VDE 0660, BS 4794, EN 60947-5-1		
Product certifications		UL, CSA		
Protective treatment	Conforming to IEC 60068	"TH"		
Degree of protection	Conforming to VDE 0106	Protection against direct finger contact IP2X		
Ambient air temperature around the device	Storage	°C	- 60...+ 80	
	Operation	°C	- 5...+ 60	
	Permissible for operation at Uc	°C	- 40...+ 70	
Maximum operating altitude	Without derating	m	3000	
Cabling	Phillips N° 2 and Ø 6 mm. Flexible or solid cable with or without cable end	mm ²	Min: 1 x 1; max: 2 x 2.5	

Instantaneous and time delay contact characteristics									
Contact block type		LAD N	LAD T and LAD S	LAD R					
Number of contacts		1 or 4	2	2					
Rated operational voltage (Ue)	Up to	V	660						
Rated insulation voltage (Ui)	Conforming to IEC 60947-5-1	V	690						
	Conforming to UL, CSA	V	600						
Conventional thermal current (Ith)	For ambient temperature ≤ 60 °C	A	10						
Frequency of the operational current		Hz	25...400						
Minimum switching capacity	U min	V	17						
	I min	mA	5						
Short-circuit protection	Conforming to IEC 60947-5-1 and VDE 0660. gG fuse	A	10						
Rated making capacity	Conforming to IEC 60947-5-1, I rms	A	~ 140; ∞: 250						
Short-time rating	Permissible for	1 s	A	100					
		500 ms	A	120					
		100 ms	A	140					
Insulation resistance		MΩ	> 10						
Non-overlap time	Guaranteed between N/C and N/O contacts	ms	1.5 (on energisation and on de-energisation)						
Time delay (LADT, R and S contact blocks) Accuracy only valid for setting range indicated on the front face	Ambient air temperature for operation	°C	-	- 40...+ 70	- 40...+ 70				
	Repeat accuracy		-	± 2 %	± 2 %				
	Drift up to 0.5 million operating cycles		-	+ 15 %	+ 15 %				
	Drift depending on ambient air temperature		-	0.25 % per °C	0.25 % per °C				
Mechanical durability	In millions of operating cycles		30	5	5				
Rated operational power of contacts Conforming to IEC 60947-5-1		V	24	48	110/127	220/230	380/400	440	600
		VA	150	300	400	480	500	500	500
		VA	80	170	250	290	320	320	320
		VA	30	65	90	120	130	130	130
		VA	1200	2600	7000	13 000	15 000	13 000	9000

Environment				
Module type			LAD T (On-delay)	LAD R (Off-delay)
Conforming to standards			IEC 60255-5	
Product certifications			UL, CSA	
Protective treatment	Conforming to IEC 60068		"TH"	
Degree of protection	Conforming to VDE 0106		Protection against direct finger contact IP2X	
Ambient air temperature around the device	Storage	°C	- 40...+ 80	
	Operation	°C	- 25...+ 55	
	For operation at U _c	°C	- 25...+ 70	
Rated insulation voltage (U _i)	Conforming to IEC 60947-1	V	250	
Cabling	Phillips N° 2 and Ø 6 mm. Flexible or solid cable with or without cable end	mm ²	Min: 1 x 1; max: 2 x 2.5	

Control circuit characteristics				
Module type			LAD T (On-delay)	LAD R (Off-delay)
Built-in protection	Of the input		By varistor	By varistor
	Contactors coil suppression		By varistor	By bidirectional peak limiting diode
Rated control circuit voltage (U _c)		V	~ or ≐ 24...250	~ 24...250
Permissible variation			0.8...1.1 U _c	0.8...1.1 U _c
Control type			By mechanical contact only	By mechanical contact only connecting cable < 10 m

Time delay characteristics				
Module type			LAD T (On-delay)	LAD R (Off-delay)
Timing ranges		s	0.1...2 ; 1.5...30 ; 25...500	0.1...2 ; 1.5...30 ; 25...500
Repeat accuracy	0...40 °C		± 3 % (10 ms minimum)	± 3 % (10 ms minimum)
Reset time	During time delay period	ms	150	225
	After time delay period	ms	50	–
Immunity to microbreaks	During time delay period	ms	10	20
	After time delay period	ms	2	–
Minimum impulse duration		ms	–	40
Time delay signalling	By LED		Illuminates during time delay period	Illuminates during time delay period

Switching characteristics (solid state type)				
Module type			LAD T (On-delay)	LAD R (Off-delay)
Maximum power dissipated		W	2	3.5
Leakage current		mA	< 5	< 5
Residual voltage		V	3.3	3.3
Overvoltage protection			3 kV; 0.5 joule	3 kV; 0.5 joule
Electrical durability	In millions of operating cycles		30	30

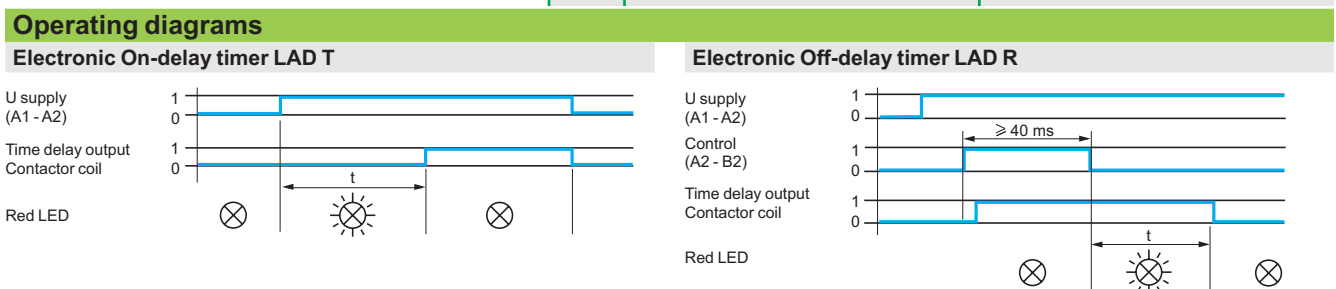

TeSys contactors

3-pole shockproof contactors LC1 FG

For control of motors and distribution circuits.

Control circuit: a.c.

PF537334



LC1 FG150

PF537335



LC1 FG185

PF537336



LC1 FG265

3-pole shockproof contactors

Standard power ratings of 3-phase motors
50-60 Hz in category AC-3

220 V 380 V 660 V
230 V 400 V 415 V 440 V 500 V 690 V 1000 V

Rated operational current in cat. AC-3, 440 V/AC-1 up to



(1)

DCN ref.

Basic reference, to be completed by adding the voltage code (3)

Screw fixing, cabling (2)

Weight

kW	kW	kW	kW	kW	kW	kW	kW	A			kg
40	75	80	80	90	100	65		150/250	CR182	LC1 FG150●●	3.430
55	90	100	100	110	110	100		185/275	CR242	LC1 FG185●●	4.650
75	132	140	140	160	160	147		265/350	CR302	LC1 FG265●●	7.440
110	200	220	250	257	280	185		400/500	CR432	LC1 FG400●●	9.100
147	250	280	295	355	335	335		500/700	CR582	LC1 FG500●●	11.350
200	335	375	400	400	450	450		630/1000	CR852	LC1 FG630●●	18.600

Note: These contactors have instantaneous auxiliary contact blocks with 2 N/O contacts, 1 N/C contact and one coil maintaining contact.

(1) Devices approved by the DCN (French naval shipyard department) and authorised for on-board use.

(2) Power terminals can, if required, be protected against direct finger contact by the addition of shrouds, to be ordered separately (see page 5/176).

(3) Standard control circuit voltages (for other voltages, please consult your Regional Sales Office):

Volt ~		48	110	115	120	208	220	230	240	380	400	415	440
LC1 FG 150...FG185	50 Hz (coil LX1)	E5	F5	F5	-	-	M5	P5	U5	Q5	V5	N5	-
	60 Hz (coil LX1)	E6	F6	-	-	L6	M6	-	U6	Q6	-	-	R6
	50/60 Hz (coil LX9)	E7	F7	F7	G6	L7	M7	P7	U7	Q7	V7	N7	R7
LC1 FG265	40...400 Hz (coil LX1)	E7	F7	F7	G7	L7	M7	P7	U7	Q7	V7	N7	R7
LC1 FG400...FG500	40...400 Hz (coil LX1)	-	F7	F7	G7	L7	M7	P7	U7	Q7	V7	N7	R7
LC1 FG630	40...400 Hz (coil LX1)	-	F7	F7	F7	L7	M7	P7	U7	Q7	V7	N7	R7

TeSys contactors

Auxiliary contact blocks for 3-pole shockproof contactors LC1 FG

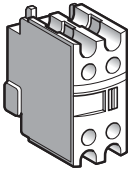

LAD N●●

Instantaneous auxiliary contact blocks						
For use in normal operating environments						
Number of contacts	Max. number of blocks per contactor Clip-on mounting	Composition		Reference	Anchor icon	Weight kg
		NO	NC			
1	1	1	0	LAD N10	(1)	0.020
		0	1	LAD N01	(1)	0.020
4	1	2	2	LAD N22	(1)	0.050
		4	0	LAD N40	(1)	0.050
		0	4	LAD N04	(1)	0.050
		3	1	LAD N31	(1)	0.050

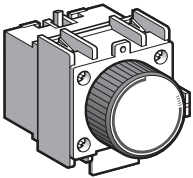

LAD T●

Time delay auxiliary contact blocks						
Number of contacts	Max. number of blocks per contactor Clip-on mounting	Time delay		Reference	Anchor icon	Weight kg
		Type	Range			
			s			
1 N/O + 1 N/C	1	On-delay	0.1...3 (2)	LAD T0		0.060
			0.1...30	LAD T2	(1)	0.060
			10...180	LAD T4		0.060
		Off-delay	1...30 (3)	LAD S2		0.060
			0.1...3 (2)	LAD R0		0.060
			0.1...30	LAD R2	(1)	0.060
		10...180	LAD R4		0.060	

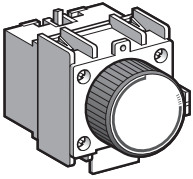

LAD R●

(1) Device approved by the DCN (French naval shipyard department) and authorised for on-board use.
 (2) With extended scale from 0.1 to 0.6 s.
 (3) With switching time of 40 ms ± 15 ms between opening of the N/C contact and closing of the N/O contact.

TeSys contactors

Accessories for 3-pole shockproof contactors LC1 FG

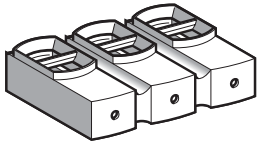

LA9 F103

Insulated terminal blocks				
For use with contactors	Cabling	Tightening	Set of 2 blocks	
			Set reference	Weight kg
LC1 FG150 and FG185	1 x 16...150 mm ² or 2 x 16...95 mm ²	4 mm hexagonal socket key	LA9 F103	0.560

Power terminal protection shrouds				
For use with contactors	Number of shrouds per set	Set reference	 (1)	Weight kg
LC1 FG150 and FG185	6	LA9 F702	(1)	0.250
LC1 FG265, FG400 and FG500	6	LA9 F703	(1)	0.250
LC1 FG630	6	LA9 F704	(1)	0.250

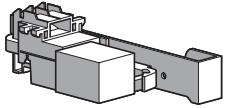

LA9 FG●●●

Shockproof devices (locking electromagnet) (2)					
Maximum energisation time at U _c	Inrush consumption	For contactors	Kit reference, to be completed by adding the voltage code (3)	 (1)	Weight kg
ms	VA				
20	250	LC1 FG150 and FG185	LA9 FG150603●●	(1)	0.200
		LC1 FG265	LA9 FG265603●●	(1)	0.200
		LC1 FG400 and FG500	LA9 FG400603●●	(1)	0.200
		LC1 FG630	LA9 FG630603●●	(1)	0.200

(1) Device approved by the DCN (French naval shipyard department) and authorised for on-board use.

(2) Replacement shockproof device, supplied in kit form, comprising:

- 1 locking electromagnet.

- fixings suitable for the contactor rating.

(3) Control circuit voltage:

Volt ~		48	110	115/120	208	220	230/240	380	415	440
LA9 FG150 to FG265	50/60 Hz	E	F	F	M	M	M	Q	N	N
LA9 FG400 to FG630	50/60 Hz	-	F	F	M	M	M	Q	N	N

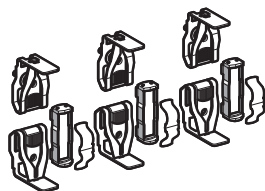

LA5 FG431

Sets of contacts

Per pole: 2 fixed contacts, 1 moving contact, 2 deflectors, 1 back-plate, clamping screws and washers.

For use on contactors	Replacement for	Reference		Weight kg
LC1 FG150	3 poles	LA5 FF431	(1)	0.270
LC1 FG185	3 poles	LA5 FG431	(1)	0.350
LC1 FG265	3 poles	LA5 FG431	(1)	0.660
LC1 FG400	3 poles	LA5 F400803	(1)	2.000
LC1 FG500	3 poles	LA5 F500803	(1)	2.950
LC1 FG630	3 poles	LA5 F630803	(1)	6.100

Arc chambers

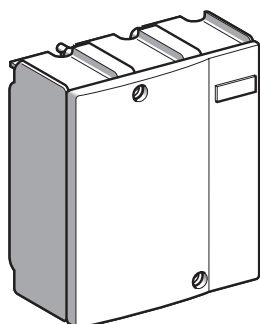

LA5 F40050

For use on contactors	Replacement for	Reference		Weight kg
LC1 FG150	3 poles	LA5 F15050	(1)	0.490
LC1 FG185	3 poles	LA5 F18550	(1)	0.670
LC1 FG265	3 poles	LA5 F26550	(1)	0.920
LC1 FG400	3 poles	LA5 F40050	(1)	1.300
LC1 FG500	3 poles	LA5 F50050	(1)	1.850
LC1 FG630	3 poles	LA5 F63050	(1)	3.150

(1) Device approved by the DCN (French naval shipyard department) and authorised for on-board use.

TeSys contactors

Coils for 3-pole shockproof contactors LC1 FG

Spare or replacement parts

a.c. supply 50/60 Hz

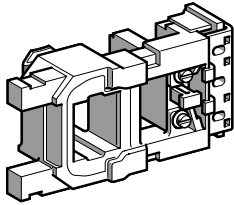

LX1 FF●●●

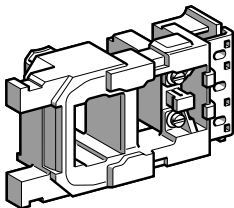

LX1 FG●●●

5

References

Control circuit voltage U _c		Voltage code	Coil reference		Weight
50 Hz	60 Hz				
V	V				kg
Coils for contactors LC1 FG150					
–	48	E6	LX1 FF040		0.430
48	–	E5	LX1 FF048		0.430
–	110	F6	LX1 FF092		0.430
–	115/120	G6	LX1 FF095	(1)	0.430
110/115	–	F5	LX1 FF110		0.430
120	–	FE5	LX1 FF120		0.430
–	208	L6	LX1 FF170		0.430
–	320	M6	LX1 FF184		0.430
–	230/240	U6	LX1 FF187		0.430
208	–	LE5	LX1 FF200		0.430
220/230	–	M5	LX1 FF220		0.430
240	–	U5	LX1 FF240		0.430
–	380	Q6	LX1 FF316		0.430
–	415	N6	LX1 FF340		0.430
–	440	R6	LX1 FF360		0.430
380	–	Q5	LX1 FF380		0.430
415/440	–	N5	LX1 FF415		0.430

Specifications

Average consumption at 20 °C:

- inrush 50 Hz: 550 VA; 60 Hz: 660 VA,

- sealed 50 Hz: 45 VA; 60 Hz: 55 VA, cos φ = 0.32.

Operating cycles/hour (θ = 55 °C): 2400.

Coils for contactors LC1 FG185

–	48	E6	LX1 FG040		0.550
48	–	E5	LX1 FG048		0.550
–	110	F6	LX1 FG092		0.550
–	115/120	G6	LX1 FG095	(1)	0.550
110/115	–	F5	LX1 FG110		0.550
120	–	FE5	LX1 FG120		0.550
–	208	L6	LX1 FG170		0.550
–	320	M6	LX1 FG184		0.550
–	230/240	U6	LX1 FG187		0.550
208	–	LE5	LX1 FG200		0.550
220/230	–	M5	LX1 FG220		0.550
240	–	U5	LX1 FG240		0.550
–	380	Q6	LX1 FG316		0.550
–	415	N6	LX1 FG340		0.550
–	440	R6	LX1 FG360		0.550
380	–	Q5	LX1 FG380		0.550
415/440	–	N5	LX1 FG415		0.550

Specifications

Average consumption at 20 °C:

- inrush 50 Hz: 805 VA; 60 Hz: 970 VA,

- sealed 50 Hz: 55 VA; 60 Hz: 66 VA, cos φ = 0.34.

Operating cycles/hour (θ = 55 °C): 2400.

(1) Device approved by the DCN (French naval shipyard department) and authorised for on-board use.

TeSys contactors

Coils for 3-pole shockproof contactors LC1 FG
Spare or replacement parts
a.c. supply 50/60 Hz

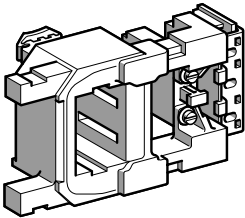

LX1 FH●●●

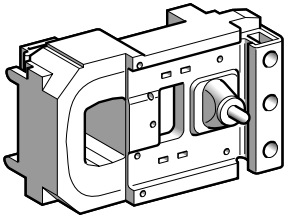

LX1 FJ●●●

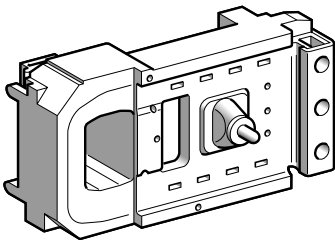

LX1 FK●●●

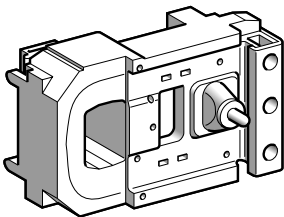

LX1 FL●●●

References (continued)

Control circuit voltage U _c 50 and 60 Hz V	Voltage code	Coil reference		Weight kg
Coils for contactors LC1 FG265				
110/120	F7	LX1 FH1102	(1)	0.740
208	L7	LX1 FH2002		0.740
220/230	M7	LX1 FH2202		0.740
240	U7	LX1 FH2402		0.740
380/415	Q7	LX1 FH3802		0.740

Specifications

Average consumption at 20 °C:

- inrush 50 or 60 Hz: 600 to 700 VA,

- sealed 50 or 60 Hz: 8 to 10 VA, cos φ = 0.9.

Operating cycles/hour (θ = 55 °C): 2400.

Coils for contactors LC1 FG400

110/120	F7	LX1 FJ110	(1)	1.000
208	L7	LX1 FJ200		1.000
220/230	M7	LX1 FJ220		1.000
230/240	U7	LX1 FJ240		1.000
380/400	Q7	LX1 FJ380		1.000
415/440	N7	LX1 FJ415		1.000

Specifications

Average consumption at 20 °C:

- inrush 50 or 60 Hz: 1000 to 1150 VA,

- sealed 50 or 60 Hz: 12 to 18 VA, cos φ = 0.9.

Operating cycles/hour (θ = 55 °C): 2400.

Coils for contactors LC1 FG500

110/120	F7	LX1 FK110	(1)	1.150
208	L7	LX1 FK200		1.150
220/230	M7	LX1 FK220		1.150
230/240	U7	LX1 FK240		1.150
380/400	Q7	LX1 FK380		1.150
415/440	N7	LX1 FK415		1.150

Specifications

Average consumption at 20 °C:

- inrush 50 or 60 Hz: 1050 to 1150 VA,

- sealed 50 or 60 Hz: 16 to 20 VA, cos φ = 0.9.

Operating cycles/hour (θ = 55 °C): 2400.

Coils for contactors LC1 FG630

110/120	F7	LX1 FL110	(1)	1.500
208	L7	LX1 FL200		1.500
220/230	M7	LX1 FL220		1.500
380/400	Q7	LX1 FL380		1.500
415/440	N7	LX1 FL415		1.500

Specifications

Average consumption at 20 °C:

- inrush 50 or 60 Hz: 1500 to 1730 VA,

- sealed 50 or 60 Hz: 20 to 25 VA, cos φ = 0.9.

Operating cycles/hour (θ = 55 °C): 1200.

(1) Device approved by the DCN (French naval shipyard department) and authorised for on-board use.

Dimensions

LC1 FG150, FG185 and FG265

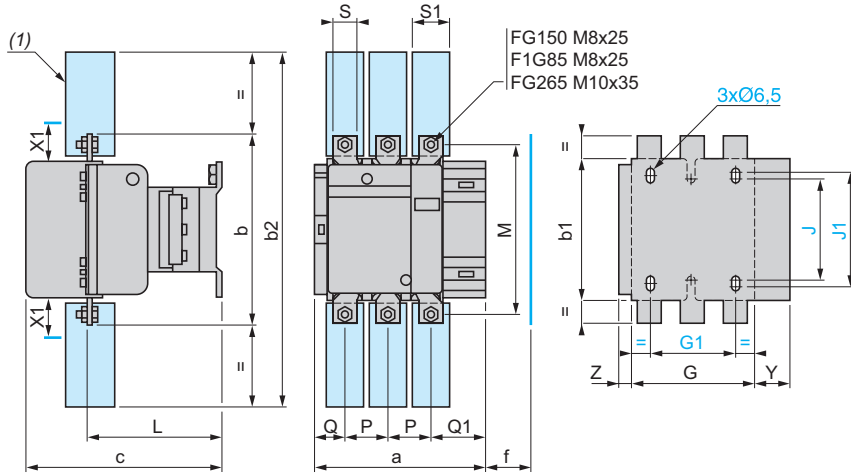

X1 (mm) = Minimum electrical clearance according to operating voltage and breaking capacity.

LC1	200...500 V	600...1000 V
FG150	10	15
FG185	10	15
FG265	10	15

(1) Power terminal protection shroud (see page 5/176).

LC1	a	b	b1	b2	c	f	G	G1	J	J1	L	M	P	Q	Q1	S	S1	Y	Z
FG150	181	170	137	301	180	131	106	80	106	120	116	150	40	26	57.5	20	34	44	13.5
FG185	183.5	174	137	305	190	130	111	80	106	120	122.5	154	40	29	59.5	20	34	44	13.5
FG265	217.5	203	145	375	222	147	142	96	106	120	150	178	48	39	66.5	25	44.5	38	21.5

f = minimum distance required for coil removal.

5

LC1 FG400 and FG500

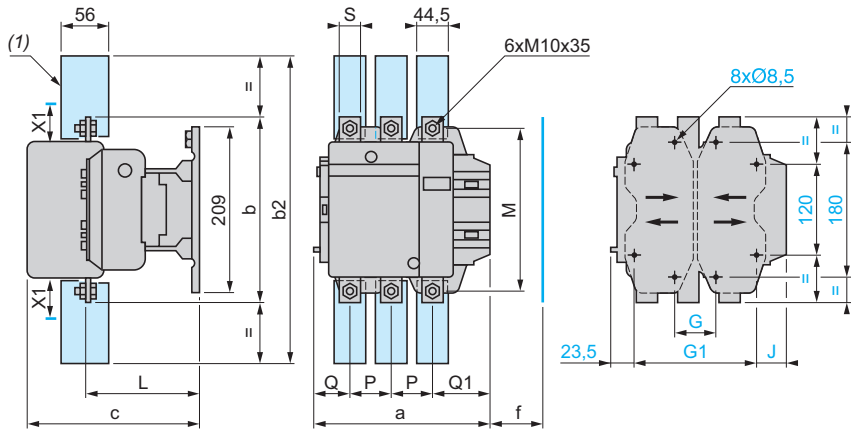

X1 (mm) = Minimum electrical clearance according to operating voltage and breaking capacity.

LC1	200...500 V	600...1000 V
FG400	15	20
FG500	15	20

(1) Power terminal protection shroud (see page 5/176).

LC1	a	b	b2	c	f	G	G supplied	G min.	G max.	G1 supplied	G1 min.	G1 max.	J	L	M	P	Q	Q1	S
FG400	237	206	375	234	146	80	66	102	223	156	192	19.5	160	181	48	75	74	25	
FG500	257	238	400	247	150	80	66	120	223	156	210	39.5	181	208	55	78	77	30	

f = minimum distance required for coil removal.

Dimensions (continued)

LC1 FG630

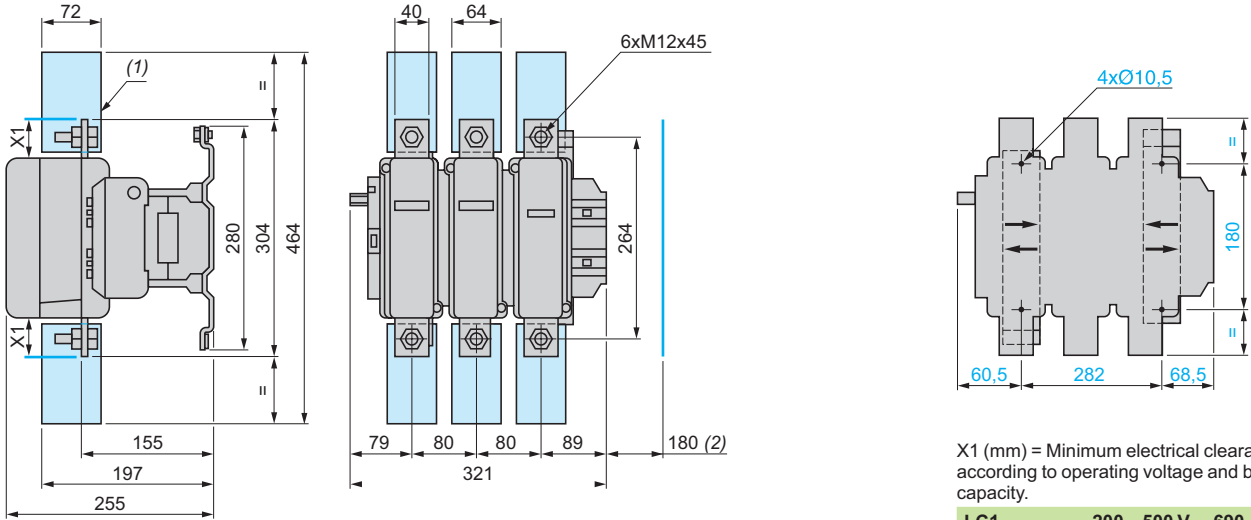

X1 (mm) = Minimum electrical clearance according to operating voltage and breaking capacity.

LC1	200...500 V	690...1000 V
FG630	20	30

(1) Power terminal protection shroud (see page 5/176).
(2) Minimum distance required for coil removal.

Schemes

Contactors LC1-FG150 to FG630

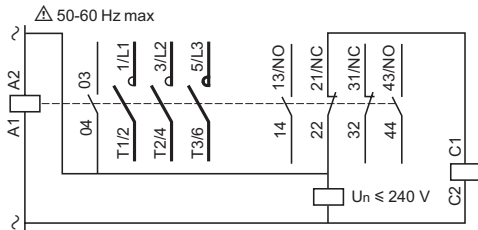

Add-on blocks

Instantaneous auxiliary contacts

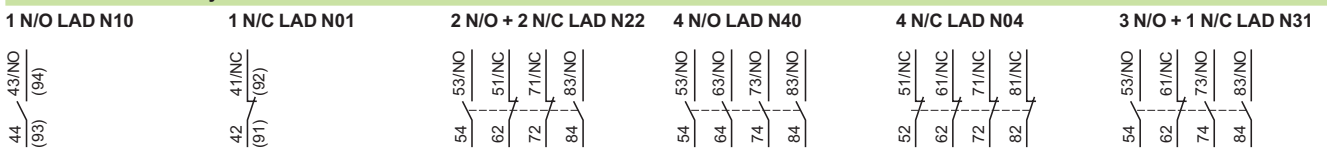

Time delay auxiliary contacts



Coils ~

LX1 FF, FG, FH, FJ, FK and FL

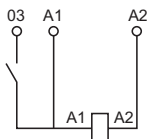

Environment						
Contactor type			LC1 BL	LC1 BM	LC1 BP	LC1 BR
Rated insulation voltage (Ui)	Conforming to IEC 60158-1/IEC 60947-4	V	1000	1000	1000	1000
	Conforming to VDE 0110 gr C	V	1500	1500	1500	1500
Conforming to standards			IEC 60158-1, IEC 60947-4, NF C 63-110, VDE 0660, BS 5424			
Product certifications			CSA, BV, RINA			
Protective treatment	Standard version		"TC"			
	Special version		"TH"			
Ambient air temperature around the device (for operation at U _c)	Storage	°C	- 60... + 80			
	Operation	°C	- 5... + 55			
	Permissible	°C	- 50... + 60			
Maximum operating altitude	Without derating	m	3000			
Operating positions	Without derating		± 30° occasional, in relation to normal vertical mounting plane			
Pole characteristics						
Number of poles			1, 2, 3 or 4	1, 2, 3 or 4	1, 2, 3 or 4	1, 2, 3 or 4
Rated operational current (I _e) (U _e ≤ 440 V)	In AC-3, θ ≤ 55 °C	A	750	1000	1500	1800
	In AC-1, θ ≤ 40 °C	A	800	1250	2000	2750
Rated operational voltage (U _e)	Up to	V	1000			
Frequency limits (sine wave)	Without derating	Hz	50/60			
	Derating coefficient		100 Hz: 0.9 - 150 Hz: 0.8 - 250 Hz: 0.7 - 400 Hz: 0.5			
Maximum thermal current (I _{th})	θ ≤ 40 °C	A	800	1250	2000	2750
Rated making capacity	I rms conforming to IEC 60158-1 and 60947-4	A	10 000	10 000	15 000	18 000
Rated breaking capacity	I rms up to 440 V conforming to IEC 60158-1 and 60947-4	A	10 000	10 000	15 000	18 000
	500 V	A	9000	9000	12 000	15 000
	660-690 V	A	8000	8000	9000	11 000
	1000 V	A	4000	4000	5000	6000
Permissible short time rating From cold state, with no current flowing for previous 60 minutes at θ ≤ 40 °C	For 1 s	A	9600	9600	12 000	15 000
	For 5 s	A	9600	9600	12 000	15 000
	For 10 s	A	7000	8000	9600	12 000
	For 30 s	A	4800	5200	6400	8000
	For 1 min.	A	3500	3800	5200	6300
	For 3 min.	A	2100	2400	3600	4400
	For 10 min.	A	1200	1800	2800	3600
Short-circuit protection by fuses U ≤ 440 V	Motor circuit (type aM)	A	800	1200	2 x 800 (1)	2 x 1000 (1)
	With thermal overload relay (type gl)	A	1000	1500	2 x 1000 (1)	2 x 1200 (1)
	gl fuses	A	800	1200	2 x 1000 (1)	2 x 1200 (1)
Average impedance per pole	At I _{th} and 50 Hz	mΩ	0.18	0.18	0.13	0.09
Power dissipated per pole	AC-3	W	88	180	290	360
	AC-1	W	115	280	520	680
Connection	Number of bars		2	2	3	4
	Bar	mm	50 x 5	80 x 5	100 x 5	100 x 5
Bolt diameter		mm	4 x Ø 8	4 x Ø 10	4 x Ø 10	4 x Ø 10
Tightening torque	Power circuit connections	N.m	21	35	35	35

(1) Fuses must not be connected in parallel unless specified by the manufacturer.

Control circuit characteristics						
Contactor type			LC1 BL	LC1 BM	LC1 BP	LC1 BR
Rated control voltage	50/60 Hz	V	110...500	110...500	110...500	110...500
	⋮ 1,2 or 3-pole contactors	V	48...500	48...500	48...500	48...500
	⋮ 4-pole contactors	V	48...500	48...500	48...500	60...500
Voltage limits	Operation	V	0.85...1.1 Uc	0.85...1.1 Uc	0.85...1.1 Uc	0.85...1.1 Uc _w
	Drop-out	V	0.30...0.50 Uc	0.30...0.50 Uc	0.35...0.50 Uc	0.40...0.50 Uc
Maximum consumption (coil + economy resistor)	~	Number of poles: 1	VA	Inrush: 620 - sealed: 10		
		Number of poles: 2	VA	Inrush: 1000 - sealed: 20		
		Number of poles: 3	VA	Inrush: 1300 - sealed: 31		
		Number of poles: 4	VA	Inrush: 1600 - sealed: 47		
	⋮ (1)	Number of poles: 1	W	Inrush: 520 - sealed: 10		
		Number of poles: 2	W	Inrush: 800 - sealed: 20		
		Number of poles: 3	W	Inrush: 1100 - sealed: 31		
		Number of poles: 4	W	Inrush: 1400 - sealed: 47		
Operating time (2) average at Uc (in milliseconds)	"C"	ms	100...150	100...150	100...150	100...150
	"O" breaking on ~ side	ms	50...100	50...100	50...100	50...100
	"O" breaking on ⋮ side	ms	20...40	20...40	20...40	20...40
Mechanical durability (at Uc)	In millions of operating cycles		1.2	1.2	1.2	1.2
Maximum operating rate in mechanical operating cycles	Ambient temperature ≤ 55 °C	Op. cycs/h	120	120	120	120

Characteristics of instantaneous auxiliary contacts ZC4 GM●											
Rated thermal current	A	20									
Rated insulation voltage	Conforming to IEC 60947-1	V	660								
	Conforming to VDE, group C	V	750								
Short-circuit protection gl type cartridge fuses	Conforming to IEC 60947-1 and VDE 0660	A	20								
Operational power	1 million operating cycles	~ supply					⋮ supply				
		V	110/127	220	380	415/440	500	110	220	440	500
		VA/W	2000	4000	4000	4000	3500	250	250	230	200
Making and breaking capacity	VA/W	14 000	23 000	35 000	45 000	35 000	1600	800	400	360	
Cabling	With cable end	mm ²	1 or 2 x 4 mm ² conductors								
	Without cable end	mm ²	1 or 2 x 6 mm ² conductors								

(1) The inrush and sealed power values of d.c. electromagnets often require the use of an intermediate relay for control.
(2) The closing time "C" is measured from the moment the coil supply is switched on to initial contact of the main poles. The opening time "O" is measured from the moment the coil supply is switched off to the moment the main poles separate.

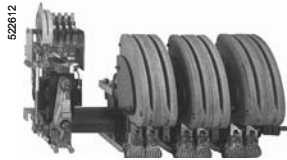

LC1 BP33

Contactors for motor control in category AC-3, from 750 to 1800 A (~ or ---)

3-pole contactors								Rated operational current in AC-3 440V up to	Instantaneous auxiliary contacts	Basic reference, to be completed by adding the voltage code (1)	Weight
Standard power ratings of 3-phase motors 50-60 Hz in category AC-3											
220 V	380 V	415 V	440 V	500 V	660 V	690 V	1000 V	A			kg
kW	kW	kW	kW	kW	kW	kW	kW				
220	400	425	450	500	560	530	750	2	2	LC1 BL33●22	58.000
								3	1	LC1 BL33●31	58.000
								1	3	LC1 BL33●13	58.000
								4	-	LC1 BL33●40	58.000
280	500	530	560	600	670	530	1000	2	2	LC1 BM33●22	57.000
								3	1	LC1 BM33●31	57.000
								1	3	LC1 BM33●13	57.000
								4	-	LC1 BM33●40	57.000
425	750	800	800	700	750	670	1500	2	2	LC1 BP33●22	94.000
								3	1	LC1 BP33●31	94.000
								1	3	LC1 BP33●13	94.000
								4	-	LC1 BP33●40	94.000
500	900	900	900	900	900	750	1800	2	2	LC1 BR33●22	129.000
								3	1	LC1 BR33●31	129.000
								1	3	LC1 BR33●13	129.000
								4	-	LC1 BR33●40	129.000

Selection: pages 5/194 to 5/217

Contactors for control in category AC-1, from 800 to 2750 A (~ or ---)

Single, 2, 3 or 4-pole contactors						Instantaneous auxiliary contacts	Basic reference, to be completed by adding the voltage code (1)	Weight
Maximum operational current in AC-1 (θ ≤ 40 °C)	Number of poles							
A	d					kg		
800	1			2	2	LC1 BL31●22	32.000	
				3	1	LC1 BL31●31	32.000	
				1	3	LC1 BL31●13	32.000	
				4	-	LC1 BL31●40	32.000	
	2			2	2	LC1 BL32●22	45.000	
				3	1	LC1 BL32●31	45.000	
				1	3	LC1 BL32●13	45.000	
				4	-	LC1 BL32●40	45.000	
	3			2	2	LC1 BL33●22	58.000	
				3	1	LC1 BL33●31	58.000	
				1	3	LC1 BL33●13	58.000	
				4	-	LC1 BL33●40	58.000	
	4			2	2	LC1 BL34●22	72.000	
				3	1	LC1 BL34●31	72.000	
				1	3	LC1 BL34●13	72.000	
				4	-	LC1 BL34●40	72.000	



(1) Standard control circuit voltages (for other voltages, please consult your Regional Sales Office):

Volts	48	110	120	125	127	220	230	240	380	400	415	440	500
~ 50...400 Hz	-	F	K	-	G	M	P	U	Q	V	N	R	S
---	ED	FD	-	GD	-	MD	-	UD	-	-	-	RD	SD

For voltages other than those indicated above, replace the p in the reference with the operational voltage (3 figures) and the type of current (2 letters: AC for a.c. supply and DC for d.c. supply). Example: 82 V d.c., the reference becomes LC1 BP33082DC22. For coil characteristics, see pages 5/188 to 5/191.

Contactors for control in category AC-1, from 800 to 2750 A (\sim or $\overline{\sim}$) (continued)

Single, 2, 3 or 4-pole contactors

Maximum operational current in AC-1 ($\theta \leq 40^\circ\text{C}$)	Number of poles	Instantaneous auxiliary contacts		Basic reference, to be completed by adding the voltage code (1)	Weight	
						
A					kg	
1250	1	2	2	LC1 BM31●22	31.000	
		3	1	LC1 BM31●31	31.000	
		1	3	LC1 BM31●13	31.000	
		4	–	LC1 BM31●40	31.000	
	2	2	2	LC1 BM32●22	44.000	
		3	1	LC1 BM32●31	44.000	
		1	3	LC1 BM32●13	44.000	
		4	–	LC1 BM32●40	44.000	
	3	2	2	LC1 BM33●22	57.000	
		3	1	LC1 BM33●31	57.000	
		1	3	LC1 BM33●13	57.000	
		4	–	LC1 BM33●40	57.000	
	4	2	2	LC1 BM34●22	71.000	
		3	1	LC1 BM34●31	71.000	
		1	3	LC1 BM34●13	71.000	
		4	–	LC1 BM34●40	71.000	
	2000	1	2	2	LC1 BP31●22	41.000
			3	1	LC1 BP31●31	41.000
			1	3	LC1 BP31●13	41.000
			4	–	LC1 BP31●40	41.000
2		2	2	LC1 BP32●22	65.000	
		3	1	LC1 BP32●31	65.000	
		1	3	LC1 BP32●13	65.000	
		4	–	LC1 BP32●40	65.000	
3		2	2	LC1 BP33●22	94.000	
		3	1	LC1 BP33●31	94.000	
		1	3	LC1 BP33●13	94.000	
		4	–	LC1 BP33●40	94.000	
4		2	2	LC1 BP34●22	120.000	
		3	1	LC1 BP34●31	120.000	
		1	3	LC1 BP34●13	120.000	
		4	–	LC1 BP34●40	120.000	
2750		1	2	2	LC1 BR31●22	52.000
			3	1	LC1 BR31●31	52.000
			1	3	LC1 BR31●13	52.000
			4	–	LC1 BR31●40	52.000
	2	2	2	LC1 BR32●22	85.000	
		3	1	LC1 BR32●31	85.000	
		1	3	LC1 BR32●13	85.000	
		4	–	LC1 BR32●40	85.000	
	3	2	2	LC1 BR33●22	129.000	
		3	1	LC1 BR33●31	129.000	
		1	3	LC1 BR33●13	129.000	
		4	–	LC1 BR33●40	129.000	
	4	2	2	LC1 BR34●22	160.000	
		3	1	LC1 BR34●31	160.000	
		1	3	LC1 BR34●13	160.000	
		4	–	LC1 BR34●40	160.000	

(1) See previous page.

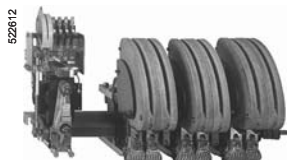

LC1 BP33

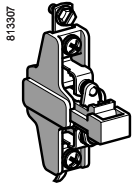

ZC4 GM1

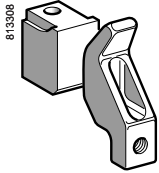

PA1 LB80
(PA1 LB76 + PA1 LB75)

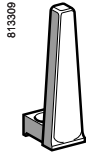

PA1 LB89

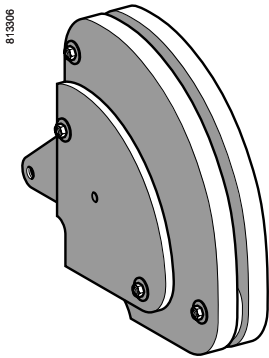

PA1 LB50

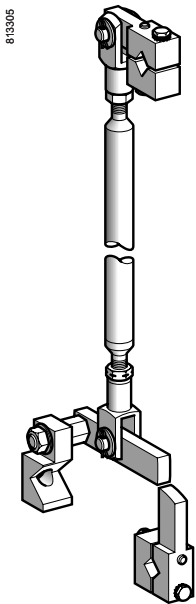

EZ2 LB0601

Spare parts

Description	For contactor	Composition	Reference	Weight kg
Instantaneous auxiliary contact blocks	LC1 B	1 N/O	ZC4 GM1	0.030
		1 N/C	ZC4 GM2	0.030

Description	For contactor	Number of sets required per contactor pole	Set reference	Weight kg
Set of contacts (1 moving contact, 1 fixed contact)	LC1 BL	1	PA1 LB80	0.420
		1	PA1 LB80	0.420
		2	PA1 LB80	0.420
		3	PA1 LB80	0.420

Description	For contactor	Reference	Weight kg
Moving contact only (for 1 finger)	LC1 B	PA1 LB75	0.220
Fixed contact only (for 1 finger)	LC1 B	PA1 LB76	0.200
Blow-out horn only (for 1 finger)	LC1 B	PA1 LB89	0.120
Arc chamber (for 1 contactor pole)	LC1 BL	PA1 LB50	3.700
		PA1 LB50	3.700
	LC1 BP	PA1 PB50	6.200
		PA1 RB50	8.500

Mounting accessories

Description	For contactor	Sold in lots of	Unit reference	Weight kg
Bar support bracket for mounting on 120 or 150 mm centres	LC1 BL to BR	2	LA9 B103	1.620

Assembly of two vertically mounted contactors by the customer

Description	For contactor	Reference	Weight kg
Mechanical interlock and locking device components	LC1 B	EZ2 LB0601	1.280

Specifications

- Positive mechanical interlock between two vertically mounted contactors of the same or different ratings.
- Connecting rod with cranks mounted on the right-hand, pole side.
- Vertical fixing centres of the two contactors: 600 mm.

Description	Specification	Height mm	Sold in lots of	Unit reference	Weight kg
Notched mounting rails used as uprights and as equipment support	2 mm steel, with zinc chromate treatment	1650	4	AM1 EC165	2.460
		1850	4	AM1 EC185	2.760
		2000	4	AM1 EC200	2.980
1/4 turn sliding clip nut and corresponding screw for assembly of rails AM1 EC	M8	-	10	AF1 CD081	0.020
	M8 x 18	-	10	AF1 VC820	0.024

Electromagnet

Electromagnet EB5 KB50

Adjustment of pick-up travel and pull-in travel

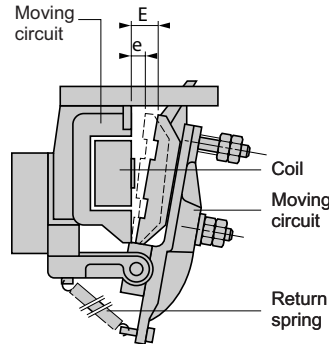
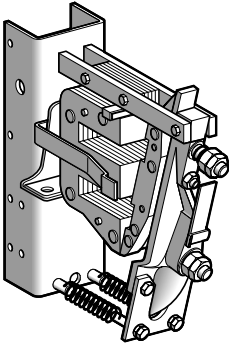

Poles

Complete pole

N/O pole

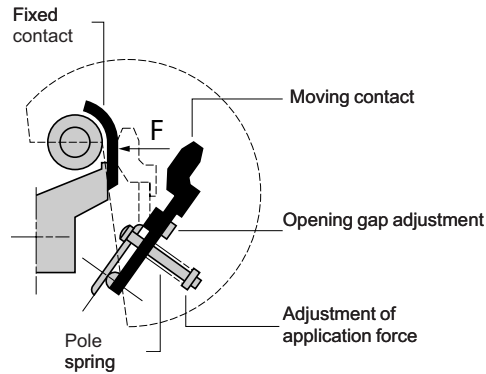
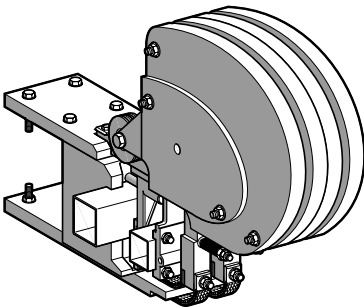

5

☐ or ~ supply adjustment characteristics with economy resistor (and rectifier on ~)

Contactor type			LC1 BL	LC1 BM	LC1 BP	LC1 BR
Electromagnet	Pick-up travel (E)	mm	30	30	30	30
	Pull-in travel (e)	mm	10	10	10	10
Coil	Pull-in voltage	V	0.75 U _c	0.75 U _c	0.75 U _c	0.75 U _c
	Drop-out voltage	V	0.3...0.5 U _c	0.3...0.5 U _c	0.3...0.5 U _c	0.3...0.5 U _c
N/O pole Adjustment of application force (F) on the contact per pole according to contactor composition	1-pole	daN	30	30	30 (1)	30 (2)
	2-pole	daN	30	30	30 (1)	30 (2)
	3-pole	daN	30	30	30 (1)	30 (2)
	4-pole	daN	30	30	30 (1)	30 (2)

(1) Each pole has 2 contacts; the force must be applied evenly to each of these contacts.
(2) Each pole has 3 contacts; the force must be applied evenly to each of these contacts.

TeSys contactors

TeSys LC1 B contactors

Replacement coils and accessories for single-pole contactors

References

The same coils are used for --- or \sim contactor control supply.

- For d.c. operation, the following must be associated with the coil:
 - 1 economy resistor arrangement (resistors + 1 or 2 auxiliary contact(s) or 1 contactor).
- For 50 to 400 Hz a.c. operation, the following must be associated with the coil:
 - 1 individual rectifier (to be wired),
 - 1 economy resistor arrangement (resistors + auxiliary contact(s) or 1 contactor) wired into the rectified current side.

Operating range min-max (1)		Coil		Economy resistor			Rectifier (for \sim only)		Coil	Weight
d.c.	a.c.	Resis- tance at 20 °C $\pm 10\%$	I inrush $\pm 10\%$ at U_n max	Resistor Unit reference	Total resis- tance Ω	Contact Qty Reference	Reference	Reference		
V	V	Ω	A		Ω				kg	
47-51	–	5.1	10.3	DR2 SC0270	270	1	ZC4 GM2	–	WB1 KB155	1.120
52-56	–	5.9	9.5	DR2 SC0330	330	1	ZC4 GM2	–	WB1 KB132	1.120
57-64	–	7.3	8.9	DR2 SC0390	390	1	ZC4 GM2	–	WB1 KB123	1.120
65-68	–	9.5	7.1	DR2 SC0560	560	1	ZC4 GM2	–	WB1 KB133	1.120
69-79	–	11.6	6.9	DR2 SC0680	680	1	ZC4 GM2	–	WB1 KB121	1.120
80-87	–	16.2	5.3	DR2 SC0820	820	1	ZC4 GM2	–	WB1 KB130	1.120
88-94	–	19.9	4.7	DR2 SC1000	1000	1	ZC4 GM2	–	WB1 KB140	1.120
95-108	110-125	25.5	4.3	DR2 SC1200	1200	1	ZC4 GM2	DR5 TE1U	WB1 KB134	1.120
109-136	126-155	33.1	4.2	DR2 SC1800	1800	1	ZC4 GM2	DR5 TE1U	WB1 KB124	1.120
137-151	156-173	50.9	3	DR2 SC2700	2700	2	ZC4 GM2	DR5 TE1U	WB1 KB122	1.120
152-166	174-191	61.36	2.7	DR2 SC3300	3300	2	ZC4 GM2	DR5 TE1U	WB1 KB135	1.120
167-189	192-216	78.4	2.4	DR2 SC3900	3900	2	ZC4 GM2	DR5 TE1U	WB1 KB136	1.120
190-221	217-256	94.8	2.3	DR2 SC4700	4700	2	ZC4 GM2	DR5 TE1U	WB1 KB139	1.120
222-243	257-280	123.9	1.9	DR2 SC6800	6800	1	LC1 DT20 LDS135	DR5 TE1U	WB1 KB125	1.120
244-267	281-307	159.9	1.7	DR2 SC8200	4700 + 3300	1	LC1 DT20 LDS135	DR5 TE1S	WB1 KB137	1.120
268-318	308-365	199.6	1.6	DR2 SC1001	5600 + 4700	1	LC1 DT20 UDS135	DR5 TE1S	WB1 KB126	1.120
319-405	366-463	247.4	1.6	DR2 SC1201	6800 + 5600	1	LC1 DT20 TDS135	DR5 TE1S	WB1 KB138	1.120
406-446	464-500	382	1.1 (2)	DR2 SC1001	20 000	1	LC1 DT20 VDS135	DR5 TE1S	WB1 KB127	1.120
447-500	–	506.7	1 (3)	DR2 SC1201	24 000	1	LC1 DT20 RDS135	–	WB1 KB128	1.120

Specifications

- Average coil consumption (low sealed consumption):
 - d.c.: inrush 380...520 W, sealed 0.15...0.20 W
 - a.c. (with rectifier): inrush 450...620 VA, sealed 0.15...0.20 VA
- Time constant when sealed 25 ms
- Economy resistor consumption: 7...10 W
- Operating cycles/hour at $\theta \leq 55$ °C: ≤ 120
- Mechanical durability at U_c : 1.2 million operating cycles
- With a.c. operation: good resistance to voltage drop on inrush, non susceptibility to micro-breaks, mains harmonics: level ≤ 7 .

(1) For supply voltages of less than 110 V, beware of voltage drops caused by the inrush current.

(2) 2 resistors in series: $2 \times 10\,000\ \Omega$.

(3) 2 resistors in series: $2 \times 12\,000\ \Omega$.

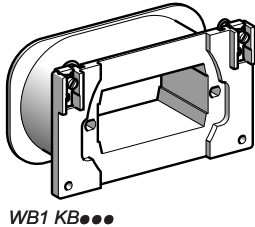

TeSys contactors

TeSys LC1 B contactors

Replacement coils and accessories for 2-pole contactors

References

The same coils are used for $\overline{\text{---}}$ or \sim contactor control supply.

- For d.c. operation, the following must be associated with the coil:
 - 1 economy resistor arrangement (resistors + 1 or 2 auxiliary contact(s) or 1 contactor).
- For 50 to 400 Hz a.c. operation, the following must be associated with the coil:
 - 1 individual rectifier (to be wired),
 - 1 economy resistor arrangement (resistors + auxiliary contact(s) or 1 contactor) wired into the rectified current side.

Operating range min-max (1)		Coil		Economy resistor			Rectifier (for \sim only)		Coil	Weight
d.c.	a.c.	Resistance at 20 °C $\pm 10\%$	I inrush $\pm 10\%$ at U_n max	Resistors (2 in series)		Contact	Reference	Reference		
V	V	Ω	A	Unit reference	Total resistance Ω	Qty Reference			kg	
48-51	-	3.22	15.8	DR2 SC0068	2x68	1 ZC4 GM2	-	WB1 KB141	1.120	
52-56	-	4.04	13.8	DR2 SC0082 DR2 SC0100	82 + 100	1 ZC4 GM2	-	WB1 KB142	1.120	
57-62	-	4.96	12.5	DR2 SC0100 DR2 SC0120	100 + 120	1 ZC4 GM2	-	WB1 KB155	1.120	
63-68	-	5.86	11.6	DR2 SC0120	2x120	1 ZC4 GM2	-	WB1 KB132	1.120	
69-79	-	7.2	11	DR2 SC0150	2 x 150	1 ZC4 GM2	-	WB1 KB123	1.120	
80-85	-	9.6	8.8	DR2 SC0180 DR2 SC0220	180 + 220	1 ZC4 GM2	-	WB1 KB133	1.120	
86-98	99-113	11.4	8.6	DR2 SC0220 DR2 SC0270	220 + 270	1 ZC4 GM2	-	WB1 KB121	1.120	
99-108	114-125	16.3	6.6	DR2 SC0330	2x330	1 ZC4 GM2	DR5 TE1U	WB1 KB130	1.120	
109-119	126-136	19.7	6	DR2 SC0390	2x390	1 ZC4 GM2	DR5 TE1U	WB1 KB140	1.120	
120-136	137-156	25.2	5.4	DR2 SC0470	2x470	2 ZC4 GM2	DR5 TE1U	WB1 KB134	1.120	
137-173	157-196	32.5	5.3	DR2 SC0680	2x680	2 ZC4 GM2	DR5 TE1U	WB1 KB124	1.120	
174-191	197-216	49.7	3.8	DR2 SC1000	2x1000	2 ZC4 GM2	DR5 TE1U	WB1 KB122	1.120	
192-210	217-238	61	3.4	DR2 SC1200	2x1200	2 ZC4 GM2	DR5 TE1U	WB1 KB135	1.120	
211-238	239-272	77.2	3	DR2 SC1500 DR2 SC1800	1500 + 1800	2 ZC4 GM2	DR5 TE1U	WB1 KB136	1.120	
239-279	273-318	94	3	DR2 SC1800 DR2 SC2200	1800 + 2200	1 LP1 DT20 LDS135	DR5 TE1S	WB1 KB139	1.120	
280-310	319-359	128	2.4	DR2 SC2700	2x2700	1 LP1 DT20 UDS135	DR5 TE1S	WB1 KB125	1.120	
311-341	360-387	160	2.1	DR2 SC3300	2x3300	1 LP1 DT20 TDS135	DR5 TE1S	WB1 KB137	1.120	
342-399	388-452	197	2	DR2 SC3900	2x3900	1 LP1 DT20 TDS135	DR5 TE1S	WB1 KB126	1.120	
400-500	453-500	257	1.9	DR2 SC4700 DR2 SC5600	4700 + 5600	1 LP1 DT20 VDS135	DR5 TE1S	WB1 KB138	1.120	

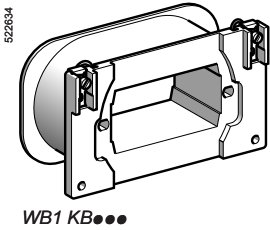

Specifications

- Average coil consumption (low sealed consumption):
 - d.c.: inrush 600...800 W, sealed 0.35...0.5 W
 - a.c. (with rectifier): inrush 720...1000 VA, sealed 0.35...0.5 W
- Time constant when sealed 25 ms
- Economy resistor consumption: 15...20 W
- Operating cycles/hour at $\theta \leq 55\text{ °C}$: ≤ 120
- Mechanical durability at U_c : 1.2 million operating cycles
- With a.c. operation: good resistance to voltage drop on inrush, non susceptibility to micro-breaks, mains harmonics: level ≤ 7 .

(1) For supply voltages of less than 110 V, beware of voltage drops caused by the inrush current.



TeSys contactors

TeSys LC1 B contactors

Replacement coils and accessories for 3-pole contactors

References

The same coils are used for --- or \sim contactor control supply.

- For d.c. operation, the following must be associated with the coil:
 - 1 economy resistor arrangement (resistors + 1 or 2 auxiliary contact(s) or 1 contactor).
- For 50 to 400 Hz a.c. operation, the following must be associated with the coil:
 - 1 individual rectifier (to be wired),
 - 1 economy resistor arrangement (resistors + auxiliary contact(s) or 1 contactor) wired into the rectified current side.

Operating range min-max (1)		Coil		Economy resistor			Rectifier (for \sim only)	Coil	Weight	
d.c.	a.c.	Resistance at 20 °C $\pm 10\%$	I inrush $\pm 10\%$ at U_n max	Resistors (2 in parallel or in series)		Contact		Reference	Reference	
V	V	Ω	A	Unit reference	Total resistance Ω	Qty	Reference		kg	
47-50	–	1.85	27	DR2 SC0150	2x150//	1	ZC4 GM2	–	WB1 KB154	1.120
51-55	–	2.35	23.5	DR2 SC0180	2x180//	1	ZC4 GM2	–	WB1 KB153	1.120
56-60	–	3.22	18.5	DR2 SC0220	2x220//	1	ZC4 GM2	–	WB1 KB141	1.120
61-66	–	4.04	16	DR2 SC0270	2X270//	1	ZC4 GM2	–	WB1 KB142	1.120
67-72	–	4.96	14.5	DR2 SC0330	2x330//	1	ZC4 GM2	–	WB1 KB155	1.120
73-79	–	5.86	13.5	DR2 SC0100	2x100	1	ZC4 GM2	–	WB1 KB132	1.120
80-92	–	7.2	12.8	DR2 SC0120	2x120	1	ZC4 GM2	–	WB1 KB123	1.120
93-98	108-113	9.6	10.2	DR2 SC0150	150	1	ZC4 GM2	DR5 TE1U	WB1 KB133	1.120
				DR2 SC0180	+ 180					
99-114	114-132	11.4	10	DR2 SC0180	180	1	ZC4 GM2	DR5 TE1U	WB1 KB121	1.120
				DR2 SC0220	+ 220					
115-126	133-145	16.3	7.7	DR2 SC0270	2x270	2	ZC4 GM2	DR5 TE1U	WB1 KB130	1.120
127-139	146-160	11.7	7	DR2 SC0330	2x330	2	ZC4 GM2	DR5 TE1U	WB1 KB140	1.120
140-159	161-181	25.2	6.3	DR2 SC0390	390	2	ZC4 GM2	DR5 TE1U	WB1 KB134	1.120
				DR2 SC0470	+ 470					
160-201	182-228	32.2	6.2	DR2 SC0560	2x560	2	ZC4 GM2	DR5 TE1U	WB1 KB124	1.120
202-222	229-255	49.7	4.5	DR2 SC0820	2x820	2	ZC4 GM2	DR5 TE1U	WB1 KB122	1.120
223-246	256-282	61	4	DR2 SC1000	2x1000	1	LC1 DT20 LDS135	DR5 TE1S	WB1 KB135	1.120
247-277	283-316	77.2	3.6	DR2 SC1200	2x1200	1	LC1 DT20 LDS135	DR5 TE1S	WB1 KB136	1.120
278-327	317-372	94	3.5	DR2 SC1500	2x1500	1	LC1 DT20 UDS135	DR5 TE1S	WB1 KB139	1.120
328-360	373-408	128	2.8	DR2 SC1500	3x1500	1	LC1 DT20 TDS135	DR5 TE1S	WB1 KB125	1.120
361-399	409-452	160	2.5	DR2 SC1800	3x1800	1	LC1 DT20 VDS135	DR5 TE1S	WB1 KB137	1.120
400-469	453-500	197	2.4	DR2 SC2200	3x2200	1	LC1 DT20 VDS135	DR5 TE1S	WB1 KB126	1.120
470-500	–	257	1.9	DR2 SC2700	3x2700	1	LC1 DT20 RDS135	–	WB1 KB138	1.120

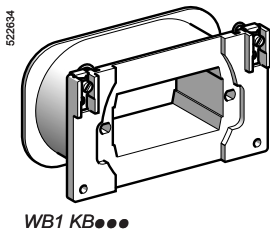

Specifications

- Average coil consumption (low sealed consumption):
 - d.c.: inrush 900...1100 W, sealed 0.7...1 W
 - a.c. (with rectifier): inrush 1100...1300 VA, sealed 0.7...1 VA
- Time constant when sealed 25 ms
- Economy resistor consumption: 24...30 W
- Operating cycles/hour at $\theta \leq 55\text{ °C}$: ≤ 120
- Mechanical durability at U_c : 1.2 million operating cycles
- With a.c. operation: good resistance to voltage drop on inrush, non susceptibility to micro-breaks, mains harmonics: level ≤ 7 .

(1) For supply voltages of less than 110 V, beware of voltage drops caused by the inrush current.

TeSys contactors

TeSys LC1 B contactors

Replacement coils and accessories for 4-pole contactors

References

The same coils are used for $\overline{\text{---}}$ or \sim contactor control supply.

- For d.c. operation, the following must be associated with the coil:
 - 1 economy resistor arrangement (resistors + 1 or 2 auxiliary contact(s) or 1 contactor).
- For 50 to 400 Hz a.c. operation, the following must be associated with the coil:
 - 1 individual rectifier (to be wired),
 - 1 economy resistor arrangement (resistors + auxiliary contact(s) or 1 contactor) wired into the rectified current side.

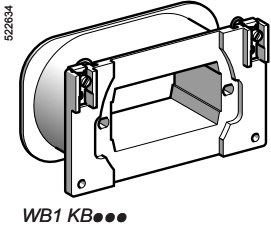

Operating range min-max (1)		Coil		Economy resistor			Rectifier (for \sim only)	Coil	Weight
d.c.	a.c.	Resistance at 20 °C $\pm 10\%$	I inrush $\pm 10\%$ at U_n max	Resistors (3 in series) Reference unit	Total resistance Ω	Contact Qty Reference	Reference	Reference	kg
V	V	Ω	A						
57-61	–	2.35	26	DR2 SC0027	3x27	1 ZC4 GM2	–	WB1 KB153	1.120
62-67	–	3.22	21	DR2 SC0033	3x33	1 ZC4 GM2	–	WB1 KB141	1.120
68-73	–	4.04	18	DR2 SC0039	3x39	1 ZC4 GM2	–	WB1 KB142	1.120
74-81	–	4.96	16.3	DR2 SC0047	3x47	1 ZC4 GM2	–	WB1 KB155	1.120
82-89	–	5.86	15	DR2 SC0056	3x56	1 ZC4 GM2	–	WB1 KB132	1.120
90-102	105-119	7.2	14	DR2 SC0068	3x68	1 ZC4 GM2	DR5 TE1U	WB1 KB123	1.120
103-111	120-128	9.6	11.5	DR2 SC0100	3x100	2 ZC4 GM2	DR5 TE1U	WB1 KB133	1.120
112-129	129-148	11.4	11.3	DR2 SC0100	3x100	2 ZC4 GM2	DR5 TE1U	WB1 KB121	1.120
130-143	149-163	16.3	8.7	DR2 SC0150	3x150	2 ZC4 GM2	DR5 TE1U	WB1 KB130	1.120
144-157	164-179	19.7	8	DR2 SC0180	3x180	2 ZC4 GM2	DR5 TE1U	WB1 KB140	1.120
158-180	180-204	25.2	7.1	DR2 SC0220	3x220	2 ZC4 GM2	DR5 TE1U	WB1 KB134	1.120
181-226	205-259	32.5	6.9	DR2 SC0330	3x330	2 ZC4 GM2	DR5 TE1U	WB1 KB124	1.120
227-251	260-288	49.7	5	DR2 SC0470	3x470	1 LC1 DT20 LDS135	DR5 TE1S	WB1 KB122	1.120
252-278	289-317	61	4.5	DR2 SC0560	3x560	1 LC1 DT20 UDS135	DR5 TE1S	WB1 KB135	1.120
279-313	318-356	77.2	4	DR2 SC0680	3x680	1 LC1 DT20 UDS135	DR5 TE1S	WB1 KB136	1.120
314-368	357-418	94	3.9	DR2 SC0820	3x820	1 LC1 DT20 TDS135	DR5 TE1S	WB1 KB139	1.120
369-408	419-462	128	3.2	DR2 SC1200	3x1200	1 LC1 DT20 VDS135	DR5 TE1S	WB1 KB125	1.120
409-448	463-500	160	2.8	DR2 SC1500	3x1500	1 LC1 DT20 VDS135	DR5 TE1S	WB1 KB137	1.120
449-500	–	197	2.5	DR2 SC1800	3x1800	1 LC1 DT20 RDS135	–	WB1 KB126	1.120

Specifications

- Average coil consumption (low sealed consumption):
 - d.c.: inrush 1100...1400 W, sealed 1.2...1.6 W
 - a.c. (with rectifier): inrush 1300...1600 VA, sealed 1.2...1.6 VA
- Time constant when sealed 25 ms
- Economy resistor consumption: 35...45 W
- Operating cycles/hour at $\theta \leq 55\text{ °C}$: ≤ 120
- Mechanical durability at U_c : 1.2 million operating cycles
- With a.c. operation: good resistance to voltage drop on inrush, non susceptibility to micro-breaks, mains harmonics: level ≤ 7 .

(1) For supply voltages of less than 110 V, beware of voltage drops caused by the inrush current.

Single, 2, 3 or 4-pole contactors LC1 B
Common side view

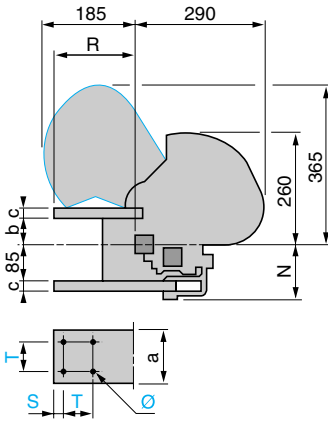

Single, 2 or 3-pole contactors LC1 B●31, B●32 or B●33

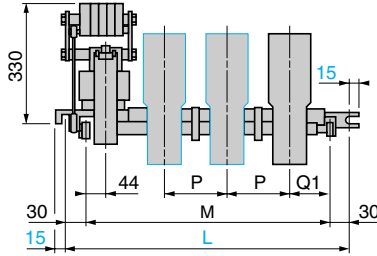

4-pole contactors LC1 B●34

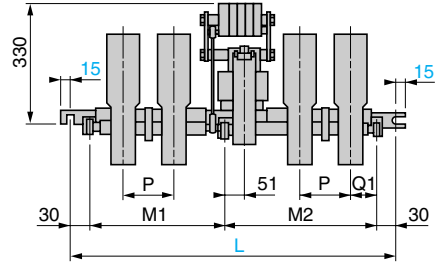

Number of poles	LC1 BL				LC1 BM				LC1 BP				LC1 BR			
	1	2	3	4	1	2	3	4	1	2	3	4	1	2	3	4
a	50	50	50	50	63	63	63	63	100	100	100	100	125	125	125	125
b	59	59	59	59	55	55	55	55	55	55	55	55	50	50	50	50
c	16	16	16	16	20	20	20	20	20	20	20	20	25	25	25	25
L	345	445	540	760	345	445	540	760	385	540	760	1065	445	635	885	1065
M	285	385	480	—	285	385	480	—	325	480	700	—	385	575	825	—
M1	—	—	—	308	—	—	—	308	—	—	—	455	—	—	—	455
M2	—	—	—	392	—	—	—	392	—	—	—	550	—	—	—	550
N	121	121	121	121	125	125	125	125	125	125	125	125	130	130	130	130
P	100	100	100	100	100	100	100	100	150	150	150	150	195	195	195	195
Q1	100	100	100	100	100	100	100	100	110	110	110	110	130	130	130	130
R	122	122	122	122	157	157	157	157	173	173	173	173	173	173	173	173
S	10	10	10	10	17	17	17	17	20	20	20	20	20	20	20	20
T	30	30	30	30	30	30	30	30	60	60	60	60	60	60	60	60
Ø	9	9	9	9	11	11	11	11	11	11	11	11	11	11	11	11

Electrical safety clearance

Values X1 and X2 are given for a breaking capacity of 10 In (~ 3-phase supply).

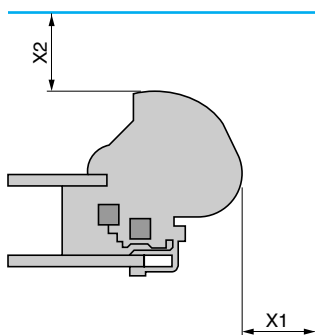

~ 3-phase voltage		LC1 BL	LC1 BM	LC1 BP	LC1 BR
		380/440 V	X1: 100 X2: 150	100 150	150 200
500 V	X1: 100 X2: 150	100 150	150 220	200 250	
660/690 V	X1: 150 X2: 200	150 200	200 250	200 250	
1000 V	X1: 200 X2: 250	200 250	200 250	250 300	

Mechanical interlock for assembling vertically mounted reversing contactors

EZ2 LB0601

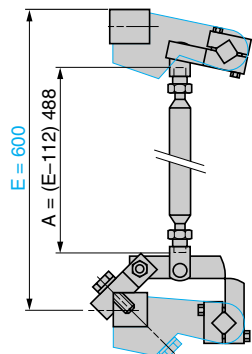

TeSys LC1 B contactors

LC1 B•31•22

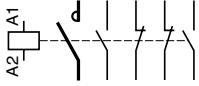

LC1 B•31•31

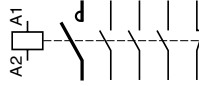

LC1 B•31•13

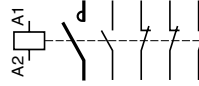

LC1 B•31•40

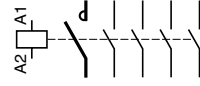

LC1 B•32•22

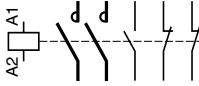

LC1 B•32•31

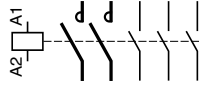

LC1 B•32•13

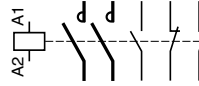

LC1 B•32•40

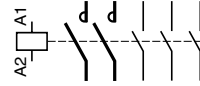

LC1 B•33•22

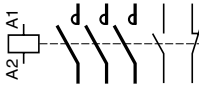

LC1 B•33•31

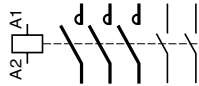

LC1 B•33•13

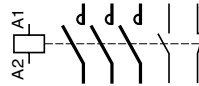

LC1 B•33•40

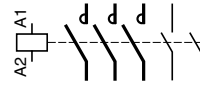

LC1 B•34•22

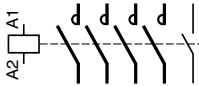

LC1 B•34•31

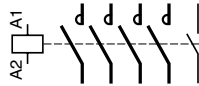

LC1 B•34•13

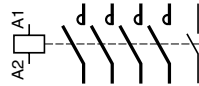

LC1 B•34•40

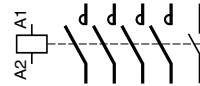

a.c. control circuit

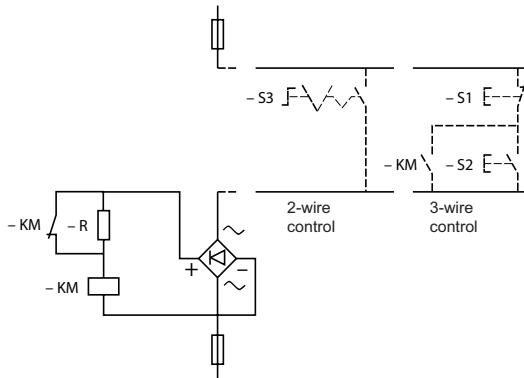

Dotted lines show optional wiring and external items required.

d.c. control circuit

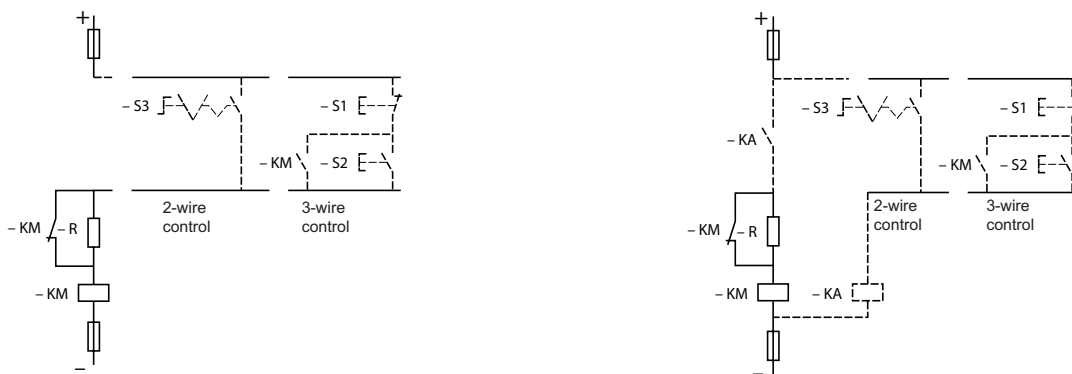

Nota : It is essential to check that the control circuit contacts have ratings compatible with the voltage and power consumption of the operating coil of the contactor. If not, an intermediate "KA" relay must be fitted and wired as shown.

Dotted lines show optional wiring and external items required.

Operational current and power conforming to IEC ($\theta \leq 60^\circ\text{C}$)

Contactor size			LC1/ LP1 K06	LC1/ LP1 K09	LC1 K12	LC1 K16	LC1 D09	LC1 D12	LC1 D18	LC1 D25	LC1 D32	LC1 D38	LC1 D40A
Maximum operational current in AC-3	$\leq 440\text{ V}$	A	6	9	12	16	9	12	18	25	32	38	40
Rated operational power P (standard motor power ratings)	220/240 V	kW	1.5	2.2	3	3	2.2	3	4	5.5	7.5	9	11
	380/400 V	kW	2.2	4	5.5	7.5	4	5.5	7.5	11	15	18.5	18.5
	415 V	kW	2.2	4	5.5	7.5	4	5.5	9	11	15	18.5	22
	440 V	kW	3	4	5.5	7.5	4	5.5	9	11	15	18.5	22
	500 V	kW	3	4	4	5.5	5.5	7.5	10	15	18.5	18.5	22
	660/690 V	kW	3	4	4	4	5.5	7.5	10	15	18.5	18.5	30
1000 V	kW	–	–	–	–	–	–	–	–	–	–	–	

Maximum operating rate in operating cycles/hour (1)

On-load factor	Operational power	LC1 D09	LC1 D12	LC1 D18	LC1 D25	LC1 D32	LC1 D38	LC1 D40A				
$\leq 85\%$	P	–	–	–	–	1200	1200	1200	1200	1000	1000	1000
	0.5 P	–	–	–	–	3000	3000	2500	2500	2500	2500	2500
$\leq 25\%$	P	–	–	–	–	1800	1800	1800	1800	1200	1200	1200

Operational current and power conforming to UL, CSA ($\theta \leq 60^\circ\text{C}$)

Contactor size			LC1/ LP1 K06	LC1/ LP1 K09	LC1/ LP1 K12	LC1 D09	LC1 D12	LC1 D18	LC1 D25	LC1 D32	LC1 D38	LC1 D40A
Maximum operational current in AC-3	$\leq 440\text{ V}$	A	6	9	12	9	12	18	25	32	–	40
Rated operational power P (standard motor power ratings 60 Hz)	200/208 V	HP	1.5	2	3	2	3	5	7.5	10	–	10
	230/240 V	HP	1.5	3	3	2	3	5	7.5	10	–	10
	460/480 V	HP	3	5	7.5	5	7.5	10	15	20	–	30
	575/600 V	HP	3	5	10	7.5	10	15	20	25	–	30

(1) Depending on the operational power and the on-load factor ($\theta \leq 60^\circ\text{C}$).

LC1 D50A	LC1 D65A	LC1 D80	LC1 D95	LC1 D115	LC1 D150	LC1 F185	LC1 F225	LC1 F265	LC1 F330	LC1 F400	LC1 F500	LC1 F630	LC1 F780	LC1 F800	LC1 BL	LC1 BM	LC1 BP	LC1 BR
50	65	80	95	115	150	185	225	265	330	400	500	630	780	800	750	1000	1500	1800
15	18,5	22	25	30	40	55	63	75	100	110	147	200	220	250	220	280	425	500
22	30	37	45	55	75	90	110	132	160	200	250	335	400	450	400	500	750	900
25	37	45	45	59	80	100	110	140	180	220	280	375	425	450	425	530	800	900
30	37	45	45	59	80	100	110	140	200	250	295	400	425	450	450	560	800	900
30	37	55	55	75	90	110	129	160	200	257	355	400	450	450	500	600	750	900
33	37	45	45	80	100	110	129	160	220	280	335	450	475	475	560	670	750	900
-	-	45	45	65	75	100	100	147	160	185	335	450	450	450	530	530	670	750

LC1 D50A	LC1 D65A	LC1 D80	LC1 D95	LC1 D115	LC1 D150	LC1 F185	LC1 F225	LC1 F265	LC1 F330	LC1 F400	LC1 F500	LC1 F630	LC1 F780	LC1 F800	LC1 BL	LC1 BM	LC1 BP	LC1 BR
1000	1000	750	750	750	750	750	750	750	750	500	500	500	500	500	120	120	120	120
2500	2500	2000	2000	2000	1200	2000	2000	2000	2000	1200	1200	1200	1200	600	120	120	120	120
1200	1200	1200	1200	1200	1200	1200	1200	1200	1200	1200	1200	1200	600	600	120	120	120	120

LC1 D50A	LC1 D65A	LC1 D80	LC1 D95	LC1 D115	LC1 D150	LC1 F185	LC1 F225	LC1 F265	LC1 F330	LC1 F400	LC1 F500	LC1 F630	LC1 F780	LC1 F800
50	65	80	95	115	150	185	225	265	330	400	500	630	780	800
15	20	30	30	30	40	50	60	60	75	100	150	250	-	350
15	20	30	30	40	50	60	75	75	100	125	200	300	450	400
40	40	60	60	75	100	125	150	150	200	250	400	600	900	900
40	50	60	60	100	125	150	150	200	250	300	500	800	-	900

Selection according to required electrical durability, in category AC-3 ($U_e \leq 440$ V)

Control of 3-phase asynchronous squirrel cage motors with breaking whilst running.
 The current broken (I_c) in category AC-3 is equal to the rated operational current (I_e) of the motor.

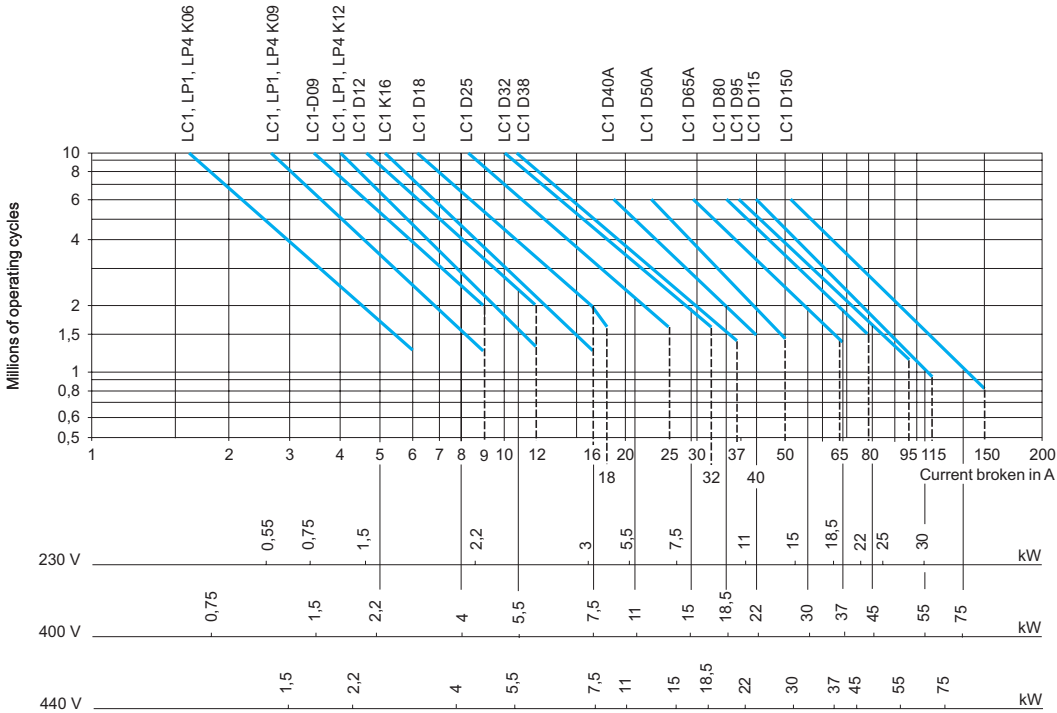

Operational power in kW-50 Hz.

Example:

Asynchronous motor with $P = 5.5$ kW - $U_e = 400$ V - $I_e = 11$ A - $I_c = I_e = 11$ A
 or asynchronous motor with $P = 5.5$ kW - $U_e = 415$ V - $I_e = 11$ A - $I_c = I_e = 11$ A
 3 million operating cycles required.

The above selection curves show the contactor rating needed: LC1 D18.

Selection according to required electrical durability, in category AC-3 ($U_e = 660/690$ V) (1)

Control of 3-phase asynchronous squirrel cage motors with breaking whilst running.
 The current broken (I_c) in category AC-3 is equal to the rated operational current (I_e) of the motor.

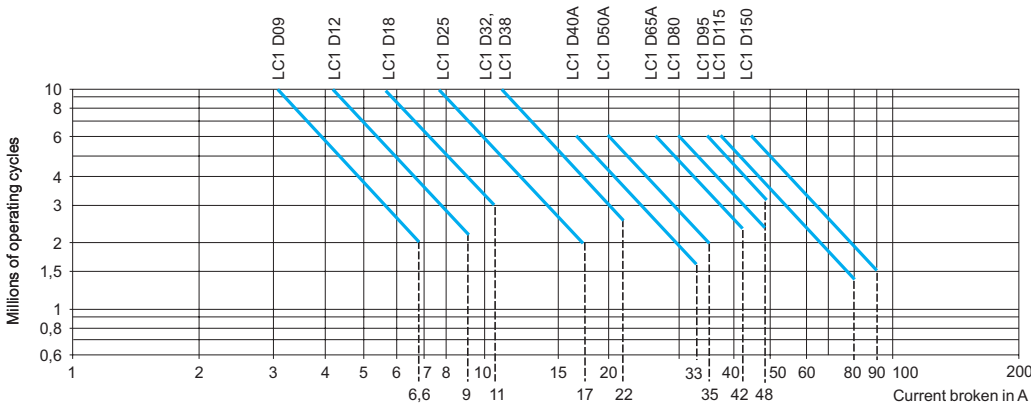

(1) For $U_e = 1000$ V, use the 660/690 V curves, but do not exceed the operational current at the operational power indicated for 1000 V.

Selection according to required electrical durability, in category AC-3 ($U_e \leq 440$ V)

Control of 3-phase asynchronous squirrel cage motors with breaking whilst running.
The current broken (I_c) in category AC-3 is equal to the rated operational current (I_e) of the motor.

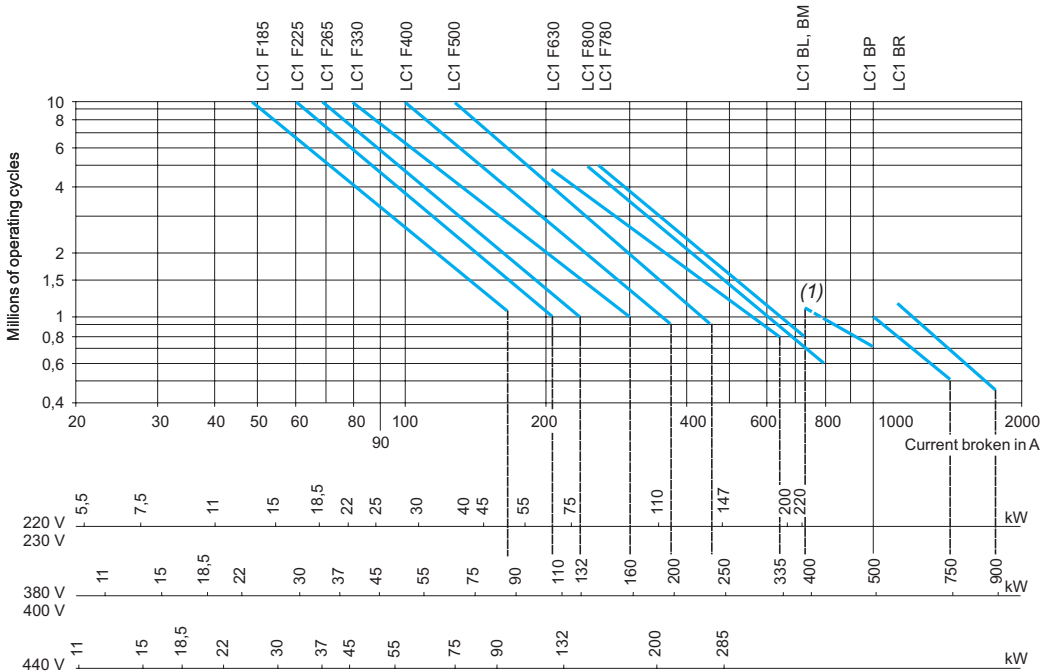

Operational power in kW-50 Hz.

Example:

Asynchronous motor with $P = 132$ kW - $U_e = 380$ V - $I_e = I_c = 245$ A
or asynchronous motor with $P = 132$ kW - $U_e = 415$ V - $I_e = I_c = 240$ A
1.5 million operating cycles required.

The above selection curves show the contactor rating needed: LC1 F330.

(1) The dotted lines are only applicable to LC1 BL contactors.

Selection according to required electrical durability, in category AC-3 ($U_e = 660/690$ V)

Control of 3-phase asynchronous squirrel cage motors with breaking whilst running.
The current broken (I_c) in category AC-3 is equal to the rated operational current (I_e) of the motor.

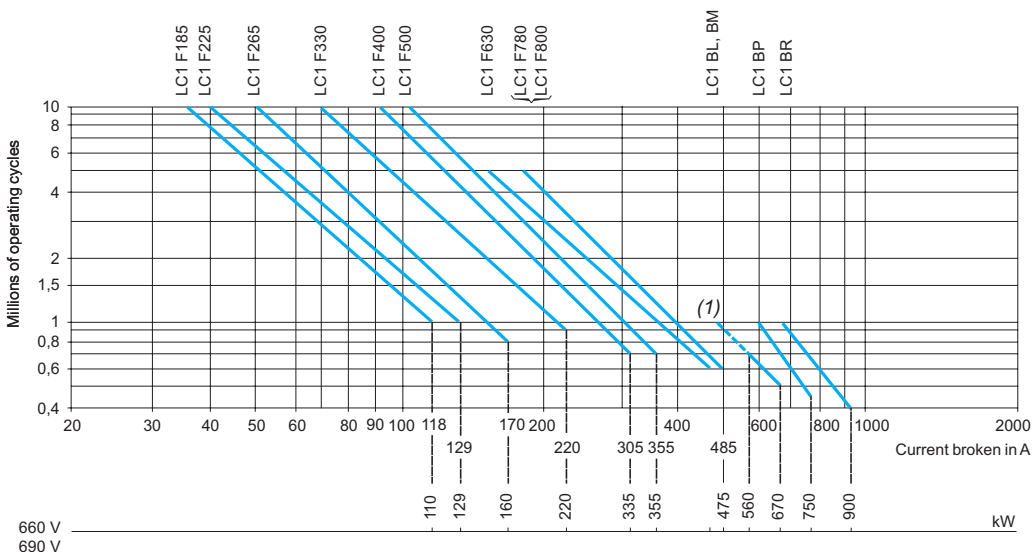

Example:

Asynchronous motor with $P = 132$ kW - $U_e = 660$ V - $I_e = I_c = 140$ A
1.5 million operating cycles required.

The above selection curves show the contactor rating needed: LC1 F330.

(1) The dotted lines are only applicable to LC1 BL contactors.



Maximum operational current (open-mounted device)

Contactor size		LC1/ LP1 K09	LC1/ LP1 K12	LC1 D09	LC1 DT20	LC1 D12 DT25	LC1 D18 DT32	LC1 D25 DT40	LC1 D32	LC1 D38	LC1 D40A DT60A	
Maximum operating rate in operating cycles/hour		600	600	600	600	600	600	600	600	600	600	
Connection conforming to IEC 60947-1	Cable c.s.a. mm²	4	4	4	4	4	6	6	10	10	35	
	Bar c.s.a. mm	-	-	-	-	-	-	-	-	-	-	
Operational current in AC-1 in A, according to the ambient temperature conforming to IEC 60947-1	≤ 40 °C	A	20	20	25	20	25	32	40	50	50	60
	≤ 60 °C	A	20	20	25	20	25	32	40	50	50	60
	≤ 70 °C	A (at UC)	(1)	(1)	17	(1)	17	22	28	35	35	42
Maximum operational power ≤ 60 °C	220/230 V	kW	8	8	9	8	9	11	14	18	18	21
	240 V	kW	8	8	9	8	9	12	15	19	19	23
	380/400 V	kW	14	14	15	14	15	20	25	31	31	37
	415 V	kW	14	14	17	14	17	21	27	34	34	41
	440 V	kW	15	15	18	15	18	23	29	36	36	43
	500 V	kW	17	17	20	17	20	23	33	41	41	49
	660/690 V	kW	22	22	27	22	27	34	43	54	54	65
	1000 V	kW	-	-	-	-	-	-	-	-	-	-

(1) Please consult your Regional Sales Office.

Increase in operational current by parallel connection of poles

Apply the following coefficients to the currents or power values given above; these coefficients take into account an often unbalanced current distribution between the poles:

- 2 poles in parallel: K = 1.6
- 3 poles in parallel: K = 2.25
- 4 poles in parallel: K = 2.8

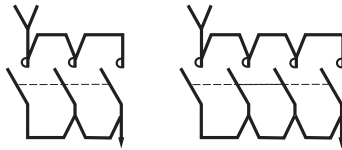

Selection according to required electrical durability, in category AC-1 (Ue ≤ 440 V)

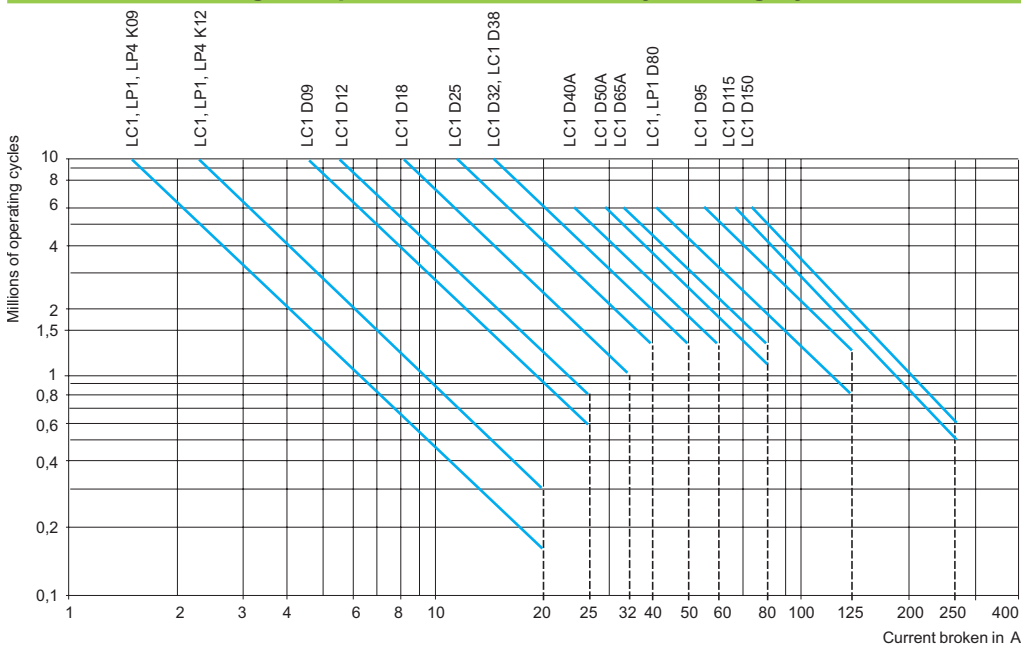

Control of resistive circuits ($\cos \varphi \geq 0.95$).

The current broken (I_c) in category AC-1 is equal to the current (I_e) normally drawn by the load.

Example:

- $U_e = 220\text{ V} - I_e = 50\text{ A } \theta \leq 40\text{ }^\circ\text{C} - I_c = I_e = 50\text{ A}$.
- 2 million operating cycles required.
- The above selection curves show the contactor rating needed: either LC1 or LP1 D50.

LC1 D50A	LC1 D65A DT80A D80	LC1/LP1 D80	LC1 D95	LC1 D115	LC1 D150	LC1 F185	LC1 F225	LC1 F265	LC1 F330	LC1 F400	LC1 F500	LC1 F630	LC1 F780	LC1 F800	LC1 F1700	LC1 F2100	LC1 BL	LC1 BM	LC1 BP	LC1 BR
600	600	600	600	600	600	600	600	600	600	600	600	600	600	600	200	200	120	120	120	120
35	35	50	50	120	120	150	185	185	240	-	-	-	-	-	-	-	-	-	-	-
-	-	-	-	-	-	-	-	-	-	2	2	2	2	2	3	4	2	2	2	2
										30 x 5	40 x 5	60 x 5	100 x 5	60 x 5	100 x 5	100 x 5	50 x 5	80 x 5	100 x 5	100 x 10
80	80	125	125	250	250	275	315	350	400	500	700	1000	1600	1000	1700	2100 (2)	800	1250	2000	2750
80	80	125	125	200	200	275	280	300	360	430	580	850	1350	850	1450	1750	700	1100	1750	2400
56	56	80	80	160	160	180	200	250	290	340	500	700	1100	700	-	-	600	900	1500	2000
29	29	45	45	80	80	90	100	120	145	170	240	350	550	350	570	700	300	425	700	1000
31	31	49	49	83	83	100	110	125	160	180	255	370	570	370	600	780	330	450	800	1100
50	50	78	78	135	135	165	175	210	250	300	430	600	950	600	1000	1200	500	800	1200	1600
54	54	85	85	140	140	170	185	220	260	310	445	630	1000	630	1050	1300	525	825	1250	1700
58	58	90	90	150	150	180	200	230	290	330	470	670	1050	670	1100	1350	550	850	1400	2000
65	65	102	102	170	170	200	220	270	320	380	660	750	1200	750	1250	1550	600	900	1500	2100
80	80	135	135	235	235	280	300	370	400	530	740	1000	1650	1000	1700	2100	800	1100	1900	2700
-	-	120	120	345	345	410	450	540	640	760	950	1500	2400	1500	2500	3100	1100	1700	3000	4200

(2) With set of right-angled connectors LA9 F2100.

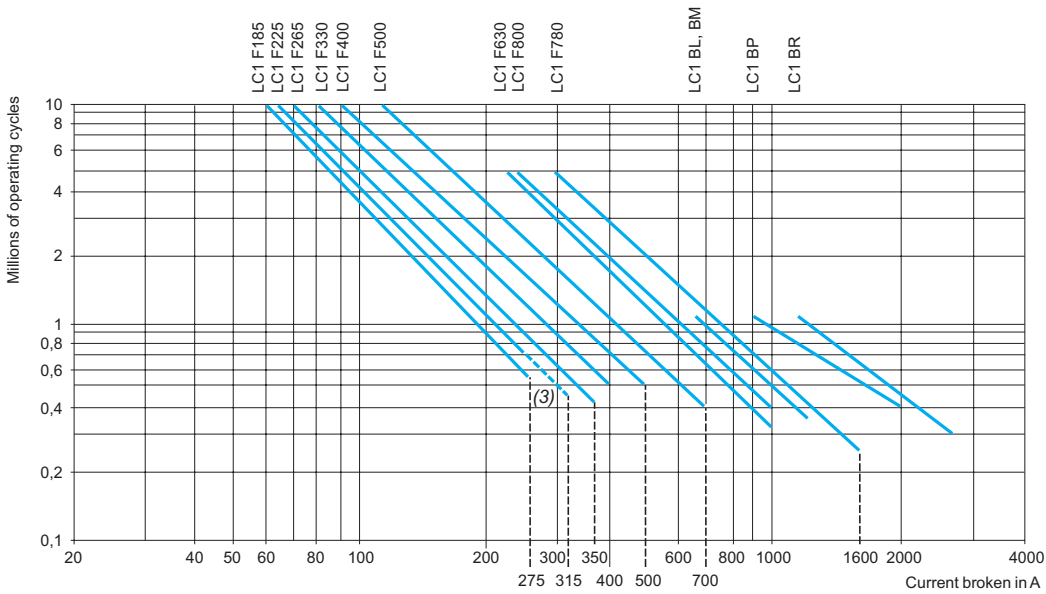

Example:

- $U_e = 220\text{ V} - I_e = 500\text{ A} - \theta \leq 40\text{ }^\circ\text{C} - I_c = I_e = 500\text{ A}$.
- 2 million operating cycles required.
- The above selection curves show the contactor rating needed: LC1 F780.

(3) The dotted lines are only applicable to LC1 F225.

Maximum breaking current

Category AC-2: slip ring motors - breaking the starting current.

Category AC-4: squirrel cage motors - breaking the starting current.

Contactor size			LC1/ LP1 K06	LC1/ LP1 K09	LC1/ LP1 K12	LC1 D09	LC1 D12	LC1 D18	LC1 D25	LC1 D32	LC1 D38	LC1 D40A
In category AC-4 (Ie max)	Ue ≤ 440 V Ie max broken = 6 x I motor	A	36	54	54	54	72	108	150	192	192	240
	440 V < Ue ≤ 690 V Ie max broken = 6 x I motor	A	26	40	40	40	50	70	90	105	105	150

Depending on the maximum operating rate (1) and the on-load factor, θ ≤ 60 °C (2)

From 150 and 15 % to 300 and 10 %	A	20	30	30	30	40	45	75	80	80	110
From 150 and 20 % to 600 and 10 %	A	18	27	27	27	36	40	67	70	70	96
From 150 and 30 % to 1200 and 10 %	A	16	24	24	24	30	35	56	60	60	80
From 150 and 55 % to 2400 and 10 %	A	13	19	19	19	24	30	45	50	50	62
From 150 and 85 % to 3600 and 10 %	A	10	16	16	16	21	25	40	45	45	53

(1) Do not exceed the maximum number of operating cycles..

(2) For temperatures higher than 60 °C, use a maximum operating rate value equal to 80% of the actual value when selecting from the tables.

Counter current braking (plugging)

The current varies from the maximum plug-braking current to the rated motor current.

The making current must be compatible with the rated making and breaking capacities of the contactor.

As breaking normally takes place at a current value at or near the locked rotor current, the contactor can be selected using the criteria for categories AC-2 and AC-4.

Permissible AC-4 power rating for 200 000 operating cycles

Operational voltage		LC●/ LP● K06	LC●/ LP● K09	LC● LP● K12	LC● D09	LC● D12	LC● D18	LC● D25	LC● D32	LC● D38	LC● D40A
220/230 V	kW	0.75	1.1	1.1	1.5	1.5	2.2	3	4	4	4
380/400 V	kW	1.5	2.2	2.2	2.2	3.7	4	5.5	7.5	7.5	9
415 V	kW	1.5	2.2	2.2	2.2	3	3.7	5.5	7.5	7.5	9
440 V	kW	1.5	2.2	2.2	2.2	3	3.7	5.5	7.5	7.5	11
500 V	kW	2.2	3	3	3	4	5.5	7.5	9	9	11
660/690 V	kW	3	4	4	4	5.5	7.5	10	11	11	15

LC1 D50A	LC1 D65A	LC1 D80	LC1 D95	LC1 D115	LC1 D150	LC1 F185	LC1 F225	LC1 F26	LC1 F330	LC1 F40	LC1 F500	LC1 F630	LC1 F780	LC1 F800	LC1 BL	LC1 BM	LC1 BP	LC1 BR
300	390	480	570	630	830	1020	1230	1470	1800	2220	2760	3360	4260	3690	4320	5000	7500	9000
170	210	250	250	540	640	708	810	1020	1410	1830	2130	2760	2910	2910	4000	4800	5400	6600
140	160	200	200	280	310	380	420	560	670	780	1100	1400	1600	1600	2250	3000	4500	5400
120	148	170	170	250	280	350	400	500	600	700	950	1250	1400	1400	2000	2400	3750	5000
100	132	145	145	215	240	300	330	400	500	600	750	950	1100	1100	1500	2000	3000	3600
80	110	120	120	150	170	240	270	320	390	450	600	720	820	820	1000	1500	2000	2500
70	90	100	100	125	145	170	190	230	290	350	500	660	710	710	750	1000	1500	1800

LC● D50A	LC● D65A	LC● D80	LC● D95	LC1 D115	LC1 D150	LC1 F185	LC1 F225	LC1 F265	LC1 F330	LC1 F400	LC1 F500	LC1 F630	LC1 F780	LC1 F800	LC1 BL	LC1 BM	LC1 BP	LC1 BR
5.5	7.5	7.5	9	9	11	18.5	22	28	33	40	45	55	63	63	90	110	150	200
11	11	15	15	18.5	22	33	40	51	59	75	80	100	110	110	160	160	220	250
11	11	15	15	18.5	22	37	45	55	63	80	90	100	110	110	160	160	250	280
11	15	15	15	18.5	22	37	45	59	63	80	100	110	132	132	160	200	250	315
15	15	22	22	30	37	45	55	63	75	90	110	132	150	150	180	200	250	355
15	18.5	25	25	30	45	63	75	90	110	129	140	160	185	185	200	250	315	450

Selection according to required electrical durability, in categories AC-2 or AC-4 ($U_e \leq 440\text{ V}$)

Control of 3-phase asynchronous squirrel cage motors (AC-4) or slip ring motors (AC-2) with breaking whilst motor stalled.
 The current broken (I_c) in AC-2 is equal to $2.5 \times I_e$.
 The current broken (I_c) in AC-4 is equal to $6 \times I_e$. (I_e = rated operational current of the motor).

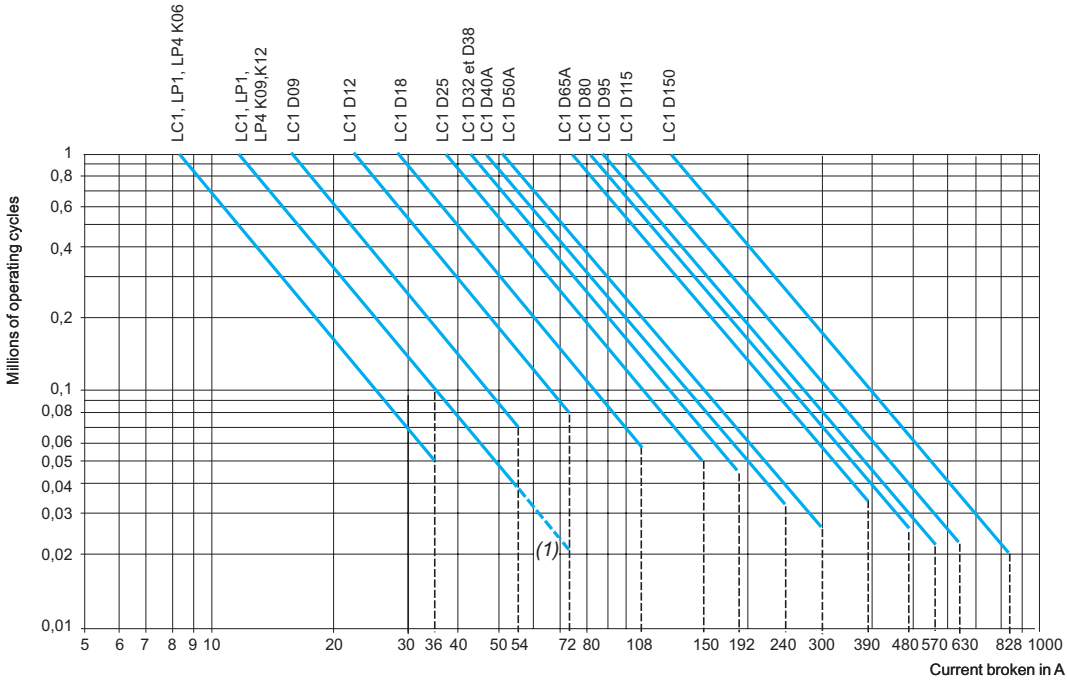

5

Example:

- Asynchronous motor with $P = 5.5\text{ kW}$ - $U_e = 400\text{ V}$ - $I_e = 11\text{ A}$. $I_c = 6 \times I_e = 66\text{ A}$
- or asynchronous motor with $P = 5.5\text{ kW}$ - $U_e = 415\text{ V}$ - $I_e = 11\text{ A}$. $I_c = 6 \times I_e = 66\text{ A}$.
- 200 000 operating cycles required.
- The above selection curves show the contactor rating needed: LC1 D25.

(1) The dotted lines are only applicable to LC1, LP1 K12 contactors.

Selection according to required electrical durability, use in category AC-4 ($440\text{ V} < U_e \leq 690\text{ V}$)

Control of 3-phase asynchronous squirrel cage motors with breaking whilst motor stalled
 The current broken (I_c) in AC-2 is equal to $2.5 \times I_e$.
 The current broken (I_c) in AC-4 is equal to $6 \times I_e$. (I_e = rated operational current of the motor).

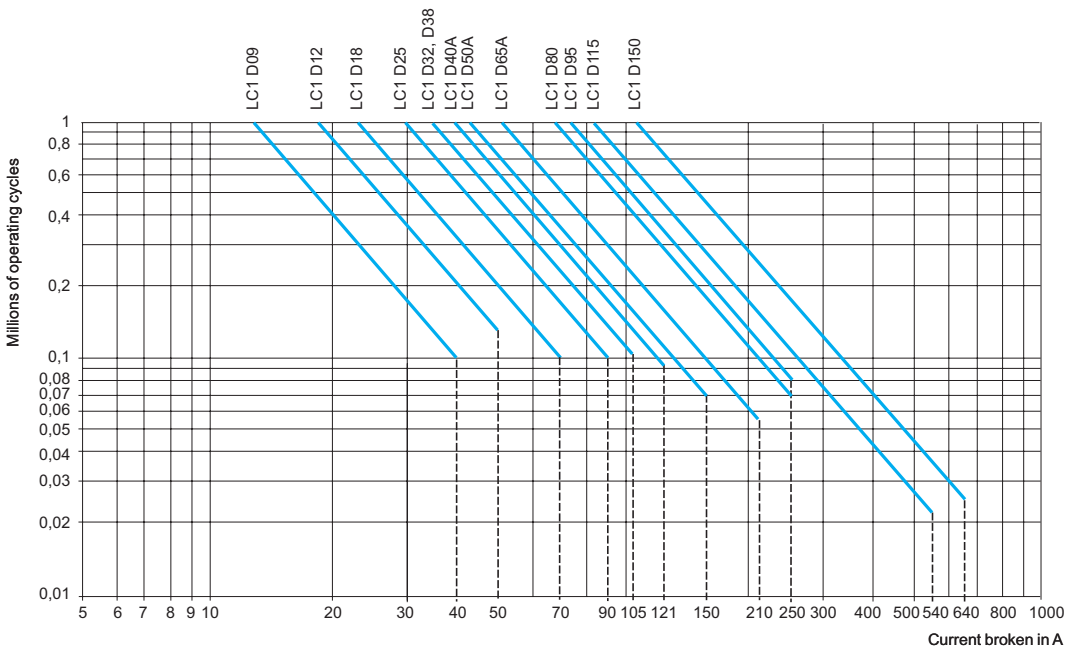

Selection according to required electrical durability, in categories AC-2 or AC-4 ($U_e \leq 440\text{ V}$)

Control of 3-phase asynchronous squirrel cage motors (AC-4) or slip ring motors (AC-2) with breaking whilst motor stalled.
 The current broken (I_c) in AC-4 is equal to $6 \times I_e$.
 (I_e = rated operational current of the motor).

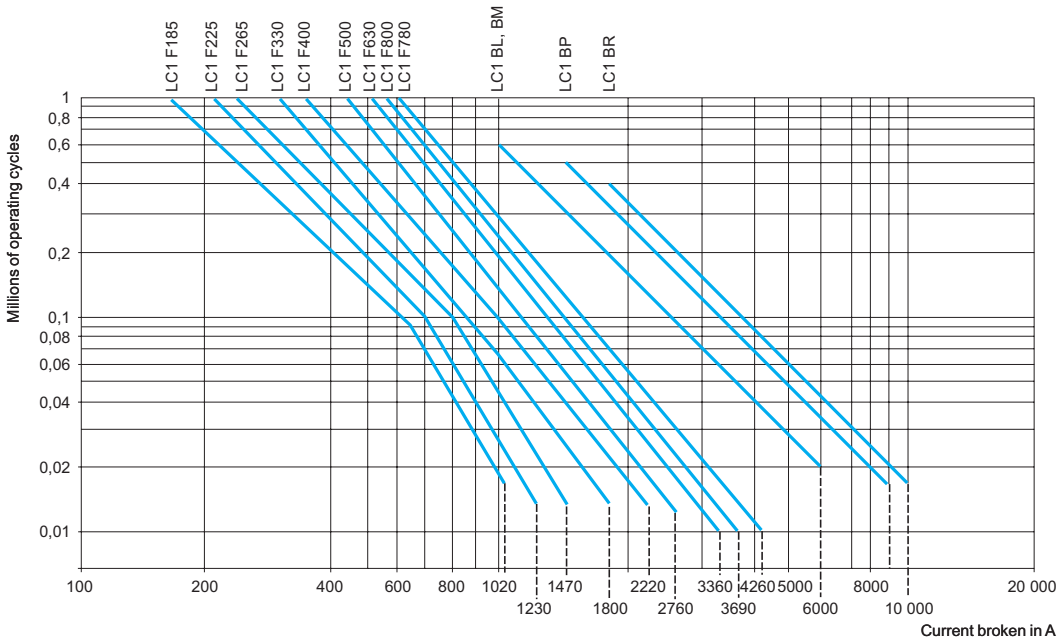

Example:

- Asynchronous motor with $P = 90\text{ kW}$ - $U_e = 380\text{ V}$ - $I_e = 170\text{ A}$. $I_c = 6 \times I_e = 1020\text{ A}$
 or asynchronous motor with $P = 90\text{ kW}$ - $U_e = 415\text{ V}$ - $I_e = 165\text{ A}$. $I_c = 6 \times I_e = 990\text{ A}$.
- 60 000 operating cycles required.
- The above selection curves show the contactor rating needed: LC1 F265.

Selection according to required electrical durability, use in category AC-4 ($440\text{ V} < U_e \leq 690\text{ V}$)

Control of 3-phase asynchronous squirrel cage motors with breaking whilst motor stalled.
 The current broken (I_c) in AC-4 is equal to $6 \times I_e$.
 (I_e = rated operational current of the motor).

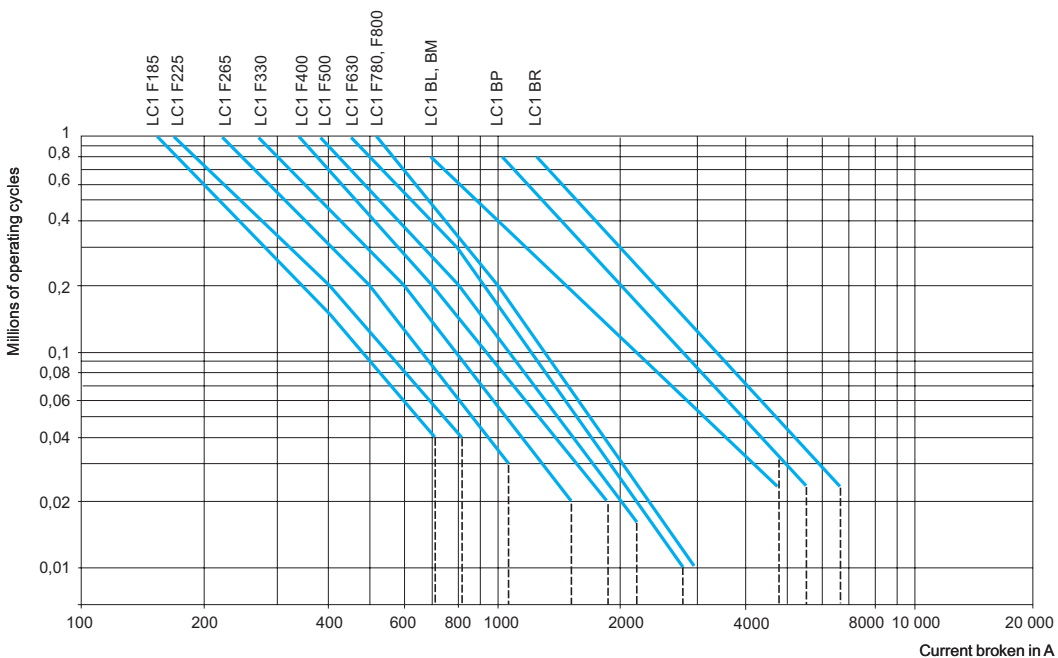

TeSys contactors

For utilisation categories DC-1 to DC-5

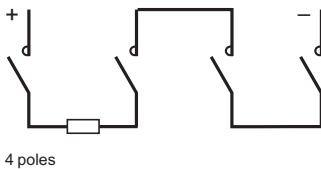
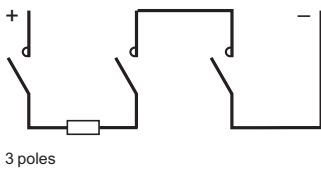
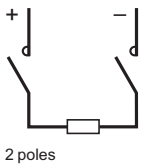
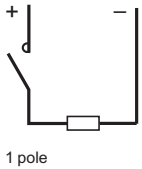

5

Rated operational current (Ie) in Amperes, in utilisation category DC-1, resistive loads: time constant $\frac{L}{R} \leq 1$ ms, ambient temperature ≤ 60 °C

Rated operational voltage Ue	No. of poles connected in series	Contactor rating (1)									
		LC1 D09	LC1 DT20	LC1 D12 DT25	LC1 D18 DT32	LC1 D25 DT40	LC1 D32	LC1 D38	LC1 D40A	LC1 DT60A	
V											
24	1	20	20	20	25	32	40	40	50	50	
	2	20	20	20	25	32	40	40	50	50	
	3	20	20	20	25	32	40	40	50	50	
	4	-	20	20	25	32	-	-	-	50	
48/75	1	20	20	20	25	32	40	40	50	50	
	2	20	20	20	25	32	40	40	50	50	
	3	20	20	20	25	32	40	40	50	50	
	4	-	20	20	25	32	-	-	-	50	
125	1	4	4	4	4	7	7	7	7	7	
	2	20	20	20	25	32	40	40	50	50	
	3	20	20	20	25	32	40	40	50	50	
	4	-	20	20	25	32	-	-	-	50	
250	1	1	1	1	1	1	1	1	1	1	
	2	4	4	4	4	7	7	7	7	7	
	3	20	20	20	25	32	40	40	50	50	
	4	-	20	20	25	32	-	-	-	50	
300	3	4	4	4	4	7	7	7	7	-	
	4	-	20	20	25	32	-	-	-	50	
460	1	-	-	-	-	-	-	-	-	-	
	4	-	-	-	-	-	-	-	-	-	
900	2	-	-	-	-	-	-	-	-	-	
1200	3	-	-	-	-	-	-	-	-	-	
1500	4	-	-	-	-	-	-	-	-	-	

Rated operational current (Ie) in Amperes, in utilisation category DC-2 to DC-5, inductive loads: time constant $\frac{L}{R} \leq 15$ ms, ambient temperature ≤ 60 °C

Rated operational voltage Ue	No. of poles connected in series	Contactor rating (1)									
		LC1 D09	LC1 DT20	LC1 D12 DT25	LC1 D18 DT32	LC1 D25 DT40	LC1 D32	LC1 D38	LC1 D40A	LC1 DT60A	
V											
24	1	20	20	20	25	32	40	40	50	50	
	2	20	20	20	25	32	40	40	50	50	
	3	20	20	20	25	32	40	40	50	50	
	4	-	20	20	25	32	-	-	-	50	
48/75	1	20	20	20	25	32	40	40	50	50	
	2	20	20	20	25	32	40	40	50	50	
	3	20	20	20	25	32	40	40	50	50	
	4	-	20	20	25	32	-	-	-	50	
125	1	2	2	2	2	3	3	3	4	4	
	2	20	20	20	25	32	40	40	50	50	
	3	20	20	20	25	32	40	40	50	50	
	4	-	20	20	25	32	-	-	-	50	
250	1	0,5	0,5	0,5	0,5	0,5	0,5	0,5	1	1	
	2	2	2	2	2	3	3	3	4	4	
	3	8	8	8	8	32	40	40	50	50	
	4	-	20	20	25	32	-	-	-	50	
300	3	2	2	2	2	3	3	3	3	3	
	4	-	8	8	8	32	-	-	-	50	
460	1	-	-	-	-	-	-	-	-	-	
	4	-	-	-	-	-	-	-	-	-	
900	2	-	-	-	-	-	-	-	-	-	
1200	3	-	-	-	-	-	-	-	-	-	
1500	4	-	-	-	-	-	-	-	-	-	

(1) For rated operational currents of contactors LC1 and LP1 K: please consult your Regional Sales Office.

LC1 D50A	LC1 D65A	LC1 DT80A	LC1 D80	LC1 D95	LC1 D115	LC1 D150	LC1 F185	LC1 F225	LC1 F265	LC1 F330	LC1 F400	LC1 F500	LC1 F630	LC1 F780	LC1 F800	LC1 BL	LC1 BM	LC1 BP	LC1 BR
65	65	65	100	100	200	200	240	260	300	360	430	580	850	1300	850	700	1100	1750	2400
65	65	65	100	100	200	200	240	260	300	360	430	580	850	1300	850	700	1100	1750	2400
65	65	65	100	100	200	200	240	260	300	360	430	580	850	1300	850	700	1100	1750	2400
–	–	65	100	–	200	–	240	260	300	360	430	580	850	1300	850	700	1100	1750	2400
65	65	65	100	100	200	200	240	260	300	360	430	580	850	1300	850	700	1100	1750	2400
65	65	65	100	100	200	200	240	260	300	360	430	580	850	1300	850	700	1100	1750	2400
65	65	65	100	100	200	200	240	260	300	360	430	580	850	1300	850	700	1100	1750	2400
–	–	65	100	–	200	–	240	260	300	360	430	580	850	1300	850	700	1100	1750	2400
7	7	7	12	12	12	12	210	230	270	320	380	520	760	1180	760	700	1100	1750	2400
65	65	65	100	100	200	200	210	230	270	320	380	520	760	1180	760	700	1100	1750	2400
65	65	65	100	100	200	200	240	260	300	360	430	580	850	1300	850	700	1100	1750	2400
–	–	65	100	–	200	–	240	260	300	360	430	580	850	1300	850	700	1100	1750	2400
1	1,5	1,5	2	2	10	10	–	–	–	–	–	–	–	–	–	700	1100	1750	2400
7	7	7	12	12	200	200	190	200	250	280	350	450	700	1000	700	700	1100	1750	2400
65	65	65	100	100	200	200	240	260	300	360	430	580	850	1300	850	700	1100	1750	2400
–	–	65	100	–	200	–	240	260	300	360	430	580	850	1300	850	700	1100	1750	2400
7	7	7	12	12	200	200	190	200	250	280	350	450	700	1000	700	700	1100	1750	2400
–	–	65	100	–	200	–	240	260	300	360	430	580	850	1000	850	700	1100	1750	2400
–	–	–	–	–	–	–	–	–	–	–	–	–	–	–	–	700	1100	1750	2400
–	–	–	–	–	200	–	190	200	250	280	350	450	700	1000	700	700	1100	1750	2400
–	–	–	–	–	–	–	–	–	–	–	–	–	–	–	–	700	1100	1750	2400
–	–	–	–	–	–	–	–	–	–	–	–	–	–	–	–	700	1100	1750	2400
–	–	–	–	–	–	–	–	–	–	–	–	–	–	–	–	700	1100	1750	2400

5

LC1 D50A	LC1 D65A	LC1 DT80A	LC1 D80	LC1 D95	LC1 D115	LC1 D150	LC1 F185	LC1 F225	LC1 F265	LC1 F330	LC1 F400	LC1 F500	LC1 F630	LC1 F780	LC1 F800	LC1 BL	LC1 BM	LC1 BP	LC1 BR
65	65	65	100	100	200	200	240	260	300	360	430	580	850	1300	850	700	1100	1750	2400
65	65	65	100	100	200	200	240	260	300	360	430	580	850	1300	850	700	1100	1750	2400
65	65	65	100	100	200	200	240	260	300	360	430	580	850	1300	850	700	1100	1750	2400
–	–	65	100	–	200	–	240	260	300	360	430	580	850	1300	850	700	1100	1750	2400
65	65	65	100	100	200	200	240	260	300	360	430	580	850	1300	850	–	–	–	–
65	65	65	100	100	200	200	240	260	300	360	430	580	850	1300	850	700	1100	1750	2400
–	–	65	100	–	200	–	240	260	300	360	430	580	850	1300	850	700	1100	1750	2400
4	4	4	5	5	10	10	–	–	–	–	–	–	–	–	–	700	1100	1750	2400
65	65	65	100	100	200	200	160	180	250	300	350	500	700	1000	700	700	1100	1750	2400
65	65	65	100	100	200	200	240	240	280	310	350	550	850	1000	850	700	1100	1750	2400
–	–	65	100	–	200	–	240	240	280	310	350	550	850	1000	850	700	1100	1750	2400
1	1,5	1,5	1	1	3	3	–	–	–	–	–	–	–	–	–	700	1100	1750	2400
4	4	4	5	5	200	200	140	160	220	280	310	480	680	900	680	700	1100	1750	2400
65	65	65	100	100	200	200	160	180	250	300	350	500	700	1000	700	700	1100	1750	2400
–	–	65	100	–	200	–	240	260	300	360	430	580	850	1300	850	700	1100	1750	2400
3	3	3	5	5	200	200	140	160	220	280	310	480	680	900	680	700	1100	1750	2400
–	–	65	100	–	200	–	240	260	300	360	430	580	850	1300	850	700	1100	1750	2400
–	–	–	–	–	–	–	–	–	–	–	–	–	–	–	–	700	1100	1750	2400
–	–	–	–	–	200	–	140	160	220	280	310	480	680	800	680	700	1100	1750	2400
–	–	–	–	–	–	–	–	–	–	–	–	–	–	–	–	700	1100	1750	2400
–	–	–	–	–	–	–	–	–	–	–	–	–	–	–	–	700	1100	1750	2400
–	–	–	–	–	–	–	–	–	–	–	–	–	–	–	–	700	1100	1750	2400

Selection according to required electrical durability, use in categories DC-1 to DC-5

The criteria for contactor selection are:

- the rated operational current I_e ,
- the rated operational voltage U_e ,
- the utilisation category and the time constant L/R,
- the required electrical durability.

Maximum operating rate (operating cycles)

The following limits must not be exceeded: 120 operating cycles/hour at rated operational current I_e .

Electrical durability

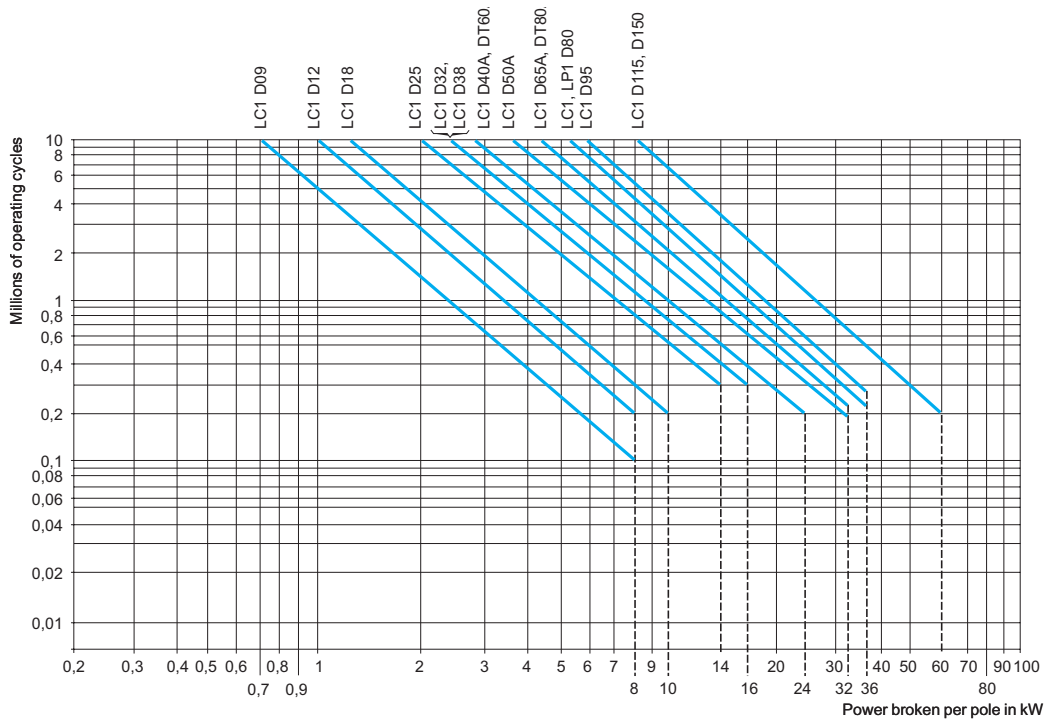

5

Example

Series wound motor - $P = 1.5 \text{ kW}$ - $U_e = 200 \text{ V}$ - $I_e = 7.5 \text{ A}$. Utilisation: reversing, inching.

- Utilisation category = DC-5.
- Select contactor LC1 D09 with 3 poles in series.
- The power broken is: $P_c \text{ total} = 2.5 \times 200 \times 7.5 = 3.75 \text{ kW}$.
- The power broken per pole is: 1.25 kW .
- The electrical durability read from the curve is ≥ 3 millions of operating cycles.

Use of poles in parallel



Electrical durability can be increased by using poles connected in parallel.

With N poles connected in parallel, the electrical durability becomes: electrical durability read from the curves $\times N \times 0.7$.

Note: 1

When the poles are connected in parallel, the maximum operational currents indicated on pages 5/204 and 5/205 must not be exceeded.

Note: 2

Ensure that the connections are made in such a way as to equalise the currents in each pole.

Selection according to required electrical durability, use in categories DC-1 to DC-5

Determining the electrical durability

The electrical durability can be read directly from the curves below, having previously calculated the power broken as follows:

$$P \text{ broken} = U \text{ broken} \times I \text{ broken}$$

The tables below give the values of U_c and I_c for the various utilisation categories.

Utilisation categories	U broken	I broken	P broken
DC-1 Non inductive or slightly inductive loads	U_e	I_e	$U_e \times I_e$
DC-2 Shunt wound motors, breaking whilst motor running	$0.1 U_e$	I_e	$0.1 U_e \times I_e$
DC-3 Shunt wound motors, reversing, inching	U_e	$2.5 I_e$	$U_e \times 2.5 I_e$
DC-4 Series wound motors, breaking whilst motor running	$0.3 U_e$	I_e	$0.3 U_e \times I_e$
DC-5 Series wound motors, reversing, inching	U_e	$2.5 I_e$	$U_e \times 2.5 I_e$

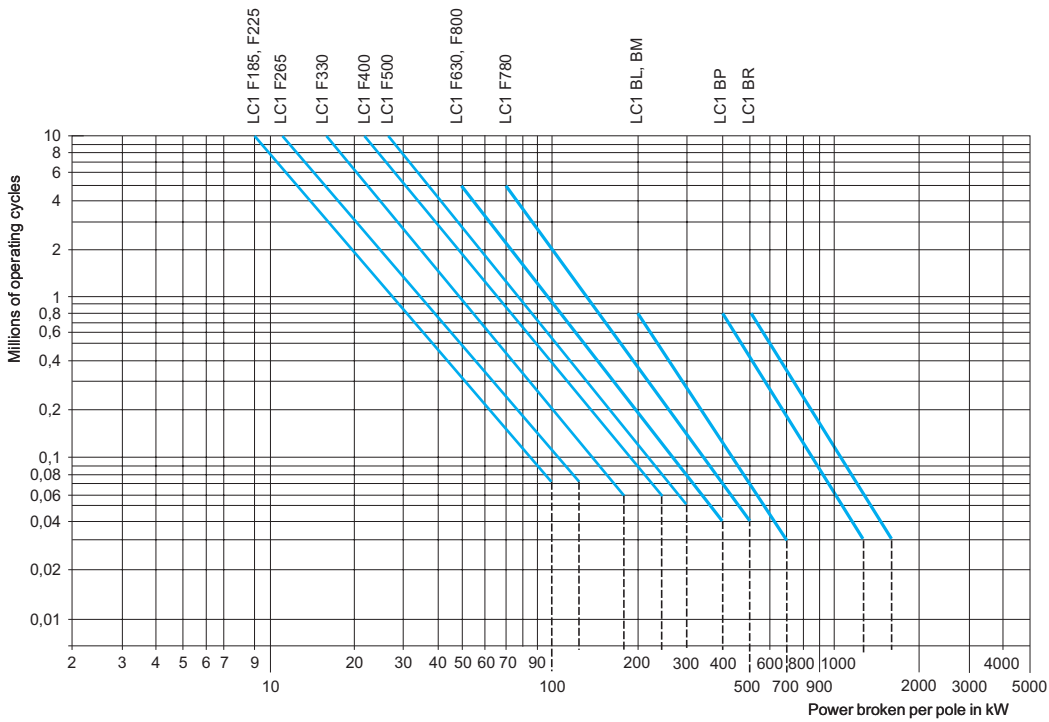

Example

Series wound motor: $P = 40 \text{ kW}$ - $U_e = 200 \text{ V}$ - $I_e = 200 \text{ A}$. Utilisation: reversing, inching.

Utilisation category = DC-5.

- Select contactor LC1 F265 with 2 poles in series.
- The power broken is: $P_c \text{ total} = 2.5 \times 200 \times 200 = 100 \text{ kW}$.
- The power broken per pole is 50 kW .
- The electrical durability read from the curve is $500\,000$ operating cycles.

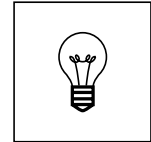

General

The operating conditions of lighting circuits have the following characteristics:

- continuous duty: the switching device can remain closed for several days or even months,
- a dispersion factor of 1: all luminaires in the same group are switched on or off simultaneously,
- a relatively high temperature around the device due to the enclosure, the presence of fuses, or an unventilated control panel location.

This is why the operational current for lighting is lower than the value given for AC-1 duty.

Protection

The continuous duty current drawn by a lighting circuit is constant.

In fact:

- it is unlikely that the number of luminaires of an existing circuit will be modified,
- this type of circuit cannot create an overload of long duration.

It is therefore only necessary to provide short-circuit protection.

This can be provided by:

- gG type fuses, or
- modular circuit-breakers.

Nevertheless, it is always possible and sometimes more economical (smaller cable size) to protect the circuit by a thermal overload relay and associated aM type fuses.

Distribution system

Single-phase circuit, 220/240 V

The tables on pages 5/209 to 5/213 are based on a single-phase 220/240 V circuit and can therefore be applied directly in this case.

3-phase circuit, 380/415 V (with neutral)

The total number of lamps (N) to be switched simultaneously is divided into three equal groups, each connected between one phase and neutral. The contactor can then be selected from the 220/240 V single-phase tables for a number of lamps equal to $\frac{N}{3}$ lamps.

3-phase circuit, 220/240 V

The total number of lamps (N) to be switched simultaneously is divided into three equal groups, each connected between 2 phases (L1-L2), (L2-L3), (L3-L1). The contactor can then be selected from the 220/240 V single-phase table for a number of lamps equal to $\frac{N}{\sqrt{3}}$ lamps.

Contactor selection tables

For the different types of lamps, the tables on pages 5/209 to 5/213 give the maximum number of lamps of unit power P (in Watts), which can be switched simultaneously for each size of contactor.

They are based on:

- a 220/240 V single-phase circuit,
- an ambient temperature of 55 °C (1), taking into account the operating conditions (see General paragraph).
- an electrical life of more than 10 years (200 days' operation per year).

They take into account:

- the total current drawn (including ballast),
- transient phenomena which occur at switch-on,
- the starting currents and their duration,
- the circulation of any harmonics which may be present.

Lamps with compensating capacitor C (µF) connected in parallel

Parallel connected compensating capacitors C cause a current peak at the moment of switch-on. To ensure that the value of this current peak remains compatible with the making characteristics of the contactors, the unit value of the capacitance must not exceed the following:

Switching contactor rating	LC1 K09	LP1 K09	LC1 D09	LC1 D12	LC1 D18	LC1 D25	LC1 D32	LC1 D38	LC1 D40A	LC1 D50A	LC1 D65A	LC1 D80
----------------------------	---------	---------	---------	---------	---------	---------	---------	---------	----------	----------	----------	---------

Maximum unit value C (µF) of parallel connected compensating capacitor	7	3	18	18	25	60	96	96	120	120	240	240
--	---	---	----	----	----	----	----	----	-----	-----	-----	-----

Switching contactor rating	LC1 D95	LC1 D115	LC1 D150	LC1 F185	LC1 F225	LC1 F265	LC1 F330	LC1 F400	LC1 F500	LC1 F630	LC1 F800
----------------------------	---------	----------	----------	----------	----------	----------	----------	----------	----------	----------	----------

Maximum unit value C (µF) of parallel connected compensating capacitor	240	300	360	800	1200	1700	2500	4000	6000	9000	10 800
--	-----	-----	-----	-----	------	------	------	------	------	------	--------

This value is independent of the number of lamps switched by the contactor.

(1) For an ambient temperature of 40 °C, multiply the number by 1.2.

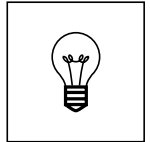

Usual values

The tables show the following values:

- IB: value of current drawn by each lamp at its rated voltage,
- C: unit capacitance for each lamp, corresponding to the values normally quoted by lamp manufacturers.

These values are given for an ambient temperature of 55 °C (for 40 °C, multiply the number by 1.2).

Incandescent and halogen lamps

P (W)	60	75	100	150	200	300	500	750	1000	
IB (A)	0.27	0.34	0.45	0.68	0.91	1.40	2.30	3.40	4.60	LC1
Max. no. of lamps according to P (W)	35	28	21	14	10	6	4	2	2	K09
	59	47	35	23	17	11	7	4	3	D09, D12
	77	61	46	30	23	15	9	6	4	D18
	92	73	55	36	27	18	11	7	5	D25
	129	103	77	51	38	25	15	10	7	D32, D38
	163	129	97	64	48	31	19	13	9	D40A
	207	164	124	82	62	40	24	16	12	D50A, D65A
	296	235	177	117	88	57	34	23	17	D80, D95
	430	340	256	170	126	82	50	34	24	D115
	466	370	280	184	138	90	54	36	26	D150
	710	564	426	282	210	136	82	56	40	F185
	770	610	462	304	228	148	90	60	44	F225
	888	704	532	352	262	170	104	70	52	F265
	1006	800	604	400	298	194	118	80	58	F330
	1274	1010	764	504	378	244	148	100	74	F400
	1718	1364	1030	682	508	330	200	136	100	F500
	2328	1850	1396	924	690	448	272	184	136	F630
	2776	2204	1666	1102	824	534	326	220	162	F800

Mixed lighting lamps

P (W)	100	160	250	500	1000	
IB (A)	0.45	0.72	1.10	2.30	4.50	LC1
Max. no. of lamps according to P (W)	21	13	8	4	2	K09
	35	22	14	7	3	D09, D12
	46	29	18	9	4	D18
	55	36	23	11	5	D25
	77	48	30	15	7	D32, D38
	97	61	38	19	9	D40A
	124	77	49	24	12	D50A, D65A
	177	111	70	34	17	D80, D95
	256	160	104	50	26	D115
	280	174	114	54	28	D150
	426	266	174	82	42	F185
	462	288	188	90	46	F225
	532	332	218	104	52	F265
	604	378	246	118	60	F330
	764	478	312	150	76	F400
	1030	644	422	202	102	F500
	1398	874	572	272	140	F630
	1666	1040	680	326	166	F800

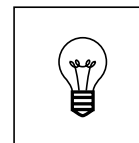

Usual values

The tables show the following values:

- IB: value of current drawn by each lamp at its rated voltage,
- C: unit capacitance for each lamp, corresponding to the values normally quoted by lamp manufacturers.

These values are given for an ambient temperature of 55 °C (for 40 °C, multiply the number by 1.2).

Fluorescent lamps with starter. Single fitting

	Non corrected				With parallel correction						LC1
	P (W)	20	40	65	80	110	20	40	65	80	
IB (A)	0.39	0.45	0.70	0.80	1.2	0.17	0.26	0.42	0.52	0.72	
C (µF)	–	–	–	–	–	5	5	7	7	16	
Max. no. of lamps according to P (W)	24	21	13	12	8	56	36	22	18	–	K09
	41	35	22	20	13	94	61	38	30	22	D09, D12
	53	46	30	26	17	123	80	50	40	29	D18
	66	57	37	32	21	152	100	61	50	36	D25
	89	77	50	43	29	205	134	83	67	48	D32, D38
	112	97	62	55	36	258	169	104	84	61	D40A
	143	124	80	70	46	329	215	133	107	77	D50A, D65A
	205	177	114	100	66	470	367	190	153	111	D80, D95
	410	354	228	200	132	940	614	380	306	222	D115, D150
	492	426	274	240	160	1128	738	456	368	266	F185
	532	462	296	260	172	1224	800	490	400	288	F225
	614	532	342	300	200	1412	922	570	462	332	F265
	696	604	388	340	226	1600	1046	648	522	378	F330
	882	764	490	430	286	2024	1322	818	662	478	F400
	1190	1030	662	580	386	2728	1724	1104	892	644	F500
	1612	1398	698	786	524	3700	2418	1498	1210	874	F630, F800

Fluorescent lamps with starter. Twin fitting

	Non corrected					With series correction					LC1
	P (W)	2x20	2x40	2x65	2x80	2x110	2x0.13	2x0.24	2x0.39	2x0.48	
IB (A)	2x0.22	2x0.41	2x0.67	2x0.82	2x1.1	2x0.13	2x0.24	2x0.39	2x0.48	2x0.65	
Max. no. of lamps according to P (W)	2x21	2x11	2x7	2x5	2x4	2x36	2x20	2x12	2x10	2x7	K09
	2x36	2x18	2x10	2x8	2x6	2x60	2x32	2x20	2x16	2x12	D09, D12
	2x46	2x24	2x14	2x12	2x8	2x80	2x42	2x26	2x20	2x16	D18
	2x58	2x30	2x18	2x14	2x10	2x100	2x54	2x32	2x26	2x20	D25
	2x78	2x42	2x26	2x20	2x14	2x134	2x72	2x44	2x36	2x26	D32, D38
	2x100	2x52	2x32	2x26	2x18	2x168	2x90	2x56	2x44	2x32	D40A
	2x126	2x68	2x40	2x34	2x24	2x214	2x116	2x70	2x58	2x42	D50A, D65A
	2x180	2x96	2x58	2x48	2x36	2x306	2x166	2x102	2x82	2x60	D80, D95
	2x360	2x194	2x118	2x96	2x72	2x614	2x332	2x204	2x166	2x122	D115, D150
	2x436	2x234	2x142	2x116	2x86	2x738	2x400	2x246	2x200	2x148	F185
	2x472	2x254	2x154	2x126	2x94	2x800	2x432	2x266	2x216	2x160	F225
	2x544	2x292	2x178	2x146	2x108	2x922	2x500	2x308	2x250	2x184	F265
	2x618	2x332	2x202	2x166	2x124	2x1046	2x566	2x348	2x282	2x208	F330
	2x782	2x420	2x256	2x210	2x156	2x1322	2x716	2x440	2x358	2x264	F400
	2x1054	2x566	2x346	2x282	2x210	2x1784	2x966	2x594	2x482	2x356	F500
	2x1430	2x766	2x468	2x384	2x286	2x2418	2x1310	2x806	2x654	2x484	F630, F800



Usual values

The tables show the following values:

- IB: value of current drawn by each lamp at its rated voltage,
- C: unit capacitance for each lamp, corresponding to the values normally quoted by lamp manufacturers.

These values are given for an ambient temperature of 55 °C (for 40 °C, multiply the number by 1.2).

Fluorescent lamps without starter. Single fitting

	Non corrected					With parallel correction					LC1	
	P (W)	20	40	65	80	110	20	40	65	80		110
	IB (A)	0.43	0.55	0.80	0.95	1.4	0.19	0.29	0.46	0.57		0.79
	C (µF)	–	–	–	–	–	5	5	7	7	16	
Max. no. of lamps according to P (W)	22	17	12	10	6	50	33	20	16	–		K09
	37	29	20	16	11	84	55	34	28	20		D09, D12
	48	38	26	22	15	110	72	45	36	26		D18
	60	47	32	27	18	136	89	56	45	32		D25
	97	63	43	36	25	184	101	76	61	44		D32, D38
	102	80	55	46	31	231	151	95	77	55		D40A
	130	101	70	58	40	294	193	121	98	70		D50A, D65A
	186	145	100	84	57	421	275	173	140	101		D80, D95
	372	290	200	168	114	842	550	346	280	202		D115, D150
	446	348	240	202	136	1010	662	416	336	242		F185
	484	378	260	218	148	1094	716	452	364	262		F225
	558	436	300	252	170	1262	828	522	420	304		F265
	632	494	340	286	194	1432	938	590	476	344		F330
	800	624	430	362	246	1810	1186	748	604	434		F400
	1078	844	580	488	330	2442	1600	1008	814	586		F500
	1462	1144	786	662	448	3310	2168	1366	1104	796		F630, F800

Fluorescent lamps without starter. Twin fitting

	Non corrected					With series correction					LC1	
	P (W)	2x20	2x40	2x65	2x80	2x110	2x20	2x40	2x65	2x80		2x110
	IB (A)	2x0.25	2x0.47	2x0.76	2x0.93	2x1.3	2x0.14	2x0.26	2x0.43	2x0.53		2x0.72
Max. no. of lamps according to P (W)	2x19	2x10	2x6	2x5	2x3	2x34	2x18	2x11	2x9	2x6		K09
	2x32	2x16	2x10	2x8	2x6	2x56	2x30	2x18	2x14	2x10		D09, D12
	2x42	2x22	2x12	2x10	2x8	2x74	2x40	2x24	2x18	2x14		D18
	2x52	2x26	2x16	2x12	2x10	2x92	2x50	2x30	2x24	2x18		D25
	2x70	2x36	2x22	2x18	2x12	2x124	2x66	2x40	2x32	2x24		D32, D38
	2x88	2x46	2x28	2x22	2x16	2x156	2x84	2x50	2x40	2x30		D40A
	2x112	2x58	2x36	2x30	2x20	2x200	2x106	2x64	2x52	2x38		D50A, D65A
	2x160	2x84	2x52	2x42	2x30	2x234	2x152	2x92	2x74	2x54		D80, D95
	2x320	2x170	2x104	2x86	2x60	2x570	2x306	2x186	2x150	2x110		D115, D150
	2x384	2x204	2x126	2x102	2x74	2x686	2x368	2x222	2x180	2x132		F185
	2x416	2x220	2x136	2x112	2x80	2x742	2x400	2x242	2x196	2x144		F225
	2x480	2x254	2x158	2x128	2x92	2x856	2x462	2x278	2x226	2x166		F265
	2x544	2x288	2x178	2x146	2x104	2x970	2x522	2x316	2x256	2x188		F330
	2x688	2x366	2x226	2x184	2x132	2x1228	2x662	2x400	2x324	2x238		F400
	2x928	2x494	2x304	2x248	2x178	2x1656	2x892	2x540	2x438	2x322		F500
	2x1258	2x668	2x414	2x338	2x242	2x2246	2x1210	2x730	2x592	2x436		F630, F800



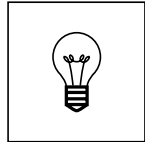

Usual values

The tables show the following values:

- IB: value of current drawn by each lamp at its rated voltage,
- C: unit capacitance for each lamp, corresponding to the values normally quoted by lamp manufacturers.

These values are given for an ambient temperature of 55 °C (for 40 °C, multiply the number by 1.2).

Low pressure sodium vapour lamps

	Non corrected							With parallel correction							LC1	
	P (W)	35	55	90	135	150	180	200	35	55	90	135	150	180		200
IB (A)	1.2	1.6	2.4	3.1	3.2	3.3	3.4	0.3	0.4	0.6	0.9	1	1.2	1.3		
C (µF)	–	–	–	–	–	–	–	17	17	25	36	36	36	36		
Max. no. of lamps according to P (W)	6	5	3	2	2	2	2	–	–	–	–	–	–	–	–	K09
	10	7	5	3	3	3	3	40	30	–	–	–	–	–	–	D09, D12
	12	9	6	4	4	4	4	50	37	25	–	–	–	–	–	D18
	15	11	7	6	5	5	5	63	47	31	21	19	15	14	–	D25
	21	16	10	8	8	7	7	86	65	43	28	26	21	20	–	D32, D38
	27	20	13	10	10	10	9	110	82	55	36	33	27	25	–	D40A
	35	26	17	13	13	12	12	140	105	70	46	42	35	32	–	D50A, D65A
	50	37	25	19	18	18	17	200	150	100	66	60	50	46	–	D80, D95
	100	75	50	38	36	36	34	400	300	200	132	120	100	92	–	D115, D150
	140	104	70	54	52	50	48	560	420	280	186	168	140	128	–	F185
	152	114	76	58	56	54	54	606	454	302	202	182	152	140	–	F225
	174	130	88	68	66	64	62	700	524	350	232	210	174	162	–	F265
	198	148	98	76	74	72	70	792	594	396	264	238	198	182	–	F330
	250	188	124	96	94	90	88	1002	752	502	334	300	250	252	–	F400
	338	254	168	130	126	122	118	1352	1014	676	450	406	338	312	–	F500
	496	372	248	192	186	180	174	1982	1488	992	660	594	496	458	–	F630, F800

High pressure sodium vapour lamps

	Non corrected					With parallel correction					LC1
	P (W)	150	250	400	700	1000	150	250	400	700	
IB (A)	1.9	3.2	5	8.8	12.4	0.84	1.4	2.2	3.9	5.5	
C (µF)	–	–	–	–	–	20	32	48	96	120	
Max. no. of lamps according to P (W)	4	2	1	–	–	–	–	–	–	–	K09
	6	3	2	1	–	–	–	–	–	–	D09, D12
	7	4	3	1	1	17	–	–	–	–	D18
	10	5	3	2	1	22	13	8	–	–	D25
	13	8	5	2	2	30	18	11	6	–	D32, D38
	17	10	6	3	2	39	23	15	8	6	D40A
	22	13	8	4	3	50	30	19	10	7	D50A, D65A
	31	18	12	6	4	71	42	27	15	10	D80, D95
	62	36	24	12	8	142	84	54	30	20	D115, D150
	88	52	34	18	14	200	120	76	42	30	F185
	96	56	36	20	16	216	130	82	46	32	F225
	110	66	42	24	18	250	150	94	54	38	F265
	124	74	48	26	20	282	170	108	60	42	F330
	158	94	60	34	24	358	214	136	76	54	F400
	214	126	80	46	32	482	290	184	104	74	F500
	312	186	118	68	48	708	424	270	152	108	F630, F800

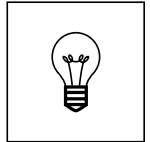

Usual values

The tables show the following values:

- IB: value of current drawn by each lamp at its rated voltage,
- C: unit capacitance for each lamp, corresponding to the values normally quoted by lamp manufacturers.

These values are given for an ambient temperature of 55 °C (for 40 °C, multiply the number by 1.2).

High pressure mercury vapour lamps

	Non corrected							With parallel correction							LC1	
	P (W)	50	80	125	250	400	700	1000	50	80	125	250	400	700		1000
IB (A)	0.54	0.81	1.20	2.30	4.10	6.80	9.90	0.3	0.45	0.67	1.3	2.3	3.8	5.5		
C (µF)	–	–	–	–	–	–	–	10	10	10	18	25	40	60		
Max. no. of lamps according to P (W)	14	9	6	3	1	–	–	–	–	–	–	–	–	–	–	K09
	22	14	9	5	2	1	1	40	26	17	9	–	–	–	–	D09, D12
	27	18	12	6	3	2	1	50	33	22	11	6	–	–	–	D18
	35	23	15	8	4	2	1	63	42	28	14	8	5	3	–	D25
	48	32	21	11	6	3	2	86	57	38	20	11	6	4	–	D32, D38
	61	40	27	14	8	4	3	110	73	49	25	14	8	6	–	D40A
	77	51	34	17	10	6	4	140	93	62	32	18	11	7	–	D50A, D65A
	111	74	49	26	14	8	6	200	133	89	46	26	15	10	–	D80, D95
	222	148	100	52	28	16	12	400	266	178	92	52	30	20	–	D115, D150
	310	206	140	72	40	24	17	560	372	250	128	72	44	30	–	F185
	336	224	152	78	44	26	18	606	404	272	140	78	48	32	–	F225
	388	258	174	90	50	30	20	700	466	312	162	90	54	38	–	F265
	440	294	198	102	58	34	24	792	528	354	182	102	62	42	–	F330
	556	372	250	130	72	44	30	1002	668	448	232	130	78	54	–	F400
	752	500	338	176	98	60	40	1352	902	606	312	176	106	74	–	F500
	1102	734	496	258	144	88	60	1982	1322	888	458	258	156	108	–	F630, F800

Metal iodine vapour lamps

	Non corrected				With parallel correction				LC1
	P (W)	250	400	1000	2000	250	400	1000	
IB (A)	2.5	3.6	9.5	20	1.4	2	5.3	11.2	
C (µF)	–	–	–	–	32	32	64	140	
Max. no. of lamps according to P (W)	3	2	–	–	–	–	–	–	K09
	4	3	1	–	–	–	–	–	D09, D12
	6	4	1	–	–	–	–	–	D18
	7	5	2	–	13	9	–	–	D25
	10	7	2	1	18	13	4	–	D32, D38
	13	9	3	1	23	16	6	–	D40A
	16	11	4	2	30	21	7	–	D50A, D65A
	24	16	6	3	42	30	11	5	D80, D95
	48	32	12	6	84	60	22	10	D115, D150
	66	46	18	8	120	84	32	14	F185
	72	50	20	10	130	90	34	16	F225
	84	58	22	12	150	104	40	18	F265
	94	66	24	14	170	118	44	20	F330
	120	84	32	16	214	150	56	26	F400
	162	112	42	20	290	202	76	36	F500
	238	164	62	30	424	298	112	52	F630, F800

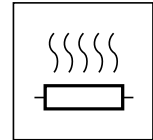

Selection

General

A heating circuit is a power switching circuit supplying one or more resistive heating elements switched by a contactor. The same general rules apply as for motor circuits, except that heating circuits are not normally subjected to overload currents. It is therefore only necessary to provide short-circuit protection.

Characteristics of heating elements

The examples below are based on resistive heating elements used for industrial furnaces or for the heating of buildings (infra-red or resistive radiant type, convector heaters, closed loop heating circuits, etc.).

The variation in resistance values between hot and cold states causes a current peak at switch-on which never exceeds 2 to 3 times the rated operational current (I_n). This initial peak does not recur during normal operation where subsequent switching is thermostatically controlled.

The rated power and current of a heater are given for the normal operating temperature.

Protection

The steady state current drawn by a heating circuit is constant when the voltage is stable. In fact:

- It is unlikely that the number of loads in an existing circuit will be modified;
- This type of circuit cannot create overloads. It is therefore only necessary to provide short-circuit protection.

This can be provided by:

- gG type fuses, or
- modular circuit-breakers.

Nevertheless, it is always possible and sometimes more economical (smaller cable size) to protect the circuit by a thermal overload relay and associated aM type fuses.

Switching, control, protection

A heating element or group of heating elements of a given power may be either single-phase or 3-phase and may be supplied from a 220/127 V or a 400/230 V distribution system.

Excluding a single-phase 127 V system (which is no longer commonly used), the following 3 types of circuit arrangement are possible:

- Single-phase, 2-pole switching
- Single-phase, 4-pole switching
- 3-phase switching

Component selection according to the power switched

The combinations suggested below are based on an ambient temperature of 55 °C and for powers at the nominal voltage, but they also ensure switching in the event of prolonged overloads up to 1.05 U_e .

Single-phase, 2-pole switching

Maximum power (kW)				Contactor rating
220/240 V	380/415 V	660/690 V	1000 V	
3.5	6.5	11	–	LC1, LP1 K09
4.5	8	14	–	LC1 D12
6	10.5	18.5	–	LC1 D18
7	13	22.5	–	LC1 D25
10	18	30.5	–	LC1 D32, LC1 D38
13	22.5	39.5	48	LC1 D40A
16.5	28.5	43.5	68	LC1 D65A
24	42	73	82.5	LC1, LP1 D80
44	76	118	157	LC1 D115, LC1 D150
48	83	130	170	LC1 F185
52	90	145	185	LC1 F225
60	104	160	210	LC1 F265
75	130	200	250	LC1 F330
86	145	230	300	LC1 F4002
116	200	310	400	LC1 F5002
170	290	450	695	LC1 F6302, LC1 F800
270	460	715	945	LC1 F780
140	242	370	490	LC1 BL32
220	380	580	770	LC1 BM32
350	605	925	1225	LC1 BP32
480	830	1270	1680	LC1 BR32

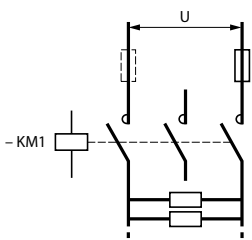

Circuit controlled by 2 poles of the contactor.

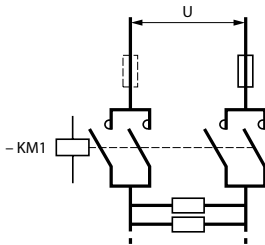
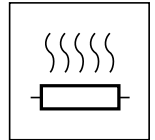

Circuit controlled by a 4-pole contactor with the poles parallel connected in pairs using appropriate connecting links. This solution enables the control of power values approximately equivalent to those controlled by the same contactor on 3-phase.

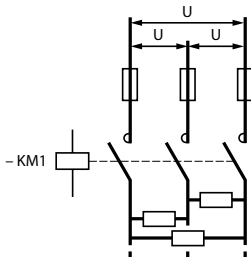

Circuit controlled by 3 poles of the contactor.

Component selection according to the power switched (continued)

Single-phase, 4-pole switching

Maximum power (kW)				Contactor rating
220/240 V	380/415 V	660/690 V	1000 V	
4.5	8	13.5	–	LC1, LP1 K09004
7	13	22.5	–	LC1 DT25
12	21	36.5	–	LC1 DT40
26	45.5	79.5	109	LC1 DT80A
38	66	117.5	132	LC1, LP1 D80004
70	121	190	251	LC1 D115004
76	132	202	270	LC1 F1854
80	142	230	295	LC1 F2254
96	166	253	335	LC1 F2654
120	205	320	400	LC1 F3304
137	236	363	480	LC1 F4004
185	320	490	650	LC1 F5004
272	470	718	950	LC1 F6304
425	735	1140	1520	LC1 F7804
224	387	590	785	LC1 BL34
352	608	930	1230	LC1 BM34
560	968	1478	1960	LC1 BP34
768	1328	2025	2685	LC1 BR34

3-phase switching

Maximum power (kW)				Contactor rating
220/240 V	380/415 V	660/690 V	1000 V	
4.5	8	13.5	–	LC1, LP1 K09
7	13	22.5	–	LC1 D12
10	18	30.5	–	LC1 D18
13	22.5	39.5	–	LC1 D25
18	31	52.5	–	LC1 D32, LC1 D38
22.5	38	68	78	LC1 D40A
28.5	49	86	112.5	LC1 D65A
40.5	70.5	126	135.5	LC1, LP1 D80
76	131	206	275	LC1 D115, LC1 D150
82	143	220	295	LC1 F185
90	155	250	320	LC1 F225
103	179	275	370	LC1 F265
130	225	345	432	LC1 F330
149	256	395	525	LC1 F400
200	346	530	710	LC1 F500
294	509	780	1030	LC1 F630, LC1 F800
463	800	1235	1650	LC1 F780
242	419	640	850	LC1 BL33
380	658	1005	1350	LC1 BM33
606	1047	1600	2150	LC1 BP33
830	1437	2200	2950	LC1 BR33

Application example

For a 220 V, 50 Hz, single-phase circuit supplying a total heating load of 12.5 kW.
Select a 3-pole contactor **LC1 D65A**.

TeSys contactors

For switching the primaries of 3-phase LV/LV transformers

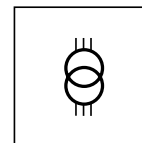

Operating conditions

Maximum ambient temperature: 55 °C.

When a transformer is switched on, there is generally an initial current surge which reaches its peak value almost instantaneously and then decreases in a largely exponential manner to quickly reach its steady state value.

The value of this current depends on:

- the characteristics of the magnetic circuit and of the windings (cross sectional area of the core, rated inductance, number of turns, layout and size of the windings, ...)
- the performance of the magnetic laminations used,
- the magnetic state of the circuit and the instantaneous value of the a.c. mains voltage at the moment of switch-on.

The inrush current at the moment of switch-on can reach 20 to 40 times the rated current for the various kVA power ratings in the tables below. This value is independent of the "no-load" or "on-load" state of the transformer.

Contactor selection

The peak magnetising current of the transformer must be lower than the values given in the tables below.

Maximum operating rate: 120 operating cycles/hour.

Contactor rating		LC1/ LP1 K06	LC1/ LP1 K09	LC1 D09	LC1 D12	LC1 D18	LC1 D25	LC1 D32	LC1 D38	LC1 D40A	LC1 D50A	LC1 D65A	LC1 D80	LC1 D95	LC1 D115	LC1 D150	
Maximum permissible current peak at switch-on	A	160	225	350	350	420	630	770	770	1100	1250	1400	1550	1650	1800	2000	
Maximum operational power (1)	220 V	kVA	2	2.5	4	4	5	7	8.5	8.5	14	16	18	19.5	19.5	25	25
	240 V	kVA	3.5	5	7	7	8	12.5	15	15	24	27	31	34	34	50	50
	380 V	kVA	4	5.5	8	8	9	14	17	17	28	32	36	39	39	55	55
	400 V	kVA	5	7	9	9	11	16.5	20	20	32	36	40	45	45	65	65
	415 V	kVA	6	8.5	12	12	14	21.5	26.5	26.5	42	48	53	59	59	80	80
	440 V	kVA	–	–	–	–	–	–	–	–	60	70	80	85	95	100	100

Contactor rating		LC1 F185	LC1 F225	LC1 F265	LC1 F330	LC1 F400	LC1 F500	LC1 F630	LC1 F780	LC1 F800	LC1 BL	LC1 BM	LC1 BP	LC1 BR	
Maximum permissible current peak at switch-on	A	2900	3300	3800	5000	6300	7700	9000	12000	11000	18000	18000	24000	30000	
Maximum operational power (1)	220 V	kVA	40	45	50	65	75	100	120	175	145	230	230	300	380
	240 V	kVA	75	80	90	120	130	170	200	280	245	400	400	530	660
	380 V	kVA	80	90	100	130	140	190	220	310	270	450	450	560	700
	400 V	kVA	95	100	110	140	170	225	260	350	315	480	480	600	750
	415 V	kVA	120	130	140	170	200	270	350	400	425	600	600	800	950
	440 V	kVA	150	170	200	225	250	375	470	650	550	700	700	1000	1200

(1) Maximum operational power corresponding to a current peak at switch-on of 30 In.

TeSys contactors

For switching 3-phase capacitor banks used for power factor correction

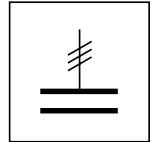

Standard contactors

Capacitors, together with the circuits to which they are connected, form oscillatory circuits which can, at the moment of switch-on, give rise to high transient currents (> 180 In) at high frequencies (1 to 15 kHz).

As a general rule, the peak current on energisation is lower when:

- the mains inductances are high,
- the line transformer ratings are low,
- the transformer short-circuit voltage is high,
- the ratio between the sum of the ratings of the capacitors already switched into the circuit and that of the capacitor to be switched in is small (for multiple step capacitor banks).

In accordance with standards IEC 60070, NF C 54-100, VDE 0560, the switching contactor must be able to withstand a continuous current of 1.43 times the rated current of the capacitor bank step being switched.

The rated operational powers given in the tables below take this overload into account. Short-circuit protection is normally provided by gl type HPC fuses rated at 1.7 to 2 In.

Contactor applications

Operating conditions

Capacitors are directly switched. **The values of peak current at switch-on must not exceed the values indicated opposite.**

An inductor may be inserted in each of the three phases supplying the capacitors to reduce the peak current, if necessary.

Inductance values are determined according to the selected operating temperature.

Power factor correction by a single-step capacitor bank

The use of a choke inductor is unnecessary: the inductance of the mains supply is adequate to limit the peak to a value compatible with the contactor characteristics.

Power factor correction by a multiple-step capacitor bank

Select a special contactor as defined on page 5/102.

If a standard contactor is used, it is essential to insert a choke inductor in each of the three phases of each step.

Maximum operational power of contactors

Standard contactors

Maximum operating rate: 120 operating cycles/hour.

Electrical durability at maximum load: 100 000 operating cycles.

With choke inductors connected, where necessary.

Operational power at 50/60 Hz						Max. peak current	Contactor rating
$\theta \leq 40^\circ\text{C}$ (1)			$\theta \leq 55^\circ\text{C}$ (1)				
220/240 V	400/440 V	600/690 V	220/240 V	400/440 V	600/690 V	A	
kvAR	kvAR	kvAR	kvAR	kvAR	kvAR		
6	11	15	6	11	15	560	LC1 D09, D12
9	15	20	9	15	20	850	LC1 D18
11	20	25	11	20	25	1600	LC1 D25
14	25	30	14	25	30	1900	LC1 D32, D38
17	30	37	17	30	37	2160	LC1 D40
22	40	50	22	40	50	2160	LC1 D50
22	40	50	22	40	50	3040	LC1 D65
35	60	75	35	60	75	3040	LC1 D80, D95
50	90	125	38	75	80	3100	LC1 D115
60	110	135	40	85	90	3300	LC1 D150
70	125	160	50	100	100	3500	LC1 F185
80	140	190	60	110	110	4000	LC1 F225
90	160	225	75	125	125	5000	LC1 F265
100	190	275	85	140	165	6500	LC1 F330
125	220	300	100	160	200	8000	LC1 F400
180	300	400	125	220	300	10 000	LC1 F500
250	400	600	190	350	500	12 000	LC1 F630
250	400	600	190	350	500	14 200	LC1 F800
200	350	500	180	350	500	25 000	LC1 BL
300	550	650	250	500	600	25 000	LC1 BM
500	850	950	400	750	750	25 000	LC1 BP
600	1100	1300	500	1000	1000	25 000	LC1 BR

(1) Upper limit of temperature category conforming to IEC 60070.

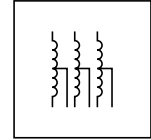

Applications

Auto-transformer starting is suitable for starting all types of squirrel cage motors: with 3, 6 or even 9 terminals according to North American technology.

Starting is performed at reduced voltage and produces maximum torque at minimum line current. It allows the starting torque ($C = f(U)^2$) to be adapted to the resistive torque of the driven machine by means of the 2 or 3 intermediate voltage take-off connections on the auto-transformer (0.65 and 0.8 U_n or 0.5, 0.65 and 0.8 U_n). In general, only one take-off connection is used.

This type of starting is used for high power and/or high inertia machines. The motor is never disconnected from its power supply during starting (closed transition) and transient phenomena are eliminated.

Recommended wiring scheme

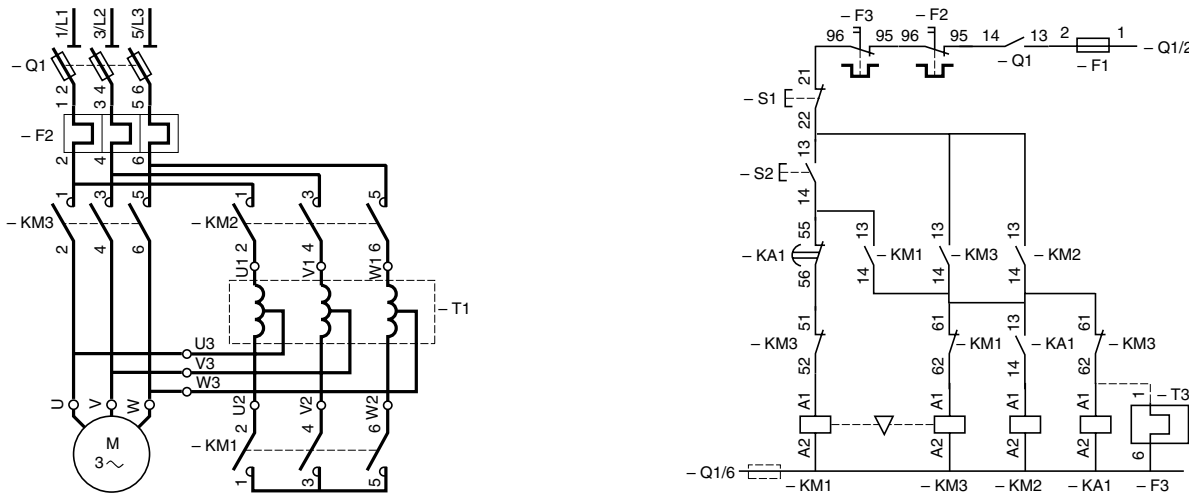

Operation

Starting is performed in 3 stages:

- star connection of the auto-transformer is made by KM1, then contactor KM2 closes and the motor starts under reduced voltage;
- the neutral point is opened by KM1; part of the auto-transformer winding is switched into each phase for a short moment, constituting a stator starting inductance;
- KM3 switches the motor to full mains voltage and causes the auto-transformer to be shunted out of circuit by KM2.

The auto-transformer used generally has an air gap (adjusted or not) in order to obtain, during the second phase of starting, a series inductance whose value is compatible with correct starting.

Operating curves

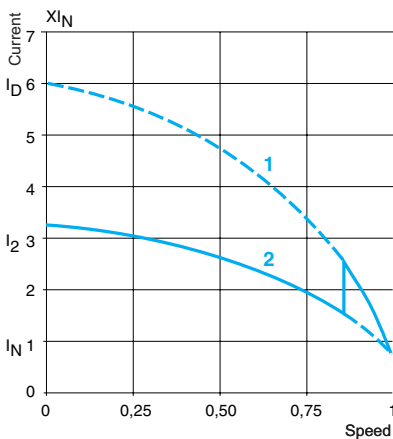

- 1 Direct switching current
- 2 Current with auto-transformer

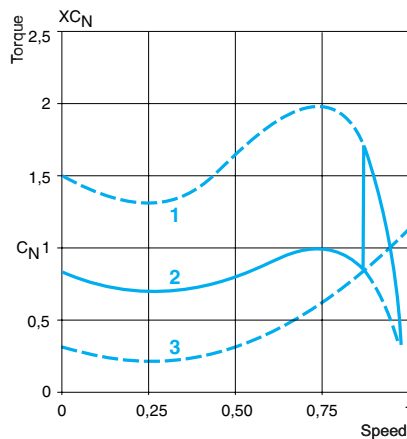

- 1 Direct motor torque
- 2 Torque with auto-transformer
- 3 Resistive torque of the machine

Auto-transformer starters from 59 to 900 kW up to 440 V (type 1 coordination)

The components recommended in the table below have been determined according to the following characteristics:

- auto-transformer: on 0.65 Un connection with non adjusted air gap,
- 3 starts per hour, of which 2 consecutive,
- Motor starting current: Id/In = 6,
- Iq = 70 kA,
- Transient current on closing of KM3 $\leq 7 \sqrt{2} I_n$,
- Maximum starting time: 30 seconds,
- Ambient temperature $\theta \leq 40^\circ\text{C}$.

Switch-disconnector-fuses: operators and accessories, please consult your Regional Sales Office.

Contactors: 3-pole.

LC1 D: see pages 5/62 and 5/65,

LC1 F: please consult your Regional Sales Office,

LC1 B: please consult your Regional Sales Office.

Auxiliary contact blocks:

- for contactors LC1 D: one LAD N11 (1 N/O + 1 N/C) on KM1,
- for contactors LC1 F: one LAD N22 (2 N/O + 2 N/C) on KM1, KM2 and KM3.

Thermal overload relays:

- LRD: see pages 6/20 to 6/25,
- LR9 D: see page 6/23,
- LR9 F: please consult your Regional Sales Office.

Standard power ratings of 3-phase motors 50/60 Hz in category AC-3					Switch-disconnector-fuse Reference	aM fuses		Contactors			Overload relays	
220/230 V	380/400 V	415 V	440 V	In max		Size	Rating	KM3 LC1	KM2 LC1	KM1 LC1	Reference (1)	Setting range
kW	kW	kW	kW	A		A						A
30	55	59	59	105	GS● K	22 x 58	125	D115	D115	D3210	LR9 D5369 LRD 4367	90...150 95...120
40	75	80	80	138	GS● L	T0	160	D150	D115	D5011	LR9 D5369 LRD 4369	90...150 110...140
51	90	90	100	170	GS● N	T1	200	F185	D115	D5011	LR9 F5371	132...220
63	110	110	110	205	GS● N	T1	250	F225	D150	D8011	LR9 F5371	132...220
75	132	132	150	245	GS● N	T1	250	F265	F185	D115	LR9 F5375	200...330
90	160	160	185	300	GS● QQ	T2	315	F330	F265	D115	LR9 F5375	200...330
110	200	200	220	370	GS● QQ	T2	400	F400	F330	D115	LR9 F5379	300...500
140	250	257	280	460	GS2 S	T3	500	F500	F400	D115	LR9 F5379	300...500
180	315	355	375	584	GS2 S	T3	630	F630	F400	D185	LR9 F5381	380...630
200	355	375	400	635	GS2 V	T4	800	F800	F500	F185	TC800/1 + LRD 05	505...800
220	400	425	450	710	GS2 V	T4	800	F800	F500	F265	TC800/1 + LRD 05	505...800
250	450	475	500	800	GS2 V	T4	800	F800	F500	F265	TC1000/1 + LRD 05	630...1000
280	500	530	560	900	GS2 V	T4	1000	BM33●22	F630	F330	TC1000/1 LRD 05	630...1000
315	560	600	630	1000	GS2 V	T4	1000	BM33●22	F630	F400	TC1250/1 LRD 05	790...1250
335	630	670	710	1100	GS2 V	T4	1250	BP33●22	F630	F400	TC1250/1 LRD 05	790...1250
400	710	750	800	1260	On base	T4	2 x 800 (2)	BP33●22	F780	F400	TC1500/1 LRD 05	945...1500
450	800	800	800	1450	On base	T4	2 x 800 (2)	BP33●22	F780	F400	TC1750/1 LRD 05	100...1750
500	900	900	900	1600	On base	T4	2 x 800 (2)	BR33●22	F780	F500	TC2000/1 LRD 05	260...2000

(1) For power ratings greater than or equal to 400 kW at 415 V, use one LRD-05 on the current transformer.

(2) Check with the motor manufacturer whether the fuses should be fitted in parallel.

TeSys contactors

For rotor circuits of slip-ring motors

Applications

These contactors are used to eliminate starting resistance in the rotor circuit of slip-ring motors.

The most common application is for starters without inching and without rotor speed adjustment: pumps, fans, conveyors, compressors, ...

In the case of control by means of a manually operated master controller, the use of contactors with magnetic blow-out is recommended. Please consult your Regional Sales Office.

For hoisting applications, contactor selection must take into account the type of motor duty, the operating rate, the rotor voltage and current, the type of connection, the ambient temperature, etc.
Please consult your Regional Sales Office.

Operation

The rotor circuit contactors are interlocked with the stator contactor and therefore do not open until after the stator contactor has opened, when the rotor voltage has disappeared, or virtually disappeared.

They make the current corresponding to the normal starting peak (1.5 to 2.5 times the rated rotor current) and open the circuit under no-load. Making and breaking are easy.

Different types of rotor connection

Star connection

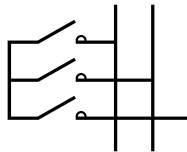

Delta connection

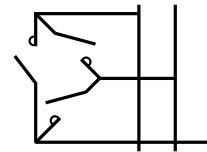

'V' connection

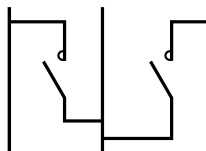

'W' connection

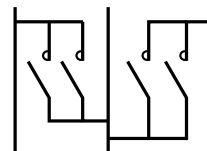

Contactor selection according to the type of connection

Rotor current and voltage coefficients

Coefficients to be applied to the operational current values shown in the table below.

Type of connection	Rotor I coefficient	3-phase rotor U _e (1)			
		Maximum		With counter-current	
	Operational I	LC1 F	LC1 B	LC1 F	LC1 B
Star	1	2000 V	2000 V	1000 V	1000 V
Delta	1.4	1700 V	1700 V	850 V	850 V
In V	1	1700 V	1700 V	850 V	850 V
In W	1.6	1700 V	1700 V	850 V	850 V

Selection according to the operational current

The selection examples below take into account:

- a ratio of 2 between the maximum operational rotor voltage (U_{er}) and the rated stator operational voltage (U_{es}). This ratio is given in standard IEC 60947-4,
- a guarantee of occasional duty (making and breaking capacities) specified in the above standards.

Time current flowing	Contactor rating											
	LC1 D150	LC1 F185	LC1 F265	LC1 F400	LC1 F500	LC1 F630	LC1 F780	LC1 BL	LC1 BM	LC1 BP	LC1 BR	
Intermediate contactor: with number of operating cycles ≤ 30/h												
10 s	450 A	550 A	800 A	1100 A	1500 A	2000 A	2500 A	2000 A	2400 A	3750 A	5000 A	
30 s	280 A	400 A	550 A	730 A	1000 A	1500 A	2000 A	1200 A	1800 A	2600 A	3600 A	
60 s	220 A	300 A	400 A	550 A	750 A	1200 A	1500 A	1000 A	1500 A	2200 A	3000 A	
Intermediate contactor: with number of operating cycles ≤ 60/h												
5 s	450 A	550 A	800 A	1100 A	1500 A	2000 A	2500 A	2000 A	2400 A	3750 A	5000 A	
10 s	330 A	450 A	620 A	860 A	1250 A	1800 A	2300 A	1600 A	2200 A	3400 A	4500 A	
30 s	220 A	300 A	400 A	550 A	750 A	1200 A	1500 A	1000 A	1500 A	2200 A	3000 A	
Intermediate contactor: with number of operating cycles ≤ 150/h for LC1 F and 120/h for LC1 B												
5 s	300 A	420 A	580 A	820 A	1150 A	1650 A	2200 A	1500 A	2100 A	3200 A	4200 A	
10 s	250 A	350 A	430 A	600 A	850 A	1300 A	1600 A	1100 A	1600 A	2300 A	3200 A	
Rotor short-circuit contactor and intermediate contactor: with number of operating cycles > 150/h for LC1 F and 120/h for LC1 B												
–	200 A	270 A	350 A	500 A	700 A	1000 A	1600 A	800 A	1250 A	2000 A	2750 A	

Electrical durability

For automatic starting, the electrical durability is in the region of 1 million operating cycles.

(1) For use up to 3000 V, please consult your Regional Sales Office.



Voltage drop caused by the inrush current

When the operating coil of a contactor is energised, the inrush current produces a voltage drop in the control circuit cable caused by the resistance of the conductors, which can adversely affect closing of the contactor.

An excessive voltage drop in the control supply cables (both a.c. and d.c.) can lead to non closure of the contactor poles or even destruction of the coil due to overheating.

This phenomenon is aggravated by:

- a long line,
- a low control circuit voltage,
- a cable with a small c.s.a.,
- a high inrush power drawn by the coil.

The maximum length of cable, depending on the control voltage, the inrush power and the conductor c.s.a., is indicated in the graphs below.

Remedial action

To reduce the voltage drop at switch-on:

- increase the conductor c.s.a.,
- use a higher control circuit voltage,
- use an intermediate control relay.

Selection of conductor c.s.a.

These graphs are for a maximum line voltage drop of 5%. They give a direct indication of the copper conductor c.s.a. to be used for the control cable, depending on its length, the inrush power drawn by the contactor coil and the control circuit voltage (see example page 5/223).

Total resistance of the 2 conductors in the control cable in Ω (1)

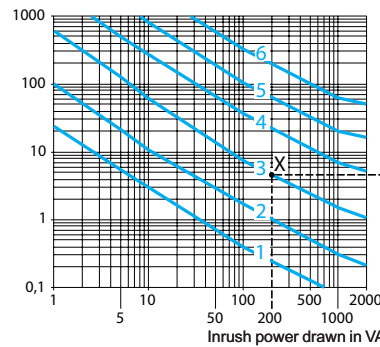

1 ~ 24 V	3 ~ 115 V	5 ~ 400 V
2 ~ 48 V	4 ~ 230 V	6 ~ 690 V

Total resistance of the 2 conductors in the control cable in Ω (1)

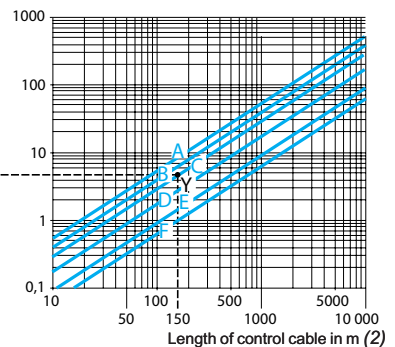

C.s.a. of copper cables

A 0.75 mm ²	C 1.5 mm ²	E 4 mm ²
B 1 mm ²	D 2.5 mm ²	F 6 mm ²

Total resistance of the 2 conductors in the control cable in Ω (1)

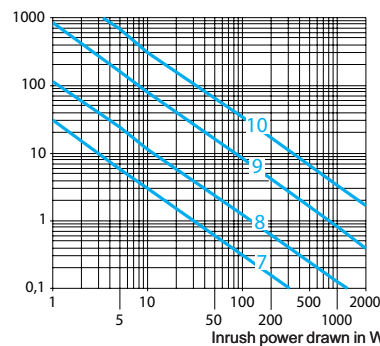

7 ~ 24 V	9 ~ 125 V
8 ~ 48 V	10 ~ 250 V

Total resistance of the 2 conductors in the control cable in Ω (1)

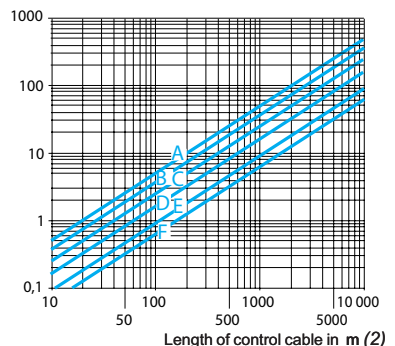

C.s.a. of copper cables

A 0.75 mm ²	C 1.5 mm ²	E 4 mm ²
B 1 mm ²	D 2.5 mm ²	F 6 mm ²

(1) For 3-wire control, the current only flows in 2 of the conductors.

(2) This is the length of the cable comprising 2 or 3 conductors. (Distance between the contactor and the control device).

Voltage drop caused by the inrush current (continued)

What cable c.s.a. is required for the control circuit of an LC1 D40A, 115 V contactor, operated from a distance of 150 metres?

- Contactor LC1 D40A, voltage 115 V, 50 Hz: inrush power: 200 VA

On the left-hand graph on the page opposite, point X is at the intersection of the vertical line corresponding to 200 VA and the ~ 115 V voltage curve.

On the right-hand graph on the page opposite, point Y is at the intersection of the vertical line corresponding to 150 m and the horizontal line passing through point X.

Use the conductor c.s.a. indicated by the curve which passes through point Y, i.e.: 1.5 mm².

If point Y lies between two c.s.a. curves, choose the larger of the c.s.a. values.

Calculating the maximum cable length

The maximum permissible length for acceptable line voltage drop is calculated by the formula:

$$L = \frac{U^2}{SA} \cdot s \cdot K$$

where:

L : distance between the contactor and the control device in m (length of the cable),

U : supply voltage in V,

SA : apparent inrush power drawn by the coil in VA,

s : conductor c.s.a. in mm²,

K : factor given in the table below.

a.c. supply	SA in VA	20	40	100	150	200
	K	1.38	1.5	1.8	2	2.15
d.c. supply	Irrespective of the apparent inrush power SA, expressed in W					
	K = 1.38					

Residual current in the coil due to cable capacitance

When the control contact of a contactor is opened, the control cable capacitance is effectively in series with the coil of the electromagnet. This capacitance can cause a residual current to be maintained in the coil, with the risk that the contactor will remain closed.

This only applies to contactors operating on an a.c. supply.

This phenomenon is aggravated by:

- a long line length between the coil control contact and the contactor, or between the coil control contact and the power supply,
- a high control circuit voltage,
- a low coil consumption, sealed,
- a low value of contactor drop-out voltage.

The maximum control cable length, according to the contactor coil supply voltage, is indicated in the graph on the page opposite

Remedial action

Various solutions can be adopted to avoid the risk of the contactor remaining closed due to cable capacitance:

- use a d.c. control voltage, or,
- add a rectifier, connected as shown in the scheme below, but retaining an a.c. operating coil: in this way, rectified a.c. current flows in the control cable.

When calculating the maximum cable length, take the resistance of the conductors into account.

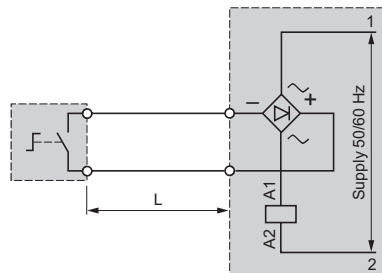

- Connect a resistor in parallel with the contactor coil (1).

Value of the resistance :

$$R \Omega = \frac{1}{10^{-3} C (\mu F)} \quad (C \text{ capacitance of the control cable})$$

Power to be dissipated :

$$PW = \frac{U^2}{R}$$

(1) To avoid increasing the voltage drop due to inrush current, this resistor must be brought into operation after the contactor has closed by using an N/O contact.

Residual current in the coil due to cable capacitance (continued)

These graphs are for a capacitance, between 2 conductors, of 0.2 µF/km. They make it possible to determine whether there is a risk of the contactor remaining closed due to the power drawn by the coil when sealed, as well as the control circuit voltage, according to the length of the control cable.

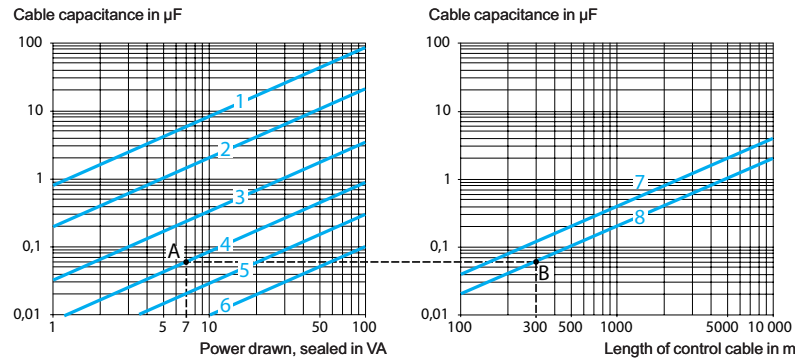

1 ~ 24 V	3 ~ 115 V	5 ~ 400 V	7 3-wire control
2 ~ 48 V	4 ~ 230 V	6 ~ 690 V	8 2-wire control

In the zones below the straight lines for 3-wire and 2-wire control respectively, there is a risk of the contactor remaining closed.

Examples

What is the maximum length for the control cable of an LC1 D12 contactor, operating on 230 V, with 2-wire control?

- Contactor LC1 D12, voltage 230 V, 50 Hz: power sealed 7 VA.

On the left-hand graph, point A is at the intersection of the vertical line for 7 VA with the ~ 230 V voltage curve.

On the right-hand graph, point B is at the intersection of the horizontal line with the 2-wire control curve.

The maximum cable length is therefore 300 m.

In the same example, with a 600 m cable, the point lies in the risk zone. A resistor must therefore be connected in parallel with the contactor coil.

Value of this resistance :

$$R = \frac{1}{10^{-3} \cdot C} = \frac{1}{10^{-3} \cdot 0.12} = 8.3 \Omega$$

Power to be dissipated :

$$P = \frac{U^2}{R} = \frac{(220)^2}{8300} = 6 \text{ W}$$

Alternative solution: use a d.c. control supply.

Calculating the cable length

The maximum permitted length of control cable to avoid the effects of capacitance is calculated using the formula:

$$L = 455 \cdot \frac{S}{U^2 \cdot Co}$$

L : distance between the contactor and the control device in km (length of the cable),

S : apparent power, sealed, in VA,

U : control voltage in V,

Co : line capacitance of the cable in µF/km.

TeSys contactors

Variable composition standard and high performance contactors

Applications

- Motor switching in categories AC-3
- Resistive load switching : heating, etc.
- Distribution circuit switching : line contactor
- Supply changeover switching : circuit coupling etc
- Transformer, capacitor, lighting switching



Type

Rated operational current	AC-3
	AC-4/DC-5
	AC-1

Rated operational voltage

Control circuit

Standard contactors

80 A	170 A	250 A	350 A	460 A	700 A
72 A/–	145 A/–	205 A/–	290/470 A (1)	380/630 A (1)	584/1000 A (1)
80 A	200 A	300 A	470 A	630 A	1000 A
690 V ~	690 V ~	690 V ~	690 V ~	690 V ~	690 V ~

Standard applications

a.c. supply ~



d.c. supply ⋯

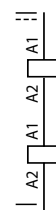

Contactors

Type

Rating

CV1

F	G	H	J	K	L
---	---	---	---	---	---

Pages

Please consult our catalogue "TeSys variable composition contactors".

(1) With PN3 poles.

- Motor switching in categories AC-4, DC-5
- Inductive circuit switching
- High voltage d.c. switching : crane electromagnets, railway locomotives
- Load switching at high operating rates

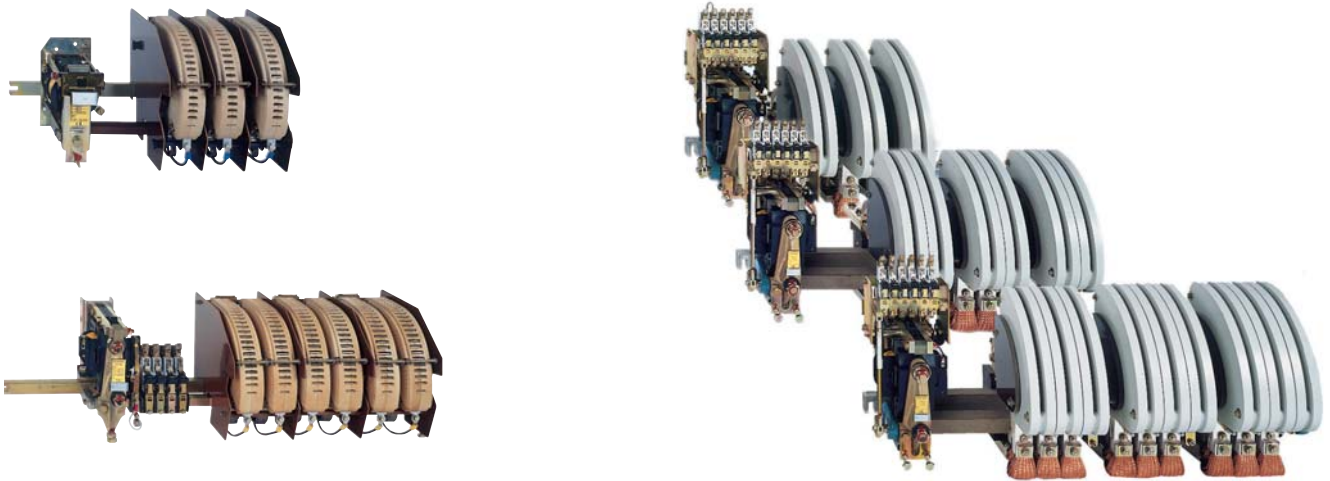

High performance contactors

80 A	200 A	250 A	320 A	460 A	800 A	1000 A	1500 A	1800 A
80/80 A	170/200 A	208/300 A	250/320 A	380/500 A	720/800 A	830/1000 A	1200/1800 A	1500/2500 A
80A	200 A	300 A	320 A	500 A	800 A	1250 A	2000 A	2750 A
1000 V ~	1000 V ~	1000 V ~	1000 V ~	1000 V ~	1000 V ~	1000 V ~	1000 V ~	1000 V ~

Low consumption applications
a.c. supply via economy resistor

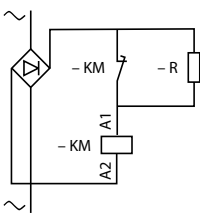

d.c. supply via economy resistor

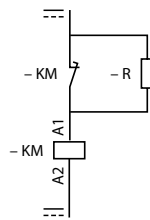

CV3

F	G	H	J	K
---	---	---	---	---

CV3 and LC1 B

L	M	P	R
---	---	---	---

5

TeSys contactors

Variable composition contactors

CV1 B (80 to 1000 A) and CV3 B (80 to 500 A)

Selection

To define a contactor

The criteria required to define the composition of a contactor are:

- the number of N/O and N/C power poles,
- the current and power supply voltage,
(note: on a d.c. supply, the time constant $\frac{L}{R}$ of the load must be known in order to define the number of poles to be wired in series to break the arc),
- the control circuit voltage,
- the number of auxiliary contacts.

To order a contactor

Contactor selectable by code combinations

- Use the symbol combination table on page 5/229.
- Check the maximum number of poles in the selection table on page 5/230.
- Check the operational currents possible below (selection restrictions).

Contactor not selectable by code combinations

- For a composition that cannot be selected using these tables, use order form CF 452, page 5/231.

Selection restrictions

Contactor type		CV1 BF CV3 BF	CV1 BG CV3 BG	CV1 BH CV3 BH	CV1 BJ CV3 BJ	CV1 BK CV3 BK	CV1 BL
Rated operational current	11 A	E	–	–	–	–	–
	13 A	M	–	–	–	–	–
	20 A	N	–	–	–	–	–
	40 A	P	–	–	–	–	–
	50 A	Q	Q	–	–	–	–
	80 A	F	–	–	–	–	–
	125 A	–	R	R	–	–	–
	200 A	–	G	G	–	–	–
	250 A	–	–	–	S	–	–
	300 A	–	–	H	–	–	–
	320 A	–	–	–	T	–	–
	400 A	–	–	–	–	U	–
	470 A	–	–	–	J	–	–
	500 A	–	–	–	–	V	–
	630 A	–	–	–	–	K	K
	1000 A	–	–	–	–	–	L
	0 Without arc chamber	Z	Z	Z	Z	Z	Z

Reference to be constituted (see examples on page 5/230)									
Type of contactor related to application									
~ 690 V, --- 220 V/pole		CV1 B							
~ 1000 V, --- 440 V/pole		CV3 B							
Contactor size AC-1/AC-3									
CV1 : 80/80 A	CV3 : 80/80 A	F							
CV1 : 200/170 A	CV3 : 200/200 A	G							
CV1 : 300/250 A	CV3 : 300/285 A	H							
CV1 : 470/350 A	CV3 : 320/320 A	J							
CV1 : 630/460 A	CV3 : 500/460 A	K							
CV1 : 1000/700 A		L							
Number of poles									
N/O poles	1 N/O		1						
	2 N/O		2						
	3 N/O		3						
	4 N/O		4						
	5 N/O		5						
N/C poles	1 N/C			1					
	2 N/C			2					
	3 N/C			3					
No main poles		0	Z	0	Z				
Operational current (determines the blow-out coil size)									
11 A			E		E				
13 A			M		M				
20 A			N		N				
40 A			P		P				
50 A			Q		Q				
80 A			F		F				
125 A			R		R				
200 A			G		G				
250 A			S		S				
300 A			H		H				
320 A			T		T				
400 A			U		U				
470 A			J		J				
500 A			V		V				
630 A			K		K				
1000 A			L		L				
Without breaking			Z		Z				
Control circuit voltage									
24 V						B			
48 V						E			
110 V						F			
120 V						K			
127 V						G			
208 V						L			
220 V						M			
230 V						P			
240 V						U			
380 V						Q			
400 V						V			
415 V						N			
440 V						R			
480 V						T			
500 V						S			
600 V						X			
Operating frequency									
50 Hz							5		
60 Hz							6		
50/60 Hz (rectifier + economy resistor)							7		
---							D		
--- + economy resistor							R		
Auxiliary contacts (type ZC4 GM)									
N/O instantaneous	1 N/O							1	
	2 N/O							2	
	3 N/O							3	
	4 N/O							4	
N/C instantaneous	1 N/C								1
	2 N/C								2
	3 N/C								3
	4 N/C								4
No instantaneous auxiliary contacts							0	0	
On-delay	1 C/O								J
Off-delay	1 C/O								N

To check whether the symbol combinations are possible, refer to the selection information and guide on pages 5/228 and 5/230.
If in doubt, fill out order form CF 452.

TeSys contactors

Variable composition contactors
CV1 B (80 to 1000 A) and CV3 B (80 to 500 A)

Guide to selection of code combinations												
CV1 contactors: maximum number of power poles												
Contactor type	CV1 BF		CV1 BG		CV1 BH		CV1 BJ		CV1 BK		CV1 BL	
Pole type	N/O	N/C	N/O	N/C	N/O	N/C	N/O	N/C	N/O	N/C	N/O	N/C
Number of poles	5	0	4	0	4	0	4	0	4	0	2	0 (1)
	0	2	0	2	0	2	0	2	0	2	0	1 (2)
	2	1	2	1	2	1	2	1	2	1	-	-

CV3 contactors: maximum number of power poles										
Contactor type	CV3 BF		CV3 BG		CV3 BH		CV3 BJ		CV3 BK	
Pole type	N/O	N/C	N/O	N/C	N/O	N/C	N/O	N/C	N/O	N/C
Number of poles	5	0	4	0	4	0	2	0	2	0
	0	2	0	2	0	2	-	-	-	-
	1	2	1	2	-	-	-	-	-	-
	3	1	2	1	2	1	-	-	-	-

CV1 or CV3 contactors:
Maximum number of auxiliary contacts: 4 + 1 time delay if necessary

Selection restrictions, according to coil type:

- (1) 4-pole with economy resistor.
- (2) 2-pole with economy resistor.

Examples

- Switching of single-phase capacitor: 400 V - 80 A - 1 N/O main pole. 220 V / 50 Hz control circuit voltage, 1 N/O and 1 N/C auxiliary contacts.
Reference: **CV1 BF1F0ZM511**.
- Switching of d.c. heating circuits: 800 V - 150 A - 2 N/O main poles - 48 V $\overline{\text{---}}$ control circuit, instantaneous auxiliary contact 1 N/O + 1 on-delay.
Reference: **CV3 BG2W0ZED10J**.

Other versions

To obtain a composition with more main poles or with more than 4 auxiliary contacts, please use **order form CF 452** (see page 5/231).

Date of order <input style="width:100%;" type="text"/>	Editor Geog. area <input style="width:100%;" type="text"/>	Order n° <input style="width:100%;" type="text"/>	Required delivery (1) <input style="width:100%;" type="text"/>	Job n° <input style="width:100%;" type="text"/>
Company:			Customer Order N°:	
Activity sector:			Application:	

Number of contactors: Type - size or symbol combination:

For devices with symbol combination: Do not fill out the form below

POWER CIRCUIT

Voltage: V AC Hz
DC

Number of N/O main poles: Rated current: Amp
Number of N/C main poles: Rated current: Amp

Any special details:

CONTROL CIRCUIT

Voltage: V AC Hz
DC

Economy resistor: Yes No
(unless specified, an economy resistor will only be included if necessary)

Customer marking:

AUXILIARY CONTACTS AVAILABLE

Instantaneous contacts:	Number of N/O	Number of N/C
-------------------------	---------------	---------------

If a specific type or block of contacts is required, please indicate below.

Number GM1: GM2: GP4: GP5: GP6: LA1:

Note : For mechanical interlocking, a N/C contact must be specified for the interlocking function.

Time delay contacts N/C + N/O : On delay or Off delay

Note: If LA1 is used, a build specification is required.

MOUNTING

Fixing centres L: Standard Specified With L =

Mechanical interlock "MI":
Yes No

Vertically mounted reversers fixing centres "E" = mm
Upper position contactor: Lower position contactor:

If mechanical interlock specified : Ref:

Supply linking components for the 2 contactors (Rod, clevis, cranks, lock, etc...): Yes No

Note : "MI" components that are part of the contactor such as the bearing, clevis or lock support are factory fitted.

ANY SPECIAL DETAILS (Comments / Specific requirements / Special "MI" / Accessories / Etc...)

.....

.....

.....

.....

.....

.....

.....

.....

.....

.....

For use by Schneider Electric

Poles

Ref: _____
Ref: _____

Electromag: _____
Coil: _____
Coil maint. cont: _____
Rectifier: _____
Econ. resist. contact: _____
Econ. Resist.: _____

No. ZC4GM1 : (N/O)
No. ZC4GM2 : (N/C)
No. ZC1GP4 : (N/C)
No. ZC1GP5 : (N/C+N/O)
No. ZC1GP6 : (N/O+N/O)
No. ZC2GG1 : (ON-Del)
No. ZC2GG5 : (OFF-Del)

No. LA1BN●31 : _____
No. LA1DN●● : _____
No. LA●DT● : _____
If CV1, specif. n°: _____

Shaft: C or E = _____
Code.: _____
Bar: L = : _____
Code.: _____
Build see drwg.
N° : _____
"MI" bearing
W1 _____
"MI" ref _____

Launch date

Delivery date

Contactor reference*
.....

* 3 possibilities

1) Device with symbol combination (see drwg 1492177)
2) Device n° defined on the basis of this form
Type/size/order n°/year. E.g.: CV1GB000599
3) Reference defined to "specification"



(1) Standard delivery time: 3 weeks, from receipt of order. For faster delivery, please consult your Regional Sales Office.

Selection

Contactor size		LC1 V160	LC1 V320	LC1 V610
For utilisation category AC-3				
Maximum operational current in AC-3	A	160	320	610
Rated operational power P (standard power ratings of motors)	230 V kW	45	90	160
	400 V kW	75	160	300
	525 V kW	110	220	400
	690 V kW	150	280	560
	1000 V kW	200	400	800
	1500 V kW	280	600	930
For 3-phase motors conforming to CSA standards				
Rated operational power P (standard power ratings of 3-phase CSA motors)	200 V hp	50	100	150
	240 V hp	60	125	200
	380 V hp	100	200	300
	480 V hp	125	250	400
	600 V hp	150	300	500
	800 V hp	200	400	700
	1000 V hp	250	500	1000
	1500 V hp	400	800	1300
For switching 3-phase capacitors				
Rated operational power P	240 V kVAR	47	94	176
	480 V kVAR	95	190	356
	600 V kVAR	100	200	400
	1500 V kVAR	250	500	1000
For switching the primaries of 3-phase transformers (LV/LV)				
Rated operational power P	208 V kVA	20	41	81
	240 V kVA	23	47	94
	480 V kVA	47	94	188
	600 V kVA	59	117	234

Environment characteristics

Contactor type			LC1 V160	LC1 V320	LC1 V610
Shock resistance (1/2 sine wave = 11 ms)	Contacts closed		10 gn	10 gn	10 gn
	Contacts open		10 gn	10 gn	10 gn
Vibration resistance	10...500 Hz		2 gn	2 gn	2 gn
Operating altitude	Above sea level	Maximum	m 3600	3600	3600
	Below sea level	Minimum	m 2500	4500	4500
Ambient air temperature around the device	Storage	°C	- 40...+ 80	- 40...+ 80	- 40...+ 80
	Operation 0.8... 1.1 Uc	°C	- 5...+ 55	- 5...+ 55	- 5...+ 55
	Permissible for operation at Uc	°C	- 10...+ 75	- 10...+ 75	- 10...+ 75
Degree of protection	Conforming to IEC 60529		IP 00	IP 00	IP 00
Operating position			Any	Any	Any
Cabling	Cable c.s.a.	mm²	70	185	2 x 185
	Key for hex. screws	mm	Allen 4	20	20
	Tightening torque	N.m	14	39	39

Control circuit characteristics

Rated insulation voltage (Ui)	To earth	V	2000	2000	2000
Consumption	Inrush	VA	300	600	1700
	Sealed	VA	30	20	28
Permissible control circuit voltage			0.8...1.1 Uc	0.8...1.1 Uc	0.8...1.1 Uc
Closing time (1)		ms	18...22	24...32	24...32
Opening time (1)		ms	95...115	95...115	95...115

(1) The closing time "C" is measured from the moment the coil supply is switched on to initial contact of the main poles. The opening time "O" is measured from the moment the coil supply is switched off to the moment the main poles separate.

Contactor type		LC1 V160	LC1 V320	LC1 V610	
Main pole characteristics					
Rated insulation voltage (Ui)	V	1500	1500	1500	
Rated impulse withstand voltage (Uimp)	kV	8	8	8	
Conforming to standards		EN 60947-4-1 - IEC 60947-4-1			
Approvals		CSA			
Conventional rated thermal current (Ith)	A	160	320	630	
Rated operational current (Ie)	$\theta \leq 40$ °C AC-1	A	160	320	630
	$\theta \leq 55$ °C AC-3	A	160	320	610
	$\theta \leq 55$ °C AC-4	A	130	270	540
Electrical durability in millions of operating cycles (400 V at I max)	AC-1		1.2	1	1
	AC-3		1.6	1.5	1.5
	AC-4		0.18	0.15	0.12
Mechanical durability	In millions of operating cycles		5	2.5	2
Maximum operating rate in operating cycles per hour	Mechanical		1200	1200	1200
	AC-1		900	900	900
	AC-3		900	900	900
	AC-4		450	450	450
Maximum making capacity (I _{ms})	Ue = 1500 V To IEC 60947	A	1900	3800	7300
Maximum breaking capacity (I _{bs})	Ue = 1500 V To IEC 60947	A	1600	3200	6100
Maximum permissible current	For 1 s	A	2400	4500	9000
	For 2 s	A	2000	3750	7580
	For 10 s	A	1600	3200	6100
	For 30 s	A	960	1920	3600
Short-circuit protection at Ie in cat. AC-3 max.	aM fuse	A	160	400	630
Auxiliary contact characteristics					
Rated insulation voltage (Ui)	V	690			
Conventional rated thermal current (Ith)	A	10			
Rated operational current (Ie)	AC-15, 230 V	A	0.78		
	AC-15, 400 V	A	0.45		
	AC-15, 500 V	A	0.35		
	DC-13, 24 V	A	1.1		
	DC-13, 110 V	A	0.24		
	DC-13, 220 V	A	0.12		
Cabling	Cable c.s.a.	mm ²	2.5		
Short-circuit protection	gG fuse	A	10		
Operating time (1) (at 100 % of Uc)	"C"	ms	± 5		
	"O"	ms	± 5		

(1) Operating time in relation to the main contacts.

TeSys contactors

3-pole vacuum contactors and reversing contactors

Power and control circuits
a.c. supply



LC1 V320

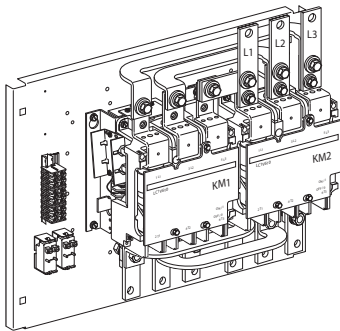

LC2 V610

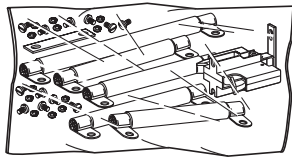

LA9 V974

5

Vacuum contactors

Standard power ratings 50/60 Hz in category AC-3					Rated operational current I _e	Instan- taneous auxiliary contacts	Control circuit voltage (50/60 Hz)	Basic reference (1)	Weight	
230 V	400 V	525 V	690 V	1000 V	AC-3	AC-1			kg	
kW	kW	kW	kW	kW	A	A				
45	75	110	150	200	160	160	2	1 (1)	LC1 V160●●	3.800
90	160	220	280	400	320	320	1	1 (1)	LC1 V320●●	10.500
160	300	400	560	800	610	630	1	1 (1)	LC1 V610●●	13.000

Reversing vacuum contactors

The reversing contactor range comprises :

- for 160 A rating, a kit with set of power connections allowing assembly of the starter,
- for 320 and 610 A ratings, a complete starter, ready for use.

Standard power ratings 50/60 Hz in category AC-3					Rated operational current I _e	Instan- taneous auxiliary contacts	Control circuit voltage (50/60 Hz)	Basic reference (1)	Weight	
230 V	400 V	525 V	690 V	1000 V	AC-3	AC-1			kg	
kW	kW	kW	kW	kW	A	A				
45	75	110	150	200	160	160	2	1 -	LA9 V974 (2)	1.200
90	160	220	280	400	320	320	1	1 110-120 V	LC2 V320FE7	30
								220-240 V	LC2 V320P7	30
								380-415 V	LC2 V320V7	30
160	300	400	560	800	610	630	1	1 110-120 V	LC2 V610FE7	36
								220-240 V	LC2 V610P7	36

(1) Basic reference; add code indicating control circuit voltage.

Standard control circuit voltages :

Volts 50/60 Hz	110...120	220...240	380...415	440...480	550...600
Item	FE7	P7	V7	R7	X7

(2) Kit containing a mechanical interlock, a set of power connections and a fixing plate. To build a complete reversing contactor, order contactors LC1 V160●● separately.



TeSys contactors

3-pole vacuum contactors and reversing contactors

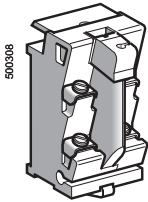
Power and control circuits
a.c. supply



LA1 VN11

Instantaneous auxiliary contact blocks ⁽¹⁾					
Number of contacts	Maximum number of blocks per contactor	Auxiliary contacts		Reference	Weight kg
					
2	4	1	1	LA1 VN11	0.030
		-	2	LA1 VN02	0.030
		2	-	LA1 VN20	0.030
		1	1	LA1 VN11X (2)	0.030

50/60 Hz coils			
Rated voltage V	Voltage code	Reference	Weight kg
For contactors LC1 V160			
110...120	FE7	LX1 V160FE7	0.400
220...240	P7	LX1 V160P7	0.400
380...415	V7	LX1 V160V7	0.400
440...480	R7	LX1 V160R7	0.400
550...600	X7	LX1 V160X7	0.400
For contactors LC1 V320			
110...120	FE7	LX1 V320FE7	0.800
220...240	P7	LX1 V320P7	0.800
380...415	V7	LX1 V320V7	0.800
440...480	R7	LX1 V320R7	0.800
550...600	X7	LX1 V320X7	0.800
For contactors LC1 V610			
110...120	FE7	LX1 V610FE7	0.800
220...240	P7	LX1 V610P7	0.800
380...415	V7	LX1 V610V7	0.800
440...480	R7	LX1 V610R7	0.800
550...600	X7	LX1 V610X7	0.800

(1) LC1 V160 : auxiliary contact blocks mounted at the top of the contactor, with no change to the overall dimensions.

LC1 V320 or LC1 V610 : 2 auxiliary contact blocks mounted on the RH and LH side of the contactor, with no change to the overall dimensions.

(2) For LC1 V160 : 1 N/C contact for the coil + 1 N/O contact.

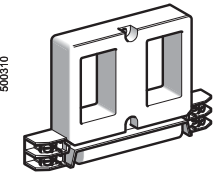

LX1 V320●●

Dimensions, mounting

LC1 V160

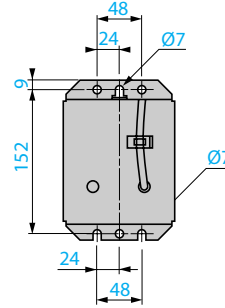
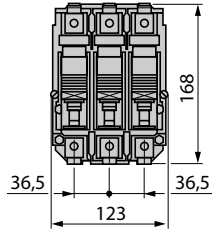
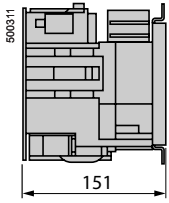

LC1 V320

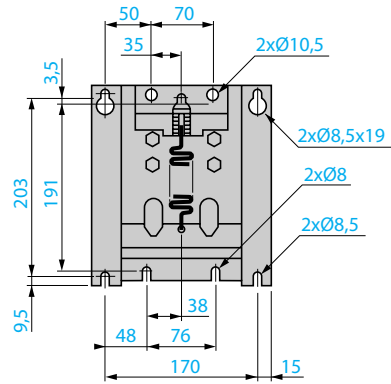
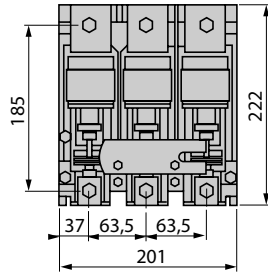
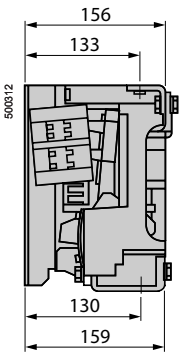

LC1 V610

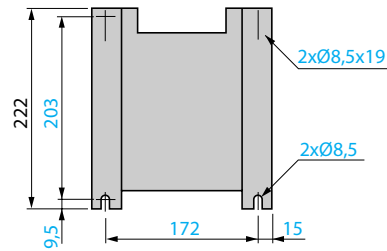
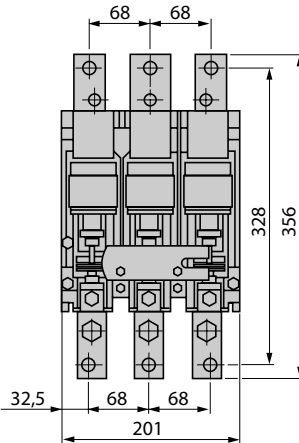
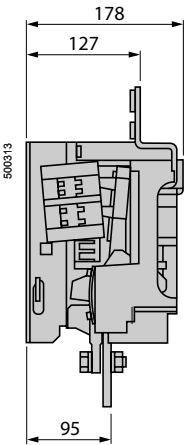

Schemes

LC1 V160

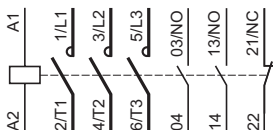

LC1 V320, V610

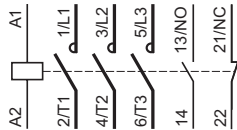

Auxiliary contact blocks

LA1 VN11 1 N/O & 1 N/C

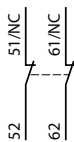
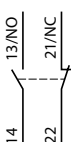

LA1 VN20 2 N/O

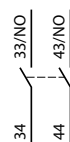

LA1 VN11X 1 N/O

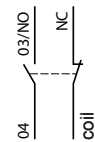

Dimensions, mounting

LA9 V974 + 2 x LC1V160

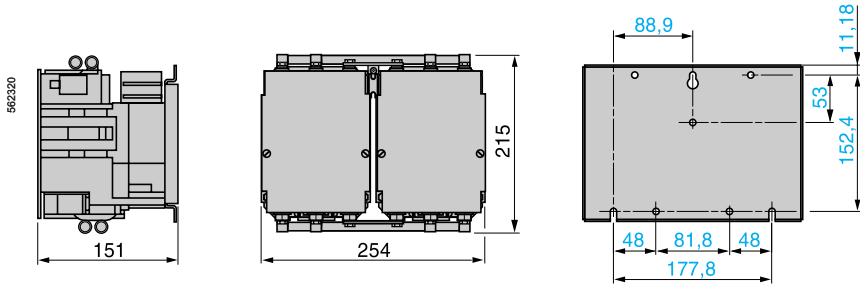

LC2 V320

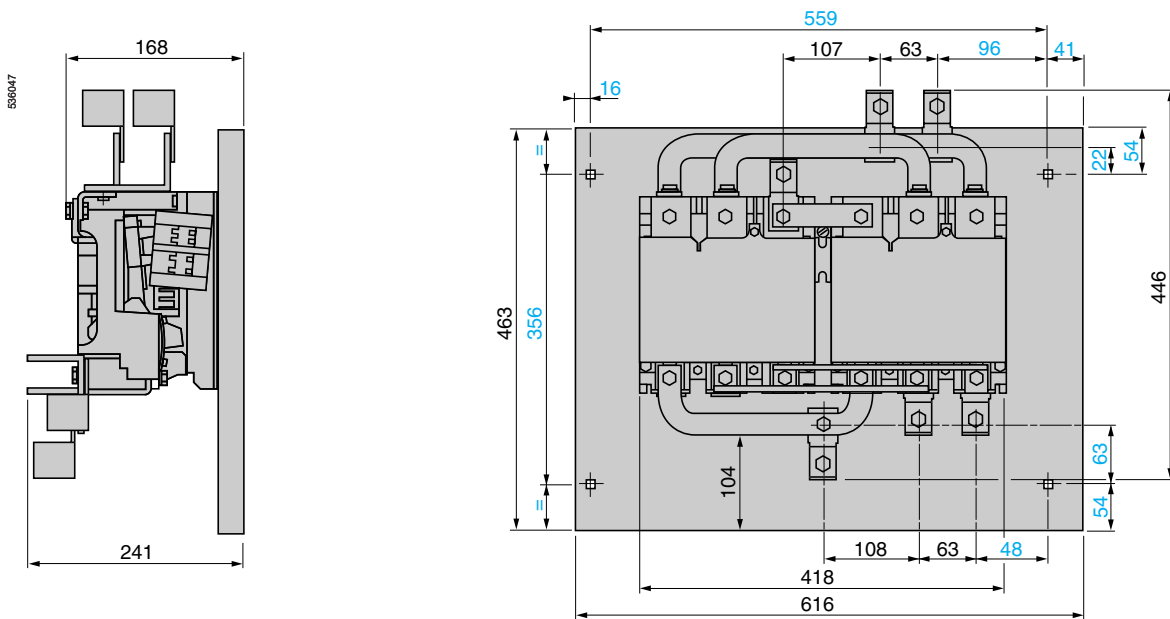

LC2 V610

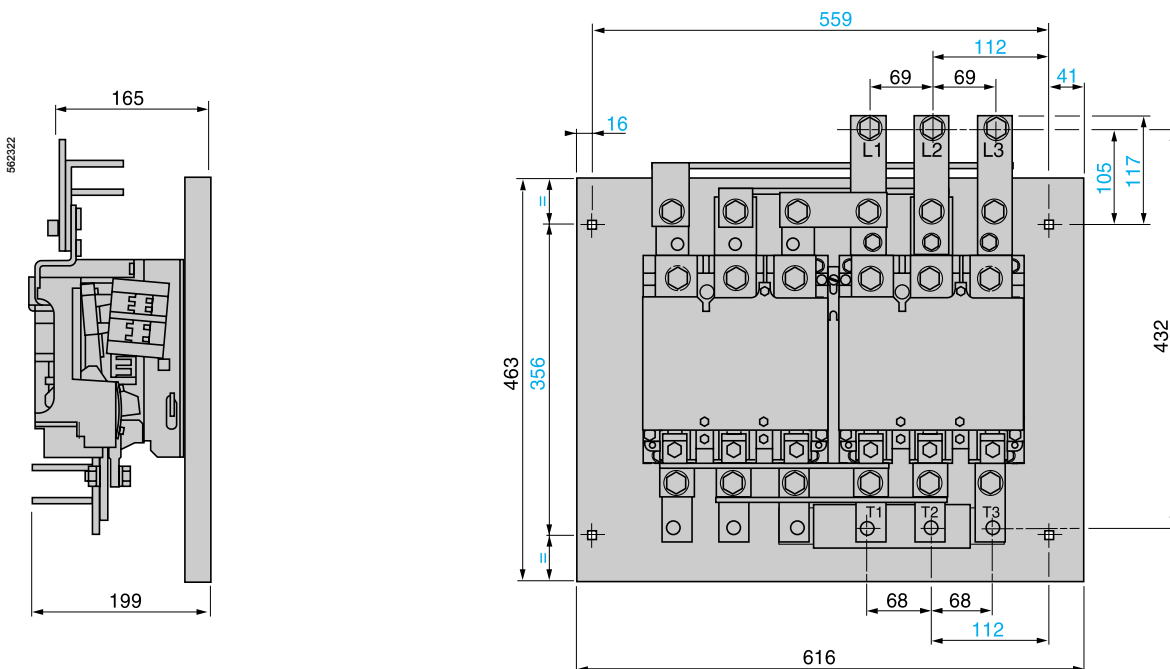

Schemes

LA9 V974 + 2 x LC1V160

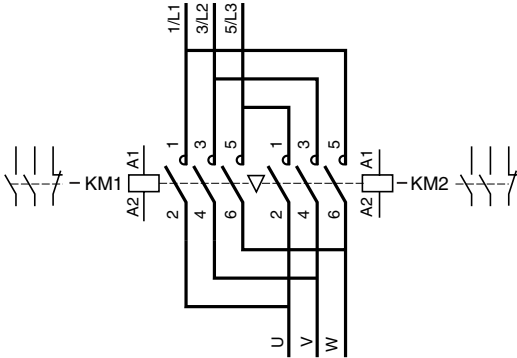

LC2 V320

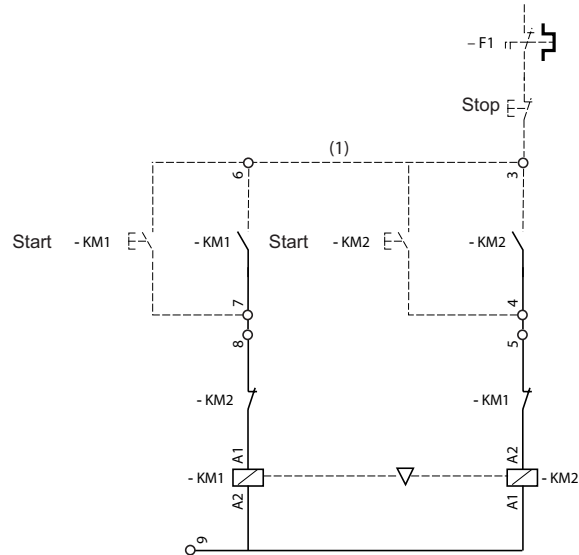
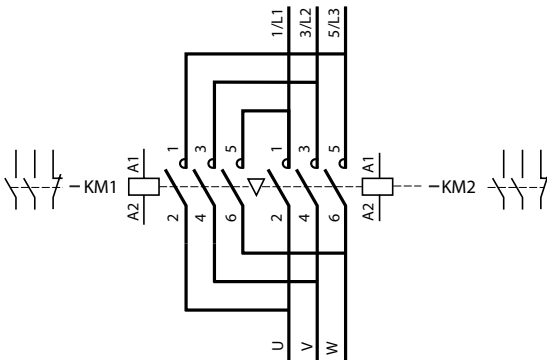

(1) Dotted line indicates wiring to be installed by the customer.

Schemes (continued)

LC2 V610

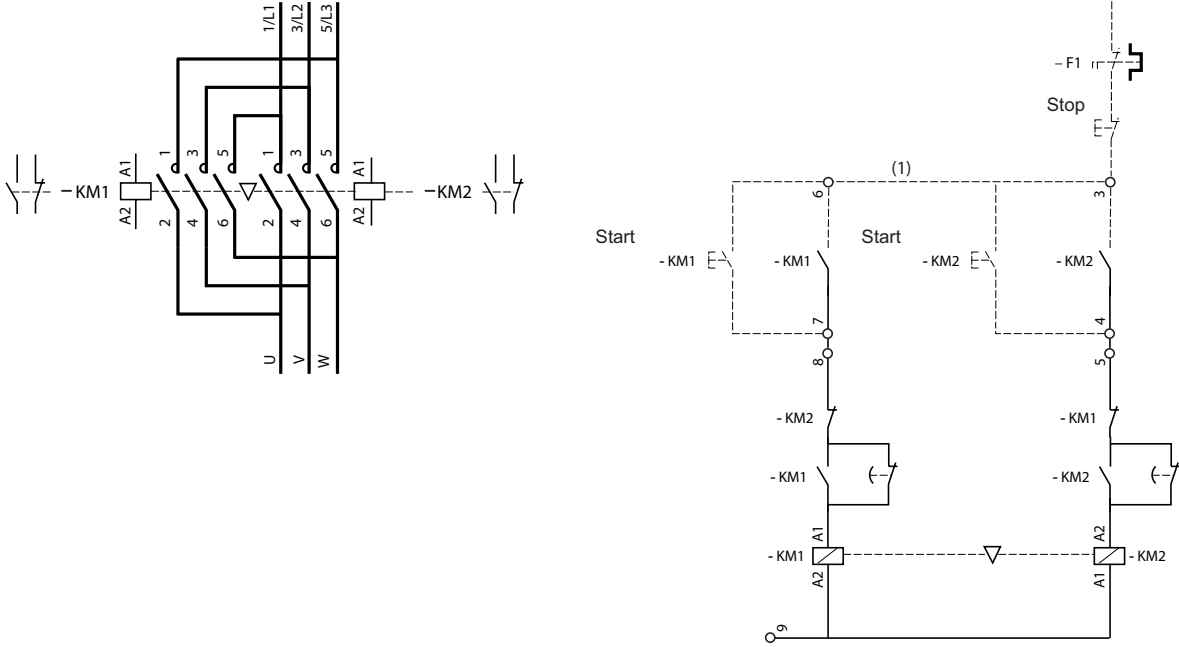

(1) Dotted line indicates wiring to be installed by the customer.

Magnetic latching contactors

Magnetic latching contactors of both block and bar mounted types are fitted with a special electromagnet which enables them to remain in the "On" position when the coil is no longer energised.

Applications

The special properties of magnetic latching contactors make them suitable for a large number of applications.

Properties

- Retention of the sequence memory in automatic control equipment in the event of loss of control voltage.
- Energy saving, since the source of supply to the coil does not need to supply current when the contactor is latched in the closed state.
- Change of state from "Closed" to "Open" by current signal through the coil.
- Unaffected by mains interference.
- Utilisation of contactors beyond their breaking capacity, as operations are performed off-load.
- Contactors are silent in the latched position.

Applications

- Refineries, power stations, excitation circuits.
- Contactors remaining in the closed state for long periods.
Examples: refineries, power supplies, low voltage distribution
- Selective opening control.
- No unwanted opening and closing of the main power poles.
- Current carrying at voltages up to 1000 Volts.

Operation of the electromagnet

CR1 F block contactors

CR1 F magnetic latching contactors are fitted with a double coil with 3 terminals comprising a latching winding and an unlatching winding. The 2 windings have a common point which can necessitate special wiring precautions when the latching supply is separate from the unlatching supply.

The power supplies may be a.c. or d.c. For d.c. operation, the polarities indicated must be complied with.

Operating precautions:

- the 2 windings must not be supplied simultaneously,
- a winding must not be supplied continuously,
- supply to the coils must be via pulsed contacts.

Manual opening:

if the control voltage is not present, the contactor can be unlatched manually.

CR1 B bar mounted contactors

CR1 B magnetic latching contactors are fitted with a single coil, supplied with d.c. or with a.c. through a rectifier.

Latching is obtained by direct supply of the coil in one direction of current flow.

Unlatching is obtained by a reverse current, adjusted by resistors.

Mechanical latching contactors

LC1 D block contactors

For applications using smaller contactor sizes than those described on page 5/241, it is possible to obtain the same function by the addition of a mechanical latch block type LA6 DK, which can be mounted on LC1 D contactors (see page 5/80).

TeSys contactors

Magnetic latching contactors

Selection guide for direct on-line starting of squirrel cage motors

Continuous or intermittent duty up to 30 operating cycles/hour																
Motor (1)												3-pole contactor (2)	3-pole differential thermal overload relay		3 fuses Type	
220 V 230 V			380 V 400 V			415 V			440 V				Reference	Setting range	aM	BS-88
P			In			P			In			Reference	A	Rating		
kW	HP	A	kW	HP	A	kW	HP	A	kW	HP	A			A	A	A
25	35	85	–	–	–	–	–	–	–	–	–	CR1 F150	LR9 F5367	60...100	100	125
30	40	103	51	70	98	55	75	100	59	80	97	CR1 F150	LR9 F5369	90...150	100	160
33	45	113	55	75	105	–	–	–	–	–	–	–	–	–	–	–
–	–	–	59	80	112	59	80	105	63	85	109	CR1 F150	LR9 F5369	90...150	125	160
–	–	–	63	85	117	63	85	115	–	–	–	–	–	–	–	–
37	50	126	75	100	138	75	100	135	75	100	125	CR1 F150	LR9 F5369	90...150	160	200
40	54	134	–	–	–	–	–	–	80	110	131	–	–	–	–	–
45	60	150	80	110	147	80	110	138	90	125	146	CR1 F185	LR9 F5369	90...150	160	200
51	70	170	90	125	170	90	125	165	100	136	162	CR1 F185	LR9 F5371	132...220	200	250
55	75	182	–	–	–	100	136	182	–	–	–	–	–	–	–	–
59	80	195	100	138	188	110	150	200	110	150	178	CR1 F265	LR9 F5371	132...220	250	315
63	85	203	110	150	205	–	–	–	129	175	209	–	–	–	–	–
75	100	240	129	175	242	129	175	230	132	180	215	CR1 F265	LR9 F7375	200...330	250	315
–	–	–	132	180	245	132	180	240	–	–	–	–	–	–	–	–
–	–	–	–	–	–	140	190	250	140	190	227	CR1 F265	LR9 F7375	200...330	315	400
80	110	260	140	190	260	147	200	260	147	200	236	CR1 F400	LR9 F7375	200...330	315	400
–	–	–	147	200	273	150	205	270	150	205	246	–	–	–	–	–
–	–	–	150	205	280	160	220	280	160	220	256	–	–	–	–	–
90	125	295	160	220	300	–	–	–	180	245	289	CR1 F400	LR9 F7375	200...330	315	400
–	–	–	–	–	–	–	–	–	185	250	295	–	–	–	–	–
100	136	325	180	245	333	180	245	320	200	270	321	CR1 F400	LR9 F7379	300...500	400	500
110	150	356	185	250	342	185	250	325	220	300	353	–	–	–	–	–
–	–	–	200	270	370	200	270	340	250	340	401	CR1 F400	LR9 F7379	300...500	400	500
–	–	–	–	–	–	220	300	385	–	–	–	–	–	–	–	–
129	175	420	220	300	408	–	–	–	257	350	412	CR1 F500	LR9 F7379	300...500	500	630
132	180	425	250	340	460	250	340	425	280	380	450	CR1 F500	LR9 F7381	380...630	500	630
140	190	450	–	–	–	257	350	450	–	–	–	–	–	–	–	–
147	200	472	–	–	–	–	–	–	295	400	473	CR1 F500	LR9 F7381	380...630	500	630
–	–	–	257	350	475	280	380	475	300	410	481	CR1 F630	LR9 F7381	380...630	500	630
–	–	–	–	–	–	295	400	500	–	–	–	–	–	–	–	–
150	205	483	280	380	510	300	410	510	315	430	505	CR1 F630	LR9 F7381	380...630	630	800
160	220	520	295	400	546	315	430	535	335	450	518	–	–	–	–	–
180	245	578	300	410	565	335	450	550	355	480	549	CR1 F630	LR9 F7381	380...630	630	800
185	250	595	315	430	584	355	480	580	375	500	575	–	–	–	–	–
200	270	626	335	450	620	375	500	610	400	454	611	CR1 F630	LR9 F7381	380...630	800	1000
220	★	700	355	★	635	400	★	650	425	★	650	CR1 BL33	LR2 F8383	500...800	800	1000
–	–	–	375	★	670	425	★	690	445	★	680	–	–	–	–	–
–	–	–	400	★	710	445	★	730	450	★	690	–	–	–	–	–
–	–	–	–	–	–	450	★	740	475	★	730	–	–	–	–	–
250	★	800	425	★	760	475	★	780	500	★	780	CR1 BM33	LR2 F8383	500...800	800	1000
257	★	826	445	★	790	500	★	820	530	★	825	CR1 BM33	LR2 F8383	630...1000	1000	1250
280	★	900	450	★	800	530	★	870	560	★	870	–	–	–	–	–
295	★	948	475	★	850	560	★	920	600	★	920	–	–	–	–	–
300	★	980	500	★	900	600	★	978	630	★	965	–	–	–	–	–
315	★	990	530	★	950	–	–	–	–	–	–	–	–	–	–	–

(1) The ratings are for standard 220/230 V, 380/400 V, 415 or 440 V motors. The overload relays should preferably be set to the motor full-load current shown on the motor rating plate. For other power ratings, select the overload relay with the appropriate range; the associated contactor and fuses must have ratings equal to or immediately greater than In.

(2) Reference to be completed, see page 5/250.

★ There are no standard power ratings for these motors.

TeSys contactors

Magnetic latching contactors

Selection guide for utilisation category AC-3

Contactor size		CR1 F150	CR1 F185	CR1 F265	CR1 F400	CR1 F500	CR1 F630	CR1 BL	CR1 BM	CR1 BP	CR1 BR
Rated operational current in AC-3 ($\theta \leq 55^\circ\text{C}$)											
440 V	A	150	185	265	400	500	630	750	1000	1500	1800
500 V	A	135	175	245	385	500	540	750	900	1200	1500
660/690 V	A	130	140	230	365	435	470	700	800	900	1100
1000 V	A	47	73	95	135	270	330	400	400	500	600
Rated operational power (standard motor power ratings)											
220...240 V	kW	40	55	75	110	147	200	220	280	425	500
	HP	54	75	100	150	200	270	300	380	580	680
380...400 V	kW	75	90	132	200	250	335	400	500	750	900
	HP	100	185	180	270	340	450	545	680	1000	1220
415 V	kW	80	100	140	220	280	375	425	530	800	900
	HP	110	136	180	300	380	500	580	720	1100	1220
440 V	kW	80	100	140	250	295	400	450	560	800	900
	HP	110	136	190	340	400	545	610	760	1100	1220
500 V	kW	90	110	160	257	355	400	500	600	750	900
	HP	125	150	220	350	480	545	680	810	1000	1220
660/690 V	kW	100	110	160	280	335	450	560	670	750	900
	HP	–	–	–	–	–	610	760	910	1000	1220
1000 V	kW	65	100	147	185	335	450	530	530	670	750
	HP	–	136	200	250	–	610	720	720	910	1000

Maximum operating rate in operating cycles/hour, at rated operational power with an on-load factor = 85%: 750 for CR1 F150 to F265, 500 for CR1 F400 to F630 and 120 for CR1 B.

Use in category AC-3 ($U_e \leq 440\text{ V}$) (1) ($\theta \leq 55\text{ }^\circ\text{C}$)

The current (I_c) in AC-3 is equal to the rated operational current (I_e) drawn by the motor.

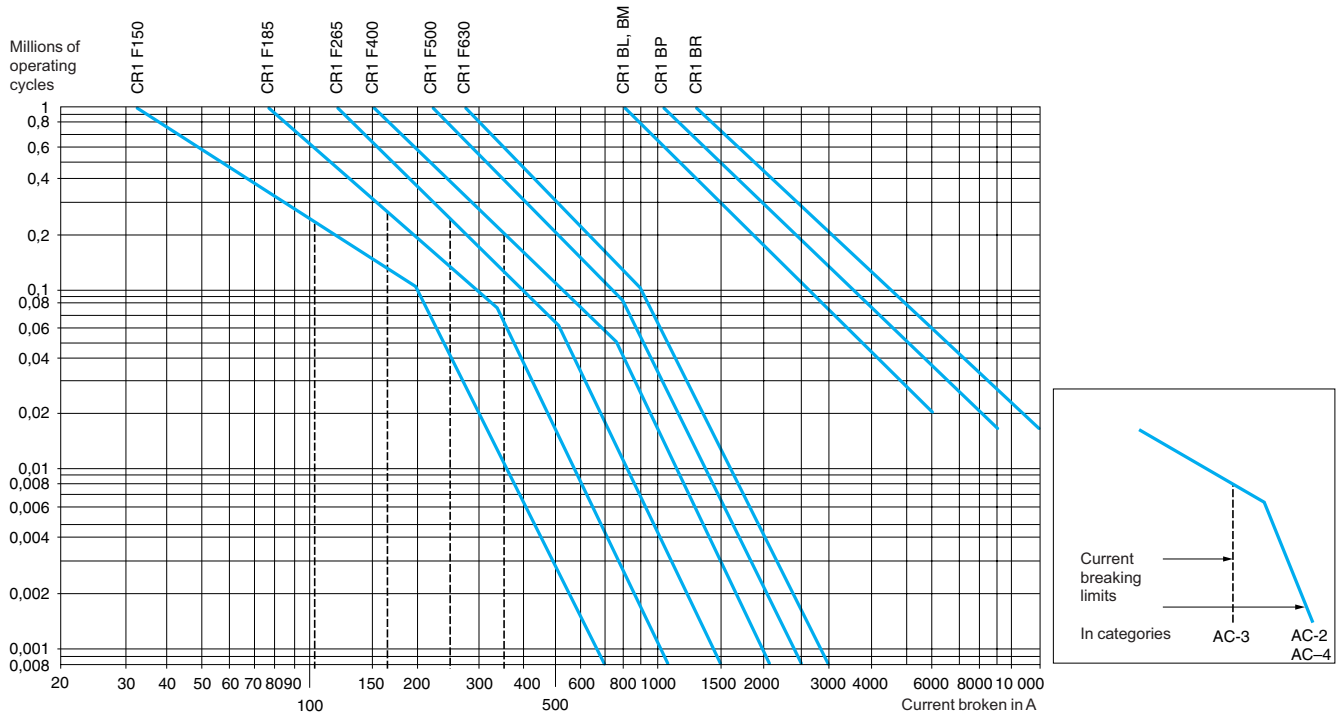

Example:

Asynchronous motor with $P = 50\text{ kW}$, $U_e = 380\text{ V}$, $I_e = 100\text{ A}$, $I_c = I_e = 100\text{ A}$, or asynchronous motor with $P = 55\text{ kW}$, $U_e = 415\text{ V}$, $I_e = 100\text{ A}$, $I_c = I_e = 100\text{ A}$

600 000 operating cycles required.

The above selection curves show the contactor rating needed, CR1 F185.

(1) For 660 V, multiply the number of operating cycles by 0.8.

TeSys contactors

Magnetic latching contactors

Selection guide for utilisation category AC-1 and according to required electrical durability

Maximum operational current (on-load factor ≥ 0.95)

Maximum operating rate: 120 operating cycles/hour

Contactor size		CR1 F150	CR1 F185	CR1 F265	CR1 F400	CR1 F500	CR1 F630	CR1 BL	CR1 BM	CR1 BP	CR1 BR	
Cable c.s.a.	mm ²	120	150	185	–	–	–	–	–	–	–	
Number of bars		–	–	–	2	2	2	2	2	3	4	
Bar c.s.a.	mm	–	–	–	30 x 5	40 x 5	60 x 5	50 x 5	80 x 5	100 x 5	100 x 5	
Operational current in category AC-1 at ambient temperature	$\leq 40\text{ °C}$	A	250	275	350	500	700	1000	800	1250	2000	2750
	$\leq 55\text{ °C}$	A	250	275	300	430	580	850	700	1100	1750	2400
	$\leq 70\text{ °C}$	A	170	180	250	340	500	700	600	900	1500	2000

Increase in operational current by parallel connection of poles

Apply the following coefficients to the above currents; these coefficients take into account an often unbalanced distribution of current between the poles:

- 2 poles in parallel: K = 1.6
- 3 poles in parallel: K = 2.25
- 4 poles in parallel: K = 2.8

Electrical durability ($U_e \leq 440\text{ V}$) (1)

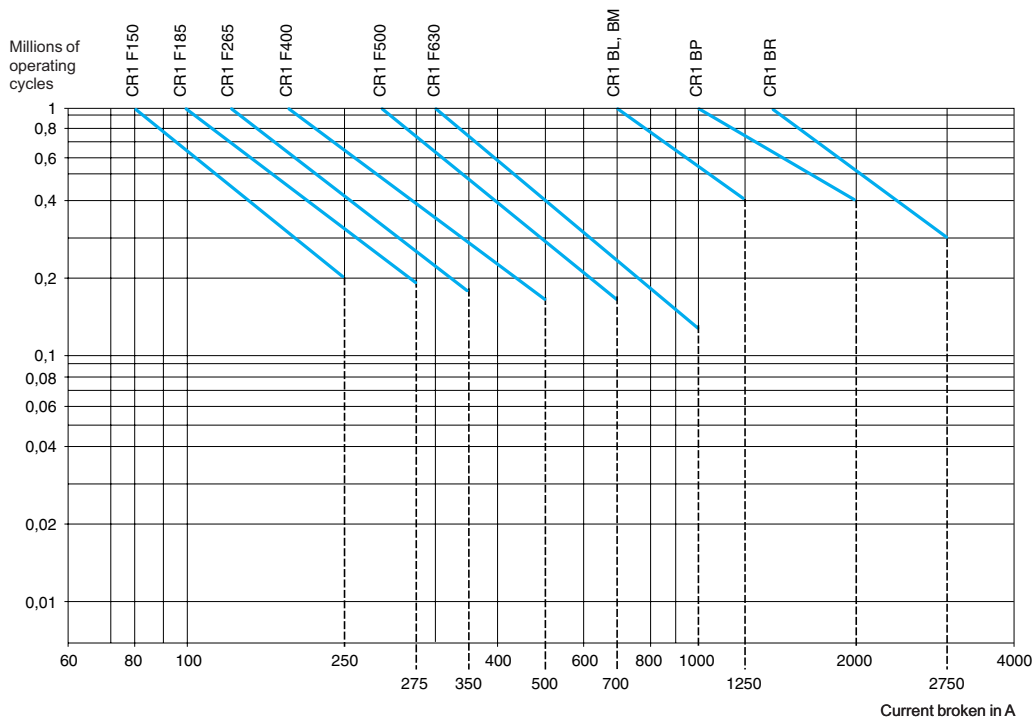

Example:

$U_e = 220\text{ V}$ - $I_e = 200\text{ A}$ - $q = 40\text{ °C}$ - $I_c = I_e = 200\text{ A}$

600 000 operating cycles required.

The above selection curves show the contactor rating needed, CR1 F400.

(1) For 660 V, multiply the number of operating cycles by 0.8.

TeSys contactors

Magnetic latching contactors

Selection guide for switching the primaries of 3-phase transformers

Operating conditions

Maximum ambient temperature: 55 °C
 Maximum operational voltage: 1000 V, 50...60 Hz

When a transformer is switched on, there is generally an initial current surge which reaches its peak value almost instantaneously and then decreases in a largely exponential manner to quickly reach its steady state value.

The value of this current depends on:

- the characteristics of the magnetic circuit and of the windings (cross sectional area of the core, rated inductance, number of turns, size of the windings, ...)
- the performance of the magnetic laminations used (residual induction and saturation inductance),
- the magnetic state of the circuit and the instantaneous value of the a.c. mains voltage at the moment of switch-on.

The peak current at the moment of switch-on can reach 20 to 40 times the rated current for the various kVA power ratings in the tables below. This value is independent of the "no-load" or "on-load" state of the transformer.

The peak magnetising current of the transformer must be lower than the values given in the tables below.

Contactor selection

Maximum operating rate: 120 operating cycles/hour

Contactor size		CR1 F150	CR1 F185	CR1 F265	CR1 F400	CR1 F500	CR1 F630	CR1 BL	CR1 BM	CR1 BP	CR1 BR	
Maximum permissible current peak at switch-on	A	1700	2800	3500	5500	6800	9000	18 000	18 000	24 000	30 000	
Maximum operational power (1)	220...230 V	kVA	25	40	50	75	100	140	230	230	300	380
	380...400 V	kVA	50	75	90	130	170	225	400	400	530	660
	415...440 V	kVA	55	80	100	140	190	250	450	450	560	700
	500 V	kVA	65	95	110	170	225	280	480	480	600	750
	660 V	kVA	80	120	140	200	270	315	600	600	800	950
	1000 V	kVA	100	150	200	250	375	470	700	700	1000	1200

(1) Maximum operational power corresponding to a current peak at switch-on of 30 In.



Contactor type		CR1 F150	CR1 F185	CR1 F265		
Environment						
Rated insulation voltage (Ui)	Conforming to IEC 60158-1, BS 775, 60947-4	V	1000	1000	1000	
	Conforming to VDE 0110 grC	V	1500	1500	1500	
Protective treatment	Standard version		"TH"			
	Special version		-			
Ambient air temperature around the device	Storage	°C	- 60...+ 80			
	For operation at Uc	°C	- 15...+ 70			
Maximum operating altitude	Without derating	m	3000			
Operating positions	Without derating		± 5 °			
Pole characteristics						
Number of poles			3 or 4	3 or 4	3 or 4	
Rated operational current (Ie) (Ue ≤ 440 V)	In AC-3, θ ≤ 40 °C	A	150	185	265	
	In AC-1, θ ≤ 40 °C	A	250	275	350	
	In AC-4, θ ≤ 40 °C	A	138	170	245	
Rated operational voltage (Ue)	Up to	V	1000	1000	1000	
Frequency limits (sine wave)	Of the operational current	Hz	25...200	25...200	25...200	
Rated making capacity	I rms	A	1700	2100	2940	
Rated breaking capacity	I rms	220...440 V	A	1500	1800	2450
		500 V	A	1200	1600	2200
		660/690 V	A	1100	1200	1700
		1000 V	A	450	600	800
Permissible short time rating from cold state, with no current flowing for previous 60 minutes at θ ≤ 40 °C	For 1 s	A	1200	1500	2200	
	For 5 s	A	1200	1500	2200	
	For 10 s	A	1200	1500	2200	
	For 30 s	A	700	920	1230	
	For 1 min	A	600	740	950	
	For 3 min	A	450	500	620	
	For 10 min	A	350	400	480	
Short-circuit protection by fuses θ ≤ 440 V	Motor circuit AC-3 (type aM)	A	160	200	315	
	AC-1 circuit (type gG, BS 88)	A	250	315	400	
Average impedance per pole	At Ith and 50 Hz	mΩ	0.45	0.36	0.32	
Power dissipated per pole for the above operational currents	AC-3	W	6	12	22	
	AC-1	W	18	26	39	
Connection	Number of conductors		1	1	1	
	Cable with lugs	mm ²	120	150	240	
	Cable with connector	mm ²	120	150	240	
	Number of bars		2	2	2	
	Bar c.s.a.	mm	25 x 3	25 x 3	32 x 4	
	Bolt diameter		Ø 8	Ø 8	Ø 10	
	Tightening torque	N.m	18	18	35	

5

CR1 F400	CR1 F500	CR1 F630	CR1 BL	CR1 BM	CR1 BP	CR1 BR
1000	1000	1000	1000	1000	1000	1000
1500	1500	1500	1500	1500	1500	1500
"TH"			"TC"			
-			"TH"			
- 60...+ 80			- 60...+ 80			
- 15...+ 70			- 15...+ 60			
3000			3000			
± 5 ° in relation to normal vertical mounting plane			± 5 ° in relation to normal vertical mounting plane			
3 or 4	3 or 4	3 or 4	1, 2, 3 or 4	1, 2, 3 or 4	1, 2, 3 or 4	1, 2, 3 or 4
400	500	630	750	1000	1500	1800
500	700	1000	800	1250	2000	2750
370	460	560	700	800	1250	1500
1000	1000	1000	1000	1000	1000	1000
25...200	25...200	25...200	50...60	50...60	50...60	50...60
4500	5000	6740	10 000	10 000	15 000	18 000
4000	5000	6300	10 000	10 000	15 000	18 000
3500	4500	5400	9000	9000	12 000	15 000
3000	3560	4600	8000	8000	9000	11 000
1200	2500	3200	4000	4000	5000	6000
3600	4200	5050	9600	9600	12 000	15 000
3600	4200	5050	9600	9600	12 000	15 000
3600	4200	5050	7000	8000	9600	12 000
2400	3200	4400	4800	5200	6400	8000
1700	2400	3400	3500	3800	5200	6300
1200	1500	2200	2100	2400	3600	4400
1000	1200	1600	1200	1800	2800	3600
400	500	630	800	1200	800 x 2 (1)	1000 x 2 (1)
500	800	1000	800	1200	1000 x 2 (1)	1200 x 2 (1)
0.28	0.18	0.12	0.18	0.18	0.13	0.09
45	45	48	88	180	290	360
70	88	120	115	280	520	680
2	2	-	-	-	-	-
150	240	-	-	-	-	-
-	-	-	-	-	-	-
2	2	2	2	2	3	4
30 x 5	40 x 5	60 x 5	50 x 5	80 x 5	100 x 5	100 x 10
Ø 10	Ø 10	Ø 12	4 x Ø 8	4 x Ø 10	4 x Ø 10	4 x Ø 10
35	35	58	21	35	35	35

(1) Paralleling of poles must be carried out only in accordance with the fuse manufacturer's recommendations.

Contactor type				CR1 F150	CR1 F185	CR1 F265	
Control circuit characteristics							
Rated control circuit voltage (Uc)	~ 50 or 60 Hz	V	48...415				
	~ 400 Hz	V	48...220				
	---	V	48...220				
	--- low consumption	V	48...220				
Control voltage limits ~ and ---	Latching		0.85...1.1 Uc				
	Unlatching		0.85...1.1 Uc				
Maximum operating rate at ambient temperature ≤ 40 °C	In operating cycles per hour		120				
Mechanical durability	In millions of operating cycles		1				
Average consumption 50/60 Hz	Latching	1-pole	VA	–	–	–	
		2-pole	VA	–	–	–	
		3-pole	VA	1100	1600	1650	
		4-pole	VA	100	1600	1650	
	Unlatching	1-pole	VA	–	–	–	
		2-pole	VA	–	–	–	
		3-pole	VA	7.3	8	9	
		4-pole	VA	7.3	8	9	
	400 Hz and ---	Latching	1-pole	VA	–	–	–
			2-pole	VA	–	–	–
			3-pole	VA	1260	1750	1800
			4-pole	VA	1260	1750	1800
		Unlatching	1-pole	VA	–	–	–
			2-pole	VA	–	–	–
			3-pole	VA	10	11	12
			4-pole	VA	10	11	12
--- low consumption	Latching	3/4-pole	W	500	500	500	
	Unlatching	3/4-pole	W	15	20	40	
Average operating time at Uc (1)	Latching	ms	35...40	35...40	45...50		
	Unlatching	ms	50...100	50...100	50...100		

(1) The closing time is measured from the moment the closing coil is energised to initial contact of the main poles. The opening time is measured from the moment the opening coil is energised to the moment the main poles separate.

Nota : the arcing time depends on the circuit switched by the main poles. For 3-phase applications the arcing time is usually less than 10 ms. The load is isolated from the supply after a time equal to the sum of the opening time and the arcing time.

Auxiliary contact characteristics

Type of contacts		LAD N for contactors CR1 F
Conventional thermal current	A	10
Rated insulation voltage (Ui)	Conforming to IEC 60947-5-1	V 690
Connection	Flexible or solid conductor with or without cable end	mm ² 1 x 1 min; 2 x 2.5 max

Operational power of contacts LAD N for contactors CR1 F	a.c. supply					d.c. supply					
	V	48	115	230	400	600	V	48	125	250	440
1 million operating cycles	VA	120	280	560	960	1440	W	90	75	68	61
Occasional making capacity	VA	2600	7000	13 000	15 000	9000	W	700	400	260	220

CR1 F400	CR1 F500	CR1 F630	CR1 BL	CR1 BM	CR1 BP	CR1 BR
48...415			110...500			
48...220			110...500			
48...220			110...500			
48...220			–			
0.85...1.1 Uc			0.85...1.1 Uc			
0.85...1.1 Uc			0.85...1.1 Uc			
120			120			
1			1			
–	–	–	650	650	650	650
–	–	–	1100	1100	1100	1100
1450	1650	2100	1650	1650	1650	1650
1450	1650	2100	1850	1850	1850	1850
–	–	–	110	110	110	110
–	–	–	125	125	125	125
12	9.5	8	165	165	165	165
12	9.5	8	175	175	175	175
–	–	–	600	600	600	600
–	–	–	1000	1000	1000	1000
1600	1800	2300	1500	1500	1500	1500
1600	1800	2300	1700	1700	1700	1700
–	–	–	100	100	100	100
–	–	–	115	115	115	115
16	13	11	150	150	150	150
16	13	11	160	160	160	160
500	550	620	–	–	–	–
70	60	45	–	–	–	–
40...75	40...80	40...80	100...150	100...150	100...150	100...150
50...100	50...100	50...100	20...40	20...40	20...40	20...40

(1) The closing time is measured from the moment the closing coil is energised to initial contact of the main poles. The opening time is measured from the moment the opening coil is energised to the moment the main poles separate.

Nota : the arcing time depends on the circuit switched by the main poles. For 3-phase applications the arcing time is usually less than 10 ms. The load is isolated from the supply after a time equal to the sum of the opening time and the arcing time.

LAD N for contactors CR1 F	ZC4 GM for contactors CR1 B
10	20
690	660
1 x 1 min; 2 x 2.5 max	2 min; 4 max

Operational power of contacts
ZC4 GM for contactors CR1 B

a.c. supply

Electrical durability (valid for up to 2400 operating cycles/hour) on an inductive load such as the coil of an electromagnet: making current (cos φ 0.7) = 10 times the power broken (cos φ 0.4).

V	110	220	380	415	500
	127			440	

VA	2000	4000	4000	4000	3500
----	------	------	------	------	------

VA	14 000	23 000	35 000	45 000	35 000
----	--------	--------	--------	--------	--------

d.c. supply

Electrical durability (valid for up to 1200 operating cycles/hour) on an inductive load such as the coil of an electromagnet, without economy resistor, the time constant increasing with the load.

V	110	120	440	500
---	-----	-----	-----	-----

W	250	250	230	200
---	-----	-----	-----	-----

W	1600	800	400	360
---	------	-----	-----	-----

1 million operating cycles

Occasional making capacity

TeSys contactors

Magnetic latching contactors

Control circuit: a.c. or d.c. supply

501612_1



CR1 F1854

501613_1



CR1 F500

5

501614_1



CR1 BP33

Maximum thermal current in category AC-1 40 °C	Rated operational current in category AC-3 (440 V max)	Number of poles	Instantaneous auxiliary contacts			Basic reference, to be completed by adding the voltage code (1)	Weight
A	A					kg	
250	150	3	–	–	–	CR1 F150●●	3.500
		4	–	–	–	CR1 F1504●●	3.800
275	185	3	–	–	–	CR1 F185●●	4.600
		4	–	–	–	CR1 F1854●●	5.400
350	265	3	–	–	–	CR1 F265●●	7.400
		4	–	–	–	CR1 F2654●●	8.500
500	400	3	–	–	–	CR1 F400●●	9.100
		4	–	–	–	CR1 F4004●●	10.200
700	500	3	–	–	–	CR1 F500●●	11.300
		4	–	–	–	CR1 F5004●●	12.900
1000	630	3	–	–	–	CR1 F630●●	18.600
		4	–	–	–	CR1 F6304●●	21.500
800	750	1	1	2	–	CR1 BL31●12	32.000
			2	1	–	CR1 BL31●21	32.000
			3	–	–	CR1 BL31●30	32.000
		2	1	2	–	CR1 BL32●12	45.000
			2	1	–	CR1 BL32●21	45.000
			3	–	–	CR1 BL32●30	45.000
		3	1	2	–	CR1 BL33●12	58.000
			2	1	–	CR1 BL33●21	58.000
			3	–	–	CR1 BL33●30	58.000
		4	1	2	–	CR1 BL34●12	72.000
			2	1	–	CR1 BL34●21	72.000
			3	–	–	CR1 BL34●30	72.000
1250	1000	1	1	2	–	CR1 BM31●12	31.000
			2	1	–	CR1 BM31●21	31.000
			3	–	–	CR1 BM31●30	31.000
		2	1	2	–	CR1 BM32●12	44.000
			2	1	–	CR1 BM32●21	44.000
			3	–	–	CR1 BM32●30	44.000
		3	1	2	–	CR1 BM33●12	57.000
			2	1	–	CR1 BM33●21	57.000
			3	–	–	CR1 BM33●30	57.000
		4	1	2	–	CR1 BM34●12	71.000
			2	1	–	CR1 BM34●21	71.000
			3	–	–	CR1 BM34●30	71.000
2000	1500	1	1	2	–	CR1 BP31●12	41.000
			2	1	–	CR1 BP31●21	41.000
			3	–	–	CR1 BP31●30	41.000
		2	1	2	–	CR1 BP32●12	65.000
			2	1	–	CR1 BP32●21	65.000
			3	–	–	CR1 BP32●30	65.000
		3	1	2	–	CR1 BP33●12	94.000
			2	1	–	CR1 BP33●21	94.000
			3	–	–	CR1 BP33●30	94.000
		4	1	2	–	CR1 BP34●12	120.000
			2	1	–	CR1 BP34●21	120.000
			3	–	–	CR1 BP34●30	120.000
2750	1800	1	1	2	–	CR1 BR31●12	52.000
			2	1	–	CR1 BR31●21	52.000
			3	–	–	CR1 BR31●30	52.000
		2	1	2	–	CR1 BR32●12	85.000
			2	1	–	CR1 BR32●21	85.000
			3	–	–	CR1 BR32●30	85.000
		3	1	2	–	CR1 BR33●12	129.000
			2	1	–	CR1 BR33●21	129.000
			3	–	–	CR1 BR33●30	129.000
		4	1	2	–	CR1 BR34●12	160.000
			2	1	–	CR1 BR34●21	160.000
			3	–	–	CR1 BR34●30	160.000

(1) Standard control circuit voltages: see page opposite.

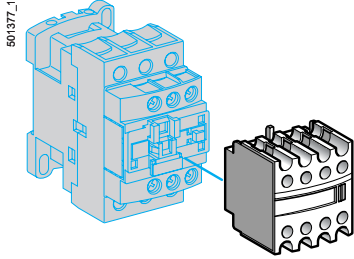

LAD N

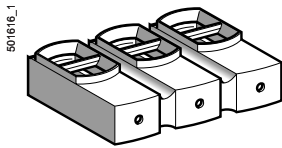

LA9 F103

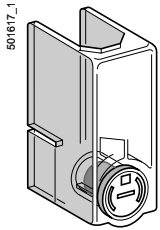

LA9 F70

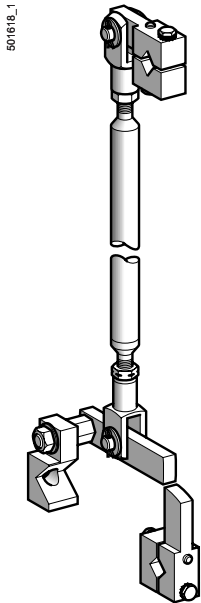

EZ2 LB0601

Accessories for contactors CR1 F

Description	Number of contacts or shrouds	For use on	Reference	Weight kg
Instantaneous auxiliary contacts	(1)	CR1 F	LAD N (1)	0.050
Time delay auxiliary contacts	(1)	CR1 F	LAD • (1)	0.060
Contact blocks with protected terminals for 3-pole contactors (for mounting on contactors with closed arc chamber)	Set of 2 blocks	CR1 F150 and CR1 F185	LA9 F103	0.300
Power terminal protection shrouds	Set of 6 shrouds for 3-pole contactors	CR1 F150 and CR1 F185	LA9 F702	0.250
		CR1 F265 to CR1 F500	LA9 F703	0.250
		CR1 F630	LA9 F704	0.250
	Set of 8 shrouds for 4-pole contactors	CR1 F1504 and CR1 F1854	LA9 F707	0.300
		CR1 F2654 to CR1 F5004	LA9 F708	0.300
		CR1 F6304	LA9 F709	0.300

Description	Application	Reference
Mechanical interlock and power connections	For assembly of reversing contactors and changeover contactor pairs	See pages 5/252 and 5/253

Accessories for contactors CR1 B

Description	Application	Reference	Weight kg
Mechanical interlock with mounting accessories (3)	For vertical assembly of reversing contactors and changeover contactor pairs	EZ2 LB0601	1.560
Kit containing 2 bar mounting brackets	For mounting on 120 or 150 mm centres	LA9 B103	1.620

(1) For maximum number per contactor and complete reference, see page 5/123.
 (2) Standard control circuit voltages (for other voltages, please consult your Regional Sales Office):

Volts	48	110	125	127	220	230	240	250	380	400	415	440	500
For contactors CR1 F													
~ 50/60 Hz	E7	F7	-	G7	M7	M7	U7	-	Q7	Q7	N7	-	-
~ 400 Hz	E7	F7	-	G7	M7	M7	-	-	-	-	-	-	-
---	E7	F7	-	G7	M7	M7	-	-	-	-	-	-	-
--- low consumption	EZ7	FZ7	-	GZ7	MZ7	MZ7	-	-	-	-	-	-	-

For contactors CR1 B													
~ 50...400 Hz	-	F	-	G	M	M	U	-	Q	V	N	R	S
---	-	FD	GD	-	MD	-	UD	UCD	-	-	-	RD	SD

(3) Positive mechanical interlocking between 2 vertically mounted contactors of identical or different ratings. Connecting rods and cranks assembled on right-hand sides, crank pins on the pole side.
 Vertical fixing centre distance between the two contactors: 600 mm.

TeSys contactors

Magnetic latching contactors

Components for assembling reversing contactors and changeover contactor pairs CR1 F

Horizontally or vertically mounted

Horizontally mounted

Mechanical interlocks

Reversers assembled using 2 contactors of identical rating, type:

- CR1 F150
- CR1 F185
- CR1 F265
- CR1 F400
- CR1 F500
- CR1 F630

LA9 F●970

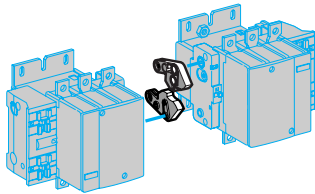

Sets of power connections

Reversing contactors LA9 F●976

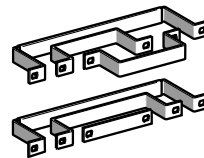
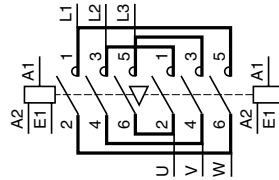

3 or 4-pole changeover contactor pairs LA9 F●977 or LA9 F●982

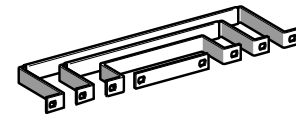
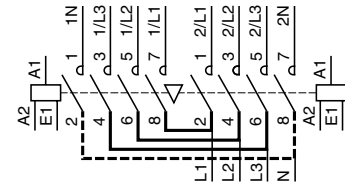

Vertically mounted

Mechanical interlocks

Reversers assembled using 2 contactors of identical rating, type:

- CR1 F150
- CR1 F185
- CR1 F265
- CR1 F400
- CR1 F500
- CR1 F630

LA9 FF4F Assembly A
LA9 FG4G

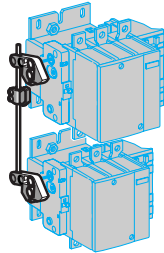

LA9 FH4H Assembly C
LA9 FJ4J
LA9 FK4K
LA9 FL4L

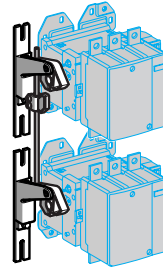

Reversers assembled using 2 contactors of different ratings, type:

- CR1 F150
- CR1 F185
- CR1 F265
- CR1 F400
- CR1 F500
- CR1 F630

LA9 FG4F Assembly A

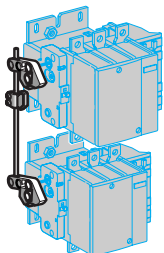

LA9 FH4F Assembly B
LA9 FJ4F
LA9 FK4F
LA9 FL4F
LA9 FH4G
LA9 FJ4G
LA9 FK4G
LA9 FL4G

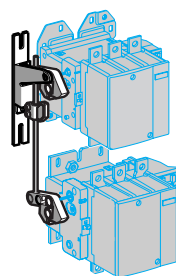

LA9 FJ4H Assembly C
LA9 FK4H
LA9 FL4H
LA9 FK4J
LA9 FL4J
LA9 FK4K

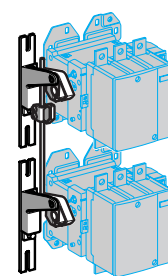

Reversers assembled using 3 contactors of identical or different ratings

LA9 F●4●4●

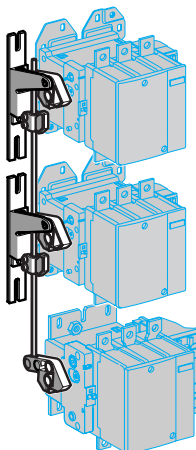

A	CR1 F500	F150	F185	F265	F400	F500	F630
B	CR1 F265			F150	F185	F265	F400
C	CR1 F185					F150	F185

Warning: the contactor ratings must be in decreasing size from top to bottom.

TeSys contactors

Magnetic latching contactors

Components for assembling reversing contactors and changeover contactor pairs CR1 F

For assembly of 3-pole reversing contactors for motor control (1)

Reversers assembled using 2 contactors of identical rating					
Contactor type	Set of power connections			Mechanical interlock	
	3-pole Reference	4-pole Reference	Weight kg	Kit reference	Weight kg
Horizontally mounted					
CR1 F150	LA9 FF976	–	0.600	LA9 FF970	0.060
CR1 F185	LA9 FG976	–	0.780	LA9 FG970	0.060
CR1 F265	LA9 FH976	–	1.500	LA9 FJ970	0.140
CR1 F400	LA9 FJ976	–	2.100	LA9 FJ970	0.140
CR1 F500	LA9 FK976	–	2.350	LA9 FJ970	0.140
CR1 F630	LA9 FL976	–	3.800	LA9 FL970	0.150
Vertically mounted					
CR1 F150	(2)	–	–	LA9 FF4F	0.345
CR1 F185	(2)	–	–	LA9 FG4G	0.350
CR1 F265	(2)	–	–	LA9 FH4H	1.060
CR1 F400	(2)	–	–	LA9 FJ4J	1.200
CR1 F500	(2)	–	–	LA9 FK4K	1.200
CR1 F630	(2)	–	–	LA9 FL4L	1.220
Horizontally mounted					
CR1 F1504	LA9 FF982	LA9 FF977	0.460	LA9 FF970	0.060
CR1 F1854	LA9 FG982	LA9 FG977	0.610	LA9 FG970	0.060
CR1 F2654	LA9 FH982	LA9 FH977	1.200	LA9 FJ970	0.140
CR1 F4004	LA9 FJ982	LA9 FJ977	1.800	LA9 FJ970	0.140
CR1 F5004	LA9 FK982	LA9 FK977	2.300	LA9 FJ970	0.140
CR1 F6304	LA9 FL982	LA9 FL977	3.400	LA9 FL970	0.150
Vertically mounted					
CR1 F1504	(2)	–	–	LA9 FF4F	0.345
CR1 F1854	(2)	–	–	LA9 FG4G	0.350
CR1 F2654	(2)	–	–	LA9 FH4H	1.060
CR1 F4004	(2)	–	–	LA9 FJ4J	1.200
CR1 F5004	(2)	–	–	LA9 FK4K	1.200
CR1 F6304	(2)	–	–	LA9 FL4L	1.220

For assembly of 4-pole changeover contactor pairs

Reversers assembled using 2 contactors of different ratings					
Contactor type	Set of power connections			Mechanical interlock	
	At bottom	At top		Kit reference	Weight kg
Vertically mounted (3)					
CR1 F150 or F1504	CR1 F185 or F1854			LA9 FG4F	0.350
	CR1 F265 or F2654			LA9 FH4F	0.870
	CR1 F400 or F4004			LA9 FJ4F	0.930
	CR1 F500 or F5004			LA9 FK4F	0.940
CR1 F630 or F6304	CR1 F630 or F6304			LA9 FL4F	0.940
	CR1 F265 or F2654			LA9 FH4G	0.860
	CR1 F400 or F4004			LA9 FJ4G	0.940
	CR1 F500 or F5004			LA9 FK4G	0.940
CR1 F185 or F1854	CR1 F630 or F6304			LA9 FL4G	0.950
	CR1 F400 or F4004			LA9 FJ4H	1.130
	CR1 F500 or F5004			LA9 FK4H	1.130
CR1 F265 or F2654	CR1 F630 or F6304			LA9 FL4H	1.140
	CR1 F400 or F4004			LA9 FJ4J	1.200
	CR1 F500 or F5004			LA9 FK4J	1.200
CR1 F400 or F4004	CR1 F630 or F6304			LA9 FL4J	1.210
	CR1 F500 or F5004			LA9 FK4K	1.210
CR1 F500 or F5004	CR1 F630 or F6304			LA9 FL4K	1.210

For assembly of 3 or 4-pole changeover contactor pairs

Contactor type	Set of power connections			Mechanical interlock	
	CR1 F150	CR1 F185	CR1 F265	CR1 F400	CR1 F500
Using 3 contactors (vertically mounted) of identical or different ratings					
The contactor ratings must be in decreasing size from top to bottom.				LA9 F●4●4●	
Kit reference (4)					

- (1) A 3-pole reversing contactor for motor control can be converted into a 3-pole changeover contactor pair by removing the upper connecting links.
- (2) All power connections are to be made by the customer.
- (3) With identical or different number of poles. Power connections to be made by the customer.
- (4) Complete the reference by replacing the first dot with the code for the upper contactor, the second dot with the code for the middle contactor and the third dot with the code for the bottom contactor.

Code	F	G	H	J	K	L
------	---	---	---	---	---	---

Example: mechanical interlock for reversing contactor made up of 3 different contactors: CR1 F500 top, CR1 F26 middle and CR1 F185 bottom: LA9 FK4H4G.

TeSys contactors

Magnetic latching contactors

Coils for contactors CR1 F

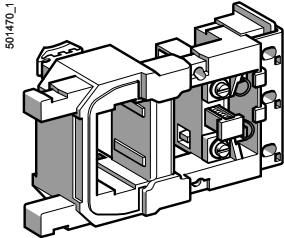

LX0 FF009

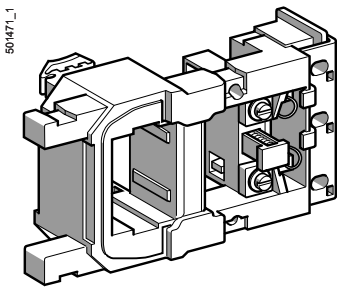

LX0 FH009

Standard coils

Usual voltages		Resistance of winding at $\theta = 20\text{ }^{\circ}\text{C}$		Reference	Voltage code	Weight
50...400 Hz 50 Hz, 60 Hz or ---		Latching	Unlatching			
V	V	Ω	Ω			kg
For contactors CR1 F150						
48	–	1.98	230.8	LX0 FF005	E7	0.440
110	–	9.35	1453	LX0 FF006	F7	0.440
127	–	11.61	1788	LX0 FF007	G7	0.440
208	–	23.50	4098	LX0 FF020	L7	0.440
220/230	–	37.55	5139	LX0 FF008	M7	0.440
–	240	45.16	6544	LX0 FF009	U7	0.440
–	380/400	114.10	12 447	LX0 FF010	Q7	0.440
–	415	139.50	16 717	LX0 FF011	N7	0.440

For contactors CR1 F185						
48	–	1.42	220	LX0 FG005	E7	0.560
110	–	6.92	1339	LX0 FG006	F7	0.560
127	–	8.45	1676	LX0 FG007	G7	0.560
208	–	21.30	3169	LX0 FG020	L7	0.560
220/230	–	26.27	4729	LX0 FG008	M7	0.560
–	240	32.95	4729	LX0 FG009	U7	0.560
–	380/400	82.29	11 885	LX0 FG010	Q7	0.560
–	415	102.30	14 305	LX0 FG011	N7	0.560

For contactors CR1 F265						
48	–	1.34	183.4	LX0 FH005	E7	0.780
110	–	6.90	1031	LX0 FH006	F7	0.780
127	–	8.56	1325	LX0 FH007	G7	0.780
208	–	20.20	2654	LX0 FH020	L7	0.780
220/230	–	25.77	4090	LX0 FH008	M7	0.780
–	240	33.03	5002	LX0 FH009	U7	0.780
–	380/400	78.39	11 803	LX0 FH010	Q7	0.780
–	415	102.9	15 006	LX0 FH011	N7	0.780

For contactors CR1 F400						
48	–	1.32	90.5	LX0 FJ005	E7	1.120
110	–	8.09	813	LX0 FJ006	F7	1.120
127	–	9.79	1027	LX0-FJ007	G7	1.120
208	–	24.40	2643	LX0 FJ020	L7	1.120
220/230	–	30.14	3309	LX0 FJ008	M7	1.120
–	240	37.02	4074	LX0 FJ009	U7	1.120
–	380/400	94.80	9380	LX0 FJ010	Q7	1.120
–	415	121.10	11 763	LX0 FJ011	N7	1.120

For contactors CR1 F500						
48	–	1.57	166	LX0 FK005	E7	1.220
110	–	7.53	916	LX0 FK006	F7	1.220
127	–	9.56	1159	LX0 FK007	G7	1.220
208	–	23.60	2981	LX0 FK020	L7	1.220
220/230	–	28.81	3733	LX0 FK008	M7	1.220
–	240	35.67	4595	LX0 FK009	U7	1.220
–	380/400	89.56	10 570	LX0 FK010	Q7	1.220
–	415	112.06	13 256	LX0 FK011	N7	1.220

For contactors CR1 F630						
48	–	0.87	204	LX0 FL005	E7	1.460
110	–	5.20	1423	LX0 FL006	F7	1.460
127	–	6.45	1830	LX0 FL007	G7	1.460
208	–	20.20	2961	LX0 FL020	L7	1.460
220/230	–	25.36	4603	LX0 FL008	M7	1.460
–	240	25.36	5658	LX0 FL009	U7	1.460
–	380/400	60.95	10 676	LX0 FL010	Q7	1.460
–	415	77.97	13 003	LX0 FL011	N7	1.460

TeSys contactors

Magnetic latching contactors

Coils for contactors CR1 F

801472_1

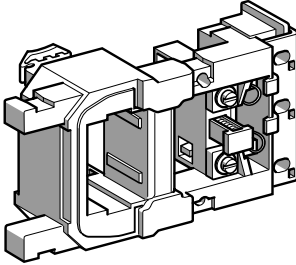

LX0 FF030

Special coils

Coils with two windings with common point, allowing the use of two separate power sources for latching and unlatching.

Coil voltages at 50 Hz, 60 Hz, 400 Hz or ---		Resistance of winding at $\theta = 20\text{ }^{\circ}\text{C}$		Reference	Voltage code	Weight
Latching	Unlatching	Latching	Unlatching			
V	V	Ω	Ω			kg
For contactors CR1 F150						
220	24	29.5	39.5	LX0 FF224	MB7	0.440
For contactors CR1 F185						
220	24	26.5	19	LX0 FG224	MB7	0.560
For contactors CR1 F265						
220	24	26	29.5	LX0 FH224	MB7	0.780
For contactors CR1 F400						
220	24	30	23	LX0 FJ224	MB7	1.120
For contactors CR1 F500						
220	24	29	26	LX0 FK224	MB7	1.220
For contactors CR1 F630						
220	24	26	41	LX0 FL224	MB7	1.460

Coils with low inrush consumption

Usual voltages ---	Resistance of winding at $\theta = 20\text{ }^{\circ}\text{C}$		Reference	Voltage code	Weight
	Latching	Unlatching			
V	Ω	Ω			kg
For contactors CR1 F150					
48	4.56	140.56	LX0 FF055	EZ7	0.440
110	22.37	706.44	LX0 FF056	FZ7	0.440
127	35.54	1086.36	LX0 FF057	GZ7	0.440
220	89.85	3342.51	LX0 FF058	MZ7	0.440
For contactors CR1 F185					
48	5.19	106.54	LX0 FG055	EZ7	0.570
110	25.50	536.26	LX0 FG056	FZ7	0.570
127	32.75	732.64	LX0 FG057	GZ7	0.570
220	102.44	2378.62	LX0 FG058	MZ7	0.570
For contactors CR1 F265					
48	5.19	74.26	LX0 FH055	EZ7	0.800
110	25	364.61	LX0 FH056	FZ7	0.800
127	30.98	458.45	LX0 FH057	GZ7	0.800
220	97.89	1344.46	LX0 FH058	MZ7	0.800
For contactors CR1 F400					
48	5.05	36.36	LX0 FJ055	EZ7	1.150
110	25.39	171.49	LX0 FJ056	FZ7	1.150
127	31.86	221.20	LX0 FJ057	GZ7	1.150
220	98.19	648.79	LX0 FJ058	MZ7	1.150
For contactors CR1 F500					
48	4.42	41	LX0 FK055	EZ7	1.270
110	22.74	193.36	LX0 FK056	FZ7	1.270
127	28.25	313.60	LX0 FK057	GZ7	1.270
220	85.12	918.68	LX0 FK058	MZ7	1.270
For contactors CR1 F630					
48	3.94	59.17	LX0 FL055	EZ7	1.500
110	19.36	365.33	LX0 FL056	FZ7	1.500
127	25.39	452.27	LX0 FL057	GZ7	1.500
220	74.44	1071.43	LX0 FL058	MZ7	1.500

TeSys contactors

Magnetic latching contactors

Coils for contactors CR1 B

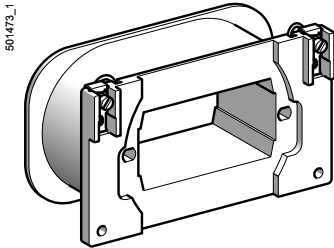

50-473_1

WB1 KB●●●

Coils with "TC" treatment (associated accessories, see page opposite)

Usual voltages		Resistance at $\theta = 20\text{ }^\circ\text{C}$	Reference	Weight
---	\sim 50...400 Hz			
V	V	Ω		kg
For contactors CR1 B●31				
–	110...120	19.7	WB1 KB140	1.120
110...125	–	25.2	WB1 KB134	1.120
–	220...240	77.2	WB1 KB136	1.120
220	–	94	WB1 KB139	1.120
250	–	128	WB1 KB125	1.120
–	380...400	197	WB1 KB126	1.120
–	415...440	257	WB1 KB138	1.120

For contactors CR1 B●32				
–	110	9.6	WB1 KB133	1.120
110	120...127	11.4	WB1 KB121	1.120
125	–	19.7	WB1 KB140	1.120
–	220/230	32.5	WB1 KB124	1.120
220	240	49.7	WB1 KB122	1.120
250	–	77.2	WB1 KB136	1.120
–	380...400	128	WB1 KB125	1.120
–	415...440	160	WB1 KB137	1.120

For contactors CR1 B●33				
–	110	7.2	WB1 KB123	1.120
110	120...127	9.6	WB1 KB133	1.120
125	–	11.4	WB1 KB121	1.120
220	240	32.5	WB1 KB124	1.120
250	–	61	WB1 KB135	1.120
–	380...415	94	WB1 KB139	1.120
–	440	128	WB1 KB125	1.120

For contactors CR1 B●34				
–	110	5.8	WB1 KB132	1.120
110	120...127	7.2	WB1 KB123	1.120
125	–	11.4	WB1 KB121	1.120
–	220/230	25.2	WB1 KB134	1.120
–	240	32.5	WB1 KB124	1.120
250	–	49.7	WB1 KB122	1.120
–	380	77.2	WB1 KB136	1.120
–	400...440	94	WB1 KB139	1.120

Coils with "TH" treatment (associated accessories, see page opposite)

Add suffix TH to the references selected above. Example: **WB1 KB140TH**.

TeSys contactors

Magnetic latching contactors

Coils for contactors CR1 B

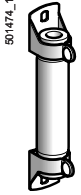

DR2 SC0220

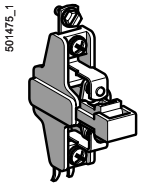

ZC4 GM2

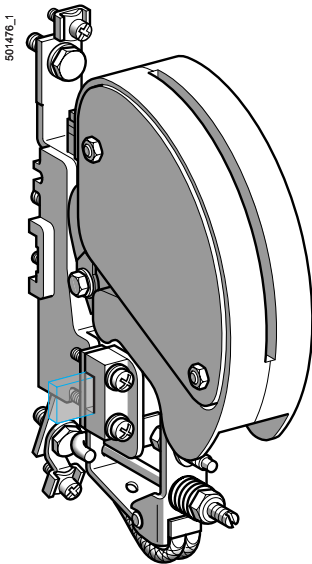

PR4 FB0014

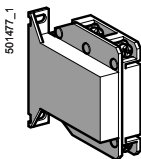

DR5 TE1U

Accessories for use with coils (1)

Coils ("TC" or "TH")	Additional resistors (2)				Automatic coil cut-out contact (3)	Rectifier (4)
	R1	Reference	R2	Reference		
	Ω		Ω		Nb Reference	Reference

For contactors CR1 B●31

WB1 KB140	68	DR2 SC0068	47	DR2 SC0047	2	ZC4 GM2 or ZC4 GM8	DR5 TE1U
WB1 KB134	68	DR2 SC0068	68	DR2 SC0068	2	ZC4 GM2 or ZC4 GM8	–
WB1 KB136	220	DR2 SC0220	180	DR2 SC0180	2	ZC4 GM2 or ZC4 GM8	DR5 TE1U
WB1 KB139	270	DR2 SC0270	220	DR2 SC0220	2	ZC4 GM2 or ZC4 GM8	–
WB1 KB125	330	DR2 SC0330	270	DR2 SC0270	3	ZC4 GM2 or ZC4 GM8	–
WB1 KB126	470	DR2 SC0470	470	DR2 SC0470	3	ZC4 GM2 or ZC4 GM8	DR5 TE1S
WB1 KB138	1000	DR2 SC1000	470	DR2 SC0470	3	ZC4 GM2 or ZC4 GM8	DR5 TE1S

For contactors CR1 B●32

WB1 KB133	10	DR2 SC0010	33	DR2 SC0033	1	PR4 FB0011	DR5 TE1U
WB1 KB121	47	DR2 SC0047	39	DR2 SC0039	1	PR4 FB0010	DR5 TE1U
WB1 KB140	100	DR2 SC0100	47	DR2 SC0047	1	PR4 FB0009	–
WB1 KB124	120	DR2 SC0120	120	DR2 SC0120	1	PR4 FB0007	DR5 TE1U
WB1 KB122	220	DR2 SC0220	150	DR2 SC0150	1	PR4 FB0007	DR5 TE1U
WB1 KB136	330	DR2 SC0330	220	DR2 SC0220	1	PR4 FB0006	–
WB1 KB125	470	DR2 SC0470	470	DR2 SC0470	1	PR4 FB0005	DR5 TE1S
WB1 KB137	680	DR2 SC0680	560	DR2 SC0560	1	PR4 FB0004	DR5 TE1S

For contactors CR1 B●33

WB1 KB123	39	DR2 SC0039	27	DR2 SC0027	1	PR4 FB0012	DR5 TE1U
WB1 KB133	47	DR2 SC0047	39	DR2 SC0039	1	PR4 FB0011	DR5 TE1U
WB1 KB121	56	DR2 SC0056	47	DR2 SC0047	1	PR4 FB0010	–
WB1 KB124	180	DR2-SC0180	120	DR2 SC0120	1	PR4 FB0008	DR5 TE1U
WB1 KB135	270	DR2 SC0270	270	DR2 SC0270	1	PR4 FB0006	–
WB1 KB139	470	DR2 SC0470	390	DR2 SC0390	1	PR4 FB0005	DR5 TE1S
WB1 KB125	680	DR2-SC0680	470	DR2 SC0470	1	PR4 FB0004	DR5 TE1S

For contactors CR1 B●34

WB1 KB132	33	DR2 SC0033	27	DR2 SC0027	1	PR4 FB0014	DR5 TE1U
WB1 KB123	47	DR2 SC0047	33	DR2 SC0033	1	PR4 FB0012	DR5 TE1U
WB1 KB121	56	DR2 SC0056	56	DR2 SC0056	1	PR4 FB0010	–
WB1 KB134	150	DR2 SC0150	120	DR2 SC0120	1	PR4 FB0008	DR5 TE1U
WB1 KB124	180	DR2-SC0180	150	DR2 SC0150	1	PR4 FB0007	DR5 TE1U
WB1 KB122	270	DR2 SC0270	220	DR2 SC0220	1	PR4 FB0007	–
WB1 KB136	390	DR2 SC0390	390	DR2 SC0390	1	PR4 FB0006	DR5 TE1S
WB1 KB139	560	DR2 SC0560	470	DR2 SC0470	1	PR4 FB0005	DR5 TE1S

(1) For connections, see page 5/267.

(2) Weight of resistors DR2 SC●●●● : 0.030 kg.

(3) Weight of automatic coil cut-out contacts: ZC4 GM● : 0.030 kg and PR4 FB00●● : 0.600 kg.

(4) Weight of rectifier DR5 TE1● : 0.100 kg. The rectifier is for use on a.c. only.

TeSys contactors

Magnetic latching contactors

Accessories and replacement parts for contactors CR1 F

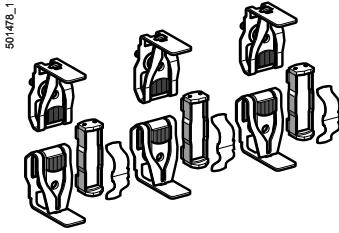

LA5 FG431

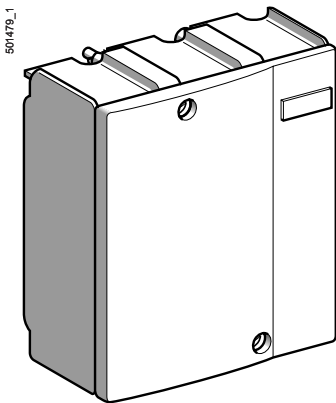

LA5 F40050

References

Description	For contactor		Reference	Weight kg
Complete sets of contacts for 3 or 4 poles (1)	3-pole	CR1 F150	LA5 FF431	0.270
		CR1 F185	LA5 FG431	0.350
		CR1 F265	LA5 FH431	0.660
		CR1 F400	LA5 F400803	0.660
		CR1 F500	LA5 F500803	0.660
		CR1 F630	LA5 F630803	0.660
	4-pole	CR1 F1504	LA5 FF441	0.360
		CR1 F1854	LA5 FG441	0.465
		CR1 F2654	LA5 FH441	0.880
		CR1 F4004	LA5 F400804	0.465
		CR1 F5004	LA5 F500804	0.465
		CR1 F6304	LA5 F630804	0.465
Arc chambers	3-pole	CR1 F150	LA5 F15050	0.490
		CR1 F185	LA5 F18550	0.670
		CR1 F265	LA5 F26550	0.920
		CR1 F400	LA5 F40050	1.300
		CR1 F500	LA5 F50050	1.850
		CR1 F630	LA5 F63050	3.150
	4-pole	CR1 F1504	LA5 F150450	0.660
		CR1 F1854	LA5 F185450	0.910
		CR1 F2654	LA5 F265450	1.220
		CR1 F4004	LA5 F400450	1.740
		CR1 F5004	LA5 F500450	2.500
		CR1 F6304	LA5 F630450	4.200

(1) Set containing the following (per pole): 2 fixed contacts, 1 moving contact, 2 deflectors, 1 back-plate, clamping screws and washers.

TeSys contactors

Magnetic latching contactors

Accessories and replacement parts for contactors CR1 B

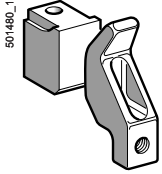

PA1 LB80
(PA1 LB76 + PA1 LB75)

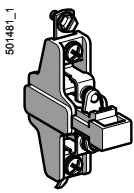

ZC4 GM1

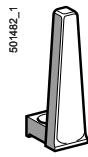

PA1 LB89

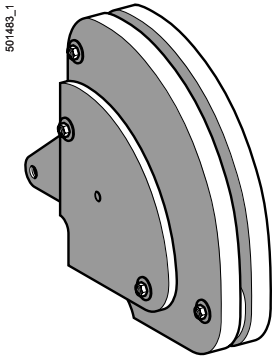

PA1 LB50

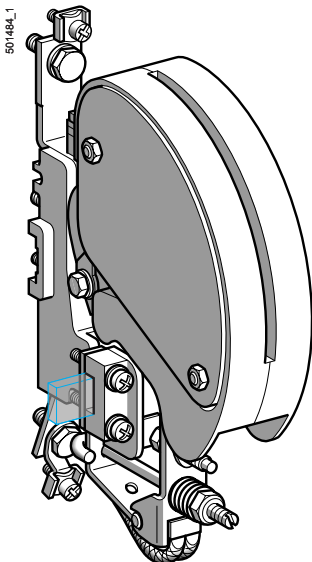

PR4 FB004

References (continued)

Description	For contactors	Number of sets required per pole	Unit reference of set	Weight kg
Sets of contacts (1 moving contact, 1 fixed contact)	CR1 BL	1	PA1 LB80	0.420
	CR1 BM	1	PA1 LB80	0.420
	CR1 BP	2	PA1 LB80	0.420
	CR1 BR	3	PA1 LB80	0.420

Description	For contactors	Composition	Reference	Weight kg
Moving contact only (for one finger)	All ratings	–	PA1 LB75	0.220
Fixed contact only (for one finger)	All ratings	–	PA1 LB76	0.200
Blow-out horn only (for 1 finger)	All ratings	–	PA1 LB89	0.120
Arc chambers (for a single pole)	CR1 BL	–	PA1 LB50	3.700
	CR1 BM	–	PA1 LB50	3.700
	CR1 BP	–	PA1 PB50	6.200
	CR1 BR	–	PA1 RB50	8.500

Auxiliary contact blocks	All ratings	1 N/O contact - normal	ZC4 GM1	0.030
	All ratings	1 N/C contact - normal	ZC4 GM2	0.030
	All ratings	1 N/O contact - gold flashed	ZC4 GM9	0.030
	All ratings	1 N/C contact - gold flashed	ZC4 GM8	0.030

N/C pole for automatic cut-out coil	All ratings	–	PR4 FB004 (1)	0.600
Set of moving and fixed contacts for N/C pole	All ratings	–	PV1 FA80	0.035
Arc chamber for N/C pole	All ratings	–	PN1 FB50	0.220
Electromagnet	All ratings	–	ET1 KB50	10.600

Description	For contactors	No. of parts required	Reference	Weight kg
Return springs for moving part of electromagnet	CR1 B (1 pole)	1	DV1 RT292	0.050
	CR1 B (2, 3 or 4 poles)	2	DV1 RT292	0.050
N/O pole springs	CR1 BL, BM or BP	1 per pole	DV1 RC201	0.020
	CR1 BR	1 per pole	DV1 RC155	0.020

(1) Reference to be completed, see page 5/257.

TeSys contactors

Magnetic latching contactors CR1 F

CR1 F150 to F500

Common side view

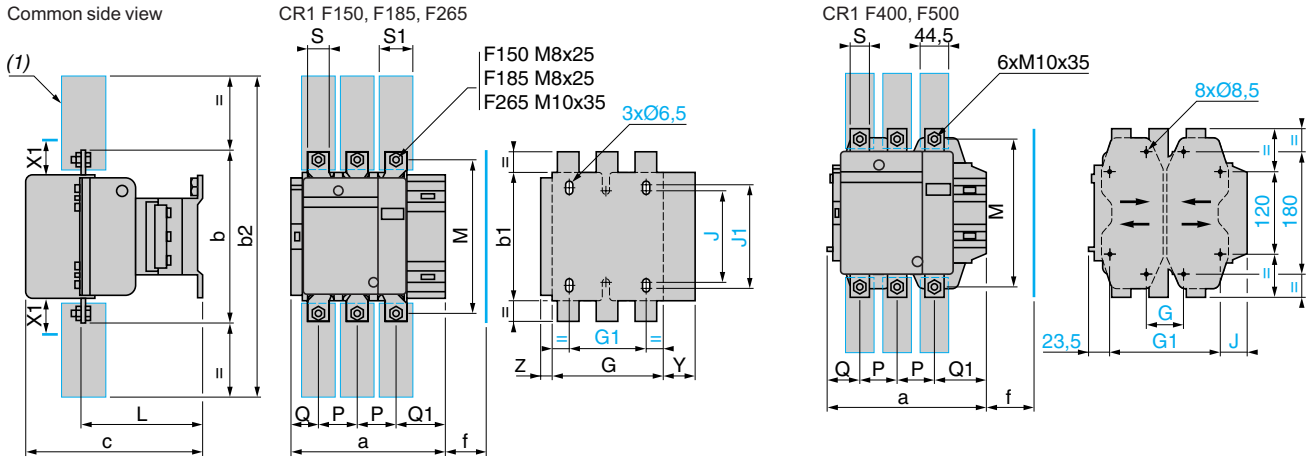

CR1	F150		F185		F265	
	3P	4P	3P	4P	3P	4P
a	163.5	201.5	168.5	208.5	201.5	244.5
b	170	170	174	174	203	203
b1	137	137	137	137	145	145
b2	301	301	305	305	370	370
c	171	171	181	181	213	213
f	131	131	130	130	147	147
G	106	143	111	151	142	190
G1	80	80	80	80	96	96
J	106	106	106	106	106	106
J1	120	120	120	120	120	120
L	107	107	113.5	113.5	141	141
M	150	150	154	154	178	178
P	40	40	40	40	48	48
Q	26	26	29	29	39	34
Q1	57.5	55.5	59.5	59.5	66.5	66.5
S	20	20	20	20	25	25
S1	27	27	34	34	38	38
Y	44	44	38.5	30.5	30.5	21.5
Z	13.5	13.5	13.5	13.5	15.5	15.5

CR1	F400		F500	
	3P	4P	3P	4P
a	213	261	233	288
G min.	66	66	66	66
b	206	206	238	238
b2	375	375	400	400
c	219	219	232	232
f	146	146	150	150
G supplied 80	80	80	80	140
G max.	102	150	120	175
G1 supplied 170	170	170	170	230
G1 min.	156	156	156	156
G1 max.	192	240	210	265
J	12	60	32	27
L	145	145	146	146
M	181	181	208	208
P	48	48	55	55
Q	43	43	47	47
Q1	74	74	77	77
S	25	25	30	30

f = minimum distance required for coil removal.

X1: Minimum electrical clearance according to operational voltage and breaking capacity.

f = minimum distance required for coil removal.

X1: Minimum electrical clearance according to operational voltage and breaking capacity.

Voltage in V	200...500	660...1000
CR1 F150	10	15
CR1 F185	10	15
CR1 F265	10	15

Voltage in V	200...500	660...1000
CR1 F400	15	20
CR1 F500	15	20

(1) Power terminal protection shroud.

CR1 F630

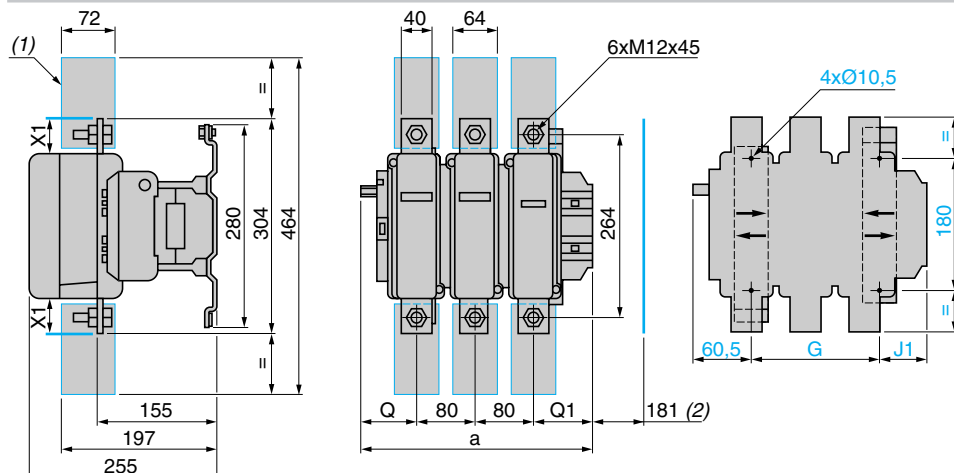

CR1 F630	3P	4P
a	309	389
G supplied	180	240
G min.	100	150
G max.	195	275
J1	61	81
Q	60	60
Q1	89	89

X1: Min. electrical clearance according to operational voltage and breaking capacity.

Voltage in V	X1
200...500	20
690...1000	30

(1) Power terminal protection shroud.
(2) Minimum distance required for coil removal.

TeSys contactors

Magnetic latching contactors CR1 F

CR1 F150...F265

Panel mounted

On pre-slotted mounting plate AM1 PA, PB, PC

On rails DZ5 MB on 120 mm centres

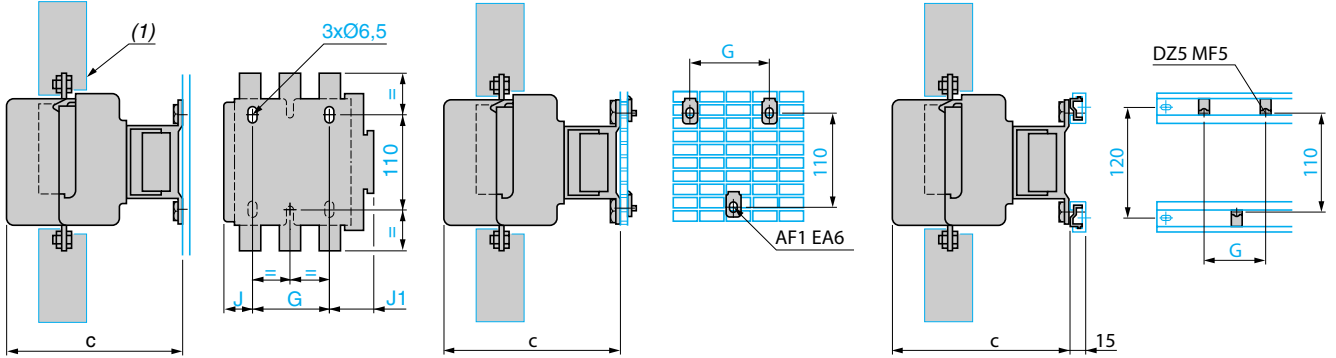

CR1	F150	F185	F265
c	3P 171	181	213
	4P 171	181	213
G	3P 80	80	96
	4P 80	80	96
J	3P 26.5	29	44.5
	4P 45	49	68.5
J1	3P 57	59.5	61.5
	4P 75.5	79.5	85.5

CR1	F150	F185	F265
c	3P 171	181	213
	4P 171	181	213
G	3P 80	80	96
	4P 80	80	96

CR1	F150	F185	F265
c	3P 171	181	213
	4P 171	181	213
G	3P 80	80	96
	4P 80	80	96

(1) Power terminal protection shroud.

CR1 F150...F650

On 2 notched uprights AM1 EC...

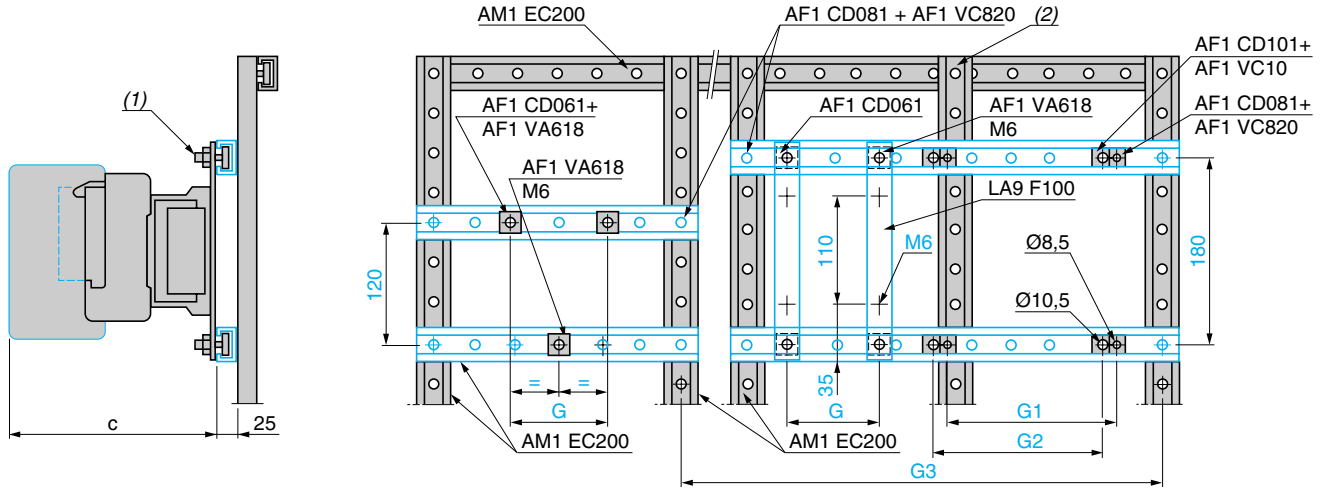

CR1	F150	F185	F265	F400	F500	F630
c	3P 171	181	213	213	226	250
	4P 171	181	213	213	226	250
G (M6)	3P 80	80	96	-	-	-
	4P 80	80	96	-	-	-
G1 (Ø 8.5)	3P -	-	-	80	80	-
	4P -	-	-	80	140	-
G2 (Ø 10.5)	3P -	-	-	-	-	180
	4P -	-	-	-	-	240

(1) AF1 CD... or AF1 VA...

(2) This AM1 EC200 upright is required when G2 or G3 is greater than 700 mm (please consult your Regional Sales Office).

Reversing contactors 2 x CR1 F150...F265

Horizontally mounted

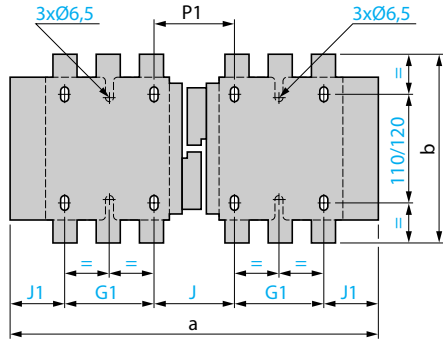

Reversing contactors 2 x CR1 F400...F630

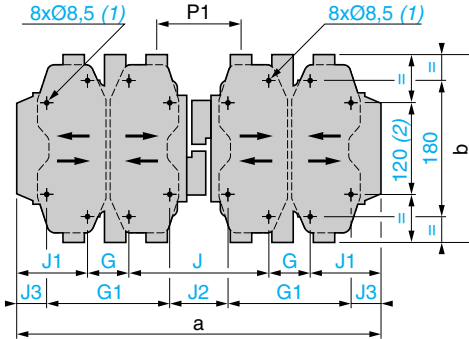

2 x CR1	F150	F185	F265	
a	3P	345	357	425
	4P	422	437	521
b	3P	170	174	203
	4P	170	174	203
G1	3P	80	80	96
	4P	80	80	96
J	3P	71	78	109
	4P	111	118	157
J1	3P	57	59.5	61.5
	4P	75.5	79.5	85.5
P1	3P	71	78	100
	4P	71	78	100

2 x CR1	F400	F500	F630	
a	3P	446	485	636
	4P	542	595	796
b	3P	206	238	304
	4P	206	238	304
G	3P	80	80	180
	4P	80	140	240
G1	3P	170	170	—
	4P	170	230	—
J	3P	157	156	139
	4P	157	156	139
J1	3P	64.5	84.5	68.5
	4P	112.5	79.5	68.5
J2	3P	67	66	—
	4P	67	66	—
J3	3P	19.5	39.5	—
	4P	67.5	34.5	—
P1	3P	107	112	137
	4P	107	112	137

(1) Except F630: 4 x Ø 10.5.
 (2) Except F630: 180.

Reversing contactors

Vertically mounted with mechanical interlock LA9 F●●●.
 2 contactors CR1 F of identical or different ratings (CR1 F150...F630), see pages 5/252 and 5/253.

Assembly A

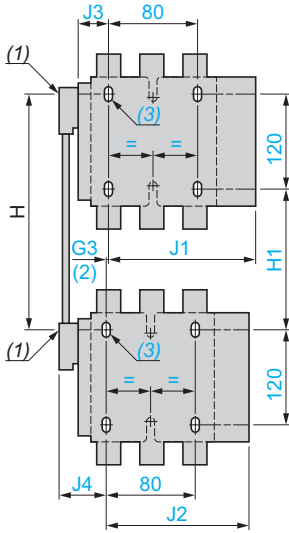

Assembly B

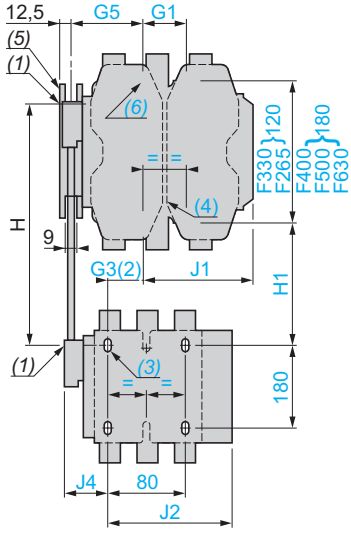

Assembly C

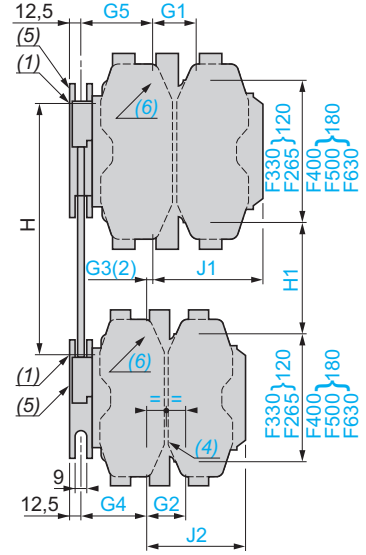

- (1) Mechanical interlock shaft.
- (2) For assembly of contactors of different ratings only.
- (3) 3 x Ø 6.5 mm for CR1 F150...F265.
- (4) 3 x Ø 6.5 mm for CR1 F265.
- (5) Mechanical interlock guide bracket.
- (6) 4 x Ø 8.5 mm for CR1 F400, F500 or 4 x Ø 10.5 mm.

Assembly type LA9 F	A			B								C									
	F4F	G4F	G4G	H4F	J4F	K4F	L4F	H4G	J4G	K4G	L4G	H4H	J4H	K4H	L4H	J4J	K4J	L4J	K4K	L4K	L4L
G1	3P	-	-	-	96	80	80	180	96	80	80	180	96	80	80	180	80	180	80	180	180
	4P	-	-	-	96	80	140	240	96	80	140	240	96	80	140	240	80	140	240	240	240
G2	3P	-	-	-	-	-	-	-	-	-	-	96	96	96	96	80	80	80	80	80	180
	4P	-	-	-	-	-	-	-	-	-	-	96	96	96	96	80	80	140	140	240	240
G3	3P	0	3	0	21	45	45	35	19	42	42	0	23	23	14	0	0	9 (7)	0	9 (7)	0
	4P	0	4	0	27	26	26	17	23	22	22	0	0	0	9 (7)	0	0	9 (7)	0	9 (7)	0
G4	3P	-	-	-	-	-	-	-	-	-	-	60	60	60	60	83	83	83	83	83	74
	4P	-	-	-	-	-	-	-	-	-	-	83	83	83	83	83	83	83	83	83	74
G5	3P	-	-	-	60	83	83	74	60	83	83	60	83	83	74	83	83	74	83	74	74
	4P	-	-	-	83	83	83	74	83	83	83	83	83	83	74	83	83	74	83	74	74
H	min.	200	210	220	240	250	270	310	250	250	270	250	260	280	330	260	280	325	300	345	380
	max.	310	300	310	380	380	380	380	380	380	380	380	380	380	380	380	380	380	380	380	380
H1	min.	80	90	100	110	80	100	140	120	90	110	130	110	130	170	60	100	140	120	160	200
	max.	190	180	190	250	210	210	210	250	220	220	260	230	230	220	200	200	195	200	195	200
J1	3P	133	134	134	149.5	137	157	241	149.5	137	157	149.5	137	157	24	137	157	241	157	244	241
	4P	145	146	146	164.5	185	212	321	164.5	185	212	164.5	185	212	321	185	212	321	212	321	321
J2	3P	133	133	134	183	133	183	133	134	134	134	142.5	149.5	149.5	149.5	137	137	137	157	157	241
	4P	145	145	146	145	145	145	145	146	146	146	164.5	164.5	164.5	164.5	185	185	185	212	212	312
J3	3P	48.5	53	53	-	-	-	-	-	-	-	-	-	-	-	-	-	-	-	-	-
	4P	67	73	73	-	-	-	-	-	-	-	-	-	-	-	-	-	-	-	-	-
J4	3P	48.5	54	53	48.5	48.5	48.5	48.5	53	53	53	-	-	-	-	-	-	-	-	-	-
	4P	67	69	73	67	67	67	67	73	73	73	-	-	-	-	-	-	-	-	-	-

(7) In this case, G4 is greater than G5.

TeSys contactors

Magnetic latching contactors CR1 B

Contactors CR1 B

Single-pole, 2-pole or 3-pole

4-pole

Common side view

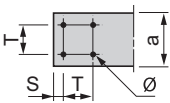
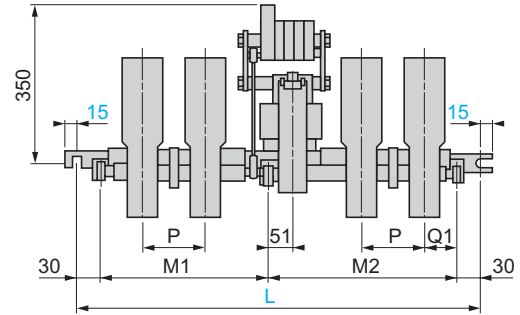
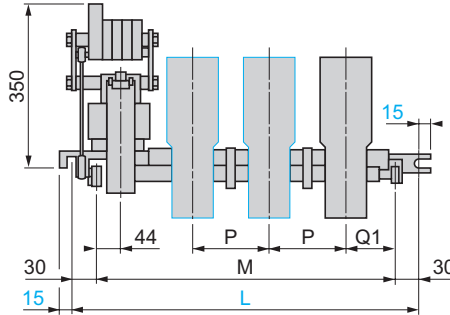
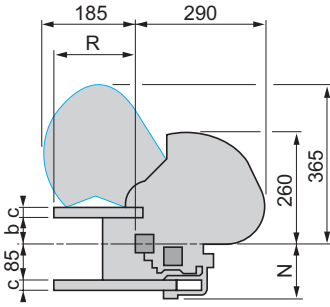

	CR1 BL				CR1 BM				CR1 BP				CR1 BR			
	1P	2P	3P	4P	1P	2P	3P	4P	1P	2P	3P	4P	1P	2P	3P	4P
a	50	50	50	50	63	63	63	63	100	100	100	100	125	125	125	125
b	59	59	59	59	55	55	55	55	55	55	55	55	50	50	50	50
c	16	16	16	16	20	20	20	20	20	20	20	20	25	25	25	25
L	345	445	540	760	345	445	540	760	385	540	760	1065	445	635	885	1065
M	285	385	480	-	285	385	480	-	325	480	700	-	385	575	825	-
M1	-	-	-	308	-	-	-	308	-	-	-	455	-	-	-	455
M2	-	-	-	392	-	-	-	392	-	-	-	550	-	-	-	550
N	121	121	121	121	125	125	125	125	125	125	125	125	130	130	130	130
P	100	100	100	100	100	100	100	100	150	150	150	150	195	195	195	195
Q1	100	100	100	100	100	100	100	100	110	110	110	110	123	123	123	123
R	122	122	122	122	157	157	157	157	173	173	173	173	173	173	173	173
S	10	10	10	10	17	17	17	17	20	20	20	20	20	20	20	20
T	30	30	30	30	30	30	30	30	60	60	60	60	60	60	60	60
Ø	9	9	9	9	11	11	11	11	11	11	11	11	11	11	11	11

Minimum electrical clearance

Values X1 and X2 are given for a breaking capacity of 10 In (3-phase ~ current).

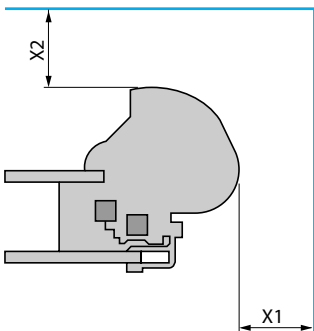

3-phase ~ voltage		CR1 BL	CR1 BM	CR1 BP	CR1 BR
380-415-440 V	X1	100	100	150	200
	X2	150	150	200	250
500 V	X1	100	100	150	200
	X2	150	150	220	250
600 V	X1	150	150	200	200
	X2	200	200	250	250
1000 V	X1	200	200	200	250
	X2	250	250	250	300

Mechanical interlock for assembly of vertically mounted reversing contactors EZZ LB0601

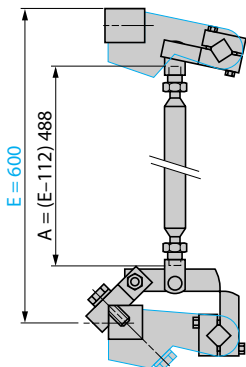

501391_1

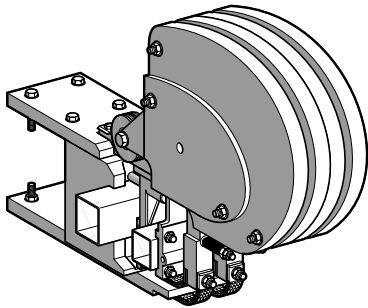

Complete pole

Adjustment of pick-up travel and pull-in travel

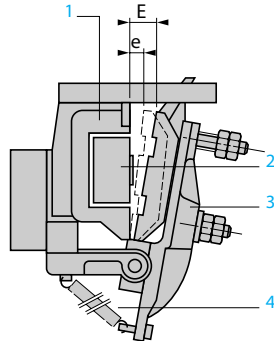

- 1 Moving circuit
- 2 Coil
- 3 Moving circuit
- 4 Return spring

N/O pole adjustment

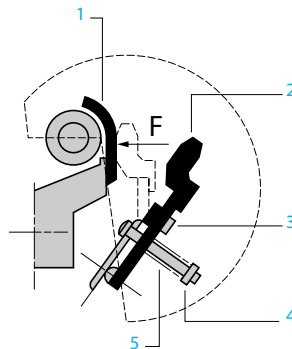

- 1 Fixed contact
- 2 Moving contact
- 3 Pull-in gap adjustment
- 4 Adjustment of application force
- 5 Pole spring

N/C automatic coil cut-out pole adjustment

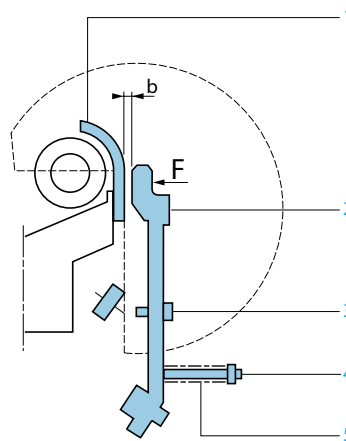

- 1 Fixed contact
- 2 Moving contact
- 3 Opening gap adjustment
- 4 Adjustment of application force
- 5 Pole spring

5

a.c. or d.c. supply with economy resistor (and rectifier on ~)

Contactor type			CR1 BL	CR1 BM	CR1 BP	CR1 BR
Electromagnet (EB5 KB50)	Pick-up travel (E)	mm	30	30	30	30
	Pull-in travel (e)	mm	10	10	10	10
Coil (WB1 KB)	Pull-in voltage	V	0.75 U _c	0.75 U _c	0.75 U _c	—
	Drop-out voltage	V	0.3...0.5 U _c	0.3...0.5 U _c	0.3...0.5 U _c	0.3...0.5 U _c
N/O power pole (PA1)	Application force (F) to contact per pole	daN	30	30	30 (1)	30 (2)
N/C automatic coil cut-out pole (PR4)	Application force (F)	daN	0.9	0.9	0.9	0.9
	Opening gap (b) with electromagnet closed	mm	3.5 ± 0.5	3.5 ± 0.5	3.5 ± 0.5	3.5 ± 0.5

(1) Each pole has 2 contacts: the force must be applied evenly to each of these contacts.
 (2) Each pole has 3 contacts: the force must be applied evenly to each of these contacts.

Contactors CR1 F

3-pole

4-pole

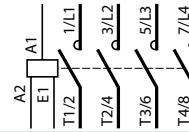
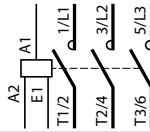

Instantaneous auxiliary contacts (References : page 5/123)

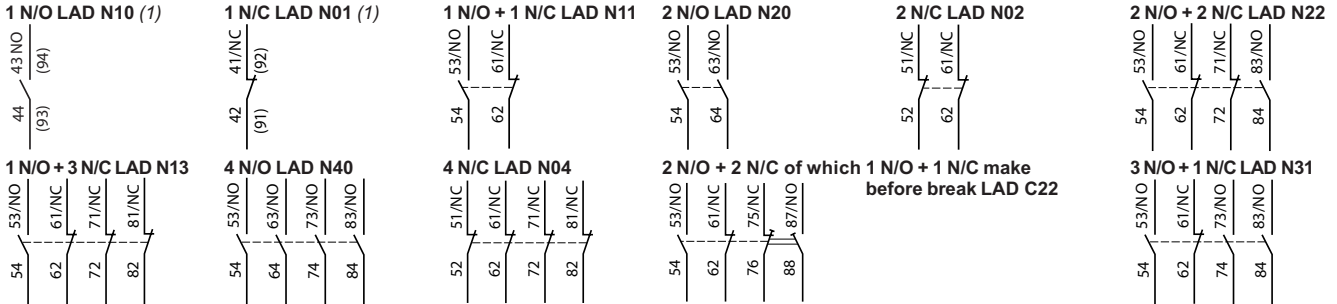

(1) Items in brackets refer to blocks mounted on right-hand side of contactor.

Instantaneous auxiliary contacts conforming to standard EN 50012 (References: page 5/123)

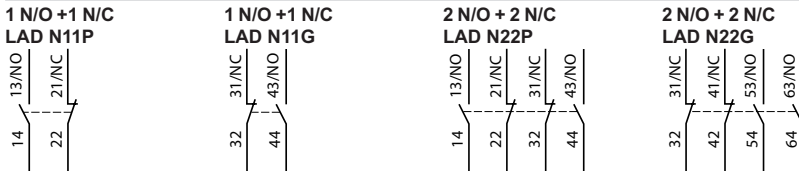

Front mounting add-on contact blocks - Dust and damp protected instantaneous auxiliary contacts (References : page 5/123)

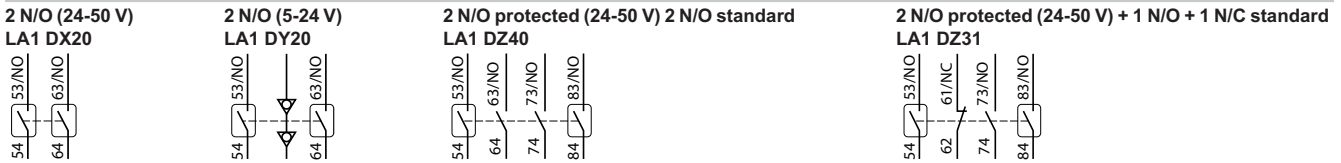

Time delay auxiliary contacts (References : page 5/123)

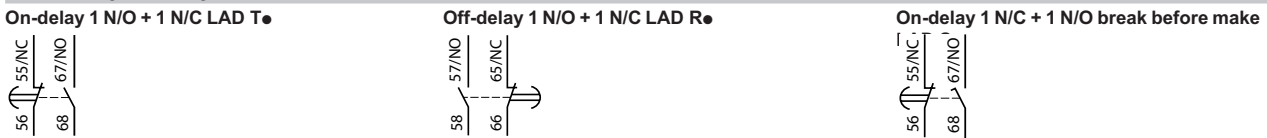

3-pole reversing contactors 2 x CR1 F150...F630

4-pole reversing contactors 2 x CR1 F1504...F6304

Horizontally mounted

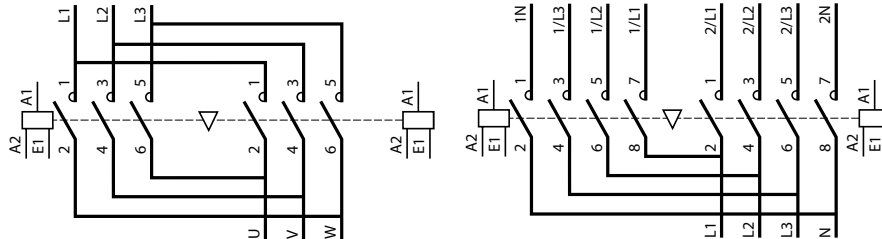

Vertically mounted contactors using 2 contactors of identical or different ratings

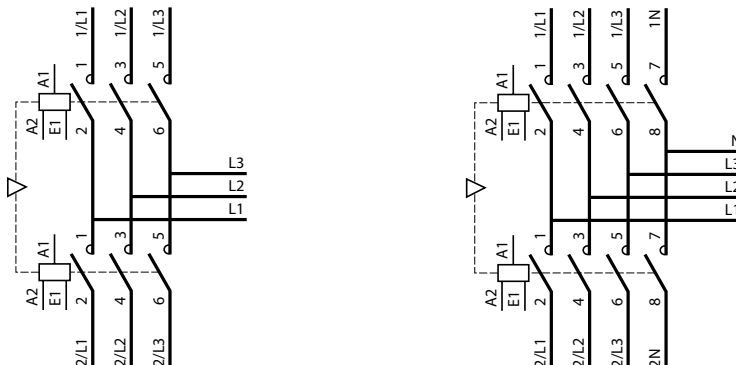

Contactors CR1 B

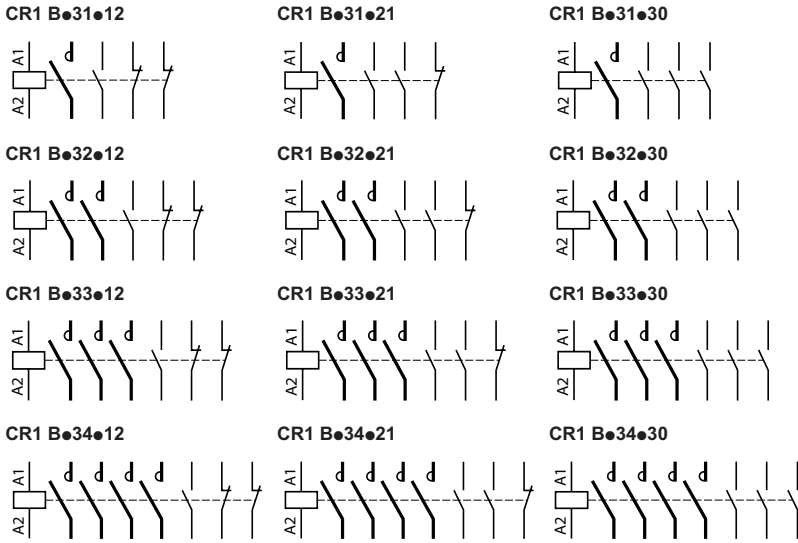

Wiring schemes

Contactors CR1 F and CR1 B with thermal overload relay

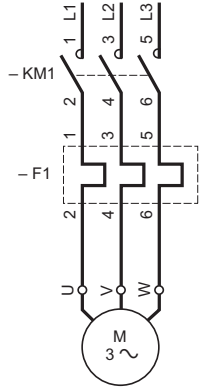

Contactors CR1 F

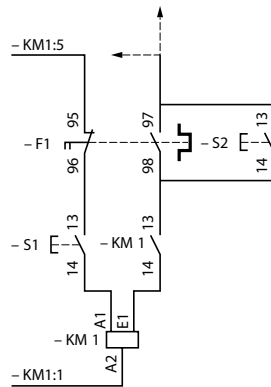

Connectors CR1 B

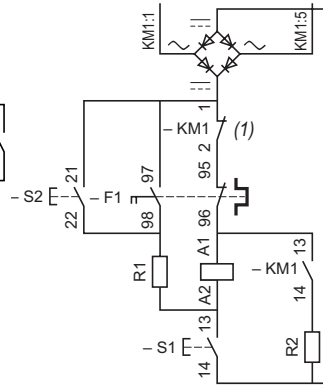

(1) automatic coil cut-out contact ZC4 GM or PR4 FB00●●
 S1: latching pushbutton
 S2: unlatching pushbutton

Coils for contactors CR1 F

Pushbutton control

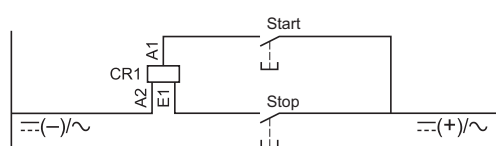

Switch control

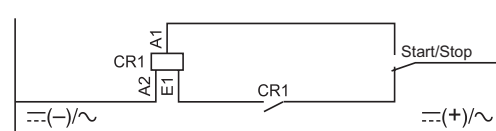

Scheme of internal circuit

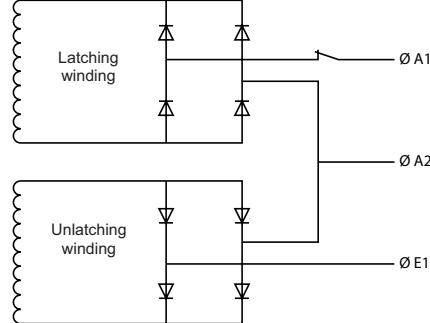

Warning: terminal A2 is common to both windings in all cases.

Applications	Control of lighting, heating, hot water systems, ventilation systems and small motors	
		
Functions	GC contactors for standard applications	GY "Dual tariff" contactors
Rating	16...63 A	16...63 A
Number of 17.5 mm modules (variable, depending on size and number of poles)	1...3	1...4
Device type	GC	GY
Pages	5/278	5/292

5

Control of lighting heating, hot water systems, ventilation systems and small motors

Direct control of motors

Fuse protection

Motor control and protection



Impulse relays

Rotary switch disconnectors

Single, 2, 3 or 4-pole fuse carriers, with or without neutral

Thermal-magnetic motor circuit-breakers

16 A

25...80 A

Up to 125 A

0.1...32 A

1

2.5

1...8

2.5

GF 16

VVD, VVE

DF8, DF10, DF14, DF22

GV2 M

5/286

Please consult your Regional Sales Office

4/26

3/46

53862



GC 25

Presentation

TeSys GC contactors are designed for use in modular panels and enclosures. These contactors feature:

■ Easy installation

- quick clip-on fixing and locking onto 35 mm omega rail,
- easy connection by means of ready-to-tighten, captive, pozidrive screw terminals.

■ Compact size

All units have a common depth of 60 mm and width in modules of 17.5 mm (width of one module: 17.5 mm).

■ User safety

- use of materials conforming to strictest fire safety standards,
- live parts protected against direct finger contact,
- completely safe operation,
- state indication on front panel.

Standards

This range of modular contactors has been designed taking into account the requirements of international standard IEC 61095.

This standard is specific to "Electromagnetic contactors for domestic and similar use".

It has very strict requirements, meeting the expectations of users, with regard to the safety of equipment and persons in "premises and areas accessible to the public".

Conformity with this standard makes it possible to obtain the following quality labels without the need for additional tests: NF-USE, VDE, CEBEC, etc.

Applications

TeSys GC modular contactors are designed for switching all single-phase, 3-phase or 4-phase loads up to 100 A.

Power switching

These contactors have multiple applications in industrial, agricultural and commercial premises, hospitals and the home, i.e. wherever switching of a specific supply is required:

- lighting,
- heating,
- ventilation,
- motorised shutters or gates.

Setting-up precautions

The contactor controls must be bounce free. If not, connect a coil suppression block **1** (GAP 21, 22 or 23) across the coil terminals ≤ 250 V.

When several contactors which operate at the same time are mounted side by side, a GAC 5 ventilation 1/2 module **2** must be fitted every 2 contactors.

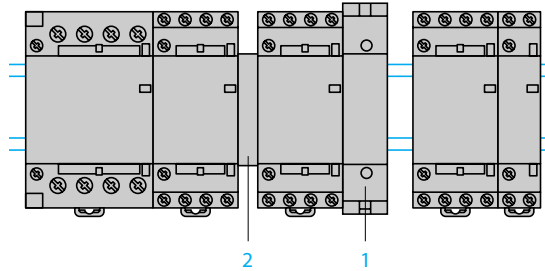

It is advisable to mount electronic units at the bottom of the modular panel and to separate them from electromechanical units by a space **3** equal to one module, or by 2 ventilation 1/2 modules (GAC 5).

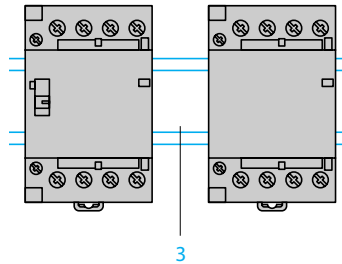

Derating of contactors mounted in a modular enclosure if the temperature within the enclosure is > 40 °C

Contactor rating	40 °C	50 °C	60 °C (1)
16 A	16 A	14 A	13 A
25 A	25 A	22 A	20 A
40 A	40 A	36 A	32 A
63 A	63 A	57 A	50 A
100 A	100 A	87 A	80 A

(1) Ventilation 1/2 module must be fitted

Lighting (Maximum number of lamps depending on the power of each unit)

Presentation of installations according to type of supply

Single-phase circuit, 230 V

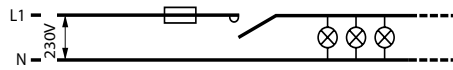

3-phase circuit, 230 V

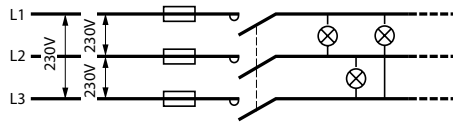

The maximum number of lamps which can be operated per phase is equal to the number of lamps in the "single phase 230 V" table divided by $\sqrt{3}$.

3-phase circuit, 400 V (with neutral)

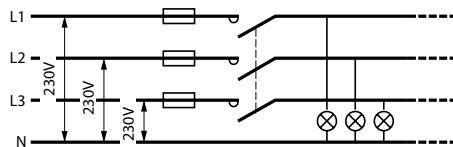

The maximum number of lamps which can be operated per phase is equal to the total number of lamps in the "single-phase 230 V" table.

Contactor rating for a single-phase 230 V circuit (single-pole)

Fluorescent lamps with starter

Single fitting	Non corrected					With parallel correction					Contactor rating
	P (W)	I _B (A)	C (μF)	Maximum number of lamps		P (W)	I _B (A)	C (μF)	Maximum number of lamps		
	20	0.39	-	22	30	20	0.43	-	20	30	16 A
	50	0.70	-	13	17	40	0.82	-	15	20	25 A
	80	0.80	-	10	15	58	0.96	-	10	14	40 A
	110	1.2	-	7	10	80	1.3	-	5	7	63 A
						110	0.79	-	15	7	
						16	-	-	5	20	

Twin fitting	Non corrected					With series correction					Contactor rating
	P (W)	I _B (A)	C (μF)	Maximum number of lamps		P (W)	I _B (A)	C (μF)	Maximum number of lamps		
	2 x 18	0.44	-	20	30	2 x 18	0.26	3.5	30	46	16 A
	2 x 36	0.82	-	11	16	2 x 36	0.48	4.5	17	25	25 A
	2 x 58	1.34	-	7	10	2 x 58	0.78	7	10	13	40 A
	2 x 80	1.64	-	5	8	2 x 80	0.96	9	9	10	63 A
	2 x 140	2.2	-	4	6	2 x 140	1.3	18	6	6	

High pressure mercury vapour lamps

	Non corrected							With parallel correction							Contactor rating	
	P (W)	I _B (A)	C (μF)	Maximum number of lamps				P (W)	I _B (A)	C (μF)	Maximum number of lamps					
	50	0.6	-	15	20	34	53	50	0.35	7	10	15	20	34	53	16 A
	80	0.8	-	10	15	27	40	80	0.50	8	10	13	20	28	43	25 A
	125	1.15	-	8	10	20	28	125	0.7	10	18	10	11	20	25	40 A
	250	2.15	-	4	6	10	15	250	1.5	18	25	6	4	8	12	63 A
	400	3.25	-	2	4	6	8	400	2.4	25	40	4	3	5	7	
	700	5.4	-	1	2	4	6	700	4	40	60	2	1	3	5	
								1000	5.7	60		-	1	1	1	

I_B : value of current drawn by each lamp at its rated voltage.

C : unit capacitance for each lamp.

I_B and C correspond to values normally quoted by lamp manufacturers

Contactor rating for a single-phase 230 V circuit (single-pole) (continued)

Low pressure sodium vapour lamps

	Non corrected						With parallel correction						Contactor rating
P (W)	18	35	55	90	135	180	18	35	55	90	135	180	–
I_B (A)	0.35	1.4	1.4	2.1	3.1	3.1	0.35	0.6	0.6	0.9	0.9	0.9	–
C (μF)	–	–	–	–	–	–	5	20	20	26	45	40	–
Maximum number of lamps	18	4	5	3	2	2	14	3	3	2	1	1	16 A
	34	9	9	6	4	4	21	5	5	4	2	2	25 A
	57	14	14	9	6	6	40	10	10	8	4	5	40 A
	91	24	24	19	10	10	60	15	15	11	6	7	63 A

High pressure sodium vapour lamps

	Non corrected					With parallel correction					Contactor rating
P (W)	70	150	250	400	1000	70	150	250	400	1000	–
I_B (A)	1	1.8	3	4.4	10.3	0.6	0.7	1.5	2.5	6	–
C (μF)	–	–	–	–	–	12	20	32	45	100	–
Maximum number of lamps	8	4	2	1	–	6	6	2	2	1	16 A
	12	7	4	3	1	9	9	3	4	2	25 A
	20	13	8	5	2	18	18	6	8	4	40 A
	32	18	11	8	3	25	25	9	12	6	63 A

Metal iodine or halogen vapour lamps

	Non corrected						With parallel correction						Contactor rating	
P (W)	35	70	150	250	400	1000	39	70	150	250	400	1000	2000	–
I_B (A)	0.3	0.5	1	1.5	2.5	6	0.3	0.5	1	1.5	2.5	6	5.5	–
C (μF)	–	–	–	–	–	–	6	12	20	32	45	85	60	–
Maximum number of lamps	27	16	8	5	3	1	12	6	4	3	2	–	1	16 A
	40	24	12	8	5	2	18	9	6	4	3	1	2	25 A
	68	42	20	14	8	4	31	16	10	7	5	3	3	40 A
	106	64	32	21	13	5	50	25	15	10	7	4	5	63 A

Incandescent and halogen lamps

											Contactor rating
P (W)	60	75	100	150	200	300	500	1000			–
I_B (A)	0.26	0.32	0.44	0.65	0.87	1.3	2.17	4.4			–
Maximum number of lamps	30	25	19	12	10	7	4	2			16 A
	45	38	28	18	14	10	6	3			25 A
	85	70	50	35	26	18	10	6			40 A
	125	100	73	50	37	25	15	8			63 A

Halogen lamps used with transformer

					Contactor rating
P (W)	60	80	105	150	–
I_B (A)	0.26	0.35	0.45	0.65	–
Maximum number of lamps	9	8	6	4	16 A
	14	12	9	6	25 A
	27	23	18	13	40 A
	40	35	27	19	63 A

I_B: value of current drawn by each lamp at its rated voltage.

C: unit capacitance for each lamp.

I_B and C correspond to values normally quoted by lamp manufacturers

Heating (AC-7a)

Single-phase, 2-pole switching

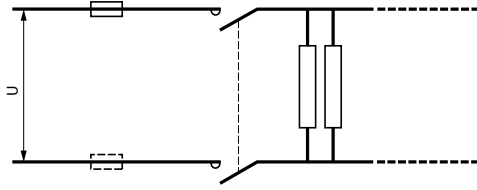

3-phase switching

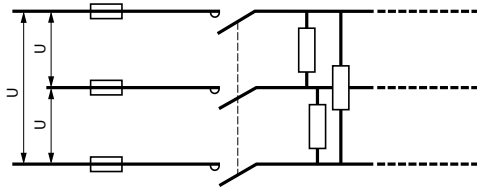

Heating by resistive elements or by infra-red radiators, convectors or radiators, heating ducts, industrial furnaces. The current peak between the hot and cold states must not exceed 2 to 3 In at the moment of switch-on.

Contactor selection according to power and required electrical life

Electrical durability (in operating cycles)	Maximum power (kW)					Contactor rating
	100 x 10 ³	150 x 10 ³	200 x 10 ³	500 x 10 ³	10 ⁶	
Single-phase switching 230 V (2-pole)	3.5	3	2.2	1	0.8	16 A
	5.4	4.6	3.5	1.6	1.2	25 A
	8.6	7.4	5.6	2.6	1.9	40 A
	13.6	11.6	8.8	4	3	63 A
	21.6	18.4	14	6.4	4.8	100 A
3-phase switching 400 V (3-pole)	10	9	6.5	3.2	2.2	16 A
	16	14	10	5	3.5	25 A
	26	22	17	7.5	6	40 A
	41	35	26.5	12	9	63 A
	64.8	55.2	42	19.2	14.4	100 A

Motor control (AC-7b)

Single-phase circuit, 230 V

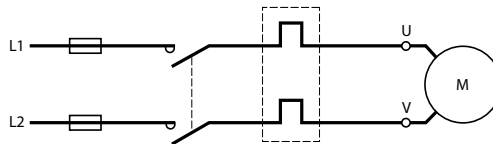

3-phase circuit, 400 V

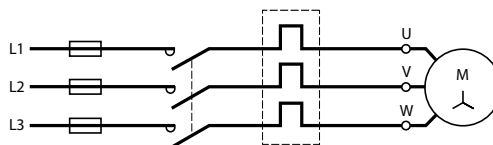

Contactor selection according to maximum power in kW

230 V single-phase capacitor motor (2-pole)	400 V 3-phase motor	Contactor rating (Ith)
0.55	2.2	16 A
1.1	4	25 A
2.2	7.5	40 A
4	11	63 A

Contactor type			GC16	GC25	GC40	GC63	GC100
Environment							
Rated insulation voltage (Ui)	Conforming to IEC 61095	V	500				
	Conforming to VDE 0110	V	500				
Rated impulse withstand voltage (Uimp)		kV	4 in enclosure				
Conforming to standards			IEC 61095, VDE 0637-3 and IEC 60947-5 for auxiliary contacts				
Product certifications			NF- USE, VDE, CEBEC, ÖVE				
Degree of protection	Conforming to VDE 0106		Protection against direct finger contact (IP 20 open, IP 40 in enclosure)				
Protective treatment	Standard version		"TC"				
Ambient air temperature around the device	Storage	°C	- 40...+ 70				
	Operation	°C	- 5...+ 50 (0.85...1.1 Uc)				
Maximum operating altitude	Without derating	m	3000				
Operating positions	Without derating		± 30° in relation to normal vertical mounting plane				
Shock resistance 1/2 sine wave = 10 ms	Contactor open		10 gn				
	Contactor closed		15 gn				
Vibration resistance 5...300 Hz	Contactor open		2 gn				
	Contactor closed		3 gn				
Flame resistance			Conforming to IEC 61095				

Pole characteristics								
Number of poles			2, 3 or 4					
Rated operational current (Ie) (Ue ≤ 440 V)	In AC-7a (heating)	A	16	25	40	63	100	
	In AC-7b (motor control)	A	5	8.5	15	25	–	
Rated operational voltage (Ue)	Up to	V	250 two-pole contactors, 415 three and four-pole contactors					
Frequency limits	Of the operating current	Hz	400					
Conventional thermal current (Ith)	θ ≤ 50 °C	A	16	25	40	63	100	
Rated breaking and making capacity	Conforming to IEC 61095 (AC-7b) I rms 400 V 3-phase	A	40	68	120	200	–	
Permissible short time rating no current flowing for preceding 15 minutes with θ ≤ 40 °C	For 10 s	A	128	200	320	504	800	
	For 30 s	A	40	62	100	157	250	
Short-circuit protection by fuse or circuit breaker U ≤ 440 V	gl fuse	A	16	25	40	63	100	
	Circuit-breaker I _{pn} 230 V (at 3 kA rms prospective) 400 V	A ² s	5000	10 000	16 000	18 000	–	
		A ² s	9000	14 000	17 500	20 000	–	
Average impedance per pole	At Ith and 50 Hz	mΩ	2.5	2.5	2	2	1	
Power dissipated per pole	For the above operational currents	W	0.65	1.6	3.2	8	10	
Maximum cabling c.s.a.	Flexible cable without cable end	1 conductor	mm ²	6	6	25	25	35
		2 conductors	mm ²	4	4	16	16	–
	Flexible cable with cable end	1 conductor	mm ²	6	6	16	16	35
		2 conductors	mm ²	1.5	1.5	4	4	–
	Solid cable without cable end	1 conductor	mm ²	6	6	25	25	35
		2 conductors	mm ²	4	4	6	6	10
Tightening torque	Power circuit connections	N.m	0.8	0.8	3.5	3.5	3.5	

Contactor type		GC16, GC25 single or 2-pole	GC16, GC25 3 or 4-pole GC40, GC63 2-pole	GC40, GC63 3 or 4-pole GC100 2-pole	GC100 4-pole		
Control circuit characteristics							
Rated control circuit voltage (Uc)	50 or 60 Hz	V	12...240 V, for other voltages, please consult your Regional Sales Office				
Control voltage limits ($\theta \leq 50\text{ }^{\circ}\text{C}$)	50 Hz coils	Operational	0.85...1.1 Uc				
		Drop-out	0.2...0.75 Uc				
Average coil consumption at 20 °C and at Uc	~ 50 Hz	Inrush	VA	15	34	53	106
		Sealed	VA	3.8	4.6	6.5	13
Maximum heat dissipation	50/60 Hz	W	1.3	1.6	2.1	4.2	
Operating time	Closing "C"	ms	10...30				
	Opening "O"	ms	10...25				
Mechanical durability	In operating cycles		10 ⁶				
Maximum operating rate at ambient temperature $\leq 50\text{ }^{\circ}\text{C}$	In operating cycles per hour		300				
Maximum cabling c.s.a.	Flexible cable without cable end	1 or 2 conductors	mm²	2.5			
		1 conductor	mm²	2.5			
	Flexible cable with cable end	1 conductor	mm²	2.5			
		2 conductors	mm²	1.5			
Solid cable without cable end	1 or 2 conductors	mm²	1.5				
Tightening torque		N.m	0.8				
Instantaneous auxiliary contact characteristics							
Rated operational voltage (Ue)	Up to	V	250				
Rated insulation voltage (Ui)	Conforming to IEC 60947-5	V	500				
	Conforming to VDE 0110	V	500				
Conventional thermal current (Ith)	For ambient $\theta \leq 50\text{ }^{\circ}\text{C}$	A	5				
Mechanical durability	Operating cycles		10 ⁶				
Maximum cabling c.s.a.	Flexible or solid conductor	mm²	2.5				
Tightening torque		N.m	0.8				

526285



GC 2520

526286



GC 4040

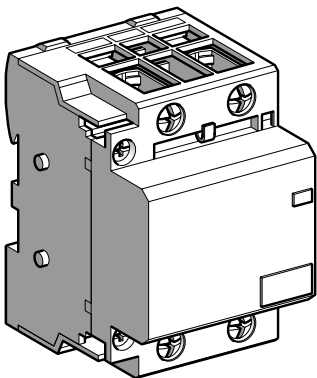

GC 10020

Standard contactors, TeSys GC

Maximum current rating category AC-7a	No. of poles	Number of 17.5 mm modules	Sold in lots of	Basic reference, to be completed by adding the voltage code (1)	Weight	
A						
kg						
16	1	–	1	12	GC 1610●●	0.110
	2	–	1	12	GC 1620●●	0.110
	3	–	2	6	GC 1630●●	0.230
	4	–	2	6	GC 1640●●	0.230
	1	1	1	12	GC 1611●●	0.110
	2	2	2	6	GC 1622●●	0.230
25	1	–	1	12	GC 2510●●	0.110
	2	–	1	12	GC 2520●●	0.110
	3	–	2	6	GC 2530●●	0.230
	4	–	2	6	GC 2540●●	0.230
	1	1	1	12	GC 2511●●	0.110
	2	2	2	6	GC 2522●●	0.230
	–	2	1	12	GC 2502●●	0.110
	–	4	2	6	GC 2504●●	0.230
40	2	–	2	6	GC 4020●●	0.230
	3	–	3	4	GC 4030●●	0.350
	4	–	3	4	GC 4040●●	0.390
	1	1	2	6	GC 4011●●	0.230
	2	2	3	4	GC 4022●●	0.390
	–	2	2	6	GC 4002●●	0.230
	–	4	3	4	GC 4004●●	0.390
	63	2	–	2	6	GC 6320●●
3		–	3	4	GC 6330●●	0.390
4		–	3	4	GC 6340●●	0.390
1		1	2	6	GC 6311●●	0.340
2		2	3	4	GC 6322●●	0.390
–		2	2	6	GC 6302●●	0.340
–		4	3	4	GC 6304●●	0.390
100	2	–	3	4	GC 10020●●	0.680
	4	–	6	2	GC 10040●●	0.780

(1) Standard control circuit voltages (for other voltages, please consult your Regional Sales Office):

Volts	12	24	48	110	220/240
50 Hz	J5	B5	E5	F5	M5
60 Hz	J6	B6	E6	F6	M6



GAC 05●●



GAC 2●

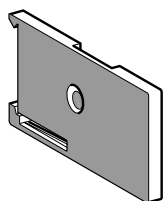

GAC 5



GA1 C●

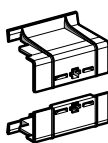

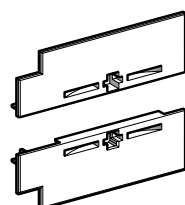

GW 254



GW 63●

Instantaneous auxiliary contact blocks

Number of contacts	No. of poles			Reference	Weight kg
					
2	1	1	-	GAC 0521	0.016
-	-	2	-	GAC 0531	0.016
-	-	-	1	GAC 0511	0.016

Accessories

Description	For use on contactor	Number of modules	Operational voltage	Sold in lots of	Unit reference	Weight kg
			V			
Coil suppression blocks comprising 2 RC circuits	-	1	12...48	1	GAP 21	0.090
	-	-	110...240	1	GAP 23	0.090
Ventilation 1/2 module Clips onto rail	-	1/2	-	10	GAC 5	0.015
Cover plates	-	1/2	-	10	GA1 C7	0.001
		1	-	10	GA1 C6	0.001
Set of sealable terminal covers (10 top parts + 10 bottom parts)	16 or 25 A 3 or 4 contacts	2	-	1	GW 254	0.040
	40 or 63 A 2 contacts	2	-	1	GW 632	0.040
	40 or 63 A 3 or 4 contacts	3	-	1	GW 634	0.050

Dimensions

Contactors

Common side view

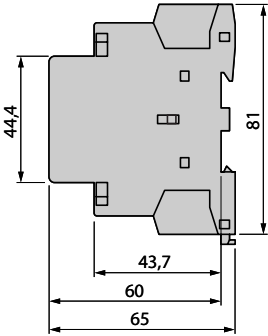

GC 1610, 1611, 1620
GC 2502, 2510, 2511, 2520

1 module



GC 1622, 1640
GC 2504, 2522, 2530, 2540

2 modules

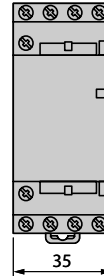

Common side view

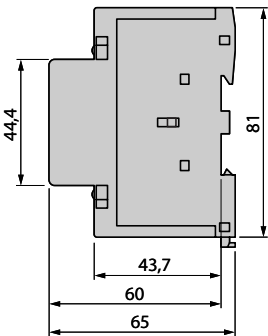

GC 4002, 4011, 4020
GC 6302, 6311, 6320

2 modules



GC 4004, 4022, 4030, 4040
GC 6304, 6322, 6330, 6340

3 modules

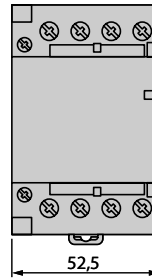

Common side view

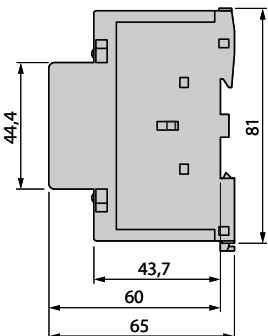

GC 10020

3 modules

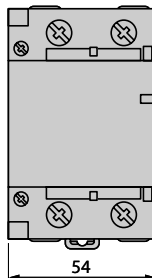

GC 10040

6 modules

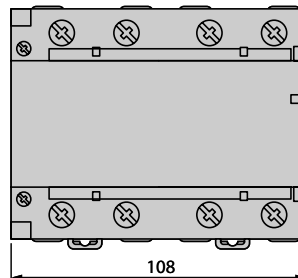

5

Dimensions

Auxiliary contacts

GAC 0511, 0531 and 0521

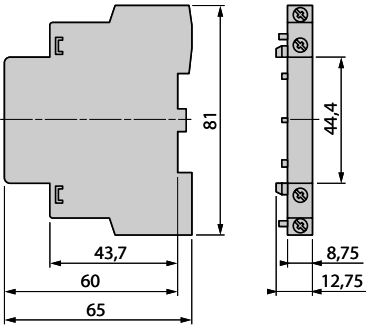

Coil suppression blocks

GAP 21, 22 and 23

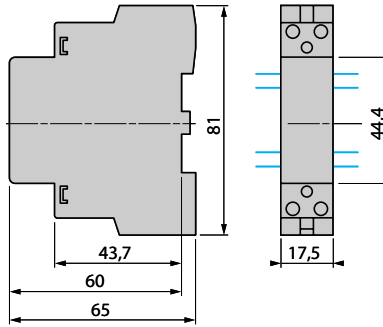

Clip-on ventilation 1/2 module

GAC 5

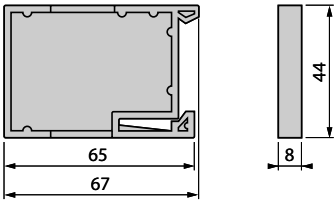

Cover plates

GA1 C6

GA1 C7

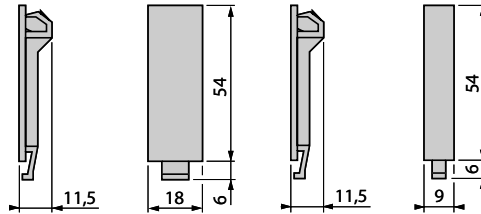

Schemes

Contactors

GC ●●10

GC ●●20

GC ●●30

GC ●●40

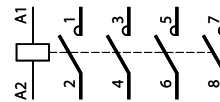
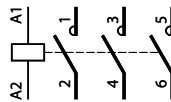
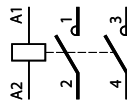
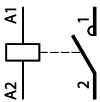

GC ●●11

GC ●●22

GC ●●02

GC ●●04

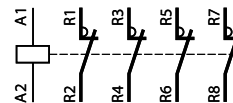
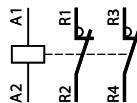
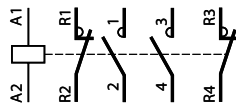
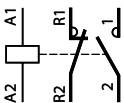

Auxiliary contacts

GAC 0521

GAC 0531

GAC 0511

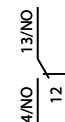
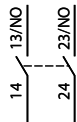
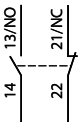

PF526294



GF 1611M7

Presentation

TeSys GF impulse relays are designed for use in modular enclosures. They feature:

■ Easy installation

- quick clip-on fixing and locking onto 35 mm omega rail,
- easy connection by means of ready-to-tighten captive, pozidrive screw terminals.

■ Compact size

Units have a common depth of 60 mm and width of 18 mm.

■ User safety

- live parts protected against direct finger contact,
- completely safe operation,
- state indication on front panel.

Standards

This range of modular impulse relays has been designed taking into account the requirements of international standard IEC 60669-2.

This standard is specific to "Impulse relays".

Conformity with this standard makes it possible to obtain the following quality labels without the need for additional tests: NF-USE, VDE, CEBEC, etc.

Functions

Modular impulse relays are designed for opening and closing of circuits which are remotely controlled by impulses. The position is mechanically maintained.

These impulse relays are used in lighting circuits when there are more than two switching points.

Power switching

TeSys GF impulse relays have multiple applications in industrial, agricultural and commercial premises, hospitals and the home, i.e. wherever switching of a specific lighting supply is required:

Lighting circuits						
Fluorescent lamps with starter						
Single fitting	Non corrected			With parallel correction		
Power in W	18	36	58	18	36	58
Number of lamps	70	35	21	50	25	16
Twin fitting	With series correction					
Power in W	2 x 18	2 x 36	2 x 58			
Number of lamps	56	28	17			
Incandescent lamps: filament lamps						
Power in W	40	60	75	100	200	
Number of lamps	40	25	20	16	8	
Incandescent lamps: halogen lamps						
Power in W	300	500	1000	1500		
Number of lamps	5	3	1	1		
Incandescent lamps: very low voltage halogen lamps						
Power in W	20	50	75	100		
Number of lamps	70	28	19	4		
Low pressure sodium vapour lamps						
	Non corrected					
Power in W	55	90	135	180		
Number of lamps	24	15	10	7		
High pressure sodium vapour lamps						
	Non corrected					
Power in W	250	400	1000			
Number of lamps	5	3	1			
Heating circuits						
Single-phase 230 V, 2-pole						
Power in kW	3.6					

Environment			
Rated insulation voltage (Ui)	Conforming to IEC 60947-1-5	V	400
	Conforming to VDE 0110	V	400
Rated impulse withstand voltage (Uimp)		kV	4 in enclosure
Conforming to standards			IEC 60669-1 and 60669-2, NF C 61-112
Product certifications			NF-USE, CEBC, ASE, KEMA, N, S, D, FI, VDE
Degree of protection	Conforming to VDE 0106		Protection against direct finger contact IP 20 open, IP 40 in enclosure
Protective treatment	Standard version		"TC"
Ambient air temperature around the device	Storage	°C	- 40...+ 80
	Operation	°C	- 20...+ 50
Maximum operating altitude	Without derating	m	2000
Operating positions	Without derating		± 90° in relation to normal vertical mounting plane
Shock resistance 1/2 sine wave = 10 ms	Impulse relay open		Please consult your Regional Sales Office
	Impulse relay closed		Please consult your Regional Sales Office
Vibration resistance 5...300 Hz	Impulse relay open		4 gn
	Impulse relay closed		4 gn

Pole characteristics					
Number of poles			1 or 2		
Rated operational current (Ie) (Ue ≤ 250 V)	In AC-7a (heating)	A	16		
Rated operational voltage		V	250		
Conventional thermal current (Ith)	θ ≤ 50 °C	A	16		
Permissible short time rating no current flowing for preceding 15 minutes with θ ≤ 40 °C	For 1 s	A	320		
	For 10 s	A	96		
	For 30 s	A	48		
Short-circuit protection by fuse or circuit-breaker	gl fuse	A	16		
	Circuit-breaker I ² t (at 3 kA rms prospective)	A ² s	5000		
Average impedance per pole	At Ith and 50 Hz	mΩ	4		
Power dissipated per pole		W	1		
Maximum cabling c.s.a.	Flexible cable without cable end	1 conductor	mm ²	Min.	Max.
		2 conductors	mm ²	0.5	6
	Flexible cable with cable end	1 conductor	mm ²	0.5	6
		2 conductors	mm ²	0.5	4
	Solid cable without cable end	1 conductor	mm ²	0.5	6
		2 conductors	mm ²	0.5	4
Tightening torque	Power circuit connections	N.m	0.8		

Control circuit characteristics			
Rated control circuit voltage (Uc)		V	12...240 V, for other voltages, please consult your Regional Sales Office
Control voltage limits ($\theta < 50\text{ }^{\circ}\text{C}$)	Operating threshold, dual frequency 50/60 Hz	V	0.85...1.1 Uc
Average consumption at 20 °C and at Uc	Inrush at 50 Hz	VA	19
Operating time	Closing "C"	ms	70
	Opening "O"	ms	70
Minimum impulse time		ms	70
Mechanical durability			10 ⁶ operating cycles
Electrical durability		AC-21	200 000 operating cycles
		AC-22	100 000 operating cycles
Maximum operating rate	Operating cycles per hour		900
Maximum cabling c.s.a.	Flexible cable without cable end	1 or 2 conductors	mm² 2.5
	Flexible cable with cable end	1 conductor	mm² 2.5
		2 conductors	mm² 1.5
	Solid cable without cable end	1 or 2 conductors	mm² 1.5
Tightening torque		N.m	0.8

PF326294



GF 1611M7

TeSys GF impulse relays							
Maximum current rating category AC-1	Composition		Coil voltages		Sold in lots of	Unit reference	Weight
			~ 50/60 Hz	---			
A			V	V			kg
16	1	-	12	6	12	GF 1610J7	0.110
			24	12	12	GF 1610B7	0.110
			48	24	12	GF 1610E7	0.110
			110	48	12	GF 1610F7	0.110
			220	-	12	GF 1610M7	0.110
			230/240	110	12	GF 1610U7	0.110
	2	-	12	6	12	GF 1620J7	0.110
			24	12	12	GF 1620B7	0.110
			48	24	12	GF 1620E7	0.110
			110	48	12	GF 1620F7	0.110
			220	-	12	GF 1620M7	0.110
			230/240	110	12	GF 1620U7	0.110
	1	1	12	6	12	GF 1611J7	0.110
			24	12	12	GF 1611B7	0.110
			48	24	12	GF 1611E7	0.110
			110	48	12	GF 1611F7	0.110
			220	-	12	GF 1611M7	0.110
			230/240	110	12	GF 1611U7	0.110

Dimensions

GF 1610, GF 1611, GF 1620

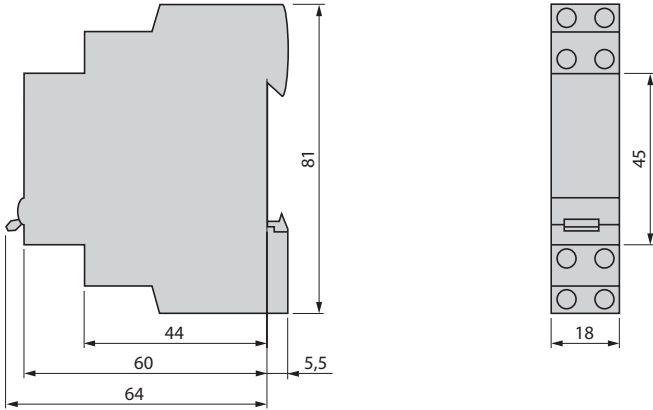

Schemes

GF 1610

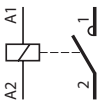

GF 1611

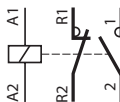

GF 1620

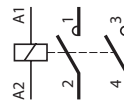

528295



GY 25

Presentation

TeSys GY “dual tariff” contactors are designed for use in modular panels and enclosures.

These contactors feature:

- Easy installation
 - quick clip-on fixing and locking onto 35 mm omega rail,
 - easy connection by means of ready-to-tighten captive, pozidrive screw terminals.

- **Compact size**

All units have a common depth of 60 mm and width in modules of 17.5 mm (width of one module: 17.5 mm).

- **User safety**

- use of materials conforming to strictest fire safety standards,
- live parts protected against direct finger contact,
- completely safe operation,
- state indication on front panel.

“Dual tariff” contactors are designed for use with Electricity Supply Authority dual tariffs.

They have a 4-position selector switch on the front panel:

“Stop” (O) For switching off the load, e.g. for prolonged periods of absence.

**“Off peak”
Automatic start (A)** The contactor switches automatically during “off peak” hours as set by the Supply Authority remote control and thus supplies the load, (washing machine, dishwasher, convector heater, water heater) during this period, at an economy rate to the user.

**“Peak time”
Manual start (I)** In this position, the contactor supplies the load to cater for additional requirements for hot water, heating, etc., but at the standard rate. The contactor returns automatically to the “off-peak” position at the start of the “off-peak” period.

**“Peak time”
Manual override
with lock** Facility for setting the contactor to continuous manual operation, ignoring the automation system and the Supply Authority control; setting and locking is achieved by means of a tool, with manual return to the “AUTO” position.

Standards

This range of modular contactors has been designed taking into account the requirements of international standard IEC 61095.

This standard is specific to “Electromagnetic contactors for domestic and similar use”.

It has very strict requirements, meeting the expectations of users, with regard to the safety of equipment and persons in “premises and areas accessible to the public”. Conformity with this standard makes it possible to obtain the following quality labels without the need for additional tests: NF-USE, VDE, CEBEC, etc.

Applications

“Dual tariff” modular contactors are designed for switching all single-phase, 3-phase or 4-phase loads up to 63 A.

Power switching

TeSys GY contactors have multiple applications in industrial, agricultural and commercial premises, hospitals and the home, i.e. wherever switching of a specific supply is required:

- lighting,
- heating, ventilation,
- motorised shutters or gates.

Setting-up precautions

The contactor controls must be bounce free. If not, connect a coil suppression block **1** (GAP 21, 22 or 23) across the coil terminals ≤ 250 V.

When several contactors which operate at the same time are mounted side by side, a GAC 5 ventilation 1/2 module **2** must be fitted every 2 contactors.

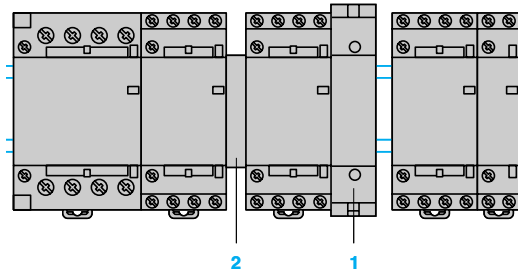

It is advisable to mount electronic units at the bottom of the modular panel and to separate them from electromechanical units by a space equal to one module **3** or by 2 ventilation 1/2 modules GAC 5

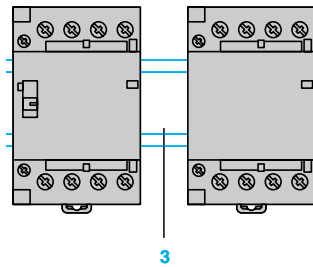

Derating of contactors mounted in a modular enclosure if the temperature within the enclosure is > 40 °C

Contactor rating	40 °C	50 °C	60 °C (1)
16 A	16 A	14 A	13 A
25 A	25 A	22 A	20 A
40 A	40 A	36 A	32 A
63 A	63 A	57 A	50 A

(1) Ventilation 1/2 module must be fitted

Environment					
Type		GY 16	GY 25	GY 40	GY 63
Rated insulation voltage (Ui)	Conforming to IEC 61095	V	500		
	Conforming to VDE 0110	V	500		
Rated impulse withstand voltage (Uimp)		kV	4 in enclosure		
Conforming to standards			IEC 61095, VDE 0637-3 and IEC 60947-5 for auxiliary contacts		
Product certifications			NF-USE, VDE, CEBC, ÖVE		
Degree of protection	Conforming to VDE 0106		Protection against direct finger contact IP 20 open, IP 40 in enclosure		
Protective treatment	Standard version		“TC”		
Ambient air temperature around the device	Storage	°C	- 40...+ 70		
	Operation	°C	- 5...+ 50 (0.85...1.1 Uc)		
Maximum operating altitude	Without derating	m	3000		
Operating positions	Without derating		± 30° in relation to normal vertical mounting plane		
Shock resistance 1/2 sine wave = 11 ms	Contacteur open		10 gn		
	Contacteur closed		15 gn		
Vibration resistance 5...300 Hz	Contacteur open		2 gn		
	Contacteur closed		3 gn		
Flame resistance			Conforming to IEC 61095		

Pole characteristics							
Number of poles			2, 3 or 4				
Rated operational current (Ie) (Ue ≤ 440 V)	In AC-7a (heating)	A	16	25	40	63	
	In AC-7b (motor control)	A	5	8.5	15	25	
Rated operational voltage (Ue)	Up to	V	250 - 2-pole contactors, 415 - 3 and 4-pole contactors				
Frequency limits	Of the operating current	Hz	400				
Conventional thermal current (Ith)	θ ≤ 50 °C	A	16	25	40	63	
Rated breaking and making capacity	Conforming to IEC 61095 (AC-7b) I rms 400 V 3-phase	A	40	68	120	200	
Short time rating with no current flow for the previous 15 minutes with θ ≤ 40 °C	For 10 s	A	128	200	320	504	
	For 30 s	A	40	62	100	157	
Short-circuit protection by fuse or circuit breaker U ≤ 440 V							
	gl fuse	A	16	25	40	63	
	Circuit breaker I²t (at 3 kA rms prospective)	230V	A²s	5000	10 000	16 000	18 000
		400V	A²s	9000	14 000	17 500	20 000
Average impedance per pole	At Ith and 50 Hz	mΩ	2.5	2.5	2	2	
Power dissipated per pole	For the above operational currents	W	0.65	1.6	3.2	8	
Maximum cabling c.s.a.							
Flexible cable without cable end	1 conductor	mm²	6	6	25	25	
	2 conductors	mm²	4	4	16	16	
Flexible cable with cable end	1 conductor	mm²	6	6	16	16	
	2 conductors	mm²	1.5	1.5	4	4	
Solid cable without cable end	1 conductor	mm²	6	6	25	25	
	2 conductors	mm²	4	4	6	6	
Tightening torque	Power circuit connections	N.m	0.8	0.8	3.5	3.5	

Control circuit characteristics					
Type			GY 16, GY 25 single or 2-pole	GY 16, GY 25 3 or 4-pole GY 40, GY 63 2-pole	GY 40, GY 63 3 or 4-pole
Rated control circuit voltage (Uc)	50 or 60 Hz	V	12...240 V, for other voltages, please consult your Regional Sales Office		
Control voltage limits ($\theta \leq 50\text{ }^{\circ}\text{C}$)	50 Hz coils		0.85...1.1 Uc		
	Operational		0.85...1.1 Uc		
	Drop-out		0.2...0.75 Uc		
Average consumption at 20 °C and at Uc ~ 50 Hz	Inrush	VA	15	34	53
	Sealed	VA	3.8	4.6	6.5
Heat dissipation	50/60 Hz	W	1.3	1.6	2.1
Operating time	Closing “C”	ms	10 ... 30		
	Opening “O”	ms	10 ... 25		
Mechanical durability	In operating cycles		10 ⁶		
Maximum operating rate at ambient temperature $\leq 50\text{ }^{\circ}\text{C}$	In operating cycles per hour		300		
Maximum cabling c.s.a.	Flexible cable without cable end	1 or 2 conductors	mm ²	2.5	
	Flexible cable with cable end	1 conductor	mm ²	2.5	
		2 conductors	mm ²	1.5	
	Solid cable without cable end	1 or 2 conductors	mm ²	1.5	
Tightening torque		N.m	0.8		
Instantaneous auxiliary contact characteristics					
Rated operational voltage (Ue)	Up to	V	250		
Rated insulation voltage (Ui)	Conforming to IEC 60947-5	V	500		
	Conforming to VDE 0110	V	500		
Conventional thermal current (Ith)	For ambient $\theta \leq 50\text{ }^{\circ}\text{C}$	A	5		
Mechanical durability	In operating cycles		10 ⁶		
Maximum cabling c.s.a.	Flexible or solid conductor	mm ²	2.5		
Tightening torque		N.m	0.8		

TeSys modular equipment

TeSys GY “dual tariff” contactors

526295



GY 2520M5

526296



GY 6340M5

TeSys GY “dual tariff” contactors						
Maximum current rating category AC-7a	No. of poles		Number of 17.5 mm modules	Sold in lots of	Basic reference, to be completed by adding the voltage code (1)	Weight
	d	b				
A						kg
16	2	–	1	12	GY 1620●●	0.110
	4	–	2	6	GY 1640●●	0.230
	1	1	1	12	GY 1611●●	0.110
25	2	–	1	12	GY 2520●●	0.110
	3	–	2	6	GY 2530●●	0.230
	4	–	2	6	GY 2540●●	0.230
	1	1	1	12	GY 2511●●	0.110
40	2	–	2	6	GY 4020●●	0.230
	3	–	3	4	GY 4030●●	0.350
	4	–	3	4	GY 4040●●	0.390
63	2	–	2	6	GY 6320●●	0.340
	3	–	3	4	GY 6330●●	0.390
	4	–	3	4	GY 6340●●	0.390

(1) Standard control circuit voltages (for other voltages, please consult your Regional Sales Office):

Volts	12	24	48	110	220/240
50 Hz	J5	B5	E5	F5	M5
60 Hz	J6	B6	E6	F6	M6



GAP 23

Instantaneous auxiliary contact blocks						
Number of contacts	Number of poles			Reference	Weight	kg
2	1	1	-	GAC 0521	0.016	
	-	2	-	GAC 0531	0.016	
	-	-	1	GAC 0511	0.016	

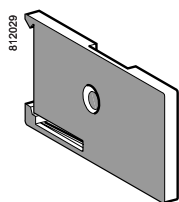

GAC 5



GA1 C7

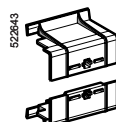

GW 254

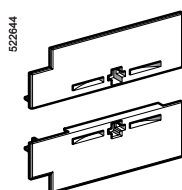

GW 63

Accessories						
Description	For use on contactor	Number of modules	Operational voltage in V	Sold in lots of	Unit reference	Weight kg
Coil suppression blocks comprising 2 RC circuits	-	1	12...48	1	GAP 21	0.090
	-	1	110...240	1	GAP 23	0.090
Ventilation 1/2 module clips onto rail	-	1/2	-	10	GAC 5	0.015
Cover plates	-	1/2	-	10	GA1 C7	0.001
	-	1	-	10	GA1 C6	0.001
Set of sealable terminal covers (10 top parts + 10 bottom parts)	16 or 25 A	2	-	1	GW 254	0.040
	3 or 4 contacts					
	40 or 63 A	2	-	1	GW 632	0.040
	2 contacts					
	40 or 63 A	3	-	1	GW 634	0.050
	3 or 4 contacts					

“Dual tariff” contactors

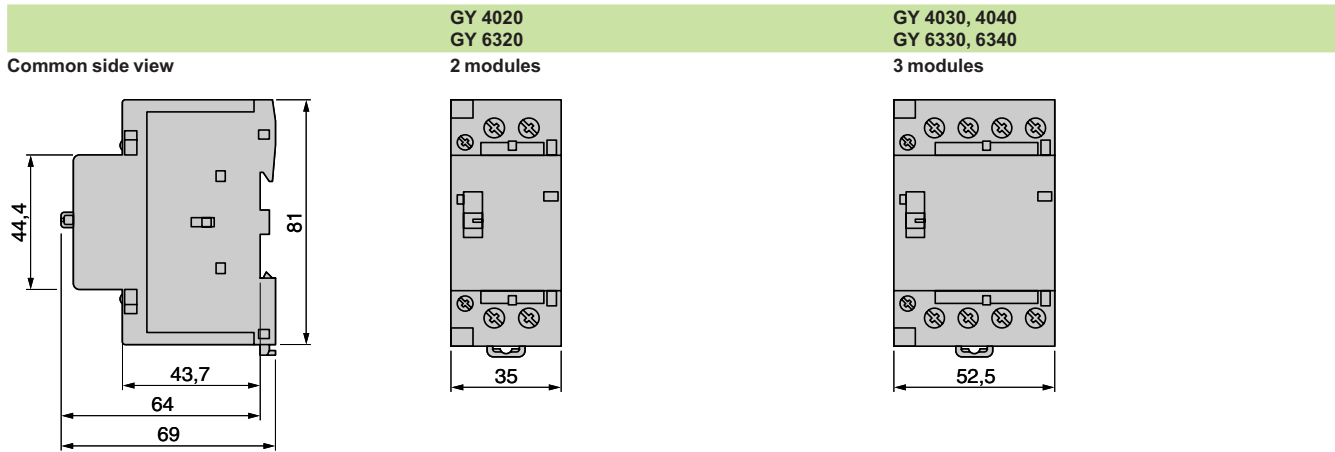
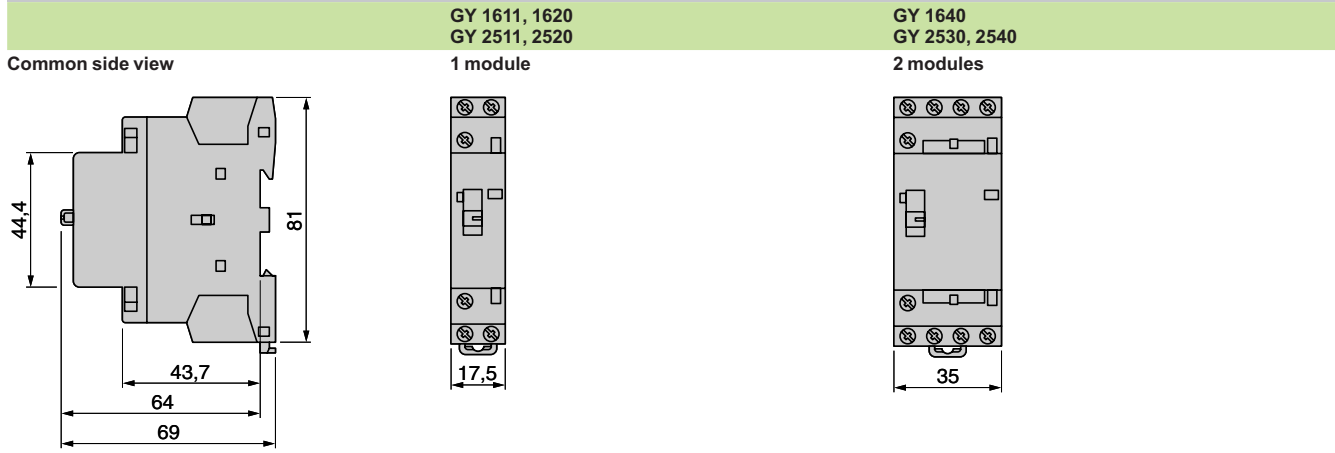

5

Dimensions

Auxiliary contacts

GAC 0511, 0531 and 0521

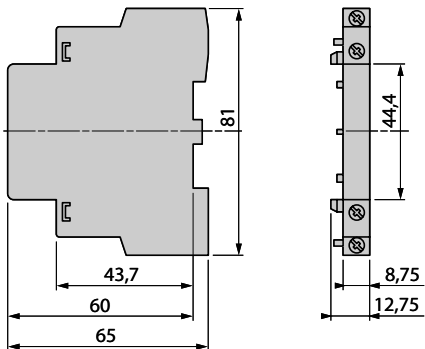

Coil suppression block

GAP 21, 22 and 23

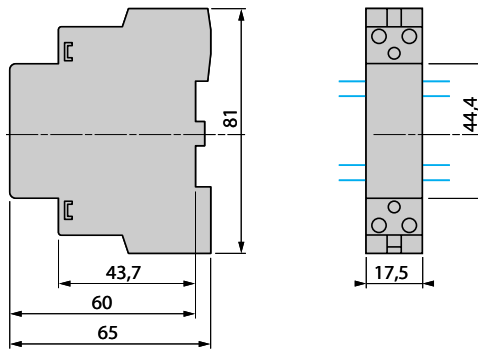

Clip-on ventilation 1/2 module

GAC 5

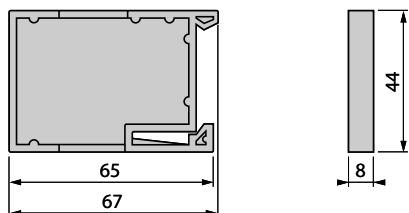

Cover plates

GA1 C6

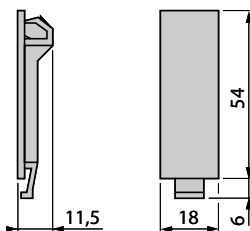

GA1 C7

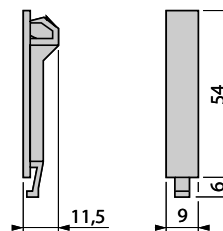

Schemes

Contactors

GY ●●20

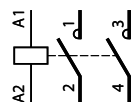

GY ●●30

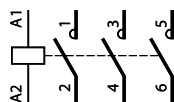

GY ●●40

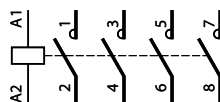

GY ●●11

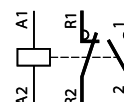

Auxiliary contacts

GAC 0521

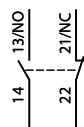

GAC 0531

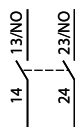

GAC 0511

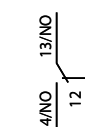

X-ON Electronics

Largest Supplier of Electrical and Electronic Components

Click to view similar products for [Contactors - Electromechanical category](#):

Click to view products by [Schneider manufacturer](#):

Other Similar products are found below :

[6-1618400-7](#) [686-117111](#) [686-120111](#) [686-924](#) [686-948](#) [70-901](#) [70-914](#) [MB-3D-6](#) [MC-22A/4-AC120V](#) [8-1616943-9](#) [8-1672124-5](#)
[A40-30-10-84](#) [120-905](#) [A701U](#) [120-904](#) [1393132-9](#) [154-905](#) [154-912](#) [154-913](#) [154-915](#) [154-902](#) [154-910](#) [AVR743D](#) [B6-40-00-84](#) [B7-40-00-84](#) [1616017-5](#) [1616021-1](#) [MVDILM](#) [HP-11D-24](#) [P25-E5019-1](#) [P30C47A12D1-120](#) [P40C47A12D1-120](#) [P40P47D13P1-24-01](#) [CA7-12-10-240](#) [CA7-72-00-24Z](#) [90-162](#) [9-1393132-2](#) [2NC4F0222](#) [A275KXXV2-120VAC](#) [ACC338UMM20](#) [AF80-30-11-13](#) [SZ-B1](#) [CGC-9A-120](#) [3GC2H0M22](#) [3NC0T0A22](#) [3NC1Q0A22](#) [3NC2H0A22](#) [3NC2T0122/SE](#) [3TF3400-0BB4](#) [MC-12B-DC24V](#)