







Contactors – TeSys F, V, FG, CR1F		
Type of product	Range	Pages
Contactors for AC-3 applications TeSys F	From 115 to 1000 A	 B9/2
Contactors for AC-1 applications TeSys F	From 200 to 2600 A	 B9/3
Vacuum contactors– 1500 V TeSys V	From 160 to 610 A - AC-3 From 160 to 630 A - AC-1	 B9/4
Shockproof contactors TeSys FG	From 150 to 630 A - AC-3	 B9/6
Magnetic latching contactors TeSys CR1F	From 150 to 630 A - AC-3	 B9/7
Reversing pre-assembled contactors for AC-3 applications TeSys F	From 115 to 265 A - AC-3	 B9/8
Changeover pre-assembled contactor pairs for AC-1 applications TeSys F	From 200 to 350 A - AC-1	 B9/9
Auxiliary contact blocks Accessories – spare parts - delayed opening devices TeSys F		B9/10
Coils TeSys F		B9/17
Accessories, coils for shockproof and magnetic latching contactors TeSys FG, TeSys CR1F		B9/27
Accessories for reversing and changeover contactor assemblies TeSys LA9F		B9/36

# TeSys contactors

TeSys F contactors for motor control in utilisation category AC-3 (115 to 1000 A)

Control circuit: a.c. or d.c. supply



LC1 F225



LC1 F630

3-pole contactors										Weight
Standard power ratings of 3-phase motors 50-60 Hz in category AC-3							Rated operational current in AC-3	Basic reference, to be completed by adding the voltage code <sup>(2)</sup>	Screw fixing, cabling <sup>(1)</sup>	
220 V	380 V	415 V	440 V	500 V	660 V	1000 V	440 V up to			
kW	kW	kW	kW	kW	kW	kW	A			
30	55	59	59	75	80	–	115	LC1F115●●		3.430
40	75	80	80	90	100	–	150	LC1F150●●		3.430
55	90	100	100	110	110	–	185	LC1F185●●		4.650
63	110	110	110	129	129	–	225	LC1F225●●		4.750
75	132	140	140	160	160	–	265	LC1F265●●		7.440
100	160	180	200	200	220	160	330	LC1F330●●		8.600
110	200	220	250	257	280	185	400	LC1F400●●		9.100
147	250	280	295	355	335	–	500	LC1F500●●		11.350
200	335	375	400	400	450	450	630	LC1F630●●		18.600
220	400	425	425	450	475	450	780	LC1F780●●		39.500
250	450	450	450	450	475	450	800	LC1F800●●		18.750
315	560	630	670	–	–	–	1000	LC1F1000●●		31.000

Note: auxiliary contact blocks, modules and accessories: see pages B9/10 to B9/27.

(1) Power terminals can be protected against direct finger contact by the addition of shrouds, to be ordered separately, except on contactors LC1 F780 (see page B9/14).

(2) Standard control circuit voltages (for other voltages, please consult your Regional Sales Office).

Volts ~	24	48	110	115	120	208	220	230	240	380	400	415	440
<b>LC1 F115...F225</b>													
40...400 Hz (coil LX9)	–	E7	F7	FE7	G7	L7	M7	P7	U7	Q7	V7	N7	R7
<b>LC1 F265...F330</b>													
40...400 Hz (coil LX1)	B7	E7	F7	FE7	G7	L7	M7	P7	U7	Q7	V7	N7	R7
<b>LC1 F400...F630, F1250</b>													
40...400 Hz (coil LX1)	–	E7	F7	FE7	G7 <sup>(3)</sup>	L7	M7	P7	U7	Q7	V7	N7	R7
<b>LC1 F780</b>													
40...400 Hz (coil LX1)	–	–	F7	FE7	F7	L7	M7	P7	U7	Q7	V7	N7	R7
<b>LC1 F800</b>													
40...400 Hz (coil LX4) <sup>(4)</sup>	–	–	FW	FW	FW	–	MW	MW	MW	QW	QW	QW	–
<b>LC1 F1000, F1400, F1700, F2100, F2600</b>													
40...400 Hz (coil LX1F)	–	–	F7	–	G7	–	M7	P7	U7	Q7	V7	N7	R7
<b>Volts ---</b>	<b>24</b>	<b>48</b>	<b>110</b>	<b>125</b>	<b>220</b>	<b>230</b>	<b>250</b>	<b>400</b>	<b>440</b>				
<b>LC1 F115...F330</b>													
(coil LX4 F)	BD	ED	FD	GD	MD	MD	UD	–	RD				
<b>LC1 F400...F630, F1250</b>													
(coil LX4 F)	–	ED	FD	GD	MD	–	UD	–	RD				
<b>LC1 F780, LC1 F1000, F1400, F1700, F2100, F2600</b>													
(coil LX4 F)	–	–	FD	GD	MD	–	UD	–	RD				
<b>LC1 F800</b>													
(coil LX4 F)	–	–	FW	FW	MW	MW	–	QW	–				

(3) F7 for LC1F630.

(4) Coil LX4 F8●● + rectifier DR5TE●●.

Click [HERE](#) for access to online contactor selector

# TeSys contactors

TeSys F contactors for motor control in utilisation category AC-1 (200 to 2600 A)

Control circuit: a.c. or d.c. supply



LC1 F1854



LC1 F4004



LC1 F6304



LC1 F1700



LC1 F2100



LC1 F2600

2, 3 or 4-pole contactors			
Maximum current in AC-1 ( $\theta \leq 40^\circ\text{C}$ )	Number of poles 	Basic reference, to be completed by adding the voltage code <sup>(2)</sup> Screw fixing, cabling <sup>(1)</sup>	Weight
A			kg
200	3	LC1F115●●	3.430
	4	LC1F1154●●	3.830
250	3	LC1F150●●	3.430
	4	LC1F1504●●	3.830
275	3	LC1F185●●	4.650
	4	LC1F1854●●	5.450
315	3	LC1F225●●	4.750
	4	LC1F2254●●	5.550
350	3	LC1F265●●	7.440
	4	LC1F2654●●	8.540
400	3	LC1F330●●	8.600
	4	LC1F3304●●	9.500
500	2	LC1F4002●●	8.000
	3	LC1F400●●	9.100
	4	LC1F4004●●	10.200
700	2	LC1F5002●●	9.750
	3	LC1F500●●	11.350
	4	LC1F5004●●	12.950
1000	2	LC1F6302●●	15.500
	3	LC1F630●●	18.600
	4	LC1F6304●●	21.500
1200	3	LC1SF1200KUE	13.400
1260	3	LC1F1250●●	19.000
1400	3	LC1F1400●●	29.000
1600	3	LC1F780●●	39.500
	4	LC1F7804●●	48.000
1700	3	LC1F1700●●	30.000
2100 <sup>(3)</sup>	3	LC1F2100●●	31.000
2600 <sup>(4)</sup>	3	LC1F2600●●	36.000

Note: auxiliary contact blocks, modules and accessories: see pages B9/10 to B9/27.

(1) Power terminals can be protected against direct finger contact by the addition of shrouds, to be ordered separately (except LC1 F780, LC1 F1250, LC1 F1400, LC1 F1700 and LC1 F2100), see page "TeSys contactors", page B9/14.

(2) Standard control circuit voltages, see previous page.

(3) With set of right-angled connectors LA9 F2100 (see page B9/13).

(4) With set of right-angled connectors LA9 F2600 (see page B9/13).

 Click [HERE](#) for access to online contactor selector

## TeSys contactors

TeSys V 3-pole vacuum contactors and reversing contactors AC-3 (160 to 610 A)  
Power and control circuits a.c. supply

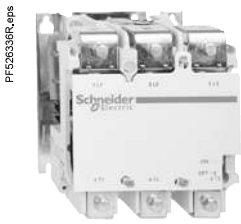

LC1 V320

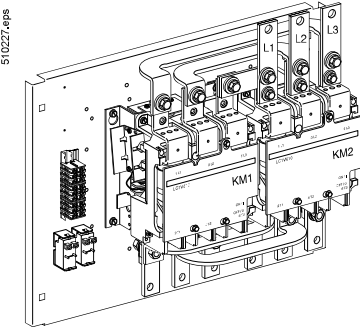

LC2 V610

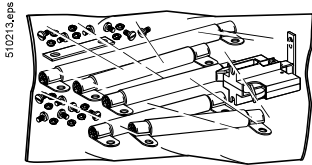

LA9 V974

Vacuum contactors											
Standard power ratings 50/60 Hz in category AC-3					Rated operational current le		Instan- taneous auxiliary contacts		Control circuit voltage (50/60 Hz)	Basic reference <sup>(1)</sup>	Weight
kW	kW	kW	kW	kW	A	A					kg
45	75	110	150	200	160	160	2	1	(1)	LC1V160●●	3.800
90	160	220	280	400	320	320	1	1	(1)	LC1V320●●	10.500
160	300	400	560	800	610	630	1	1	(1)	LC1V610●●	13.000

### Reversing vacuum contactors

The reversing contactor range comprises :

- for 160 A rating, a kit with set of power connections allowing assembly of the starter
- for 320 and 610 A ratings, a complete starter, ready for use.

Standard power ratings 50/60 Hz in category AC-3					Rated operational current le		Instan- taneous auxiliary contacts		Control circuit voltage (50/60 Hz)	Basic reference <sup>(1)</sup>	Weight
kW	kW	kW	kW	kW	A	A					kg
45	75	110	150	200	160	160	2	1	—	LA9V974 <sup>(2)</sup>	1.200
90	160	220	280	400	320	320	1	1	110-120 V	LC2V320FE7	30
									220-240 V	LC2V320P7	30
									380-415 V	LC2V320V7	30
160	300	400	560	800	610	630	1	1	110-120 V	LC2V610FE7	36
									220-240 V	LC2V610P7	36

(1) Basic reference; add code indicating control circuit voltage.

Standard control circuit voltages:

Volts 50/60 Hz	110...120	220...240	380...415	440...480	550...600
Item	FE7	P7	V7	R7	X7

(2) Kit containing a mechanical interlock, a set of power connections and a fixing plate.  
To build a complete reversing contactor, order contactors LC1 V160●● separately.

## TeSys contactors

TeSys V 3-pole vacuum contactors and reversing contactors AC-3 (160 to 610 A)  
Power and control circuits a.c. supply

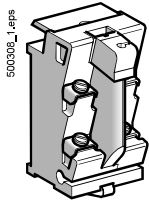

LA1 VN11

Instantaneous auxiliary contact blocks <sup>(1)</sup>			
Number of contacts	Maximum number of blocks per contactor	Auxiliary contacts	Reference
2	4		LA1VN11
			LA1VN02
			LA1VN20
			LA1VN11X (2)

50/60 Hz coils		
Rated voltage	Voltage code	Reference
V		
For contactors LC1 V160		
110...120	FE7	LX1V160FE7
220...240	P7	LX1V160P7
380...415	V7	LX1V160V7
440...480	R7	LX1V160R7
550...600	X7	LX1V160X7
For contactors LC1 V320		
110...120	FE7	LX1V320FE7
220...240	P7	LX1V320P7
380...415	V7	LX1V320V7
440...480	R7	LX1V320R7
550...600	X7	LX1V320X7
For contactors LC1 V610		
110...120	FE7	LX1V610FE7
220...240	P7	LX1V610P7
380...415	V7	LX1V610V7
440...480	R7	LX1V610R7
550...600	X7	LX1V610X7

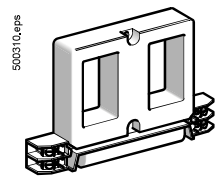

LX1 V320●●

(1) LC1 V160: auxiliary contact blocks mounted at the top of the contactor, with no change to the overall dimensions.

LC1 V320 or LC1 V610: 2 auxiliary contact blocks mounted on the RH and LH side of the contactor, with no change to the overall dimensions.

(2) For LC1 V160: 1 N/C contact for the coil + 1 N/O contact.

# TeSys contactors

## TeSys FG 3-pole shockproof contactors

For motor and distribution circuits control AC-3 (150 to 630 A)

Control circuit: a.c. supply



LC1 FG150



LC1 FG185



LC1 FG265

### 3-pole shockproof contactors

Standard power ratings of 3-phase motors 50-60 Hz in category AC-3							Rated operational current in cat. AC-3, 440 V/AC-1 up to	Anchor (1)  DCN ref.	Basic reference, to be completed by adding the voltage code (3)		Weight
220 V 230 V	380 V 400 V	415 V	440 V	500 V	660 V 690 V	1000 V			CR	LC1FG	
kW	kW	kW	kW	kW	kW	kW	A			kg	
40	75	80	80	90	100	65	150/250	CR182	LC1FG150●●	3.430	
55	90	100	100	110	110	100	185/275	CR242	LC1FG185●●	4.650	
75	132	140	140	160	160	147	265/350	CR302	LC1FG265●●	7.440	
110	200	220	250	257	280	185	400/500	CR432	LC1FG400●●	9.100	
147	250	280	295	355	335	335	500/700	CR582	LC1FG500●●	11.350	
200	335	375	400	400	450	450	630/1000	CR852	LC1FG630●●	18.600	

Note: these contactors have instantaneous auxiliary contact blocks with 2 N/O contacts, 1 N/C contact and one coil maintaining contact.

- (1) Devices approved by the DCN (French naval shipyard department) and authorised for on-board use.
- (2) Power terminals can, if required, be protected against direct finger contact by the addition of shrouds, to be ordered separately. See page B9/14.
- (3) Standard control circuit voltages (for other voltages, please consult your Regional Sales Office):

Volt ~		Anchor (1)											
		48	110	115	120	208	220	230	240	380	400	415	440
LC1 FG 150...FG185	40...400 Hz (coil LX9)	E7	F7	F7	-	L7	M7	P7	U7	Q7	V7	N7	R7
LC1 FG265	40...400 Hz (coil LX1)	E7	F7	F7	G7	L7	M7	P7	U7	Q7	V7	N7	R7
LC1 FG400...FG500	40...400 Hz (coil LX1)	-	F7	F7	G7	L7	M7	P7	U7	Q7	V7	N7	R7
LC1 FG630	40...400 Hz (coil LX1)	-	F7	F7	F7	L7	M7	P7	U7	Q7	V7	N7	R7

Note: auxiliary contact blocks, accessories and spare coils, see pages B9/27 to B9/29.

## References - TeSys CR1F

### TeSys contactors

TeSys F magnetic latching contactors AC-3 (150 to 630 A)

Control circuit: a.c. or d.c. supply



CR1 F1854



CR1 F500

Maximum thermal current in category AC-1 40 °C	Rated operational current in category AC-3 (440 V max)	Number of poles	Instantaneous auxiliary contacts		Basic reference, to be completed by adding the voltage code <sup>(1)</sup>	Weight
A	A					kg
250	150	3	—	—	CR1F150●●	3.500
		4	—	—	CR1F1504●●	3.800
275	185	3	—	—	CR1F185●●	4.600
		4	—	—	CR1F1854●●	5.400
350	265	3	—	—	CR1F265●●	7.400
		4	—	—	CR1F2654●●	8.500
500	400	3	—	—	CR1F400●●	9.100
		4	—	—	CR1F4004●●	10.200
700	500	3	—	—	CR1F500●●	11.300
		4	—	—	CR1F5004●●	12.900
1000	630	3	—	—	CR1F630●●	18.600
		4	—	—	CR1F6304●●	21.500

**Note:** accessories, replacement parts and spare coils, see pages B9/33 to B9/35.

**(1)** Standard control circuit voltages: see page B9/34.

## TeSys contactors

TeSys F reversing contactors for motor control in utilisation category AC-3 (115 to 265 A), pre-assembled  
Control circuit: a.c. or d.c. supply



LC2F115

### 3-pole reversing contactors (horizontally mounted) <sup>(1)</sup>

#### Pre-wired power connections

Standard power ratings of 3-phase motors 50/60 Hz in category AC-3						Operational current in AC-3	Maximum operational voltage	Contactors supplied without coil <sup>(2)</sup> Complete reference Fixing, cabling <sup>(3)</sup>	Weight
220 V 380 V 660 V 230 V 400 V 415 V 440 V 500 V 690 V									
kW	kW	kW	kW	kW	kW	A	V		kg
30	55	59	59	75	80	115	690	LC2F115	7.560
40	75	80	80	90	100	150	690	LC2F150	7.560
55	90	100	100	110	110	185	690	LC2F185	10.100
63	110	110	110	129	129	225	690	LC2F225	14.200
75	132	140	140	160	160	265	690	LC2F265	16.480

#### Accessories (to be ordered separately)

Description	For reversing contactors	Quantity required	Reference
Power terminal protection shrouds	LC2 F115	2	LA9F701
	LC2 F150, F185	2	LA9F702
	LC2 F225, F265	2	LA9F703
Auxiliary contact blocks and add-on modules	–	–	See pages B9/10 to B9/14

<sup>(1)</sup> Fitted with a mechanical interlock without electrical interlocking. Order separately 2 auxiliary contact blocks **LADN•1** to obtain electrical interlocking between the 2 contactors, see page B9/11. For accessories, see pages B9/12 to B9/14.

<sup>(2)</sup> Coils to be ordered separately:

- a.c. supply, see pages B9/2, B9/17 and B9/18,
- d.c. supply, see pages B9/2 and B9/23.

<sup>(3)</sup> Screw fixing.

Power terminals can be protected against direct finger contact by the addition of shrouds, to be ordered separately, see above.



## References - TeSys F

### TeSys contactors

TeSys F changeover contactors for motor control in utilisation category AC-1 (200 to 350 A), pre-assembled  
Control circuit: a.c. or d.c. supply



LC2 F1854

#### 4-pole changeover contactor pairs (horizontally mounted) <sup>(1)</sup>

##### Pre-wired power connections

Utilisation category AC-1 Non inductive loads Maximum operational current $\theta < 40\text{ }^{\circ}\text{C}$	Maximum operational voltage	Contactors supplied without coil <sup>(2)</sup> Complete reference Fixing, cabling <sup>(3)</sup>	Weight
A	V		kg
200	690	LC2F1154	8.860
250	690	LC2F1504	8.860
275	690	LC2F1854	12.100
315	690	LC2F2254	15.200
350	1000	LC2F2654	19.480

##### Accessories (to be ordered separately)

Description	For changeover pairs	Quantity required	Reference
Power terminal protection shrouds	LC2 F1154	2	LA9F706
	LC2 F1504, F1854	2	LA9F707
	LC2 F2254, F2654	2	LA9F708
Auxiliary contact blocks and add-on modules	–	–	See pages B9/10 to B9/14

<sup>(1)</sup> Fitted with a mechanical interlock without electrical interlocking. Order separately 2 auxiliary contact blocks **LAD N•1** to obtain electrical interlocking between the 2 contactors, see page B9/11. For accessories, see pages B9/12 to B9/14.

<sup>(2)</sup> Coils to be ordered separately:  
- a.c. supply, B9/2, B9/17 and B9/18,  
- d.c. supply, see pages B9/2 and B9/23.



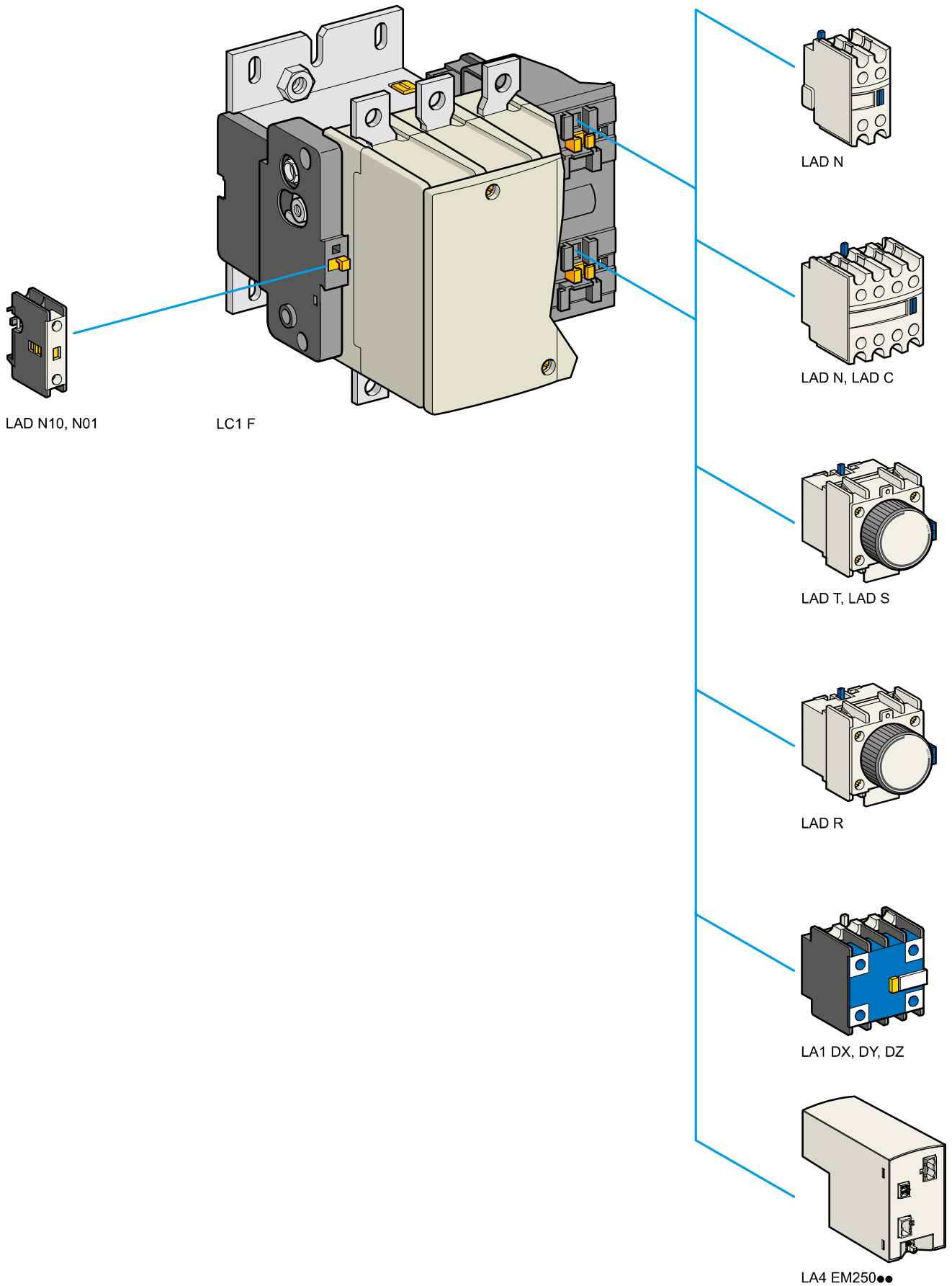

<sup>(3)</sup> Screw fixing.  
Power terminals can be protected against direct finger contact by the addition of shrouds, to be ordered separately, see above.





High power contactors

**Instantaneous auxiliary contact blocks****For use in normal operating environments**

Number of contacts	Maximum number of blocks per contactor Clip-on mounting	Composition				Reference
						
1	1	-	-	1	-	LADN10
		-	-	-	1	LADN01
2	2	-	-	1	1	LADN11
		-	-	2	-	LADN20
		-	-	-	2	LADN02
4	2	-	-	2	2	LADN22
		-	-	1	3	LADN13
		-	-	4	-	LADN40
		-	-	-	4	LADN04
		-	-	3	1	LADN31
		-	-	2	2 <sup>(1)</sup>	LADC22





**With terminal referencing conforming to EN 50012**

2	2	-	-	1	1	LADN11P
		-	-	1	1	LADN11G
4	2	-	-	2	2	LADN22P
		-	-	2	2	LADN22G

**Instantaneous auxiliary contact blocks for connection by lugs**

This type of connection is not possible for blocks with 1 contact or blocks with dust and damp protected contacts. For all other instantaneous auxiliary contact blocks, add the figure 6 to the end of the references selected above. Example: LAD N11 becomes LAD N116.

**Instantaneous auxiliary contact blocks with dust and damp protected contacts****Recommended for use in particularly harsh industrial environments**

Number of contacts	Maximum number of blocks per contactor Clip-on mounting	Composition				Reference
						
2	2	2	-	-	-	LA1DX20
		2	2 <sup>(2)</sup>	-	-	LA1DY20
4	2	2	-	2	-	LA1DZ40
		2	-	1	1	LA1DZ31

**Time delay auxiliary contact blocks**

Number of contacts	Maximum number of blocks per contactor Clip-on mounting	Time delay		Reference
		Type	Range s	
1 N/O +	2	On-delay	0.1...3 <sup>(3)</sup>	LADT0
			0.1...30	LADT2
		Off-delay	10...180	LADT4
			1...30 <sup>(4)</sup>	LADS2
1 N/C		Off-delay	0.1...3 <sup>(3)</sup>	LADR0
			0.1...30	LADR2
			10...180	LADR4

(1) Including 1 N/O + 1 N/C make before break.

(2) Device fitted with 4 earth screen continuity terminals.

(3) With extended scale from 0.1 to 0.6 s.

(4) With switching time of 40 ms ± 15 ms between opening of the N/C contact and closing of the N/O contact.

# TeSys contactors

## TeSys F contactors

### Suppressor blocks and connection accessories

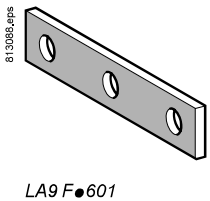
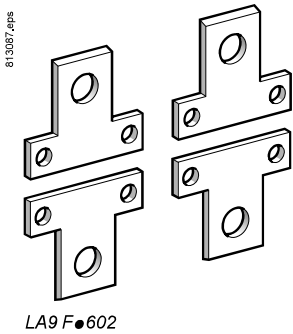
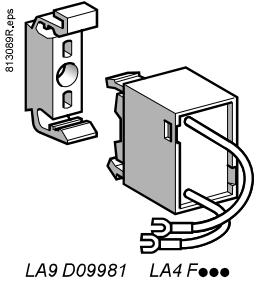

High power contactors



### Suppressor blocks <sup>(1)</sup>

#### RC circuits (resistor-capacitor)

- Effective protection for circuits highly sensitive to "high frequency" interference. For use only in cases where the voltage is virtually sinusoidal, i.e. less than 5 % total harmonic distortion.
- Voltage limited to 3 Uc max. and oscillating frequency limited to 400 Hz max.
- Slight increase in drop-out time (1.1 to 1.3 times the normal time).

Mounting	Uc		Reference
Clip-on mounting on all ratings and all a.c. coils.	~	24...48 V	LA4FRCE
		50...110 V	LA4FRCF
		127...240 V	LA4FRCP
		265...415 V	LA4FRCV
Suppressor block bracket			LA9D09981

#### Varistors (peak limiting)

- Protection provided by limiting the transient voltage to 2 Uc max.
- Maximum reduction of transient voltage peaks.

Mounting	Uc		Reference
Clip-on mounting on all ratings and all coils.	~ or ---	24...48 V	LA4FVE
		50...110 V	LA4FVF
		127...240 V	LA4FVP
		265...415 V	LA4FVV

#### Diodes

- No overvoltage or oscillating frequencies.
- Increase in drop-out time (3 to 4 times the normal time).
- Polarised component.

Mounting	Uc		Reference
Clip-on mounting on all ratings and all d.c. coils.	---	24...48 V	LA4FDE
		55...110 V	LA4FDF
		125...250 V	LA4FDP
		280...440 V	LA4FDV

#### Bidirectional peak limiting diodes (transil)

- Protection provided by limiting the transient voltage to between 2 and 2.5 times Uc max.
- Maximum reduction of transient voltage peaks.

Mounting	Uc		Reference
Clip-on mounting on all ratings and all coils.	~ or ---	24...48 V	LA4FTE
		50...110 V	LA4FTF
		127...240 V	LA4FTP
		265...415 V	LA4FTV

### Connection accessories

For use on 4-pole contactors	Set of 4 links	Weight kg
	Set reference	
<b>Links for parallel connection of poles (in pairs)</b>		
LC1 F1154	LA9FF602	0.200
LC1 F1504, F1854	LA9FG602	0.350
LC1 F2254, F2654, F3304, F4004	LA9FH602	1.000
LC1 F5004	LA9FK602	1.750
LC1 F6304	LA9FL602	3.000
<b>Links for "star" connection of 3 poles</b>		
LC1 F115	LA9FF601	0.035
LC1 F150, F185	LA9FG601	0.050
LC1 F225, F265, F330, F400	LA9FH601	0.120
LC1 F500	LA9FK601	0.180
LC1 F630, F800	LA9FL601	0.550

#### Control circuit voltage take-off from power terminals

For use with contactors	Mounted on bolt size	Sold in lots of	Unit reference
LC1 F115	M6	10	DZ3FA3
LC1 F150, F185	M8	10	DZ3GA3
LC1 F225...F500	M10	10	DZ3HA3
LC1 F630, F800	M12	10	DZ3JA3

<sup>(1)</sup> Order 2 x LA4F●●● for F780, F1000, F1400, F1700, F2100 & F2600 contactors and connect one suppressor block across each coil.  
For example, for a LC1F1400M7 (220 V coil) contactor, use 2 x LA4FRCF (110 V) as RC type surge suppressors.

# TeSys contactors

## TeSys F contactors

### Connection accessories

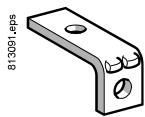

LA9 F981

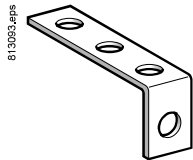

LA9 F979

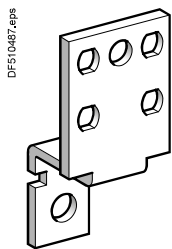

LA9 FL980

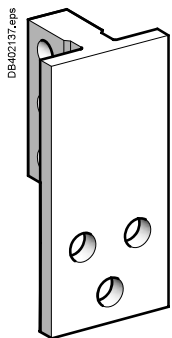

LA9 F1250

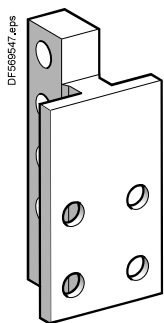

LA9 F2100

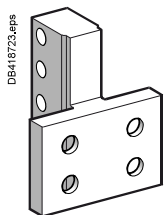

LA9 F2600

### Right-angled connectors

#### For contactors or thermal overload relays

For use with Contactors	Thermal overload relays <sup>(1)</sup>	With connector plates		Set of 3 connectors	
		Width	Type	Set reference	Weight kg
LC1 F115	LR9 F567, LR9 F67	15 mm	Rear	LA9FF981	0.060
			Side	LA9FF979	0.240
			Large surface area	LA9FF980	0.150
LC1 F150, F185	LR9 F569, F571, LR9 F69, F71	20 mm	Rear	LA9FG981	0.080
			Side	LA9FG979	0.350
			Large surface area	LA9FG980	0.200
LC1 F225, F265, F330, F400	LR9 F775, LR9 F75	25 mm	Rear	LA9FJ981	0.430
			Side	LA9FJ979	0.750
			Large surface area	LA9FJ980	0.490
LC1 F500	LR9 F779, F781, LR9 F79, F81	30 mm	Rear	LA9FK981	0.480
			Side	LA9FK979	0.920
			Large surface area	LA9FK980	0.800
LC1 F630, F800	LR9 F781, LR9 F81	40 mm	Rear	LA9FL981	1.210
			Side	LA9FL979	2.570
			Large surface area	LA9FL980	3.190

For use with Contactors	Width of connector plates	Type	Set of 6 connectors	
			Set reference	Weight kg
LC1 F1250	60 mm	Rear	LA9F1250	5.480
LC1 F1000, F1400, F1700, F2100	60 mm	Rear	LA9F2100	9.550
LC1 F2600	100 mm	Rear	LA9F2600	4.380

### Connection accessories

#### For reversing contactors or "star-delta" contactors combined with a thermal overload relay

For use with Contactors	Thermal overload relays <sup>(1)</sup>	Width of connector plates	Set of 3 busbars	
			Set reference	Weight kg
LC1 F115	LR9 F557, F563 LR9 F567, F569 LR9 F69, F71	15 mm	LA7F401	
LC1 F150 and F185	LR9 F557, F563	20 mm	LA7F402	
LC1 F185	LR9 F571, LR9 F71	25 mm	LA7F407	
LC1 F225 and F265	LR9 F571, LR9 F71	25 mm	LA7F403	
	LR9 F775, F779 LR9 F75, F79	25 mm	LA7F404	
LC1 F330 and F400	LR9 F775, F779 LR9 F75, F79	25 mm	LA7F404	
LC1 F400	LR9 F781, LR9 F81	25 mm	LA7F404	
LC1 F500	LR9 F775, F779 LR9 F781 LR9 F75, F79, F81	30 mm	LA7F405	
LC1 F630, F800	LR9 F781, LR9 F81	40 mm	LA7F406	

<sup>(1)</sup> For protection relays class 10, replace the ● with a 3 and for class 20, replace the ● with a 5.

# TeSys contactors

## TeSys F contactors

### Accessories

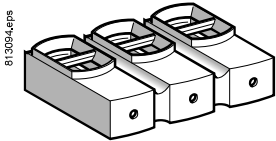

LA9 F103

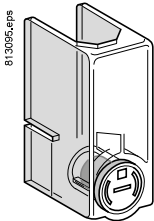

LA9 F701

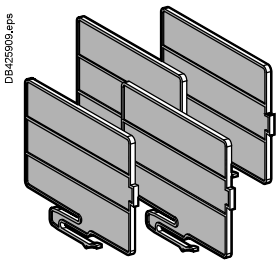

LA9 F801



LA4 EM250FK

High power contactors

#### Insulated terminal blocks

For use on 3-pole contactors	Connection	Tightening tool	Set of 2 blocks Set reference
LC1 F115, F150, F185	1 x 16...150 mm <sup>2</sup> or 2 x 16...95 mm <sup>2</sup>	4 mm hexagonal socket key	LA9F103

#### Power terminal protection shrouds

For use on 2, 3 and 4-pole contactors	Number of shrouds per set	Set reference
LC1 F115	6	LA9F701
LC1 F150, F185	6	LA9F702
LC1 F225, F265, F330, F400 and F4002 F500 and F5002	6	LA9F703
LC1 F630, F6302 and F800	6	LA9F704
LC1 F1154	8	LA9F706
LC1 F1504 and F1854	8	LA9F707
LC1 F2254, F2654, F3304, F4004, F5004	8	LA9F708
LC1 F6304	8	LA9F709

#### Phase separators

For use on 3-pole contactors	No. of barriers per set	Set reference
LC1 F1400, F1700 F2100 and F2600	4	LA9F801

#### Electronic Control Module (ECM) <sup>(1)</sup>

For use on 2, 3 and 4-pole contactors	With coil reference	ECM reference
LC1 F115, F150	LXEFF250	LA4EM250FF <sup>(2)</sup>
LC1 F185, F225	LXEFG250	LA4EM250FG
LC1 F265, F330	LXEFH250	LA4EM250FH <sup>(2)</sup>
LC1 F400	LXEFJ250	LA4EM250FJ <sup>(2)</sup>
LC1 F500	LXEFK250	LA4EM250FK
LC1 F630	LXEFL250	LA4EM250FL
LC1 F800	LXEFW250	LA4EM250FW <sup>(2)</sup>
LC1 SF1200	LXEFK250	LA4EM250FK
LC1 F1250	LXEFL250	LA4EM250FL

<sup>(1)</sup> ECM enables wider coil operating voltage for the TeSys F range of contactors.

**Note:** Refer to page numbers B9/54, B9/55 for detailed technical information.

<sup>(2)</sup> These ECM references + LXE coils will be available for ordering by end of June 2019.

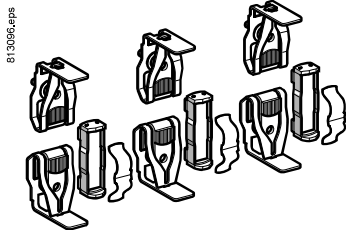

LA5 FG431

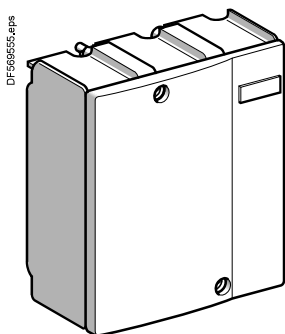

LA5 F40050

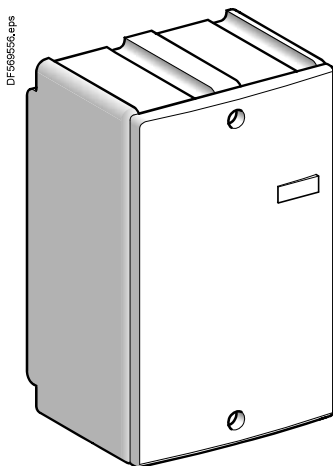

LA5 F210050

- (1) Comprising 2 identical items per pole.
- (2) Please consult us
- (3) Comprising three 2-pole arc chambers.
- (4) Comprising two 2-pole arc chambers.
- (5) Comprising single-pole arc chambers.

**Sets of contacts**

Per pole: 2 fixed contacts, 1 moving contact, 2 deflectors, 1 back-plate, clamping screws and washers.

For contactor	Type	Replacement for	Reference	Weight kg
2-pole	LC1 F4002	2 poles	LA5F400802	1.350
	LC1 F5002	2 poles	LA5F500802	1.950
	LC1 F6302	2 poles	LA5F630802	4.700
3-pole	LC1 F115. F150	3 poles	LA5FF431	0.270
	LC1 F185. F225	3 poles	LA5FG431	0.350
	LC1 F265	3 poles	LA5FH431	0.660
	LC1 F330. F400	3 poles	LA5F400803	2.000
	LC1 F500	3 poles	LA5F500803	2.950
	LC1 F630	3 poles	LA5F630803	6.100
	LC1 F780	1 pole	LA5F780801 (1)	4.700
		3 poles	LA5F780803	13.200
	LC1 F800	3 poles	LA5F800803	6.100
4-pole	LC1 F1504. F1154	4 poles	LA5FF441	0.360
	LC1 F1854. F2254	4 poles	LA5FG441	0.465
	LC1 F2654	4 poles	LA5FH441	0.880
	LC1 F3304. F4004	4 poles	LA5F400804	2.700
	LC1 F5004	4 poles	LA5F500804	3.900
	LC1 F6304	4 poles	LA5F630804	8.150
	LC1 F7804	1 pole	LA5F780801 (1)	4.700
		4 poles	LA5F780804	17.300
	LC1 F8004	4 poles	LA5F800804	17.300

**Arc chambers**

For contactor	Type	Replacement for	Reference	Weight kg
2-pole	LC1 F4002	2 poles	LA5F400250	0.870
	LC1 F5002	2 poles	LA5F500250	1.250
	LC1 F6302	2 poles	LA5F630250	2.100
3-pole	LC1 F115	3 poles	LA5F11550	0.490
	LC1 F150	3 poles	LA5F15050	0.490
	LC1 F185	3 poles	LA5F18550	0.670
	LC1 F225	3 poles	LA5F22550	0.670
	LC1 F265	3 poles	LA5F26550	0.920
	LC1 F330	3 poles	LA5F33050	1.300
	LC1 F400	3 poles	LA5F40050	1.300
	LC1 F500	3 poles	LA5F50050	1.850
	LC1 F630	3 poles	LA5F63050	3.150
	LC1 F780	1 pole	LA5F780150 (1)	2.100
	LC1 F800	3 poles	LA5F80050	3.150
	LC1 F1000	6 poles	LA5F100050	3.750
	LC1 F1250	3 poles	LA5F125050	3.150
	LC1 F1400	6 poles	LA5F140050 (3)	3.750
	LC1 F1700	6 poles	LA5F170050 (3)	3.750
LC1 F2100	6 poles	LA5F210050 (3)	3.750	
4-pole	LC1 F1154	4 poles	LA5F115450	0.660
	LC1 F1504	4 poles	LA5F150450	0.660
	LC1 F1854	4 poles	LA5F185450	0.910
	LC1 F2254	4 poles	LA5F225450	1.000
	LC1 F2654	4 poles	LA5F265450	1.220
	LC1 F3304	4 poles	LA5F330450	1.740
	LC1 F4004	4 poles	LA5F400450 (4)	1.740
	LC1 F5004	4 poles	LA5F500450 (4)	2.500
	LC1 F6304	4 poles	LA5F630450 (5)	4.200
	LC1 F7804	1 pole	LA5F780150 (1)	2.100

High power contactors

# TeSys contactors

Capacitive delayed opening devices

For TeSys F contactors



LAZR90F

## References

These devices prevent inadvertent opening of a contactor in the event of a brief volt drop or momentary supply failure.

### For contactors with d.c. coil supply

For use with contactor		Corresponding delayed opening device		
Type	With coil	Supply voltage 50/60 Hz	Non-adjustable delay time (Tr)	Reference
		V	s	
LC1 F115 or LC1 F150	LX4 FF110	110	2...5	LAZR90F
	LX4 FF125	127	2...5	LAZR90F
	LX4 FF220	220	2...5	LAZR90M
	LX4 FF250	240	2...5	LAZR90M
	LX4 FF375	380...415	2...5	LAZR90Q
	LX4 FF440	440	2...5	LAZR90Q
LC1 F185 or LC1 F225	LX4 FG110	110	2...5	LAZR90F
	LX4 FG125	127	2...5	LAZR90F
	LX4 FG220	220	2...5	LAZR90M
	LX4 FG250	240	2...5	LAZR90M
	LX4 FG375	380...415	2...5	LAZR90Q
	LX4 FG440	440	2...5	LAZR90Q
LC1 F265 or LC1 F330	LX4 FH110	110	2...5	LAZR90F
	LX4 FH125	127	2...5	LAZR90F
	LX4 FH220	220	2...5	LAZR90M
	LX4 FH250	240	2...5	LAZR90M
	LX4 FH375	380...415	2...5	LAZR90Q
	LX4 FH440	440	2...5	LAZR90Q
LC1 F400	LX4 FJ110	110	1...2	LAZR90F
	LX4 FJ125	127	1...2	LAZR90F
	LX4 FJ220	220	1...2	LAZR90M
	LX4 FJ250	240	1...2	LAZR90M
	LX4 FJ375	380	1...2	LAZR90Q
	LX4 FJ400	415	1...2	LAZR90Q
LC1 F500	LX4 FK110	110	1...2	LAZR90F
	LX4 FK125	127	1...2	LAZR90F
	LX4 FK220	220	1...2	LAZR90M
	LX4 FK250	240	1...2	LAZR90M
	LX4 FK375	380	1...2	LAZR90Q
	LX4 FK400	415	1...2	LAZR90Q
LC1 F630	LX4 FL110	110	1...2	LAZR90F
	LX4 FL125	127	1...2	LAZR90F
	LX4 FL220	220	1...2	LAZR90M
	LX4 FL250	240	1...2	LAZR90M
	LX4 FL375	380	1...2	LAZR90Q
	LX4 FL400	415	1...2	LAZR90Q
	LX4 FL440	440	1...2	LAZR90Q

### Add-on blocks for delayed opening devices

Application	For use with delayed opening device	Operational voltage	Non-adjustable delay time	Reference
		V	s	
To double the delay time	LAZR90F	110...127	Tr x 2	LAZR91F
	LAZR90M	220...240	Tr x 2	LAZR91M
	LAZR90Q	380...440	Tr x 2	LAZR91Q

### Other versions

Delayed opening devices for use with other types of contactor. Please consult your Regional Sales Office.

High power contactors



# TeSys contactors

## TeSys F contactors

a.c. 40...400 Hz supply coils

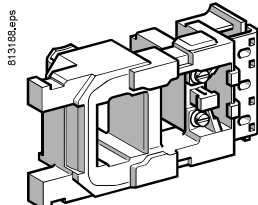

LX9 FF●●●

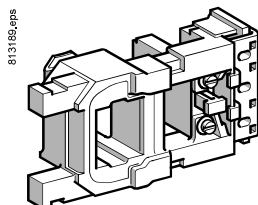

LX9 FG●●●

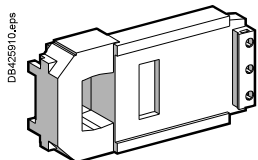

LXEFK250

### Specifications

Average consumption at 20 °C; 50 Hz/ 60 Hz;  
 $\cos \phi = 0.5$ :

- inrush: 550 VA
- sealed: 8 VA.

Heat dissipation: 5 W.

Operating time at  $U_c$ : closing = 40...80 ms,  
 opening = 10...40 ms.

Operating cycles/hour ( $\theta \leq 55$  °C): 1200.

Embedded PLC input according IEC 61131-2 type 2:

- Off state: 0...5 V DC
- On state: 11...30 V DC.

## References

Low sealed consumption.

High tolerance to inrush voltage drops.

Immune to micro-breaks (mains supply or contact chain).

Operate on networks with harmonic numbers  $\leq 7$ .

Control circuit voltage $U_c$	Average resistance at 20 °C $\pm 10$ %		Inductance of closed circuit	Voltage code	Reference
	Inrush	Sealed			
V	$\Omega$	$\Omega$	H		
<b>For contactors LC1 F115 and LC1 F150</b>					
48	3.03	80.2	0.3	E7	LX9FF048
110	14.8	579	2.08	F7	LX9FF110
115	14.8	579	2.08	FE7	LX9FF110
120/127	19	746	2.65	G7	LX9FF127
132	19	746	2.65	H7	LX9FF132
208	45	1788	5.95	L7	LX9FF200
220	59.4	2190	7.7	M7	LX9FF220
230	59.4	2190	7.7	P7	LX9FF220
240	73.5	2750	9.68	U7	LX9FF240
265	73.5	2750	9.68	UE7	LX9FF265
380	173	6540	23	Q7	LX9FF380
400	173	6540	23	V7	LX9FF380
415	218	8460	30	N7	LX9FF415
440	218	8460	30	R7	LX9FF415
460/480	262	10300	36	T7	LX9FF480
500	262	10300	36	S7	LX9FF500
575	331.4	12447	40	SC7	LX9FF575

### Specifications

Average consumption at 20 °C: inrush: 690...855 VA, sealed: 6.6...8.1 VA.

Heat dissipation: 5.9...7.2 W.

Operating cycles/hour ( $\theta \leq 55$  °C): < 2400.

Operating time at  $U_c$ : closing = 35 ms, opening = 130 ms.

<b>For contactors LC1 F185 and LC1 F225</b>					
48	2.2	60	0.23	E7	LX9FG048
110	10.4	411	1.46	F7	LX9FG110
115	10.4	411	1.46	FE7	LX9FG110
120/127	13	520	1.85	G7	LX9FG127
132	16.61	667.6	2.16	H7	LX9FG132
208	33	1339	4.9	L7	LX9FG200
220	42.1	1680	5.84	M7	LX9FG220
230	42.1	1680	5.84	P7	LX9FG220
240	50.6	2060	7.22	U7	LX9FG240
265	50.6	2060	7.22	UE7	LX9FG265
380	128	4730	16.4	Q7	LX9FG380
400	128	4730	16.4	V7	LX9FG380
415	157	5930	20.6	N7	LX9FG415
440	157	5930	20.6	R7	LX9FG415
460/480	194	7550	26.3	T7	LX9FG480
500	194	7550	26.3	S7	LX9FG500
575	246.3	9745	31.3	SC7	LX9FG575

### Specifications

Average consumption at 20 °C: inrush: 950...1180 VA, sealed: 8.9...10.9 VA.

Heat dissipation: 8...9.8 W.

Operating cycles/hour ( $\theta \leq 55$  °C): < 2400.

Operating time at  $U_c$ : closing = 35 ms, opening = 130 ms.

<b>For contactor LC1SF1200</b>					
100...250	100...250	9.16	0.16	KUE	LXEFK250

High power contactors

## TeSys contactors

TeSys F contactors

a.c. 40 to 400 Hz supply coils

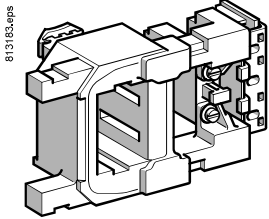

LX1 FH●●●2

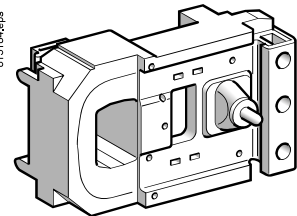

LX1 FJ●●●

High power contactors

## References

Low sealed consumption.

Operate on networks with harmonic numbers  $\leq 7$ .

Control circuit voltage U <sub>c</sub>	Average resistance at 20 °C ±10 %		Inductance of closed circuit	Voltage code	Reference
	Inrush	Sealed			
V	Ω	Ω	H		
<b>For contactors LC1 F265 and LC1 F330</b>					
24	0.8	20	(1)	B7	LX1FH0242
48	2.96	67	(1)	E7	LX1FH0482
110	18.7	440	(1)	F7	LX1FH1102
115	18.7	440	(1)	FE7	LX1FH1102
120/127	22.9	536	(1)	G7	LX1FH1272
200/208	58.4	1366	(1)	L7	LX1FH2002
220	70.6	1578	(1)	M7	LX1FH2202
230	70.6	1578	(1)	P7	LX1FH2202
240	87.94	1968	(1)	U7	LX1FH2402
277	113	2444	(1)	W7	LX1FH2772
380	217	4631	(1)	Q7	LX1FH3802
400	217	4631	(1)	V7	LX1FH3802
415	217	4631	(1)	N7	LX1FH3802
440	265	6731	(1)	R7	LX1FH4402
480/500	329	8543	(1)	S7	LX1FH5002
600/660	296	10245	(1)	X7	LX1FH6002
1000	696	25880	(1)	–	LX1FH10002

## Specifications

Average consumption at 20 °C for 50 or 60 Hz and  $\cos \varphi = 0.9$ :

■ inrush: 600...700 VA

■ sealed: 8...10 VA.

Heat dissipation: 8 W.

Operating time at U<sub>c</sub>: closing = 40...65 ms, opening = 100...170 ms.Operating cycles/hour ( $\theta \leq 55$  °C):  $\leq 2400$ .

<b>For contactor LC1 F400</b>					
48	1.6	29.5	0.18	E7	LX1FJ048
110/120	9.8	230	1.35	F7	LX1FJ110
115	9.8	230	1.35	FE7	LX1FJ110
120/127	12.8	280	1.75	G7	LX1FJ127
200/208	30	815	4.1	L7	LX1FJ200
220	37	1030	5.1	M7	LX1FJ220
230	37	1030	5.1	P7	LX1FJ220
240	47.5	1320	6.4	U7	LX1FJ240
265/277	61	1700	8.1	W7	LX1FJ280
380	120	3310	15.8	Q7	LX1FJ380
400	120	3310	15.8	V7	LX1FJ380
415	145	4070	19.4	N7	LX1FJ415
440	145	4070	19.4	R7	LX1FJ415
500	190	4980	25.5	S7	LX1FJ500
550/600	243	6310	27.4	X7	LX1FJ600
1000	720	19420	84.6	–	LX1FJ1000

## Specifications

Average consumption at 20 °C for 50 or 60 Hz and  $\cos \varphi = 0.9$ :

■ inrush: 1000...1150 VA

■ sealed: 12...18 VA.

Heat dissipation: 14 W.

Operating time at U<sub>c</sub>: closing = 40...75 ms, opening = 100...170 ms.Operating cycles/hour ( $\theta \leq 55$  °C):  $\leq 2400$ .

(1) Please consult your Regional Sales Office.

## TeSys contactors

TeSys F contactors

a.c. 40 to 400 Hz supply coils

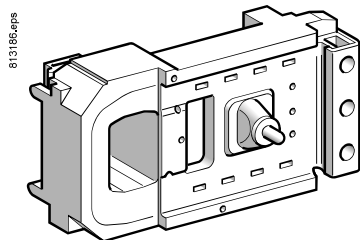

LX1 FK●●●

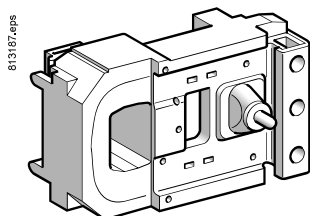

LX1 FL●●●

## References

Low sealed consumption.

Operate on networks with harmonic numbers  $\leq 7$ .

Control circuit voltage U <sub>c</sub>	Average resistance at 20 °C $\pm 10\%$		Inductance of closed circuit H	Voltage code	Reference	Weight kg
	Inrush $\Omega$	Sealed $\Omega$				
<b>For contactor LC1 F500</b>						
48	1.9	33.5	0.19	E7	LX1FK048	1.150
110/120	9.55	260	1.25	F7	LX1FK110	1.150
115	9.55	260	1.25	FE7	LX1FK110	1.150
120/127	11.5	315	1.5	G7	LX1FK127	1.150
200/208	29	735	3.75	L7	LX1FK200	1.150
220	35.5	915	4.55	M7	LX1FK220	1.150
230	35.5	915	4.55	P7	LX1FK220	1.150
240	44.5	1160	5.75	U7	LX1FK240	1.150
265/277	56.5	1490	7.3	W7	LX1FK280	1.150
380	112	2980	14.7	Q7	LX1FK380	1.150
400	112	2980	14.7	V7	LX1FK380	1.150
415	143	3730	18.4	N7	LX1FK415	1.150
440	143	3730	18.4	R7	LX1FK415	1.150
500	172	4590	22.8	S7	LX1FK500	1.150
550/600	232	5660	23.9	X7	LX1FK600	1.150
1000	679	16960	72	–	LX1FK1000	1.150

## Specifications

Average consumption at 20 °C for 50 or 60 Hz,  $\cos \varphi = 0.9$ :

■ inrush: 1050...1150 VA,

■ sealed: 16...20 VA.

Operating cycles/hour ( $\theta \leq 55$  °C):  $\leq 2400$ .

Heat dissipation: 18 W.

Operating time at U<sub>c</sub>: closing = 40...75 ms, opening = 100...170 ms.

<b>For contactor LC1 F630 and LC1 F1250</b>						
48	1.1	17.1	0.09	E7	LX1FL048 <sup>(1)</sup>	1.500
110/120	6.45	165	1.85	F7	LX1FL110	1.500
115	6.45	165	1.85	FE7	LX1FL110	1.500
127	8.1	205	1.05	G7	LX1FL127	1.500
200/208	20.5	605	2.65	L7	LX1FL200	1.500
220	25.5	730	3.35	M7	LX1FL220	1.500
230	25.5	730	3.35	P7	LX1FL220	1.500
240	25.5	730	3.35	U7	LX1FL220	1.500
265/277	31	900	4.1	W7	LX1FL260	1.500
380	78	2360	10.5	Q7	LX1FL380	1.500
400	78	2360	10.5	V7	LX1FL380	1.500
415	96	2960	13	N7	LX1FL415	1.500
440	96	2960	13	R7	LX1FL415	1.500
500	120	3660	16.5	S7	LX1FL500	1.500
550/600	155	4560	19.5	X7	LX1FL600	1.500
1000	474	12880	56.2	–	LX1FL1000 <sup>(1)</sup>	1.500

<sup>(1)</sup> Incompatible with LC1F1250.

## Specifications

Average consumption at 20 °C for 50 or 60 Hz,  $\cos \varphi = 0.9$ :

■ inrush: 1500...1730 VA,

■ sealed: 20...25 VA.

Operating cycles/hour ( $\theta \leq 55$  °C): 1200.

Heat dissipation: 20 W.

Operating time at U<sub>c</sub>: closing = 40...80 ms, opening = 100...200 ms.

# TeSys contactors

## TeSys F contactors

a.c. 40 to 400 Hz supply coils

### Specifications

Average consumption at 20 °C for 50 or 60 Hz,  $\cos \varphi = 0,9$ :

■ inrush: 1900...2300 VA, sealed: 44...55 VA.

Operating cycles/hour ( $\theta \leq 55 \text{ }^\circ\text{C}$ ): 600.

Heat dissipation: 2 x 22 W.

Operating time at  $U_c$ : closing = 40...80 ms, opening = 130...230 ms.

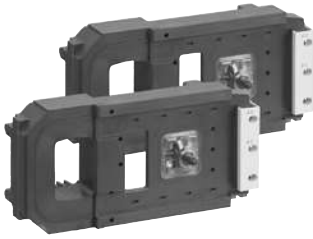

LX1 FX●●●

### Specifications

Operating cycles/hour ( $\theta \leq 55 \text{ }^\circ\text{C}$ ): 600.

Average consumption at 20 °C for 50 or 60 Hz,  $\cos \varphi = 0,8$ :

■ inrush: 1700 VA, sealed: 12 VA.

Operating time at  $U_c$ : closing = 60...80 ms,

opening = 160...180 ms.

### Specifications

Average consumption at 20 °C for 50 or 60 Hz,  $\cos \varphi = 0,9$ :

■ inrush: 1600...2400 VA, sealed: 29...37 VA.

Operating cycles/hour ( $\theta \leq 55 \text{ }^\circ\text{C}$ ): 600.

Heat dissipation: 2 x 18 W.

Operating time at  $U_c$ : closing = 40...75 ms, opening = 100...170 ms.

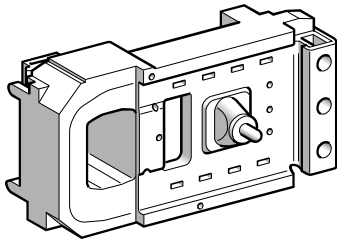

LX1 FK●●●

### Specifications

Average consumption at 20 °C for 50 or 60 Hz,  $\cos \varphi = 0,9$ :

■ inrush: 2200...2700 VA, sealed: 37.4...50.6 VA.

Operating cycles/hour ( $\theta \leq 55 \text{ }^\circ\text{C}$ ): 600.

Heat dissipation: 2 x 25 W.

Operating time at  $U_c$ : closing = 40...80 ms, opening = 100...200 ms.

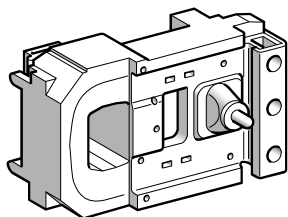

LX1 FL●●●

(1) Reference of set of 2 identical coils, to be connected in series.

(2) Value for the 2 coils in series.

(3) Rectifier to be ordered separately: 0.100 kg.

(4) Order 2 coils and connect them in series.

## References

Low sealed consumption.

Operate on networks with harmonic numbers  $\leq 7$ .

Control circuit voltage $U_c$	Average resistance at 20 °C $\pm 10 \%$		Inductance of closed circuit	Voltage code	Reference	Weight
	Inrush	Sealed				
V	$\Omega$	$\Omega$	H			kg
<b>For contactor LC1 F780</b>						
110/120	4.95 <sup>(2)</sup>	230 <sup>(2)</sup>	0.21	F7	LX1FX110 <sup>(1)</sup>	3.000
115	4.95 <sup>(2)</sup>	230 <sup>(2)</sup>	0.21	FE7	LX1FX110 <sup>(1)</sup>	3.000
127	6.1 <sup>(2)</sup>	280 <sup>(2)</sup>	0.26	G7	LX1FX127 <sup>(1)</sup>	3.000
200/208	15.5 <sup>(2)</sup>	750 <sup>(2)</sup>	0.66	L7	LX1FX200 <sup>(1)</sup>	3.000
220	19.5 <sup>(2)</sup>	920 <sup>(2)</sup>	0.82	M7	LX1FX220 <sup>(1)</sup>	3.000
230	19.5 <sup>(2)</sup>	920 <sup>(2)</sup>	0.82	P7	LX1FX220 <sup>(1)</sup>	3.000
240	19.5 <sup>(2)</sup>	920 <sup>(2)</sup>	0.82	U7	LX1FX220 <sup>(1)</sup>	3.000
265/277	29.8 <sup>(2)</sup>	1330 <sup>(2)</sup>	1.25	W7	LX1FX280 <sup>(1)</sup>	3.000
380	60.9 <sup>(2)</sup>	2780 <sup>(2)</sup>	2.3	Q7	LX1FX380 <sup>(1)</sup>	3.000
400	60.9 <sup>(2)</sup>	2780 <sup>(2)</sup>	2.3	V7	LX1FX380 <sup>(1)</sup>	3.000
415/480	74.3 <sup>(2)</sup>	3340 <sup>(2)</sup>	2.8	N7	LX1FX415 <sup>(1)</sup>	3.000
440	74.3 <sup>(2)</sup>	3340 <sup>(2)</sup>	2.8	R7	LX1FX415 <sup>(1)</sup>	3.000
500	92 <sup>(2)</sup>	4180 <sup>(2)</sup>	3.5	S7	LX1FX500 <sup>(1)</sup>	3.000

Control circuit voltage $U_c$	Voltage code	Rectifier Reference <sup>(3)</sup>	Coil Reference	Weight
V				kg
<b>For contactor LC1 F800</b>				
110/127	FE7	DR5TE4U	LX4F8FW	1.650
220/240	P7	DR5TE4U	LX4F8MW	1.650
380/400	V7	DR5TE4S	LX4F8QW	1.650

Control circuit voltage $U_c$	Average resistance at 20 °C $\pm 10 \%$		Inductance of closed circuit	Voltage code	Reference	Weight
	Inrush	Sealed				
V	$\Omega$	$\Omega$	H			kg
<b>For contactor LC1 F1000</b>						
110	4.718	98.4	0.63	F7	LX1FK055 <sup>(4)</sup>	1.150
120	5.92	106	0.72	G7	LX1FK065 <sup>(4)</sup>	1.150
<b>For contactors LC1 F1400, LC1 F1700 and LC1 F2100</b>						
110	5.92	106	0.72	F7	LX1FK065 <sup>(4)</sup>	1.150
120	5.92	106	0.72	G7	LX1FK070 <sup>(4)</sup>	1.150
<b>For contactors LC1 F1000, LC1 F1400, LC1 F1700 and LC1 F2100</b>						
220	9.55	260	1.25	M7	LX1FK110 <sup>(4)</sup>	1.150
230	9.55	260	1.25	P7	LX1FK110 <sup>(4)</sup>	1.150
240	11.5	315	1.50	U7	LX1FK127 <sup>(4)</sup>	1.150
277	16.5	420	2.25	W7	LX1FK140 <sup>(4)</sup>	1.150
380	29	735	3.75	Q7	LX1FK200 <sup>(4)</sup>	1.150
400	29	735	3.75	V7	LX1FK200 <sup>(4)</sup>	1.150
415	35.5	915	4.55	N7	LX1FK220 <sup>(4)</sup>	1.150
440	35.5	915	4.55	R7	LX1FK220 <sup>(4)</sup>	1.150
500	44.5	1160	5.75	S7	LX1FK240 <sup>(4)</sup>	1.150

Control circuit voltage $U_c$	Average resistance at 20 °C $\pm 10 \%$		Inductance of closed circuit	Voltage code	Reference	Weight
	Inrush	Sealed				
V	$\Omega$	$\Omega$	H			kg
<b>For contactors LC1 F2600</b>						
110	2.05	41	0.18	F7	LX1FL065 <sup>(4)</sup>	1.150
120	2.05	41	0.18	G7	LX1FL065 <sup>(4)</sup>	1.150
220	6.45	165	0.76	M7	LX1FL110 <sup>(4)</sup>	1.150
230	6.45	165	0.76	P7	LX1FL110 <sup>(4)</sup>	1.150
240	8.1	205	1.05	U7	LX1FL127 <sup>(4)</sup>	1.150
277	10.2	317	1.45	W7	LX1FL140 <sup>(4)</sup>	1.150
380	20.5	605	2.65	Q7	LX1FL200 <sup>(4)</sup>	1.150
400	20.5	605	2.65	V7	LX1FL200 <sup>(4)</sup>	1.150
415	25.5	730	3.35	N7	LX1FL220 <sup>(4)</sup>	1.150
440	25.5	730	3.35	R7	LX1FL220 <sup>(4)</sup>	1.150
500	30.8	901	4.13	S7	LX1FL260 <sup>(4)</sup>	1.150

## TeSys contactors

## TeSys F contactors

a.c. 40 to 400 Hz supply coils for specific applications <sup>(1)</sup>

## References

Low sealed consumption.

High tolerance to inrush voltage drops.

Immune to micro-breaks (mains supply or contact chain).

Operate on networks with harmonic numbers  $\leq 7$ .

Control circuit voltage Uc	Average resistance at 20 °C $\pm 10$ %		Inductance of closed circuit	Voltage code	Reference
	Inrush	Sealed			
V	$\Omega$	$\Omega$	H		
<b>For contactors LC1 F265 and LC1 F330</b>					
48	2.96	72	<sup>(2)</sup>	–	LX9FH0482
110/115	18.7	415	<sup>(2)</sup>	–	LX9FH1102
120/127	22.9	156	<sup>(2)</sup>	–	LX9FH1272
220/230	71.6	1621	<sup>(2)</sup>	–	LX9FH2202
240	88	1968	<sup>(2)</sup>	–	LX9FH2402
380/415	222	5075	<sup>(2)</sup>	–	LX9FH3802
500	345	7990	<sup>(2)</sup>	–	LX9FH5002

## Specifications

Average consumption at 20 °C: inrush: 560...660 VA, sealed: 8...10 VA.

Heat dissipation: 8.4...10.4 W.

Operating cycles/hour ( $\theta \leq 55$  °C): < 3600.Operating time at U<sub>c</sub>: closing = 45 ms, opening = 25 ms.

<sup>(1)</sup> Application examples: hoisting (inching, high operating rates), Main-Standby (unstable mains supplies). These coils are particularly suited for use at higher operating temperatures (mounting in non-ventilated compartments, enclosures, etc.).

<sup>(2)</sup> Please consult your Regional Sales Office.

# TeSys contactors

## TeSys F contactors

a.c. 40 to 400 Hz supply coils for specific applications

These coils are particularly suited for use at higher operating temperatures (mounting in non-ventilated compartments, enclosures, etc).  
Application examples: hoisting (inching, high operating rates), Main-Standby (unstable mains supplies).

### References

Coils with short operating times (at  $U_c$ ):

- Closing: 60 ms
- Opening: 50 ms ( $\sim$  side); 20 ms ( $\dashv$  side).

Coils with high operating rates ( $\theta \leq 70^\circ\text{C}$ ):

- 3600 operating cycles/hour
- 1800 for LC1 F630.

Coils with low inrush consumption.

Control circuit voltage $U_c$	Average resistance at $20^\circ\text{C} \pm 10\%$		Inductance of closed circuit	Rectifier Reference <sup>(1)</sup>	Coil Reference	Weight
	Inrush	Sealed				
V	$\Omega$	$\Omega$	H			kg
<b>For contactor LC1 F400</b>						
48	4.03	43	0.22	DR5TF4V	LX9FJ917	0.970
110	25.7	246	1.3	DR5TE4U	LX9FJ925	0.970
127	32.3	302	1.7	DR5TE4U	LX9FJ926	0.970
220/230	99.5	919	5	DR5TE4U	LX9FJ931	0.970
380/415	311	3011	15	DR5TE4S	LX9FJ936	0.970
440	386	3690	19	DR5TE4S	LX9FJ937	0.970
500	478	4380	23	DR5TE4S	LX9FJ938	0.970

#### Specifications

Average consumption:

- inrush: 500 VA
- sealed: 23 VA.

Heat dissipation: 11.4...13.9 W.

<b>For contactor LC1 F500</b>						
48	3.73	30.7	0.18	DR5TF4V	LX9FK917	1.080
110	24	204	1.1	DR5TE4U	LX9FK925	1.080
127	29.8	250	1.4	DR5TE4U	LX9FK926	1.080
220/230	89.9	770	4	DR5TE4U	LX9FK931	1.080
380/415	274	2075	12	DR5TE4S	LX9FK936	1.080
440	361	3060	16	DR5TE4S	LX9FK937	1.080
500	448	3750	19	DR5TE4S	LX9FK938	1.080

#### Specifications

Average consumption:

- inrush: 550 VA
- sealed: 31 VA.

Heat dissipation: 15...18.3 W.

<b>For contactor LC1 F630</b>						
48	2.81	20.8	0.17	DR5TF4V	LX9FL917	1.450
110	13.5	114	0.77	DR5TE4U	LX9FL924	1.450
127	20.8	167	1.2	DR5TE4U	LX9FL926	1.450
220	52	425	2.9	DR5TE4U	LX9FL930	1.450
220/240	64.5	518	3.6	DR5TE4U	LX9FL931	1.450
380/400	163	1360	8.8	DR5TE4S	LX9FL935	1.450
415/440	204	1670	11	DR5TE4S	LX9FL936	1.450
500	312	2510	17	DR5TE4S	LX9FL938	1.450

#### Specifications

Average consumption:

- inrush: 830 VA
- sealed: 47 VA.

Heat dissipation: 22.8...27.8 W.

<sup>(1)</sup> Rectifier to be ordered separately: 0.100 kg.

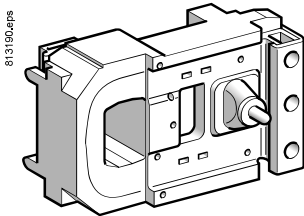

LX9 FJ●●●

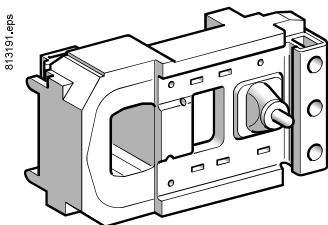

LX9 FK●●●

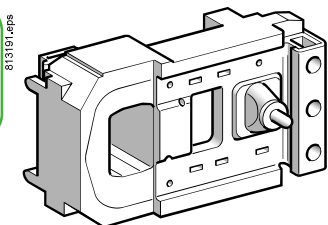

LX9 FL●●●

High power contactors

## TeSys contactors

TeSys F contactors

d.c. supply coils

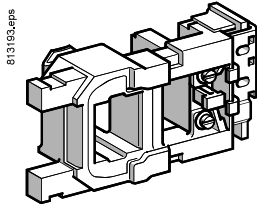

LX4 FF●●●

## References

Low sealed consumption.

Control circuit voltage Uc	Average resistance at 20 °C ±10 %		Inductance of closed circuit	Voltage code	Reference
	Inrush	Sealed			
V	Ω	Ω	H		
<b>For contactors LC1 F115 and LC1 F150</b>					
24	1.12	177	11	BD	LX4FF024
48	4.52	715	42.7	ED	LX4FF048
110	21.7	2940	179	FD	LX4FF110
125	26.8	3560	223	GD	LX4FF125
220/230	84	11100	704	MD	LX4FF220
250	105	13000	868	UD	LX4FF250
440/460	301	48200	4000	RD	LX4FF440

## Specifications

Average consumption:

■ inrush: 543...665 W,

■ sealed: 3.94...4.83 W.

Operating time at Uc: closing = 30...40 ms, opening = 30...50 ms.

Operating cycles/hour ( $\theta \leq 55$  °C):  $\leq 2400$ .

## For contactors LC1 F185 and LC1 F225

24	0.79	169	14.9	BD	LX4FG024
48	3.2	662	55.3	ED	LX4FG048
110	14.9	2810	241	FD	LX4FG110
125	19	3320	289	GD	LX4FG125
220/230	57.7	10200	890	MD	LX4FG220
250	76	12400	1140	UD	LX4FG250
440/460	223	39700	4210	RD	LX4FG440

## Specifications

Average consumption:

■ inrush: 737...902 W,

■ sealed: 4.13...5.07 W.

Operating time at Uc: closing = 30...40 ms, opening = 30...50 ms.

Operating cycles/hour ( $\theta \leq 55$  °C):  $\leq 2400$ .

## For contactors LC1 F265 and LC1 F330

24	0.9	192	26.3	BD	LX4FH024
48	3.49	707	92.9	ED	LX4FH048
110	16.8	3180	424	FD	LX4FH110
125	20.8	3840	530	GD	LX4FH125
220/230	65.7	11500	1590	MD	LX4FH220
250	84	13900	1910	UD	LX4FH250
440/460	255	44000	7570	RD	LX4FH440

## Specifications

Average consumption:

■ inrush: 655...803 W,

■ sealed: 3.68...4.53 W.

Operating time at Uc: closing = 40...50 ms, opening = 40...65 ms.

Operating cycles/hour ( $\theta \leq 55$  °C):  $\leq 2400$ .

## For contactor LC1 F400

48	2.5	558	56	ED	LX4FJ048
110	12.7	2660	270	FD	LX4FJ110
125	15.8	3130	330	GD	LX4FJ125
220	47	8820	910	MD	LX4FJ220
250	61	10500	1200	UD	LX4FJ250
440	236	33750	4435	RD	LX4FJ440

## Specifications

Average consumption:

■ inrush: 920...1140 W,

■ sealed: 4...7.5 W.

Operating time at Uc: closing = 50...60 ms, opening = 45...60 ms.

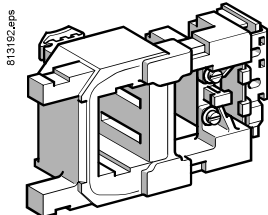
Operating cycles/hour ( $\theta \leq 55$  °C):  $\leq 2400$ .

LX4 FH●●●

## TeSys contactors

## TeSys F contactors

d.c. supply coils

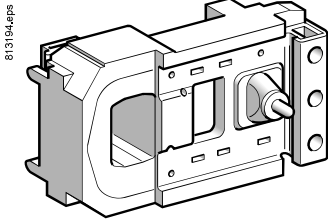

LX4 FK●●●

**LX4FK specifications**

Average consumption:

■ inrush: 990...1220 W,

■ sealed: 4.54...8 W.

Operating cycles/hour ( $\theta \leq 55^\circ\text{C}$ ): 2400.Operating time at  $U_c$ : closing = 50...60 ms,

opening = 45...60 ms.

**LXEFK specifications**

Average consumption:

■ inrush: 500 W

■ sealed: 5 W.

Operating cycles/hour ( $\theta \leq 55^\circ\text{C}$ ): 1200.Operating time at  $U_c$ : closing = 40...80 ms,

opening = 10...40 ms.

Embedded PLC input according IEC 61131-2 type 2:

■ Off state: 0...5 V DC

■ On state: 11...30 V DC.

**LX4FL specifications**

Average consumption:

■ inrush: 1420...1920 W,

■ sealed: 6.5...12.5 W.

Operating cycles/hour ( $\theta \leq 55^\circ\text{C}$ ): 1200.Operating time at  $U_c$ : closing = 60...70 ms,

opening = 40...50 ms.

**LX4FX specifications**

Average consumption:

■ inrush: 1960...2420 W

■ sealed: 42...52 W.

Operating cycles/hour ( $\theta \leq 55^\circ\text{C}$ ): 600.Operating time at  $U_c$ : closing = 70...80 ms,

opening = 100...130 ms.

**LX4F8 specifications**

Heat dissipation: 25 W.

Operating time at  $U_c$ : closing = 60...80 ms,

opening = 40...50 ms.

**LX4FK specifications****with LC1 F1000,1400,1700, 2100**

Average consumption:

■ inrush: 2000...2200 W,

■ sealed: 8...10 W.

Operating cycles/hour ( $\theta \leq 55^\circ\text{C}$ ): 600.Operating time at  $U_c$ : closing = 50...60 ms,

opening = 45...60 ms.

**LX4FL specifications with LC1F2600**

Average consumption:

■ inrush: 2130...2880 W

■ sealed: 13...25 W.

Operating cycles/hour ( $\theta \leq 55^\circ\text{C}$ ): 600.Operating time at  $U_c$ : closing = 60...70 ms,

opening = 40...50 ms.

**References**

Low sealed consumption.

Control circuit voltage $U_c$	Average resistance at $20^\circ\text{C} \pm 10\%$		Inductance of closed circuit	Voltage code	Reference	Weight
	Inrush	Sealed				
V	$\Omega$	$\Omega$	H			kg
<b>For contactor LC1 F500</b>						
48	2.35	515	67	ED	LX4FK048	1.080
110	11.5	2450	280	FD	LX4FK110	1.080
125	15	2930	400	GD	LX4FK125	1.080
220	44	8150	1080	MD	LX4FK220	1.080
250	56	9650	1350	UD	LX4FK250	1.080
440	225	31300	5270	RD	LX4FK440	1.080

**For contactor LC1 F500 and LC1 SF1200**

100...380	—	9.16	0.16	KUE	LXEFK250	1.100
-----------	---	------	------	-----	----------	-------

**For contactor LC1 F630 and LC1 F1250**

48	1.7	353	40.5	ED	LX4FL048	1.450
110	8.1	1680	180	FD	LX4FL110	1.450
125	10	2110	230	GD	LX4FL125 <sup>(1)</sup>	1.450
220	31	5160	650	MD	LX4FL220	1.450
250	38	6080	815	UD	LX4FL250	1.450
440	152	23120	2910	RD	LX4FL440 <sup>(1)</sup>	1.450

**For contactor LC1 F780**

110	6.1 <sup>(3)</sup>	280 <sup>(3)</sup>	0.26	FD	LX4FX110 <sup>(2)</sup>	3.000
125	7.7 <sup>(3)</sup>	410 <sup>(3)</sup>	0.33	GD	LX4FX125 <sup>(2)</sup>	3.000
220	24.6 <sup>(3)</sup>	1100 <sup>(3)</sup>	1	MD	LX4FX220 <sup>(2)</sup>	3.000
250	29.8 <sup>(3)</sup>	1330 <sup>(3)</sup>	1.25	UD	LX4FX250 <sup>(2)</sup>	3.000
440	92 <sup>(3)</sup>	4180 <sup>(3)</sup>	3.5	RD	LX4FX440 <sup>(2)</sup>	3.000

**For contactor LC1 F800**

110/120	—	—	—	FW	LX4F8FW	1.650
220/240	—	—	—	MW	LX4F8MW	1.650
380/400	—	—	—	QW	LX4F8QW	1.650

**For contactors LC1 F1000, LC1 F1400, LC1 F1700 and LC1 F2100**

110	2.94	734	98	FD	LX4FK055 <sup>(4)</sup>	1.080
125	3.73	916	122	GD	LX4FK065 <sup>(4)</sup>	1.080
220	11.5	2450	280	MD	LX4FK110 <sup>(4)</sup>	1.080
250	15	2930	400	UD	LX4FK125 <sup>(4)</sup>	1.080
440	44	8150	1080	RD	LX4FK220 <sup>(4)</sup>	1.080

**For contactors LC1 F2600**

110	2.05	481	64	FD	LX4FL055 <sup>(4)</sup>	1.080
125	2.53	603	80	GD	LX4FL065 <sup>(4)</sup>	1.080
220	11.5	2450	280	MD	LX4FL110 <sup>(4)</sup>	1.080
250	15	2930	400	UD	LX4FL125 <sup>(4)</sup>	1.080
440	44	8150	1080	RD	LX4FL220 <sup>(4)</sup>	1.080

<sup>(1)</sup> Incompatible with LC1 F1250.<sup>(2)</sup> Reference of set of 2 identical coils, to be connected in series.<sup>(3)</sup> Value for the 2 coils in series.<sup>(4)</sup> Order 2 coils and connect them in series.



# TeSys contactors

## TeSys F contactors

d.c. supply coils for specific applications

### References

Coils with short operating times (at  $U_c$ ):

- Opening: 60 ms
- Closing: 20 ms.

Coils with high operating rates ( $\theta \leq 70\text{ °C}$ ):

- 3600 operating cycles/hour
- 1800 for LC1 F630.

Coils with low inrush consumption.

Control circuit voltage $U_c$	Average resistance at 20 °C $\pm 10\%$		Inductance of closed circuit	Resistor <sup>(1)</sup> Qty required	Coil		Weight
	Inrush	Sealed			Reference	Reference	
V	$\Omega$	$\Omega$	H				kg
<b>For contactor LC1 F400</b>							
48	5.11	99	0.27	1	DR2SC0047	LX9FJ918	0.970
110	32.3	632	1.7	1	DR2SC0330	LX9FJ926	0.970
125	39.4	760	2	1	DR2SC0390	LX9FJ927	0.970
220	123	2320	6.1	1	DR2SC1200	LX9FJ932	0.970
440/460	478	9080	23	1	DR2SC4700	LX9FJ938	0.970

#### Specifications

Average consumption:

- inrush: 430 W
- sealed: 22 W.

#### For contactor LC1 F500

48	4.67	76.7	0.22	1	DR2SC0039	LX9FK918	1.080
110	29.8	470	1.4	1	DR2SC0220	LX9FK926	1.080
125	37.4	637	1.7	1	DR2SC0330	LX9FK927	1.080
220	115	1935	5.1	1	DR2SC1000	LX9FK932	1.080
440/460	448	7050	19	1	DR2SC3300	LX9FK938	1.080

#### Specifications

Average consumption:

- inrush: 470 W
- sealed: 29 W.

#### For contactor LC1 F630

48	3.43	52.9	0.20	2	DR2SC0047	LX9FL918	1.450
110	17.2	272	0.98	2	DR2SC0270	LX9FL925	1.450
125	20.8	333	1.2	2	DR2SC0330	LX9FL926	1.450
220	64.5	1018	3.6	2	DR2SC1000	LX9FL931	1.450
440/460	260	4010	14	2	DR2SC3900	LX9FL937	1.450

#### Specifications

Average consumption:

- inrush: 733 W
- sealed: 48 W.

<sup>(1)</sup> Resistor to be ordered separately, weight of resistor: 0.030 kg.

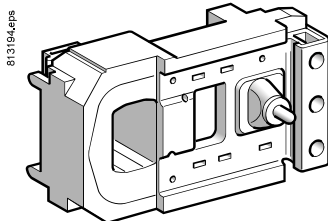

LX9 FJ●●●

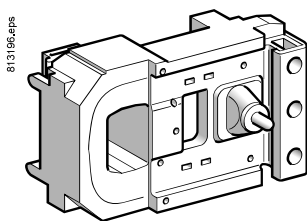

LX9 FK●●●

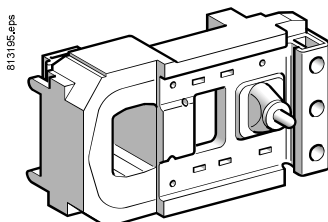

LX9 FL●●●

# TeSys contactors

## TeSys F contactors

Wide range d.c. supply coils for specific applications

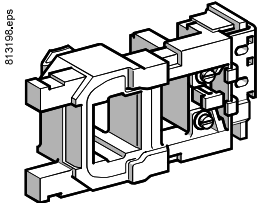

LX4 FF●●●

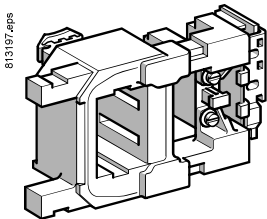

LX4 FH●●●

High power contactors

### References

Wide range coils: 0.7...1.25 Uc.

Operating cycles/hour: ≤ 60 <sup>(1)</sup>.

Ambient temperature (operation): -55 to + 70 °C.

Control circuit voltage Uc	Average resistance at 20 °C ±10 %		Inductance of closed circuit	Reference
	Inrush	Sealed		
V	Ω	Ω	H	
<b>For contactors LC1 F115 and LC1 F150</b>				
24	0.71	120	7.4	LX4FF020
48	2.86	392	27	LX4FF040
72	7.05	1055	66	LX4FF060
110	13.2	1970	121	LX4FF090
125	16.9	2340	149	LX4FF100

#### Specifications

Average consumption:

- inrush: 415...1300 W
- sealed: 3...9 W.

#### For contactors LC1 F185 and LC1 F225

24	0.52	112	9.3	LX4FG020
48	2	359	34.4	LX4FG040
72	5.07	984	85	LX4FG060
110	9.66	1840	157	LX4FG090
125	12	2230	196	LX4FG100

#### Specifications

Average consumption:

- inrush: 580...1820 W
- sealed: 3.1...9.5 W.

#### For contactors LC1 F265 and LC1 F330

24	0.58	129	17.3	LX4FH020
48	2.19	400	59.5	LX4FH040
72	5.58	1110	149	LX4FH060
110	11	2120	287	LX4FH090
125	13.8	2520	353	LX4FH100

#### Specifications

Average consumption:

- inrush: 515...1600 W
- sealed: 2.7...8.5 W.

Operational voltage	Average resistance at 20 °C ±10 %	Inductance of closed circuit	Coil		Economy resistor		Reference of the assembly <sup>(2)</sup>
			Reference	No. Ω	Resistors in //	Reference	
V	Ω	H					
<b>For contactor LC1 F400</b>							
24	1.05	0.049	LX2FJW11	3	56	DR2SC0056	LX5FJW11
48	4.8	0.22	LX2FJW18	3	220	DR2SC0220	LX5FJW18
72	9.6	0.44	LX2FJW21	3	470	DR2SC0470	LX5FJW21

#### Specifications

Average consumption:

- inrush: 290...860 W
- sealed: 16...47 W.

(1) The mechanical durability of the contactor is limited to 1 million operating cycles.

(2) The set comprises: 1 coil LX2 FJ and 3 resistors DR2 SC.

# TeSys contactors

Auxiliary contact blocks for 3-pole shockproof contactors LC1 FG

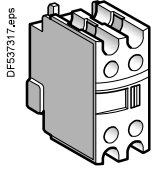

LAD N●●

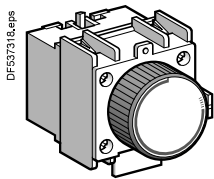

LAD T●

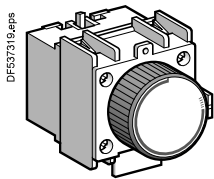

LAD R●

## Instantaneous auxiliary contact blocks

For use in normal operating environments

Number of contacts	Max. number of blocks per contactor Clip-on mounting	Composition				Reference	Anchor
1	1	-	-	1	-	LADN10	(1)
		-	-	-	1	LADN01	(1)
4	1	-	-	2	2	LADN22	(1)
		-	-	4	-	LADN40	(1)
		-	-	-	4	LADN04	(1)
		-	-	3	1	LADN31	(1)

## Time delay auxiliary contact blocks

Number of contacts	Max. number of blocks per contactor Clip-on mounting	Time delay		Reference	Anchor
		Type	Range s		
1 N/O + 1 N/C	1	On-delay	0.1...3 (2)	LADT0	
			0.1...30	LADT2	(1)
			10...180	LADT4	
		Off-delay	1...30 (3)	LADS2	
			0.1...3 (2)	LADR0	
			0.1...30	LADR2	(1)
		10...180	LADR4		

(1) Device approved by the DCN (French naval shipyard department) and authorised for on-board use.

(2) With extended scale from 0.1 to 0.6 s.

(3) With switching time of 40 ms ±15 ms between opening of the N/C contact and closing of the N/O contact.

## TeSys contactors

Coils for 3-pole shockproof contactors LC1 FG

Spare or replacement parts a.c. supply 40...400 Hz

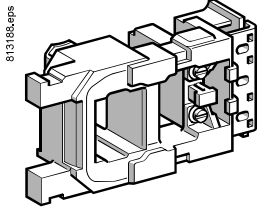

LX9 FF●●●

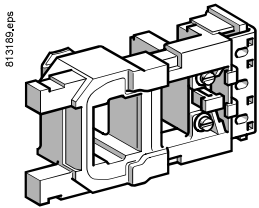

LX9 FG●●●

### References

Control circuit voltage U <sub>c</sub>	Average resistance at 20 °C ±10 %		Inductance of closed circuit	Voltage code	Reference
	Inrush	Sealed			
V	Ω	Ω	H		
<b>For contactor LC1 FG150</b>					
48	3.03	80.2	0.3	E7	LX9FF048
110	14.8	579	2.08	F7	LX9FF110
115	14.8	579	2.08	FE7	LX9FF110
120/127	19	746	2.65	G7	LX9FF127
208	45	1788	5.95	L7	LX9FF200
220	59.4	2190	7.7	M7	LX9FF220
230	59.4	2190	7.7	P7	LX9FF220
240	73.5	2750	9.68	U7	LX9FF240
380	173	6540	23	Q7	LX9FF380
400	173	6540	23	V7	LX9FF380
415	218	8460	30	N7	LX9FF415
440	218	8460	30	R7	LX9FF415

#### Specifications

Average consumption at 20 °C: inrush: 690...855 VA, sealed: 6.6...8.1 VA.

Heat dissipation: 5.9...7.2 W.

Operating cycles/hour (θ ≤ 55 °C): < 2400.

Operating time at U<sub>c</sub>: closing = 35 ms, opening = 130 ms.

### For contactor LC1 FG185

48	2.2	60	0.23	E7	LX9FG048
110	10.4	411	1.46	F7	LX9FG110
115	10.4	411	1.46	FE7	LX9FG110
120/127	13	520	1.85	G7	LX9FG127
208	33	1339	4.9	L7	LX9FG200
220	42.1	1680	5.84	M7	LX9FG220
230	42.1	1680	5.84	P7	LX9FG220
240	50.6	2060	7.22	U7	LX9FG240
380	128	4730	16.4	Q7	LX9FG380
400	128	4730	16.4	V7	LX9FG380
415	157	5930	20.6	N7	LX9FG415
440	157	5930	20.6	R7	LX9FG415

#### Specifications

Average consumption at 20 °C: inrush: 950...1180 VA, sealed: 8.9...10.9 VA.

Heat dissipation: 8...9.8 W.

Operating cycles/hour (θ ≤ 55 °C): < 2400.

Operating time at U<sub>c</sub>: closing = 35 ms, opening = 130 ms.

## TeSys contactors

Coils for 3-pole shockproof contactors LC1 FG

Spare or replacement parts a.c. supply 40...400 Hz

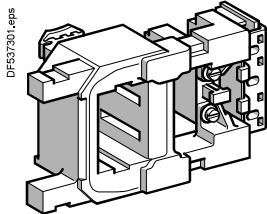

LX1 FH●●●

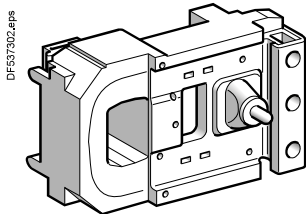

LX1 FJ●●●

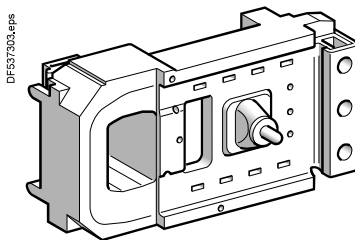

LX1 FK●●●

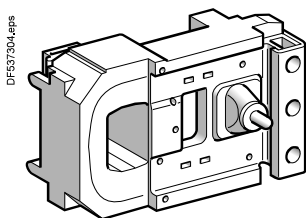

LX1 FL●●●

## References

Control circuit voltage U <sub>c</sub>	Voltage code	Coil reference		Weight
V				kg
<b>Coils for contactors LC1 FG265</b>				
110/120	F7	LX1FH1102	(1)	0.740
208	L7	LX1FH2002		0.740
220/230	M7	LX1FH2202		0.740
240	U7	LX1FH2402		0.740
380/415	Q7	LX1FH3802		0.740

## Specifications

Average consumption at 20 °C:

- inrush: 600 to 700 VA
  - sealed: 8 to 10 VA, cos φ = 0.9.
- Operating cycles/hour (θ = 55 °C): 2400.

## Coils for contactors LC1 FG400

110/120	F7	LX1FJ110	(1)	1.000
208	L7	LX1FJ200		1.000
220/230	M7	LX1FJ220		1.000
230/240	U7	LX1FJ240		1.000
380/400	Q7	LX1FJ380		1.000
415/440	N7	LX1FJ415		1.000

## Specifications

Average consumption at 20 °C:

- inrush: 1000 to 1150 VA
  - sealed: 12 to 18 VA, cos φ = 0.9.
- Operating cycles/hour (θ = 55 °C): 2400.

## Coils for contactors LC1 FG500

110/120	F7	LX1FK110	(1)	1.150
208	L7	LX1FK200		1.150
220/230	M7	LX1FK220		1.150
230/240	U7	LX1FK240		1.150
380/400	Q7	LX1FK380		1.150
415/440	N7	LX1FK415		1.150

## Specifications

Average consumption at 20 °C:

- inrush: 1050 to 1150 VA
  - sealed: 16 to 20 VA, cos φ = 0.9.
- Operating cycles/hour (θ = 55 °C): 2400.

## Coils for contactors LC1 FG630

110/120	F7	LX1FL110	(1)	1.500
208	L7	LX1FL200		1.500
220/230	M7	LX1FL220		1.500
380/400	Q7	LX1FL380		1.500
415/440	N7	LX1FL415		1.500

## Specifications

Average consumption at 20 °C:

- inrush 50 or 60 Hz: 1500 to 1730 VA
  - sealed 50 or 60 Hz: 20 to 25 VA, cos φ = 0.9.
- Operating cycles/hour (θ = 55 °C): 1200.

(1) Device approved by the DCN (French naval shipyard department) and authorised for on-board use.

# References - TeSys CR1 F, TeSys CR1B

## TeSys contactors

### Magnetic latching contactors

#### Accessories

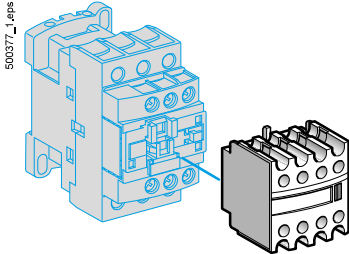

LAD N

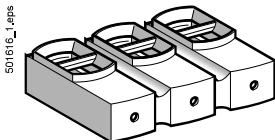

LA9 F103

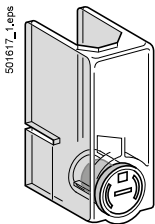

LA9 F70

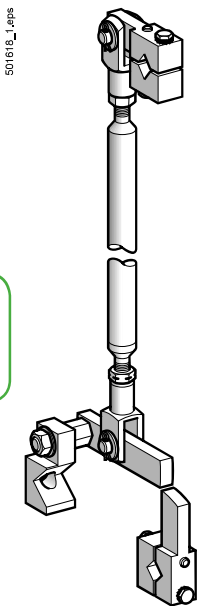

EZ2 LB0601

High power contactors

#### Accessories for contactors CR1 F

Description	Number of contacts or shrouds	For use on	Reference
Instantaneous auxiliary contacts	(1)	CR1 F	LADN●●, LADN●●●, LADX●●, LADY●●, LADZ●● (1)
Time delay auxiliary contacts	(1)	CR1 F	LADT●, LADS●, LADR● (1)
Contact blocks with protected terminals for 3-pole contactors (for mounting on contactors with closed arc chamber)	Set of 2 blocks	CR1 F150 and CR1 F185	LA9F103
Power terminal protection shrouds	Set of 6 shrouds for 3-pole contactors	CR1 F150 and CR1 F185	LA9F702
		CR1 F265 to CR1 F500	LA9F703
		CR1 F630	LA9F704
	Set of 8 shrouds for 4-pole contactors	CR1 F1504 and CR1 F1854	LA9F707
		CR1 F2654 to CR1 F5004	LA9F708
		CR1 F6304	LA9F709

Description	Application	Reference
Mechanical interlock and power connections	For assembly of reversing contactors and changeover contactor pairs	See pages B9/31 and B9/32

#### Accessories for contactors CR1 B

Description	Application	Reference	Weight kg
Mechanical interlock with mounting accessories (2)	For vertical assembly of reversing contactors and changeover contactor pairs	EZ2LB0601	1.560
Kit containing 2 bar mounting brackets	For mounting on 120 or 150 mm centres	LA9B103	1.620

(1) For maximum number per contactor and complete reference, see page B9/11.

(2) Positive mechanical interlocking between 2 vertically mounted contactors of identical or different ratings. Connecting rods and cranks assembled on right-hand sides, crank pins on the pole side.

Vertical fixing centre distance between the two contactors: 600 mm.

# Mounting - TeSys CR1 F

## TeSys contactors

Magnetic latching contactors

Components for assembling reversing contactors and changeover contactor pairs CR1 F

Horizontally or vertically mounted

### Horizontally mounted

Reversers assembled using 2 contactors of identical rating, type:  
**CR1 F150**  
**CR1 F185**  
**CR1 F265**  
**CR1 F400**  
**CR1 F500**  
**CR1 F630**

#### Mechanical interlocks

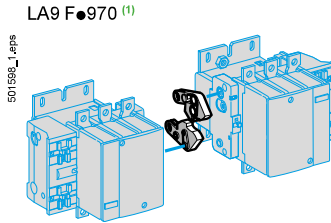

#### Sets of power connections

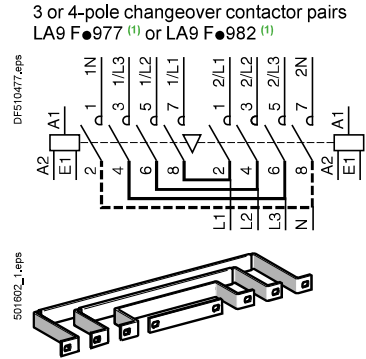
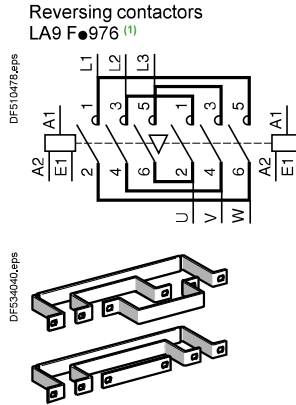

### Vertically mounted

Reversers assembled using 2 contactors of identical rating, type:  
**CR1 F150**  
**CR1 F185**  
**CR1 F265**  
**CR1 F400**  
**CR1 F500**  
**CR1 F630**

#### Mechanical interlocks

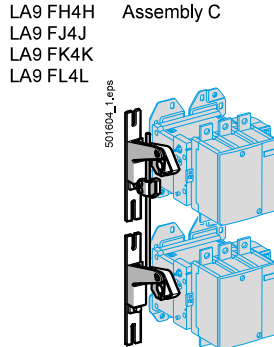
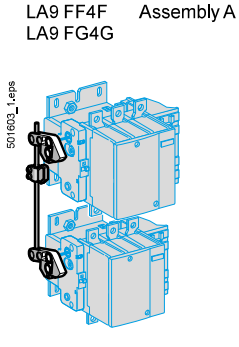

Reversers assembled using 2 contactors of different ratings, type:  
**CR1 F150**  
**CR1 F185**  
**CR1 F265**  
**CR1 F400**  
**CR1 F500**  
**CR1 F630**

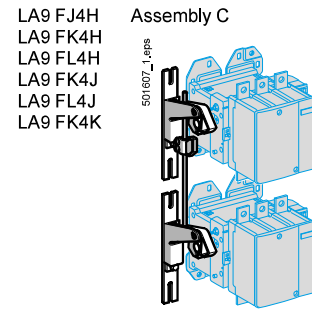
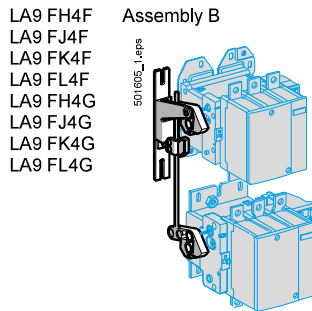
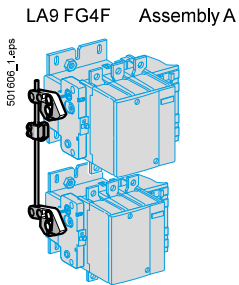

Reversers assembled using 3 contactors of identical or different ratings

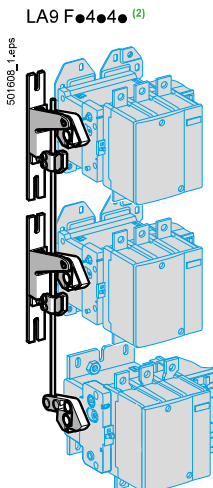

DF50955Z\_1.eps

A	CR1 F500							
B	CR1 F265	F150	F185	F265	F400	F500	F630	
C	CR1 F185							

**Warning:** the contactor ratings must be in decreasing size from top to bottom.

High power contactors

<sup>(1)</sup> Complete references: see page B9/37.  
<sup>(2)</sup> Complete references: see pages B9/40 and B9/41.

# TeSys contactors

## Magnetic latching contactors

Components for assembling reversing contactors and changeover contactor pairs CR1 F

### Reversers assembled using 2 contactors of identical rating

Contactor type	Set of power connections			Mechanical interlock	
	3-pole Reference	4-pole Reference	Weight kg	Kit reference	Weight kg

#### For assembly of 3-pole reversing contactors for motor control <sup>(1)</sup>

##### Horizontally mounted

CR1 F150	LA9FF976	–	0.600	LA9FF970	0.060
CR1 F185	LA9FG976	–	0.780	LA9FG970	0.060
CR1 F265	LA9FH976	–	1.500	LA9FJ970	0.140
CR1 F400	LA9FJ976	–	2.100	LA9FJ970	0.140
CR1 F500	LA9FK976	–	2.350	LA9FJ970	0.140
CR1 F630	LA9FL976	–	3.800	LA9FL970	0.150

##### Vertically mounted

CR1 F150	<sup>(2)</sup>	–	–	LA9FF4F	0.345
CR1 F185	<sup>(2)</sup>	–	–	LA9FG4G	0.350
CR1 F265	<sup>(2)</sup>	–	–	LA9FH4H	1.060
CR1 F400	<sup>(2)</sup>	–	–	LA9FJ4J	1.200
CR1 F500	<sup>(2)</sup>	–	–	LA9FK4K	1.200
CR1 F630	<sup>(2)</sup>	–	–	LA9FL4L	1.220

#### For assembly of 4-pole changeover contactor pairs

##### Horizontally mounted

CR1 F1504	LA9FF982	LA9FF977	0.460	LA9FF970	0.060
CR1 F1854	LA9FG982	LA9FG977	0.610	LA9FG970	0.060
CR1 F2654	LA9FH982	LA9FH977	1.200	LA9FJ970	0.140
CR1 F4004	LA9FJ982	LA9FJ977	1.800	LA9FJ970	0.140
CR1 F5004	LA9FK982	LA9FK977	2.300	LA9FJ970	0.140
CR1 F6304	LA9FL982	LA9FL977	3.400	LA9FL970	0.150

##### Vertically mounted

CR1 F1504	<sup>(2)</sup>	–	–	LA9FF4F	0.345
CR1 F1854	<sup>(2)</sup>	–	–	LA9FG4G	0.350
CR1 F2654	<sup>(2)</sup>	–	–	LA9FH4H	1.060
CR1 F4004	<sup>(2)</sup>	–	–	LA9FJ4J	1.200
CR1 F5004	<sup>(2)</sup>	–	–	LA9FK4K	1.200
CR1 F6304	<sup>(2)</sup>	–	–	LA9FL4L	1.220

### Reversers assembled using 2 contactors of different ratings

Contactor type	Set of power connections		Mechanical interlock	
	At bottom	At top	Kit reference	Weight kg

#### For assembly of 3 or 4-pole changeover contactor pairs

##### Vertically mounted <sup>(3)</sup>

CR1 F150 or F1504	CR1 F185 or F1854	LA9FG4F	0.350
	CR1 F265 or F2654	LA9FH4F	0.870
	CR1 F400 or F4004	LA9FJ4F	0.930
	CR1 F500 or F5004	LA9FK4F	0.940
	CR1 F630 or F6304	LA9FL4F	0.940
CR1 F185 or F1854	CR1 F265 or F2654	LA9FH4G	0.860
	CR1 F400 or F4004	LA9FJ4G	0.940
	CR1 F500 or F5004	LA9FK4G	0.940
	CR1 F630 or F6304	LA9FL4G	0.950
CR1 F265 or F2654	CR1 F400 or F4004	LA9FJ4H	1.130
	CR1 F500 or F5004	LA9FK4H	1.130
	CR1 F630 or F6304	LA9FL4H	1.140
CR1 F400 or F4004	CR1 F500 or F5004	LA9FK4J	1.200
	CR1 F630 or F6304	LA9FL4J	1.210
CR1 F500 or F5004	CR1 F630 or F6304	LA9FL4K	1.210

#### For assembly of 3 or 4-pole reversing contactors <sup>(4)</sup>

Contactor type	Set of power connections	Mechanical interlock	
		Kit reference <sup>(5)</sup>	Weight kg
Using 3 contactors (vertically mounted) of identical or different ratings		LA9F●4●4●	

The contactor ratings must be in decreasing size from top to bottom.

Contactors	CR1 F150	CR1 F185	CR1 F265	CR1 F400	CR1 F500	CR1 F630
Code	F	G	H	J	K	L

**Example:** mechanical interlock for reversing contactor made up of 3 different contactors: CR1 F500 top, CR1 F265 middle and CR1 F185 bottom: **LA9 FK4H4G**.

(1) A 3-pole reversing contactor for motor control can be converted into a 3-pole changeover contactor pair by removing the upper connecting links.

(2) All power connections are to be made by the customer.

(3) With identical or different number of poles. Power connections to be made by the customer.

(4) Closing of one of the 3 contactors prevents closing of the other 2 contactors.

(5) Complete the reference by replacing the first dot with the code for the upper contactor, the second dot with the code for the middle contactor and the third dot with the code for the bottom contactor.



## References - TeSys CR1 F

### TeSys contactors

Magnetic latching contactors

Accessories and replacement parts for contactors CR1 F

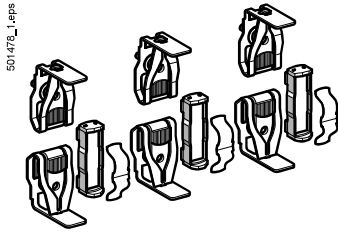

LA5 FG431

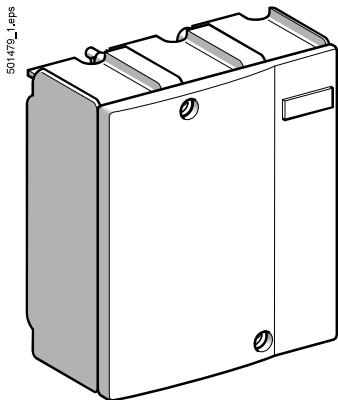

LA5 F40050

#### References

Description	For contactor		Reference	Weight kg
Complete sets of contacts for 3 or 4 poles <sup>(1)</sup>	3-pole	CR1 F150	LA5FF431	0.270
		CR1 F185	LA5FG431	0.350
		CR1 F265	LA5FH431	0.660
		CR1 F400	LA5F400803	0.660
		CR1 F500	LA5F500803	0.660
		CR1 F630	LA5F630803	0.660
	4-pole	CR1 F1504	LA5FF441	0.360
		CR1 F1854	LA5FG441	0.465
		CR1 F2654	LA5FH441	0.880
		CR1 F4004	LA5F400804	0.465
		CR1 F5004	LA5F500804	0.465
		CR1 F6304	LA5F630804	0.465
Arc chambers	3-pole	CR1 F150	LA5F15050	0.490
		CR1 F185	LA5F18550	0.670
		CR1 F265	LA5F26550	0.920
		CR1 F400	LA5F40050	1.300
		CR1 F500	LA5F50050	1.850
		CR1 F630	LA5F63050	3.150
	4-pole	CR1 F1504	LA5F150450	0.660
		CR1 F1854	LA5F185450	0.910
		CR1 F2654	LA5F265450	1.220
		CR1 F4004	LA5F400450	1.740
		CR1 F5004	LA5F500450	2.500
		CR1 F6304	LA5F630450	4.200

<sup>(1)</sup> Set containing the following (per pole): 2 fixed contacts, 1 moving contact, 2 deflectors, 1 back-plate, clamping screws and washers.

High power contactors

# TeSys contactors

TeSys CR1 F magnetic latching contactors

a.c. or d.c. supply coils

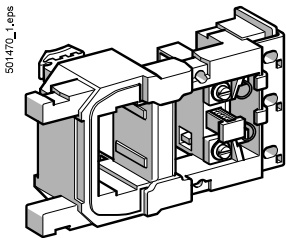

LX0 FF009

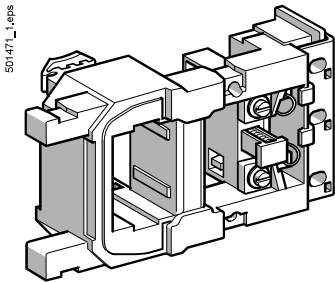

LX0 FH009

High power contactors

Standard coils						
Usual voltages		Resistance of winding at $\theta = 20\text{ }^{\circ}\text{C}$		Reference	Voltage code	Weight code
50...400 Hz or ---	50 Hz, 60 Hz	Latching	Unlatching			
V	V	$\Omega$	$\Omega$			kg
<b>For contactors CR1 F150</b>						
48	–	1.98	230.8	LX0FF005	E7	0.440
110	–	9.35	1453	LX0FF006	F7	0.440
127	–	11.61	1788	LX0FF007	G7	0.440
208	–	23.50	4098	LX0FF020	L7	0.440
220/230	–	37.55	5139	LX0FF008	M7	0.440
–	240	45.16	6544	LX0FF009	U7	0.440
–	380/400	114.10	12 447	LX0FF010	Q7	0.440
–	415	139.50	16 717	LX0FF011	N7	0.440
<b>For contactors CR1 F185</b>						
48	–	1.42	220	LX0FG005	E7	0.560
110	–	6.92	1339	LX0FG006	F7	0.560
127	–	8.45	1676	LX0FG007	G7	0.560
208	–	21.30	3169	LX0FG020	L7	0.560
220/230	–	26.27	4729	LX0FG008	M7	0.560
–	240	32.95	4729	LX0FG009	U7	0.560
–	380/400	82.29	11 885	LX0FG010	Q7	0.560
–	415	102.30	14 305	LX0FG011	N7	0.560
<b>For contactors CR1 F265</b>						
48	–	1.34	183.4	LX0FH005	E7	0.780
110	–	6.90	1031	LX0FH006	F7	0.780
127	–	8.56	1325	LX0FH007	G7	0.780
208	–	20.20	2654	LX0FH020	L7	0.780
220/230	–	25.77	4090	LX0FH008	M7	0.780
–	240	33.03	5002	LX0FH009	U7	0.780
–	380/400	78.39	11 803	LX0FH010	Q7	0.780
–	415	102.9	15 006	LX0FH011	N7	0.780
<b>For contactors CR1 F400</b>						
48	–	1.32	90.5	LX0FJ005	E7	1.120
110	–	8.09	813	LX0FJ006	F7	1.120
127	–	9.79	1027	LX0FJ007	G7	1.120
208	–	24.40	2643	LX0FJ020	L7	1.120
220/230	–	30.14	3309	LX0FJ008	M7	1.120
–	240	37.02	4074	LX0FJ009	U7	1.120
–	380/400	94.80	9380	LX0FJ010	Q7	1.120
–	415	121.10	11 763	LX0FJ011	N7	1.120
<b>For contactors CR1 F500</b>						
48	–	1.57	166	LX0FK005	E7	1.220
110	–	7.53	916	LX0FK006	F7	1.220
127	–	9.56	1159	LX0FK007	G7	1.220
208	–	23.60	2981	LX0FK020	L7	1.220
220/230	–	28.81	3733	LX0FK008	M7	1.220
–	240	35.67	4595	LX0FK009	U7	1.220
–	380/400	89.56	10 570	LX0FK010	Q7	1.220
–	415	112.06	13 256	LX0FK011	N7	1.220
<b>For contactors CR1 F630</b>						
48	–	0.87	204	LX0FL005	E7	1.460
110	–	5.20	1423	LX0FL006	F7	1.460
127	–	6.45	1830	LX0FL007	G7	1.460
208	–	20.20	2961	LX0FL020	L7	1.460
220/230	–	25.36	4603	LX0FL008	M7	1.460
–	240	25.36	5658	LX0FL009	U7	1.460
–	380/400	60.95	10 676	LX0FL010	Q7	1.460
–	415	77.97	13 003	LX0FL011	N7	1.460

## TeSys contactors

TeSys CR1 F magnetic latching contactors

a.c. or d.c. supply coils

501472\_1.ppt

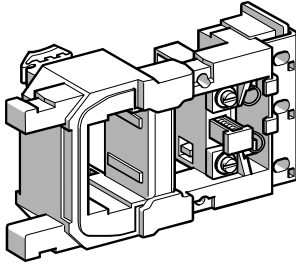

LX0FF030

## Special coils

Coils with two windings with common point, allowing the use of two separate power sources for latching and unlatching.

Coil voltages at 50 Hz, 60 Hz, 400 Hz or ---		Resistance of winding at $\theta = 20\text{ }^{\circ}\text{C}$		Reference	Voltage code	Weight
Latching	Unlatching	Latching	Unlatching			
V	V	$\Omega$	$\Omega$			kg
<b>For contactors CR1 F150</b>						
220	24	29.5	39.5	LX0FF224	MB7	0.440
<b>For contactors CR1 F185</b>						
220	24	26.5	19	LX0FG224	MB7	0.560
<b>For contactors CR1 F265</b>						
220	24	26	29.5	LX0FH224	MB7	0.780
<b>For contactors CR1 F400</b>						
220	24	30	23	LX0FJ224	MB7	1.120
<b>For contactors CR1 F500</b>						
220	24	29	26	LX0FK224	MB7	1.220
<b>For contactors CR1 F630</b>						
220	24	26	41	LX0FL224	MB7	1.460

## Coils with low inrush consumption

Usual voltages ---	Resistance of winding at $\theta = 20\text{ }^{\circ}\text{C}$		Reference	Voltage code	Weight
	Latching	Unlatching			
V	$\Omega$	$\Omega$			kg
<b>For contactors CR1 F150</b>					
48	4.56	140.56	LX0FF055	EZ7	0.440
110	22.37	706.44	LX0FF056	FZ7	0.440
127	35.54	1086.36	LX0FF057	GZ7	0.440
220	89.85	3342.51	LX0FF058	MZ7	0.440
<b>For contactors CR1 F185</b>					
48	5.19	106.54	LX0FG055	EZ7	0.570
110	25.50	536.26	LX0FG056	FZ7	0.570
127	32.75	732.64	LX0FG057	GZ7	0.570
220	102.44	2378.62	LX0FG058	MZ7	0.570
<b>For contactors CR1 F265</b>					
48	5.19	74.26	LX0FH055	EZ7	0.800
110	25	364.61	LX0FH056	FZ7	0.800
127	30.98	458.45	LX0FH057	GZ7	0.800
220	97.89	1344.46	LX0FH058	MZ7	0.800
<b>For contactors CR1 F400</b>					
48	5.05	36.36	LX0FJ055	EZ7	1.150
110	25.39	171.49	LX0FJ056	FZ7	1.150
127	31.86	221.20	LX0FJ057	GZ7	1.150
220	98.19	648.79	LX0FJ058	MZ7	1.150
<b>For contactors CR1 F500</b>					
48	4.42	41	LX0FK055	EZ7	1.270
110	22.74	193.36	LX0FK056	FZ7	1.270
127	28.25	313.60	LX0FK057	GZ7	1.270
220	85.12	918.68	LX0FK058	MZ7	1.270
<b>For contactors CR1 F630</b>					
48	3.94	59.17	LX0FL055	EZ7	1.500
110	19.36	365.33	LX0FL056	FZ7	1.500
127	25.39	452.27	LX0FL057	GZ7	1.500
220	74.44	1071.43	LX0FL058	MZ7	1.500

High power contactors

## TeSys contactors

TeSys F reversing contactors and changeover contactor pairs

Components for assembling 3-pole reversing contactors and changeover contactor pairs, for customer assembly

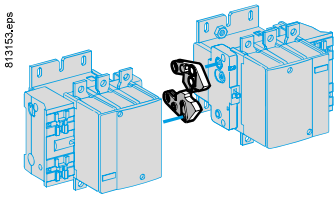
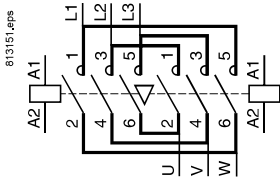
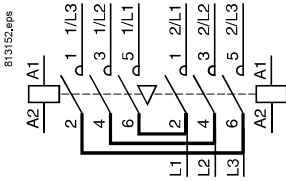
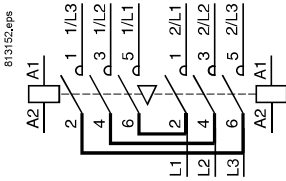
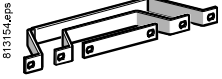
Horizontally mounted	Mechanical interlocks	Sets of power connections	
<p>Reversers assembled using 2 contactors of identical rating, type :</p> <ul style="list-style-type: none"> <li>LC1 F115</li> <li>LC1 F150</li> <li>LC1 F185</li> <li>LC1 F225</li> <li>LC1 F265</li> <li>LC1 F330</li> <li>LC1 F400</li> <li>LC1 F500</li> <li>LC1 F630</li> <li>LC1 F800</li> </ul>	<p><b>LA9 F●●970</b> <sup>(2)</sup></p> 	<p><b>Reversing contactors</b></p> <p><b>LA9 F●●●76</b> <sup>(2)</sup></p>  	<p><b>3-pole changeover contactor pairs</b> <sup>(1)</sup></p> <p><b>LA9 F●●●82</b> <sup>(2)</sup></p>  

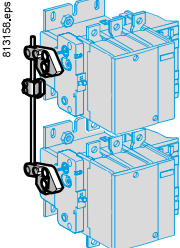
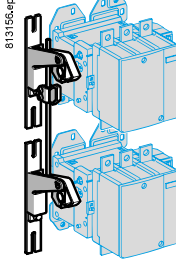
Vertically mounted	Mechanical interlocks	
<p>Reversers assembled using 2 contactors of identical rating, type :</p> <ul style="list-style-type: none"> <li>LC1 F115</li> <li>LC1 F150</li> <li>LC1 F185</li> <li>LC1 F225</li> <li>LC1 F265</li> <li>LC1 F330</li> <li>LC1 F400</li> <li>LC1 F500</li> <li>LC1 F630</li> <li>LC1 F800</li> </ul> <p>Reversers assembled using 2 contactors of different ratings, see page B9/38</p>	<p><b>LA9 FF4F</b> <b>LA9 FG4G</b></p> 	<p><b>LA9 FH4H</b> <b>LA9 FJ4J</b> <b>LA9 FK4K</b> <b>LA9 FL4L</b></p> 

**LC1 F780**

**LA9 FX970**

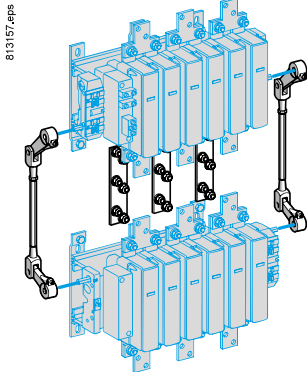

High power contactors

(1) For 4-pole changeover contactor pairs, see pages B9/38 and B9/39.  
 (2) Complete references: see page B9/37.

## TeSys contactors

TeSys F reversing contactors and changeover contactor pairs

Control circuit: a.c. or d.c. supply

Reversers assembled using 2 contactors of identical rating				
Contactor type <sup>(1)</sup>	Set of power connections		Mechanical interlock	
	Reference	Weight kg	Kit reference	Weight kg
<b>For assembly of 3-pole reversing contactors for motor control</b>				
<b>Horizontally mounted</b>				
LC1 F115	LA9FF976	0.600	LA9FF970	0.060
LC1 F150	LA9F15076	0.600	LA9FF970	0.060
LC1 F185	LA9FG976	0.780	LA9FG970	0.060
LC1 F225	LA9F22576	1.500	LA9FG970	0.060
LC1 F265	LA9FH976	1.500	LA9FJ970	0.140
LC1 F330	LA9FJ976	2.100	LA9FJ970	0.140
LC1 F400	LA9FJ976	2.100	LA9FJ970	0.140
LC1 F500	LA9FK976	2.350	LA9FJ970	0.140
LC1 F630 or F800	LA9FL976	3.800	LA9FL970	0.150
<b>Vertically mounted</b>				
LC1 F115 or F150	<sup>(2)</sup>	–	LA9FF4F	0.345
LC1 F185	<sup>(2)</sup>	–	LA9FG4G	0.350
LC1 F225	<sup>(2)</sup>	–	LA9FG4G	0.350
LC1 F265 or F330	<sup>(2)</sup>	–	LA9FH4H	1.060
LC1 F400	<sup>(2)</sup>	–	LA9FJ4J	1.200
LC1 F500	<sup>(2)</sup>	–	LA9FK4K	1.200
LC1 F630 or F800	<sup>(2)</sup>	–	LA9FL4L	1.220
LC1 F780	<sup>(3)</sup>	–	LA9FX970 <sup>(3)</sup>	6.100
<b>For assembly of 3-pole changeover contactor pairs <sup>(4)</sup></b>				
<b>Horizontally mounted</b>				
LC1 F115	LA9FF982	0.460	LA9FF970	0.060
LC1 F150	LA9F15082	0.460	LA9FF970	0.060
LC1 F185	LA9FG982	0.610	LA9FG970	0.060
LC1 F225	LA9F22582	1.200	LA9FG970	0.060
LC1 F265	LA9FH982	1.200	LA9FJ970	0.140
LC1 F330	LA9FJ982	1.800	LA9FJ970	0.140
LC1 F400	LA9FJ982	1.800	LA9FJ970	0.140
LC1 F500	LA9FK982	2.300	LA9FJ970	0.140
LC1 F630 or F800	LA9FL982	3.400	LA9FL970	0.150
<b>Vertically mounted</b>				
LC1 F115 or F150	<sup>(2)</sup>	–	LA9FF4F	0.345
LC1 F185	<sup>(2)</sup>	–	LA9FG4G	0.350
LC1 F225	<sup>(2)</sup>	–	LA9FG4G	0.350
LC1 F265 or F330	<sup>(2)</sup>	–	LA9FH4H	1.060
LC1 F400	<sup>(2)</sup>	–	LA9FJ4J	1.200
LC1 F500	<sup>(2)</sup>	–	LA9FK4K	1.200
LC1 F630 or F800	<sup>(2)</sup>	–	LA9FL4L	1.220
LC1 F780	<sup>(3)</sup>	–	LA9FX970 <sup>(3)</sup>	7.800

<sup>(1)</sup> To order the 2 contactors: see pages B9/2 and B9/3. For the 2 auxiliary contact blocks **LAD N•1** required to obtain electrical interlocking between the 2 contactors, see page B9/11. For accessories, see pages B9/12 to B9/14.

<sup>(2)</sup> All power connections are to be made by the customer.

<sup>(3)</sup> Double mechanical interlock mechanism with 2 interlock connecting rods and 3 power connecting links.

<sup>(4)</sup> For assembly of 4-pole changeover contactor pairs, see pages B9/38 and B9/39.

## TeSys contactors

### TeSys F changeover contactor pairs

Components for assembling 3 and 4-pole changeover contactor pairs, for customer assembly

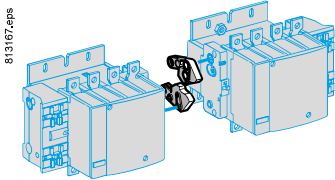
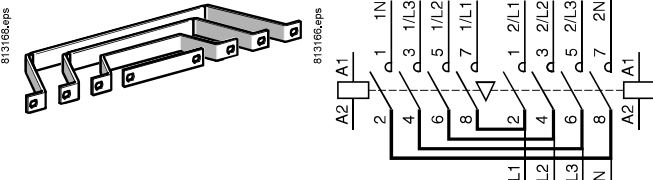
Horizontally mounted	Mechanical interlocks	Sets of power connections
<p>Contactor pairs assembled using 2 contactors of identical rating, type :</p> <ul style="list-style-type: none"> <li>LC1 F1154</li> <li>LC1 F1504</li> <li>LC1 F1854</li> <li>LC1 F2254</li> <li>LC1 F2654</li> <li>LC1 F3304</li> <li>LC1 F4004</li> <li>LC1 F5004</li> <li>LC1 F6304</li> </ul>	<p><b>LA9 F●970</b> <sup>(2)</sup></p> 	<p><b>4-pole changeover contactor pairs</b> <sup>(1)</sup></p> <p><b>LA9 F●●77</b> <sup>(2)</sup></p> 

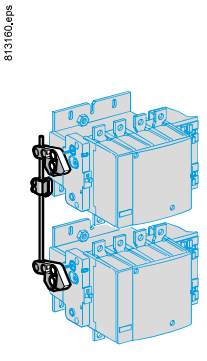
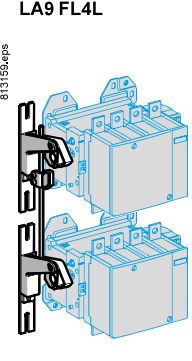
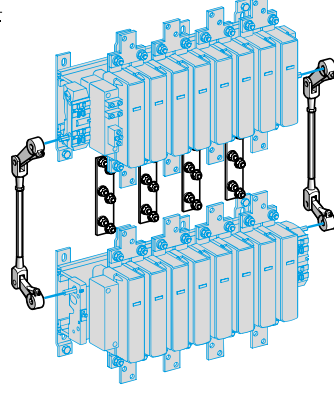
Vertically mounted	Mechanical interlocks	Assembly B	Assembly C
<p>Contactor pairs assembled using 2 contactors of identical rating, type :</p> <ul style="list-style-type: none"> <li>LC1 F1154</li> <li>LC1 F1504</li> <li>LC1 F1854</li> <li>LC1 F2254</li> <li>LC1 F2654</li> <li>LC1 F3304</li> <li>LC1 F4004</li> <li>LC1 F5004</li> <li>LC1 F6304</li> </ul>	<p><b>Assembly A</b></p> <p><b>LA9 FF4F</b></p> <p><b>LA9 FG4G</b></p> 	<p><b>Assembly B</b></p> <ul style="list-style-type: none"> <li>LA9 FH4H</li> <li>LA9 FJ4J</li> <li>LA9 FK4K</li> <li>LA9 FL4L</li> </ul> 	<p><b>Assembly C</b></p> <p><b>LA9 FX971</b></p> 

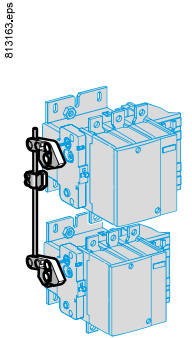
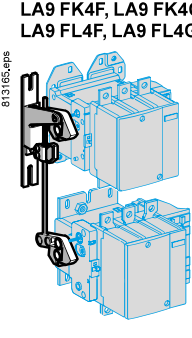
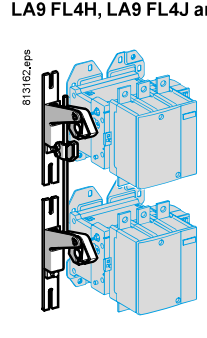
<p>Contactor pairs assembled using 2 contactors of different ratings, type :</p> <ul style="list-style-type: none"> <li>LC1 F115 or F1154</li> <li>LC1 F150 or F1504</li> <li>LC1 F185 or F1854</li> <li>LC1 F225 or F2254</li> <li>LC1 F265 or F2654</li> <li>LC1 F330 or F3304</li> <li>LC1 F400 or F4004</li> <li>LC1 F500 or F5004</li> <li>LC1 F630 or F6304</li> <li>LC1 F800</li> </ul>	<p><b>Assembly A</b></p> <p><b>LA9 FG4F</b></p> 	<p><b>Assembly B</b></p> <ul style="list-style-type: none"> <li>LA9 FH4F, LA9 FH4G</li> <li>LA9 FJ4F, LA9 FJ4G</li> <li>LA9 FK4F, LA9 FK4G</li> <li>LA9 FL4F, LA9 FL4G</li> </ul> 	<p><b>Assembly C</b></p> <ul style="list-style-type: none"> <li>LA9 FJ4H</li> <li>LA9 FK4H, LA9 FK4J</li> <li>LA9 FL4H, LA9 FL4J and LA9 FL4K</li> </ul> 
--	---	---	--

Contactor pairs assembled using 3 contactors of identical or different ratings, type :

- LC1 F115 or F1154
- LC1 F150 or F1504
- LC1 F185 or F1854
- LC1 F225 or F2254
- LC1 F265 or F2654
- LC1 F330 or F3304
- LC1 F400 or F4004
- LC1 F500 or F5004
- LC1 F630 or F6304
- LC1 F800

**LA9 F●4●4●** : see pages B9/40 and B9/41.

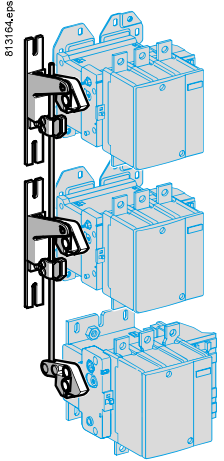

High power contactors

**Important:** the contactor ratings must be in decreasing size from top to bottom.

(1) For 3-pole changeover contactor pairs, see pages B9/36 and B9/37.  
 (2) Complete references: see page B9/39.

## TeSys contactors

TeSys F changeover contactor pairs

Components for assembling 3 and 4-pole changeover contactor pairs, for customer assembly

### Contactor pairs assembled using 2 contactors of identical rating

For assembly of 4-pole changeover contactor pairs <sup>(1)</sup>				
Contactor type <sup>(2)</sup>	Set of power connections		Mechanical interlock	
	Reference	Weight kg	Kit reference	Weight kg
<b>Horizontally mounted</b>				
LC1 F1154	LA9FF977	0.460	LA9FF970	0.060
LC1 F1504	LA9F15077	0.460	LA9FF970	0.060
LC1 F1854	LA9FG977	0.610	LA9FG970	0.060
LC1 F2254	LA9F22577	1.200	LA9FG970	0.060
LC1 F2654	LA9FH977	1.200	LA9FJ970	0.140
LC1 F3304	LA9FJ977	1.800	LA9FJ970	0.140
LC1 F4004	LA9FJ977	1.800	LA9FJ970	0.140
LC1 F5004	LA9FK977	2.300	LA9FJ970	0.140
LC1 F6304	LA9FL977	3.400	LA9FL970	0.150
<b>Vertically mounted</b>				
LC1 F1154 or F1504	<sup>(3)</sup>	–	LA9FF4F	0.345
LC1 F1854	<sup>(3)</sup>	–	LA9FG4G	0.350
LC1 F2254	<sup>(3)</sup>	–	LA9FG4G	0.350
LC1 F2654 or F3304	<sup>(3)</sup>	–	LA9FH4H	1.060
LC1 F4004	<sup>(3)</sup>	–	LA9FJ4J	1.200
LC1 F5004	<sup>(3)</sup>	–	LA9FK4K	1.200
LC1 F6304	<sup>(3)</sup>	–	LA9FL4L	1.220
LC1 F7804	<sup>(4)</sup>	–	LA9FX971 <sup>(4)</sup>	7.800

### Contactor pairs assembled using 2 contactors of different ratings

For assembly of 3 or 4-pole changeover contactor pairs			
Contactor type <sup>(1)</sup>			Mechanical interlock
	At bottom	At top	Kit reference      Weight kg
<b>Vertically mounted</b>			
LC1 F115 or F1154 or LC1 F150 or F1504	LC1 F185 or F1854		LA9FG4F      0.350
	LC1 F225 or F2254		LA9FG4F      0.350
	LC1 F265 or F2654		LA9FH4F      0.870
	LC1 F330 or F3304		LA9FH4F      0.870
	LC1 F400 or F4004		LA9FJ4F      0.930
	LC1 F500 or F5004		LA9FK4F      0.940
LC1 F185 or F1854 or LC1 F225 or F2254	LC1 F630, F6304 or F800		LA9FL4F      0.940
	LC1 F265 or F2654		LA9FH4G      0.860
	LC1 F330 or F3304		LA9FH4G      0.860
	LC1 F400 or F4004		LA9FJ4G      0.940
	LC1 F500 or F5004		LA9FK4G      0.940
	LC1 F630, F6304 or F800		LA9FL4G      0.950
LC1 F265 or F2654 or LC1 F330 or F3304	LC1 F400 or F4004		LA9FJ4H      1.130
	LC1 F500 or F5004		LA9FK4H      1.130
	LC1 F630, F6304 or F800		LA9FL4H      1.140
LC1 F400 or F4004	LC1 F500 or F5004		LA9FK4J      1.200
	LC1 F630 or F6304 or F800		LA9FL4J      1.210
LC1 F500 or F5004	LC1 F630 or F6304 or F800		LA9FL4K      1.210

#### For assembly of reversers using 3 contactors, vertically mounted

See pages B9/40 and B9/41.

<sup>(1)</sup> For assembly of 3-pole changeover contactor pairs, see pages B9/36 and B9/37.

<sup>(2)</sup> To order the 2 contactors: see pages B9/2 and B9/3. For the 2 auxiliary contact blocks **LAD N 1** required to obtain electrical interlocking between the 2 contactors, see page B9/11. For accessories, see pages B9/12 to B9/14.

<sup>(3)</sup> All power connections are to be made by the customer.

<sup>(4)</sup> Double mechanical interlock mechanism with 2 interlock connecting rods and 4 power connecting links.

# TeSys contactors

## TeSys F contactors

Accessories for assembly of reversing contactors and changeover contactor pairs using 3 contactors, vertically mounted - for customer assembly

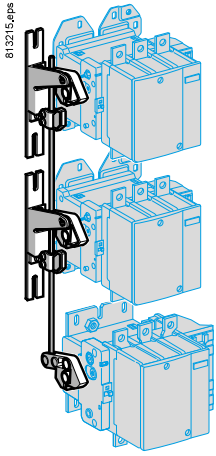

LA9 F●4●4●

Closing of one of the 3 contactors prevents closing of the other 2.

Mechanical interlock kits				
Contactor type <sup>(1)</sup>			Mechanical interlock <sup>(2)</sup>	
Top	Middle	Bottom	Kit reference <sup>(3)</sup>	Weight kg
LC1 F115, F150, F1154 or F1504	LC1 F115, F150, F1154 or F1504	LC1 F115, F150, F1154 or F1504	LA9FF4F4F	0.554
LC1 F185, F225, F1854 or F2254	LC1 F115, F150, F1154 or F1504	LC1 F115, F150, F1154 or F1504	LA9FG4F4F	0.559
		LC1 F185, F225, F1854 or F2254	LA9FG4G4F	0.559
LC1 F265, F330, F2654 or F3304	LC1 F115, F150, F1154 or F1504	LC1 F115, F150, F1154 or F1504	LA9FG4G4G	0.562
		LC1 F185, F225, F1854 or F2254	LA9FG4G4G	0.562
LC1 F265, F330, F2654 or F3304	LC1 F115, F150, F1154 or F1504	LC1 F115, F150, F1154 or F1504	LA9FH4F4F	1.350
		LC1 F185, F225, F1854 or F2254	LA9FH4G4F	1.375
		LC1 F185, F225, F1854 or F2254	LA9FH4G4G	1.375
		LC1 F265, F330, F2654 or F3304	LA9FH4H4F	1.524
LC1 F400, F4002 or F4004	LC1 F115, F150, F1154 or F1504	LC1 F115, F150, F1154 or F1504	LA9FH4H4G	1.527
		LC1 F185, F225, F1854 or F2254	LA9FH4H4H	1.684
		LC1 F265, F330, F2654 or F3304	LA9FJ4F4F	1.421
		LC1 F115, F150, F1154 or F1504	LA9FJ4G4F	1.424
LC1 F500, F5002 or F5004 (continued on page B9/41)	LC1 F185, F225, F1854 or F2254	LC1 F115, F150, F1154 or F1504	LA9FJ4G4G	1.428
		LC1 F185, F225, F1854 or F2254	LA9FJ4H4F	1.595
		LC1 F185, F225, F1854 or F2254	LA9FJ4H4G	1.598
		LC1 F265, F330, F2654 or F3304	LA9FJ4H4H	1.755
LC1 F400, F4002 or F4004	LC1 F265, F330, F2654 or F3304	LC1 F115, F150, F1154 or F1504	LA9FJ4J4F	1.666
		LC1 F115, F150, F1154 or F1504	LA9FJ4J4G	1.669
		LC1 F185, F225, F1854 or F2254	LA9FJ4J4H	1.829
		LC1 F265, F330, F2654 or F3304	LA9FJ4J4J	1.890
LC1 F400, F4002 or F4004	LC1 F400, F4002 or F4004	LC1 F115, F150, F1154 or F1504	LA9FK4F4F	1.421
		LC1 F115, F150, F1154 or F1504	LA9FK4G4F	1.424
		LC1 F115, F150, F1154 or F1504	LA9FK4G4G	1.428
		LC1 F185, F225, F1854 or F2254	LA9FK4H4F	1.595
LC1 F500, F5002 or F5004 (continued on page B9/41)	LC1 F185, F225, F1854 or F2254	LC1 F115, F150, F1154 or F1504	LA9FK4H4G	1.598
		LC1 F185, F225, F1854 or F2254	LA9FK4H4H	1.755
		LC1 F265, F330, F2654 or F3304	LA9FK4J4F	1.666
		LC1 F115, F150, F1154 or F1504	LA9FK4J4G	1.669
LC1 F400, F4002 or F4004	LC1 F265, F330, F2654 or F3304	LC1 F115, F150, F1154 or F1504	LA9FK4J4H	1.829
		LC1 F185, F225, F1854 or F2254	LA9FK4J4J	1.896
		LC1 F400, F4002 or F4004	LA9FK4K4F	1.666
		LC1 F500, F5002 or F5004	LA9FK4K4F	1.666

(1) To order the 3 contactors, see pages B9/2 and B9/3. For auxiliary contact blocks LAD N02 used for electrical locking, see page B9/11. For accessories, see pages B9/12 to B9/14.

(2) Minimum distances between contactors, see page B9/41.

(3) The kit contains the lever arms, the 2 x Ø8 mm rods and all parts required for assembly.



## TeSys contactors

## TeSys F contactors

Accessories for assembly of reversing contactors and changeover contactor pairs using 3 contactors, vertically mounted - for customer assembly

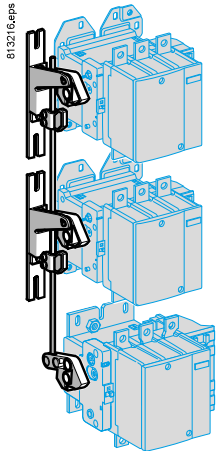

LA9 F●4●4●

## Mechanical interlock kits (continued)

Contactor type <sup>(1)</sup>			Mechanical interlock <sup>(2)</sup>		
Top	Middle	Bottom	Kit reference <sup>(3)</sup>	Weight kg	
LC1 F500, F5002 or F5004 <i>(continued)</i>	LC1 F500, F5002 or F5004	LC1 F185, F225, F1854 or F2254	LA9FK4K4G	1.669	
		LC1 F265, F330, F2654 or F3304	LA9FK4K4H	1.825	
		LC1 F400, F4002 or F4004	LA9FK4K4J	1.896	
		LC1-F500, F5002 or F5004	LA9FK4K4K	1.896	
LC1 F630, F800, F6302 or F6304	LC1 F115, F150, F1154 or F1504	LC1 F115, F150, F1154 or F1504	LA9FL4F4F	1.428	
		LC1 F185, F225, F1854 or F2254	LA9FL4G4F	1.431	
		LC1 F185, F225, F1854 or F2254	LA9FL4G4G	1.436	
	LC1 F265, F330, F2654 or F3304	LC1 F115, F150, F1154 or F1504	LA9FL4H4F	1.602	
		LC1 F185, F225, F1854 or F2254	LA9FL4H4G	1.606	
		LC1 F265, F330, F2654 or F3304	LA9FL4H4H	1.751	
	LC1 F400, F4002 or F4004	LC1 F115, F150, F1154 or F1504	LC1 F115, F150, F1154 or F1504	LA9FL4J4F	1.673
			LC1 F185, F225, F1854 or F2254	LA9FL4J4G	1.676
			LC1 F265, F330, F2654 or F3304	LA9FL4J4H	1.832
			LC1 F400, F4002 or F4004	LA9FL4J4J	1.903
	LC1-F500, F5002 or F5004	LC1 F115, F150, F1154 or F1504	LC1 F115, F150, F1154 or F1504	LA9FK4K4F	1.666
			LC1 F185, F225, F1854 or F2254	LA9FK4K4G	1.669
LC1 F265, F330, F2654 or F3304			LA9FK4K4H	1.825	
LC1 F400, F4002 or F4004			LA9FK4K4J	1.896	
LC1-F500, F5002 or F5004			LA9FK4K4K	1.896	
LC1 F630, F800, F6302 or F6304	LC1 F115, F150, F1154 or F1504	LC1 F115, F150, F1154 or F1504	LA9FL4L4F	1.680	
		LC1 F185, F225, F1854 or F2254	LA9FL4L4G	1.683	
		LC1 F265, F330, F2654 or F3304	LA9FL4L4H	1.910	
		LC1 F400, F4002 or F4004	LA9FL4L4J	1.896	
		LC1 F500, F5002 or F5004	LA9FL4L4K	1.896	
		LC1 F630, F800, F6302, or F6304	LA9FL4L4L	1.920	

<sup>(1)</sup> To order the 3 contactors, see pages B9/2 and B9/3. For auxiliary contact blocks LAD N02 used for electrical locking, see page B9/11. For accessories, see pages B9/12 to B9/14.

<sup>(2)</sup> Minimum distances between contactors.

This is the distance, in mm, between the centres of two adjacent contactors (between the top and middle contactors or between the middle and bottom contactors).

Contactor Bottom or top	Middle					
	LC1 F115 or F150	LC1 F185 or F225	LC1 F265 or F330	LC1 F400	LC1 F500	LC1 F630 or F800
LC1 F115 or F150	200	210	240	250	270	320
LC1 F185 or F225	210	220	250	250	270	330
LC1 F265 or F330	240	250	250	260	280	350
LC1 F400	250	250	260	260	280	320
LC1 F500	270	270	280	280	300	340
LC1 F630 or F800	320	330	350	320	340	380

<sup>(3)</sup> The kit contains the lever arms, the 2 x Ø8 mm rods and all parts required for assembly.

# TeSys contactors

High power changeover contactor pairs for distribution

Control circuit: a.c. or d.c. supply

## General

A changeover contactor pair ensures continuity of operation of an installation and energy management.

It switches between:

- a power supply source M (main) which normally supplies the installation
- and a power supply source S (standby) which may be an incoming line from an additional network or a generating set.

The supply sources may be 3-phase or 3-phase + neutral.

## Supply - 3-phase

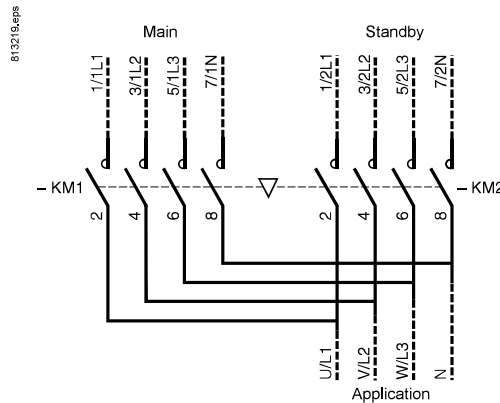
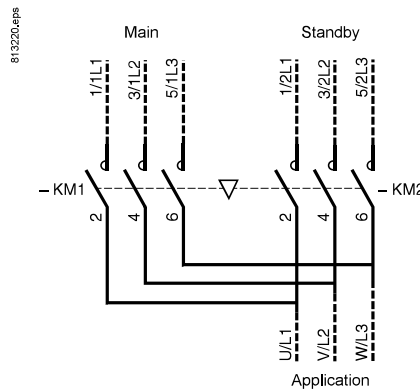

The 2 contactors must be mechanically and electrically interlocked to prevent any paralleling, even transitory, of the two supplies.

## TeSys contactors

High power changeover contactor pairs for distribution

Control circuit: a.c. or d.c. supply

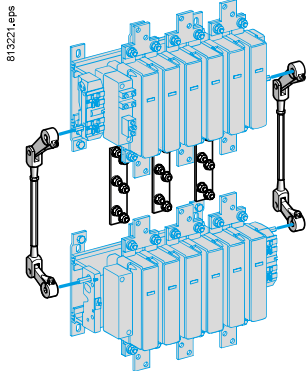

LA9 FX970

### Changeover contactor pairs for customer assembly: 3-phase

Vertically mounted.

Maximum operational voltage: 1000 V.

Utilisation category: AC-1.

Maximum temperature in the vicinity of the devices: 40 °C.

Maximum operational current AC-1		Contactors <sup>(1)</sup>		Mechanical interlock <sup>(2)</sup>
Main	Standby	Main	Standby	Reference
3-phase	3-phase	Reference	Reference	Reference
1600 A	1000 A	LC1F780	LC1F6309	LA9FX970
1600 A	1600 A	LC1F780	LC1F780	LA9FX970

### Changeover contactor pairs for customer assembly: 3-phase + neutral

Vertically mounted.

Maximum operational voltage: 1000 V.

Utilisation category: AC-1.

Maximum temperature in the vicinity of the devices: 40 °C.

Maximum operational current AC-1		Contactors <sup>(1)</sup>		Mechanical interlock <sup>(2)</sup>
Main	Standby	Main	Standby	Reference
3-phase + N	3-phase + N	Reference	Reference	Reference
1600 A + 1000 A	1000 A + 1000 A	LC1F78041	LC1F63049	LA9FX970 <sup>(3)</sup>
1600 A + 1000 A	1600 A + 1000 A	LC1F78041	LC1F78040	LA9FX970 <sup>(3)</sup>
1600 A + 1600 A	1000 A + 1000 A	LC1F7804	LC1F63049	LA9FX971
1600 A + 1600 A	1600 A + 1600 A	LC1F7804	LC1F7804	LA9FX971

<sup>(1)</sup> Coils to be ordered separately, see pages B9/17 to B9/26.

<sup>(2)</sup> Double mechanical interlock mechanism with 2 interlock connecting rods and 4 power connecting links. To order the the 2 auxiliary contact blocks **LAD N●1** required to obtain electrical interlocking between the 2 contactors: see page B9/11.

<sup>(3)</sup> Neutral connecting link not supplied (to be ordered separately).

High power  
contactors

# TeSys F

# Technical Data for Designers

## Contents

### TeSys F contactors:

- > characteristics ..... B9/46 to B9/55
- > dimensions ..... B9/56 to B9/62
- > schemes ..... B9/63 and B9/64

### TeSys V vacuum contactors:

- > selection  
and characteristics .... B9/66 and B9/67
- > dimensions ..... B9/68 and B9/69
- > schemes ..... B9/68 to B9/71

### TeSys FG shockproof contactors:

- > presentation  
and selection ..... B9/72 to B9/79
- > characteristics ..... B9/80 to B9/87
- > dimensions  
and schemes ..... B9/88 and B9/89

### TeSys CR1F magnetic latching contactors:

- > selection ..... B9/88 to B9/95
- > characteristics ..... B9/96 to B9/99
- > dimensions ..... B9/100 to B9/103

### TeSys F - reversing contactors:

- > dimensions ..... B9/104 to B9/106
- > schemes ..... B9/107

### TeSys F - high power changeover contactor pairs for distribution:

- > dimensions ..... B9/108 and B9/109
- > schemes ..... B9/109

High power  
contactors

# Characteristics - TeSys F

## TeSys contactors

### TeSys F contactors

Utilisation category AC-3 (115 to 1000 A), AC-1 (200 to 2600 A)

Control circuit: a.c. or d.c. supply

Environment					
Contactor type			LC1 F115	LC1 F150	LC1 F185
Rated insulation voltage (Ui)	Conforming to IEC 60947-4-1. Overvoltage category III, degree of pollution: 3	V	1000	1000	1000
Rated impulse withstand voltage (Uimp)	Coil not connected to the power circuit	kV	8	8	8
Conforming to standards			IEC/EN 60947-4-1, UL 60947-4-1, CSA C22.2 n° 60947-4-1, JIS C 8201-4-1		
Product certifications			UL, CSA, CCC, CB certification, EAC, ABS, BV, DNV-GL, LRoS, RINA, RMRoS		
Degree of protection	Conforming to IEC 60529		IP 2X front face with shrouds LA9 F		
Climatic withstand			According to IACS E10		
Ambient air temperature around the device	Storage	°C	-60...+80		
	Operation	°C	-5...+55		
	Permissible at Uc <sup>(1)</sup>	°C	-40...+70		
Maximum operating altitude	Without derating	m	3000		
Operating positions			Without derating		
With derating			<p>(not to be used for LC1 F780, F1000, F1400, F1700, F2100 and F2600) Apply the following derating coefficients: 0.75 on the pull-in voltage, 0.9 on the drop-out voltage and 0.8 on the operational current in AC-1.</p> <p>Apply the following derating coefficients: 1.15 on the pull-in voltage, 1.1 on the drop-out voltage and 0.8 on the operational current in AC-1.</p>		
Not to be used			<p>In either case, neither the making and breaking capacities nor the electrical and mechanical durabilities can be assured.</p>		
Shock resistance <sup>(2)</sup> 1/2 sine wave = 11 ms	Contactor open			9 gn	7 gn
	Contactor closed			15 gn	15 gn
Vibration resistance <sup>(2)</sup> 5...300 Hz	Contactor open			2 gn	2 gn
	Contactor closed			6 gn	5 gn

(1) In these conditions, it is recommended that LX9 F coils be used for contactor sizes F115 to F225.

(2) In the least favourable direction, without change of contact state (coil at Uc). Where higher resistance to mechanical shock is required, select shock-proof contactors. Please consult your Regional Sales Office.

High power contactors

# Characteristics - TeSys F

## TeSys contactors

### TeSys F contactors

Utilisation category AC-3 (115 to 1000 A), AC-1 (200 to 2600 A)

Control circuit: a.c. or d.c. supply

LC1 F225	LC1 F265	LC1 F330	LC1 F400	LC1 F500	LC1 F630	LC1 F780	LC1 F800	LC1 F1000	LC1 SF1200	LC1 F1250	LC1 F1400	LC1 F1700	LC1 F2100	LC1 F2600
1000	1000	1000	1000	1000	1000	1000	1000	1000	1000	1000	1000	1000	1000	1000
8	8	8	8	8	8	8	8	8	8	8	8	8	8	8

EN 60947-1, EN 60947-4-1, IEC 60947-1, IEC 60947-4-1, JIS C 8201-4-1 (except for LC1F1000 & LC1SF1200)

UL, CSA, CCC, CB certification, EAC, ABS, BV, DNV-GL, LRoS, RINA, RMRoS

CB, CSA, UL, CCC, LRoS, ABS, RMRoS

CB, CSA, CCC

CB, CCC

CB, CSA, CCC, cETLus

IP 20 front face with shrouds LA9 F

-60...+80

-5...+55

-40...+70

-5...+40

-5...+60

-5...+40

-5...+55

-40...+60

-40...+70

-40...+60

3000

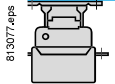
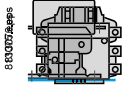
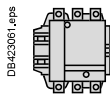
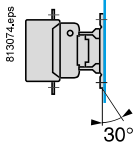
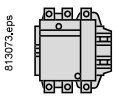

Apply the following derating coefficients: 0.75 on the pull-in voltage, 0.8 on the drop-out voltage and 0.8 on the operational current in AC-1.

Apply the following derating coefficients: 1.15 on the pull-in voltage, 1.1 on the drop-out voltage and 0.8 on the operational current in AC-1.

In either case: neither the making and breaking capacities nor the electrical and mechanical durabilities can be assured.

Not to be used

Possible positions with derating (see corresponding paragraph on left, same line)

Not to be used

7 gn	6 gn	6 gn	6 gn	9 gn	6 gn	5 gn	6 gn	6 gn	6 gn	6 gn	6 gn	6 gn	6 gn	6 gn
15 gn	15 gn	15 gn	15 gn	15 gn	15 gn	15 gn	15 gn	15 gn	15 gn	15 gn	15 gn	15 gn	15 gn	15 gn
2 gn	2 gn	2 gn	1.5 gn	2 gn	2 gn	2.5 gn	2 gn	2 gn	2 gn	2 gn	2 gn	2 gn	2 gn	2 gn
5 gn	5 gn	5 gn	5 gn	4 gn	4 gn	5.5 gn	4 gn	4 gn	4 gn	4 gn	4 gn	4 gn	4 gn	4 gn

813075.eps

High power contactors

# Characteristics - TeSys F

## TeSys contactors

### TeSys F contactors

Utilisation category AC-3 (115 to 1000 A), AC-1 (200 to 2600 A)

Control circuit: a.c. or d.c. supply

Pole characteristics							
Contactor type			LC1 F115	LC1 F150	LC1 F185	LC1 F225	LC1 F265
Number of poles			3 or 4	3 or 4	3 or 4	3 or 4	3 or 4
Rated operational current (Ie) (Ue ≤ 440 V)	In AC-3, θ ≤ 55 °C	<b>A</b>	115	150	185	225	265
	In AC-1, θ ≤ 40 °C	<b>A</b>	200	250	275	315	350
Rated operational voltage (Ue)	Up to	<b>V</b>	690	690	690	690	1000 <sup>(5)</sup>
Frequency limits	Of the operational current <sup>(1)</sup>	<b>Hz</b>	16 <sup>2/3</sup> ...200	16 <sup>2/3</sup> ...200	16 <sup>2/3</sup> ...200	16 <sup>2/3</sup> ...200	16 <sup>2/3</sup> ...200
Conventional thermal current	θ ≤ 40 °C	<b>A</b>	200	250	275	315	350
Rated making capacity	I rms conforming to IEC 60947-4-1	<b>A</b>	Making current: 10 x I in AC-3 or 12 x I in AC-4				
Rated breaking capacity	I rms conforming to IEC 60947-4-1	<b>A</b>	Making and breaking current: 8 x I in AC-3 or 10 x I in AC-4				
Maximum permissible current No current flowing for previous 60 minutes, at θ ≤ 40 °C	For 10 s	<b>A</b>	1100	1200	1500	1800	2200
	For 30 s	<b>A</b>	640	700	920	1000	1230
	For 1 min	<b>A</b>	520	600	740	850	950
	For 3 min	<b>A</b>	400	450	500	560	620
	For 10 min	<b>A</b>	320	350	400	440	480
Short-circuit protection by fuses U ≤ 440 V	Motor circuit (type aM)	<b>A</b>	125	160	200	250	315
	With thermal overload relay (type gG)	<b>A</b>	200	200	315	315	500
	gG fuses	<b>A</b>	200	250	315	315	400
Average impedance per pole	At Ith and 50 Hz	<b>mΩ</b>	0.37	0.35	0.33	0.32	0.3
Power dissipation per pole for the above operational currents	AC-3	<b>W</b>	5	8	12	16	21
	AC-1	<b>W</b>	15	22	25	32	37
Connection			Maximum c.s.a.				
Bar	Number of bars		2	2	2	2	2
	Bar	<b>mm</b>	20 x 3	25 x 3	25 x 3	32 x 4	32 x 4
Cable with lug		<b>mm<sup>2</sup></b>	95	120	150	185	240
Cable with connector		<b>mm<sup>2</sup></b>	95	120	150	185	240
Bolt diameter		<b>mm</b>	Ø6	Ø8	Ø8	Ø10	Ø10
Tightening torque	Power circuit connections	<b>N.m</b>	10	18	18	35	35

(1) Sine wave without interference. Above these values, contactors can be used only for AC-1 application.

(2) With set of right-angled connectors **LA9 F2100** (see page B9/13).

(3) Paralleling of poles must be carried out only in accordance with the fuse manufacturer's recommendations.

(4) θ ≤ 60 °C with set of right-angled connectors **LA9 F2600** (see page B9/13).

(5) Ue ≤ 690 V in AC-3; Ue ≤ 1000 V in AC-1.

(6) Ue = 1000 V, with set of right angled connectors **LA9 F2100** (see page B9/13).



# Characteristics - TeSys F

## TeSys contactors

### TeSys F contactors

Utilisation category AC-3 (115 to 1000 A), AC-1 (200 to 2600 A)

Control circuit: a.c. or d.c. supply

LC1 F330	LC1 F400	LC1 F500	LC1 F630	LC1 F780	LC1 F800	LC1 F1000	LC1SF1200	LC1 F1250	LC1 F1400	LC1 F1700	LC1 F2100	LC1 F2600
3 or 4	2, 3 or 4	2, 3 or 4	2, 3 or 4	3 or 4	3	3	3	3	3	3	3	3
330	400	500	630	780	800	1000	-	-	-	-	-	-
400	500	700	1000	1600	1000	1250	1200	1260	1400	1700	2100 <sup>(2)</sup>	2600 <sup>(4)</sup>
1000	1000	1000 <sup>(5)</sup>	1000	1000	1000	440	690	690	1000	1000	1000 <sup>(6)</sup>	1000
16 <sup>2/3</sup> ...200	16 <sup>2/3</sup> ...200	16 <sup>2/3</sup> ...200	16 <sup>2/3</sup> ...200	16 <sup>2/3</sup> ...200	16 <sup>2/3</sup> ...200	16 <sup>2/3</sup> ...200	16 <sup>2/3</sup> ...200	16 <sup>2/3</sup> ...200	16 <sup>2/3</sup> ...200	16 <sup>2/3</sup> ...200	16 <sup>2/3</sup> ...200	16 <sup>2/3</sup> ...200
400	500	700	1000	1600	1000	1250	1200	1260	1400	1700	2100 <sup>(2)</sup>	2600 <sup>(4)</sup>
Making current: 10 x I in AC-3 or 12 x I in AC-4						10 x I in AC-3	Making current: 1.5 x I in AC-1					
Making and breaking current: 8 x I in AC-3 or 10 x I in AC-4						8 x I in AC-3	Making and breaking current: 1.5 x I in AC-1					
2650	3600	4200	5050	6250	5500	10000	8000	8000	8000	10000	10000	12000
1800	2400	3200	4400	5600	4600	7500	5200	5200	6000	7500	7500	9000
1300	1700	2400	3400	4600	3600	5500	4000	4000	4500	5500	5500	7000
900	1200	1500	2200	3000	2600	4200	3000	3000	4000	4200	4200	6000
750	1000	1200	1600	2200	1700	3000	2000	2000	2600	3000	3000	4000
400	400	500	630	800	800	1000	-	-	-	-	-	-
500	630	800	800	1000	1000	1000	-	-	-	-	-	-
500	500	800	1000	2 x 800 <sup>(3)</sup>	1000	1000	1400	1400	2 x 800 <sup>(3)</sup>	2 x 800 <sup>(3)</sup>	2 x 1000 <sup>(3)</sup>	2 x 1250 <sup>(3)</sup>
0.28	0.26	0.18	0.12	0.10	0.12	0.12	0.10	0.12	0.10	0.10	0.10	0.10
31	42	45	48	60	77	100	-	-	-	-	-	-
44	65	88	120	250	120	120	120	120	150	200	200	250
Maximum c.s.a.												
2	2	2	2	2	2	3	2	2	2	3	4	3
30 x 5	30 x 5	40 x 5	60 x 5	100 x 5	60 x 5	100 x 5	50x8	100 x 5	100 x 5	100 x 5	100 x 5	100 x 10
240	2 x 150	2 x 240	-	-	-	-	-	-	-	-	-	-
-	-	-	-	-	-	-	-	-	-	-	-	-
Ø10	Ø10	Ø10	Ø12	2 x Ø12	Ø12	4 x Ø12 (Ø11.5 with set of right-angled connectors LA9F2100)	3 x Ø12	3 x Ø12 (Ø11.5 with set of right-angled connectors LA9F1250)	4 x Ø12 (Ø11.5 with set of right-angled connectors LA9 F2100)			4 x Ø12 (Ø11.5 with set of right-angled connectors LA9 F2600)
35	35	35	58	58	58	58 (35 with set of right-angled connectors LA9F2100)	58	58 (35 with set of right-angled connectors LA9F1250)	58 (35 with set of right-angled connectors LA9 F2100)			58 (35 with set of right-angled connectors LA9 F2600)

High power contactors

## TeSys contactors

TeSys F contactors

Utilisation category AC-3 (115 to 1000 A), AC-1 (200 to 2600 A)

Control circuit: a.c. supply

Control circuit characteristics with LX1 or LX9 coil								
Contactor type			LC1 F115	LC1 F150	LC1 F185	LC1 F225	LC1 F265	
Rated control circuit voltage (Uc)			V	48...500			24...1000	
Control voltage limits ( $\theta \leq 55\text{ }^\circ\text{C}$ )	40...400 Hz coils	Operation		0.85...1.1 Uc			0.85...1.1 Uc	
		Drop-out		0.2...0.55 Uc			0.35...0.55 Uc	
Average consumption at 20 °C and at Uc	Inrush	40...400 Hz coil	VA	690...855	690...855	950...1180	950...1180	600...700
		Cos $\varphi$		0.9	0.9	0.9	0.9	0.9
	Sealed	40...400 Hz coil	VA	6.6...8.1	6.6...8.1	8.9...10.9	8.9...10.9	8...10
		Cos $\varphi$		0.9	0.9	0.9	0.9	0.9
Heat dissipation			W	5.9...7.2	5.9...7.2	8...9.8	8...9.8	8
Operating time <sup>(2)</sup>	Closing "C"		ms	35	35	35	35	40...65
	Opening "O"		ms	130	130	130	130	100...170
Mechanical durability at Uc	In millions of operating cycles			10	10	10	10	10
Maximum operating rate at ambient temperature $\leq 55\text{ }^\circ\text{C}$	In operating cycles per hour			2400	2400	2400	2400	2400
Connection				Min/max c.s.a.				
Flexible cable without cable end	1 or 2 conductors		mm <sup>2</sup>	1/4	1/4	1/4	1/4	1/4
			mm <sup>2</sup>	1/4	1/4	1/4	1/4	1/4
Flexible cable with cable end	1 conductor		mm <sup>2</sup>	1/4	1/4	1/4	1/4	1/4
	2 conductors		mm <sup>2</sup>	1/2.5	1/2.5	1/2.5	1/2.5	1/2.5
Solid cable without cable end	1 or 2 conductors		mm <sup>2</sup>	1/4	1/4	1/4	1/4	1/4
			mm <sup>2</sup>	1/4	1/4	1/4	1/4	1/4
Tightening torque			N.m	1.2	1.2	1.2	1.2	1.2
Mechanical latching			Mechanical latch blocks LA6 DK must not be fitted on LC1 F contactors. For similar type of operation, use magnetic latching contactors CR1 F. See pages B9/30 to B9/35.					

(1) Equipped with 2 coils.

(2) The closing time "C" is measured from the moment the coil supply is switched on to initial contact of the main poles. The opening time "O" is measured from the moment the coil supply is switched off to the moment the main poles separate.

## Characteristics - TeSys F

### TeSys contactors

#### TeSys F contactors

Utilisation category AC-3 (115 to 1000 A), AC-1 (200 to 2600 A)

Control circuit: a.c. supply

LC1 F330	LC1 F400	LC1 F500	LC1 F630	LC1 F780 <sup>(1)</sup>	LC1 F800	LC1 F1000 <sup>(1)</sup>	LC1 F1250	LC1 F1400 <sup>(1)</sup>	LC1 F1700	LC1 F2100 <sup>(1)</sup>	LC1 F2600 <sup>(1)</sup>
24...1000	48...1000		48...1000	110...500	110...400	110...500	110...600	110...500	110...500	110...500	110...500
0.85...1.1 Uc	0.85...1.1 Uc		0.85...1.1 Uc	0.85...1.1 Uc	0.85...1.1 Uc	0.85...1.1 Uc	0.85...1.1 Uc	0.85...1.1 Uc	0.85...1.1 Uc	0.85...1.1 Uc	0.85...1.1 Uc
0.35...0.55 Uc	0.3...0.5 Uc		0.25...0.5 Uc	0.2...0.4 Uc	0.3...0.5 Uc	0.3...0.5 Uc	0.25...0.5 Uc	0.3...0.5 Uc	0.3...0.5 Uc	0.3...0.5 Uc	0.3...0.5 Uc
600...700	1000...1150	1050...1150	1500...1730	1900...2300	1700	1600...2400	1500...1730	1600...2400	1600...2400	1600...2400	2200...2700
0.9	0.9	0.9	0.9	0.9	0.9	0.9	0.9	0.9	0.9	0.9	0.9
8...10	12...18	16...20	20...25	44...55	12	29...37	20...25	29...37	29...37	29...37	37.4...50.6
0.9	0.9	0.9	0.9	0.9	–	0.9	0.9	0.9	0.9	0.9	0.9
8	14	18	20	2 x 22	25	2 x 18	20	2 x 18	2 x 18	2 x 18	2 x 25
40...65	40...75	40...75	40...80	40...80	60...80	40...75	40...80	40...75	40...75	40...75	40...80
100...170	100...170	100...170	100...200	130...230	160...180	100...170	100...200	100...170	100...170	100...170	100...200
10	10	10	5	5	5	0.5	1	0.5	0.5	0.5	0.5
2400	2400	2400	1200	600	600	600	1200	600	600	600	600
Min/max c.s.a.											
1/4	1/4	1/4	1/4	1/4	1/4	1/4	1/4	1/4	1/4	1/4	1/4
1/4	1/4	1/4	1/4	1/4	1/4	1/4	1/4	1/4	1/4	1/4	1/4
1/2.5	1/2.5	1/2.5	1/2.5	1/2.5	1/2.5	1/2.5	1/2.5	1/2.5	1/2.5	1/2.5	1/2.5
1/4	1/4	1/4	1/4	1/4	1/4	1/4	1/4	1/4	1/4	1/4	1/4
1.2	1.2	1.2	1.2	1.2	1.2	1.2	1.2	1.2	1.2	1.2	1.2

Mechanical latch blocks LA6 DK must not be fitted on LC1 F contactors.  
For similar type of operation, use magnetic latching contactors CR1 F.  
See pages B9/30 to B9/35.

# Characteristics - TeSys F

## TeSys contactors

TeSys F contactors

Utilisation category AC-3 (115 to 1000 A), AC-1 (200 to 2600 A)

Control circuit: d.c. supply

Control circuit characteristics with LX4 coil								
Contactor type			LC1 F115	LC1 F150	LC1 F185	LC1 F225	LC1 F265	
Rated control circuit voltage (Uc) <sup>---</sup>		V	24...460	24...460	24...460	24...460	24...460	
Control voltage limits ( $\theta \leq 55\text{ }^\circ\text{C}$ )	Operation		0.85...1.1 Uc	0.85...1.1 Uc	0.85...1.1 Uc	0.85...1.1 Uc	0.85...1.1 Uc	
	Drop-out		0.15...0.2 Uc	0.15...0.2 Uc	0.15...0.2 Uc	0.15...0.2 Uc	0.15...0.2 Uc	
Average consumption at 20 °C and at Uc	<sup>---</sup>	Inrush	W	543...665	543...665	737...902	737...902	655...803
		Sealed	W	3.94...4.83	3.94...4.83	4.13...5.07	4.13...5.07	3.68...4.53
Average operating time at Uc <sup>(1)</sup>	Closing "C"	ms	30...40	30...40	30...40	30...40	40...50	
	Opening "O"	ms	30...50	30...50	30...50	30...50	40...65	
			<i>Note: the arcing time depends on the circuit switched by the poles. For all normal 3-phase applications, the arcing time is less than 10 ms. The load is isolated from the supply after a time equal to the sum of the opening time and the arcing time.</i>					
Mechanical durability at Uc	In millions of operating cycles		10	10	10	10	10	
Maximum operating rate at ambient temperature $\leq 55\text{ }^\circ\text{C}$	In operating cycles per hour		2400	2400	2400	2400	2400	
Cabling			Min/max c.s.a.					
Flexible cable without cable end	1 conductor	mm <sup>2</sup>	1/4	1/4	1/4	1/4	1/4	
	2 conductors	mm <sup>2</sup>	1/4	1/4	1/4	1/4	1/4	
Flexible cable with cable end	1 conductor	mm <sup>2</sup>	1/4	1/4	1/4	1/4	1/4	
	2 conductors	mm <sup>2</sup>	1/2.5	1/2.5	1/2.5	1/2.5	1/2.5	
Solid cable without cable end	1 conductor	mm <sup>2</sup>	1/4	1/4	1/4	1/4	1/4	
	2 conductors	mm <sup>2</sup>	1/4	1/4	1/4	1/4	1/4	
Tightening torque		N.m	1.2	1.2	1.2	1.2	1.2	
Mechanical latching		Mechanical latch blocks LA6 DK must not be fitted on LC1 F contactors. For similar type of operation, use magnetic latching contactors CR1 F. See pages B9/30 to B9/35.						

<sup>(1)</sup> The operating times depend on the type of contactor electromagnet and its control mode.  
The closing time "C" is measured from the moment the coil supply is switched on to initial contact of the main poles. The opening time "O" is measured from the moment the coil supply is switched off to the moment the main poles separate.

## Characteristics - TeSys F

### TeSys contactors

TeSys F contactors

Utilisation category AC-3 (115 to 1000 A), AC-1 (200 to 2600 A)

Control circuit: d.c. supply

LC1 F330	LC1 F400	LC1 F500	LC1 F630	LC1 F780	LC1 F800	LC1 F1000	LC1 F1250	LC1 F1400	LC1 F1700	LC1 F2100	LC1 F2600
24...460	48...440	48...440	48...440	110...440	110...400	110...440	48...250	110...440	110...440	110...440	110...440
0.85...1.1 Uc	0.85...1.1 Uc	0.85...1.1 Uc	0.85...1.1 Uc	0.85...1.1 Uc	0.85...1.1 Uc	0.85...1.1 Uc	0.85...1.1 Uc	0.85...1.1 Uc	0.85...1.1 Uc	0.85...1.1 Uc	0.85...1.1 Uc
0.15...0.2 Uc	0.2...0.35 Uc	0.2...0.35 Uc	0.2...0.35 Uc	0.2...0.4 Uc	0.3...0.5 Uc	0.2...0.35 Uc	0.2...0.35 Uc	0.2...0.35 Uc	0.2...0.35 Uc	0.2...0.35 Uc	0.2...0.35 Uc
655...803	920...1140	990...1220	1420...1920	1960...2420	1900	2000...2200	1420...1920	2000...2200	2000...2200	2000...2200	2130...2880
3.68...4.53	4...7.5	4.54...8	6.5...12.5	42...52	12	8...10	6.5...12.5	8...10	8...10	8...10	13...25
40...50	50...60	50...60	60...70	70...80	60...80	50...60	60...70	50...60	50...60	50...60	60...70
40...65	45...60	45...60	40...50	100...130	40...50	45...60	40...50	45...60	45...60	45...60	40...50

**Note:** the arcing time depends on the circuit switched by the poles. For all normal 3-phase applications, the arcing time is less than 10 ms. The load is isolated from the supply after a time equal to the sum of the opening time and the arcing time.

10	10	10	5	5	5	0.5	1	0.5	0.5	0.5	0.5
2400	2400	2400	1200	600	600	600	1200	600	600	600	600
Min/max c.s.a.											
1/4	1/4	1/4	1/4	1/4	1/4	1/4	1/4	1/4	1/4	1/4	1/4
1/4	1/4	1/4	1/4	1/4	1/4	1/4	1/4	1/4	1/4	1/4	1/4
1/4	1/4	1/4	1/4	1/4	1/4	1/4	1/4	1/4	1/4	1/4	1/4
1/2.5	1/2.5	1/2.5	1/2.5	1/2.5	1/2.5	1/2.5	1/2.5	1/2.5	1/2.5	1/2.5	1/2.5
1/4	1/4	1/4	1/4	1/4	1/4	1/4	1/4	1/4	1/4	1/4	1/4
1/4	1/4	1/4	1/4	1/4	1/4	1/4	1/4	1/4	1/4	1/4	1/4
1.2	1.2	1.2	1.2	1.2	1.2	1.2	1.2	1.2	1.2	1.2	1.2

Mechanical latch blocks LA6 DK must not be fitted on LC1 F contactors.

For similar type of operation, use magnetic latching contactors CR1 F.

See pages B9/30 to B9/35.

# Characteristics - TeSys F

## TeSys contactors

TeSys F contactors

Utilisation category AC-3 (115 to 800 A), AC-1 (200 to 1260 A)

Control circuit: a.c or d.c. supply

Control circuit characteristics with LXE coil <sup>(1)</sup>				LC1 F115, F150	LC1 F185, F225	LC1 F265, F330
Contactor type						
ECM <sup>(2)</sup> reference				LA4EM250FF	LA4EM250FG	LA4EM250FH
Coil reference				LXEFF250	LXEFG250	LXEFH250
Rated control circuit voltage (Uc)	50/60 Hz		V	100...250		
	---		V	100...380		
Control voltage limits (< 55 °C) 50/60 Hz	Operation		V	85...275		
	Drop-out		V	< 58		
---	Operation		V	85...418		
	Drop-out		V	< 45		
Average consumption at 20 °C and at Uc	Inrush	50/60 Hz	VA rms	280...310	280...310	300...350
		Cos φ		0.5...0.6		
	---		W	270...320	270...320	300...310
	Sealed	50/60 Hz	VA	4.5...7.0	4.5...7.0	4.5...7.0
		Cos φ		0.5...0.6		
	---			2.5...4.0	2.5...4.0	2.5...4.0
Embedded PLC <sup>(4)</sup> input according IEC 61131-2 type 2	Off state		V DC	0...5		
	On state			11...30		
Heat dissipation			W	2.2...5.5		
Operating time	Closing "C"		ms	40...80		
	Opening "O"		ms	10...40		
Mechanical durability at Uc	In millions of operating cycles			10		
Maximum operating rate at ambient temperature ≤ 55 °C	In operating cycles per hour			2400		
Connection <sup>(5)</sup>	Flexible cable without cable end	1 conductor		0.2/2.5		
	Flexible cable with cable end	1 conductor		0.25/2.5		
	Solid cable without cable end	1 conductor		0.2/2.5		
Tightening torque			N.m	0.6		

(1) LXE coil shall be always used along with Electronic Control Module (ECM) LA4EM250●●.

(2) Electronic Control Module enables wider coil operating voltage for the TeSys F range of contactors. ECM LA4EM250●● shall be always used along with suitable type of LXE●●250 coils.

(3) LC1SF1200KUE is supplied with LA4EM250FK & LXEFK250.

(4) PLC control connectors shall be provided by customer (Type MC 1.5/2-ST-3.81).

(5) Connection input is made to Electronic control module (ECM).

## Characteristics - TeSys F

### TeSys contactors

TeSys F contactors

Utilisation category AC-3 (115 to 800 A), AC-1 (200 to 1260 A)

Control circuit: a.c or d.c. supply

LC1 F400	LC1 F500, SF1200 <sup>(3)</sup>	LC1 F630, F1250	LC1 F800
LA4EM250FJ	LA4EM250FK	LA4EM250FL	LA4EM250FW
LXEFJ250	LXEFK250	LXEFL250	LXEFW250
100...250			
100...380			
85...275			
< 58			
85...418			
< 45			
360...470	360...550	460...730	460...730
0.5...0.6			
410...450	410...500	500...680	500...680
4.5...7.0	5.0...8.0	7...10	7...10
0.5...0.6			
2.5...4.0	2.7...5.0	4.0...5.5	4.0...5.5
0...5			
11...30			
2.2...5.5			
40...80			
10...40			
10	10/0.5	5/1	5
2400	2400/1200	1200	600
0.2/2.5			
0.25/2.5			
0.2/2.5			
0.6			

High power  
contactors

LC1 F115 to F330

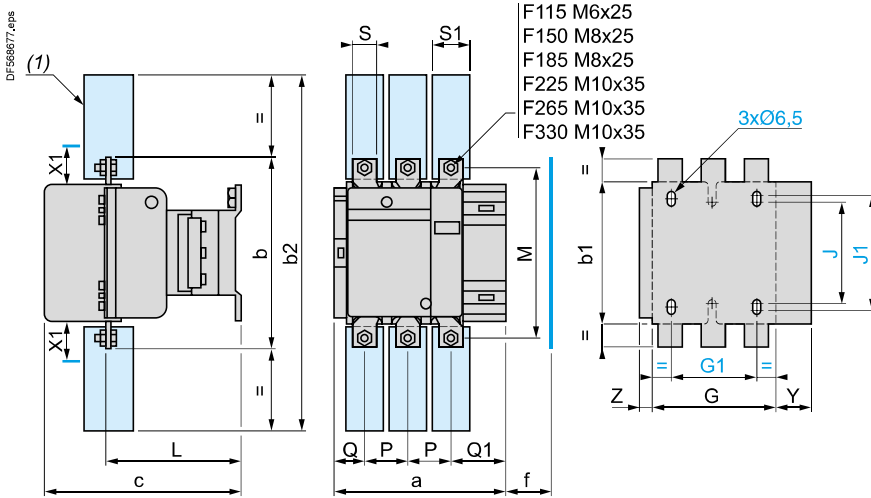

X1 (mm) = Minimum electrical clearance according to operating voltage and breaking capacity.

LC1	200...500 V	600...1000 V
F115, F150	10	15
F185	10	15
F225, F265	10	15
F330	10	15

(1) Power terminal protection shroud (see page B9/14).

LC1		a	b	b1	b2	c	f	G	G1	J	J1	L	M	P	Q	Q1	S	S1	Y	Z
F115	3P	163.5	162	137	265	171	131	106	80	106	120	107	147	37	29.5	60	20	26	44	13.5
	4P	200.5	162	137	265	171	131	143	80	106	120	107	147	37	29.5	60	20	26	44	13.5
F150	3P	163.5	170	137	301	171	131	106	80	106	120	107	150	40	26	57.5	20	34	44	13.5
	4P	200.5	170	137	301	171	131	143	80	106	120	107	150	40	26	55.5	20	34	44	13.5
F185	3P	168.5	174	137	305	181	130	111	80	106	120	113.5	154	40	29	59.5	20	34	44	13.5
	4P	208.5	174	137	305	181	130	151	80	106	120	113.5	154	40	29	59.5	20	34	44	13.5
F225	3P	168.5	197	137	364	181	130	111	80	106	120	113.5	172	48	21	51.5	25	44.5	44	13.5
	4P	208.5	197	137	364	181	130	151	80	106	120	113.5	172	48	17	47.5	25	44.5	44	13.5
F265	3P	201.5	203	145	375	213	147	142	96	106	120	141	178	48	39	66.5	25	44.5	38	21.5
	4P	244.5	203	145	375	213	147	190	96	106	120	141	178	48	34	66.5	25	44.5	38	16.5
F330	3P	213	206	145	375	219	147	154.5	96	106	120	145	181	48	43	74	25	44.5	38	20.5
	4P	261	206	145	375	219	147	202.5	96	106	120	145	181	48	43	74	25	44.5	38	20.5

f = minimum distance required for coil removal.

LC1 F400 and F500

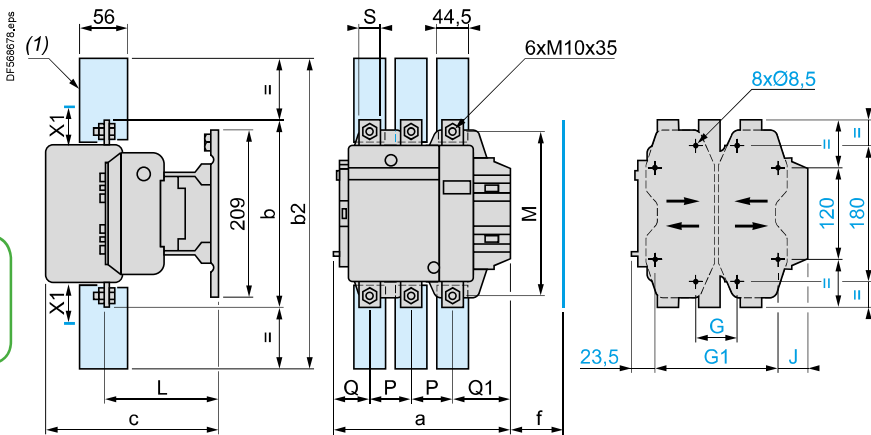

X1 (mm) = Minimum electrical clearance according to operating voltage and breaking capacity.

LC1	200...500 V	600...1000 V
F400	15	20
F500	15	20

(1) Power terminal protection shroud (see page B9/14).

LC1		a	b	b2	c	f	G	G	G	G1	G1	G1	J	L	M	P	Q	Q1	S	
							supplied	min.	max.	supplied	min	max.								
F400	2P	213	206	375	219	146	80	66	102	170	156	192	19.5	145	181	48	69	96	25	
	3P	213	206	375	219	146	80	66	102	170	156	192	19.5	145	181	48	43	74	25	
	4P	261	206	375	219	146	80	66	150	170	156	240	67.5	145	181	48	43	74	25	
F500	2P	233	238	400	232	150	80	66	120	170	156	210	39.5	146	208	55	76	102	30	
	3P	233	238	400	232	150	80	66	120	170	156	210	39.5	146	208	55	46	77	30	
	4P	288	238	400	232	150	140	66	175	230	156	265	34.5	146	208	55	46	77	30	

f = minimum distance required for coil removal.



LC1 F630 and F800

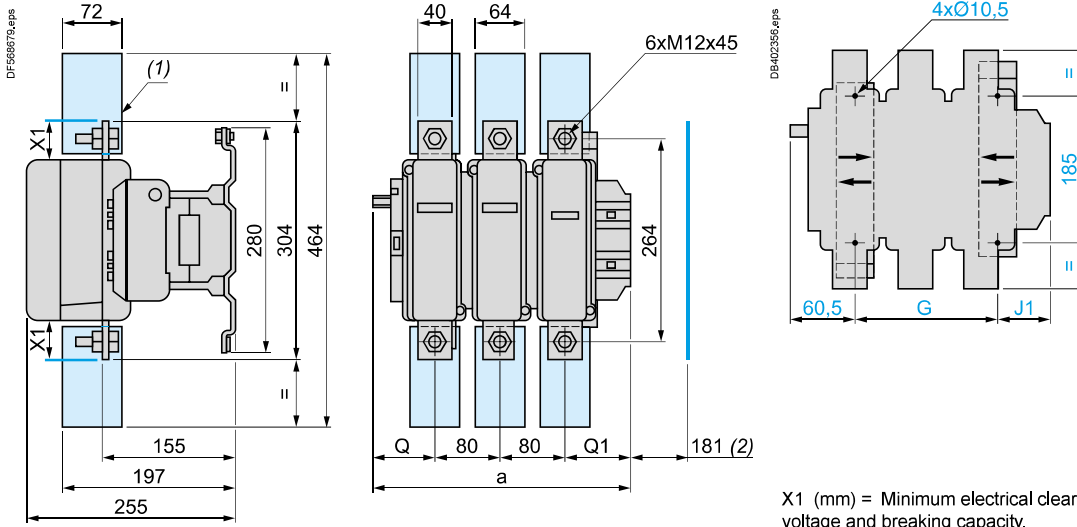

LC1		a	G	G	G	J1	Q	Q1
			supplied	min.	max.			
F630	2P	309	180	100	195	68.5	102	127
F630, F800	3P	309	180	100	195	68.5	60	89
F630	4P	389	240	150	275	88.5	60	89

X1 (mm) = Minimum electrical clearance according to operating voltage and breaking capacity.

Voltage	200...500 V	690...1000 V	200...690 V	1000 V
LC1 F630	20	30	-	-
LC1 F800	-	-	10	20

- (1) Power terminal protection shroud (see page B9/14).
- (2) Minimum distance required for coil removal.

LC1 F780

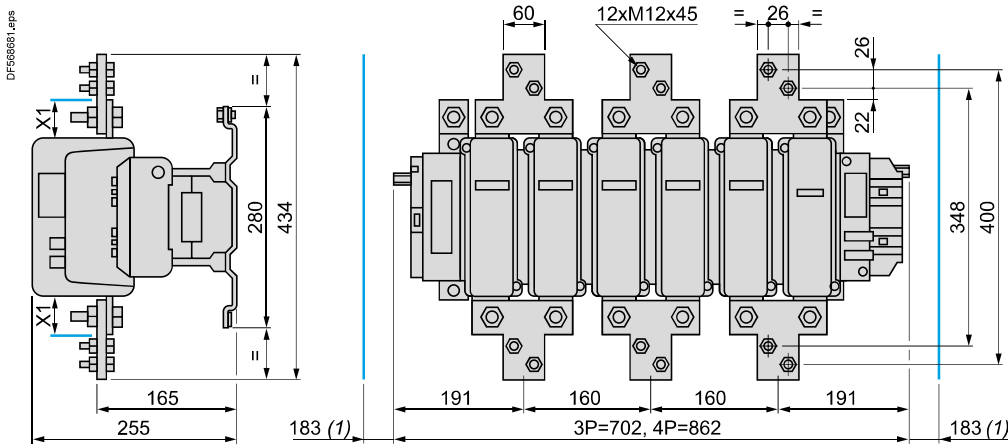

X1 (mm) = Minimum electrical clearance according to operating voltage and breaking capacity.

Voltage	200...500 V	690...1000 V
X1 (mm)	30	35

(1) Minimum distance required for coil removal.

Fixing centres of LC1 F7804

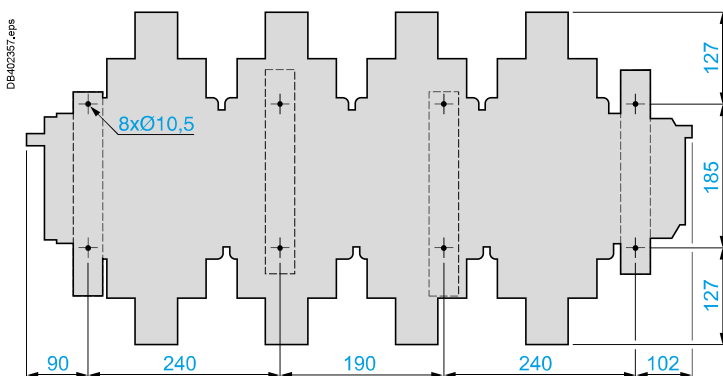

Fixing centres of LC1 F780

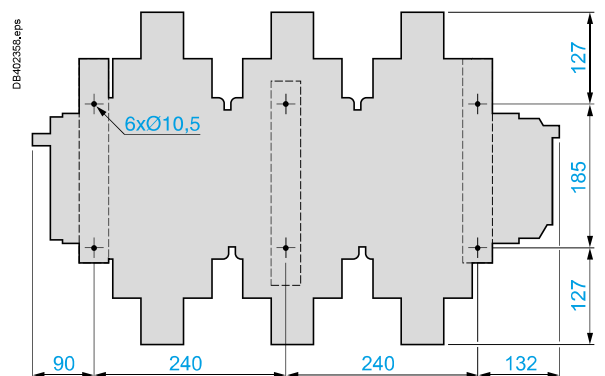

High power contactors

# Dimensions - TeSys F

## TeSys contactors

### TeSys F contactors

#### LC1 SF1200

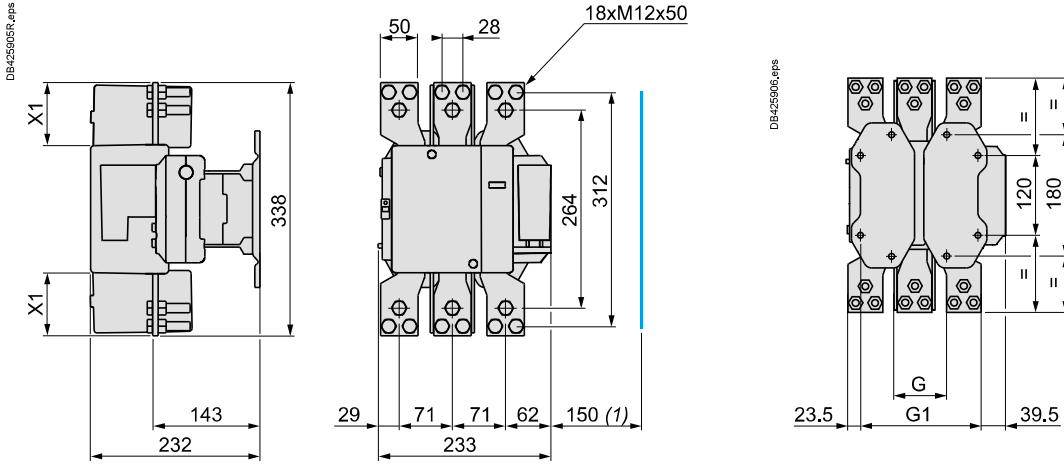

(1) Minimum distance required for coil removal.

X1 (mm) = Minimum electrical clearance according to operating voltage and breaking capacity.  
**Voltage** 200...500 V ≤ 690 V  
**X1 (mm)** 20 30

G (2)	Gmin	Gmax	G1 (2)	Gmin	Gmax
80	66	120	170	156	210

(2) Factory setting.

#### LC1 F1250

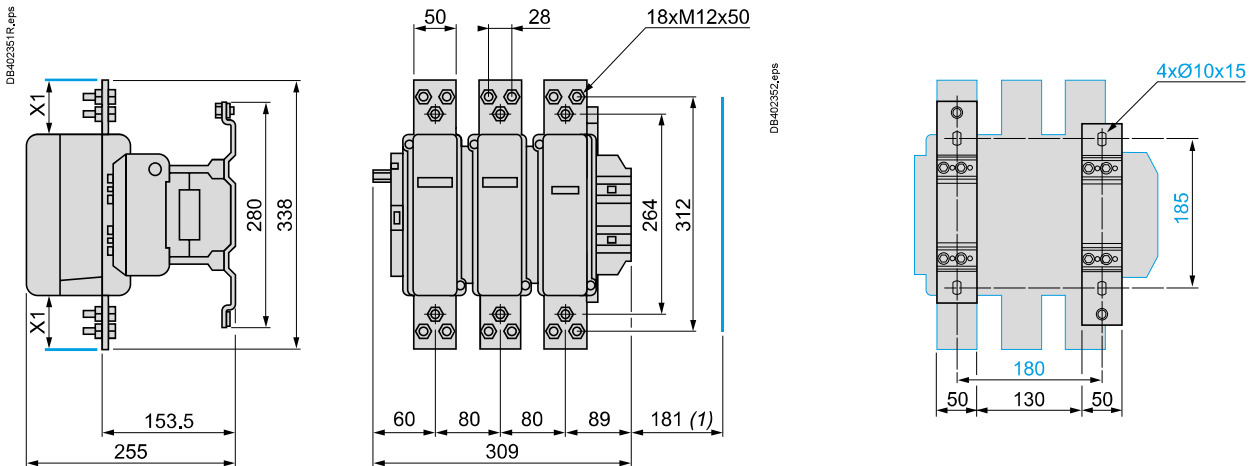

(1) Minimum distance required for coil removal.

X1 (mm) = Minimum electrical clearance according to operating voltage and breaking capacity.

Voltage	200...500 V	690...1000 V
X1 (mm)	20	30

High power contactors

#### LC1 F1000, LC1 F1400, LC1 F1700 and LC1 F2100

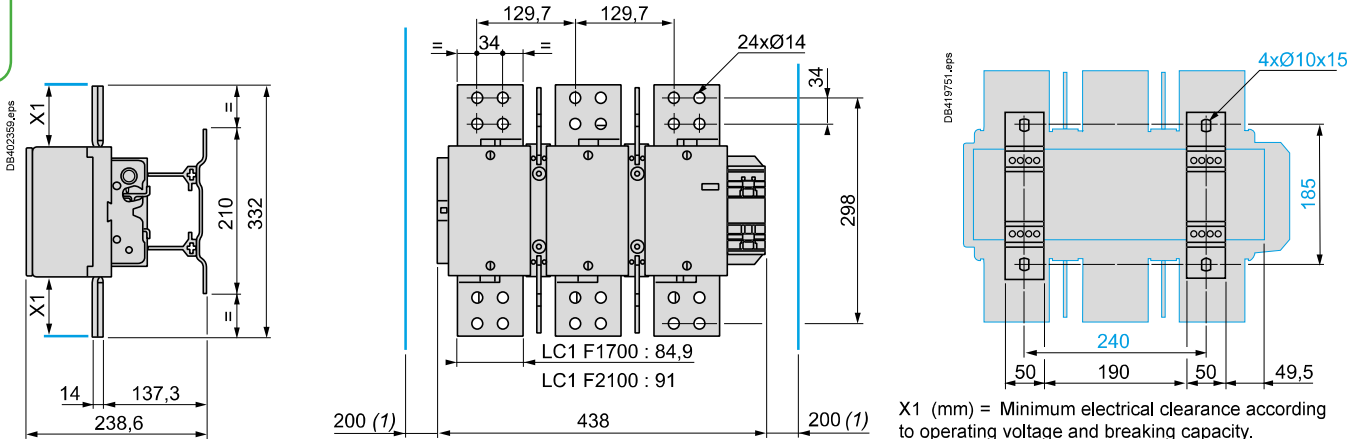

(1) Minimum distance required for coil removal.

X1 (mm) = Minimum electrical clearance according to operating voltage and breaking capacity.

Voltage	200...500 V	690...1000 V
X1 (mm)	90	100

Selection: pages A6/26 to A6/35

Characteristics: pages B9/46 to B9/53

References: pages B9/2 to B9/9

Schemes: page B9/64

# Dimensions - TeSys F

## TeSys contactors

### TeSys F contactors

#### LC1 F2600

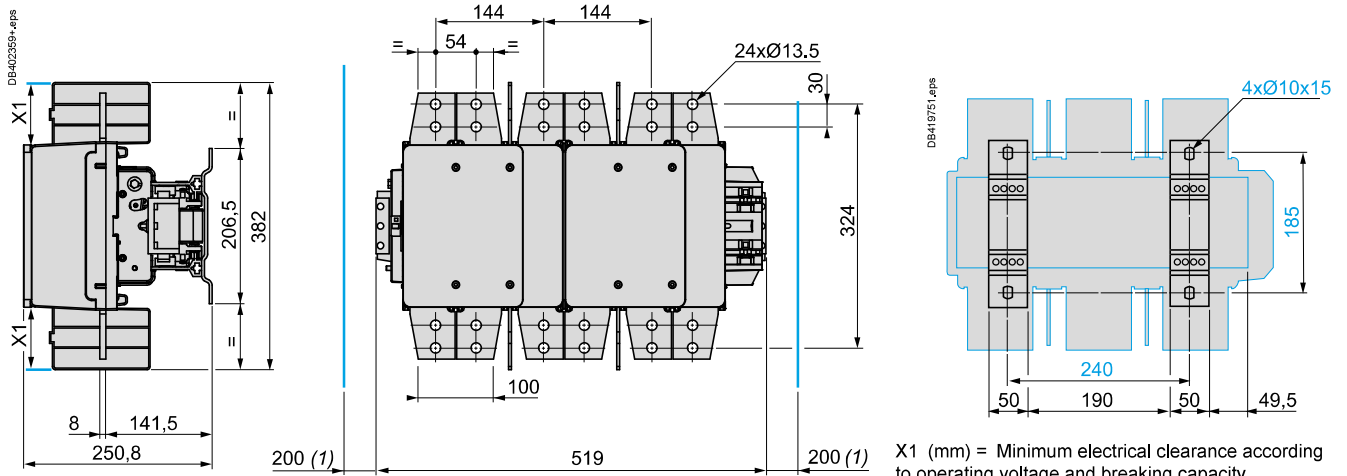

(1) Minimum distance required for coil removal.

X1 (mm) = Minimum electrical clearance according to operating voltage and breaking capacity.

Voltage	200...500 V	690...1000 V
X1 (mm)	90	100

High power contactors

#### Right-angled connectors LA9 F●981 (set of 3) for rear connection

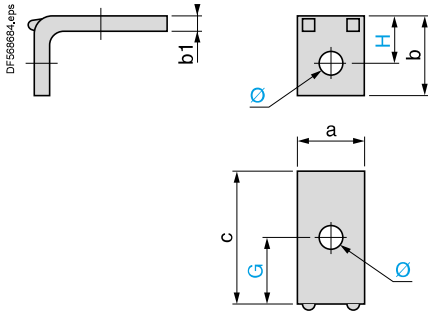

LA9	FF981	FG981	FJ981	FK981	FL981
a	15	20	25	30	40
b	18	23	29	35	48
b1	3	3	4	5	8
c	42	45	55	52	86
G	24	26	32,5	26	45
H	10,5	13	16,5	20	28
Ø	6,5	9	11	11	13

#### Right-angled connectors LA9 F●979 (set of 3) for side connection

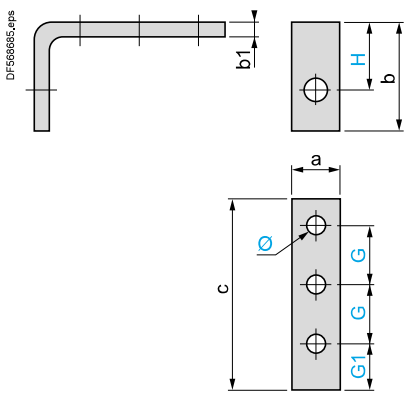

LA9	FF979	FG979	FJ979	FK979	FL979
a	15	20	25	30	40
b	54	58	63,5	68	117
b1	5	5	6	6	10
c	80	92	120	120	130
G	24	28	37	37	37,5
G1	20	22	29	29	35
H	36	39	41	42	76
Ø	6,5	9	11	11	13

#### Right-angled connectors LA9 F●980 with large surface area (set of 3)

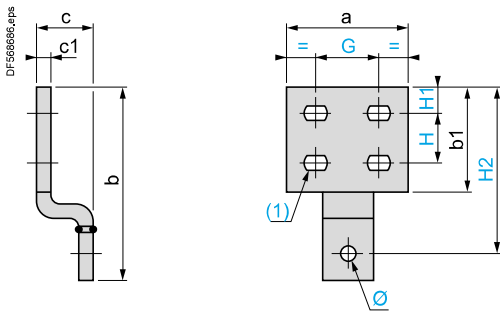

LA9	FF980	FG980	FJ980	FK980	FL980
a	35	40	50	60	100
b	70,5	82,5	98,5	114	154
b1	40	45	55	65	85
c	29	29	33	33	43
c1	3	3	5	5	10
G	18	20	25	29	53
H	18	20	22	26	40
H1	10	12	14	17	20
H2	60,5	72,5	84,5	97	132
Ø	6,5	9	11	11	13
(1)	Ø7 x 10	Ø9 x 12	Ø11 x 14	Ø12,5 x 15	Ø12,5 x 15

#### Right-angled connectors LA9 F1250 (set of 6)

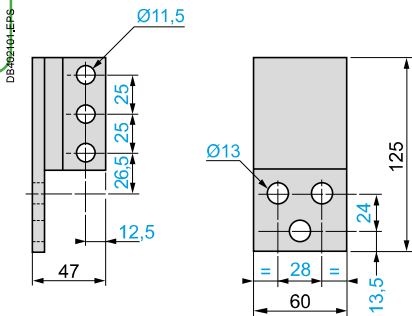

#### Right-angled connectors LA9 F2100 (set of 6) for rear connection

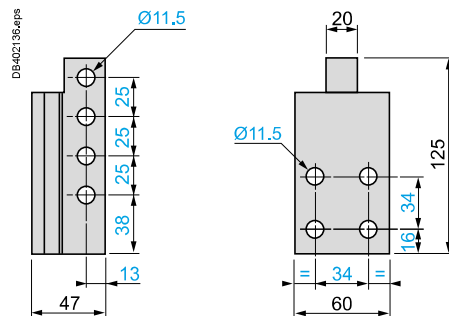

#### Right-angled connectors LA9 F2600 (set of 6) for rear connection

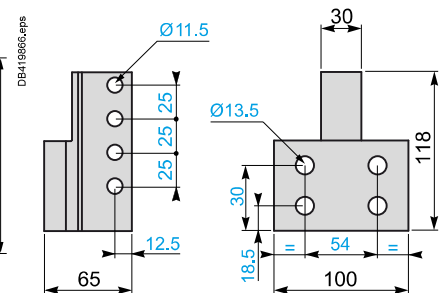

High power contactors

# Dimensions - TeSys F

## TeSys contactors

### TeSys F contactors

#### Accessories

#### Paralleling links (set of 4)

LA9 FF602, FG602, FH602

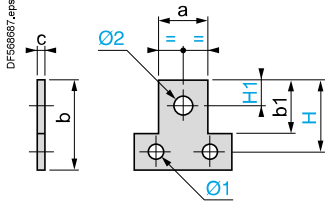

LA9 FK602, FL602

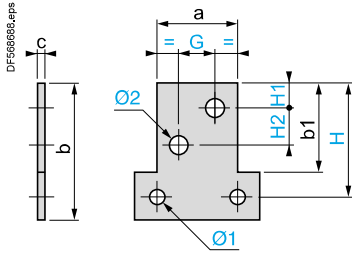

LA9	FF602	FG602	FH602	FK602	FL602
a	25	30	40	50	60
b	45	55	60	85	100
b1	30	35	40	55	65
c	4	5	8	10	10
G	–	–	–	22	26
H	37.5	45	52.5	70	85
H1	12.5	15	15	14	17
H2	–	–	–	22	26
Ø1	6.5	9	11	11	13
Ø2	11	11	13	11	14

#### Links for "star" connection of 3 poles

LA9 F●601

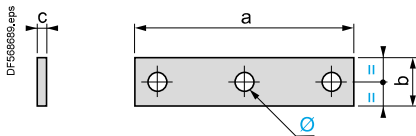

LA9	FF601	FG601	FH601	FK601	FL601
a	69	100	121	140	200
b	15	20	20	30	40
c	3	3	5	5	8
Ø	6.5 x 8.5	8.5 x 10.5	10.5 x 13	11	13

#### Capacitive delayed opening devices for TeSys F contactors

LAZ R9●●

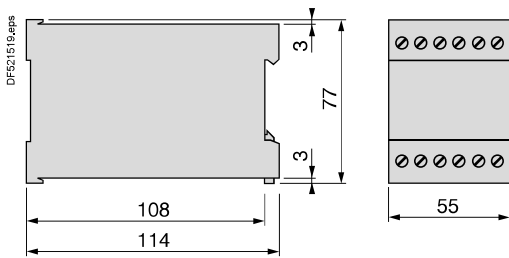

#### Electronic Control Module for LXE●●250 coils

LA4 EM250●●

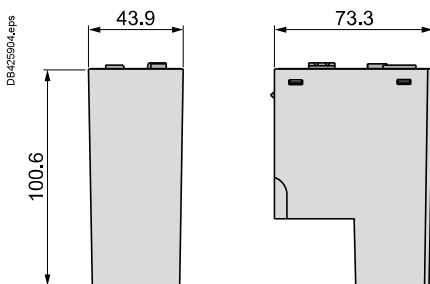

High power contactors

# Mounting - TeSys F

## TeSys contactors

### TeSys F contactors

#### Accessories

#### LC1 F115 to F330

On panel

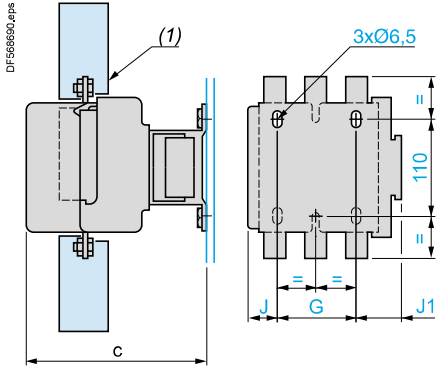

On pre-slotted mounting plate AM1 PA, PB, PC

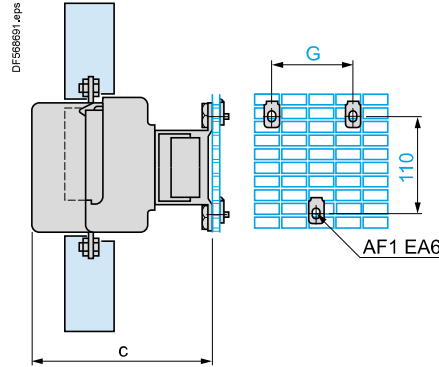

On rails DZ5 MB on 120 mm centres

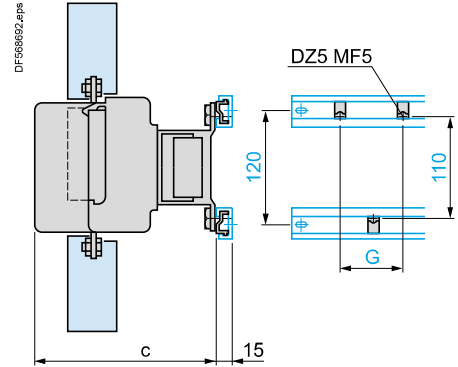

	LC1	F115 F150	F185 F225	F265	F330
c <sup>(2)</sup>	3P	171	181	213	219
	4P	171	181	213	219
G	3P	80	80	96	96
	4P	80	80	96	96
J	3P	26.5	29	44.5	44.5
	4P	45	49	68.5	68.5
J1	3P	57	59.5	61.5	61.5
	4P	75.5	79.5	85.5	85.5

	LC1	F115 F150	F185 F225	F265	F330
c <sup>(2)</sup>	3P	171	181	213	219
	4P	171	181	213	219
G	3P	80	80	96	96
	4P	80	80	96	96

	LC1	F115 F150	F185 F225	F265	F330
c <sup>(2)</sup>	3P	171	181	213	219
	4P	171	181	213	219
G	3P	80	80	96	96
	4P	80	80	96	96

#### LC1 F

On 2 notched rails AM1 EC●●●

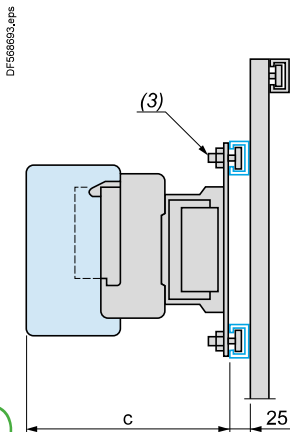

#### LC1 F115 to F330

#### LC1 F400 to F800

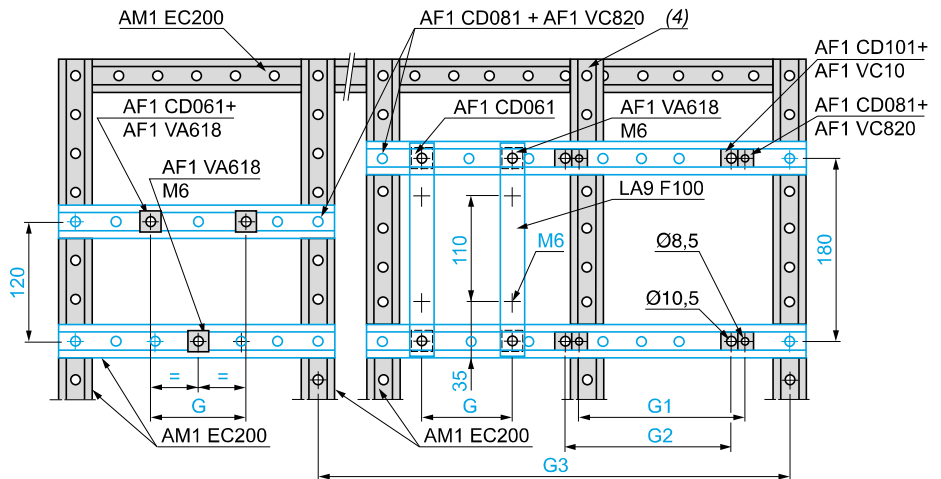

	LC1	F115, F150	F185, F225	F265	F330	F400	F500	F630	F780	F800
c	3P	165 <sup>(5)</sup>	176	207	213	219	232	255	255	255
	4P	165 <sup>(5)</sup>	176	207	213	219	232	255	255	-
G (M6)	3P	80	80	96	96	-	-	-	-	-
	4P	80	80	96	96	-	-	-	-	-
G1 (Ø 8.5)	3P	-	-	-	-	80	80	-	-	-
	4P	-	-	-	-	80	140	-	-	-
G2 (Ø 10.5)	3P	-	-	-	-	-	-	180	See page B9/57	180
	4P	-	-	-	-	-	-	240	See page B9/57	-

(1) Power terminal protection shroud (see page B9/14).

(2) See X1 (minimum electrical clearance) pages B9/56 and B9/57.

(3) AF1 CD●●● and AF1 VA●●●.

(4) This AM1 EC200 upright is required when G2 or G3 is greater than 700 mm (please consult your Regional Sales Office).

(5) + 6 mm with time-delay block on LC1 F.

#### Contactors

##### 2, 3 and 4-pole contactors

LC1 F115 to F630, F1250  
(coil LX1 F ~)

LC1 F115 to F630, F1250 (coil LX4 F ~:~)  
LC1 F115 to F265 (coil LX9 F ~)  
LC1 F800 (coil LX8 F ~/:~)

LC1 F780 ~ or ~:~

LC1 F1000  
LC1 F1400 ~ or ~:~  
LC1 F1700 ~ or ~:~  
LC1 F2100 ~ or ~:~  
LC1 F2600 ~ or ~:~

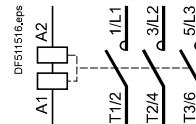
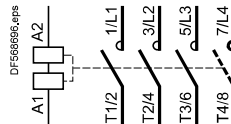
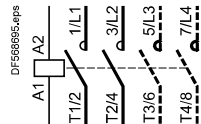
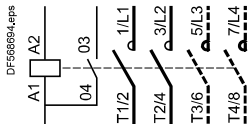

#### Coils

##### Standard ~ coils

LX1 FJ...FL  
LX1 FH0422...FH3802

LX1 FH0202...FH0362  
LX1 FH4402...FH10002  
LX1 F8●

LX1 FX  
Rectifier supplied and fixed on the contactor

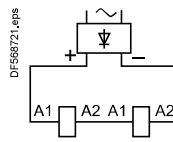
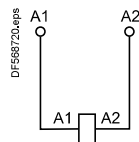
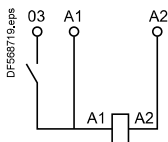

##### Standard ~:~ coils

LX4 FF, FG, FH, FJ, FK, FL, FX (1), LX4 F8●

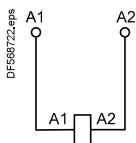

(1) 2 coils in series.

##### Special ~ coils

LX9 FF, FG

LX9 FH●●●2

LX9 FJ, FK, FL

LX4 F8●

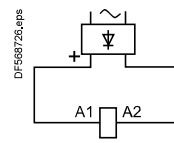
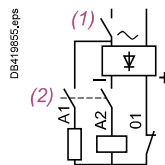
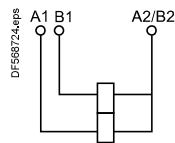
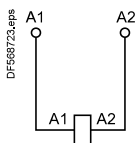

- (1) Breaking on ~ side.  
Drop-out time 50 ms.
- (2) Breaking on ~:~ side.  
Drop-out time 20 ms.

#### Add-on blocks

##### Instantaneous auxiliary contacts

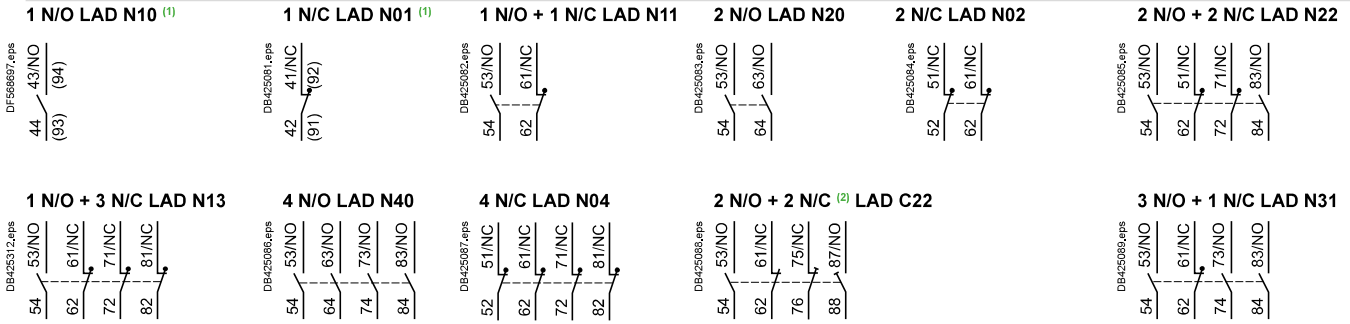

<sup>(1)</sup> Items in brackets: See "TeSys D contactors".

<sup>(2)</sup> 1 N/O + 1 N/C make before break.

##### Instantaneous auxiliary contacts with terminal referencing conforming to standard EN 50012 (References: pages B9/10 and B9/11)

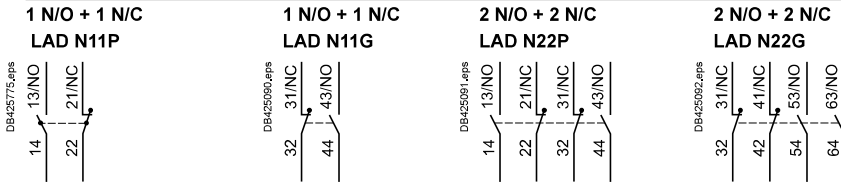

##### Dust and damp protected instantaneous auxiliary contacts

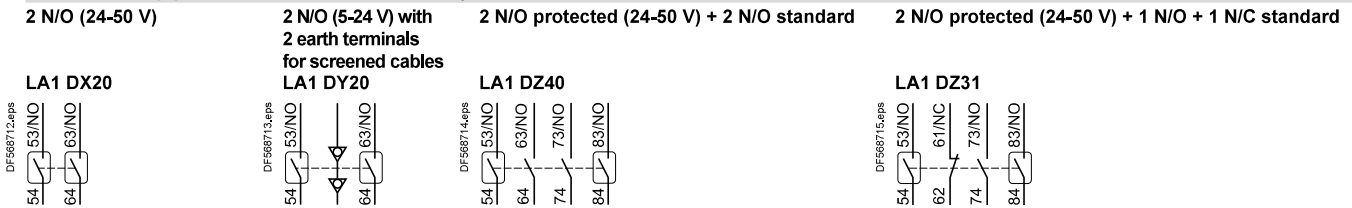

##### Time delay auxiliary contacts

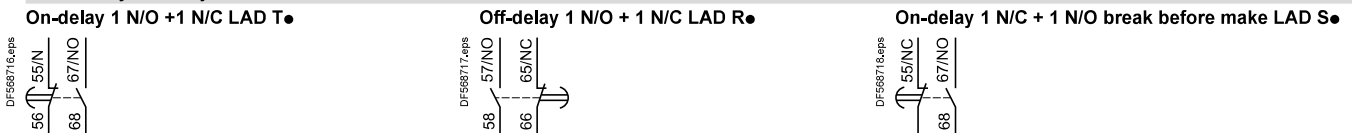

##### Capacitive delayed opening devices for TeSys F contactors

LAZ R9●● + LC1 F

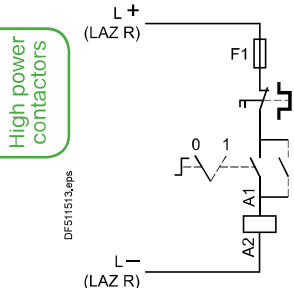



High power  
contactors

## X-ON Electronics

Largest Supplier of Electrical and Electronic Components

*Click to view similar products for [schneider](#) manufacturer:*

Other Similar products are found below :

[LU9M1](#) [7D](#) [7S](#) [7XA1](#) [FNQR2](#) [8501RS44V24](#) [8501RSD14P14V51](#) [8501XO20V03Y414](#) [9001KXRK](#) [9001SKR9P35RH25](#) [9001SKT35L31](#)  
[9003K2C003GA](#) [9007AA1](#) [9007BA1](#) [9007C54D](#) [9007C62A2](#) [9007CA11](#) [9007FA3](#) [9007HA4](#) [9007HA6](#) [9007KA1](#) [9007KB11](#)  
[9007MS01S0206](#) [9007MS02S0300](#) [9012GAR4](#) [9012GAW2](#) [9012GBW1](#) [9012GDW5E3](#) [9012GFW1](#) [9012GNG1](#) [9012GNG3](#) [9012GNG6](#)  
[9013FHG39J69](#) [9013GHG2J30](#) [9050JCK2F30V14](#) [GV2ME32](#) [GVAN20](#) [GZ1E02](#) [A9F04102](#) [A9F04106](#) [A9F05110](#) [A9F07102](#)  
[ABL8RPS24030](#) [DL1BLB](#) [ATS01N206QN](#) [RSL1PRJU](#) [9001KA35](#) [9001KA3G](#) [9001KA4](#) [9001KR1GH5](#)