



# EasyPact TVS

Catalog 2019

Motor starters from 6 to 630A



[schneider-electric.co.in](http://schneider-electric.co.in)

Life Is On

**Schneider**  
Electric



# 90 years of leadership in motor starter technology

EasyPact TVS provide you **Essential** control & protection for your applications:



HVAC



GenSet

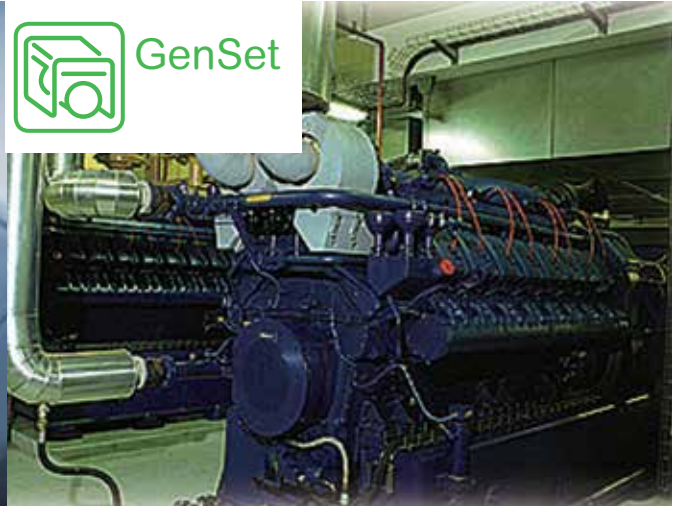

Pumps



Textile



Material Handling



Packaging



# 2 principles to build your starter solution

Designed for the essential

## 3-components solution

(Magnetic circuit breaker or fuse + Contactor + TOR)

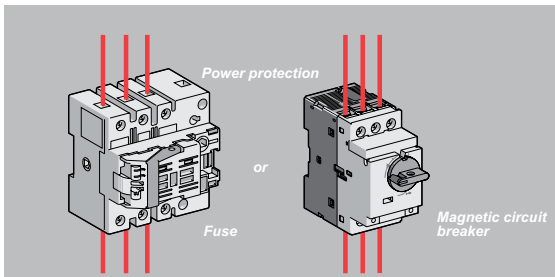

## 2-components solution

(Thermal-magnetic circuit breaker + Contactor)

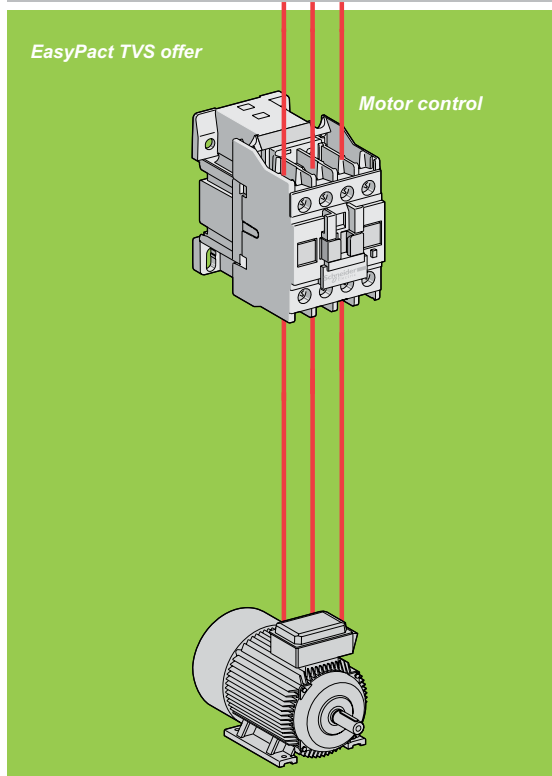
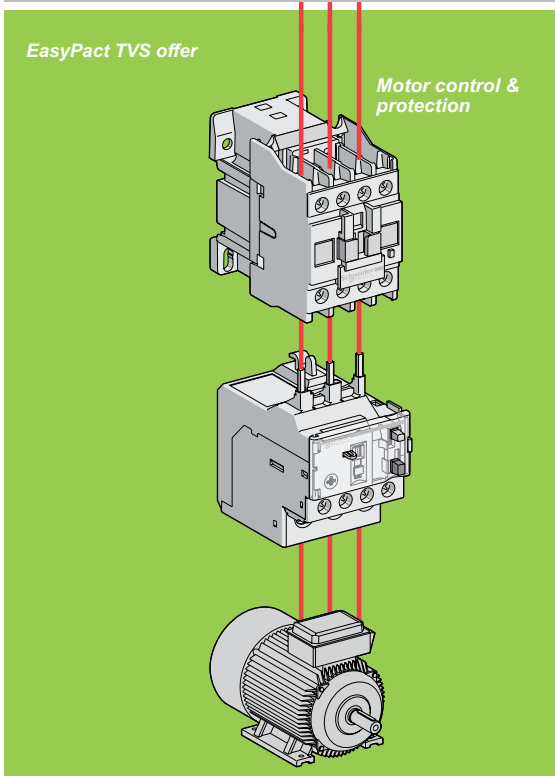
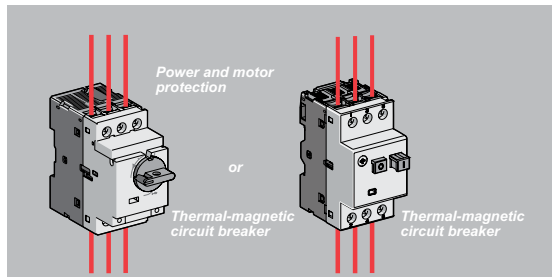

To build the essential solutions in an easy and simple way

Control

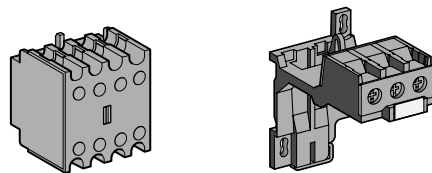

Terminal block

Reversor starter

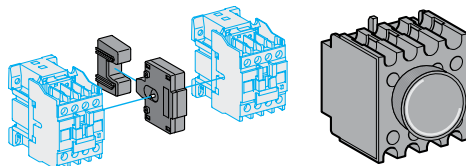

Star-Delta solution

> Easy choice for  
simple applications

# General contents

EasyPact TVS contactors, 6 A to 630 A

A

EasyPact TVS thermal overload relays 0.1 A to 630 A

B

EasyPact TVS control relays 4 NO/NC contacts

C

EasyPact TVS motor protection circuit breaker 0.1A to 32A

D

Coordination between protection and control components

E

# EasyPact TVS



> EasyPact TVS contactors,  
6 A to 630 A



> EasyPact TVS thermal overload relays  
0.1 A to 630 A



> EasyPact TVS control relays  
4 NO/NC contacts



> EasyPact TVS motor protection  
circuit breaker 0.1A to 32A

- > Coordination between protection and control components
- > Glossary, definitions, technical information

Control your motors, Do It Yourself simply your solution:  
direct-on-line starter, reversing starter, star-delta starter

- 3 pole & 4 pole Characteristics ▶ A-1
- Accessories, spare parts ▶ A-17
- Dimensions, mounting ▶ A-26

Footprint for complete compatibility with contactors  
(direct mounting under contactors)

- Characteristics ▶ B-1
- Dimensions, mounting ▶ B-7

Pilot your control circuits

- Characteristics ▶ C-1
- Dimensions, mounting ▶ C-4



- Characteristics ▶ D-1
- References ▶ D-3
- Dimensions, mounting ▶ D-7

Better continuity of service

- What coordination means ▶ E-1
- Glossary ▶ E-5
- Definitions ▶ E-6
- Technical informations ▶ E-7



# EasyPact TVS 3-pole contactors

											
<b>Size</b>		1			2		3				
<b>Rated operational current AC-3</b>	<b>A</b>	6	9	12	18	25	32	38	40	50	65
<b>Rated operational current AC-1</b>	<b>A</b>	20	25		32	36	50		60	70	80
<b>Rated operational power in AC-3</b>	<b>220/230 V</b>	1.1	2.2	3	4	5.5	7.5	9	11	15	18.5
	<b>380/400 V</b>	2.2	4	5.5	7.5	11	15	18.5	18.5	22	30
	<b>415/440 V</b>	2.2	4	5.5	9	11	15	18.5	22	25/30	37
	<b>500 V</b>	3	5.5	7.5	10	15	18.5	18.5	22	30	37
	<b>660/690 V</b>	3	5.5	7.5	10	15	18.5	18.5	30	33	37
<b>Width</b>	<b>mm</b>	45			45.5	56	75				
<b>Coil rated operating voltage</b>		24...440 V AC according to the coil voltage code (see below)									
<b>Auxiliary built in contact</b>		1 NO or 1 NC					1 NO + 1 NC				
<b>References <sup>(1)</sup></b>		<b>LC1E06</b>	<b>LC1E09</b>	<b>LC1E12</b>	<b>LC1E18</b>	<b>LC1E25</b>	<b>LC1E32</b>	<b>LC1E38</b>	<b>LC1E40</b>	<b>LC1E50</b>	<b>LC1E65</b>

(1) Partial, see below.

### Coil voltage code for 3-pole contactors

		24	48	110	220	230	240	380	415	440
<b>LC1E06-300</b>	50 Hz	B5	E5	F5	M5	-	U5	Q5	N5	R5
	60 Hz	B6	-	F6	M6	-	-	Q6	-	R6
<b>LC1E06-95</b>	50/60Hz	B7	E7	F7	M7	P7	-	Q7	-	-
<b>LC1E400-630</b>	50/60Hz	-	E7	F7	M7	-	U7	Q7	N7	-

### Contactors: how to determine the full commercial reference ?

Example:

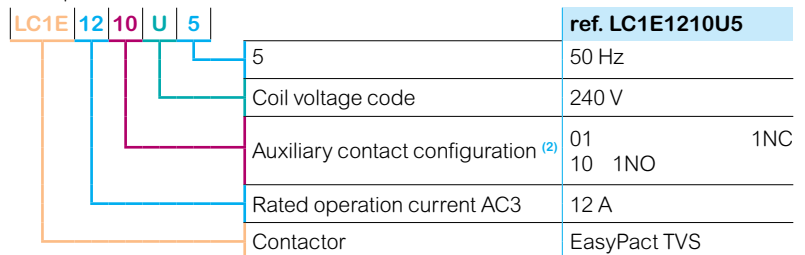

Example 1: you need a 32 A contactor, 1 NC auxiliary contact, 24 V - 50 Hz coil ⇒ **LC1E3201B5**

Example 2: you need a 120 A contactor, 1 NC + NO auxiliary contact, 220 V - 50 Hz coil ⇒ **LC1E120M5**

<sup>(2)</sup> Example up to LC1E38 For details, please consult page A-3.







# from 6 to 630 A

											
4		5 <sup>(3)</sup>		6 <sup>(3)</sup>		7 <sup>(3)</sup>		8 <sup>(3)</sup>		9 <sup>(3)</sup>	
80	95	120	160	200	250	300	400	500	630		
110	120	150	200	250	300	320	500	700	1000		
22	25	37	45	55	75	90	110	147	185		
37	45	55	75	90	132	160	200	250	335		
45	45	59	80	100	140	160/185	220/250	280/295	375/400		
45	55	75	90	110	160	200	257	355	400		
45	45	80	100	110	160	220	280	335	450		
85		120		168.5		213		213		233	309
1 NO + 1 NC				-				-			
LC1E80	LC1E95	LC1E120	LC1E160	LC1E200	LC1E250	LC1E300	LC1E400	LC1E500	LC1E630		

## Common characteristics

> Contactors compatible with:

-  LAEN● auxiliary contact blocks (see page A-20)
-  LAETSD time delay auxiliary contact (from 25 A contactor) (see page A-20)
-  LAERC●● RC switch suppressor (up to 95 A) (see page A-19)
-  LAEM● mechanical interlock (see page A-19)
-  LAEP● set of power connections (up to 95 A) (see page A-19)

## Utilisation categories

- > Class AC-1: AC loads with  $\cos \phi$  at least equal to 0.95 (resistive load, heating, distribution, etc.).
- > Class AC-3: squirrel-cage motors with breaking taking place with the motor running.

<sup>(3)</sup> Color change for 120-630A contactors would come later, please consult your local Schneider Electric office.

# Commercial reference numbering system

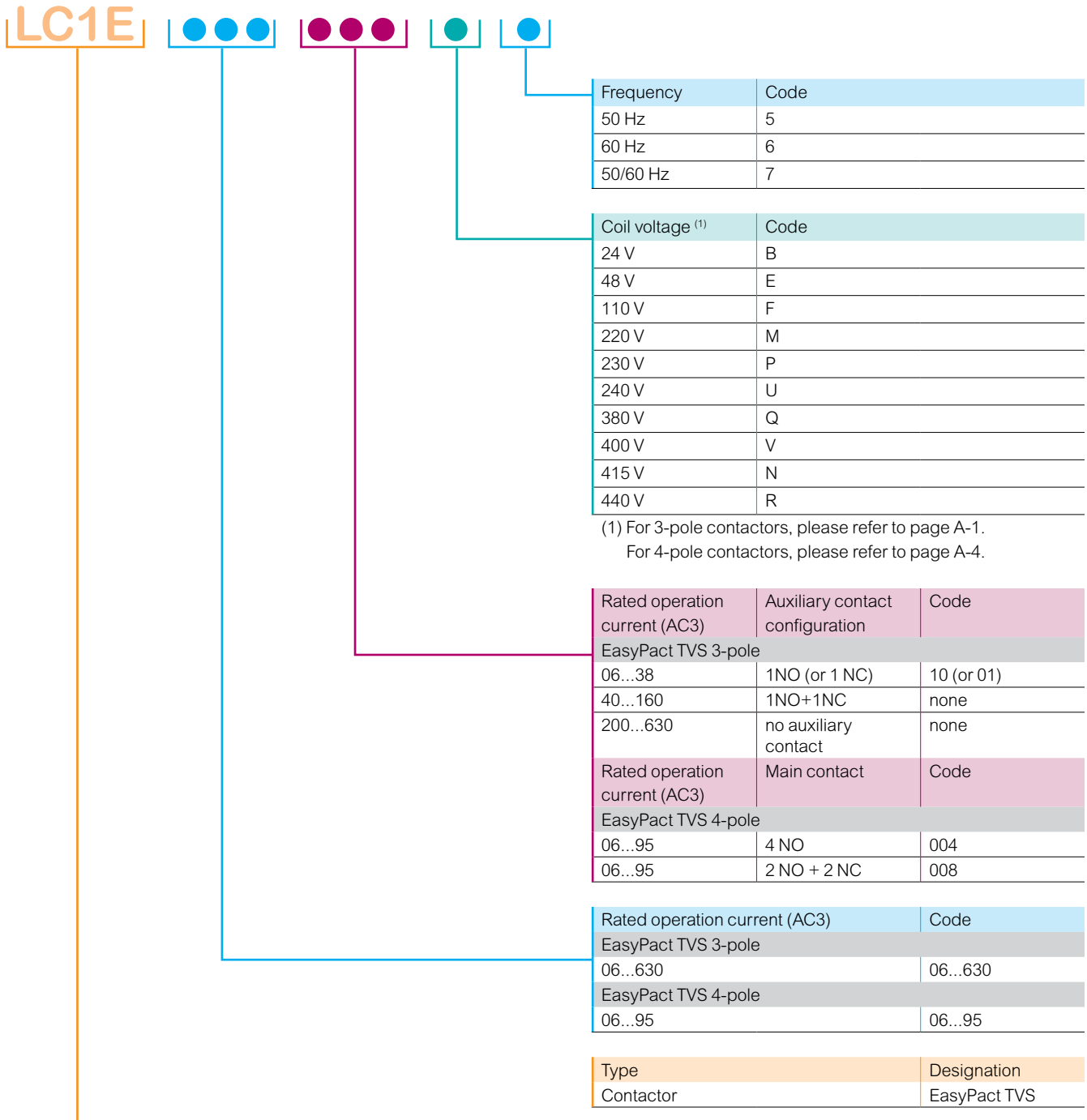





## Contactors: how to determine the full commercial reference ?

Example 1: you need a 32 A contactor, 1 NC auxiliary contact, 24 V - 50 Hz coil ⇒ **LC1E3201B5**

Example 2: you need a 120 A contactor, 1 NC + NO auxiliary contact, 220 V - 50 Hz coil ⇒ **LC1E120M5**

# EasyPact TVS 4-pole contactors from 20 to 125 A

												
<b>Size</b>		1	2	3	4							
<b>Rated operational current AC-3</b>	<b>A</b>	6	9	12	18	25	32	38	40	65	80	95
<b>Rated operational current AC-1</b>	<b>A</b>	20	25	32	40	50	55	60	75	85	110	125
<b>Width</b>	<b>mm</b>	45		56		84.5		95.5				
<b>Coil rated operating voltage</b>	24...415 V AC according to the coil voltage code (see below)											
<b>Auxiliary built in contact</b>	no built in contact											
<b>References <sup>(1)</sup></b>		<b>LC1E06</b>	<b>LC1E09</b>	<b>LC1E12</b>	<b>LC1E18</b>	<b>LC1E25</b>	<b>LC1E32</b>	<b>LC1E38</b>	<b>LC1E40</b>	<b>LC1E65</b>	<b>LC1E80</b>	<b>LC1E95</b>

(1) Partial, see below.

### Coil voltage code for 4-pole contactors

		24	48	110	220	230	240	380	400	415
<b>LC1E06-95</b>	50/60Hz	B7	E7	F7	M7	P7	U7	Q7	V7	N7
					M5WB					N5WB

## Common characteristics

> Contactors compatible with:



LAEN● auxiliary contact blocks (see page A-20)



LAETSD time delay auxiliary contact (from 25 A contactor) (see page A-20)



LAERC●● RC switch suppressor (up to 95 A) (see page A-19)

### Contactors: how to determine the full commercial reference ?

Example:

<b>LC1E</b>	<b>12</b>	<b>004</b>	<b>B</b>	<b>7</b>	<b>IN</b>	<b>ref. LC1E12004B7IN</b>
					IN	-For LC1E06 to LC1E80 -Blank for LC1E95
					7	50/60Hz
					Coil voltage code	24V
					Main Contact	004 4NO 008 2NO+2NC
					Rated operation current AC3	12 A
					Contactors	EasyPact TVS

Example 1: you need a 32 A contactor, 4 NO contact, 24 V - 50/60Hz coil ⇒ **LC1E32004B7IN**

Example 2: you need a 95A contactor, 2NO+2NC contact, 220 V - 50/60Hz coil ⇒ **LC1E95008M7**

# EasyPact TVS 3-pole contactors

## 6 to 630 A

### Power characteristics

Power circuit connections						
Contactor type			LC1E06	LC1E09	LC1E12	LC1E18
Number of poles			3			
Rated operational current (Ie) (Ue ≤ 440 V)	In AC-3 (θ ≤ 55 °C)	<b>A</b>	6	9	12	18
	In AC-3 (θ ≤ 55 °C)					
	In AC-1 (θ ≤ 55 °C)		20	25		32
	In AC-1 (θ ≤ 40 °C)		–			
Rated operational voltage (Ue)	Up to	<b>V</b>	690			
Frequency limits	Of the operational current	<b>Hz</b>	50 or 60			
Conventional thermal current (Ith)	θ ≤ 55 °C	<b>A</b>	20	25		32
	θ ≤ 40 °C		–			
Rated breaking capacity at 440 V	Conforming to IEC 60947	<b>A</b>	48	72	96	144
Rated making capacity at 440 V	Conforming to IEC 60947-4-1	<b>A</b>	60	90	120	180
Permissible short time rating No current flowing for preceding 15 minutes with θ ≤ 40 °C	10 s	<b>A</b>	80	105		145
	1 min		45	61		84
	10 min		20	30		40
Maximum permissive current No current flowing for previous 60 minutes, at θ ≤ 40 °C	For 10 s	<b>A</b>	–			
Protection by fuses against short-circuits (U ≤ 690 V)	Without thermal overload relay gG fuse Type 1	<b>A</b>	12	20	25	35
	With thermal overload relay		For corresponding aM or gG fuse ratings corresponding to the associated LRE● thermal overload relay, please see page B-3			
Average impedance per pole	At Ith and 50 Hz	<b>mΩ</b>	2.5			
Power dissipation per pole for the above operational currents	AC-3	<b>W</b>	0.09	0.20	0.36	0.81
	AC-1		1.0	1.6		2.6
Electrical durability	AC-3 (Ue ≤ 440 V)	<b>Million cycles</b>	1.4			1.2
	AC-1 (Ue ≤ 440 V)		0.15		0.3	
Mechanical durability			10			
Power circuit connections						
Connection maximum c.s.a.						
Flexible cable with cable end	1 conductor	<b>mm<sup>2</sup></b>	1...4			
	2 conductors		1...2.5			
Solid cable without cable end	1 conductor	<b>mm<sup>2</sup></b>	1...4		1.5...6	
	2 conductors		1...4		1.5...6	
Cable with lug		<b>mm</b>	–			
Bar	Number of bars		–			
	Bar	<b>mm x mm</b>	–			
Bolt diameter	1 conductor	<b>mm</b>	–			
Tightening torque	Power circuit connection	<b>N.m</b>	1.2			
Tool			Philips N°2 or Ø6mm flat			



	LC1E25	LC1E32	LC1E38	LC1E40	LC1E50	LC1E65	LC1E80	LC1E95	LC1E120	LC1E160	LC1E200	LC1E250	LC1E300	LC1E400	LC1E500	LC1E630
	25	32	38	40	50	65	80	95	–							
									120	160	200	250	300	400	500	630
	36	50		60	70	80	110	120	–							
									150	200	250	300	320	500	700	1000
														50/60		
	36	50		60	70	80	110	120	–							
									150	200	250	300	320	500	700	1000
	200	256	304	320	400	520	640	760	960	1280	1600	2000	2400	3200	4000	5040
	250	320	380	400	500	650	800	950	1200	1600	2000	2500	3000	4000	5000	6300
	240	260	310	320	400	520	640	800	950	1200	1500	1800	2650	3600	4200	5050
	120	138	150	165	208	260	320	400	550	580	740	850	1300	1700	2400	3400
	50	60		72	84	110	135		250	250	400	440	750	1000	1200	1600
									1100	1400	1500	1800	2200	3600	4200	5050
	40	63		80	100	125	160		250	315			500	630	800	800
									–							
	2.5			1.5		1	0.8		0.6		0.33	0.32	0.3	0.26	0.18	0.12
	1.6	2.0	2.9	2.4	3.8	4.2	5.1	7.2	8.6	15	13	20	27	42	45	48
	3.2	5.0		5.4	7.4	6.4	9.7	12	14	24	21	29	31	65	88	120
		1	0.9						0.8		0.5	0.7	0.5	0.6	0.6	0.6
	0.35								0.25		0.2		0.4	0.25	0.25	0.2
		8		5			3		4		5			4	4	4
	1...6	1...10		2.5...25			4...50		10...120							
	1...4	1.5...6		2.5...10			4...16		10...120 + 10...50							
		1.5...10		2.5...25			4...50		10...120							
		1.5...10		2.5...16			4...25		10...120 + 10...50							
										150	185	240	2 x 150	2 x 240		–
										2						
										3 x 25	4 x 32	5 x 30	30 x 5	40 x 5	60 x 5	
										M8	M10				M12	
	1.5	2.1		5			9		12	18	35				58	
				Ø8mm flat			Ø8mm flat or Allen key n°4		Allen key n°4		Wrench					

# EasyPact TVS 4-pole contactors

## 20 to 125 A, AC1

### Power characteristics

Power circuit connections				LC1E06**IN	LC1E09**IN	LC1E12**IN	LC1E18**IN
<b>Contactors type</b>							
Number of poles			4				
Rated operational current (Ie) (Ue ≤ 415V)	In AC-3 (θ ≤ 60 °C)	<b>A</b>	6	9	12	18	
	In AC-1 (θ ≤ 40 °C)		20	25	32	40	
Rated operational voltage (Ue)			<b>V</b> 690				
Frequency limits		Of the operational current	<b>Hz</b> 50/60				
Conventional thermal current (Ith)		θ ≤ 40 °C	<b>A</b> 20	25	32	40	
Rated breaking capacity at 440 V		Conforming to IEC 60947-4-1	<b>A</b> 48	72	96	144	
Rated making capacity at 440 V		Conforming to IEC 60947-4-1	<b>A</b> 60	90	120	180	
Permissible short time rating No current flowing for preceding 15 minutes with θ ≤ 40 °C	10 s	<b>A</b>	80	105		145	
	1 min		45	61	84		
	10 min		20	30	40		
Protection by fuses against short-circuits (U ≤ 690 V) Type-1	Without thermal overload relay gG fuse	<b>A</b>	12	20	25	35	
	With thermal overload relay		For corresponding aM or gG fuse ratings corresponding to the associated LRE thermal overload relay, please see page B-3				
Average impedance per pole		At Ith and 50 Hz	<b>mΩ</b> 2.5				
Power dissipation per pole for the above operational currents		AC-1	<b>W</b> 1.0	1.6		2.6	
Electrical durability		AC-1 (Ue ≤ 440 V)	<b>Million cycles</b> 0.15		0.27	0.21	
Mechanical durability			10				

Power circuit connections				Connection maximum c.s.a.			
Flexible cable with cable end	1 conductor	<b>mm<sup>2</sup></b>	1...4				
	2 conductors		1...2.5				
Solid cable without cable end	1 conductor	<b>mm<sup>2</sup></b>	1...6			1.5...6	
	2 conductors		1...4			1.5...6	
Cable with lug		<b>mm</b>	-				
Bar	Number of bars		-				
	Bar	<b>mm x mm</b>	-				
Bolt diameter		1 conductor	<b>mm</b> -				
Tightening torque		Power circuit connection	<b>N.m</b> 1.2			1.5	
Tool			Phillips N°2 or Ø6mm flat				

	LC1E25**IN	LC1E32**IN	LC1E38**IN	LC1E40**IN	LC1E65**IN	LC1E80**IN	LC1E95
	25	32	38	40	65	80	95
	50	55	60	75	85	110	125
	50	55	60	75	85	110	125
	200	256	304	320	520	640	760
	250	320	380	400	650	800	950
	240	260	310	320	520	640	800
	120	138	150	165	260	320	400
	50	60		72	110	135	
	40	63		80	125	160	
	2.5			1.5	1	0.8	
	3.2	5.0	5.4	5.4	6.4	9.7	12
	0.35						
		8		5		3	
	1...10			2.5...25		4...50	
	1...6			2.5...10		4...16	
	1.5...10			2.5...25		4...50	
	1.5...10			2.5...16		4...50	
	1.7	2.1		5		9	
				Ø8mm flat		Ø8mm flat or Allen key n°4	

# EasyPact TVS 3-pole contactors

6 to 630 A

Control circuit: coil characteristics

Built in auxiliary contact

## Control circuit: coil characteristics with a.c. supply

Contactor type		LC1E06	LC1E09	LC1E12	LC1E18
Rated control circuit voltage (Uc) 50/60 Hz	<b>V</b>	24...440 according coil voltage code			
Control voltage limits ( $\theta \leq 55^\circ\text{C}$ )					
50 Hz or 60 Hz coils Operational		0.85...1.1 Uc			
Drop-out		0.3...0.6 Uc			
Average consumption at 20°C and at Uc					
~ 50 Hz coils Inrush	<b>VA</b>	95			
cos $\phi$		0.75			
Sealed coil	<b>VA</b>	8.5			
cos $\phi$		0.3			
~ 60 Hz coils Inrush	<b>VA</b>	95			
cos $\phi$		0.75			
Sealed coil	<b>VA</b>	8.5			
cos $\phi$		0.3			
Heat dissipation	<b>W</b>	2...3			
Operating time Closing "C"	<b>ms</b>	12...22			
Opening "O"		4...19			
Maximum operating rate at ambient temperature $\leq 60^\circ\text{C}$	<b>In operating cycles per hour</b>	1800			
Maximum operating rate at ambient temperature $\leq 55^\circ\text{C}$					

## Control circuit connections

### Connection maximum c.s.a.

Flexible cable1 or 2 conductors without cable end	<b>mm<sup>2</sup></b>	1...4
Flexible cable with1 conductor cable end	<b>mm<sup>2</sup></b>	1...4
2 conductors		1...2.5
Solid cable without1 or 2 conductors cable end	<b>mm<sup>2</sup></b>	1...4
Tightening torque	<b>N.m</b>	1.2
Screwdriver		Philips N° 2 - Ø6 mm flat

## Built in auxiliary contact

Contacts conforming to IEC 60947-5-1		LC1E06...E38: contactor's own 1NO or 1NC LC1E40...E160: contactor's own 1NO and 1NC
Rated operational voltage (Ue) Up to	<b>V</b>	690
Rated insulation voltage (Ui) Conforming to IEC 60947-1		690
Conventional thermal current (Ith) Ambient air temperature $\leq 60^\circ\text{C}$	<b>A</b>	10
Operating current frequency	<b>Hz</b>	50 or 60
Minimum switching capacity U min	<b>V</b>	17
$\lambda = 10^{-8}$ I min	<b>mA</b>	5
Short-circuit protection Conforming to IEC 60947-5-1		gG fuse: 10 A
Raked making capacity Conforming to IEC 60947-5-1	<b>A</b>	~: 140
Short-time rating Permissible for 1 s	<b>A</b>	100
500 ms		120
100 ms		140
Insulation resistance	<b>MΩ</b>	>10
Non-overlap time Guaranteed between N/C and N/O contacts	<b>ms</b>	1.5 on energisation and on de-energisation



LC1E25	LC1E32	LC1E38	LC1E40	LC1E50	LC1E65	LC1E80	LC1E95	LC1E120	LC1E160	LC1E200	LC1E250	LC1E300	LC1E400	LC1E500	LC1E630
								24...440 according coil voltage code							
								0.85...1.1 Uc							
								0.35...0.55 Uc				0.3...0.5 Uc		0.25...0.5Uc	
95		160		200		300		805		650		1075	1100	1650	
						0.8	0.9	0.3	0.9	0.9	0.9	0.9	0.9	0.9	
8.3		15		20		22		55		10		15	18	22	
						0.3	0.9	0.3	0.9	0.9	0.9	0.9	0.9	0.9	
95		140		220		300		970		650		1075	1100	1650	
						0.8	0.9	0.3	0.9	0.9	0.9	0.9	0.9	0.9	
8.3		13		22		22		66		10		15	18	22	
							0.9	0.3	0.9	0.9	0.9	0.9	0.9	0.9	
		6...10				3...8		18...24		8		14	18	20	
		20...26		20...35		20...50		20...35		40...65		40...75		40...80	
		8...12		6...20		6...20		7...15		100...170		100...170		100...200	
		1200				1200						2400		1200	
								1...2.5	1...4		1...4	1...4	1...4		
								1...2.5			1...4	1...4	1...4		
											1...2.5	1...2.5	1...2.5		
								1...2.5	1...4		1...4	1...4	1...4		
		1.2				1.2					1.2	1.2	1.2		
												50/60			

# EasyPact TVS contactors

## 6 to 630 A

### Wide Band Coil

EasyPact TVS Contactor: Wide Band Coil				
Contactor Type	LC1E06	LC1E09	LC1E12	LC1E18
No. of Power Poles	3			
Rated Control Circuit Voltage (VAC) at 50Hz	220 & 415	220 & 415	220 & 415	220 & 415
Coil Operating Band	65% to 120%	65% to 120%	65% to 120%	65% to 120%
Contactor Type	LC1E0600	LC1E0900	LC1E1200	LC1E1800
No. of Power Poles	4			
Rated Control Circuit Voltage (VAC) at 50Hz	220 & 415	220 & 415	220 & 415	220 & 415
Coil Operating Band	70% to 125%	70% to 125%	70% to 125%	70% to 125%

LC1E25	LC1E32	LC1E38	LC1E40B				
220 & 415	220 & 415	220 & 415	220 & 415				
70% to 120%	70% to 120%	70% to 120%	70% to 120%				
LC1E2500	LC1E3200	LC1E3800	LC1E4000	LC1E6500	LC1E8000	LC1E9500	
220 & 415	220 & 415	220 & 415	220 & 415	220 & 415	220 & 415	220 & 415	
70% to 125%	70% to 125%	70% to 125%	70% to 125%	70% to 125%	70% to 125%	70% to 125%	

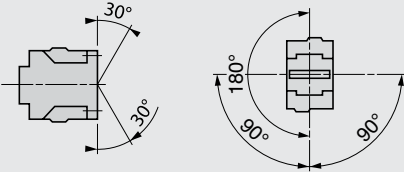
Environment				
Contactor type			LC1E06...E18	LC1E25...E38
Rated insulation voltage (Ui)	Conforming to IEC 60947-4-1, overvoltage category III, degree of pollution: 3	<b>V</b>	690	
Rated impulse withstand voltage (Uimp)	Conforming to IEC 60947	<b>kV</b>	6	
Conforming to standards			IEC 60947-4-1, IEC 60947-5-1	
Product certifications			EAC, CE	
Degree of protection (front face only)	Conforming to IEC 60529		Protection against direct finger contact IP2X	
Protective treatment	Conforming to IEC 60068-2-30		IEC60068-2-30 Test Db, Variant 2	
Ambiant air temperature around the device	Storage	<b>°C</b>	-60...+80	
	Operation		-5...+55	
	Permissible at UC <sup>(1)</sup>		-20...+70	
Maximum operating altitude	Without derating	<b>m</b>	3000	
Operating positions	Without derating		±30° in relation to normal vertical mounting plane	
				
Flame resistance	Conforming to IEC 60695-2-1	<b>°C</b>	850	
Shock resistance <sup>(2)</sup>	Contactor open		7 gn	6 gn
1/2 sinewave = 11 ms	Contactor closed		10 gn	
Vibration resistance <sup>(2)</sup>	Contactor open		1.5 gn	
	Contactor closed		3 gn	

(1) Derating see page E-4.

(2) Without change of contact states, in the most unfavorable direction (coil energised at Ue).

## Installation recommendations



### Avoid fire, product damage or power loss with a safe enclosure

Severe conditions such as dust, humidity, high temperature can result in people or equipments exposed to serious risks if the suitable protection of the electrical components is not taken.

#### Spacial CRN steel enclosures is one of our solutions

A complete offer with 39 dimensions from 200 x 200 x 150 mm to 1000 x 800 x 300 mm:

- with plain door, without plain mounting plate
- with plain door and plain mounting plate
- with glazed door, without plain mounting plate.
  
- Degree of protection IP 66.
- Compliance with standard IEC 62208.
- A wide range of accessories to fit to all your applications.

#### Spacial CRN, suitable for any application

Indoors with harsh and dirty environments like machines, manufacturing plants, and logistic centers.

Specific optional devices re-enforce the protection: fans, filters.



LC1E40... E65	LC1E80... E95	LC1E120... E160	LC1E200...E300	LC1E400	LC1E500	LC1E630
			8			
			IEC 60947-4-1			
			IP00			
			-			
				6gn	9gn	6gn
7 gn				15gn		
				1.5gn	2gn	
				5gn	4gn	

### Environment

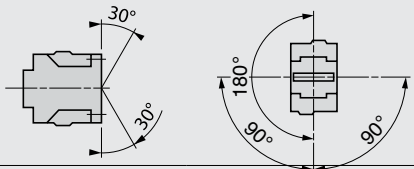
Contactor type			LC1E06...E18**IN	LC1E25...E38**IN
Rated insulation voltage (Ui)	Conforming to IEC 60947-4-1, overvoltage category III, degree of pollution: 3	V	690	
Rated impulse withstand voltage (Uimp)	Conforming to IEC 60947	kV	6	
Conforming to standards			IEC 60947-4-1, IEC 60947-5-1	
Product certifications			EAC, CE	
Degree of protection (front face only)	Conforming to IEC 60529		Protection against direct finger contact IP2X	
Protective treatment	Conforming to IEC 60068-2-30		IEC60068-2-30 Test Db, Variant 2	
Ambiant air temperature around the device	Storage	°C	-60...+80	
	Operation		-5...+55	
	Permissible at UC <sup>(1)</sup>		-20...+70	
Maximum operating altitude	Without derating	m	3000	
Operating positions	Without derating		±30° in relation to normal vertical mounting plane	
				
Flame resistance	Conforming to IEC 60695-2-1	°C	850	
Shock resistance <sup>(2)</sup> 1/2 sinewave = 11 ms	Contactor open		7 gn	6 gn
	Contactor closed		10 gn	
Vibration resistance <sup>(2)</sup> 5...300 Hz	Contactor open		1.5 gn	
	Contactor closed		3 gn	

(1) Derating see page E-4.

(2) Without change of contact states, in the most unfavorable direction (coil energised at Ue).

### Installation recommendations



#### Avoid fire, product damage or power loss with a safe enclosure

Severe conditions such as dust, humidity, high temperature can result in people or equipments exposed to serious risks if the suitable protection of the electrical components is not taken.

#### Spacial CRN steel enclosures is one of our solutions

A complete offer with 39 dimensions from 200 x 200 x 150 mm to 1000 x 800 x 300 mm:

- with plain door, without plain mounting plate
- with plain door and plain mounting plate
- with glazed door, without plain mounting plate.
  
- Degree of protection IP 66.
- Compliance with standard IEC 62208.
- A wide range of accessories to fit to all your applications.

#### Spacial CRN, suitable for any application

Indoors with harsh and dirty environments like machines, manufacturing plants, and logistic centers.

Specific optional devices re-enforce the protection: fans, filters.

LC1E40...E65\*\*IN

LC1E80\*\*IN...LC1E95

7 gn

# EasyPact TVS 3-pole contactors

EasyPact TVS contactors for motor control up to 335 kW at 400 V, in category AC-3



3-pole contactors						Rated operational current at 440V (AC-3) up to	Instantaneous auxiliary contacts		Basic reference, to be completed by adding the control voltage code	Weight
Standard power ratings of 3-phase motors 50/60 Hz in category AC-3					A					
220 V	380 V	415V	660V		kW	A				
230 V	400 V	440V	500 V	690 V						
kW	kW	kW	kW	kW	Connection by screw clamp terminals					
1.1	2.2	2.2	3	3	6	1	0	LC1E0610●●	0.300	
1.1	2.2	2.2	3	3	6	0	1	LC1E0601●●	0.300	
2.2	4	4	5.5	5.5	9	1	0	LC1E0910●●	0.300	
2.2	4	4	5.5	5.5	9	0	1	LC1E0901●●	0.300	
3	5.5	5.5	7.5	7.5	12	1	0	LC1E1210●●	0.300	
3	5.5	5.5	7.5	7.5	12	0	1	LC1E1201●●	0.300	
4	7.5	9	10	10	18	1	0	LC1E1810●●	0.300	
4	7.5	9	10	10	18	0	1	LC1E1801●●	0.300	
5.5	11	11	15	15	25	1	0	LC1E2510●●	0.360	
5.5	11	11	15	15	25	0	1	LC1E2501●●	0.360	
7.5	15	15	18.5	18.5	32	1	0	LC1E3210●●	0.450	
7.5	15	15	18.5	18.5	32	0	1	LC1E3201●●	0.450	
9	18.5	18.5	18.5	18.5	38	1	0	LC1E3810●●	0.450	
9	18.5	18.5	18.5	18.5	38	0	1	LC1E3801●●	0.450	
11	18.5	22	22	30	40	1	1	LC1E40●●	0.980	
15	22	25/30	30	33	50	1	1	LC1E50●●	0.980	
18.5	30	37	37	37	65	1	1	LC1E65●●	0.980	
22	37	45	45	45	80	1	1	LC1E80●●	1.520	
25	45	45	55	45	95	1	1	LC1E95●●	1.520	
37	55	59	75	80	120	1	1	LC1E120●●	2.300	
45	75	80	90	100	160	1	1	LC1E160●●	2.300	
Connection by bars										
55	90	100	110	110	200	0	0	LC1E200●●	4.600	
75	132	140	160	160	250	0	0	LC1E250●●	4.700	
90	160	160/185	200	220	300	0	0	LC1E300●●	8.500	
110	200	220/250	257	280	400	0	0	LC1E400●●	9.1	
147	250	280/295	355	335	500	0	0	LC1E500●●	11.35	
185	335	375/400	400	450	630	0	0	LC1E630●●	18.6	

### Coil voltage code for 3-pole contactors

		24	48	110	220	230	240	380	415	440
LC1E06-300	50 Hz	B5	E5	F5	M5	-	U5	Q5	N5	R5
	60 Hz	B6	-	F6	M6	-	-	Q6	-	R6
LC1E06-95	50/60Hz	B7	E7	F7	M7	P7	-	Q7	-	-
LC1E400-630	50/60Hz	-	E7	F7	M7	-	U7	Q7	N7	R7

### Separate components

Auxiliary contact blocks, add-on modules and accessories, see pages A-20 to A-21.

### Coil spare parts

For maintenance, each coil can be ordered separately, see page A-22 to A-26.

<sup>(1)</sup> LC1E06 to E65: clip-on mounting on 35 mm rail AM1 DP or screw fixing.  
 LC1E80 to E95: clip-on mounting on 35 mm rail AM1DP or 75 mm 5 rail AM1 DL or screw fixing.  
 LC1E120 and E160: clip-on mounting on 2 x 35 mm rail AM1 DP or screw fixing.

# EasyPact TVS 4-pole contactors

EasyPact TVS contactors for motor control in category AC-1, 20 to 125A



4-pole contactors				
Non inductive loads maximum current (at 40°C) utilisation category AC-1	number of poles		Basic reference, to be completed by adding the control voltage code(1)	weight (3)
20	4	-	LC1E06004●●IN	0.34
	2	2	LC1E06008●●IN	0.34
25	4	-	LC1E09004●●IN	0.34
	2	2	LC1E09008●●IN	0.34
32	4	-	LC1E12004●●IN	0.34
	2	2	LC1E12008●●IN	0.34
40	4	-	LC1E18004●●IN	0.34
	2	2	LC1E18008●●IN	0.34
50	4	-	LC1E25004●●IN	0.52
	2	2	LC1E25008●●IN	0.52
55	4	-	LC1E32004●●IN	0.52
	2	2	LC1E32008●●IN	0.52
60	4	-	LC1E38004●●IN	0.52
	2	2	LC1E38008●●IN	0.52
75	4	-	LC1E40004●●IN	1.30
	2	2	LC1E40008●●IN	1.30
85	4	-	LC1E65004●●IN	1.30
	2	2	LC1E65008●●IN	1.30
110	4	-	LC1E80004●●IN	1.60
	2	2	LC1E80008●●IN	1.60
125	4	-	LC1E95004●●	1.60
	2	2	LC1E95008●●	1.60

Control voltage code										
	Volts	24	48	110	220	230	240	380	400	415
LC1E06-95	50/60 Hz	B7	E7	F7	M7	P7	U7	Q7	V7	N7
		M5WB						N5WB		

### Separate components

Auxiliary contact blocks, add-on modules and accessories, see pages A-20 to A-21.

### Coil spare parts

For maintenance, each coil can be ordered separately, please check with schneider electric.

(1) LC1E06 to E38: clip-on mounting on 35 mm rail AM1 DP or screw fixing.  
LC1E40 to E95: clip-on mounting on 35 mm rail AM1DP or 75 mm rail AM1 DL or screw fixing.

# EasyPact TVS contactors

## 3-pole/4-pole Accessories for LC1E contactor

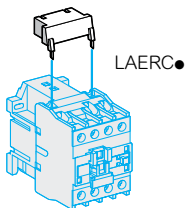
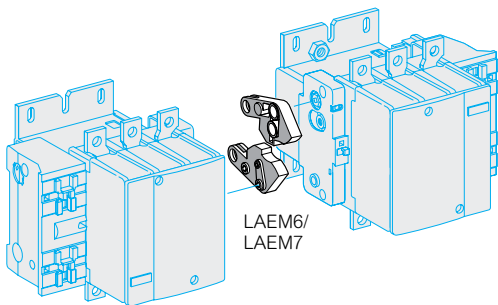
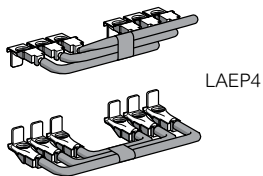
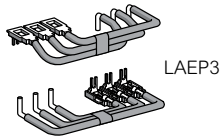
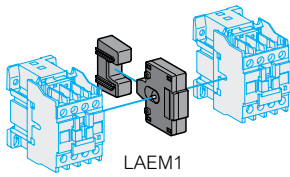

LC1E●●

### 3-pole accessories for LC1E contactor

#### Accessories for motor reverse assembly

Contactors with screw clamp terminals				
Using 2 identical contactors	Set of power connections		Mechanical interlock	
	Cat. no.	Weight kg	Cat. no.	Weight kg
<b>Mechanical interlock</b>				
LC1E06...E12	LAEP1	0.020	LAEM1	0.030
LC1E18/E25	LAEP12	0.026	LAEM1	0.030
LC1E32/E38	LAEP2	0.040	LAEM1	0.030
LC1E40...E65	LAEP3	0.230	LAEM1	0.030
LC1E80/E95	LAEP4	0.465	LAEM4	0.095
LC1E120/E160	– (DIY) <sup>(1)</sup>		LAEM5	0.300
LC1E200/E250	– (DIY) <sup>(1)</sup>		LAEM6	0.110
LC1E300	– (DIY) <sup>(1)</sup>		LAEM7	0.250
LC1E400	– (DIY) <sup>(1)</sup>		LAEM7	0.250
LC1E500	– (DIY) <sup>(1)</sup>		LAEM7	0.250
LC1E630	– (DIY) <sup>(1)</sup>		LAEM8	0.270

(1) DIY : Do It Yourself.

### 4-pole accessories for LC1E contactor

#### Accessories for motor reverse assembly

Contactors with screw clamp terminals		
Using 2 identical contactors	Mechanical interlock	
	Cat. no.	Weight kg
<b>Mechanical interlock</b>		
LC1E06...E12	LAEM1	0.030
LC1E18/E25	LAEM1	0.030
LC1E32/E38	LAEM1	0.030
LC1E40...E65	LAEM4	0.030
LC1E80/E95	LAEM4	0.095

#### RC surge suppressor

- Effective protection for circuits highly sensitive to "high frequency" interference and transient generated when the contactor coil is switched off. For use only in cases where the voltage is virtually sinusoidal, i.e. less than 5 % total harmonic distortion.
- Voltage limited to 3 Uc max. and oscillating frequency limited to 400 Hz max.
- Slight increase in drop-out time (1.2 to 2 times the normal time).

Mounting	For use with contactor		Cat. no.	Weight kg
	Rating	Type		
Screw mounting	LC1E06...E95	V~		
		24...48	LAERCE	0.025
		50...127	LAERCG	0.025
		110...240	LAERCU	0.025
		380...415	LAERCN	0.025



LAEN22



LAETSD

### Instantaneous auxiliary contact blocks for connection by screw lamps terminals

For use in normal operating environment

Clip-on mounting	Number of contacts per block	Cat. no.	Weight kg
Front	1 NO / 1 NC	LAEN11	0.035
	2 NO	LAEN20	0.035
	2 NC	LAEN02	0.035
	2 NO / 2 NC	LAEN22	0.060

### Time delay auxiliary contact blocks for connection by screw clamp terminals 8 A - 690 V

Clip-on mounting	Number of contacts per block	Time delay Type	Setting range	Cat. no. <sup>(1)</sup>	Weight kg
Front	1 NO / 1 NC	On-delay	1...30 s	LAETSD	0.060

(1) For use only LC1E25 to LC1E630.

### Instantaneous and time delay contact characteristics

Contact block type		LAEN11, 20, 02, 22	LAETSD				
Number of contacts		2 or 4	2				
Rated operational voltage (Ue)	Up to	<b>V</b> 690					
Rated insulation voltage (Ui)	Conforming to IEC 60947-5-1	690					
Conventional thermal current (Ith)	For ambient temperature $\theta \leq 60^\circ\text{C}$	<b>A</b> 10					
Minimum switching capacity	U min	<b>V</b> 17					
	I min	<b>mA</b> 5					
Short-circuit protection	Conforming to IEC 60947-5-1	<b>A</b> 10					
Rated making capacity	Conforming to IEC 60947-5-1	<b>I<sub>rms</sub></b> $\sim 140$					
Short-time rating	Permissible for	<b>A</b> 100					
		500 ms	120				
		100 ms	140				
Insulation resistance		<b>mΩ</b> > 10					
Non-overlap time	Guaranteed between NC and NO contacts	<b>ms</b> 1.5 (on energisation and on de-energisation)					
Overlap time	Guaranteed between LAE N22 N/C and N/O contacts	<b>ms</b> –					
Time delay	Ambient air temperature for operation	<b>°C</b> –	-20...+70				
	Repeat accuracy	–	±2 %				
	Drift up to 0.5 million operating cycles	–	+15 %				
	Drift depending on ambient air temperature	–	0.25 % per °C				
Mechanical durability		<b>In millions of operating cycles</b> 10	4				
Rated operational power of contacts (Conforming to IEC 60947-5-1)	a.c. supply categories AC14/15	<b>V</b> 24	48	115	230	400	440
	1 million operating cycles	<b>VA</b> 60	120	280	560	960	1050
	3 million operating cycles	16	32	80	160	280	300
	10 million operating cycles	4	8	20	4	70	80



Environment			LAEN11, 20, 02, 22	LAETSD
Contact block type			LAEN11, 20, 02, 22	LAETSD
Conforming to standard			IEC 60947-5-1	
Product certifications			EAC	
Protective treatment	Conforming to IEC 60068		"TH"	
Degree of protection	Conforming to IEC 60529		IP2X	
Ambiant air temperature	Storage	°C	-60...+80	
	Operation		-5...+55	
	Permissible for operation at U <sub>c</sub>		-20...+70	
Maximum operating altitude	Without derating	m	3000	
Connection by cable	Philips N° 2 and Ø 6 mm. Flexible or solid cable with or without cable end	mm <sup>2</sup>	Min: 1 x 1 Max: 2 x 2.5	
Tightening torque		N.m	1.2	

3-pole Accessories compatibility						
Contactor	Built in contacts	LAEN●●	LAETSD	LAERC●	LAEM	LAEP●
LC1E06	1 NO or 1NC	1	-	-	-	-
LC1E09						
LC1E12						
LC1E18						
LC1E25	1 NO + 1NC	1	or 1	1	1	1
LC1E32						
LC1E38						
LC1E40						
LC1E65						
LC1E80						
LC1E95	-	-	-	-	-	-
LC1E120						
LC1E160						
LC1E200						
LC1E250	-	2	or 0	-	-	DIY <sup>(1)</sup>
LC1E300						
LC1E400						
LC1E500						
LC1E630						

(1) Do It Yourself.

4-pole Accessories compatibility			
Contactor	LAEN●●	LAETSD	LAERC●
LC1E06	1	or 1	1
LC1E09			
LC1E12			
LC1E18			
LC1E25			
LC1E32			
LC1E38			
LC1E40			
LC1E50			
LC1E65			
LC1E80			
LC1E95			

# EasyPact TVS 3-poles contactors

## Coil replacement for EasyPact TVS, LC1E06 to E38

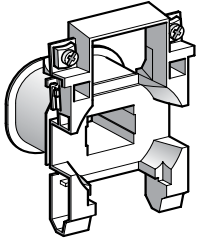

LAEX12●●

### For 3-pole contactors LC1E06...E25

#### Specifications

Average consumption at 20 °C:

■ inrush ( $\cos \varphi = 0.75$ ) 50 Hz: 70 VA; 60 Hz: 70 VA

■ sealed ( $\cos \varphi = 0.3$ ) 50 Hz: 7 VA; 60 Hz: 7.5 VA

Operating range ( $\theta \leq 55 \text{ °C}$ ): 0.85...1.1 Uc.

Control circuit voltage Uc	Average resistance at 20 °C ±10 %	Inductance of closed circuit	Cat. no. <sup>(1)</sup>	Average resistance at 20 °C ±10 %		Cat. no. <sup>(1)</sup>	Average resistance at 20 °C ±10 %		Cat. no. <sup>(1)</sup>	Weight
				Ω	H		Ω	H		
V	Ω	H	50 Hz	Ω	H	60 Hz	Ω	H	50/60 Hz	kg
24	5.37	0.21	LAEX12B5	5.37	0.18	LAEX12B6	5.2	0.17	LAEX12B7	0.067
48	21.7	0.84	LAEX12E5	-	-	-	21.0	0.68	LAEX12E7	0.067
110	124	4.41	LAEX12F5	124	3.68	LAEX12F6	117.1	3.80	LAEX12F7	0.067
220	515	17.6	LAEX12M5	516	14.7	LAEX12M6	507.5	16.48	LAEX12M7	0.067
240	562	21.0	LAEX12U5	-	-	-	-	-	-	0.067
380	1550	52.6	LAEX12Q5	1550	43.8	LAEX12Q6	1397.4	45.38	LAEX12Q7	0.067
415	1690	62.8	LAEX12N5	-	-	-	-	-	-	0.067
440	1990	70.6	LAEX12R5	1990	58.9	LAEX12R6	-	-	-	0.067

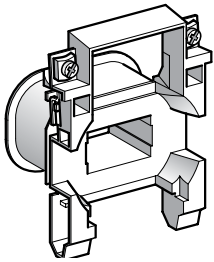

LAEX2●●

### For 3-pole contactors LC1E32/E38

#### Specifications

Average consumption at 20 °C:

■ inrush ( $\cos \varphi = 0.75$ ) 50 Hz: 70 VA; 60 Hz: 70 VA

■ sealed ( $\cos \varphi = 0.3$ ) 50 Hz: 7 VA; 60 Hz: 7.5 VA

Operating range ( $\theta \leq 55 \text{ °C}$ ): 0.85...1.1 Uc.

Control circuit voltage Uc	Average resistance at 20 °C ±10 %	Inductance of closed circuit	Cat. no. <sup>(1)</sup>	Average resistance at 20 °C ±10 %		Cat. no. <sup>(1)</sup>	Average resistance at 20 °C ±10 %		Cat. no. <sup>(1)</sup>	Weight
				Ω	H		Ω	H		
V	Ω	H	50 Hz	Ω	H	60 Hz	Ω	H	50/60 Hz	kg
24	5.37	0.21	LAEX2B5	5.37	0.18	LAEX2B6	5.2	0.18	LAEX2B7	0.073
48	21.7	0.84	LAEX2E5	-	-	-	21.1	0.73	LAEX2E7	0.073
110	124	4.41	LAEX2F5	124	3.68	LAEX2F6	117.0	4.07	LAEX2F7	0.073
220	515	17.6	LAEX2M5	516	14.7	LAEX2M6	509.7	17.72	LAEX2M7	0.073
240	562	21.0	LAEX2U5	-	-	-	-	-	-	0.073
380	1550	52.6	LAEX2Q5	1550	43.8	LAEX2Q6	1536.1	53.40	LAEX2Q7	0.073
415	1690	62.8	LAEX2N5	-	-	-	-	-	-	0.073
440	1990	70.6	LAEX2R5	1990	58.9	LAEX2R6	-	-	-	0.073

(1) The last two digits in the reference represent the voltage code.

# EasyPact TVS 3-poles contactors

## Coil replacement for EasyPact TVS, LC1E40 to E95

### For 3-pole contactors LC1E40...E65

#### Specifications

Average consumption at 20 °C:  
 ■ inrush (cos φ = 0.75): 50 Hz: 160 VA; 60 Hz: 140 VA  
 ■ sealed (cos φ = 0.3) 50 Hz: 15 VA; 60 Hz: 13 VA  
 Operating range (θ ≤ 60 °C): 0.85...1.1 Uc

Control circuit voltage Uc	Average resistance at 20 °C ±10 %	Inductance of closed circuit	Cat. no. <sup>(1)</sup>	Average resistance at 20 °C ±10 %	Inductance of closed circuit	Cat. no. <sup>(1)</sup>	Average resistance at 20 °C ±10 %	Inductance of closed circuit	Cat. no. <sup>(1)</sup>	Weight
V	Ω	H	50 Hz	Ω	H	60 Hz	Ω	H	50/60 Hz	kg
24	1.98	0.12	LAEX3B5	1.98	0.10	LAEX3B6	1.9	0.11	LAEX3B7	0.110
48	7.97	0.48	LAEX3E5	-	-	-	7.7	0.43	LAEX3E7	0.110
110	42.3	2.51	LAEX3F5	42.3	2.09	LAEX3F6	34.4	1.93	LAEX3F7	0.110
220	182	10.0	LAEX3M5	182	8.36	LAEX3M6	153.9	8.64	LAEX3M7	0.110
240	202	12.0	LAEX3U5	-	-	-	-	-	-	0.110
380	512	30.3	LAEX3Q5	512	25.3	LAEX3Q6	425.8	23.89	LAEX3Q7	0.110
415	635	35.8	LAEX3N5	-	-	-	-	-	-	0.110
440	682	40.1	LAEX3R5	682	33.4	LAEX3R6	-	-	-	0.110

### For 3-pole contactors LC1E80/E95

#### Specifications

Average consumption at 20 °C:  
 ■ inrush (cos φ = 0.75) 50 Hz: 200 VA; 60 Hz: 220 VA  
 ■ sealed (cos φ = 0.3) 50 Hz: 20 VA; 60 Hz: 22 VA  
 Operating range (θ ≤ 55 °C): 0.85...1.1 Uc.

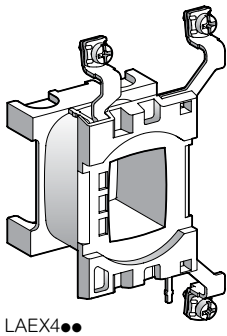

Control circuit voltage Uc	Average resistance at 20 °C ±10 %	Inductance of closed circuit	Cat. no. <sup>(1)</sup>	Average resistance at 20 °C ±10 %	Inductance of closed circuit	Cat. no. <sup>(1)</sup>	Average resistance at 20 °C ±10 %	Inductance of closed circuit	Cat. no. <sup>(1)</sup>	Weight
V	Ω	H	50 Hz	Ω	H	60 Hz	Ω	H	50/60 Hz	kg
24	1.4	0.09	LAEX4B5	1.05	0.04	LAEX4B6	1.2	0.09	LAEX4B7	0.145
48	5.5	0.35	LAEX4E5	-	-	-	4.3	0.36	LAEX4E7	0.145
110	31.0	1.90	LAEX4F5	22.0	0.90	LAEX4F6	24.0	1.92	LAEX4F7	0.145
220	127	7.50	LAEX4M5	98	3.80	LAEX4M6	95.0	7.29	LAEX4M7	0.145
240	152	5.4	LAEX4U5	-	-	-	-	-	-	0.145
380	381	14.11	LAEX4Q5	300	12.17	LAEX4Q6	298.6	23.47	LAEX4Q7	0.145
415	463	16.6	LAEX4N5	-	-	-	-	-	-	0.145
440	513	18.4	LAEX4R5	392	14.3	LAEX4R6	-	-	-	0.145

# EasyPact TVS 3-poles contactors

## Coil replacement for EasyPact TVS, LC1E120 to E160

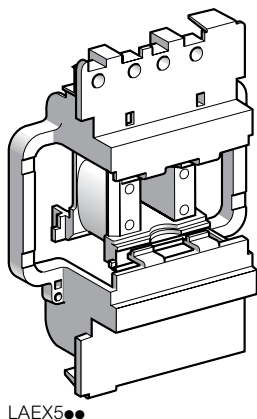

### For 3-pole contactors LC1E120/E160

#### Specifications

Average consumption at 20 °C:

■ inrush (cos φ = 0.8) 50 Hz: 300 VA

■ sealed (cos φ = 0.8) 50 Hz: 22 VA

Operating range (θ ≤ 55 °C): 0.85...1.1 Uc.

Control circuit voltage Uc	Average resistance at 20 °C ±10 %	Inductance of closed circuit	Cat. no. <sup>(1)</sup>	Average resistance at 20 °C ±10 %	Inductance of closed circuit	Cat. no. <sup>(1)</sup>	Weight
V	Ω	H	50 Hz	Ω	H	60 Hz	kg
24	1.24	0.09	LAEX5B5	0.87	0.07	LAEX5B6	0.210
48	4.51	0.36	LAEX5E5	-	-	-	0.210
110	26.5	2.00	LAEX5F5	20.0	1.45	LAEX5F6	0.210
220	105	7.65	LAEX5M5	79.6	5.69	LAEX5M6	0.210
240	125	8.89	LAEX5U5	-	-	-	0.210
380	339	22.3	LAEX5Q5	243	17.0	LAEX5Q6	0.210
415	368	27.7	LAEX5N5	-	-	-	0.210
440	442	30.3	LAEX5R5	339	22.3	LAEX5R6	0.210

(1) The last two digits in the reference represent the voltage code.

# EasyPact TVS 3-poles contactors

## Coil replacement for EasyPact TVS, LC1E200 to E300

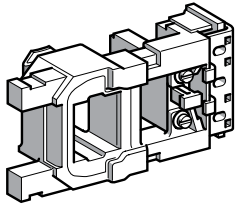

LAEX6●●

### For 3-pole contactors LC1E200...E250

#### Specifications

Average consumption at 20 °C:  
 ■ inrush (cos φ = 0.9) 50 Hz: 805 VA; 60 Hz: 970 VA  
 ■ sealed (cos φ = 0.3) 50 Hz: 55 VA; 60 Hz: 66 VA  
 Heat dissipation: 18...24 W.  
 Operating time à U<sub>c</sub>: closing = 20...35 ms, opening = 7...15 ms.

Control circuit voltage U <sub>c</sub>	Average resistance at 20 °C ±10 %	Inductance of closed circuit	Cat. no. <sup>(1)</sup>	Average resistance at 20 °C ±10 %	Inductance of closed circuit	Cat. no. <sup>(1)</sup>	Weight
V	Ω	H	50 Hz	Ω	H	60 Hz	kg
24	0.18	0.03	LAEX6B5	0.13	0.02	LAEX6B6	0.510
48	0.71	0.12	LAEX6E5	-	-	-	0.510
110	4.2	0.65	LAEX6F5	2.7	0.44	LAEX6F6	0.510
220	17	2.59	LAEX6M5	11.1	1.80	LAEX6M6	0.510
240	20	3.09	LAEX6U5	-	-	-	0.510
380	51.3	7.8	LAEX6Q5	34	5.3	LAEX6Q6	0.510
415	62.3	9.1	LAEX6N5	-	-	-	0.510
440	62.3	9.1	LAEX6R5	43.5	6.9	LAEX6R6	0.510

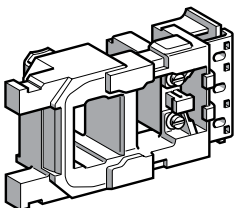

LAEX7●●

### For 3-pole contactors LC1E300

#### Specifications

Average consumption at 20 °C:  
 ■ inrush (cos φ = 0.9) 50 Hz or 60 Hz: 650 VA  
 ■ sealed (cos φ = 0.3) 50 Hz or 60 Hz: 10 VA.  
 Heat dissipation: 8 W.  
 Operating time à U<sub>c</sub>: closing = 40...65 ms, opening = 100...170 ms.  
 Operate on networks with harmonic numbers ≤ 7.  
 Operating cycles/hour (θ ≤ 55 °C): ≤ 2400

Control circuit voltage U <sub>c</sub>	Average resistance at 20 °C ±10 %	Inductance of closed circuit	Cat. no. <sup>(1)</sup>	Average resistance at 20 °C ±10 %	Inductance of closed circuit	Cat. no. <sup>(1)</sup>	Weight
V	Ω	H	50 Hz	Ω	H	60 Hz	kg
24	20	<sup>(2)</sup>	LAEX7B5	20	<sup>(2)</sup>	LAEX7B6	0.770
48	67	<sup>(2)</sup>	LAEX7E5	-	-	-	0.770
110	440	<sup>(2)</sup>	LAEX7F5	440	<sup>(2)</sup>	LAEX7F6	0.770
220	1578	<sup>(2)</sup>	LAEX7M5	1578	<sup>(2)</sup>	LAEX7M6	0.770
240	1968	<sup>(2)</sup>	LAEX7U5	-	-	-	0.770
380	4631	<sup>(2)</sup>	LAEX7Q5	4631	<sup>(2)</sup>	LAEX7Q6	0.770
415	4631	<sup>(2)</sup>	LAEX7N5	-	-	-	0.770
440	6731	<sup>(2)</sup>	LAEX7R5	6731	<sup>(2)</sup>	LAEX7R6	0.770

(1) The last two digits in the reference represent the voltage code.  
 (2) Please consult your Regional Sales Office.

### LC1E06...E25

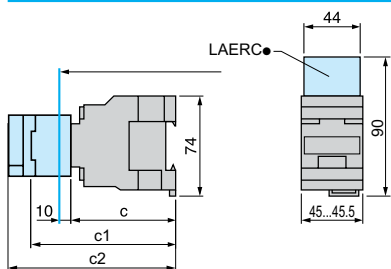

LC1	E06...E18	E25
c	80	85
c1 with LAEN	113	118
c2 with LAETSD	-	136

### LC1E32/38

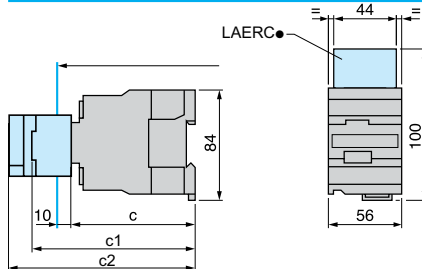

LC1	E32/38
c	86
c1 with LAEN	120
c2 with LAETSD	138

### LC1E06...E25

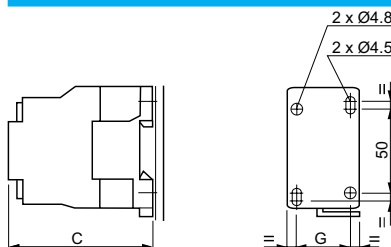

LC1	E06	E09	E12	E18	E25
c	80	80	80	80	85
G	35	35	35	35	35

### LC1E32/38

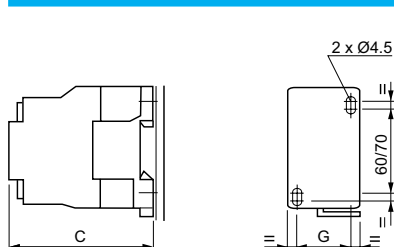

LC1	E32/38
c	86
G	40

### LC1E40...E65

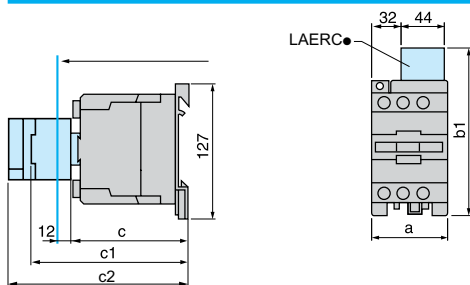

LC1	E40...E65
a	75
b1	with LAERC● 135
c	115
c1	with LAEN● 147
c2	with LAETSD 165

### LC1E80/95

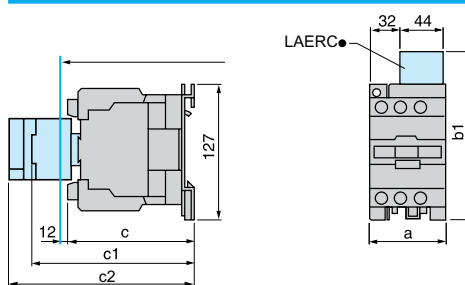

LC1	E80/95
a	85
b1	with LAERC● 135
c	124
c1	with LAEN● 153
c2	with LAETSD 171

### LC1E40...E65

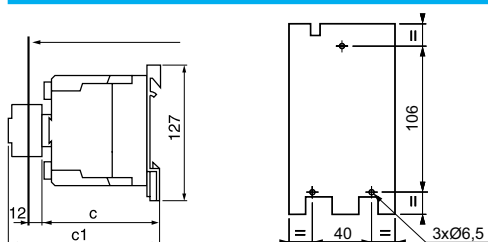

LC1	E40...E65
c	115

### LC1E80/95

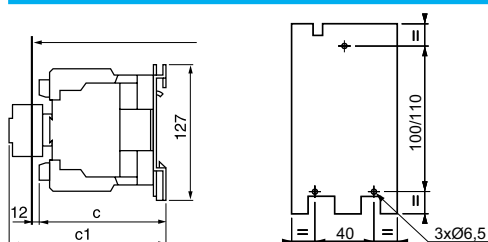

LC1	E80/95
c	124

2 x LC1E06...E65 with LAEM1

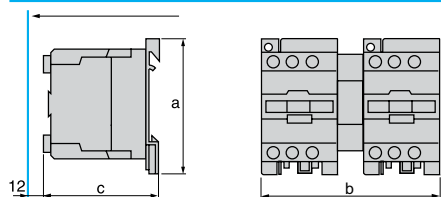

2 x LC1E80/95 with LAEM4

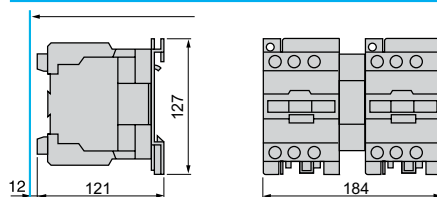

LC1	E06...25	E32...38	E40...65
a	74	84	127
b	104	126	164
c	80	86	114



### LC1E120/160

#### On panel with accessories

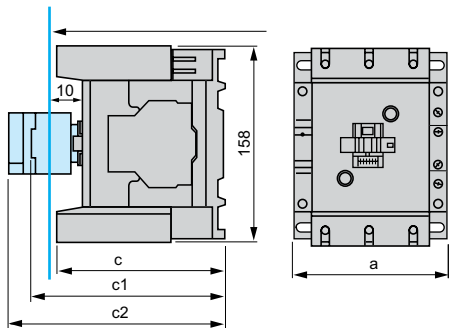

a		120
c	Without add-on blocks	132
c1	With LAEN	150
c2	With LAETSD	168

#### On 2 mounting rails DZ5 MB on 120 mm centres

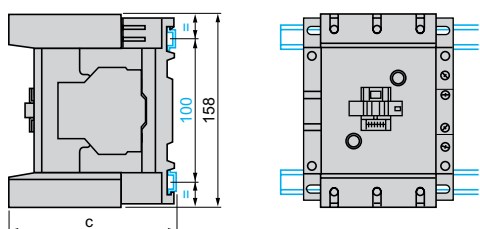

c	(AM1 DP200 or DR200)	134.5
c	(AM1 DE200 or ED●●●)	150

#### On Panel

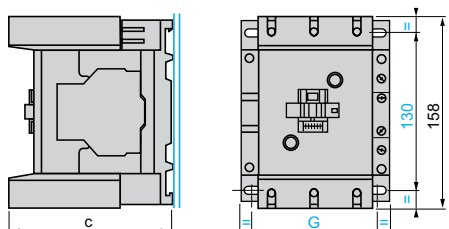

	LC1E120	LC1E160
c	(AM1 DP200 or DR200)	132
G	91/110	96/110

#### 2 x LC1E120 or LC160 with LAEM5

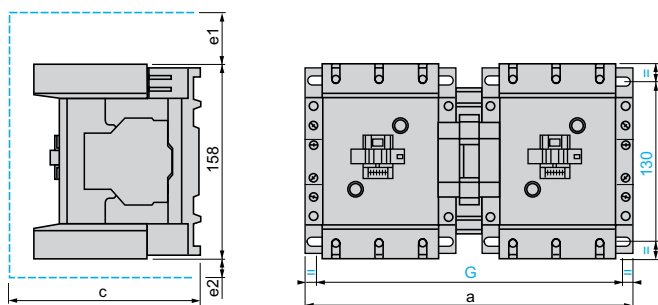

2 x LC1E120 or 160	a	c	e1	e2	G
For 120 and 160	266	148	56	18	242/256

c, e1 and e2: including cabling

**LC1E200 - LC1E250 - LC1E300**

**On panel**

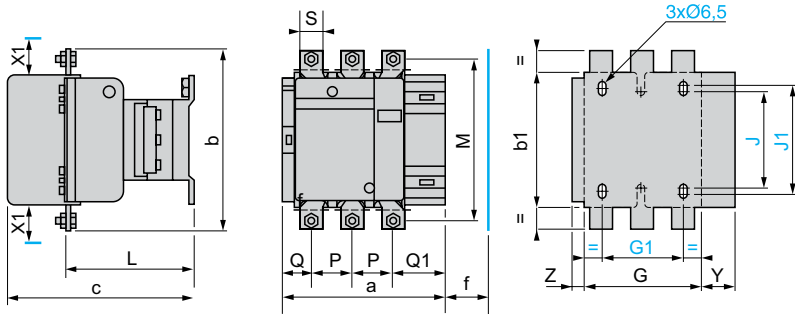

X1 (mm) = minimum electrical clearance according to operating voltage and breaking capacity.

	220...500 V	600...690 V
LC1E200	10	15
LC1E250, 300	10	15

	a	b	b1	c	f	G	G1	J	J1	L	M	P	Q	Q1	S	Y	Z
LC1E200	168.5	174	137	181	130	111	80	106	120	113.5	154	40	29	59.5	20	44	13.5
LC1E250	168.5	197	137	181	130	111	80	106	120	113.5	172	48	21	51.5	25	44	13.5
LC1E300	213	206	145	219	147	154.5	96	106	120	145	181	48	43	74	25	38	20.5

f = minimum distance required for coil removal.

**2 x LC1E200 or LC1E250 with LAEM6 - 2 x LC1E300 with LAEM7**

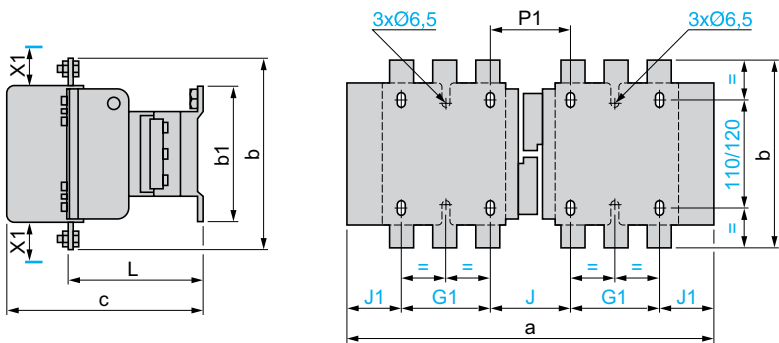

X1 (mm) = minimum electrical clearance according to operating voltage and breaking capacity.

	220...500 V	600...690 V
LC1E200	10	15
LC1E250, 300	10	15

	a	b	b1	c	G1	J	J1	L	P1
2 x LC1E200	357	174	137	181	80	78	59.5	113.5	78
2 x LC1E250	357	197	137	181	80	78	59.5	113.5	62
2 x LC1E300	447	206	145	219	96	124	65.5	145	107

## LC1E400 - LC1E500

On panel

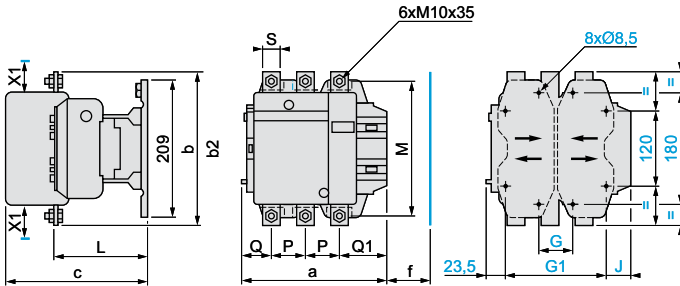

X1 (mm) minimum electrical clearance according to operating voltage and breaking capacity.

	220...500 V	600...690 V
LC1E400	15	20
LC1E500	15	20

	a	b	b2	c	f	G*	Gmin.	Gmax.	G1*	G1min.	G1max.	J	L	M	P	Q	Q1	S
LC1E400	213	206	375	219	146	80	66	102	170	156	192	19.5	145	181	48	43	74	25
LC1E500	233	238	400	232	150	80	66	120	170	156	210	39.5	146	208	55	46	77	30

f=minimum distance required for coil removal

## LC1E630

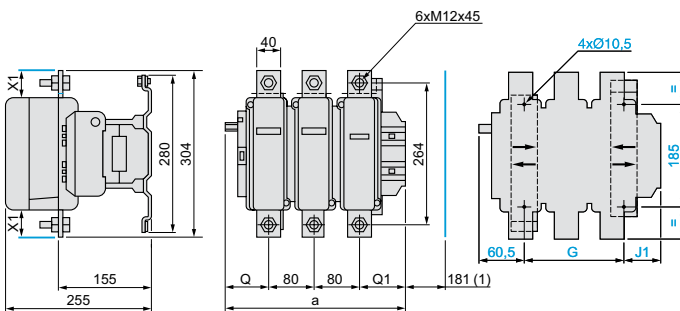

X1 (mm) = minimum electrical clearance according to operation voltage and breaking capacity.

	220...500 V	600...690 V
LC1E630	20	30

(1) Minimum distance required for coil removal.

	a	G*	G min	Gmax.	J1	Q	Q1
LC1E630	309	180	100	195	68.5	60	89

## 2 x LC1E400, LC1E500, LC1E630

X1 (mm) = minimum electrical clearance according to operating voltage and breaking capacity.

	220...500 V	600...690 V
LC1E400,500	15	20
LC1E630	20	30

(1) Except LC1 E630 : 4 x Ø 10.5.  
(2) Except LC1 E630 : 180mm.

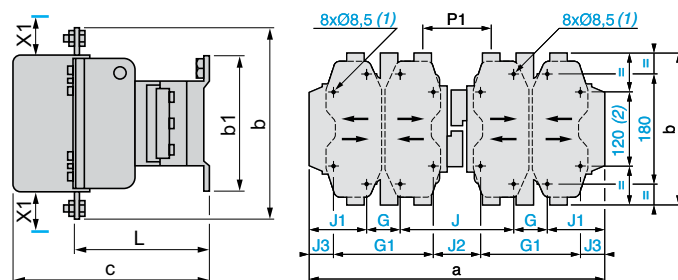

	a	b	b1	c	G	G1	J	J1	J2	J3	L	P1
2 x LC1E400	446	206	209	219	80	170	157	64.5	67	19.5	145	107
3 x LC1E500	485	238	209	232	80	170	156	84.5	66	39.5	146	112
4 x LC1E630	636	304	280	255	180	-	139	68.5	-	-	155	137

**LC1E06...E18**

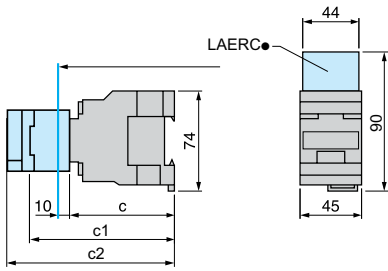

LC1	E06/E18
c	80
c1 with LAEN	113
c2 with LAETSD	135

**LC1E25...E38**

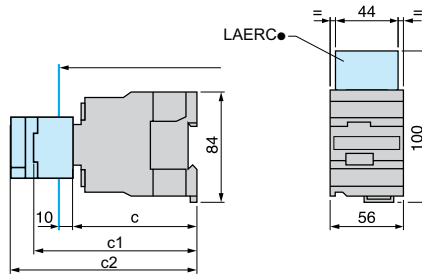

LC1	E25/38
c	93
c1 with LAEN	125
c2 with LAETSD	147

**LC1E06...E18**

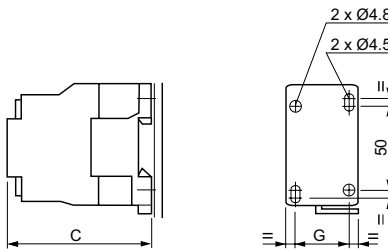

LC1	E06	E09	E12	E18
c	80	80	80	80
G	35	35	35	35

**LC1E25...E38**

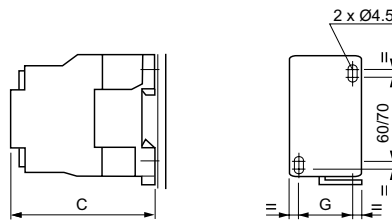

LC1	E25/38
c	93
G	40

**LC1E40/65**

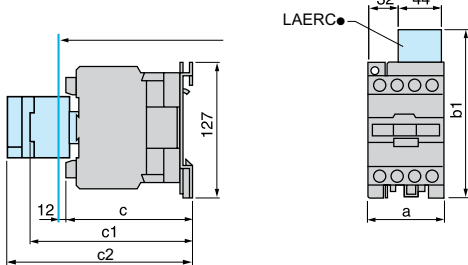

LC1	E40...E65
a	85
b1	with LAERC 135
c	110/125
c1	with LAEN 143
c2	with LAETSD 165

**LC1E80/95**

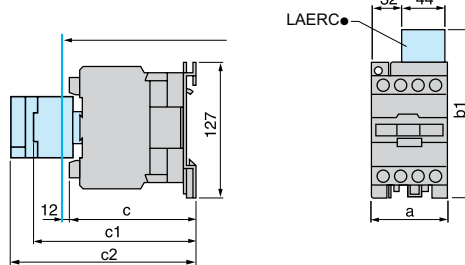

LC1	E80/95
a	95
b1	with LAERC 135
c	120/135
c1	with LAEN 160
c2	with LAETSD 172

**LC1E40/65**

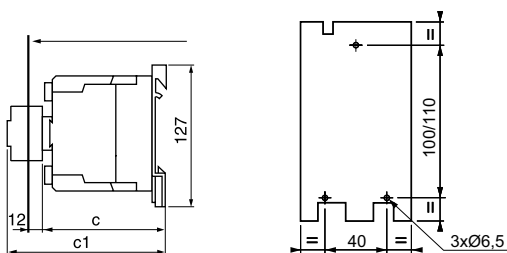

LC1	E40/E65
c	114

**LC1E80/95**

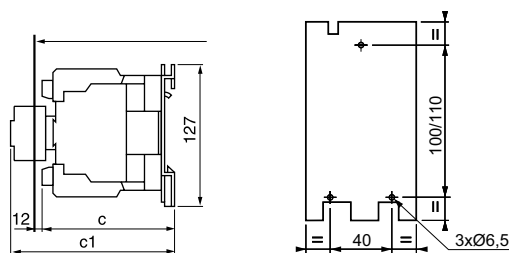

LC1	E80/95
c	121

## Contactors (3-pole)

### LC1E06...38

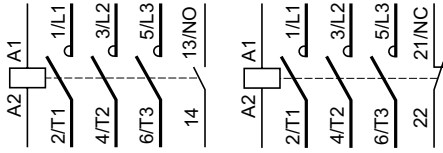

### LC1E40...95

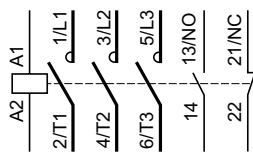

### LC1E120/160

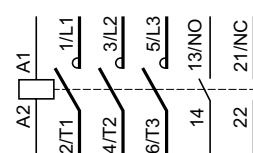

### LC1E200, 250, 300

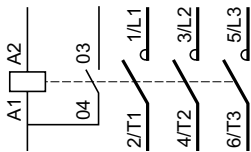

### LC1E 400,500,630

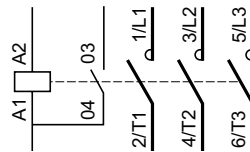

## Contactors (4-pole)

### LC1E06...95004

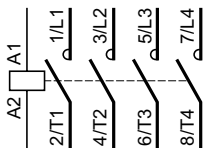

### LC1E06...38008

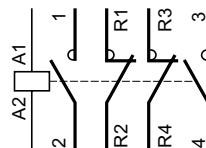

### LC1E40...95008

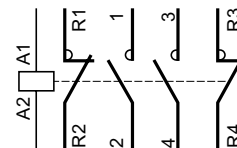

### Reversing contactors

2 x LC1E06...38

2 x LC1E40...95

Horizontally mounted

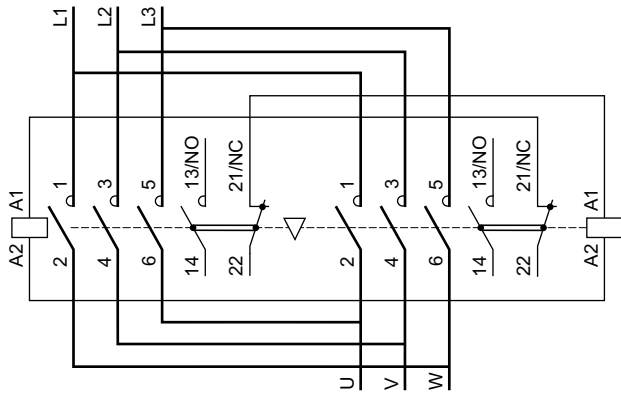
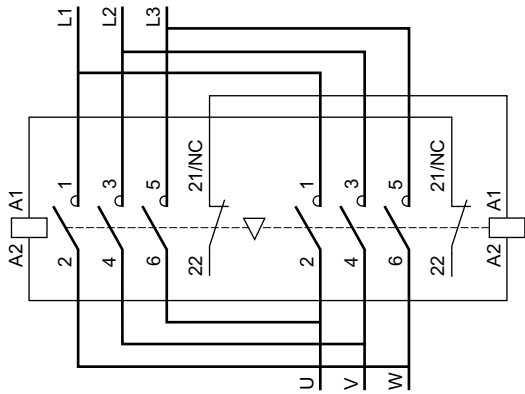

2 x LC1E120, 160

2 x LC1E200, 250, 300

Horizontally mounted

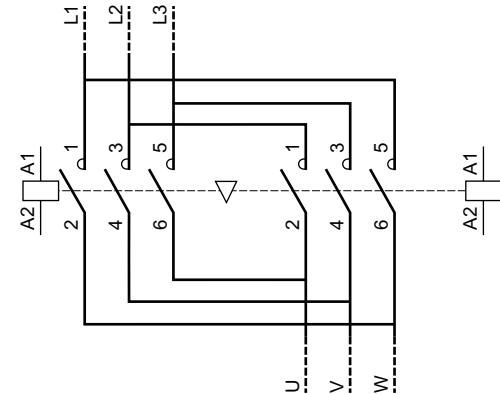
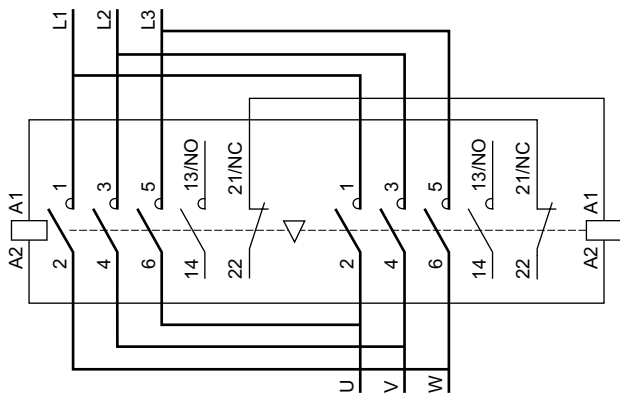

### Front mounting add-on contact blocks

1NO + 1NC (LAEN11) 2NO (LAEN20)

2NC (LAEN02)

2NO + 2NC (LAEN22)

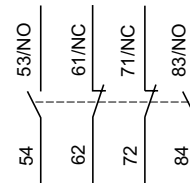
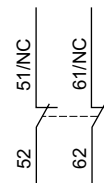
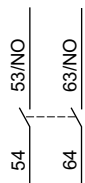
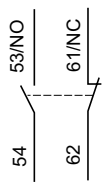

### Time delay auxiliary contacts

On delay 1NO + 1NC (LAETSD)

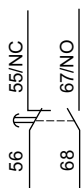

### Mechanical interlock

LAEM●

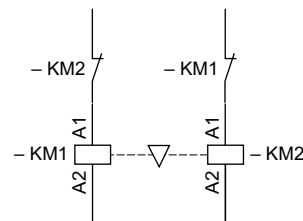





# EasyPact TVS Thermal



TOR Com. Ref	Possible I <sub>max</sub> Calibration	Compatible with Contactor (size 1 & 2) Com. Ref.						
		LC1E06	LC1E09	LC1E12	LC1E18	LC1E25	LC1E32	LC1E38
LRE01	0.10...0.16 A	■	■	■	■	■	■	■
LRE02	0.16...0.25 A	■	■	■	■	■	■	■
LRE03	0.25...0.40 A	■	■	■	■	■	■	■
LRE04	0.40...0.63 A	■	■	■	■	■	■	■
LRE05	0.63...1 A	■	■	■	■	■	■	■
LRE06	1...1.6 A	■	■	■	■	■	■	■
LRE07	1.6...2.5 A	■	■	■	■	■	■	■
LRE08	2.5...4 A	■	■	■	■	■	■	■
LRE10	4...6 A	■	■	■	■	■	■	■
LRE12	5.5...8 A		■	■	■	■	■	■
LRE14	7...10 A		■	■	■	■	■	■
LRE16	9...13 A			■	■	■	■	■
LRE21	12...18 A				■	■	■	■
LRE22	16...24 A					■	■	■
LRE32	23...32 A					■	■	■
LRE35	30...38 A							■

## Common characteristics

- > Class: 10 A.
- > Operating voltage: max. 690 V AC.

# Overload Relays



TOR Com. Ref	Possible I <sub>max</sub> Calibration	Compatible with Contactor (size 3 & 4) Com. Ref.				
		LC1E40	LC1E50	LC1E65	LC1E80	LC1E95
LRE322	17...25 A	■	■	■	■	■
LRE353	23...32 A	■	■	■	■	■
LRE355	30...40 A	■	■	■	■	■
LRE357	37...50 A		■	■	■	■
LRE359	48...65 A			■	■	■
LRE361	55...70 A				■	■
LRE363	63...80 A				■	■
LRE365	80...104 A					■



TOR Com. Ref	Possible I <sub>max</sub> Calibration	Compatible with Contactor (size 5, 6, 7, 8 & 9) Com. Ref.							
		LC1E120	LC1E160	LC1E200	LC1E250	LC1E300	LC1E400	LC1E500	LC1E630
LRE480	51...81A	■	■	□	□	□	□	□	□
LRE481	62...99A	■	■	□	□	□	□	□	□
LRE482	84...135A	■	■	□	□	□	□	□	□
LRE483	124...198A		□	■	□	□	□	□	□
LRE484	146...234A			□	■	■	■	□	□
LRE485	174...279A			□	■	■	■	□	□
LRE486	208...333A				■	■	■	□	□
LRE487	259...414A					■	■	□	□
LRE488	321...513A						□	■	□
LRE489	394...630A							□	■

**Note:**

- means the relay can match with contactor both in electrical and mechanical.
- means the relay can match with contactor only in electrical (can not directly mounting).

## Presentation



EasyPact TVS thermal overload relays are designed to protect a.c. circuits and motors against:

- overloads
- phase failure
- Long starting time
- prolonged stalled rotor condition.

The thermal relay controls permanently the current driven by the motor. When this current exceeds the setting it's auxiliary contacts will change state, causing the motor to stop.

## Description

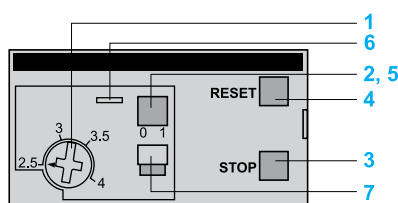

LRE●●, LRE48●

- 1 Adjustment dial I<sub>r</sub>.
- 2 Test button.  
Operation of the Test button allows:
  - checking of control circuit wiring,
  - simulation of relay tripping (actuates both the N/O and N/C contacts).
- 3 Stop button. Actuates the N/C contact; does not affect the N/O contact.
- 4 Reset button.
- 5 Trip indicator.
- 6 Setting locked by sealing the cover.
- 7 Selector for manual or automatic reset.

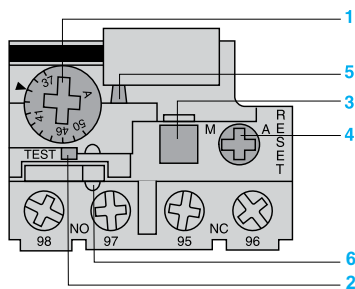

LRE3●●

LRE relays are supplied with the selector in the manual position, protected by a cover. Deliberate action is required to move it to the automatic position.

Power circuit characteristics										
Relay type	Ref.	LRE 01...21	LRE 22...35	LRE 322...365	LRE 480...482	LRE 483	LRE 484	LRE 485...487	LRE 488	LRE 489
	Size	1	2			3			4	
Tripping class	Conforming to IEC 60947-4-1	10 A								
Rated insulation voltage	Conforming to IEC 60947-4-1	V 690								
Rated impulse withstand voltage (Uimp)		kV 6								
Frequency limits	Of the operating current	Hz 50...60								
Setting range	Depending on model	0.1...18	16...38	17...104	51...630					
Power circuit connections										
Connection by screw clamp terminals		Minimum/maximum c.s.a.								
	Flexible cable without cable end 1 conductor	mm <sup>2</sup> 1.5...6	2.5...10	4...35	-					
	Flexible cable with cable end 1 conductor	1...4	1.5...6	4...35	-					
	Solid cable without cable end 1 conductor	1...6	2.5...10	4...35	-					
	Tightening torque	N.m 1.7	2.5	9	-					
Connection by bars or lugs										
Pitch	Without spreaders	mm	-		34.8	40	48	48	55	80
Bars or cables with lugs	Cross section	-			3X18	3X20	3X25	4X25	5x30	6X40
Screws	Type	-			M8	M8	M10	M10	M10	M12
	Tightening torque	N.m	-		27.5	27.5	35	35	35	58
Auxiliary contact characteristics										
Conventional thermal current		A	5							
Max. sealed consumption of the operating coils of controlled contactors (Occasional operating cycles of contact 95-96)	a.c. supply	V	110	120	220	240	380	480	500	600
		A	3.27	3	1.63	1.5	0.95	0.75	0.72	0.12
Protection against short-circuits	By gG, maximum rating or by GB2	A	5							
Connection by screw clamp terminals		Minimum/maximum c.s.a.								
	Flexible cable without cable end 1 conductor	mm <sup>2</sup>	2 x 1...2.5							
	Flexible cable with cable end 1 conductor		2 x 1...2.5							
	Solid cable without cable end 1 conductor		2 x 1...2.5							
	Tightening torque	N.m	1.7							
Environment										
Conforming to standard			IEC 60947-4-1, IEC 60947-5-1							
Product certifications			EAC							
Degree of protection	Conforming to IEC 60529		IP2X				IP00			
Protective treatment	Conforming to IEC 60068		"TH"							
Ambiant air temperature	Storage	°C	-60...+80							
	Normal operation without derating (IEC 60947-4-1)		-20...+60							
	Minimum/maximum operating temperature (with derating) <sup>(1)</sup>		-20...+70							
Operating positions without derating	In relation to normal vertical mounting plane		Any position							
Flame resistance	Conforming to IEC 60068-2-1	°C	850							
Shock resistance	Permissive acceleration conforming to IEC 60068-2-7		6 gn - 11 ms							
Vibration resistance	Permissive acceleration conforming to IEC 60068-2-6		3 gn							
Dielectric strenght at 50 Hz	Conforming to IEC 60255-5	kV	6							
Surge withstand	Conforming to IEC 60801-5		6							
Operating characteristics										
Temperature compensation		°C	-20...+60							
Tripping threshold	Conforming to IEC 60947-4-1	A	1.14 ± 0.06 I <sub>r</sub>							
Sensitivity to phase failure	Conforming to IEC 60947-4-1		Tripping current 130 % of I <sub>r</sub> on two phase, the last one at 0							

(1) Contact your regional sales.

## Tripping curves

Average operating time related to multiples of the setting current

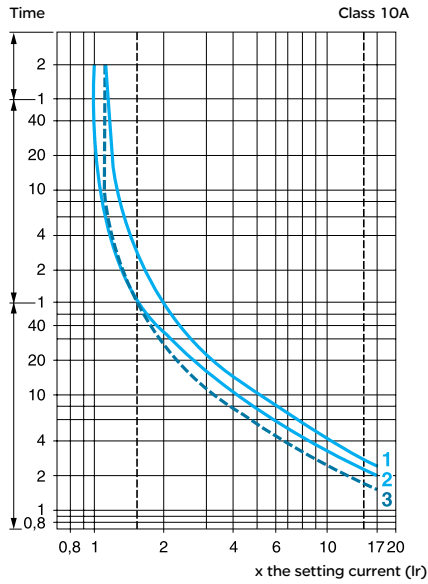

- 1 Balanced operation, 3-phase, without prior current flow (cold state).
- 2 2-phase operation, without prior current flow (cold state).
- 3 Balanced operation, 3-phase, after a long period at the set current (hot state).

# EasyPact TVS thermal overload relays

## 3-pole thermal overload relays



LRE00



LRE30



LRE48

### Differential thermal overload relays

for use with fuses or magnetic circuit-breakers GV2 L and GV3 L

- Compensated relays with manual or automatic reset,
- with relay trip indicator,
- for a.c.

Relay setting range (A)	Fuses to be used with selected relay		For use with contactor LC1	Reference	Weight kg
	aM (A)	gG (A)			
<b>Class 10 A <sup>(1)</sup> for connection by screw clamp terminals</b>					
0.10...0.16	0.25	2	E06...E38	<b>LRE01</b>	0.130
0.16...0.25	0.5	2	E06...E38	<b>LRE02</b>	0.130
0.25...0.40	1	2	E06...E38	<b>LRE03</b>	0.130
0.40...0.63	1	2	E06...E38	<b>LRE04</b>	0.130
0.63...1	2	4	E06...E38	<b>LRE05</b>	0.130
1...1.6	2	4	E06...E38	<b>LRE06</b>	0.130
1.6...2.5	4	6	E06...E38	<b>LRE07</b>	0.130
2.5...4	6	10	E06...E38	<b>LRE08</b>	0.130
4...6	8	16	E06...E38	<b>LRE10</b>	0.130
5.5...8	12	20	E09...E38	<b>LRE12</b>	0.130
7...10	12	20	E09...E38	<b>LRE14</b>	0.130
9...13	16	25	E12...E38	<b>LRE16</b>	0.130
12...18	20	35	E18...E38	<b>LRE21</b>	0.130
16...24	25	50	E25...E38	<b>LRE22</b>	0.130
23...32	40	63	E25...E38	<b>LRE32</b>	0.130
30...38	40	80	E38	<b>LRE35</b>	0.130
17...25	25	50	E40...E95	<b>LRE322</b>	0.470
23...32	40	63	E40...E95	<b>LRE353</b>	0.470
30...40	40	100	E40...E95	<b>LRE355</b>	0.470
37...50	63	100	E50...E95	<b>LRE357</b>	0.460
48...65	63	100	E65...E95	<b>LRE359</b>	0.460
55...70	80	125	E80...E95	<b>LRE361</b>	0.480
63...80	80	125	E80...E95	<b>LRE363</b>	0.480
80...104	80	160	E95	<b>LRE365</b>	0.520
<b>Class 10 A <sup>(1)</sup> directly connected by connector</b>					
51...81	100	125	E120...E160	<b>LRE480</b>	2.2
62...99	125	160	E120...E160	<b>LRE481</b>	2.2
84...135	160	200	E120...E160	<b>LRE482</b>	2.2
124...198	200	250	E200	<b>LRE483</b>	2.1
146...234	250	315	E250...E400	<b>LRE484</b>	2.2
174...279	315	315	E250...E400	<b>LRE485</b>	2.2
208...333	400	400	E250...E400	<b>LRE486</b>	2.2
259...414	400	500	E300...E400	<b>LRE487</b>	2.4
321...513	500	800	E500	<b>LRE488</b>	3.2
394...630	630	1000	E630	<b>LRE489</b>	3.9

(1) Standard IEC 60947-4-1 specifies a tripping time for 7.2 times the setting current  $I_R$ : class 10 A: between 2 and 10 seconds.

# EasyPact TVS thermal overload relays

Direct connection to LRE contactors

## LRE01...E35

Direct mounting under LC1E06...38 contactors with screw clamp connections

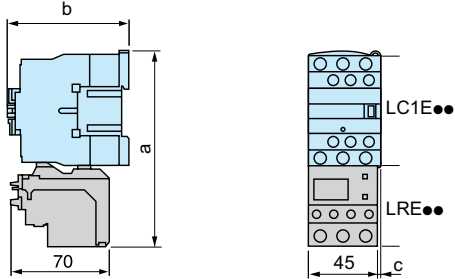

With contactor	LC1E06...E18	LC1E25	LC1E32/E38
a	123	137	137
b	84	92	92
c	0	0	11

## LRE3●●

Direct mounting under LC1E06...38 contactors with screw clamp connections

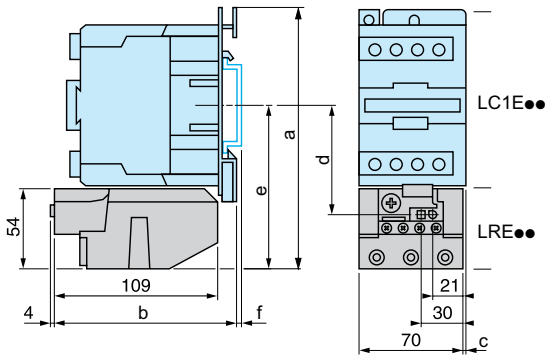

With contactor on DIN rail	onAM1-DL201	AM1-DL200
f	7	17

With contactor	LC1E40	LC1E50	LC1E65	LC1E80	LC1E95
a	175	175	175	180	180
b	119	119	119	124	124
c	4.5	4.5	4.5	9.5	9.5
d	72.4	72.4	72.4	76.9	76.9
e	111	111	111	115.5	115.5

## Electrical diagram all relays

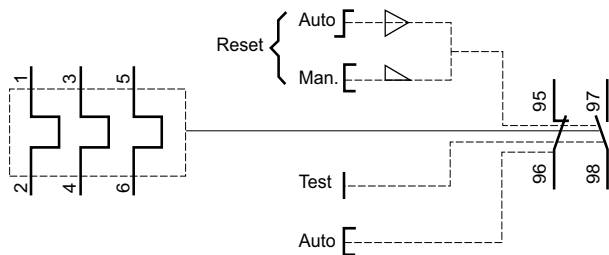



# EasyPact TVS thermal overload relays

## Connection to a terminal block

### LRE01...E35 connected to LAEB1 terminal block

Independent mounting on 50 mm centres; or on rail AM1 DP200 or DE200

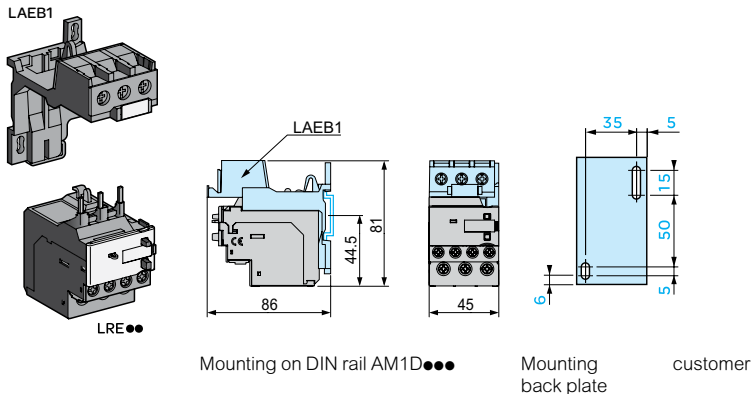

### LRE322...E365, connected to LAEB3 terminal block

Independent mounting on 50 mm centres; or on rail AM1 DP200 or DE200

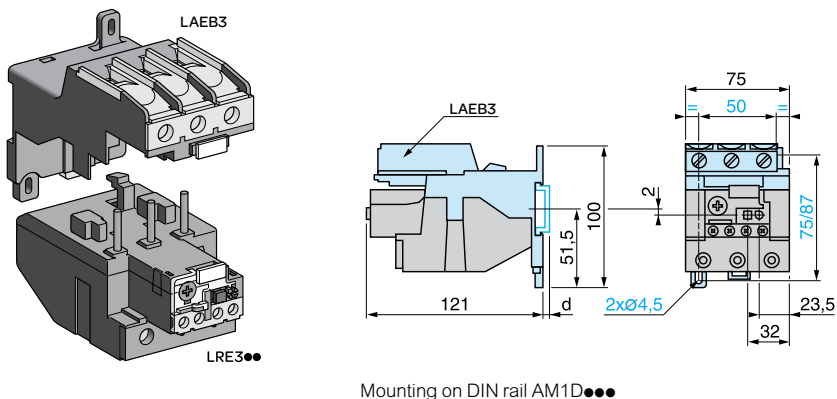

	AM1-DP200	AM1-DE200
d	2	9.5

# EasyPact TVS thermal overload relays

## Independant mounting and connection

### LRE48●

#### Independent mounting on mounting plate

LRE48●: with direct mounting under contactors LC1E120...630 or separate mounting (without accessory).

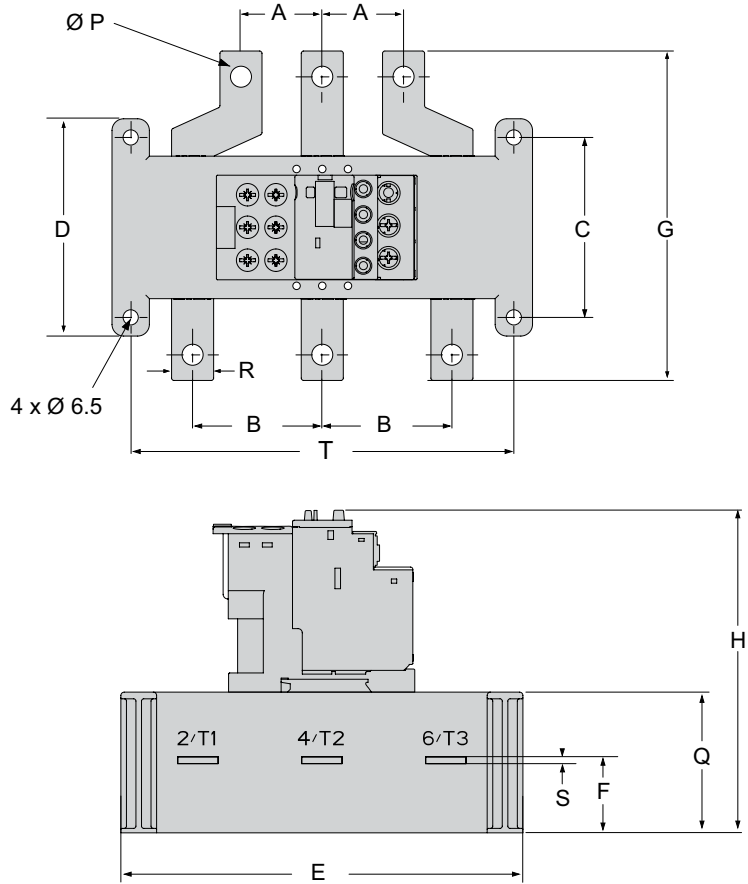

(mm)

#### Dimensions and mounting

Range (A)		A	B	C	D	E	F	G	H	P	Q	R	S	T
LRE480	51...81	34.8	55.5	77	93	180	32	141	134	9	63	18	3	164
LRE481	62...99							10		20				
LRE482	84...135							12		25				
LRE483	124...198	40	76	93	180	32.5	134	134	148	12	77	25	4	222
LRE484	146...234	48										30		
LRE485	174...279	55										40		
LRE486	208...333	80	80	77	93	180	32.5	134	148	14	77	30	5	222
LRE487	259...414	80	80									40	6	
LRE488	321...513	80	80									40	6	
LRE489	394...630	80	80	77	93	242	43.5	150	148	14	77	40	6	222

# EasyPact TVS thermal overload relays

Independant mounting and connection

## LRE48●

### Independent mounting on mounting plate

LRE48●: with direct mounting.

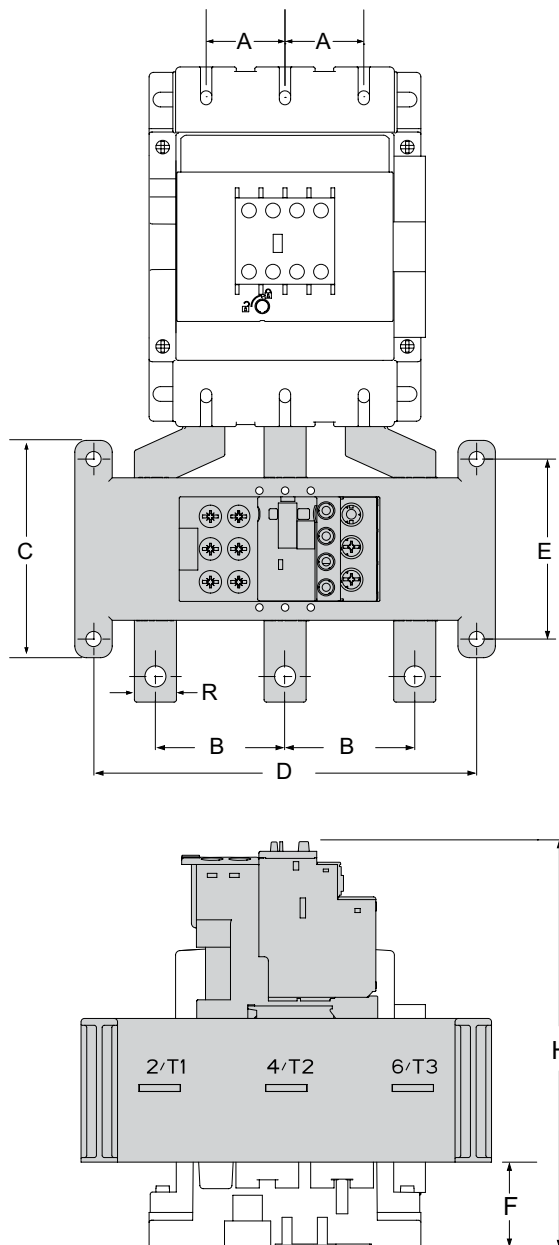

(mm)

Dimensions and mounting		A	B	C	D	E	F	H
Range (A)								
LRE480	51...81	34.8	55.5	93	164	77	38	180
LRE481	62...99							
LRE482	84...135							
LRE483	124...198	40	55.5	93	164	77	82	223
LRE484	146...234	48						
LRE485	174...279							
LRE486	208...333	48	55.5	93	164	77	113	255
LRE487	259...414							
LRE488	321...513	55						
LRE489	394...630	80	80	222	125	279		

# EasyPact TVS thermal overload relays

## Independant mounting and connection

CDB500412

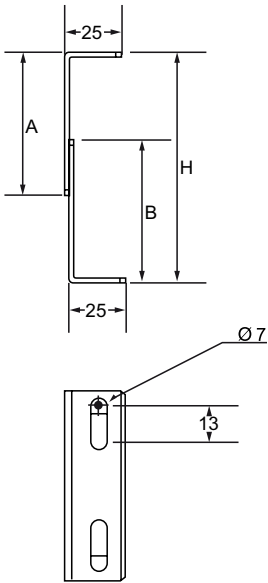
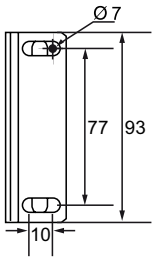
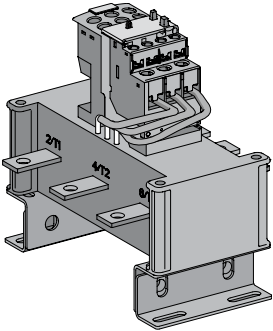

### Accessories for LRE48X Thermal Overload Relay

#### Relay mounting with Contactor directly

Relay	Contactor	Mounting support	
		cat No.	weight (Kg)
LRE480	LC1E120...160	LAES1	0.32
LRE481	LC1E120...160	LAES1	0.32
LRE482	LC1E120...160	LAES1	0.32
LRE483	LC1E200	LAES2	0.45
LRE484	LC1E250...300	LAES2	0.45
LRE485	LC1E250...300	LAES2	0.45
LRE486	LC1E250...300	LAES2	0.45

Dimension	LAES1	LAES2	
A (mm)	34	70	
B (mm)	30	70	
C (mm)	34-42	75-90	107-122



# EasyPact TVS control relays

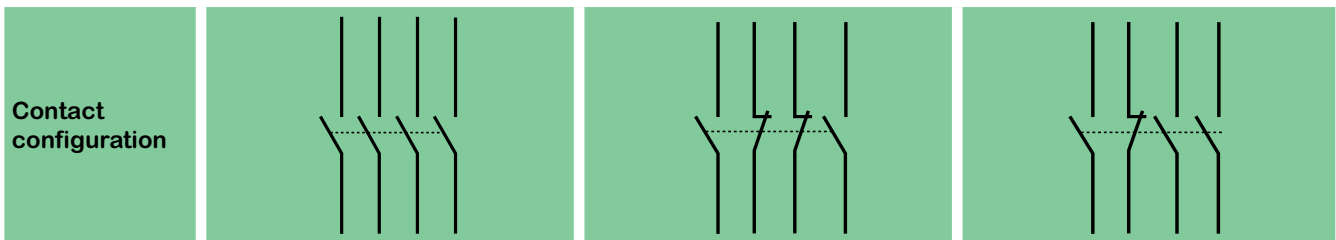

Coil V AC/Hz	50 Hz	50 Hz	50 Hz
24	CAE40B5	CAE22B5	CAE31B5
48	CAE40E5	CAE22E5	CAE31E5
110	CAE40F5	CAE22F5	CAE31F5
220	CAE40M5	CAE22M5	CAE31M5
240	CAE40U5	CAE22U5	CAE31U5
380	CAE40Q5	CAE22Q5	CAE31Q5
415	CAE40N5	CAE22N5	CAE31N5
Coil V AC/Hz	60 Hz	60 Hz	60 Hz
110	CAE40F6	CAE22F6	CAE31F6
220	CAE40M6	CAE22M6	CAE31M6
440	CAE40R6	CAE22R6	CAE31R6

Control circuit characteristics				
Type			CAE~	
Rated control circuit voltage (Uc)	<b>V</b>		24...440	
Control voltage limits	Operation	Coil type: 50 Hz	0.85...1.1 Uc	
	Drop-out		0.3...0.6 Uc	
Average consumption at ~ 50 Hz 20 °C and at Uc	<b>VA</b>		Sealed and closed: 70 Maintain: 8	
Operating time Between coilopening of the N/C (rated control circuit energisation contact voltage, ambient and closing of the N/O contact temperature 20 °C)	<b>ms</b>		4...19	
			12...22	
		Between coilopening of the N/O de-energisation contact and closing of the N/C contact	4...12	
			6...17	
Momentary supply failure	Maximum power-off time without influencing sealed state		2	
Maximum operating rate	Operating cycles per second		3	
Mechanical durability In millions of operating cycles	Coil type: 50 Hz		10	
Control connection (coil)				
Connecting to screw clamp terminals	Flexible cable without cable end	1 conductor	<b>mm<sup>2</sup></b>	1...2.5
		2 conductors		1...2.5
	Flexible cable with cable end	1 conductor		1...2.5
		2 conductors		1...2.5
	Solid cable without cable end	1 conductor		1...2.5
		2 conductors		1...2.5
Tightening torque		<b>N.m</b>	1.2	
Characteristics of built in instantaneous contacts				
Number of contacts			4	
Rated operational voltage Up to (Ue)	<b>V</b>		690	
Rated insulation voltage (Ui)		Conforming to IEC 60947-5-1	690	
Conventional thermal current (Ith)	<b>A</b>	Operational environment temperature ≤ 40 °C	10	
Operating frequency	<b>Hz</b>	current	50	
Minimum switching capacity	<b>V</b>	U min	17	
	<b>mA</b>	I min	5	
Short-circuit protection	<b>A</b>	Conforming to IEC 60947-5-1	gG fuse: 10 A	
Rated making capacity	<b>A</b>	Conforming to IEC 60947-5-1	~: 140	
Short-time rating	<b>A</b>	Permissible for 500 ms	120	
		100 ms	140	
Insulation resistance	<b>MΩ</b>		> 10	
Non-overlap time	<b>ms</b>	Guaranteed non-overlap between N/C and N/O contacts	1.5 on energisation and on de-energisation	
Tightening torque	<b>N.m</b>	Philips n°2	1.2	
Non-overlap distance			Contact LAEN●● connecting with auxiliary contacts	
Instantaneous contacts connection				
Connecting to screw clamp terminals	Flexible cable without cable end	1 conductor	<b>mm<sup>2</sup></b>	1...2.5
		2 conductors		1...2.5
	Flexible cable with cable end	1 conductor		1...2.5
		2 conductors		1...2.5
	Solid cable without cable end	1 conductor		1...2.5
		2 conductors		1...2.5
Tightening torque		<b>N.m</b>	1.2	

Environment			
Type			CAE~
Rated insulation voltage (Ui)	Conforming to IEC 60947-5-1	<b>V</b>	690
Rated impulse withstand voltage (Uimp)	Conforming to IEC 60947	<b>kV</b>	6
Electrical insulation	IEC 60536		Up to 400 V reinforced insulation
Conforming to standards			IEC 60947-5-1
Certifications			EAC
Protective treatment	Conforming to IEC 60068-2-30		IEC60068-2-30 Test Db, Variant 2
Degree of protection	Conforming to IEC 60529		IP2X
Ambient air temperature around the device	Storage	<b>°C</b>	-60...+80
	0.85...1.1 UC		-5...+55
	For operation at Uc		-20...+70
Maximum operating altitude	Without derating	<b>m</b>	3000
Operating position	Without derating in the following positions		
Shock resistance <sup>(1)</sup> 1/2 sine wave, 11 ms	Control relay open		7 gn
	Control relay closed		10 gn
Vibration resistance <sup>(1)</sup> 5...300 Hz	Control relay open		1.5 gn
	Control relay closed		3 gn
Weight		<b>kg</b>	0.280

(1) No change of contact state at coil voltage Ue in worst conditions.



## Rated operational power of contacts ( conforming to IEC 60947-5-1)

### a.c.supply. categories AC-14 and AC-15

Electrical durability ( valid for up to 3600 operating cycles/hour ) on an inductive load such as the coil of an electromagnet: making current (  $\cos \phi 0.7$  ) = 10 times the power broken (  $\cos \phi 0.4$  ).

### d.c.supply. categories DC-13

Electrical durability ( valid for up to 1200 operating cycles/hour ) on an inductive load such as the coil of an electromagnet, without economy resistor, the time constant increasing with the power.

## Number of operation cycles

AC-14/AC-15	Volts ~	24 VAC	48 VAC	115 VAC	230 VAC	400 VAC	440 VAC	600 VAC
1 million operating cycles	VA	20	39	94	188	327	360	491
3 million operating cycles	VA	9	18	42	84	146	161	219
10 million operating cycles	VA	3	6	13	26	46	51	69

DC-13	Volts —	24 VDC	48 VDC	125 VDC	250 VDC	400 VDC
1 million operating cycles	W	80	60	50	45	40
3 million operating cycles	W	47	34	25	22	18
10 million operating cycles	W	17	12	10	8	7

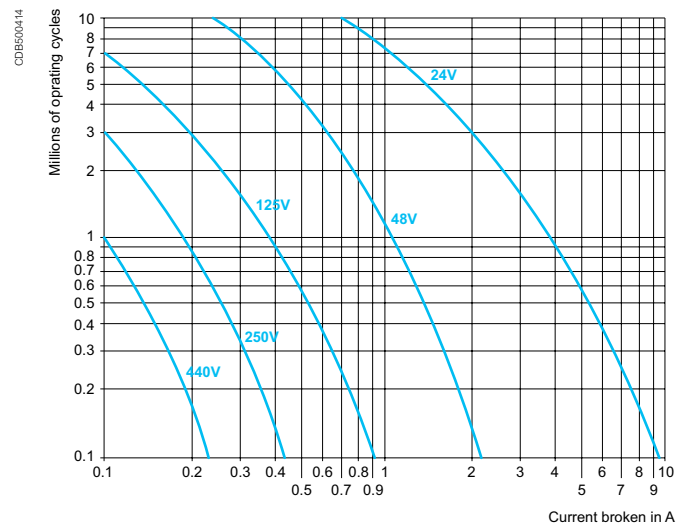
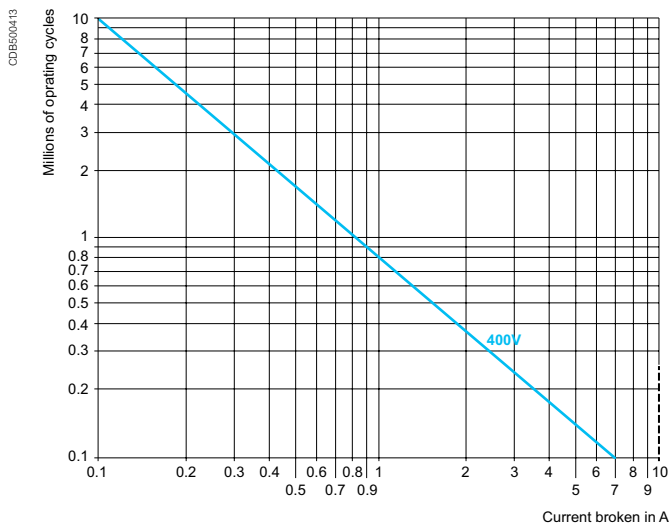

### CAE●●

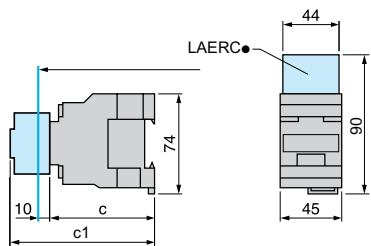

CAE	32	50
c	80	80
c1 with LAEN	113	113

### CAE

On mounting plate AM1-P

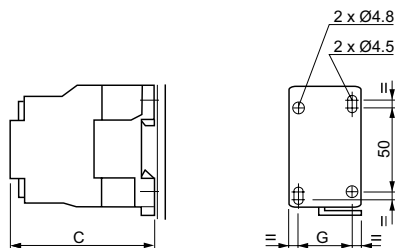

CAE~	
c	80
G	35

### CAE40

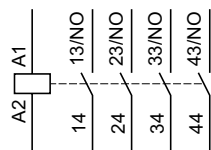

### CAE31

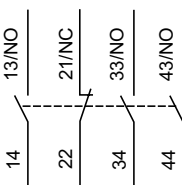

### CAE22

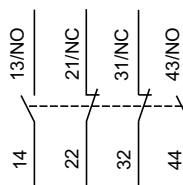

# EasyPact TVS control relays

## Auxiliary contact blocks

### RC suppressor

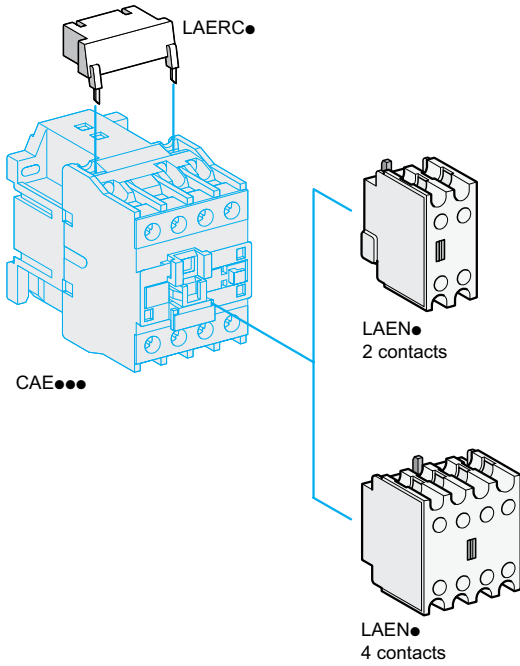

### Instantaneous auxiliary contact blocks

For use in normal operating environments <sup>(1)</sup>

Number of contacts	Maximum number of relays that can be mounted		Composition		Cat. no.	Weight kg
	Front mounted	Side mounted	NO	NC		
2	1	-	1	1	LAEN11	0.030
	1	-	2	-	LAEN20	0.030
	1	-	-	2	LAEN02	0.030
4	1	-	2	2	LAEN22	0.050

<sup>(1)</sup> For use in particularly harsh industrial environments, please consult the auxiliary contact blocks with dust and damp protected contacts in TeSys catalog.

### Coil suppressor modules

#### RC suppressor

- Effective protection for circuits highly sensitive to "high frequency" interference and transient generates when the contactor coil is switched off. For use only in cases where the voltage is virtually sinusoidal, i.e. less than 5 % total harmonic distortion.
- Voltage limited to 3 Uc max. and oscillating frequency limited to 400 Hz max.
- Slight increase in drop-out time (1.2 to 2 times the normal time).

Mounted on	Operational voltage	Cat. no.	Weight kg
CAE40●●	~24...48 V	LAERCE	0.012
	~110...240 V	LAERCU	0.012
	~50...120 V	LAERCG	0.012
	~380...415 V	LAERCN	0.012

# Protection components

## Thermal-magnetic motor circuit-breakers

### GZ1 E

#### Presentation

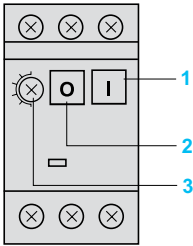

GZ1 E motor circuit-breakers are 3-pole thermal-magnetic circuit-breakers specifically designed for the control and protection of motors, conforming to standards IEC 60947-2 and IEC 60947-4-1.

#### Connection

These circuit-breakers are designed for connection by screw clamp terminals. This technique ensures secure, permanent and durable clamping that is resistant to harsh environments, vibration and impact and is even more effective when conductors without cable ends are used. Each connection can take two independent conductors.

#### Pushbutton control.

Energisation is controlled manually by operating the Start button "I" **1**. De-energisation is controlled manually by operating the Stop button "O" **2**, or automatically by the thermal-magnetic protection elements or by a voltage trip attachment.

#### Protection of motors and personnel

Motor protection is provided by the thermal-magnetic protection elements incorporated in the motor circuit-breaker.

The magnetic elements (short-circuit protection) have a non-adjustable tripping threshold, which is equal to about 13 times the maximum setting current of the thermal trips.

The thermal elements (overload protection) include automatic compensation for ambient temperature variations.

The rated operational current of the motor is displayed by means of a graduated knob **3**.

Personnel protection is also provided. All live parts are protected against direct finger contact.

GZ1 E motor circuit-breakers are easily installed in any configuration thanks to their universal fixing arrangement: screw fixing or clip-on mounting on symmetrical, asymmetrical or combination rails.

#### Environment

Circuit-breaker type		GZ1 E	
<b>Conforming to standards</b>		IEC 60947-2, IEC 60947-4	
<b>Protective treatment</b>	Conforming to IEC 60068-2-30	IEC60068-2-30 Test Db, Variant 2	
<b>Degree of protection</b>		In <b>GV2 MC01</b> enclosure: IP 41 In <b>GV2 MC02</b> enclosure: IP 55	
<b>Ambient air temperature</b>	Storage	°C	- 40...+ 80
	Operation		- 20...+ 60
<b>Flame resistance</b>	Conforming to IEC 60695-2-1	°C	960
<b>Maximum operating altitude</b>		m	2000
<b>Cabling</b>			<b>Min.</b>
Number of conductors and c.s.a.	Solid cable	mm <sup>2</sup>	2 x 1
	Flexible cable without cable end	mm <sup>2</sup>	2 x 1.5
	Flexible cable with cable end	mm <sup>2</sup>	2 x 1
			<b>Max.</b>
			2 x 6
			2 x 6
			2 x 4
<b>Suitable for isolation</b>			Yes
<b>Tightening torque</b>		N.m	1.7
<b>Rated operational voltage (U<sub>e</sub>)</b>		V	690
<b>Rated insulation voltage (U<sub>i</sub>)</b>		V	690
<b>Rated operational frequency</b>		Hz	50/60
<b>Rated impulse withstand voltage (U<sub>imp</sub>)</b>		kV	6
<b>Total power dissipated per pole</b>		W	2.5
<b>Mechanical durability (C.O.: closing, opening)</b>		C.O.	100 000
<b>Electrical durability</b> For AC-3 duty		C.O.	100 000
<b>Duty class (maximum operating rate)</b>		C.O./h	25

Breaking capacity			GZ1 E									
			Circuit-breaker type		01 to 06	07	08	10	14	16	20	21
Rating		A	0.1 to 1.6	2,5	4	6.3	10	14	14	18	23	25 to 32
<b>Breaking capacity</b>	230/240 V	Icu	kA	★	★	★	★	★	★	★	30	30
		Ics % <sup>(1)</sup>		★	★	★	★	★	★	★	100	100
conforming to IEC 60947-2	400/415 V	Icu	kA	★	★	★	★	★	10	10	10	10
		Ics % <sup>(1)</sup>		★	★	★	★	★	50	50	40	40
440 V	Icu	kA	★	★	★	30	10	6	6	5	5	
		Ics % <sup>(1)</sup>		★	★	★	100	100	50	50	50	50
500 V	Icu	kA	★	★	★	30	8	5	5	3	3	
		Ics % <sup>(1)</sup>		★	★	★	100	100	75	75	75	75
690 V	Icu	kA	★	2	2	2	2	2	2	2	2	
		Ics % <sup>(1)</sup>		★	75	75	75	75	75	75	75	75

★ > 100 kA.  
 (1) As % of Icu.

### Tripping curves

Average operating times at 20 °C related to multiples of the setting current

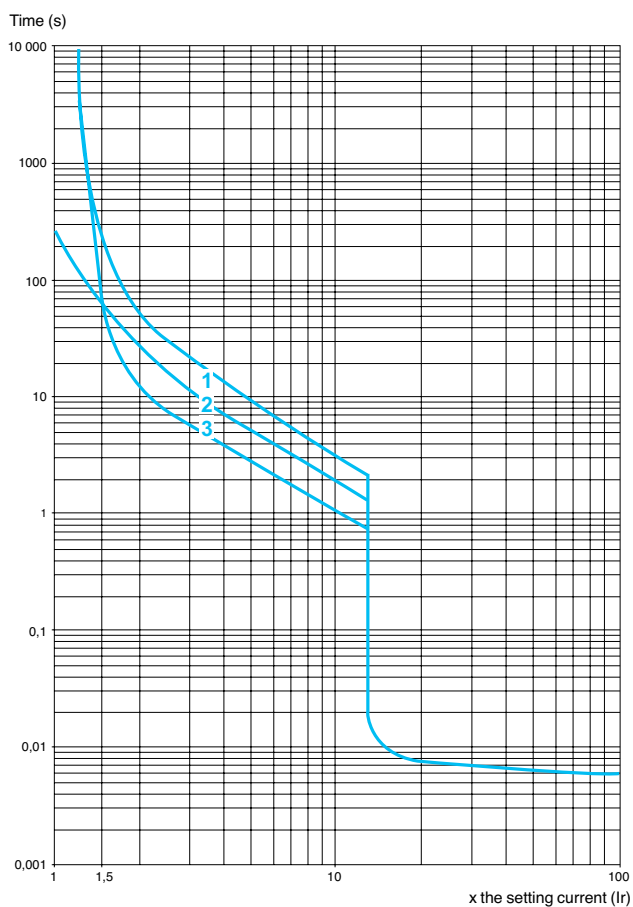

- 1 3 poles from cold state
- 2 2 poles from cold state
- 3 3 poles from hot state

# Protection components

## Thermal-magnetic motor circuit-breakers

### GZ1 E

CPB100407



GZ1 E

Motor circuit-breakers									
Pushbutton control									
Standard power ratings of 3-phase motors 50/60 Hz in category AC-3					Setting range of thermal trips	Magnetic tripping current $I_d \pm 20\%$	Reference	Weight	
230 V	400 V	440 V	500 V	690 V	A	A			kg
–	–	–	–	–	0.1...0.16	1.5	<b>GZ1 E01</b>	0.260	
–	–	–	–	–	0.16...0.25	2.4	<b>GZ1 E02</b>	0.260	
–	–	–	–	–	0.25...0.40	5	<b>GZ1 E03</b>	0.260	
–	–	–	–	0.37	0.40...0.63	8	<b>GZ1 E04</b>	0.260	
–	–	–	0.37	0.55	0.63...1	13	<b>GZ1 E05</b>	0.260	
–	0.37	0.55	0.75	1.1	1...1.6	22.5	<b>GZ1 E06</b>	0.260	
0.37	0.75	1.1	1.1	1.5	1.6...2.5	33.5	<b>GZ1 E07</b>	0.260	
0.75	1.5	1.5	2.2	3	2.5...4	51	<b>GZ1 E08</b>	0.260	
1.1	2.2	3	3.7	4	4...6.3	78	<b>GZ1 E10</b>	0.260	
2.2	4	4	5.5	7.5	6...10	138	<b>GZ1 E14</b>	0.260	
–	5.5	5.5	9	11	9...14	170	<b>GZ1 E16</b>	0.260	
4	7.5	9	10	15	13...18	223	<b>GZ1 E20</b>	0.260	
5.5	9	11	11	18.5	17...23	327	<b>GZ1 E21</b>	0.260	
5.5	11	11	15	22	20...25	327	<b>GZ1 E22</b>	0.260	
7.5	15	15	18.5	22	24...32	416	<b>GZ1 E32</b>	0.260	

# Protection components

## Thermal-magnetic motor circuit-breakers

### GZ1 E

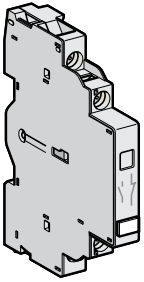

GZ1 AN11

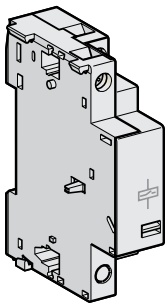

GZ1 AS115

#### Contact blocks

##### Instantaneous auxiliary contacts

Mounting	Maximum number	Type of contacts	Sold in lots of	Unit reference	Weight kg	Tightening torque
Side	2	N/O + N/C	1	<b>GZ1 AN11</b>	0.050	1.2
LH side		N/O + N/O	1	<b>GZ1 AN20</b>	0.050	1.2

#### Electric trips

Montage	Type	Tension		Reference	Weight kg	Tightening torque
Side (1 block on RH side of circuit- breaker)	Undervoltage trip	110...115 V	50 Hz	<b>GZ1 AU115</b>	0.105	1.2
		220...240 V	50 Hz	<b>GZ1 AU225</b>	0.105	1.2
		380...400 V	50 Hz	<b>GZ1 AU385</b>	0.105	1.2
	Shunt trip	110...115 V	50 Hz	<b>GZ1 AS115</b>	0.105	1.2
		220...240 V	50 Hz	<b>GZ1 AS225</b>	0.105	1.2

#### Mounting accessory

Description	Application	Sold in lots of	Unit reference	Weight kg
<b>Adapter plate</b>	For screw fixing of a GZ1 E	10	<b>GV2 AF02</b>	0.021

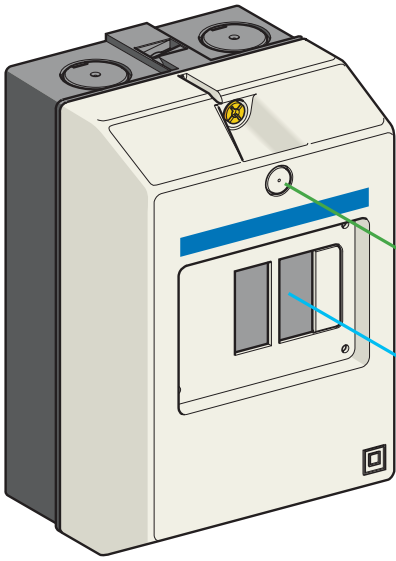

GV2 MC

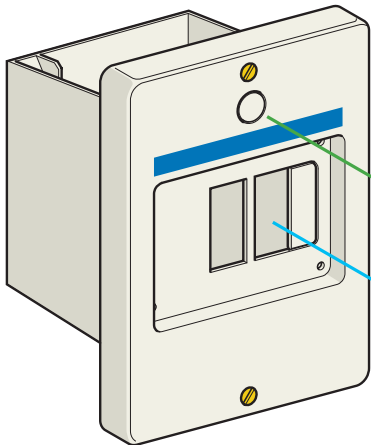

GV2 MP

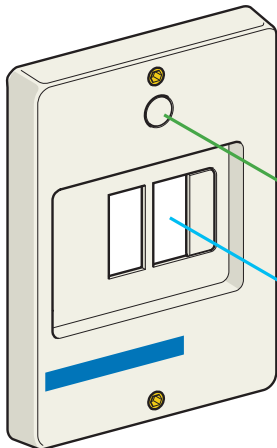

GV2 CP

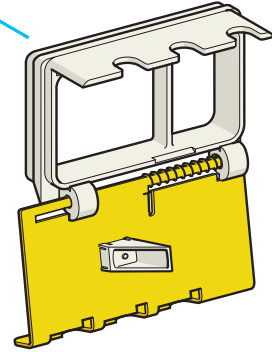
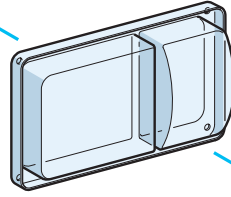

GV2 V01

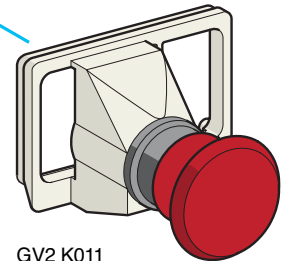
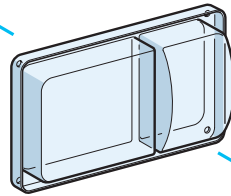

GV2 K011

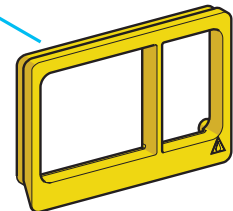
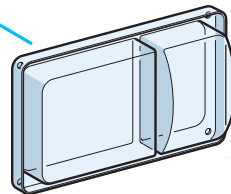

GV2 E01

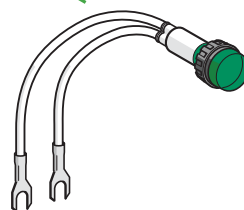

GV2 SN



# Protection components

## Thermal-magnetic motor circuit-breakers

### GZ1 E

#### Enclosures for thermal-magnetic circuit-breakers GZ1 E

Type	Degree of protection	Reference	Weight kg
Surface mounting, double insulated, with protective earth Sealable cover	IP 41	GV2 MC01	0.290
	IP 55	GV2 MC02	0.300
Flush mounting, with protective earth	IP 41 (front face)	GV2 MP01	0.115
	IP 55 (front face)	GV2 MP02	0.130

#### Front plate

Description	Degree of protection	Sold in lots of	Unit reference	Weight kg
For direct control, through a panel, of a chassis mounted GZ1 E	IP 55	1	GV2 CP21	0.800

#### Accessories common to all enclosures (to be ordered separately)

Padlocking device <sup>(1)</sup> for GZ1 E operator (padlocking is only possible in the "O" position)	1 to 3 padlocks Ø 4 to 8 mm	1	GV2 V01	0.075
Mushroom head "Stop" pushbutton, Ø 40 mm, red	Spring return <sup>(1)</sup>	1	GV2 K011	0.052
Sealing kit	For enclosures and front plate IP 55	10	GV2 E01	0.012
Neutral terminal		100	AB1 VV635UBL	0.015
Partition		50	AB1 AC6BL	0.003

Description	Voltage V	Colour	Sold in lots of	Unit reference	Weight kg
Pilot light with neon bulb	380/440	Green	10	GV2 SN33	0.019
		Red	10	GV2 SN34	0.019
		Orange	10	GV2 SN35	0.019
		Clear	10	GV2 SN37	0.019

(1) Supplied with IP 55 sealing kit. To be fitted with enclosures GV2 M●01.

#### Dimensions

##### GZ1 E

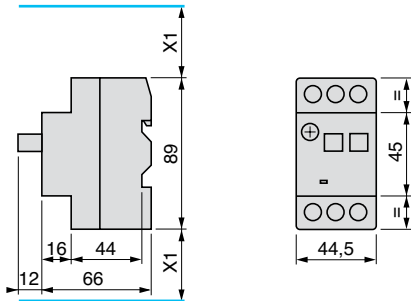

X1: electrical clearance = 40 mm for U<sub>e</sub> y 690 V.

##### GZ1 AN, GZ1 AU, GZ1 AS

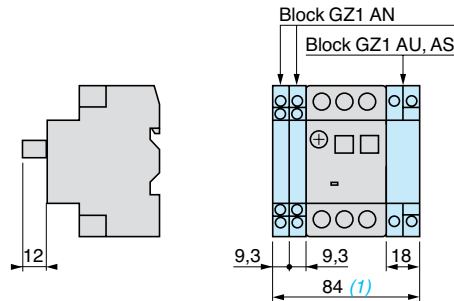

(1) max.

#### Mounting

##### GZ1 E on 35 mm ≤ rail

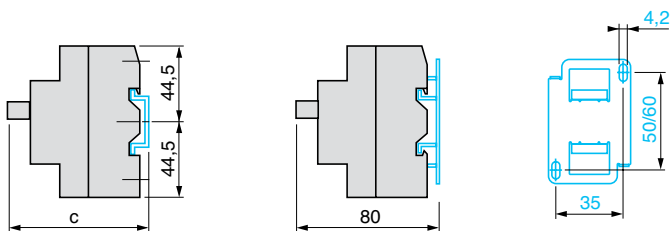

c = 78.5 on AM1 DP200 (35 x 7.5).  
c = 86 on AM1 DE200 and AM1 ED200 (35 x 15).

##### GZ1 E on pre-slotted mounting plate

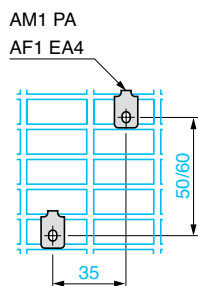

##### GZ1 E on rails DZ5 MB201, DZ5 ME8 or GV2 AF02

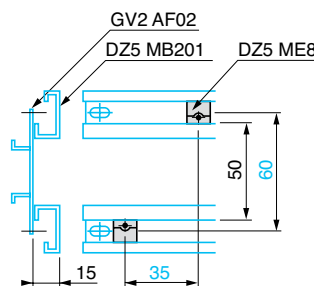

**Dimensions**

**Surface mounting enclosure GV2 MC0**

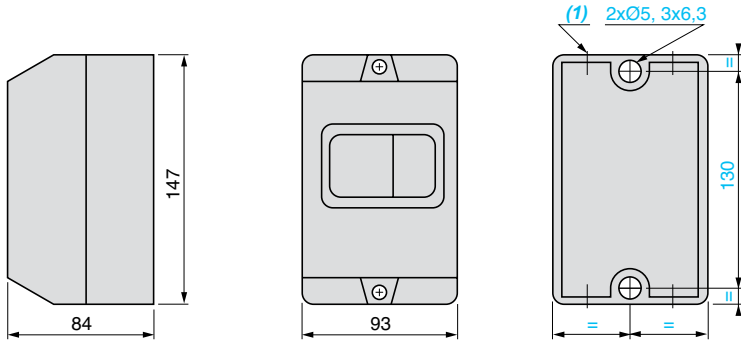

(1) 4 knock-outs for 16 mm plastic cable gland or 16 mm conduit.

**Front plate GV2 CP21**

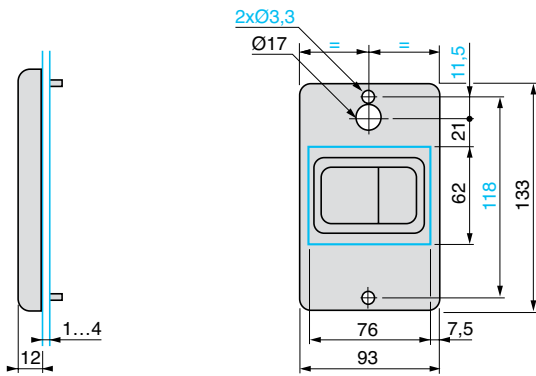

**Flush mounting enclosures GV2 MP01 and GV2 MP02**

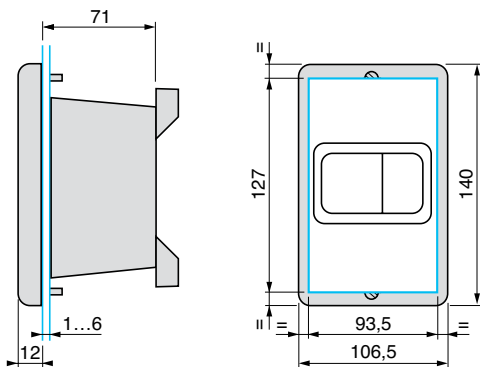

# Coordination between protection & control components

## Coordination: safety and faster restart after a short circuit

This benefit is obtained by choosing contactors with Schneider Electric guaranteed coordination.

## What exactly is coordination?

A contactor is said to be "coordinated" with the upstream protection device when its behaviour is controlled in the event of a short circuit. This behaviour of Type 1 coordination can be:

- > Guaranteed not to pose a danger to the workforce and not to damage the installation. It is accepted that the contactor should be destroyed or repaired.

## Compliance tests

Only the very stringent certified tests performed by Schneider Electric can guarantee the behaviour described by IEC 60947-4-1.

# EasyPact TVS LC1E06 to 630

## Type 1 coordination (IEC 60947-4-1)

### 400 - 440 V

Direct on line starter													
Motors					Switch-fuse <sup>(1)</sup>	Fuse-link type:	Fuse size	Switch-Fuse	Fuse-link type:	Fuse size	Contactors	Thermal o/l relays:	
P(KW)	400V I <sub>e</sub>	P(KW)	440V I <sub>e</sub>	I <sub>e</sub> max								Type	Type
0,06	0,2	0,06	0,19	0,25	GS* G	4	T000	GS* G	2	T000	LC1E06	LRE02	0.16..0.25
0,09	0,3	0,09	0,28	0,4	GS* G	4	T000	GS* G	2	T000	LC1E06	LRE03	0.25..0.4
-	-	0,12	0,37	0,63	GS* G	4	T000	GS* G	2	T000	LC1E06	LRE04	0.4..0.63
0,12	0,44	-	-	1	GS* G	4	T000	GS* G	2	T000	LC1E06	LRE05	0.63..1
0,18	0,6	0,18	0,55	1	GS* G	4	T000	GS* G	2	T000	LC1E06	LRE05	0.63..1
0,37	1,1	0,37	1	1,6	GS* G	4	T000	GS* G	2	T000	LC1E06	LRE06	1..1.6
0,55	1,5	0,55	1,36	1,6	GS* G	6	T000	GS* G	2	T000	LC1E06	LRE06	1..1.6
0,75	1,9	0,75	1,68	2,5	GS* G	10	T000	GS* G	4	T000	LC1E06	LRE07	1,6..2,5
-	-	1,1	2,37	2,5	GS* G	10	T000	GS* G	4	T000	LC1E06	LRE07	1,6..2,5
1,1	2,7	-	-	4	GS* G	10	T000	GS* G	4	T000	LC1E06	LRE08	2.5..4
1,5	3,6	1,5	3,06	4	GS* G	16	T000	GS* G	4	T000	LC1E06	LRE08	2.5..4
2,2	4,9	2,2	4,42	6	GS* G	16	T000	GS* G	6	T000	LC1E06	LRE10	4..6
3	6,5	3	5,77	8	GS* G	20	T000	GS* G	8	T000	LC1E09	LRE12	5,5..8
4	8,5	4	7,9	9	GS* G	25	T000	GS* G	12	T000	LC1E09	LRE14	7..10
5,5	11,5	5,5	10,4	12	GS* G	32	T000	GS* G	16	T000	LC1E12	LRE16	9..13
7,5	15,5	7,5	13,7	18	GS* G	40	T000	GS* G	16	T000	LC1E18	LRE21	12..18
9	18,1	9	16,9	24	GS* G	50	T000	GS* G	25	T000	LC1E25	LRE22	16..24
11	22	11	20,1	24	GS* G	50	T000	GS* G	25	T000	LC1E25	LRE22	16..24
15	29	15	26,5	32	GS* G	80	T000	GS* G	32	T000	LC1E32	LRE32	23..32
18,5	35	18,5	32,8	40	GS* G	80	T000	GS* G	40	T000	LC1E40	LRE355	30..40
22	41	22	39	50	GS* G	100	T000	GS* G	50	T000	LC1E50	LRE357	37..50
30	55	30	51,5	65	GS* KK	125	T00	GS* KK	80	T00	LC1E65	LRE359	48..65
37	66	37	64	70	GS* KK	160	T00	GS* KK	100	T00	LC1E80	LRE361	55..70
-	-	45	76	80	GSx L	200	T0	GS* KK	100	T00	LC1E80	LRE363	63..80
45	80	-	-	95	GSx L	200	T0	GS* KK	100	T00	LC1E95	LRE365	80..104
55	97	55	90	120	GSx L	200	T0	GS* L	125	T0	LC1E120	LRE482	84..135
75	132	75	125	160	GSx N	250	T1	GS* L	160	T0	LC1E160	LRE483	124..198
90	160	90	146	200	GSxQQ	350	T2	GS* N	200	T1	LC1E200	LRE483	124..198
110	195	110	178	234	GSxQQ	400	T2	GS* N	250	T1	LC1E250	LRE484	146..234
132	230	132	215	234	GS2 S	450	T3	GS* QQ	315	T2	LC1E250	LRE484	146..234
160	280	160	256	300	GS2 S	630	T3	GS* QQ	400	T2	LC1E300	LRE486	208..333
200	350	200	391	400	GS2 S	500	T3	GS* QQ	400	T3	LC1E400	LRE487	259...414
250	430	250	461	500	GS2 S	800	T3	GS* QQ	500	T3	LC1E500	LRE488	321....513
335	574	335	627	630	GS2 S	1000	T3	GS* QQ	630	T3	LC1E630	LRE489	394....630

(1) Proposed Switch-Fuse are for Blade fuse type. Other fuse type and according switch-fuse can be used.

# EasyPact TVS LC1E06 to 300

## Type 1 coordination (IEC 60947-4-1)

### with Switch Fuse

### 400 - 440 V

Star-delta starter																	
Motors							Switch-fuse <sup>(1)</sup>	Fuse-link type: gG cal(A)	Fuse size	Switch-Fuse Type	Fuse-link type: aM cal(A)	Fuse size	Line contactor Type	Delta contactor Type	Star contactor Type	Thermal o/l relays:	
P (KW)	400V		440V			Type										Type	Type
	I <sub>e</sub>	I <sub>rD</sub>	P (KW)	I <sub>e</sub>	I <sub>rD</sub>		I <sub>e max</sub>										
1,5	3,6	2,08	1,5	3,06	1,8	4	GS* G	10	T000	GS* G	4	T000	LC1E06	LC1E06	LC1E06	LRE07	1,6..2,5
2,2	4,9	2,83	2,2	4,42	2,6	6	GS* G	16	T000	GS* G	6	T000	LC1E06	LC1E06	LC1E06	LRE08	2,5..4
3	6,5	3,75	3	5,77	3,3	8	GS* G	16	T000	GS* G	8	T000	LC1E06	LC1E06	LC1E06	LRE08	2,5..4
4	8,5	4,9	4	7,9	4,6	10	GS* G	20	T000	GS* G	12	T000	LC1E06	LC1E06	LC1E06	LRE10	4..6
-	-	-	5,5	10,4	6	12	GS* G	20	T000	GS* G	16	T000	LC1E06	LC1E06	LC1E06	LRE10	4..6
5,5	11,5	6,64	-	-	-	16	GS* G	20	T000	GS* G	16	T000	LC1E09	LC1E09	LC1E09	LRE14	7..10
7,5	15,5	8,95	7,5	13,7	7,9	16	GS* G	32	T000	GS* G	16	T000	LC1E09	LC1E09	LC1E09	LRE14	7..10
9	18,1	10,5	9	16,9	9,8	20	GS* G	32	T000	GS* G	25	T000	LC1E12	LC1E12	LC1E09	LRE16	9..13
11	22	12,7	11	20,1	12	24	GS* G	50	T000	GS* G	25	T000	LC1E18	LC1E18	LC1E09	LRE21	12..18
15	29	16,7	15	26,5	15	32	GS* G	63	T000	GS* G	32	T000	LC1E18	LC1E18	LC1E09	LRE21	12..18
18,5	35	20,2	18,5	32,8	19	40	GS* G	80	T000	GS* G	40	T000	LC1E25	LC1E25	LC1E09	LRE22	16..24
22	41	23,7	22	39	23	43	GS* G	80	T000	GS* G	50	T000	LC1E25	LC1E25	LC1E09	LRE32	23..32
30	55	31,8	30	51,5	30	55	GS* KK	100	T00	GS* KK	80	T00	LC1E32	LC1E32	LC1E18	LRE35	30..38
37	66	38,1	37	64	37	70	GS* KK	125	T00	GS* KK	100	T00	LC1E40	LC1E40	LC1E40	LRE355	30..40
45	80	46,2	45	76	44	85	GSx L	160	T0	GS* KK	100	T00	LC1E50	LC1E50	LC1E40	LRE357	37..50
55	97	56	55	90	52	110	GSx L	200	T0	GS* L	125	T0	LC1E65	LC1E65	LC1E40	LRE359	48..65
75	132	76,2	75	125	72	140	GSx N	250	T1	GS* L	160	T0	LC1E80	LC1E80	LC1E65	LRE365	80..104
90	160	92,4	90	146	84	165	GSxQQ	350	T2	GS* N	200	T1	LC1E95	LC1E95	LC1E80	LRE365	80..104
110	195	113	110	178	103	210	GSxQQ	400	T2	GS* N	250	T1	LC1E120	LC1E120	LC1E95	LRE482	84..135
132	230	133	132	215	124	280	GS2 S	450	T3	GS* QQ	315	T2	LC1E160	LC1E160	LC1E120	LRE483	124..198
160	280	162	160	256	148	300	GS2 S	500	T3	GS* QQ	315	T2	LC1E200	LC1E200	LC1E160	LRE483	124..198
220	388	224	220	350	202	405	GS2 S	630	T3	GS* QQ	400	T2	LC1E250	LC1E250	LC1E200	LRE484	146..234
260	480	277	220	430	248	500	GS2 S	800	T3	GS2 S	500	T3	LC1E300	LC1E300	LC1E250	LRE486	208..333

(1) Proposed Switch-Fuse are for Blade fuse type. Other fuse type and according switch-fuse can be used.

# EasyPact TVS LC1E09 to 32

## Type 1 coordination (IEC 60947-4-1)

### with Circuit Breaker GZ1E

### 440 V

0.06kW to 15kW at 440V: Type 1 coordination					
Standard power ratings of 3-phase motors 50/60 Hz in Category AC-3			Circuit-breaker		Contactor
440V			Reference	Setting range of thermal trips A	Reference
P	I <sub>e</sub>	I <sub>q</sub>			
kW	A	kA			
0.06	0.19	50	GZ1E02	0.16...0.25	LC1E09
0.09	0.28	50	GZ1E03	0.25...0.40	LC1E09
0.12	0.37	50			
0.18	0.55	50	GZ1E04	0.40...0.63	LC1E09
0.25	0.76	50	GZ1E05	0.63...1	LC1E09
0.37	0.99	50			
0.55	1.36	50	GZ1E06	1...1.6	LC1E09
0.75	1.68	50	GZ1E07	1.6...2.5	LC1E09
1.1	2.37	50			
1.5	3.06	50	GZ1E08	2.5...4	LC1E09
2.2	4.42	50	GZ1E10	4...6.3	LC1E09
3	5.77	50			
4	7.9	15	GZ1E14	6...10	LC1E09
5.5	10.5	8	GZ1E16	9...14	LC1E12
7.5	13.7	8	GZ1E20	13...18	LC1E18
9	16.9	8			
11	20.1	6	GZ1E21	17...23	LC1E25
			GZ1E22	20...25	LC1E25
15	26.5	6	GZ1E32	24...32	LC1E32

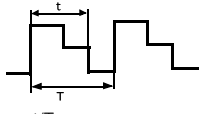
Altitude	<p>The rarefied atmosphere at high altitude reduces the dielectric strength of the air and hence the rated operational voltage of the contactor. It also reduces the cooling effect of the air and hence the rated operational current of the contactor (unless the temperature drops at the same time). No derating is necessary up to 3000 m.</p> <p>Derating factors to be applied above this for main pole operational voltage and current (a.c. supply) are as follows:</p> <table border="1"> <thead> <tr> <th>Altitude</th> <th>3500m</th> <th>4000m</th> <th>4500m</th> <th>5000m</th> </tr> </thead> <tbody> <tr> <td>Rated operational voltage</td> <td>0.90</td> <td>0.80</td> <td>0.70</td> <td>0.60</td> </tr> <tr> <td>Rated operational current</td> <td>0.92</td> <td>0.90</td> <td>0.88</td> <td>0.86</td> </tr> </tbody> </table>	Altitude	3500m	4000m	4500m	5000m	Rated operational voltage	0.90	0.80	0.70	0.60	Rated operational current	0.92	0.90	0.88	0.86
Altitude	3500m	4000m	4500m	5000m												
Rated operational voltage	0.90	0.80	0.70	0.60												
Rated operational current	0.92	0.90	0.88	0.86												
Ambient air temperature	<p>The temperature of the air surrounding the device, measured near to the device. The operating characteristics are given:</p> <ul style="list-style-type: none"> <li>■ with no restriction for temperatures between -5 and +55 °C</li> <li>■ with restrictions, if necessary, for temperatures between -20 and +70 °C. Please consult your local Schneider Electric office.</li> </ul>															
Rated operational current (Ie)	This is defined taking into account the rated operational voltage, operating rate, utilisation category and ambient temperature around the device.															
Conventional thermal current (Ith) <sup>(1)</sup>	The current which a closed contactor can sustain for a minimum of 8 hours without its temperature rise exceeding the limits given in the standards.															
Permissible short-time rating	The current which a closed contactor can for a short time after a period of no load, without dangerous overheating.															
Rated operational voltage (Ue)	This is the voltage value which, in conjunction with the rated operational current, determines the use of the contactor or starter, and on which the corresponding tests and the utilisation category are based. For 3-phase circuits, it is expressed as the voltage between phases.															
Rated control circuit voltage (Uc)	The rated value of the control circuit voltage, on which the operating characteristics are based. For a.c. applications, the values are given for a sinusoidal wave form (less than 5% total harmonic distortion).															
Rated insulation voltage (Ui)	This is the voltage value used to define the insulation characteristics of a device and referred to in dielectric tests determining leakage paths. As the specifications are not identical for all standards, the rated value given for each of them is not necessarily the same.															
Rated impulse withstand voltage (Uimp)	The peak value of a voltage surge which the device is able to withstand without breaking down.															
Rated operational power (expressed in kW)	The rated power of the standard motor which can be switched by the contactor, at the rated operational voltage.															
Rated breaking capacity <sup>(2)</sup>	This is the current value which the contactor can break in accordance with the breaking conditions specified in the IEC standard.															
Rated making capacity <sup>(2)</sup>	This is the current value which the contactor can make in accordance with the making conditions specified in the IEC standard.															
On-load factor (m)	<p>This is the ratio between the time the current flows (t) and the duration of the cycle (T).</p>  <p><math>m = t/T</math></p> <p>Cycle duration: duration of current flow + time at zero current.</p>															
Pole impedance	The impedance of one pole is the sum of the impedance of all the circuit components between the input terminal and the output terminal. The impedance comprises a resistive component (R) and an inductive component ( $X = L\omega$ ). The total impedance therefore depends on the frequency and is normally given for 50 Hz. This average value is given for the pole at its rated operational current.															
Electrical durability	This is the average number of on-load operating cycles which the main pole contacts can perform without maintenance. The electrical durability depends on the utilisation category, the rated operational current and the rated operational voltage.															
Mechanical durability	This is the average number of no-load operating cycles (i.e. with zero current flow through the main pole) which the contactor can perform without mechanical failure.															

<sup>(1)</sup> Conventional thermal current, in free air, conforming to IEC standards.  
<sup>(2)</sup> For a.c. applications, the breaking and making capacities are expressed by rms value of the symmetrical component of the short-circuit current. Taking into account the maximum asymmetry which may exist in the circuit, the contacts therefore have to withstand a peak asymmetrical current which may be twice the rms symmetrical component.

**Note:** these definitions are extracted from standard IEC 60947-1.



**Contactors utilisation categories conforming to IEC 60947-4**

The standard utilisation categories define the current values which the contactor must be able to make or break.

These values depend on:

- the type of load being switched: squirrel cage or slip ring motor, resistors
- the conditions under which making or breaking takes place: motor stalled, starting or running, reversing, plugging.

**a.c. applications****■ Category AC-1:**

This category applies to all types of a.c. load with a power factor equal to or greater than 0.95.

Examples: heating, lighting, distribution.

**■ Category AC-3:**

This category applies to squirrel cage motors with breaking during normal running of the motor. On closing, the contactor makes the starting current, which is about 7 times the rated current of the motor.

On opening, it breaks the rated current drawn by the motor; at this point, the voltage at the contactor terminals is about 20 % of the mains supply voltage. Breaking is light. For example: all standard squirrel cage motors: lifts, escalators, conveyor belts, bucket elevators, compressors, pumps, mixers, air condition units, etc...

**■ Category AC-4:**

The contactor closes at a current peak which may be as high as 5 or 7 times the rated motor current. On opening it breaks this same current at a voltage which is higher, the lower the motor speed. This voltage can be the same as the mains voltage. Breaking is severe.

This category covers applications with plugging and inching of squirrel cage and slip ring motors.

For example: printing machines, wire drawing machines, cranes and hoists, metallurgy industry.

# Technical information

## Current of asynchronous squirrel cage motors at nominal load

3-phase 4-pole motors				
Current values for power in kW				
Rated operational power (1)	Indicative rated operational current values at:			
	230 V	400 V	500 V	690 V
kW	A	A	A	A
0.06	0.35	0.2	0.16	0.12
0.09	0.52	0.3	0.24	0.17
0.12	0.7	0.44	0.32	0.23
0.18	1	0.6	0.48	0.35
0.25	1.5	0.85	0.68	0.49
0.37	1.9	1.1	0.88	0.64
0.55	2.6	1.5	1.2	0.87
0.75	3.3	1.9	1.5	1.1
1.1	4.7	2.7	2.2	1.6
1.5	6.3	3.6	2.9	2.1
2.2	8.5	4.9	3.9	2.8
3	11.3	6.5	5.2	3.8
4	15	8.5	6.8	4.9
5.5	20	11.5	9.2	6.7
7.5	27	15.5	12.4	8.9
11	38	22	17.6	12.8
15	51	29	23	17
18.5	61	35	28	21
22	72	41	33	24
30	96	55	44	32
37	115	66	53	39
45	140	80	64	47
55	169	97	78	57
75	230	132	106	77
90	278	160	128	93
110	340	195	156	113
132	400	230	184	134
160	487	280	224	162
200	609	350	280	203
250	748	430	344	250
315	940	540	432	313
355	1061	610	488	354
400	1200	690	552	400
500	1478	850	680	493
560	1652	950	760	551
630	1844	1060	848	615
710	2070	1190	952	690
800	2340	1346	1076	780
900	2640	1518	1214	880
1000	2910	1673	1339	970

(1) Values conforming to standard IEC60072-1 (at 50Hz).

**Note:** These values are given as a guide. They may vary depending on the type of motor, its polarity and the manufacturer.

# Technical information

## Product standards and certifications

### Standardisation

#### Conformity to standards

Schneider Electric products satisfy, in the majority of cases, European (for example: CENELEC) or international (IEC) standards. These product standards precisely define the performance of the designated products (such as IEC 60947 for low voltage equipment).

When used correctly, as designated by the manufacturer and in accordance with regulations and correct practices, these products will allow users to build equipment, machine systems or installations that conform to their appropriate standards (for example: IEC 60204-1, relating to electrical equipment used on industrial machines).

Schneider Electric is able to provide proof of conformity of its production to the standards it has chosen to comply with, through its quality assurance system. On request, and depending on the situation, Schneider Electric can provide the following:

- a declaration of conformity
- a certificate of conformity
- a homologation certificate or approval, in the countries where this procedure is required or for particular specifications, such as those existing in the merchant navy.

Code	Certification authority		Country
	Name	Abbreviation	
EAC	Eurasian Conformity	EAC	Russia
IEC	International Electrotechnical Commission	IEC	Worldwide

### Regulations

#### European Directives

Opening up of European markets assumes harmonisation of the regulations pertaining to each of the member countries of the European Union.

The purpose of the European Directive is to eliminate obstacles hindering the free circulation of goods within the European Union, and it must be applied in all member countries. Member countries are obliged to transcribe each Directive into their national legislation and to simultaneously withdraw any contradictory regulations. The Directives, in particular those of a technical nature which concern us, only establish the objectives to be achieved, referred to as "essential requirements".

The manufacturer must take all the necessary measures to ensure that his products conform to the requirements of each Directive applicable to his production.

As a general rule, the manufacturer certifies conformity to the essential requirements of the Directive(s) for his product by affixing the CE marking.

The CE marking is affixed to Schneider Electric brand products concerned, in order to comply with French and European regulations.

#### Significance of the CE marking

- The CE marking affixed to a product signifies that the manufacturer certifies that the product conforms to the relevant European Directive(s) which concern it; this condition must be met to allow free distribution and circulation within the countries of the European Union of any product subject to one or more of the E.U. Directives.
- The CE marking is intended solely for national market control authorities.
- The CE marking must not be confused with a conformity marking.

#### European Directives (continued)

For electrical equipment, only conformity to standards signifies that the product is suitable for its designated function, and only the guarantee of an established manufacturer can provide a high level of quality assurance.

For Schneider Electric brand products, one or several Directives are likely to be applicable, depending on the product, and in particular:

- the Low Voltage Directive 2014/35/EU: the CE marking relating to this Directive has been compulsory since 16th January 2007.
- the Electromagnetic Compatibility Directive 2014/30/EU.

### Note

For further details on a specific product, please refer to the "Characteristics" pages in this catalogue or consult your Regional Sales Office.





Life Is 

**Schneider**  
 Electric

**Schneider Electric India Pvt. Ltd.**

Corporate Office  
9th Floor, DLF Building No.10,  
Tower C, DLF Cyber City, Phase II,  
Gurgaon - 122002, Haryana.  
Tel: 0124 3940400, Fax: 0124 4222036  
[www.schneider-electric.co.in](http://www.schneider-electric.co.in)

**Customer Care Centre**

Toll-free numbers: 1800 103 0011, 1800 419 4272  
General number: 0124 4222040  
Email: [in.campaign@schneider-electric.com](mailto:in.campaign@schneider-electric.com)

## X-ON Electronics

Largest Supplier of Electrical and Electronic Components

*Click to view similar products for [Schneider manufacturer](#):*

Other Similar products are found below :

[XS518B1DAM12](#) [RE22R2MMW](#) [W9AS5A52-24](#) [RE22R2MYMR](#) [67SPCX-56](#) [70-454](#) [70-750EL8-1](#) [70S2-05-B-12-S](#) [712XBXC-240A](#)  
[788XCXRM4L-24D](#) [78RPCX-3](#) [MMS124](#) [8501NR45](#) [8501NR52](#) [8501RS42V20](#) [8501RS44V24](#) [8501RSD14P14V51](#) [8501XO20V03Y414](#)  
[861HSSR410-AC-1](#) [9001K35H2](#) [9001K51](#) [9001KP35LRR9](#) [9001KS11FB](#) [9001KS43BH2](#) [9001KXRK](#) [9001SKT35L31](#) [9003K2C003GA](#)  
[9007AA1](#) [9007BA1](#) [9007C54D](#) [9007C54K](#) [9007CA11](#) [9007FA3](#) [9007HA2](#) [9007HA4](#) [9007HA6](#) [9007KA1](#) [9007MA18](#) [9007MS01S0300](#)  
[9007MS02S0100](#) [9007MS02S0300](#) [9012GAW5K1](#) [9012GDW5E3](#) [9012GFW1](#) [9012GNG1](#) [9012GNG3](#) [9013FHG39J69](#) [9013FSG52J33M4](#)  
[9013GHG2J57X](#) [11HPX-75](#)