



Harmony Electromechanical Relays

Interface, miniature, and power
electromechanical relays



Harmony

Discover Harmony

Advanced operator interface and industrial relays

Harmony operator interface and industrial relays enhance operational efficiency and equipment availability across industrial and building applications. **Harmony** includes intelligent connected products and edge terminals that visualize, gather and process data, enabling informed operator decisions.

Explore our offer

- [Harmony Push Buttons and Switches](#)
- [Harmony HMI Operator Terminals, IPC and EdgeBox](#)
- [Harmony Signaling Devices](#)
- [Harmony Electrical Relays](#)
- [Harmony Safety](#)

Life Is On

Schneider
Electric

Quick access to product information

Get technical information about your product

References

Modicon TM3
I/O expansion modules for Modicon controllers
Analog I/O modules

Number and type of channels	Input range	Resolution	Input format (max)	Reference	Weight (kg)
2 voltage inputs	-15...+10 VDC 0...20 mA r.t. 20 mA	16,000 or 10,000 r.s.g.	0VDC 0VDC 0VDC	TM3AI2H TM3AI2HG TM3AI2H	0.110 0.206 0.100
4 voltage inputs	-15...+10 VDC 0...20 mA r.t. 20 mA	12,000 or 10,000 r.s.g.	0VDC 0VDC 0VDC	TM3AI4 TM3AI4G TM3AI4	0.100 0.206 0.100
4 voltage or temperature inputs	-15...+10 VDC 0...20 mA r.t. 20 mA	16,000 or 10,000 r.s.g.	0VDC 0VDC 0VDC	TM3AI2H TM3AI2HG TM3AI2H	0.110 0.206 0.100
4 differential temperature inputs	0...100 °C 0...100 °F 0...100 °C 0...100 °F	16,000 or 10,000 r.s.g.	0VDC 0VDC 0VDC 0VDC	TM3TI4 TM3TI4G TM3TI4 TM3TI4G	0.110 0.206 0.100 0.200
8 voltage inputs	-15...+10 VDC	12,000 or 10,000 r.s.g.	0VDC	TM3AI8	0.110

Share Price Global (English) My Products My Documents Partner Portal

Life Is On Schneider Electric Search products, documents & more

PRODUCTS SOLUTIONS SERVICES SUPPORT ABOUT US

All products Industrial Automation and Control PLC, PAC and Dedicated Controllers Distributed Input/Output (I/O) Modules Modicon TMI

View all Modicon TMI

TM3AI2H

Module TM3 - 2 analog inputs high resolution

Show more characteristics >

Related Software >

Add to My Products Compare

Product Datasheet User guide Catalogue CAD Document

Characteristics Documents and Downloads Technical FAQs Additional Information Dimensions Drawings >

Main

range of product Modicon TMI

product or component type Analog input module

range compatibility Modicon M251

Each commercial reference presented in a catalog contains a hyperlink. Click on it to obtain the technical information of the product:

- Characteristics, Dimensions and drawings, Mounting and clearance, Connections and schemas, Performance curves
- Product image, Instruction sheet, User guide, Product certifications, End of life manual

Find your catalog

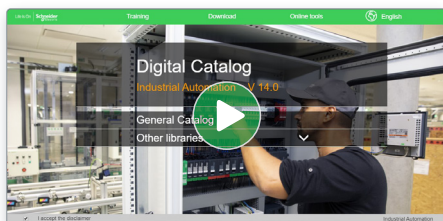

- > With just 3 clicks, you can access the Industrial Automation and Control catalogs, in both English and French
- > Consult digital automation catalogs at [Digi-Cat Online](#)

Industrial Automation

General Catalog

- Publications, Selections, PLCs & PACs
- Books, Catalogs & Interfaces
- Signaling Devices
- HMI (Terminals and Industrial PC)
- Sensors & RFID System
- Motor Starters and Load Management
- Components for Motor Starters
- Variable Speed Drives & Soft Starters
- Motor Control & Robotics
- Interface, Measurement & Control Relays
- PLC, PAC & other Controllers

Publications, Selections, PLCs & PACs

Hardware 380

Product Selector

360°

- Up-to-date catalogs
- Embedded product selectors, 360° pictures
- Optimized search by commercial references

Select your training



- > Find the right [Training](#) for your needs on our Global website
- > Locate the training center with the selector tool, using this [link](#)

Training and courses

Training by domain of expertise

- Electrical Installation and Safety
- Data Center
- Industrial Automation

Harmony Electromechanical Relays

Interface, miniature, and power electromechanical relays

General presentation

- RSL relays for compactness page 2
- RXG relays for reliability page 2
- RXM relays for automation control page 3
- Selection guide of Plug-in relays and relays with clamp fixing* page 4

RSL slim interface relays

- **Presentation**
 - Presentation of the range page 10
 - Relay description page 10
 - Socket description page 10
- **References**
 - Pre-assembled slim interface relays page 11
 - Slim interface relays for customer assembly page 11
 - Accessories for sockets page 11

RSB interface relays

- **Presentation**
 - Presentation of the range page 12
 - Socket description page 12
- **References**
 - Pre-assembled interface relays page 13
 - Interface relays for customer assembly page 14
 - Sockets with separate contact terminal arrangement and connector connection page 14
 - Protection modules page 14
 - Accessories page 13

RXG interface relays

- **Presentation**
 - Presentation of the range page 16
 - Relay description page 16
 - Socket description page 16
- **References**
 - Pre-assembled interface relays page 17
 - Interface relays for customer assembly page 17
 - Sockets with separate contact terminals, screw connector connection, and built-in clamp page 19
 - Protection modules page 19
 - Accessories page 19

RXM miniature relays

- **Presentation**
 - Presentation of the range page 20
 - Relay description page 20
 - Socket description page 20
- **References**
 - Pre-assembled interface relays page 21
 - Miniature relays for customer assembly page 22
 - Sockets page 23
 - Protection modules page 23
 - Timing relays page 23
 - Accessories page 24

Harmony Electromechanical Relays

Interface, miniature, and power electromechanical relays

782H hermetically sealed relays

- **Presentation**
- Presentation of the range..... [page 26](#)
- Relay description [page 26](#)
- Socket description [page 26](#)
- **References** [page 26](#)
- 782H Hermetically sealed relays [page 27](#)
- Sockets..... [page 27](#)
- Socket modules [page 27](#)
- Socket accessories..... [page 27](#)

725 power relays

- **Presentation**
- Presentation of the range..... [page 28](#)
- Relay description [page 28](#)
- Socket description [page 28](#)
- **References** [page 29](#)
- 725 power relays [page 29](#)
- Sockets..... [page 29](#)
- Socket modules [page 29](#)
- Socket accessories..... [page 29](#)

RPM power relays

- **Presentation**
- Presentation of the range..... [page 30](#)
- Relay description [page 30](#)
- Socket description [page 30](#)
- **References** [page 31](#)
- Power relays for customer assembly [page 31](#)
- Sockets..... [page 32](#)
- Protection modules..... [page 32](#)
- Timer module..... [page 32](#)
- Accessories [page 33](#)

RUM universal relays

- **Presentation**
- Presentation of the range..... [page 34](#)
- Relay description [page 34](#)
- Socket description [page 35](#)
- **References** [page 36](#)
- Universal relays for customer assembly [page 36](#)
- Sockets..... [page 37](#)
- Protection modules..... [page 37](#)
- Timer module..... [page 37](#)
- Timing relays [page 37](#)
- Accessories [page 37](#)

RPF power relays

- **Presentation**..... [page 38](#)
- **References** [page 39](#)

Technical presentation

- **Relays**..... [page 40](#)
- **Protection modules**..... [page 41](#)

Index

- **Product reference index**..... [page 42](#)

Harmony Electromechanical Relays

Interface, miniature, and power electromechanical relays

Harmony Electromechanical Relays

Used to multiply the number of input and output contacts, or for logic processing control

RSL relays are compact modular relays conforming to IEC/EN 61810-1, UL508, CSA C22.2 No. 14, and EAC international standards.

Harmony relays offer interface, miniature, universal, and power electromechanical relays, from 1 CO to 4 CO contacts, up to 30 A. The electromechanical relays help to reduce the size of enclosures and at the same time increase machine reliability.

RSL relays for compactness

Flexible offer

- > Available as a single-referenced complete product (relay and socket) or customer-assembled product
- > Wide choice of sockets ranging from 12 to 230 V ~
- > Standard and low level contact types

Enhanced performance

- > Sockets with integrated reverse polarity protection circuit
- > Relays for high breaking capacity or low-level current application requirements
- > Power-on and Relay status LED indicator

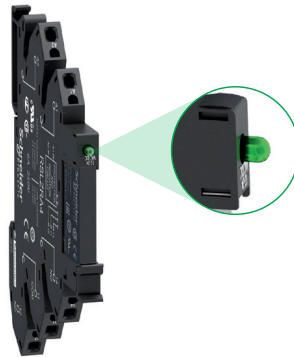

LED indicator for RSL relay status

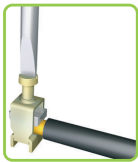

Screw connector



Spring terminal

Simple installation and cabling

- > Locking/unlocking lever for removing and replacing the relay in the socket
- > Simple DIN rail mounting and commoning link accessory
- > Choice of screw connector or spring terminal connection for sockets

RXG relays for reliability

Complete offer

RXG relays offer a broad range of coil voltages, from 6 V to 110 V \pm and 24 V to 230 V ~. The relays are available with/without lockable test button, LED, and clear cover.



Easy to mount and use

These are the latest relays with a single-step lockable test button. The Faston pin terminal mounts quickly and securely. The slim 16 mm/0.629 in. socket for 2 CO saves panel space.



Single-step lockable test button

Harmony RXG → Latest interface relay with easy testing function

RXG relays for reliability (continued)

Expandable relays

RXG relays can be expanded with protection modules such as diode, diode with LED, varistor with LED, and RC circuit.



RXM industrial relays bring features for easy and improved control of simple and complex automation systems.

RXM relays for automation control

Easy to select

- > Wider choice of contacts (2, 3, and 4 CO)
- > Broad range of control circuit voltages and different socket types
- > Configurator available in Apple App and Android Play Store



Convenient to use

- > One-step lockable test button
- > Mechanical indicator for contact status
- > "Power On" LED for readiness

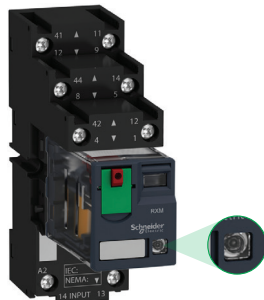

LED indicator for relay status

Simple to install

- > Push and stay spring clamp socket wiring (no screwdriver required) provides up to 65% time saving
- > Sockets for both DIN rail and panel mounting, time-saving bus jumper
- > Direct mounting with DIN rail or flange adapter



Push and stay spring clamp terminal: insert without tool

Designed to perform

- > Eco-design with RoHS and REACH
- > Flexible add-on protection modules
- > Spring clamp socket with 20 kg/44 lb wire pull-out force and reliable retention force on cables

Note: The Zelio Relays range name has been changed in 2020 to Harmony Relays. As the timeline for each range is different, during the transition period there will be both Zelio and Harmony ranges shown on different product datasheets and packaging.

Harmony RXM → Miniature in size and powerful in performance

Type of product

Plug-in relays
Slim interface relays

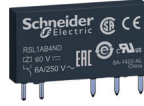

Number and type of contacts/conventional thermal current (Ith on NO contact)	
Control circuit voltage	~ —
Pin type	
Operational voltage	
Durability (operating cycles per hour)	Electrical, resistive load Mechanical, no-load
Functions	LED Mechanical indicator Test button Contact type
Type references	
Pages	
Type of associated sockets	

1 CO/6 A
-
12...60 V
Flat (PCB type, reinforced)
Up to 400 V ~ / 300 V —
60,000
10,000,000
No
No
No
Standard and low level
RSL1●B4●D (1)
11
Sockets with LED and protection circuit



Contact terminal arrangements	
Connection	
Accessories	Protection modules Timer module Maintaining clamps Socket identification legend Mounting adapters for DIN rail Mounting adapters with fixing lugs Bus jumper
Conventional thermal current (Ith)	
Type references	
Pages	

Separate	
Screw connector	Spring terminals
No	No
No	No
No	No
Yes	Yes
No	No
No	No
Yes, 20-pole	Yes, 20-pole
6 A	6 A
RSLZV●●	RSLZR●●
11	

(1) Pre-assembled interface relays RSL1PV●● and RSL1PR●● (standard type relay + socket), RSB (relay + socket + clamp + protection module + label), and RXG (relay + socket + protection module) are also available.
 (2) When using relay RSB1A160●● with socket RSZE1S48M, terminals must be linked.

Harmony Electromechanical Relays

Interface, miniature, and power electromechanical relays

Type of product	
Number and type of contacts/conventional thermal current (I_{th} on NO contact)	
Control circuit voltage	~ =
Pin type	
Operational voltage	
Durability (operating cycles per hour)	Electrical, resistive load Mechanical, no-load
Functions	LED Mechanical indicator Test button Contact type
Type references	
Pages	
Type of associated sockets	

Plug-in relays
Miniature relays



2 CO/12 A 3 CO/10 A 4 CO/6 A 4 CO/3 A (low level)
24...240 V 12...220 V
Flat (Faston type)
Up to 250 V ~
100,000 10,000,000
Yes (depending on version) Yes Yes, lockable Standard and low level
RXM●●●●●● (1)
21
Sockets without LED



Contact terminal arrangements	
Connection	
Accessories	Protection modules Timer module Maintaining clamps Socket identification legend Mounting adapters for DIN rail Mounting adapters with fixing lugs Bus jumper
Conventional thermal current (I_{th})	
Type references	
Pages	

Mixed		Separate	
Screw connector	Screw clamp terminals	Screw connector	Push-in terminals
Yes		Yes	Yes
No		No	No
Yes		Yes	Yes (plastic, integrated)
Yes	No	Yes	Yes
Yes		Yes	Yes
Yes		Yes	Yes
No		Yes, 2-pole (I _{th} = 5 A)	Yes, 2-pole
10 A	10 A	12 A for 2 CO (2) 6 A for 4 CO	12 A for 2 CO 6 A for 4 CO
RXZE2M114M	RXZE2M114	RXZE2S●●●M	RXZE14P
23			

(1) Pre-assembled miniature relays RXM (relay + socket + clamp + label) are also available.
 (2) Except for sockets RXZE2S11●M: 10 A.
 (3) To be used with specified sockets only.
 (4) When using relay RSB1A160●● with socket RSZE1S48M, terminals must be linked.

Harmony Electromechanical Relays

Interface, miniature, and power electromechanical relays

Type of product

Plug-in socket mount
Power relays

Panel/DIN rail mount with flat (Faston type) terminals

Panel/DIN rail mount with screw terminals

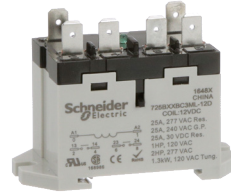

Number and type of contacts/conventional thermal current (Ith on NO contact)	
Control circuit voltage	~ ---
Pin type	
Operational voltage	
Durability (operating cycles per hour)	Electrical, resistive load Mechanical, no-load
Functions	LED
	Mechanical indicator
	Test button
	Contact type
Type references	
Pages	
Type of associated sockets	

1 NO/30 A 2 NO/25 A		
24...240 V 12...24 V		
Flat (Faston type)	Flat (Faston type)	Screw type
Up to 264 V ~/26.4 V ---		
100,000 5,000,000		
Yes	Yes	Yes
Yes	No	No
Yes, lockable	Yes, non-lockable	Yes, non-lockable
Standard		
725•XX•BM4L-•	725•XX•BC3ML-•	725•XX•SC3ML-•
29	29	29
Socket		



Contact terminal arrangements	
Connection	
Accessories	Protection modules
	Timer module
	Maintaining clamps
	Socket identification legend
	Mounting adapters for DIN rail
	Mounting adapters with fixing lugs
Bus jumper	
Conventional thermal current (Ith)	
Type references	
Pages	

Separate	–
Screw connector	–
Yes	–
No	–
Yes	–
–	–
No	–
No	–
No	–
30 A	–
70-725-1	–
29	–

(1) 100,000 for RPM1 and RPM2; 60,000 for RPM3 and RPM4.

(2) 30 A when mounted with 13 mm (0.51 in.) gap between two relays and 25 A when mounted side-by-side without a gap.

Note: The Zelio Relays range name has been changed in 2020 to Harmony Relays. As the timeline for each range is different, during the transition period there will be both Zelio and Harmony ranges shown on different product datasheets and packaging.

Presentation of the range

RSL slim interface relays offer the advantages of compact size and modular design. Their slim width (6 mm/0.236 in.) saves space when mounting on a DIN rail at the back of an enclosure.

RSL relays are available as:

■ **Pre-assembled offer:** a single reference comprising a standard relay mounted on its socket.

- The socket includes a protection circuit (against reverse polarity and surge) and an LED indicator as standard.
- 2 types of connector are available for wire connection: screw connectors or spring terminals.

□ This pre-assembled solution covers a wide range of operating voltages from 12 to 230 V.

■ **Customer assembly offer:**

□ The relay (standard or low level) and the socket are selected, as required, according to the operating voltage of the application.

□ For maintenance, an RSL slim relay can be replaced without disconnecting the socket wiring.

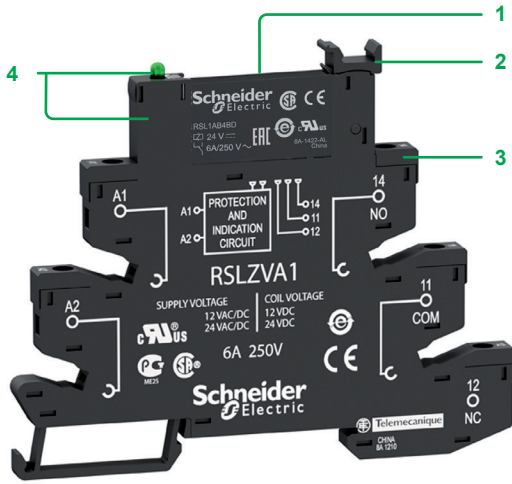

Relay description

RSL slim interface relays, pre-assembled

- 1 6 A standard relay with 1 CO contact
- 2 Lever for retaining or easy withdrawal of the relay from its socket
- 3 Sockets: wire connection by screw connectors or spring terminals
- 4 Built-in protection circuit and LED indicator on all sockets

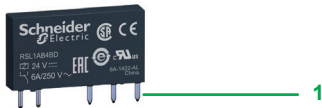

RSL slim interface relay

- 1 5 flat (PCB type) standard pins

Socket description

Sockets for RSL slim interface relays

- 1 5 female contacts for the relay pins
- 2 Retaining lever with marker label
- 3 Wire connection by screw connectors or spring terminals
- 4 Built-in protection circuit and LED indicator
- 5 Locating slot for mounting on DIN rail

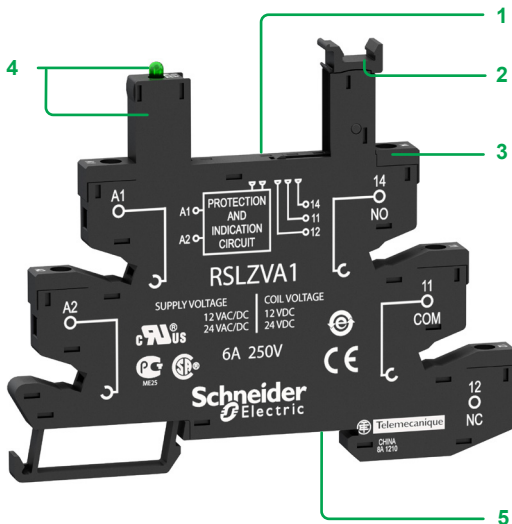



Pre-assembled slim interface relays					
Standard relays mounted on socket equipped with LED and protection circuit					
1 CO contact - 6A thermal current (Ith)					
Operating voltage V	Control circuit voltage V	Socket type		Spring terminal	
		Screw connector Unit reference	Weight kg/lb	Unit reference	Weight kg/lb
~/~ 12	~ 12	RSL1PVJU (RSL1AB4JD + RSLZVA1)	0.031/0.068	RSL1PRJU (RSL1AB4JD + RSLZRA1)	0.029/0.064
~/~ 24	~ 24	RSL1PVBU (RSL1AB4BD + RSLZVA1)	0.031/0.068	RSL1PRBU (RSL1AB4BD + RSLZRA1)	0.029/0.064
~/~ 48	~ 48	RSL1PVEU (RSL1AB4ED + RSLZVA2)	0.031/0.068	RSL1PREU (RSL1AB4ED + RSLZRA2)	0.029/0.064
~/~ 110	~ 60	RSL1PVFU (RSL1AB4ND + RSLZVA3)	0.031/0.068	RSL1PRFU (RSL1AB4ND + RSLZRA3)	0.029/0.064
~/~ 230	~ 60	RSL1PVPU (RSL1AB4ND + RSLZVA4)	0.031/0.068	RSL1PRPU (RSL1AB4ND + RSLZRA4)	0.029/0.064



Slim interface relays for customer assembly				
Relays with flat (PCB type) standard pins				
1 CO contact - 6A Thermal current (Ith)				
Control circuit voltage V	Standard		Low level	
	Unit reference	Weight kg/lb	Unit reference	Weight kg/lb
~ 12	RSL1AB4JD	0.006/0.013	RSL1GB4JD	0.006/0.013
~ 24	RSL1AB4BD	0.006/0.013	RSL1GB4BD	0.006/0.013
~ 48	RSL1AB4ED	0.006/0.013	RSL1GB4ED	0.006/0.013
~ 60	RSL1AB4ND	0.006/0.013	RSL1GB4ND	0.006/0.013



Sockets equipped with LED and protection circuit (Sold in lots of 10)					
Operating voltage V	For use with relays	Socket type		Spring terminal	
		Screw connector Unit reference	Weight kg/lb	Unit reference	Weight kg/lb
~/~ 12 and ~/~ 24	RSL1●B4JD RSL1●B4BD	RSLZVA1	0.025/0.055	RSLZRA1	0.023/0.051
~/~ 48 and ~/~ 60	RSL1●B4ED RSL1●B4ND	RSLZVA2	0.025/0.055	RSLZRA2	0.023/0.051
~/~ 110	RSL1●B4ND	RSLZVA3	0.025/0.055	RSLZRA3	0.023/0.051
~/~ 230	RSL1●B4ND	RSLZVA4	0.025/0.055	RSLZRA4	0.023/0.051



Socket accessories			
Description	For use with	Reference	Weight kg/lb
Clip-in legends (2 sheets of 64 legends)	All sockets	RSLZ5	0.001/0.002
Bus jumper (10 x 20-pole jumper)	All sockets	RSLZ2	0.003/0.007
Partition plate (10 partition plates)	All sockets	RSLZ3	0.001/0.002

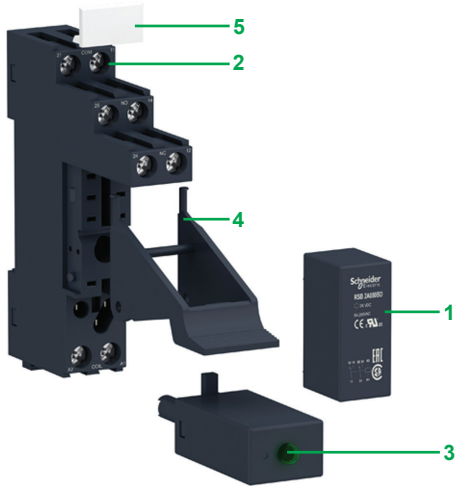

Presentation of the range

The RSB interface relay range comprises:

- 1 12 A relays with 1 CO contact , 16 A relays with 1 CO contact, and 8 A relays with 2 CO contacts
- 2 Sockets with separate contact terminals
- 3 Protection modules (diode, diode + LED, RC circuit, or varistor + LED) common to all sockets
- 4 A plastic maintaining clamp for all sockets
- 5 Clip-in legend for all sockets

These relays are available in both pre-assembled (single reference) and customer assembled offers.

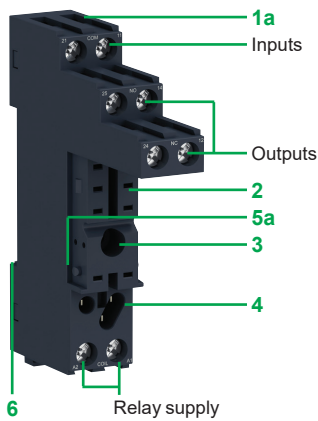

Socket description

Sockets with separate contact terminals (1)

- 1 a Connection by screw connector
b Connection by push-in terminal
- 2 5 or 8 female contacts for the relay pins
- 3 Hole for panel mounting
- 4 Location for protection modules
- 5 a Locking components for plastic maintaining clamp
b Built-in plastic maintaining clamp for locking components
- 6 Locating slot for mounting on DIN rail
- 7 Test point
- 8 Push button to release wire
- 9 Location for bus jumpers

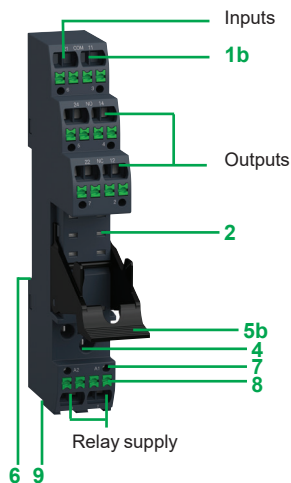

(1) The inputs and outputs are separate from the relay supply.



RSB2A080F7PV

Pre-assembled interface relays						
Relays mounted on sockets with protection module (LED version) and integrated clamp (sold in lots of 30)						
Control circuit voltage V	Number and types of contact - Thermal current (Ith)					
	1 CO - 12 A		1 CO - 16 A		2 CO - 8 A	
	Unit Reference	Weight kg/lb	Unit Reference	Weight kg/lb	Unit Reference	Weight kg/lb
12 \equiv	RSB1A120JDPV (RSB1A120JD + RSZE1S35M + RSZR215 + RZM031RB + RSZL300)	0.050/ 0.110	–	–	RSB2A080JDPV (RSB2A080JD + RSZE1S48M + RSZR215 + RZM031RB + RSZL300)	0.057/ 0.126
24 \equiv	RSB1A120BDPV (RSB1A120BD + RSZE1S35M + RSZR215 + RZM031RB + RSZL300)	0.050/ 0.110	RSB1A160BDPV (RSB1A160BD + RSZE1S48M + RSZR215 + RZM031RB + RSZL300)	0.057/ 0.126	RSB2A080BDPV (RSB2A080BD + RSZE1S48M + RSZR215 + RZM031RB + RSZL300)	0.057/ 0.126
24 \sim	RSB1A120B7PV (RSB1A120B7 + RSZE1S35M + RSZR215 + RZM021RB + RSZL300)	0.050/ 0.110	–	–	RSB2A080B7PV (RSB2A080B7 + RSZE1S48M + RSZR215 + RZM021RB + RSZL300)	0.057/ 0.126
120 \sim	RSB1A120F7PV (RSB1A120F7 + RSZE1S35M + RSZR215 + RZM021FP + RSZL300)	0.050/ 0.110	–	–	RSB2A080F7PV (RSB2A080F7 + RSZE1S48M + RSZR215 + RZM021FP + RSZL300)	0.057/ 0.126
220 \sim	–	–	–	–	RSB2A080M7PV (RSB2A080M7 + RSZE1S48M + RSZR215 + RZM021FP + RSZL300)	0.057/ 0.126
230 \sim	RSB1A120P7PV (RSB1A120P7 + RSZE1S35M + RSZR215 + RZM021FP + RSZL300)	0.050/ 0.110	RSB1A160P7PV (RSB1A160P7 + RSZE1S48M + RSZR215 + RZM021FP + RSZL300)	0.057/ 0.126	RSB2A080P7PV (RSB2A080P7 + RSZE1S48M + RSZR215 + RZM021FP + RSZL300)	0.057/ 0.126



RSB1A120JD + RZM031RB + RSZE1S35M



RSB1A160JD + RSZE1S48M



RSZE05P

Interface relays for customer assembly

RSB interface relays for standard applications (sold in lots of 10)

Control circuit voltage V	Number and type of contacts - Thermal current (Ith)			Unit reference	Weight kg/lb
	1 CO - 12 A	1 CO - 16 A	2 CO - 8 A		
6 ---	RSB1A120RD	RSB1A160RD	RSB2A080RD	0.014/0.031	
12 ---	RSB1A120JD	RSB1A160JD	RSB2A080JD	0.014/0.031	
24 ---	RSB1A120BD	RSB1A160BD	RSB2A080BD	0.014/0.031	
48 ---	RSB1A120ED	RSB1A160ED	RSB2A080ED	0.014/0.031	
60 ---	RSB1A120ND	RSB1A160ND	RSB2A080ND	0.014/0.031	
110 ---	RSB1A120FD	RSB1A160FD	RSB2A080FD	0.014/0.031	
24 ~	RSB1A120B7	RSB1A160B7	RSB2A080B7	0.014/0.031	
48 ~	RSB1A120E7	RSB1A160E7	RSB2A080E7	0.014/0.031	
120 ~	RSB1A120F7	RSB1A160F7	RSB2A080F7	0.014/0.031	
220 ~	RSB1A120M7	RSB1A160M7	RSB2A080M7	0.014/0.031	
230 ~	RSB1A120P7	RSB1A160P7	RSB2A080P7	0.014/0.031	
240 ~	RSB1A120U7	RSB1A160U7	RSB2A080U7	0.014/0.031	

Sockets with separate contact terminal arrangement and screw connector

Rated insulation voltage	Thermal current (Ith)	Relay type	Sold in lots of	Unit reference	Weight kg/lb
250 V ~	12A	RSB1A120●●	10	RSZE1S35M	0.060/0.132
	10A (1)	RSB1A160●● (2) RSB2A080●●	10	RSZE1S48M	0.050/0.110



Sockets with separate contact terminal arrangement, push in terminals, and built-in clamp

Rated insulation voltage	Thermal current (Ith)	Relay type	Sold in lots of	Unit reference	Weight kg/lb
250 V ~	12A	RSB1A●●●●●	10	RSZE05P	0.037/0.082
	10A	RSB2A●●●●●	10	RSZE08P	0.042/0.093

Protection modules

Description	For use with	Voltage V	Sold in lots of	Unit reference	Weight kg/lb
Diode	All sockets	6...230 ---	10	RZM040W	0.003/0.007
		24...60 ~	10	RZM041BN7	0.010/0.022
RC circuit	All sockets	110...240 ~	10	RZM041FU7	0.010/0.022
		6...24 ---	10	RZM031RB	0.004/0.009
Diode + green LED	All sockets	24...60 ---	10	RZM031BN	0.004/0.009
		110...230 ---	10	RZM031FPD	0.004/0.009
		6...24 ---/~	10	RZM021RB	0.005/0.011
Varistor + green LED	All sockets	24...60 ---/~	10	RZM021BN	0.005/0.011
		110...230 ---/~	10	RZM021FP	0.005/0.011

(1) RSZE1S48M is a two terminal socket each carrying 10 A.
 (2) If RSZE1S48M/RSZE08P socket terminals are linked, relay RSB1A160●● can be used up to 16 A. See "Wiring diagrams" on www.se.com/harmonyelectromechanicalrelays

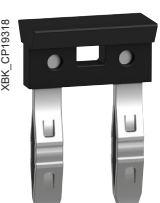
Accessories					
Description	For use with	Sold in lots of	Unit reference	Weight kg/lb	
 <p>XBK_CPI9486</p> <p>RSZR215</p>	Plastic maintaining clamp	All sockets	10	RSZR215	0.002/0.004
	Legend	All sockets	10	RSZL300	0.001/0.002
 <p>RS_SZ2_CPSCT17003+88-Q</p> <p>RGZS08</p>	Bus jumper (10 x 8-pole jumper)	For inputs (A1, A2) of RSZE screw sockets (RSZE1S35M, RSZE1S48M)	10	RGZS08	0.006/0.013
	Bus jumper (10 x 2-pole jumper)	For input (A2) of RSZE push-in sockets (RSZE05P, RSZE08P)	10	RSZS02	0.002/0.004
 <p>XBK_CPI9318</p> <p>RSZS02</p>					

Harmony Electromechanical Relays

Plug-in relays

RXG interface relays

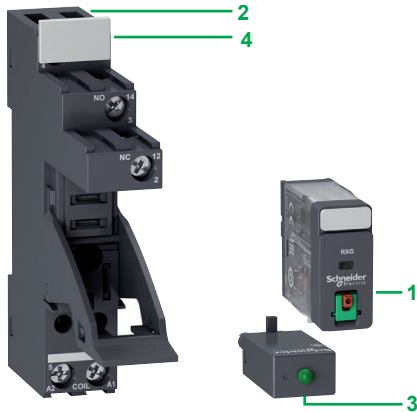

Presentation of the range

RXG relays are interface plug-in relays with Faston pins for better reliability and robust installation. They are used in PLC applications.

The RXG interface relay range comprises:

- 1 10 A relays with 1 CO contact and 5 A relays with 2 CO contacts
- 2 Sockets with separate contact terminals, built-in plastic maintaining clamp
- 3 Protection modules (diode, diode + LED, RC circuit, or varistor + LED) common to all RXG sockets
- 4 Clip-in legends for all RXG sockets

These relays are available in both pre-assembled (single reference) and customer assembled offers.



Relay description

- 1 Spring-return pushbutton for testing the contacts (green: $\overline{\text{---}}$, red: \sim)
- 2 Mechanical "relay status" indicator
- 3 Removable lock-down door enabling forced maintaining of the contacts for test sequences or maintenance purposes
- 4 LED (depending on version) indicating the relay status
- 5 Removable legend for relay identification
- 6 5 or 8 Faston type pins
- 7 Standard cover-type relay with pushbutton, mechanical indicator, and LED options
- 8 Clear cover-type relay

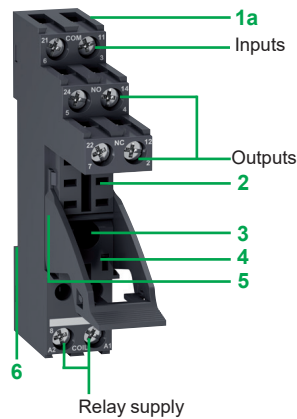

Socket description

Sockets with separate contact terminals (1)

- 1 a Connection by connector
b Connection by push-in terminal
- 2 5 or 8 female contacts for the relay pins
- 3 Hole for panel mounting
- 4 Location for protection modules
- 5 Built-in plastic maintaining clamp for locking components
- 6 Locating slot for mounting on DIN rail
- 7 Test point
- 8 Push button to release wire
- 9 Location for bus jumpers

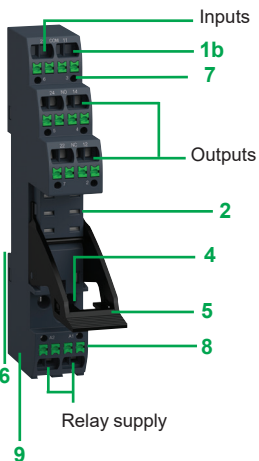

(1) The inputs and outputs are separate from the relay supply.



RXG22BDPV

Pre-assembled interface relays

Relays with lockable test button and LED, mounted on sockets with protection module and integrated clamp

Control circuit voltage V	Sold in lots of	Number and type of contacts - Thermal current (Ith)			
		1 CO - 10 A		2 CO - 5 A	
		Unit reference	Weight kg/lb	Unit reference	Weight kg/lb
24 ---	30	RXG12BDPV (RXG12BD + RGZE1S35M + RZM031RB)	0.059/0.130	RXG22BDPV (RXG22BD + RGZE1S48M + RZM031RB)	0.066/0.145
24 ~	30	RXG12B7PV (RXG12B7 + RGZE1S35M + RZM021RB)	0.059/0.130	RXG22B7PV (RXG22B7 + RGZE1S48M + RZM021RB)	0.067/0.148
230 ~	30	RXG12P7PV (RXG12P7 + RGZE1S35M + RZM021FP)	0.059/0.130	RXG22P7PV (RXG22P7 + RGZE1S48M + RZM021FP)	0.067/0.148

Relays with LED, mounted on sockets with protection module, and integrated clamp

24 ---	30	RXG13BDPV (RXG13BD + RGZE1S35M + RZM031RB)	0.058/0.129	RXG23BDPV (RXG23BD + RGZE1S48M + RZM031RB)	0.066/0.145
230 ~	30	RXG13P7PV (RXG13P7 + RGZE1S35M + RZM021FP)	0.059/0.130	RXG23P7PV (RXG23P7 + RGZE1S48M + RZM021FP)	0.067/0.148

Relays with lockable test button and without LED, mounted on sockets with protection module, and integrated clamp

24 ---	30			RXG21BDPV (RXG21BD + RGZE1S48M + RZM031RB)	0.067/0.148
24 ~	30			RXG21B7PV (RXG21B7 + RGZE1S48M + RZM021RB)	0.067/0.148
230 ~	30			RXG21P7PV (RXG21P7 + RGZE1S48M + RZM021FP)	0.067/0.148



RXG11RD

Interface relays for customer assembly

Standard cover relays with lockable test button

6 ---	10	RXG11RD		RXG21RD	0.020/0.044
12 ---	10	RXG11JD		RXG21JD	0.020/0.044
24 ---	10	RXG11BD		RXG21BD	0.020/0.044
48 ---	10	RXG11ED		RXG21ED	0.020/0.044
60 ---	10	RXG11ND		RXG21ND	0.020/0.044
110 ---	10	RXG11FD		RXG21FD	0.020/0.044
24 ~	10	RXG11B7		RXG21B7	0.020/0.044
48 ~	10	RXG11E7		RXG21E7	0.020/0.044
120 ~	10	RXG11F7		RXG21F7	0.020/0.044
220 ~	10	RXG11M7		RXG21M7	0.020/0.044
230 ~	10	RXG11P7		RXG21P7	0.020/0.044



RXG22B7



RXG13RD

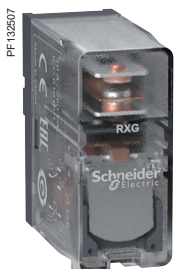

RXG15RD

Interface relays for customer assembly				
Standard cover relays with lockable test button and LED				
Control circuit voltage V	Sold in lots of	Number and type of contacts - Thermal current (Ith)		Weight kg/lb
		1 CO - 10 A Unit reference	2 CO - 5 A Unit reference	
6 ---	10	RXG12RD	RXG22RD	0.020/0.044
12 ---	10	RXG12JD	RXG22JD	0.020/0.044
24 ---	10	RXG12BD	RXG22BD	0.020/0.044
48 ---	10	RXG12ED	RXG22ED	0.020/0.044
60 ---	10	RXG12ND	RXG22ND	0.020/0.044
110 ---	10	RXG12FD	RXG22FD	0.020/0.044
24 ~	10	RXG12B7	RXG22B7	0.020/0.044
48 ~	10	RXG12E7	RXG22E7	0.020/0.044
120 ~	10	RXG12F7	RXG22F7	0.020/0.044
220 ~	10	RXG12M7	RXG22M7	0.020/0.044
230 ~	10	RXG12P7	RXG22P7	0.020/0.044
Standard cover relays with LED				
6 ---	10	RXG13RD	RXG23RD	0.020/0.044
12 ---	10	RXG13JD	RXG23JD	0.020/0.044
24 ---	10	RXG13BD	RXG23BD	0.020/0.044
48 ---	10	RXG13ED	RXG23ED	0.020/0.044
60 ---	10	RXG13ND	RXG23ND	0.020/0.044
110 ---	10	RXG13FD	RXG23FD	0.020/0.044
24 ~	10	RXG13B7	RXG23B7	0.020/0.044
48 ~	10	RXG13E7	RXG23E7	0.020/0.044
120 ~	10	RXG13F7	RXG23F7	0.020/0.044
220 ~	10	RXG13M7	RXG23M7	0.020/0.044
230 ~	10	RXG13P7	RXG23P7	0.020/0.044
Clear cover relays				
6 ---	10	RXG15RD	RXG25RD	0.019/0.042
12 ---	10	RXG15JD	RXG25JD	0.019/0.042
24 ---	10	RXG15BD	RXG25BD	0.019/0.042
48 ---	10	RXG15ED	RXG25ED	0.019/0.042
60 ---	10	RXG15ND	RXG25ND	0.019/0.042
110 ---	10	RXG15FD	RXG25FD	0.019/0.042
24 ~	10	RXG15B7	RXG25B7	0.018/0.040
48 ~	10	RXG15E7	RXG25E7	0.018/0.040
120 ~	10	RXG15F7	RXG25F7	0.018/0.040
220 ~	10	RXG15M7	RXG25M7	0.018/0.040
230 ~	10	RXG15P7	RXG25P7	0.018/0.040

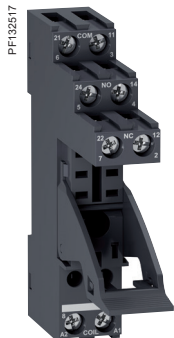

RGZE1S48M



RGZE05P



RZM031RB



RSZL300



RGZS08



RGZR215



RSZS02

Sockets with separate contact terminals arrangement, screw connector connection, and built-in clamp

Description	Thermal current (Ith)	Relay type	Sold in lots of	Unit reference	Weight kg/lb
1 CO socket with 1 pole	10 A	RXG1●●●	10	RGZE1S35M	0.034/0.075
2 CO socket with 2 poles	5 A	RXG2●●●	10	RGZE1S48M	0.042/0.093

Sockets with separate contact terminal arrangement, push-in terminals, and built-in clamp

Description	Thermal current (Ith)	Relay type	Sold in lots of	Unit reference	Weight kg/lb
1 CO socket with 1 pole	10 A	RXG1●●●	10	RGZE05P	0.039/0.086
2 CO socket with 2 poles	5 A	RXG2●●●	10	RGZE08P	0.042/0.093

Protection modules

Description	For use with	Voltage V	Sold in lots of	Unit reference	Weight kg/lb
Diode	All sockets	6...230 ---	10	RZM040W	0.003/0.007
RC circuit	All sockets	24...60 ~	10	RZM041BN7	0.010/0.022
		110...240 ~	10	RZM041FU7	0.010/0.022
Diode + green LED	All sockets	6...24 ---	10	RZM031RB	0.004/0.009
		24...60 ---	10	RZM031BN	0.004/0.009
		110...230 ---	10	RZM031FPD	0.004/0.009
Varistor + green LED	All sockets	6...24 ~/---	10	RZM021RB	0.005/0.011
		24...60 ~/---	10	RZM021BN	0.005/0.011
		110...230 ~/---	10	RZM021FP	0.005/0.011

Accessories

Description	For use with	Sold in lots of	Unit reference	Weight kg/lb
Plastic maintaining clamp	All sockets	10	RGZR215	0.002/0.004
Legend	All sockets	10	RSZL300	0.001/0.002
Legend	All relays	10	RGZL520	0.001/0.002
Bus jumper (10 x 8-pole jumper)	For inputs (A1, A2) of RGZE screw sockets (RGZE1S35M, RGZE1S48M)	10	RGZS08	0.006/0.013
Bus jumper (10 x 2-pole jumper)	For input (A2) of RGZE push-in sockets (RGZE05P, RGZE08P)	10	RSZS02	0.002/0.004

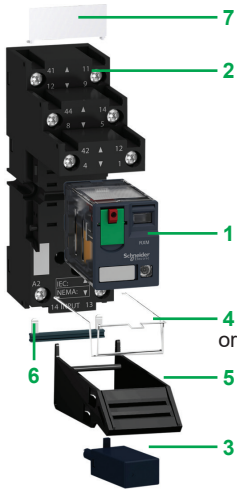

Presentation of the range

The RXM miniature relay range comprises:

- 1 12 A relays with 2 CO contacts, 10 A relays with 3 CO contacts, 6 A relays with 4 CO contacts, and 3 A "low level" relays with 4 CO contacts (all these relays have the same dimensions)
- 2 Sockets with mixed or separate contact terminals
- 3 Protection modules (diode, RC circuit, or varistor) common to all sockets
- 4 Metal maintaining clamp for all sockets
- 5 Plastic maintaining clamp for all sockets
- 6 2-pole bus jumper that can be used on sockets with separate contact terminals in order to simplify cabling when creating an equipotential link between the coil terminals
- 7 Clip-in legends for all sockets except **RXZE2M114** and **RXZE2S114S**

These relays are available in both pre-assembled (single reference) and customer assembled offers.

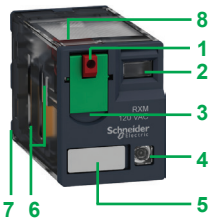

Relay description

- 1 Spring-return pushbutton for testing the contacts (green: $\overline{\text{---}}$, red: \sim)
- 2 Mechanical "relay status" indicator
- 3 Removable lock-down door enabling forced maintaining of the contacts for test sequences or maintenance purposes
- 4 LED (depending on version) indicating the relay status
- 5 Removable legend for relay identification
- 6 4 notches for rail mounting adapter or panel mounting adapter with mounting lugs
- 7 8, 11, or 14 Faston type pins
- 8 Area by which the product can be easily gripped
- 9 Mounting adapter enabling direct mounting of the relay on a panel
- 10 Mounting adapter enabling direct mounting of the relay on a DIN rail



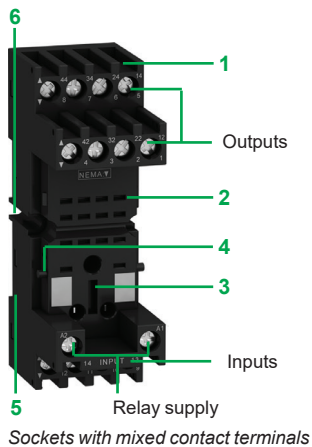

Sockets with mixed contact terminals

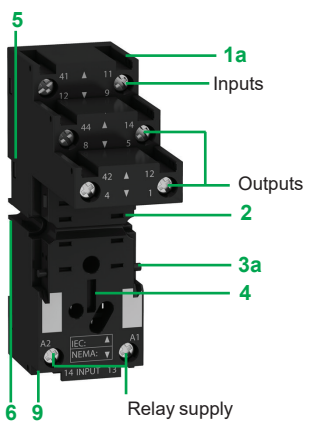

Sockets with separate contact terminals

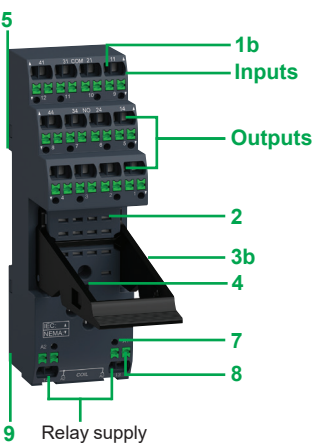

Sockets with separate contact terminals

Socket description

Sockets with mixed contact terminals (1)

- 1 Connection by screw clamp terminals or screw connector
- 2 14 female contacts for the relay pins
- 3 Location for protection modules
- 4 Locking components for plastic and metal maintaining clamps
- 5 Locating slot for mounting on DIN rail with compression spring or mounting clip
- 6 2 or 4 holes for panel mounting

Sockets with separate contact terminals (2)

- 1 a Connection by screw connector
b Connection by push in terminal
- 2 8, 11, or 14 female contacts for the relay pins
- 3 a Locking components for plastic and metal maintaining clamps
b Built-in plastic maintaining clamp for locking components
- 4 Location for protection modules
- 5 Locating slot for mounting on DIN rail with compression spring or mounting clip
- 6 2 holes for panel mounting
- 7 Test point
- 8 Push button to release wire
- 9 Location for bus jumpers

(1) The inputs are mixed with the relay supply, with the outputs being located on the opposite side of the socket.

(2) The inputs and outputs are separate from the relay supply.

Harmony Electromechanical Relays

Plug-in relays

RXM miniature relays

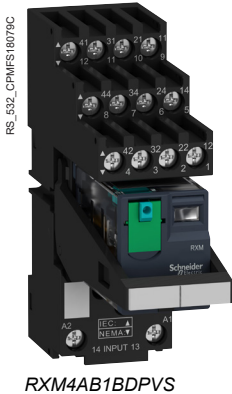

RXM4AB1BDPVS

Pre-assembled interface relays						
Relays without LED, mounted on sockets with clamp and socket legend (sold in lots of 30)						
Control circuit voltage V	Type of socket	Number and type of contacts - Thermal current (Ith)		Weight kg/lb	Unit reference	Weight kg/lb
		2 CO - 12 A	4 CO - 6 A			
24 ~	Mixed terminal socket	-	-	-	RXM4AB1BDPVM (RXM4AB1BD + RXZE2M114M + RXZR335 + RXZL520)	0.099/ 0.218
24 ~		-	-	-	RXM4AB1B7PVM (RXM4AB1B7 + RXZE2M114M + RXZR335 + RXZL520)	0.099/ 0.218
230 ~		-	-	-	RXM4AB1P7PVM (RXM4AB1P7 + RXZE2M114M + RXZR335 + RXZL520)	0.099/ 0.218
24 ~	Separate terminal socket	-	-	-	RXM4AB1BDPVS (RXM4AB1BD + RXZE2S114M + RXZR335 + RXZL520)	0.113/ 0.249
24 ~		-	-	-	RXM4AB1B7PVS (RXM4AB1B7 + RXZE2S114M + RXZR335 + RXZL520)	0.113/ 0.249
230 ~		-	-	-	RXM4AB1P7PVS (RXM4AB1P7 + RXZE2S114M + RXZR335 + RXZL520)	0.113/ 0.249
Relays with LED, mounted on sockets with clamp and socket legend (sold in lots of 30)						
24 ~	Mixed terminal socket	RXM2AB2BDPVM (RXM2AB2BD + RXZE2M114M + RXZR335 + RXZL520)	0.099/ 0.218	RXM4AB2BDPVM (RXM4AB2BD + RXZE2M114M + RXZR335 + RXZL520)	0.099/ 0.218	0.099/ 0.218
24 ~		RXM2AB2B7PVM (RXM2AB2B7 + RXZE2M114M + RXZR335 + RXZL520)	0.099/ 0.218	RXM4AB2B7PVM (RXM4AB2B7 + RXZE2M114M + RXZR335 + RXZL520)	0.099/ 0.218	0.099/ 0.218
230 ~		RXM2AB2P7PVM (RXM2AB2P7 + RXZE2M114M + RXZR335 + RXZL520)	0.099/ 0.218	RXM4AB2P7PVM (RXM4AB2P7 + RXZE2M114M + RXZR335 + RXZL520)	0.099/ 0.218	0.099/ 0.218
24 ~	Separate terminal socket	RXM2AB2BDPVS (RXM2AB2BD + RXZE2S108M + RXZR335 + RXZL520)	0.101/ 0.223	RXM4AB2BDPVS (RXM4AB2BD + RXZE2S114M + RXZR335 + RXZL520)	0.113/ 0.249	0.113/ 0.249
24 ~		RXM2AB2B7PVS (RXM2AB2B7 + RXZE2S108M + RXZR335 + RXZL520)	0.101/ 0.223	RXM4AB2B7PVS (RXM4AB2B7 + RXZE2S114M + RXZR335 + RXZL520)	0.113/ 0.249	0.113/ 0.249
230 ~		RXM2AB2P7PVS (RXM2AB2P7 + RXZE2S108M + RXZR335 + RXZL520)	0.101/ 0.223	RXM4AB2P7PVS (RXM4AB2P7 + RXZE2S114M + RXZR335 + RXZL520)	0.113/ 0.249	0.113/ 0.249



RXM2AB1BD



RXM2AB1F7



RXM2AB2ED



RXM2AB2F7



RXM4GB1BD



RXM4GB1P7



RXM4GB2BD



RXM4GB2F7

Miniature relays for customer assembly

RXM miniature relays without LED (sold in lots of 10)

Control circuit voltage V	Number and type of contacts - Thermal current (Ith)					
	2 CO - 12 A		3 CO - 10 A		4 CO - 6 A	
	Unit reference	Weight kg/lb	Unit reference	Weight kg/lb	Unit reference	Weight kg/lb
12 ---	RXM2AB1JD	0.037/0.082	RXM3AB1JD	0.037/0.082	RXM4AB1JD	0.037/0.082
24 ---	RXM2AB1BD	0.037/0.082	RXM3AB1BD	0.037/0.082	RXM4AB1BD	0.037/0.082
48 ---	RXM2AB1ED	0.037/0.082	RXM3AB1ED	0.037/0.082	RXM4AB1ED	0.037/0.082
110 ---	RXM2AB1FD	0.037/0.082	RXM3AB1FD	0.037/0.082	RXM4AB1FD	0.037/0.082
220 ---	-	-	-	-	RXM4AB1MD	0.037/0.082
24 ~	RXM2AB1B7	0.037/0.082	RXM3AB1B7	0.037/0.082	RXM4AB1B7	0.037/0.082
48 ~	RXM2AB1E7	0.037/0.082	RXM3AB1E7	0.037/0.082	RXM4AB1E7	0.037/0.082
120 ~	RXM2AB1F7	0.037/0.082	RXM3AB1F7	0.037/0.082	RXM4AB1F7	0.037/0.082
230 ~	RXM2AB1P7	0.037/0.082	RXM3AB1P7	0.037/0.082	RXM4AB1P7	0.037/0.082
240 ~	-	-	-	-	RXM4AB1U7	0.037/0.082

RXM miniature relays with LED (sold in lots of 10)

12 ---	RXM2AB2JD	0.037/0.082	RXM3AB2JD	0.037/0.082	RXM4AB2JD	0.037/0.082
24 ---	RXM2AB2BD	0.037/0.082	RXM3AB2BD	0.037/0.082	RXM4AB2BD	0.037/0.082
48 ---	RXM2AB2ED	0.037/0.082	RXM3AB2ED	0.037/0.082	RXM4AB2ED	0.037/0.082
110 ---	RXM2AB2FD	0.037/0.082	RXM3AB2FD	0.037/0.082	RXM4AB2FD	0.037/0.082
125 ---	-	-	-	-	RXM4AB2GD	0.037/0.082
24 ~	RXM2AB2B7	0.037/0.082	RXM3AB2B7	0.037/0.082	RXM4AB2B7	0.037/0.082
48 ~	RXM2AB2E7	0.037/0.082	RXM3AB2E7	0.037/0.082	RXM4AB2E7	0.037/0.082
120 ~	RXM2AB2F7	0.037/0.082	RXM3AB2F7	0.037/0.082	RXM4AB2F7	0.037/0.082
230 ~	RXM2AB2P7	0.037/0.082	RXM3AB2P7	0.037/0.082	RXM4AB2P7	0.037/0.082

RXM miniature relays with low level contacts, without LED (sold in lots of 10)

Control circuit voltage V	Number and type of contacts Thermal current (Ith)	
	Unit reference	Weight kg/lb
12 ---	RXM4GB1JD	0.037/0.082
24 ---	RXM4GB1BD	0.037/0.082
48 ---	RXM4GB1ED	0.037/0.082
110 ---	RXM4GB1FD	0.037/0.082
24 ~	RXM4GB1B7	0.037/0.082
48 ~	RXM4GB1E7	0.037/0.082
120 ~	RXM4GB1F7	0.037/0.082
230 ~	RXM4GB1P7	0.037/0.082

RXM miniature relays with low level contacts, with LED (sold in lots of 10)

12 ---	RXM4GB2JD	0.037/0.082
24 ---	RXM4GB2BD	0.037/0.082
48 ---	RXM4GB2ED	0.037/0.082
60 ---	RXM4GB2ND	0.037/0.082
110 ---	RXM4GB2FD	0.037/0.082
125 ---	RXM4GB2GD	0.037/0.082
220 ---	RXM4GB2MD	0.037/0.082
24 ~	RXM4GB2B7	0.037/0.082
48 ~	RXM4GB2E7	0.037/0.082
120 ~	RXM4GB2F7	0.037/0.082
230 ~	RXM4GB2P7	0.037/0.082
240 ~	RXM4GB2U7	0.037/0.082



RXZE2M114M



RXZE14P

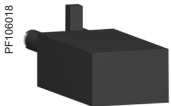

RXM04177

Sockets					
Contact terminal arrangement	Connection	Relay type	Sold in lots of	Unit reference	Weight kg/lb
Mixed	Screw clamp terminals	RXM2●●●●● (3) RXM4●●●●●	10	RXZE2M114 (1)	0.048/0.106
	Screw connector	RXM2●●●●● (3) RXM4●●●●●	10	RXZE2M114M (1)	0.056/0.124
Separate	Spring clamp terminals	RXM2●●●●● (3) RXM4●●●●●	10	RXZE2S114S (2)	0.070/0.154
		RXM2●●●●● RXM4●●●●●	10	RXZE14P	0.080/0.176
	Screw connector	RXM2●●●●●	10	RXZE2S108M (2)	0.058/0.128
		RXM3●●●●●	10	RXZE2S111M (1)	0.066/0.146
		RXM4●●●●●	10	RXZE2S114M (1)	0.070/0.154

Protection modules					
Description	Voltage V	For use with	Sold in lots of	Unit reference	Weight kg/lb
Diode	6...250 ---	All sockets	10	RXM040W	0.003/0.007
RC circuit	24...60 ~	All sockets	10	RXM041BN7	0.010/0.022
	110...240 ~	All sockets	10	RXM041FU7	0.010/0.022
Varistor	6...24 ~/---	All sockets	10	RXM021RB	0.030/0.066
	24...60 ~/---	All sockets	10	RXM021BN	0.030/0.066
	110...240 ~/---	All sockets	10	RXM021FP	0.030/0.066

Timing relays			
Description	For use with	Unit reference	Weight kg/lb
2 or 4 timed CO contacts (function A)	RXZE●●●●● sockets	REXL2●● (4)	—
		REXL4●● (4)	—

(1) Thermal current (Ith): 10 A.
 (2) Thermal current (Ith): 12 A.
 (3) When mounting relay RXM2●●●●● on socket RXZE2M●●●●●, the thermal current should not exceed 10 A.
 (4) Please refer to "Zelio Time timing relays" catalog.
 (5) Test button becomes inaccessible.



REXL4●●



RXZR315

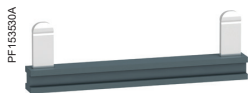

RXZS2



RSZS02

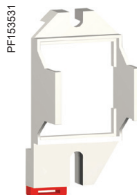

RXZE2DA



RXZ400



RXZL520



RXZL300

Accessories

Description	For use with	Sold in lots of	Unit reference	Weight kg/lb
Metal maintaining clamp	All sockets	10	RXZ400	0.001/0.002
Plastic maintaining clamp	All sockets except push-in socket RXZE14P	10	RXZR335	0.005/0.011
	RXZE14P	10	RXZR315	0.004/0.009
2-pole bus jumper (lth: 5 A)	All screw sockets with separate contacts (RXZE2S●●●●)	10	RXZS2	0.005/0.011
Bus jumper (10 x 2-pole jumper)	For input (A2) of RXZE push in sockets (RXZE14P)	10	RSZS02	0.002/0.004
Mounting adapter for \perp rails (5)	RXM2●●●●● RXM3●●●●●	10	RXZE2DA	0.004/0.009
Mounting adapter with panel mounting lugs	RXM2●●●●● RXM3●●●●●	10	RXZE2FA	0.002/0.004
Clip-in legends	All relays (sheet of 108 legends)	10	RXZL520	0.080/0.176
	RXZE14P	10	RXZL300	0.004/0.009
	All sockets except RXZE2M114 and RXZE2S114S	10	RXZL420	0.001/0.002
	RXZE2S114S socket	10	RSZL300	0.001/0.002

(1) Thermal current (lth): 10 A.

(2) Thermal current (lth): 12 A.

(3) When mounting relay RXM2●●●●● on socket RXZE2M●●●●●, the thermal current should not exceed 10 A.

(4) Please refer to "Zelio Time timing relays" catalog.

(5) Test button becomes inaccessible.

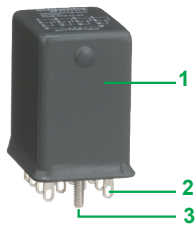

Presentation of the range

The hermetically sealed 782H series relays comply with UL Class I Division 2 requirements for use in hazardous locations. They are suitable for installation in harsh, hazardous, and corrosive environments like offshore mining and refineries in the oil and gas, petrochemical, chemical, and mines and minerals sectors.

782H hermetically sealed relays comprise:

- Relays with 3 A/5 A, 2 CO/4 CO contacts
- Sockets with multiple configuration, finger-safe according to IP20, and compatible with DIN rail or panel mounting
- Accessories (protection modules and/or LED indicator)

These relays are available in panel, DIN rail, PCB, and chassis mount versions.

Description

Relay

- 1 Hermetically sealed enclosure
- 2 Flat (Plug-in type) terminal
- 3 Stub to mount in panel

Socket

- 4 There are different types of sockets:
 - DIN rail or panel mount sockets
 - a with screw clamp terminals
 - b with screw connector
 - c with screw connector
 - d with screw clamp terminals
 - Other types of terminals
 - e Solder terminals for chassis mount
 - f Printed circuit terminals for PCB mount
- 5 Connection by screw connector
- 6 Location for protection modules
- 7 Solder lug
- 8 PCB pins

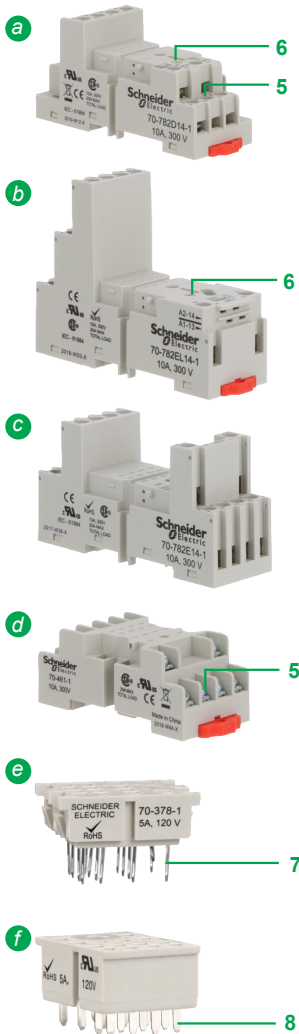



782DXH21-12D

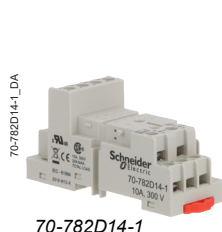

70-782D14-1

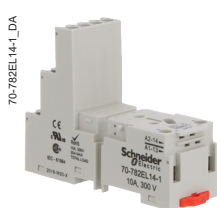

70-782EL14-1



70-782E14-1



70-461-1



70-379-1



70-378-1

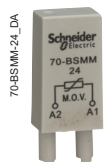

70-BSMM-24

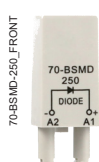

70-BSMD-250

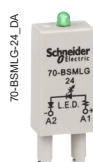

70-BSMLG-24



16-1342



RXZS2

References

782H hermetically sealed relays (sold in lots of 10)

Coil voltage	Contact type - Thermal current (Ith)			
	4 CO - 3 A		4 CO - 5 A	
V	Unit reference	Weight kg/lb	Unit reference	Weight kg/lb
6 ~	782DXH10-6A	0.045/0.099	–	–
24 ~	782DXH10-24A	0.045/0.099	–	–
120 ~	782DXH10-120A	0.045/0.099	782DXH21-120A	0.045/0.099
240 ~	782DXH10-240A	0.045/0.099	782DXH21-240A	0.045/0.099
6 ---	782DXH10-6D	0.045/0.099	–	–
12 ---	782DXH10-12D	0.045/0.099	782DXH21-12D	0.045/0.099
24 ---	782DXH10-24D	0.045/0.099	782DXH21-24D	0.045/0.099
48 ---	–	–	782DXH21-48D	0.045/0.099
110 ---	782DXH10-110D	0.045/0.099	–	–

Coil voltage	Contact type - Thermal current (Ith)	
	2 CO - 5 A	
V	Unit reference	Weight kg/lb
24 ---	782BXH21-24D	0.045/0.099

Sockets for all 782H relays (sold in lots of 10)

Contact terminal arrangement	Connection	Mounting	Unit reference	Weight Kg/lb
Mixed	Screw clamp terminals	DIN rail/ Panel	RXZE2M114 (1) 70-782D14-1	0.07/0.154
	Screw connector		RXZE2M114M (1) 70-782E14-1	0.06/0.132
	Screw clamp terminals		70-461-1	0.044/0.097
Separate	Screw connector		RXZE2S114M (1) 70-782EL14-1	0.06/0.132
	Solder terminals	Chassis	70-378-1	0.007/0.015
	Printed circuit terminals	PCB	70-379-1	0.007/0.015

Protection modules (sold in lots of 10)

Description	For use with sockets	Coil voltage	Unit reference	Weight Kg/lb
Diode	70-782D14-1, 70-782EL14-1,	6 to 250 ---	70-BSMD-250	–
MOV suppressor	70-782E14-1	24 ~	70-BSMM-24	–
		120 ~	70-BSMM-120	–
		240 ~	70-BSMM-240	–
LED indicator		24 ~	70-BSMLG-24	–

Accessories (sold in lots of 10)

Description	For use with sockets	Unit reference	Weight Kg/lb
Metal spring clip	All sockets	16-1342	–
Plastic ID tag	70-782E14-1, 70-782EL14-1	RXZL420	–
Insulated coil bus jumper system	70-782EL14-1	RXZS2	–

(1) 782H relays are:

- UL Recognized when used with **RXZE** sockets
- UL Listed when used with **70-782** sockets

Harmony Electromechanical Relays

Plug-in and DIN rail/Panel mount relays

725 power relays

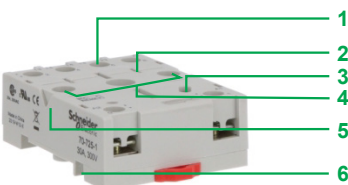
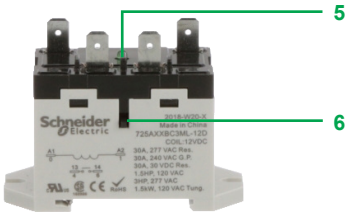
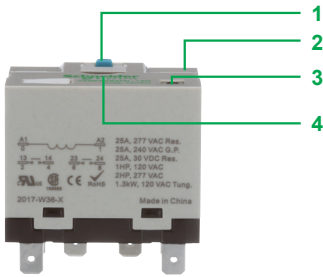
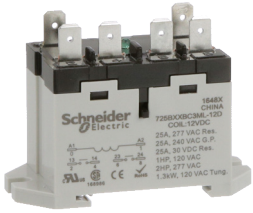

Presentation of the range

The 725 series are power relays offering multiple mounting options for ease of use, enhanced reliability, and robust installation. They are used in high-capacity switching applications such as EV charging, CNC machines, and HVAC compressors.

725 power relays comprise:

- 30 A relays with 1 NO contact and 25 A relays with 2 NO contacts
- Socket for plug-in type version with flat (Faston type) terminals
- Protection modules as accessories (diode, separate LED indicator, RC circuit)

Apart from Plug-in relays with flat (Faston type) terminals, these relays are also available in Panel/DIN rail mount versions with screw type and flat (Faston type) terminals.

Description

Plug-in socket mount power relay

- 1 Spring-return pushbutton for testing the contacts (blue: $\overline{}$; red: \sim)
- 2 Mechanical "relay status" indicator
- 3 LED indicating the relay status
- 4 Lock-down door enabling forced maintaining of the contacts for testing purposes

DIN rail/Panel mount power relay

- 5 LED indicating the relay status
- 6 Side-mounted spring-return pushbutton for testing the contacts
- 7 Touch-proof cover (for screw type terminal)

Socket

- 1 Connection by screw connector
- 2 6 female contacts for the relay pins
- 3 Location for protection modules
- 4 Holes for panel mounting
- 5 Spring clip location
- 6 Locating slot for mounting on DIN rail

725AXXBC3ML-12D_DA



725AXXBC3ML-12D

725AXXSC3ML-12D_FRONT



725AXXSC3ML-12D

725BXXBM4L-12D_FRONT



725BXXBM4L-12D

70-725-1_DA



70-725-1

70-ASMD-250_FRONT

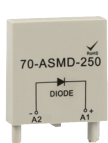

70-ASMD-250

70-ASMM-120_DA



70-ASMM-120

16-725SC-1_DA



16-725SC-1

References

725 power relays with DIN rail/Panel mounting (sold in lots of 10)

Coil voltage V	Terminal style	Contact type - (Thermal current (Ith))			
		2 NO - 25 A		1 NO - 30 A	
		Unit reference	Weight kg/lb	Unit reference	Weight kg/lb
24 ~	Flat (Faston type)	725BXXBC3ML-24A	0.120/0.265	725AXXBC3ML-24A	0.120/0.265
	Screw terminals	725BXXSC3ML-24A	0.120/0.265	725AXXSC3ML-24A	0.120/0.265
120 ~	Flat (Faston type)	725BXXBC3ML-120A	0.120/0.265	725AXXBC3ML-120A	0.120/0.265
	Screw terminals	725BXXSC3ML-120A	0.120/0.265	725AXXSC3ML-120A	0.120/0.265
240 ~	Flat (Faston type)	725BXXBC3ML-240A	0.120/0.265	725AXXBC3ML-240A	0.120/0.265
	Screw terminals	725BXXSC3ML-240A	0.120/0.265	725AXXSC3ML-240A	0.120/0.265
12 ∴	Flat (Faston type)	725BXXBC3ML-12D	0.120/0.265	725AXXBC3ML-12D	0.120/0.265
	Screw terminals	725BXXSC3ML-12D	0.120/0.265	725AXXSC3ML-12D	0.120/0.265
24 ∴	Flat (Faston type)	725BXXBC3ML-24D	0.120/0.265	725AXXBC3ML-24D	0.120/0.265
	Screw terminals	725BXXSC3ML-24D	0.120/0.265	725AXXSC3ML-24D	0.120/0.265

725 power relays with Plug-in socket mounting (sold in lots of 10)

24 ~	Flat (Faston type)	725BXXBM4L-24A	0.120/0.265	725AXXBM4L-24A	0.120/0.265
120 ~	Flat (Faston type)	725BXXBM4L-120A	0.120/0.265	725AXXBM4L-120A	0.120/0.265
240 ~	Flat (Faston type)	725BXXBM4L-240A	0.120/0.265	725AXXBM4L-240A	0.120/0.265
12 ∴	Flat (Faston type)	725BXXBM4L-12D	0.120/0.265	725AXXBM4L-12D	0.120/0.265
24 ∴	Flat (Faston type)	725BXXBM4L-24D	0.120/0.265	725AXXBM4L-24D	0.120/0.265

Socket (sold in lots of 10)

Contact terminal arrangement	Connection	Relay type	Unit reference	Weight Kg/lb
Separate	Screw connector	725 relays with Plug-in socket mount cover	70-725-1	0.055/0.121

Socket modules (sold in lots of 10)

Description	For use with sockets	Coil voltage V	Unit reference	Weight Kg/lb
Diode	70-725-1	6 to 250 ∴	70-ASMD-250	–

MOV suppressor

24 ~	70-ASMM-24	–
120 ~	70-ASMM-120	–
240 ~	70-ASMM-240	–

Socket accessories (sold in lots of 10)

Description	For use with sockets	Unit reference	Weight Kg/lb
Spring clip	70-725-1	16-725SC-1	–

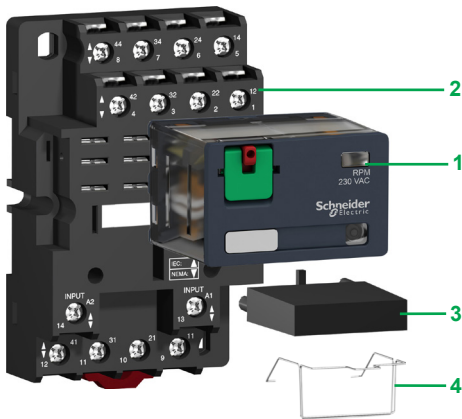

Presentation of the range

The RPM power relay range comprises:

- 1 15 A relay with 1, 2, 3, and 4 CO contacts
- 2 Sockets with mixed contact terminals
- 3 Protection modules (diode, RC circuit, or varistor) or 1 timer module (these protection modules are common to all sockets except for the timer module, which can be used on 3-pole or 4-pole sockets only)
- 4 Metal maintaining clamp for single-contact relays

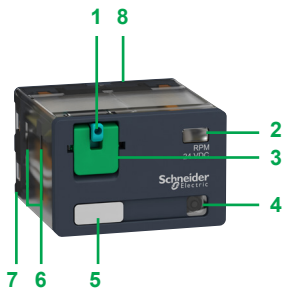

Relay description

- 1 Spring-return pushbutton for testing the contacts (green: $\overline{\text{---}}$, red: \sim)
- 2 Mechanical "relay status" indicator
- 3 Removable lock-down door enabling forced maintaining of the contacts for test sequences or maintenance purposes
- 4 LED (depending on version) indicating the relay status
- 5 Removable legend for relay identification
- 6 4 notches for rail mounting adapter or panel mounting adapter with mounting lugs
- 7 5, 8, 11, or 14 Faston type pins
- 8 Area by which the product can be easily gripped
- 9 Mounting adapter enabling direct mounting of the relay on a panel
- 10 Mounting adapter enabling direct mounting of the relay on a \perp rail

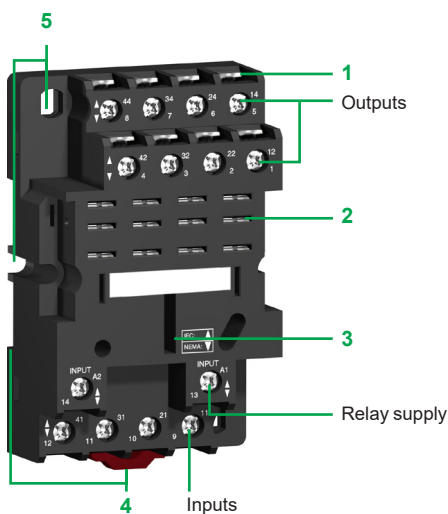
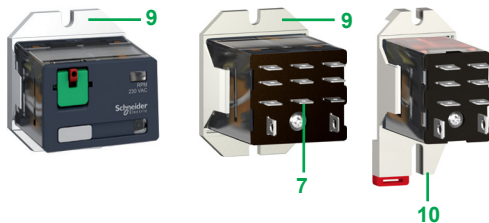

Socket description

Sockets with mixed contact terminals (1)

- 1 Connection by screw clamp terminals
- 2 5, 8, 11, or 14 female contacts for the relay pins
- 3 Location for protection modules or the timer module
- 4 Locating slot for mounting on rail with mounting clip
- 5 2 or 4 holes for panel mounting

(1) The inputs are mixed with the relay supply, with the outputs being located on the opposite side of the socket.



RPM41BD



RPM41P7

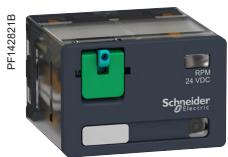

RPM42BD



RPM42P7

Power relays for customer assembly

Power relays without LED (sold in lots of 10)

Control circuit voltage V	Number and type of contacts - Thermal current (Ith)							
	1 CO - 15 A		2 CO - 15 A		3 CO - 15 A		4 CO - 15 A	
	Unit reference	Weight kg/lb	Unit reference	Weight kg/lb	Unit reference	Weight kg/lb	Unit reference	Weight kg/lb
12 ---	RPM11JD	0.026/0.057	RPM21JD	0.036/0.079	RPM31JD	0.054/0.119	RPM41JD	0.071/0.157
24 ---	RPM11BD	0.026/0.057	RPM21BD	0.036/0.079	RPM31BD	0.054/0.119	RPM41BD	0.071/0.157
48 ---	RPM11ED	0.026/0.057	RPM21ED	0.036/0.079	RPM31ED	0.054/0.119	RPM41ED	0.071/0.157
110 ---	RPM11FD	0.026/0.057	RPM21FD	0.036/0.079	RPM31FD	0.054/0.119	RPM41FD	0.071/0.157
24 ~	RPM11B7	0.026/0.057	RPM21B7	0.036/0.079	RPM31B7	0.054/0.119	RPM41B7	0.071/0.157
48 ~	RPM11E7	0.026/0.057	RPM21E7	0.036/0.079	RPM31E7	0.054/0.119	RPM41E7	0.071/0.157
120 ~	RPM11F7	0.026/0.057	RPM21F7	0.036/0.079	RPM31F7	0.054/0.119	RPM41F7	0.071/0.157
230 ~	RPM11P7	0.026/0.057	RPM21P7	0.036/0.079	RPM31P7	0.054/0.119	RPM41P7	0.071/0.157

Power relays with LED (sold in lots of 10)

12 ---	RPM12JD	0.026/0.057	RPM22JD	0.036/0.079	RPM32JD	0.054/0.119	RPM42JD	0.071/0.157
24 ---	RPM12BD	0.026/0.057	RPM22BD	0.036/0.079	RPM32BD	0.054/0.119	RPM42BD	0.071/0.157
48 ---	RPM12ED	0.026/0.057	RPM22ED	0.036/0.079	RPM32ED	0.054/0.119	RPM42ED	0.071/0.157
110 ---	RPM12FD	0.026/0.057	RPM22FD	0.036/0.079	RPM32FD	0.054/0.119	RPM42FD	0.071/0.157
24 ~	RPM12B7	0.026/0.057	RPM22B7	0.036/0.079	RPM32B7	0.054/0.119	RPM42B7	0.071/0.157
48 ~	RPM12E7	0.026/0.057	RPM22E7	0.036/0.079	RPM32E7	0.054/0.119	RPM42E7	0.071/0.157
120 ~	RPM12F7	0.026/0.057	RPM22F7	0.036/0.079	RPM32F7	0.054/0.119	RPM42F7	0.071/0.157
230 ~	RPM12P7	0.026/0.057	RPM22P7	0.036/0.079	RPM32P7	0.054/0.119	RPM42P7	0.071/0.157

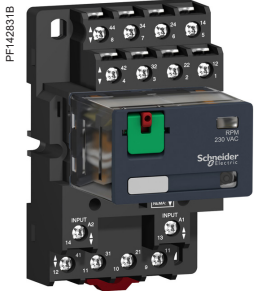

RPZF4 + Relay RPM42P7

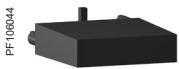

RUW24

Sockets					
Contact terminal arrangement	Connection	Relay type	Sold in lots of	Unit reference	Weight kg/lb
Mixed	Screw clamp terminals	RPM1●●●	10	RPZF1	0.042/0.093
		RPM2●●●	10	RPZF2	0.054/0.119
		RPM3●●●	10	RPZF3	0.072/0.159
		RPM4●●●	10	RPZF4	0.094/0.207

Protection modules					
Description	Voltage V	Socket type	Sold in lots of	Unit reference	Weight kg/lb
Diode	6...250 ---	RPZF1	10	RXM040W	0.003/0.007
		RPZF2	10	RUW240BD	0.004/0.009
RC circuit	24...60 ~	RPZF1	10	RXM041BN7	0.010/0.022
		RPZF2	10	RXM041FU7	0.010/0.022
	110...240 ~	RPZF1	10	RXM041FU7	0.010/0.022
		RPZF2	10	RUW241P7	0.004/0.009
Varistor	6...24 ~/---	RPZF1	10	RXM021RB	0.030/0.066
		RPZF2	10	RXM021BN	0.030/0.066
	24...60 ~/---	RPZF1	10	RXM021FP	0.030/0.066
		RPZF2	10	RUW242B7	0.004/0.009
	110...240 ~/---	RPZF1	10	RXM021FP	0.030/0.066
		RPZF2	10	RUW242P7	0.004/0.009
24 ~/---	RPZF3	10	RUW242B7	0.004/0.009	
	RPZF4	10	RUW242P7	0.004/0.009	

Timer module (1)					
Description	Voltage V	Socket type	Reference	Weight kg/lb	
Multifunction	24... 240 ~/---	RPZF3 RPZF4	RUW101MW	0.020/0.044	

(1) See timer module description (selection of functions and time delays) on www.se.com/harmonyelectromechanicalrelays.

PF108045



RPZ1DA

PF108046



RPZ4FA

Accessories

Description	For use with	Sold in lots of	Unit reference	Weight kg/lb
Metal maintaining clamp (for single-pole relays)	RPZF1	10	RPZR235	0.001/0.002
Mounting adapters for \perp rail (1)	RPM1●●●	10	RPZ1DA	0.004/0.009
	RPM2●●●	10	RXZE2DA	0.004/0.009
	RPM3●●●	10	RPZ3DA	0.004/0.009
	RPM4●●●	10	RPZ4DA	0.006/0.013
Mounting adapters with panel mounting lugs	RPM1●●●	10	RPZ1FA	0.002/0.004
	RPM2●●●	10	RXZE2FA	0.002/0.004
	RPM3●●●	10	RPZ3FA	0.003/0.007
	RPM4●●●	10	RPZ4FA	0.004/0.009
Clip-in legends (sheet of 108 legends)	All relays	10	RXZL520	0.080/0.176
Clip-in legends (sheet of 16 legends)	All relays	10	RGZL520	0.080/0.176

(1) Test button becomes inaccessible.



Presentation of the range

The RUM universal relay range comprises:

- 1 10 A relays with 2 and 3 CO contacts, and cylindrical or flat (Faston type) pins (all these relays have the same dimensions)
- 2 Sockets with mixed or separate contact terminals
- 3 Protection modules (diode, RC circuit, or varistor) or 1 timer module, common to all RUM sockets
- 4 Metal maintaining clamp for all RUM sockets
- 5 2-pole bus jumper that can be used on sockets with separate contact terminals in order to simplify cabling when creating an equipotential link between the coil terminals
- 6 Clip-in legends for the sockets

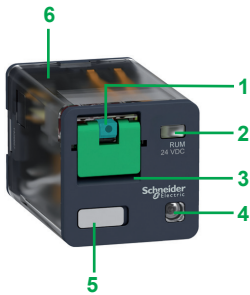

Relay description

- 1 Spring-return pushbutton for testing the contacts (green: $\overline{\text{---}}$, red: \sim)
- 2 Mechanical "relay status" indicator
- 3 Removable lock-down door enabling forced maintaining of the contacts for test sequences or maintenance purposes (1)
- 4 LED (depending on version) indicating the relay status
- 5 Removable legend for relay identification
- 6 Area by which the product can be easily gripped
- 7 8 or 11 cylindrical pins
- 8 8 or 11 flat (Faston type) pins

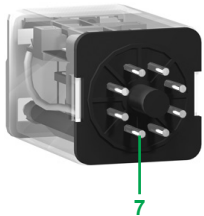

(1) During operation, this lock-down door must always be in the closed position.

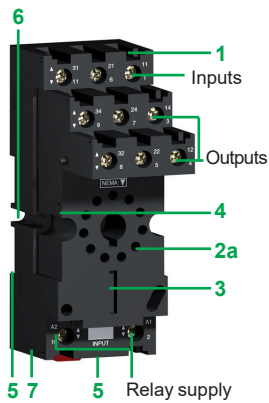

Socket description

Sockets with separate contact terminals (1)

- 1 Connection by screw connector
- 2 a 8 or 11 female contacts for the relay cylindrical pins
b 11 female contacts for the relay flat pins
- 3 Location for protection modules or the timer module
- 4 Locking component for metal maintaining clamp
- 5 Locating slot for mounting on DIN rail with mounting clip
- 6 2 holes for panel mounting
- 7 Location for bus jumpers (see dimensions for mounting on sockets on www.se.com/harmonyelectromechanicalrelays)

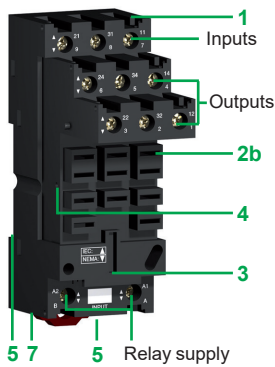

Sockets with mixed contact terminals

- 1 Connection by screw connector
- 2 8 or 11 female contacts for the relay cylindrical pins
- 3 Location for protection modules or the timer module
- 4 Locking component for metal maintaining clamp
- 5 A locating slot for mounting on DIN rail
- 6 2 holes for panel mounting

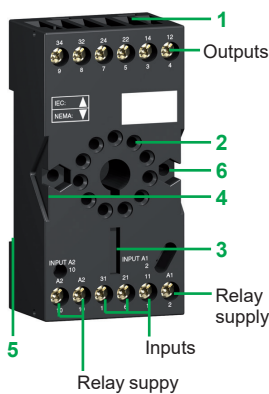

(1) The inputs and outputs are separate from the relay supply.

Harmony Electromechanical Relays

Plug-in relays

RUM universal relays



RUMC21BD



RUMC21F7



RUMC32BD



RUMF32F7

Universal relays for customer assembly

Relays for standard applications, with lockable test button and without LED (sold in lots of 10)

Pins	Control circuit voltage V	Number and type of contacts - Thermal current (Ith)		3 CO - 10 A	
		2 CO - 10 A Unit reference	Weight kg/lb	Unit reference	Weight kg/lb
Cylindrical	≡ 12	RUMC21JD	0.086/0.190	RUMC31JD	0.086/0.190
	≡ 24	RUMC21BD	0.086/0.190	RUMC31BD	0.086/0.190
	≡ 48	RUMC21ED	0.086/0.190	RUMC31ED	0.086/0.190
	≡ 60	–	–	RUMC31ND	0.086/0.190
	≡ 110	RUMC21FD	0.086/0.190	RUMC31FD	0.086/0.190
	≡ 125	–	–	RUMC31GD	0.086/0.190
	≡ 220	–	–	RUMC31MD	0.086/0.190
	~ 24	RUMC21B7	0.086/0.190	RUMC31B7	0.086/0.190
	~ 48	RUMC21E7	0.086/0.190	RUMC31E7	0.086/0.190
	~ 120	RUMC21F7	0.086/0.190	RUMC31F7	0.086/0.190
~ 230	RUMC21P7	0.086/0.190	RUMC31P7	0.086/0.190	
Flat (Faston type)	≡ 12	RUMF21JD	0.086/0.190	RUMF31JD	0.086/0.190
	≡ 24	RUMF21BD	0.086/0.190	RUMF31BD	0.086/0.190
	≡ 48	RUMF21ED	0.086/0.190	RUMF31ED	0.086/0.190
	≡ 110	RUMF21FD	0.086/0.190	RUMF31FD	0.086/0.190
	~ 24	RUMF21B7	0.086/0.190	RUMF31B7	0.086/0.190
	~ 48	RUMF21E7	0.086/0.190	RUMF31E7	0.086/0.190
	~ 120	RUMF21F7	0.086/0.190	RUMF31F7	0.086/0.190
	~ 230	RUMF21P7	0.086/0.190	RUMF31P7	0.086/0.190

Relays for standard applications, with lockable test button and LED (sold in lots of 10)

Cylindrical	≡ 12	RUMC22JD	0.086/0.190	RUMC32JD	0.086/0.190
	≡ 24	RUMC22BD	0.086/0.190	RUMC32BD	0.086/0.190
	≡ 48	RUMC22ED	0.086/0.190	RUMC32ED	0.086/0.190
	≡ 60	–	–	RUMC32ND	0.086/0.190
	≡ 110	RUMC22FD	0.086/0.190	RUMC32FD	0.086/0.190
	≡ 125	–	–	RUMC32GD	0.086/0.190
	~ 24	RUMC22B7	0.086/0.190	RUMC32B7	0.086/0.190
	~ 48	RUMC22E7	0.086/0.190	RUMC32E7	0.086/0.190
	~ 120	RUMC22F7	0.086/0.190	RUMC32F7	0.086/0.190
	~ 230	RUMC22P7	0.086/0.190	RUMC32P7	0.086/0.190
Flat (Faston type)	≡ 12	RUMF22JD	0.086/0.190	RUMF32JD	0.086/0.190
	≡ 24	RUMF22BD	0.086/0.190	RUMF32BD	0.086/0.190
	≡ 48	RUMF22ED	0.086/0.190	RUMF32ED	0.086/0.190
	≡ 110	RUMF22FD	0.086/0.190	RUMF32FD	0.086/0.190
	~ 24	RUMF22B7	0.086/0.190	RUMF32B7	0.086/0.190
	~ 48	RUMF22E7	0.086/0.190	RUMF32E7	0.086/0.190
	~ 120	RUMF22F7	0.086/0.190	RUMF32F7	0.086/0.190
	~ 230	RUMF22P7	0.086/0.190	RUMF32P7	0.086/0.190

(1) The inputs are mixed with the relay supply, with the outputs being located on the opposite side of the socket.

PF140733B



RUZSC3M +
Relay RUMC3●●●

PF108027



RUW241P7

PF516229



RUW101MW

DF538485



RUZC200

DF535203



RUZS2

Sockets					
Contact terminal arrangement	Connection	Relay type	Sold in lots of	Unit reference	Weight kg/lb
Mixed	Screw connector	RUMC2●●●	10	RUZC2M	0.054/0.119
		RUMC3●●●	10	RUZC3M	0.054/0.119
Separate	Screw connector	RUMC2●●●	10	RUZSC2M	0.095/0.209
		RUMC3●●●	10	RUZSC3M	0.100/0.220
		RUMF2●●●	10	RUZSF3M	0.095/0.209
		RUMF3●●●			
Protection modules					
Description	For use with	Voltage V	Sold in lots of	Unit reference	Weight kg/lb
Diode	All RUM sockets	— 6...250	10	RUW240BD	0.004/0.009
RC circuit	All RUM sockets	~ 110...240	10	RUW241P7	0.004/0.009
Varistor	All RUM sockets	~ / — 24	10	RUW242B7	0.004/0.009
		~ / — 240	10	RUW242P7	0.004/0.009
Timer module					
Description	For use with	Voltage V		Reference	Weight kg/lb
Multifunction	All RUM sockets	~ / — 24... 240		RUW101MW	0.020/0.044
Timing relays					
Description	For use with			Reference	Weight kg/lb
2 timed CO contacts (single-function or multifunction)	RUZC●M sockets			RE48A●● (1)	—
Accessories					
Description	For use with		Sold in lots of	Unit reference	Weight kg/lb
Metal maintaining clamp	All RUM sockets		10	RUZC200	0.001/0.002
2-pole bus jumper (Ith: 5 A)	All RUM sockets with separate contacts		10	RUZS2	0.005/0.011
Clip-in legends	All relays (sheet of 108 legends)		10	RXZL520	0.086/0.190
	All RUM sockets with separate contacts		10	RUZL420	0.001/0.002

(1) Please refer to "Zelio Time timing relays" catalog.

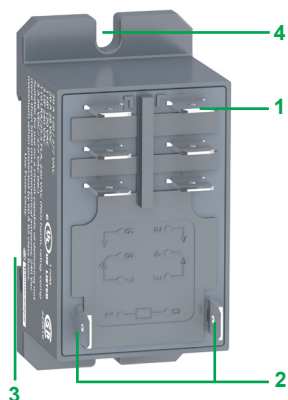

Presentation of the range

RPF power relays with 2 CO or 2 NO contacts comprise:

- 1 4 or 6 Faston type pins
- 2 2 relay supply pins
- 3 Locating slot for mounting on DIN rail
- 4 2 holes for panel mounting

Harmony Electromechanical Relays

Relays with clamp mounting

RPF power relays

RPF20361C



RPF2A●●

Power relays

Control circuit voltage V	Sold in lots	Number and type of contacts - Thermal current (Ith)		Weight kg/lb
		2 NO - 30 A (1) Unit reference	2 CO - 30 A (1) Unit reference	
12 $\overline{\text{---}}$	10	RPF2AJD	RPF2BJD	0.082/ 0.181
24 $\overline{\text{---}}$	10	RPF2ABD	RPF2BBD	0.082/ 0.181
24 \sim	10	RPF2AB7	RPF2BB7	0.082/ 0.181
120 \sim	10	RPF2AF7	RPF2BF7	0.082/ 0.181
230 \sim	10	RPF2AP7	RPF2BP7	0.082/ 0.181

(1) 30 A when mounted with 13 mm (0.51 in.) gap between two relays and 25 A when mounted side by side without a gap.

Harmony Electromechanical Relays

Interface, miniature, and power electromechanical relays

Relays			
Contact types			
Symbol	Configuration	EU	USA
	Make contact (Normally Open)	NO	SPST-NO DPST-NO nPST-NO (1)
	Break contact (Normally Closed)	NC	SPST-NC DPST-NC nPST-NC (1)
	Changeover Contact	CO	SPDT DPDT nPDT (1)

Utilization categories		
Category	Type of current	Applications
AC-1	~ 1-phase ~ 3-phase	Resistive or slightly inductive loads
AC-3	~ 3-phase	Starting and braking of squirrel cage motors; reversing direction of rotation only after stopping of motor
AC-4	~ 3-phase	Starting of squirrel cage motors, inching; plugging, reversing direction of rotation
DC-1	---	Resistive or slightly inductive loads (2)
AC-14	~ 1-phase	Control of electromagnetic loads (< 72 VA), auxiliary control relays, power contactors, electromagnetic solenoid valves, and electromagnets
AC-15	~ 1-phase	Control of electromagnetic loads (> 72 VA), auxiliary control relays, power contactors, electromagnetic solenoid valves, and electromagnets
DC-13	---	Control of electromagnetic loads, auxiliary control relays, power contactors, magnetic solenoid valves, and electromagnets

Protection categories		
Category	Explanation	Condition
RT 0	Unenclosed relay	Relay not provided with a protective case
RT I	Dust protected relay	Relay provided with a case that helps to protect its mechanism from dust
RT II	Flux-proof relay	Relay capable of being automatically soldered without allowing the migration of solder fluxes beyond the intended areas
RT III	Wash-tight relay	Relay capable of being automatically soldered and then washed to remove flux residues and minimize the possibility of ingress of flux or washing solvents
RT IV	Sealed relay	Relay provided with a case that has no venting to the outside atmosphere
RT V	Hermetically sealed relay	Sealed relay with an enhanced level of sealing

(1) n = number of contacts.

(2) The switchable voltage can be doubled, for an equal current, by connecting 2 contacts in series.

Protection modules

Whenever an inductive load is de-energized (coil of a relay or of a contactor), an overvoltage appears at its terminals. This voltage peak can reach several thousand volts and a frequency of several MHz.

It is likely to disturb the operation of automation systems that contain electronic devices.

Protection modules are used to reduce the voltage peak on de-energization and therefore limit the energy of interference signals to a level that will not disturb surrounding coils and electronic devices.

These modules are used to help reduce the risk of:

- electromagnetic compatibility problems
- deterioration of contact materials
- damage to insulation due to overvoltage
- damage to electronic components

Diode protection module (with or without LED)

Advantages

- accumulation of energy allowing current to flow in the same direction
- absence of any voltage peaks at the coil terminals
- low cost

Disadvantages

- increase in relay drop-out time (3 to 4 times the usual time)
- no polarity protection
- de-energization of the relay

Protection module with varistor

Advantages

- can be used with \sim and --- supply
- voltage peak limited to about $2 U_n$
- little effect on relay drop-out time

Disadvantages

- no modification of coil's own oscillating frequency
- limitation of switching frequency

Protection module with RC circuit

Advantages

- coil oscillating frequency reduced to about 150 Hz
- voltage peak limited to $3 U_n$
- little effect on relay drop-out time

Disadvantages

- no protection for low voltages

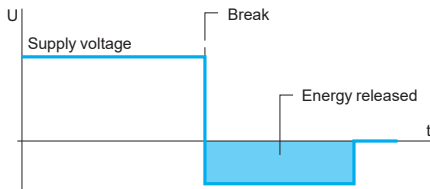

Coil voltage with diode protection module (--- only)

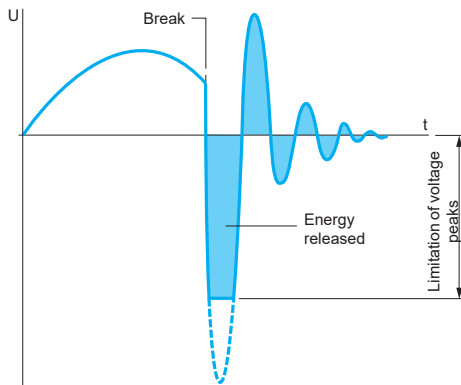

Coil voltage with varistor protection module (\sim and ---)

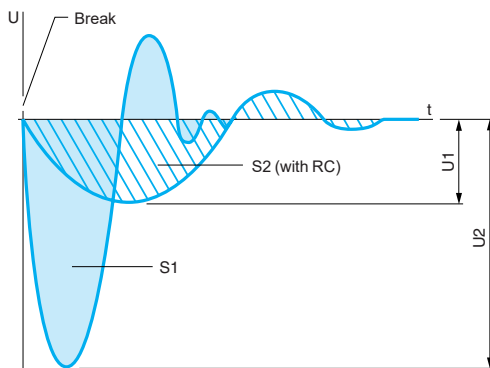

Coil voltage with RC circuit protection module (\sim only)

S1 = S2 = Energy released

Harmony Electromechanical Relays

Interface, miniature, and power
electromechanical relays
Product reference Index

#	782DXDH21-48D	26	RPM32BD	31	RSB1A160U7	14	RUMC21FD	35
16-700DIN	782DXDH21-120A	26	RPM32E7	31	RSB2A080B7	14	RUMC21JD	35
16-725SC-1	782DXDH21-240A	26	RPM32ED	31	RSB2A080B7PV	13	RUMC21P7	35
16-782CBJ-1			RPM32F7	31	RSB2A080BD	14	RUMC22B7	35
16-782FT-1			RPM32FD	31	RSB2A080BDPV	13	RUMC22BD	35
16-1342	R		RPM32JD	31	RSB2A080E7	14	RUMC22E7	35
16-DCLIP-1	RGZE1S35M	19	RPM32P7	31	RSB2A080ED	14	RUMC22ED	35
70-378-1	RGZE1S48M	19	RPM41B7	31	RSB2A080F7	14	RUMC22F7	35
70-379-1	RGZE05P	19	RPM41BD	31	RSB2A080F7PV	13	RUMC22FD	35
70-461-1	RGZE08P	19	RPM41E7	31	RSB2A080FD	14	RUMC22JD	35
70-725-1	RGZL520	19	RPM41ED	31	RSB2A080FD	14	RUMC22JD	35
70-782D14-1	RGZR215	19	RPM41E7	31	RSB2A080JD	14	RUMC22P7	35
70-782E14-1	RGZS08	15	RPM41F7	31	RSB2A080JDPV	13	RUMC31B7	35
70-782EL14-1		19	RPM41FD	31	RSB2A080M7	14	RUMC31BD	35
70-ASMD-250	RPF2AB7	39	RPM41JD	31	RSB2A080M7PV	13	RUMC31E7	35
70-ASMM-24	RPF2ABD	39	RPM41P7	31	RSB2A080ND	14	RUMC31ED	35
70-ASMM-120	RPF2AF7	39	RPM42B7	31	RSB2A080P7	14	RUMC31F7	35
70-ASMM-240	RPF2AJD	39	RPM42BD	31	RSB2A080P7PV	13	RUMC31FD	35
70-BSMD-250	RPF2AP7	39	RPM42E7	31	RSB2A080RD	14	RUMC31GD	35
70-BSMLG-24	RPF2BB7	39	RPM42ED	31	RSB2A080U7	14	RUMC31JD	35
70-BSMM-24	RPF2BBD	39	RPM42F7	31	RSL1AB4BD	11	RUMC31MD	35
70-BSMM-120	RPF2BF7	39	RPM42FD	31	RSL1AB4ED	11	RUMC31ND	35
70-BSMM-240	RPF2BJD	39	RPM42JD	31	RSL1AB4JD	11	RUMC31P7	35
725AXXBC3ML-12D	RPF2BP7	39	RPM42P7	31	RSL1AB4ND	11	RUMC32B7	35
725AXXBC3ML-24A	RPM11B7	31	RPZ1DA	33	RSL1GB4BD	11	RUMC32BD	35
725AXXBC3ML-24D	RPM11BD	31	RPZ1FA	33	RSL1GB4BD	11	RUMC32E7	35
725AXXBC3ML-120A	RPM11E7	31	RPZ3DA	33	RSL1GB4ED	11	RUMC32ED	35
725AXXBC3ML-240A	RPM11ED	31	RPZ3FA	33	RSL1GB4JD	11	RUMC32F7	35
725AXXB4L-12D	RPM11FD	31	RPZ4DA	33	RSL1GB4ND	11	RUMC32FD	35
725AXXB4L-24A	RPM11F7	31	RPZ4FA	33	RSL1PRBU	11	RUMC32GD	35
725AXXB4L-24D	RPM11JD	31	RPZF1	32	RSL1PREU	11	RUMC32JD	35
725AXXB4L-120A	RPM11P7	31	RPZF2	32	RSL1PRFU	11	RUMC32ND	35
725AXXB4L-240A	RPM12B7	31	RPZF3	32	RSL1PRJU	11	RUMC32P7	35
725AXXSC3ML-12D	RPM12BD	31	RPZF4	32	RSL1PRPU	11	RUMF21B7	35
725AXXSC3ML-24A	RPM12B7	31	RPZR235	33	RSL1PVBU	11	RUMF21BD	35
725AXXSC3ML-24D	RPM12ED	31	RSB1A120B7	14	RSL1PVEU	11	RUMF21E7	35
725AXXSC3ML-120A	RPM12ED	31	RSB1A120B7PV	13	RSL1PVFU	11	RUMF21ED	35
725AXXSC3ML-240A	RPM12F7	31	RSB1A120BD	14	RSL1PVJU	11	RUMF21F7	35
725BXXBC3ML-12D	RPM12FD	31	RSB1A120BDPV	13	RSL1PVPU	11	RUMF21FD	35
725BXXBC3ML-24A	RPM12JD	31	RSB1A120E7	14	RSLZ2	11	RUMF21JD	35
725BXXBC3ML-24D	RPM12P7	31	RSB1A120E7	14	RSLZ3	11	RUMF21P7	35
725BXXBC3ML-120A	RPM21B7	31	RSB1A120ED	14	RSLZ5	11	RUMF22B7	35
725BXXBC3ML-240A	RPM21BD	31	RSB1A120F7	14	RSLZRA1	11	RUMF22BD	35
725BXXBM4L-12D	RPM21E7	31	RSB1A120F7PV	13	RSLZRA2	11	RUMF22E7	35
725BXXBM4L-24A	RPM21ED	31	RSB1A120FD	14	RSLZRA3	11	RUMF22ED	35
725BXXBM4L-24D	RPM21F7	31	RSB1A120JD	14	RSLZRA4	11	RUMF22F7	35
725BXXBM4L-120A	RPM21FD	31	RSB1A120JDPV	13	RSLZVA1	11	RUMF22FD	35
725BXXBM4L-240A	RPM21JD	31	RSB1A120M7	14	RSLZVA2	11	RUMF22JD	35
725BXXSC3ML-12D	RPM21P7	31	RSB1A120ND	14	RSLZVA3	11	RUMF22P7	35
725BXXSC3ML-24A	RPM22B7	31	RSB1A120P7	14	RSLZVA4	11	RUMF31B7	35
725BXXSC3ML-24D	RPM22BD	31	RSB1A120P7PV	13	RSZE1S35M	14	RUMF31BD	35
725BXXSC3ML-120A	RPM22E7	31	RSB1A120RD	14	RSZE1S48M	14	RUMF31E7	35
725BXXSC3ML-240A	RPM22ED	31	RSB1A120U7	14	RSZE05P	14	RUMF31ED	35
782XBHX21-24D	RPM22F7	31	RSB1A160B7	14	RSZE08P	14	RUMF31F7	35
782DXDH10-6A	RPM22FD	31	RSB1A160BD	14	RSZL300	15	RUMF31FD	35
782DXDH10-6D	RPM22JD	31	RSB1A160BDPV	13		19	RUMF31JD	35
782DXDH10-12D	RPM22P7	31	RSB1A160E7	14	RSZR215	15	RUMF31P7	35
782DXDH10-24A	RPM31B7	31	RSB1A160ED	14		19	RUMF32B7	35
782DXDH10-24D	RPM31BD	31	RSB1A160F7	14		25	RUMF32BD	35
782DXDH10-110D	RPM31E7	31	RSB1A160FD	14		25	RUMF32E7	35
782DXDH10-120A	RPM31ED	31	RSB1A160JD	14	RUMC21B7	35	RUMF32ED	35
782DXDH10-240A	RPM31F7	31	RSB1A160JDPV	13	RUMC21BD	35	RUMF32F7	35
782DXDH21-12D	RPM31FD	31	RSB1A160M7	14	RUMC21E7	35	RUMF32FD	35
782DXDH21-24D	RPM31JD	31	RSB1A160ND	14	RUMC21ED	35	RUMF32JD	35
	RPM31P7	31	RSB1A160P7	14	RUMC21FD	35	RUMF32P7	35
	RPM32B7	31	RSB1A160P7PV	13				
			RSB1A160RD	14				

RUW101MW	32	RXG15P7	18	RXM2AB2B7PVS	22	RXM4GB1FD	23
	36	RXG15RD	18	RXM2AB2BD	23	RXM4GB1JD	23
RUW240BD	32	RXG21B7	17	RXM2AB2BDPVM	22	RXM4GB1P7	23
	36	RXG21B7PVP	17	RXM2AB2BDPVS	22	RXM4GB2B7	23
RUW241P7	32	RXG21BD	17	RXM2AB2E7	23	RXM4GB2BD	23
	36	RXG21BDPV	17	RXM2AB2ED	23	RXM4GB2E7	23
RUW242B7	32	RXG21E7	17	RXM2AB2F7	23	RXM4GB2ED	23
	36	RXG21ED	17	RXM2AB2FD	23	RXM4GB2F7	23
RUW242P7	32	RXG21F7	17	RXM2AB2JD	23	RXM4GB2FD	23
	36	RXG21FD	17	RXM2AB2P7	23	RXM4GB2GD	23
RUZC2M	36	RXG21JD	17	RXM2AB2P7PVM	22	RXM4GB2JD	23
RUZC3M	36	RXG21M7	17	RXM2AB2P7PVS	22	RXM4GB2MD	23
RUZC200	37	RXG21ND	17	RXM3AB1B7	23	RXM4GB2ND	23
RUZL420	37	RXG21P7	17	RXM3AB1BD	23	RXM4GB2P7	23
RUZS2	37	RXG21P7PVP	17	RXM3AB1E7	23	RXM4GB2U7	23
RUZSC2M	36	RXG21RD	17	RXM3AB1ED	23	RXM021BN	24
RUZSC3M	36	RXG22B7	18	RXM3AB1F7	23		32
RUZSF3M	36	RXG22B7PVP	17	RXM3AB1FD	23	RXM021FP	24
RXG11B7	17	RXG22BD	18	RXM3AB1JD	23		32
RXG11BD	17	RXG22BDPV	17	RXM3AB1P7	23	RXM021RB	24
RXG11E7	17	RXG22E7	18	RXM3AB2B7	23		32
RXG11ED	17	RXG22ED	18	RXM3AB2BD	23	RXM040W	24
RXG11F7	17	RXG22F7	18	RXM3AB2E7	23		32
RXG11FD	17	RXG22FD	18	RXM3AB2ED	23	RXM041BN7	24
RXG11JD	17	RXG22JD	18	RXM3AB2F7	23		32
RXG11M7	17	RXG22M7	18	RXM3AB2FD	23	RXM041FU7	24
RXG11ND	17	RXG22ND	18	RXM3AB2JD	23		32
RXG11P7	17	RXG22P7	18	RXM3AB2P7	23	RXZ400	25
RXG11RD	17	RXG22P7PVP	17	RXM4AB1B7	23	RXZE2DA	25
RXG12B7	18	RXG22RD	18	RXM4AB1B7PVM	22		33
RXG12B7PVP	17	RXG23B7	18	RXM4AB1B7PVS	22	RXZE2FA	25
RXG12BD	18	RXG23BD	18	RXM4AB1BD	23		33
RXG12BDPV	17	RXG23BDPV	17	RXM4AB1BDPVM	22	RXZE2M114	24
RXG12E7	18	RXG23E7	18	RXM4AB1BDPVS	22	RXZE2M114M	24
RXG12ED	18	RXG23ED	18	RXM4AB1E7	23	RXZE2S108M	24
RXG12F7	18	RXG23F7	18	RXM4AB1ED	23	RXZE2S111M	24
RXG12FD	18	RXG23FD	18	RXM4AB1F7	23	RXZE2S114M	24
RXG12JD	18	RXG23JD	18	RXM4AB1FD	23	RXZE2S114S	24
RXG12M7	18	RXG23M7	18	RXM4AB1JD	23	RXZE14P	24
RXG12ND	18	RXG23M7	18	RXM4AB1MD	23	RXZL300	25
RXG12P7	18	RXG23ND	18	RXM4AB1P7	23	RXZL420	25
RXG12P7PVP	17	RXG23P7	18	RXM4AB1P7PVM	22	RXZL520	25
RXG12RD	18	RXG23P7PVP	17	RXM4AB1P7PVS	22		33
RXG13B7	18	RXG23RD	18	RXM4AB1U7	23		37
RXG13BD	18	RXG25B7	18	RXM4AB2B7	23	RXZR315	25
RXG13BDPV	17	RXG25BD	18	RXM4AB2B7PVM	22	RXZR335	25
RXG13E7	18	RXG25E7	18	RXM4AB2B7PVS	22	RXZS2	25
RXG13ED	18	RXG25ED	18	RXM4AB2BD	23	RZM021BN	14
RXG13F7	18	RXG25F7	18	RXM4AB2BDPVM	22		19
RXG13FD	18	RXG25FD	18	RXM4AB2BDPVS	22	RZM021FP	14
RXG13JD	18	RXG25JD	18	RXM4AB2E7	23		19
RXG13M7	18	RXG25M7	18	RXM4AB2ED	23	RZM021RB	14
RXG13ND	18	RXG25ND	18	RXM4AB2F7	23		19
RXG13P7	18	RXG25P7	18	RXM4AB2FD	23	RZM031BN	14
RXG13P7PVP	17	RXG25RD	18	RXM4AB2GD	23		19
RXG13RD	18	RXM2AB1B7	23	RXM4AB2JD	23	RZM031FPD	14
RXG15B7	18	RXM2AB1BD	23	RXM4AB2P7	23		19
RXG15BD	18	RXM2AB1E7	23	RXM4AB2P7PVM	22	RZM031RB	14
RXG15E7	18	RXM2AB1ED	23	RXM4AB2P7PVS	22		19
RXG15ED	18	RXM2AB1F7	23	RXM4GB1B7	23	RZM040W	14
RXG15F7	18	RXM2AB1FD	23	RXM4GB1BD	23		19
RXG15FD	18	RXM2AB1JD	23	RXM4GB1E7	23	RZM041BN7	14
RXG15JD	18	RXM2AB1P7	23	RXM4GB1ED	23		19
RXG15M7	18	RXM2AB2B7	23	RXM4GB1F7	23	RZM041FU7	14
RXG15ND	18	RXM2AB2B7PVM	22				19

Life Is On



Learn more about our products at
www.schneider-electric.com/relays

The information provided in this documentation contains general descriptions and/or technical characteristics of the performance of the products contained herein. This documentation is not intended as a substitute for and is not to be used for determining suitability or reliability of these products for specific user applications. It is the duty of any such user or integrator to perform the appropriate and complete risk analysis, evaluation and testing of the products with respect to the relevant specific application or use thereof. Neither Schneider Electric nor any of its affiliates or subsidiaries shall be responsible or liable for misuse of the information contained herein.

Design: Schneider Electric
Photos: Schneider Electric

Schneider Electric Industries SAS

Head Office
35, rue Joseph Monier - CS 30323
F-92500 Rueil-Malmaison Cedex
France

DIA5ED2130303EN
November 2020 - V5.0

X-ON Electronics

Largest Supplier of Electrical and Electronic Components

Click to view similar products for [General Purpose Relays](#) category:

Click to view products by [Schneider](#) manufacturer:

Other Similar products are found below :

[PCN-105D3MH,000](#) [59641F200](#) [5JO-1000CD-SIL](#) [LY1SAC110120](#) [5X827E](#) [5X837F](#) [5X840F](#) [5X842F](#) [5X848E](#) [LY2N-AC120](#) [LY2S-AC220/240](#) [LY2-US-AC120](#) [LY3-US-AC120](#) [LY4F-UA-DC12](#) [LY4F-UA-DC24](#) [LY4F-US-AC120](#) [LY4F-US-AC240](#) [LY4F-US-DC24](#) [LY4F-VD-AC110](#) [LYQ20DC12](#) [M115C60](#) [M115N010](#) [M115N0150](#) [6031007G](#) [603-12D](#) [61211T0B4](#) [61212T400](#) [61222Q400](#) [61243B600](#) [61243C500](#) [61243Q400](#) [61311BOA2](#) [61311BOA6](#) [61311BOA8](#) [61311C0A2](#) [61311COA1](#) [61311COA6](#) [61311F0A2](#) [61311QOA1](#) [61311QOA4](#) [61311T0D6](#) [61311TOA6](#) [61311TOA7](#) [61311TOB3](#) [61311TOB4](#) [61311U0A6](#) [61312Q600](#) [61312T400](#) [61312T600](#) [61313U200](#)