



Product availability: Non-Stock - Not normally stocked in distribution facility



### Main

Range of product	Modicon M171/M172
Product or component type	Controller
Product specific application	HVAC and pumping solution
Variant	Programmable
Total inputs/outputs	14
Discrete input number	2
Discrete output number	1For relay outputs SPDT with independent common 3For relay outputs SPST with same common
Discrete output current	2 AFor relay
Analogue input number	3 analog input NTC 2 configurable
Analogue output number	2 voltage 0...10 V 2 PWM/PPM 20 kHz, 12 V, 35 mA 1 current 0...20 mA/4...20 mA

### Complementary

Number of port	1 LAN expansion bus 1 RS485 - screw terminal block (Modbus serial link)
Input/output number	5 analog output(s) 4 digital output(s) 5 analog input(s)
Discrete input logic	Sink or source (positive/negative)
Contacts usage	Volt-free contacts
Analogue input type	Voltage 0...1 V Voltage 0...10 V (ratiometric) NTC temperature probe - 50...100 °C - resolution: 0.1 °C Pt 1000 temperature probe - 50...400 °C - resolution: 0.1 °C Voltage 0...5 V Current 0...20 mA/4...20 mA
Sensor power supply	12 V DC at 85 mA
[Us] rated supply voltage	100...240 V

### Ordering and shipping details

Category	22537 - M171 / M172 HVAC CONTROLLERS
Discount Schedule	PC12
GTIN	003606480752735
Nbr. of units in pkg.	1
Package weight(Lbs)	0.5999999999999998
Returnability	N
Country of origin	IT

The information provided in this documentation contains general descriptions and/or technical characteristics of the performance of the products contained herein. This documentation is not intended as a substitute for and is not to be used for determining suitability or reliability of these products for specific user applications. It is the duty of any such user or integrator to perform the appropriate and complete risk analysis, evaluation and testing of the products with respect to the relevant specific application or use thereof. Neither Schneider Electric Industries SAS nor any of its affiliates or subsidiaries shall be responsible or liable for misuse of the information contained herein.

## Offer Sustainability

Sustainable offer status	Green Premium product
RoHS (date code: YYWW)	Compliant - since 1429 - Schneider Electric declaration of conformity  Schneider Electric declaration of conformity
REACH	Reference not containing SVHC above the threshold
Product environmental profile	Available
Product end of life instructions	Available
California proposition 65	WARNING: This product can expose you to chemicals including:
----- Substance 1	Lead and lead compounds which is known to the State of California to cause cancer and birth defects or other reproductive harm.
----- More information	For more information go to <a href="http://www.p65warnings.ca.gov">www.p65warnings.ca.gov</a>

Dimensions

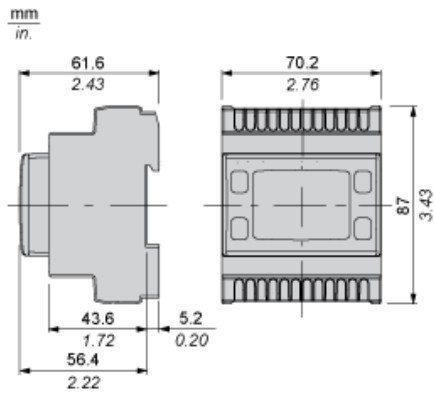

Mounting and Clearance

Clearance

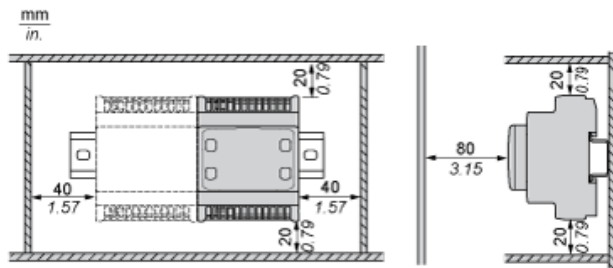

Misplacement

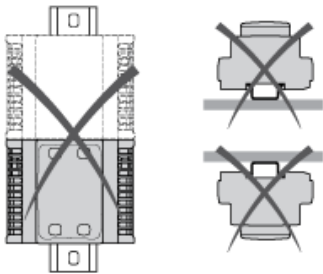

Power Supply

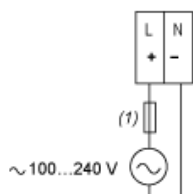

(1) Type T fuse 160 mA

Wiring Diagram

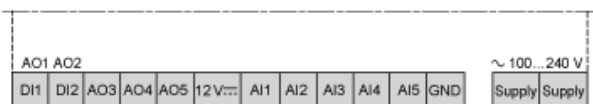
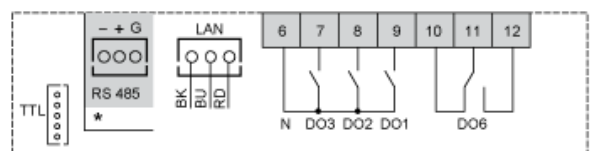

- N : Neutral
- GND Ground
- BK : Black
- BU : Blue
- RD : Red
- AI : Analogue input
- AO : Analogue output
- DI : Digital input
- DO : Digital output

## X-ON Electronics

Largest Supplier of Electrical and Electronic Components

*Click to view similar products for [Controllers](#) category:*

*Click to view products by [Schneider](#) manufacturer:*

Other Similar products are found below :

[61FGPN8DAC120](#) [CV500SLK21](#) [70177-1011](#) [F03-03 HAS C](#) [F03-31](#) [81550401](#) [FT1A-C12RA-W](#) [88981106](#) [H2CAC24A](#) [H2CRSAC110B](#)  
[R88A-CRGB003CR-E](#) [R88ARR080100S](#) [R88A-TK01K](#) [DCN1-1](#) [DRT2ID08C](#) [DTB4896VRE](#) [DTB9696CVE](#) [DTB9696LVE](#) [E53-AZ01](#)  
[E53E01](#) [E53E8C](#) [E5C4Q40J999FAC120](#) [E5CWLQ1TCAC100240](#) [E5GNQ03PFLKACDC24](#) [B300LKL21](#) [NSCXDC1V3](#) [NSH5-232CW-3M](#)  
[NT20SST122BV1](#) [NV-CN001](#) [OAS-160-N](#) [C40PEDRA](#) [K31S6](#) [K33-L1B](#) [K3MA-F](#) [100-240VAC](#) [K3TX-AD31A](#) [89750101](#) [L595020](#)  
[SRM1-C02](#) [SRS2-1](#) [FT1A-C14SA-S](#) [G32X-V2K](#) [26546803](#) [26546805](#) [PWRA440A](#) [CPM1AETL03CH](#) [CV500SLK11](#) [3G2A5BI081](#)  
[3G2A5IA122](#) [3G2A5LK010E](#) [3G2A5OA223](#)