

Product availability: Non-Stock - Not normally stocked in distribution facility



Main

Range of product	Modicon M221
Product or component type	Logic controller
[Us] rated supply voltage	24 V DC
Discrete input number	24 discrete input conforming to IEC 61131-2 Type 1 including 4 fast input
Analogue input number	2 at input range: 0...10 V
Discrete output type	Transistor
Discrete output number	16 transistor including 2 fast output
Discrete output voltage	24 V DC
Discrete output current	0.5 A

Complementary

Discrete I/O number	40
Number of I/O expansion module	<= 7 relay output
Supply voltage limits	20.4...28.8 V
Inrush current	<= 35 A
Power consumption in W	<= 4.1 Wat 24 V without I/O expansion module <= 16 Wat 24 V with max number of I/O expansion module
Power supply output current	0.52 A at 5 V expansion bus 0.3 A at 24 V expansion bus
Discrete input logic	Sink or source (positive/negative)
Discrete input voltage	24 V
Discrete input voltage type	DC
Analogue input resolution	10 bits
LSB value	10 mV
Conversion time	1 ms per channel + 1 controller cycle time analog input
Permitted overload on inputs	+/- 30 V DC analog input with 5 min maximum +/- 13 V DC analog input permanent
Voltage state 1 guaranteed	>= 15 V input
Voltage state 0 guaranteed	<= 5 V input
Discrete input current	7 mA discrete input 5 mA fast input
Input impedance	4.9 kOhm fast input 3.4 kOhm discrete input 100 kOhm analog input
Response time	35 µs turn-off operation input; I2...I5 terminal 5 µs turn-on operation fast input; I0, I1, I6, I7 terminal 35 µs turn-on operation input; other terminals terminal 5 µs turn-off operation fast input; I0, I1, I6, I7 terminal 100 µs turn-off operation input; other terminals terminal 5 µs turn-on, turn-off operation output; Q0...Q1 terminal 50 µs turn-on, turn-off operation output; Q2...Q3 terminal 300 µs turn-on, turn-off operation output; other terminals terminal
Configurable filtering time	0 ms input 12 ms input 3 ms input
Discrete output logic	Positive logic (source)
Current per output common	4 A
Output frequency	100 kHz fast output (PWM/PLS mode) at Q0...Q1 terminal 5 kHz output at Q2...Q3 terminal 0.1 kHz output at Q4...Q15 terminal

The information provided in this documentation contains general descriptions and/or technical characteristics of the performance of the products contained herein. This documentation is not intended as a substitute for and is not to be used for determining suitability or reliability of these products for specific user applications. It is the duty of any such user or integrator to perform the appropriate and complete risk analysis, evaluation and testing of the products with respect to the relevant specific application or use thereof. Neither Schneider Electric Industries SAS nor any of its affiliates or subsidiaries shall be responsible or liable for misuse of the information contained herein.

Absolute accuracy error	+/- 1 % of full scale analog input
Leakage current	0.1 mA transistor output
Voltage drop	<= 1 V
Mechanical durability	>= 20000000 cycles transistor output
Tungsten load	<= 12 W output and fast output
Protection type	Overload and short-circuit protection at 1 A
Reset time	1 s automatic reset
Memory capacity	256 kB user application and data RAM with 10000 instructions 256 kB internal variables RAM
Data backed up	256 kB built-in flash memory backup of application and data
Data storage equipment	2 GB SD card optional
Battery type	BR2032 lithium non-rechargeable, battery life: 4 yr
Backup time	1 year at 77 °F (25 °C) by interruption of power supply
Execution time for 1 KInstruction	0.3 ms event and periodic task
Execution time per instruction	0.2 µs Boolean
Exct time for event task	60 µs response time
Maximum size of object areas	255 %TM timers 255 %C counters 512 %M memory bits 8000 %MW memory words 512 %KW constant words
Realtime clock	With
Clock drift	<= 30 s/month at 77 °F (25 °C)
Regulation loop	Adjustable PID regulator up to 14 simultaneous loops
Positioning functions	Position PTO 2 axe(s) pulse/direction mode (100 kHz) Position PTO 1 axe(s) CW/CCW mode (100 kHz)
Function available	PWM PLS Frequency generator
Counting input number	4 fast input (HSC mode) (counting frequency: 100 kHz), counting capacity: 32 bits
Counter function	A/B Single phase Pulse/direction
Integrated connection type	USB port with connector mini B USB 2.0 Non isolated serial link "serial 1" with connector RJ45 and interface RS485 Non isolated serial link "serial 2" with connector RJ45 and interface RS232/RS485
Supply	Serial serial link supply at 5 V 200 mA
Transmission rate	1.2...115.2 kbit/s (115.2 kbit/s by default) for bus length of 15 m - communication protocol: RS485 1.2...115.2 kbit/s (115.2 kbit/s by default) for bus length of 9.84 ft (3 m) - communication protocol: RS232 480 Mbit/s - communication protocol: USB
Communication port protocol	USB port: USB protocol - SoMachine-Network Non isolated serial link: Modbus protocol master/slave - RTU/ASCII or SoMachine-Network
Local signalling	1 LED green SD card access (SD) 1 LED red BAT 1 LED green SL1 1 LED green SL2 1 LED per channel green I/O state 1 LED red module error (ERR) 1 LED green PWR 1 LED green RUN
Electrical connection	Mini B USB 2.0 connector for a programming terminal Terminal block, 3 terminal(s) for connecting the 24 V DC power supply Connector, 4 terminal(s) for analogue inputs Removable screw terminal block for inputs Removable screw terminal block for outputs
Cable distance between devices	Shielded cable: 10 m for fast input Unshielded cable: 30 m for output Unshielded cable: 30 m for digital input Unshielded cable: 1 m for analog input Shielded cable: 3 m for fast output

Insulation	500 V AC between fast input and internal logic Non-insulated between inputs Non-insulated between analogue inputs 500 V AC between output and internal logic 500 V AC between input and internal logic Non-insulated between analogue input and internal logic
Marking	CE
Mounting support	Top hat type TH35-15 rail conforming to IEC 60715 Top hat type TH35-7.5 rail conforming to IEC 60715 Plate or panel with fixing kit
Height	3.54 in (90 mm)
Depth	2.76 in (70 mm)
Width	6.3 in (160 mm)
Product weight	1.01 lb(US) (0.456 kg)

Environment

Standards	EN/IEC 60664-1 EN/IEC 61131-2 EN/IEC 61010-2-201
Product certifications	EAC CULus IACS E10 LR CSA RCM ABS DNV-GL
Environmental characteristic	Ordinary and hazardous location
Resistance to electrostatic discharge	4 kV on contact conforming to EN/IEC 61000-4-2 8 kV in air conforming to EN/IEC 61000-4-2
Resistance to electromagnetic fields	9.14 V/yd (10 V/m) (80 MHz...1 GHz) conforming to EN/IEC 61000-4-3 2.74 V/yd (3 V/m) (1.4 GHz...2 GHz) conforming to EN/IEC 61000-4-3 1 V/m (2...2.7 GHz) conforming to EN/IEC 61000-4-3
Resistance to magnetic fields	30 A/m 50/60 Hz conforming to EN/IEC 61000-4-8
Resistance to fast transients	2 kV power lines conforming to EN/IEC 61000-4-4 2 kV relay output conforming to EN/IEC 61000-4-4 1 kV Ethernet line conforming to EN/IEC 61000-4-4 1 kV serial link conforming to EN/IEC 61000-4-4 1 kV I/O conforming to EN/IEC 61000-4-4
Surge withstand	2 kV power lines (AC) in common mode conforming to EN/IEC 61000-4-5 2 kV relay output in common mode conforming to EN/IEC 61000-4-5 1 kV I/O in common mode conforming to EN/IEC 61000-4-5 1 kV shielded cable in common mode conforming to EN/IEC 61000-4-5 0.5 kV power lines (DC) in differential mode conforming to EN/IEC 61000-4-5 1 kV power lines (AC) in differential mode conforming to EN/IEC 61000-4-5 1 kV relay output in differential mode conforming to EN/IEC 61000-4-5 0.5 kV power lines (DC) in common mode conforming to EN/IEC 61000-4-5
Resistance to conducted disturbances	10 Vrms (0.15...80 MHz) conforming to EN/IEC 61000-4-6 3 Vrms (0.1...80 MHz) conforming to Marine specification (LR, ABS, DNV, GL) 10 Vrms (spot frequency (2, 3, 4, 6.2, 8.2, 12.6, 16.5, 18.8, 22, 25 MHz)) conforming to Marine specification (LR, ABS, DNV, GL)
Electromagnetic emission	Conducted emissions conforming to EN/IEC 55011 power lines (AC), 0.15...0.5 MHz: 79 dB μ V/m QP/66 dB μ V/m AV Conducted emissions conforming to EN/IEC 55011 power lines (AC), 0.5...300 MHz: 73 dB μ V/m QP/60 dB μ V/m AV Conducted emissions conforming to EN/IEC 55011 power lines, 10...150 kHz: 120...69 dB μ V/m QP Conducted emissions conforming to EN/IEC 55011 power lines, 1.5...30 MHz: 63 dB μ V/m QP Radiated emissions conforming to EN/IEC 55011 class A 10 m, 30...230 MHz: 40 dB μ V/m QP Conducted emissions conforming to EN/IEC 55011 power lines, 150...1500 kHz : 79...63 dB μ V/m QP Radiated emissions conforming to EN/IEC 55011 class A 10 m, 200...1000 MHz : 47 dB μ V/m QP
Immunity to microbreaks	10 ms
Ambient air temperature for operation	14...131 °F (-10...55 °C) horizontal installation -10...35 °C vertical installation
Ambient air temperature for storage	-13...158 °F (-25...70 °C)

Relative humidity	10...95 % without condensation in operation 10...95 % without condensation in storage
IP degree of protection	IP20 with protective cover in place
Pollution degree	<= 2
Operating altitude	0...6561.68 ft (0...2000 m)
Storage altitude	0...9842.52 ft (0...3000 m)
Vibration resistance	3.5 mm (vibration frequency: 5...8.4 Hz) on symmetrical rail 1 gn (vibration frequency: 8.4...150 Hz) on symmetrical rail 3.5 mm (vibration frequency: 5...8.4 Hz) on panel mounting 1 gn (vibration frequency: 8.4...150 Hz) on panel mounting
Shock resistance	147 m/s ² (test wave duration:11 ms)

Ordering and shipping details

Category	22533 - M2XX PLC & ACCESSORIES
Discount Schedule	MSX
GTIN	003606480648748
Nbr. of units in pkg.	1
Package weight(Lbs)	1.6899999999999999
Returnability	N
Country of origin	CN

Offer Sustainability

Sustainable offer status	Green Premium product
RoHS (date code: YYWW)	Compliant - since 1415 - Schneider Electric declaration of conformity Schneider Electric declaration of conformity
REACH	Reference not containing SVHC above the threshold
Product environmental profile	Available
Product end of life instructions	Available
California proposition 65	WARNING: This product can expose you to chemicals including:
----- Substance 1	Lead and lead compounds, which is known to the State of California to cause cancer and birth defects or other reproductive harm.
----- More information	For more information go to www.p65warnings.ca.gov

Dimensions

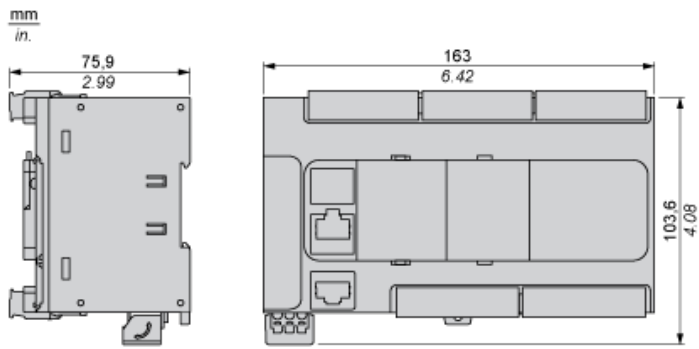

Mounting on a Rail

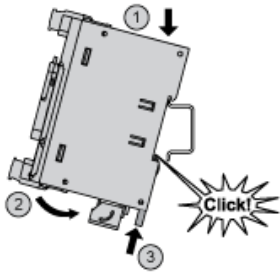

Direct Mounting on a Panel Surface

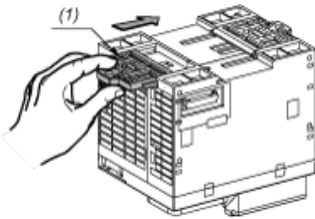

- (1) Install a mounting strip

Mounting Hole Layout

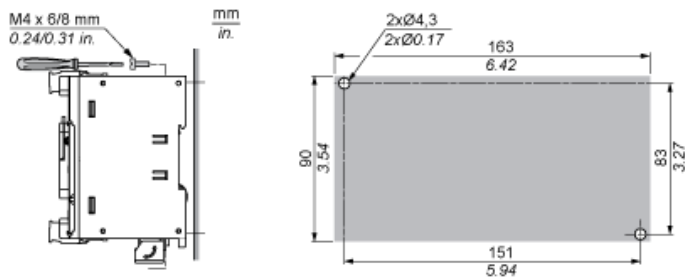

Mounting

Correct Mounting Position

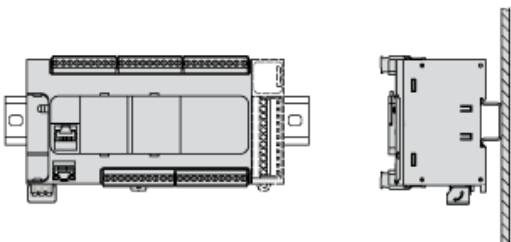

Acceptable Mounting Position

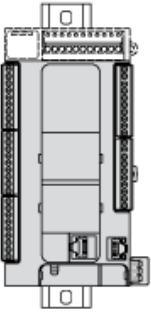

Incorrect Mounting Position

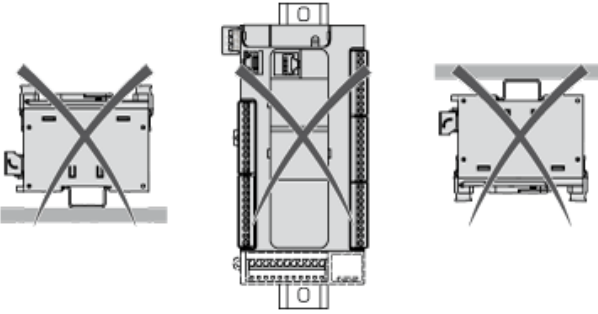

Clearance

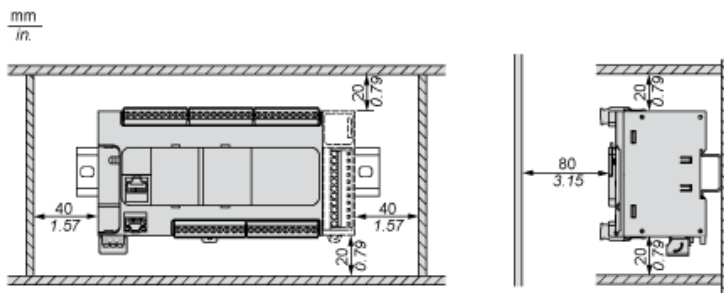

Digital Inputs

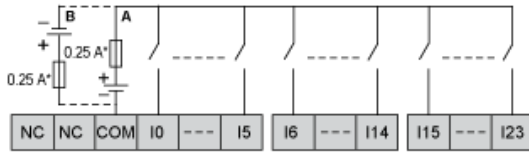

- (*) Type T fuse
- (A) Sink wiring (positive logic).
- (B) Source wiring (negative logic).

Connection of the Fast Inputs

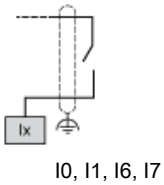

I0, I1, I6, I7

Transistor Outputs

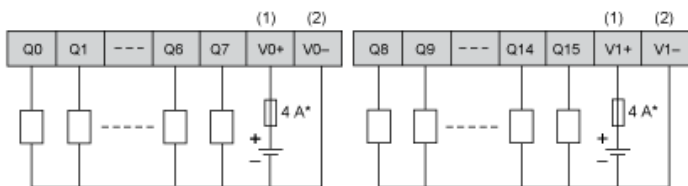

- (*) Type T fuse
- (1) The V0+ and V1+ terminals are not connected internally.
- (2) The V0- and V1- terminals are not connected internally.

Connection of the Fast Outputs

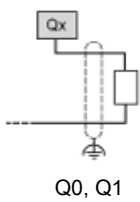

Q0, Q1

Analog Inputs

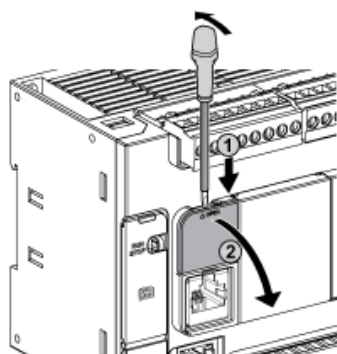

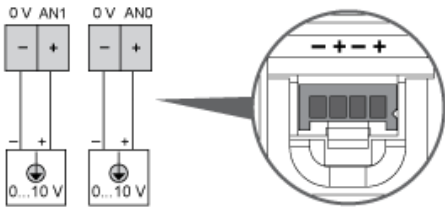

The (-) poles are connected internally.

Pin	Wire Color
0 V	Black
AN1	Red
0 V	Black
AN0	Red

USB Mini-B Connection

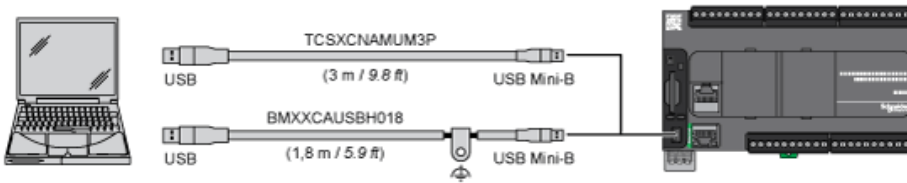

SL1 Connection

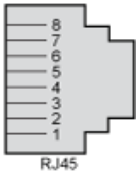

SL1

N °	RS 232	RS 485
1	RxD	N.C.
2	TxD	N.C.
3	RTS	N.C.
4	N.C.	D1
5	N.C.	D0
6	CTS	N.C.
7	N.C.*	5 Vdc
8	Common	Common

N.C.: not connected

* : 5 Vdc delivered by the controller. Do not connect.

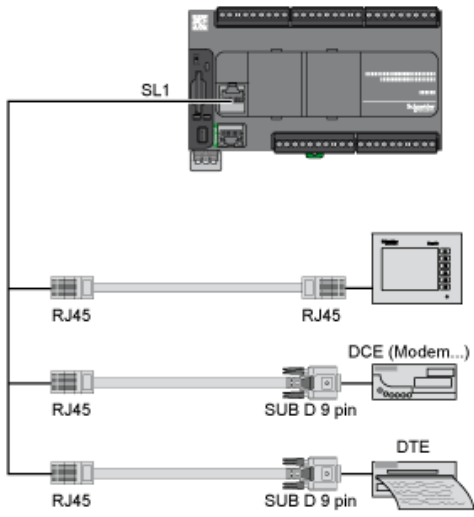

SL2 Connection

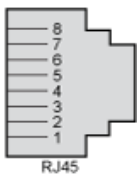

N °	RS 485
1	N.C.
2	N.C.
3	N.C.
4	D1
5	D0
6	N.C.
7	N.C.
8	Common

N.C.: not connected

Derating Curves

Embedded Digital Inputs (No Cartridge)

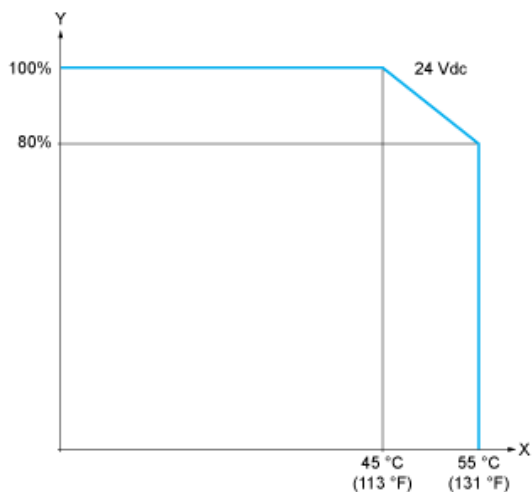

X : Ambient temperature
Y : Input simultaneous ON ratio

Embedded Digital Inputs (with Cartridge)

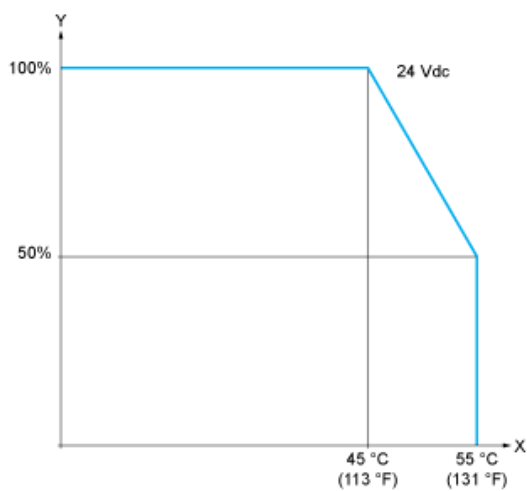

X : Ambient temperature
Y : Input simultaneous ON ratio

Derating Curves

Embedded Digital Outputs (No Cartridge)

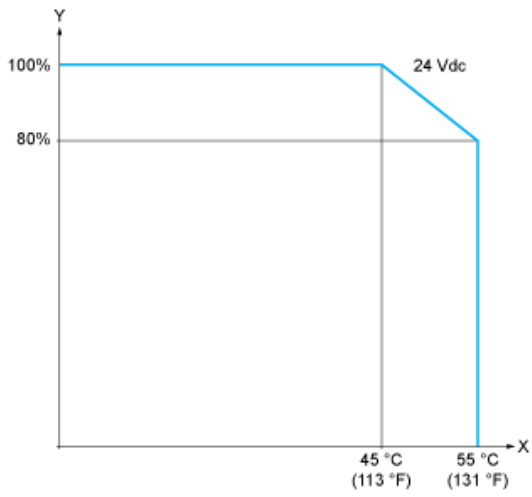

X : Ambient temperature
Y : Output simultaneous ON ratio

Embedded Digital Outputs (with Cartridge)

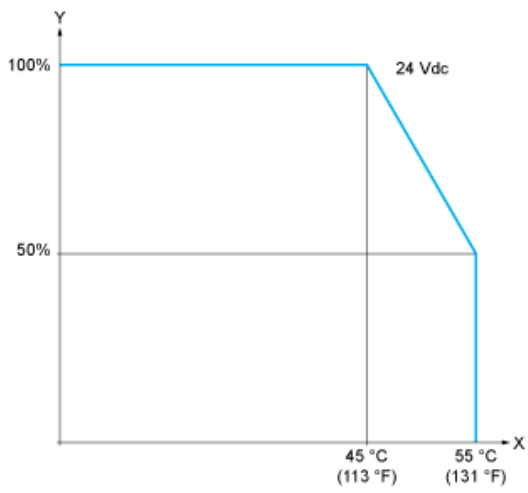

X : Ambient temperature
Y : Output simultaneous ON ratio

X-ON Electronics

Largest Supplier of Electrical and Electronic Components

Click to view similar products for [Controllers](#) category:

Click to view products by [Schneider](#) manufacturer:

Other Similar products are found below :

[61FGPN8DAC120](#) [CV500SLK21](#) [70177-1011](#) [F03-03 HAS C](#) [F03-31](#) [81550401](#) [FT1A-C12RA-W](#) [88981106](#) [H2CAC24A](#) [H2CRSAC110B](#)
[R88A-CRGB003CR-E](#) [R88ARR080100S](#) [R88A-TK01K](#) [DCN1-1](#) [DRT2ID08C](#) [DTB4896VRE](#) [DTB9696CVE](#) [DTB9696LVE](#) [E53-AZ01](#)
[E53E01](#) [E53E8C](#) [E5C4Q40J999FAC120](#) [E5CWLQ1TCAC100240](#) [E5GNQ03PFLKACDC24](#) [B300LKL21](#) [NSCXDC1V3](#) [NSH5-232CW-3M](#)
[NT20SST122BV1](#) [NV-CN001](#) [OAS-160-N](#) [C40PEDRA](#) [K31S6](#) [K33-L1B](#) [K3MA-F](#) [100-240VAC](#) [K3TX-AD31A](#) [89750101](#) [L595020](#)
[SRM1-C02](#) [SRS2-1](#) [FT1A-C14SA-S](#) [G32X-V2K](#) [26546803](#) [26546805](#) [PWRA440A](#) [CPM1AETL03CH](#) [CV500SLK11](#) [3G2A5BI081](#)
[3G2A5IA122](#) [3G2A5LK010E](#) [3G2A5OA223](#)