

## Door mounting isolation switch - mini Vario - Vario

Type of product	Range		Pages
Switch disconnectors mini-Vario	Up to 12 or 20 A		B3/2
Switch disconnectors, high performance applications Vario	From 12 to 175 A		B3/6
Accessories mini-Vario and Vario			B3/8

Switch-  
disconnectors

Technical Data for Designers

B3/17

## TeSys protection components

Mini-VARIO switch-disconnectors for standard applications

Complete units

- 3-pole rotary switch-disconnectors, 12 to 20 A
- Marking on operator .
- Padlockable operating handle (padlocks not supplied).
- Degree of protection IP 65.



VCDN 20

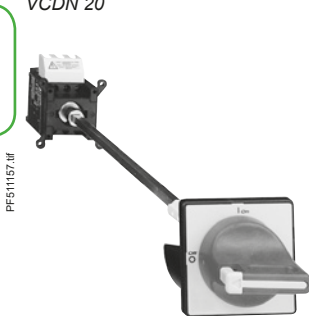

VCCDN 20



VBDN 20

Switch-disconnectors

### Main and Emergency stop switch-disconnectors for door mounting

Operator	Front plate	Fixing	Ith	Reference
Handle	mm	mm	A	
Red, padlockable with up to 3 padlocks (Ø4 to Ø8)	Yellow 60 x 60	Ø22.5	12	VCDN12
			20	VCDN20

### Main and Emergency stop switch-disconnectors for mounting at back of an enclosure <sup>(1)</sup>

Operator	Front plate	Fixing	Ith	Reference
Handle	mm	mm	A	
Red, padlockable with up to 3 padlocks (Ø4 to Ø8)	Yellow 60 x 60	Ø22.5	12	VCCDN12
			20	VCCDN20

### Main switch-disconnectors for door mounting

Operator	Front plate	Fixing	Ith	Reference
Handle	mm	mm	A	
Black, padlockable with up to 3 padlocks (Ø4 to Ø8)	Black 60 x 60	Ø22.5	12	VBDN12
			20	VBDN20

<sup>(1)</sup> Switches supplied with a shaft extension VZN 17 and a door interlock plate KZ 32 (see page B3/5).

## References (continued) - Mini-Vario

### TeSys protection components

Mini-VARIO switch-disconnectors for standard applications

Switch bodies, add-on modules

812801.tif

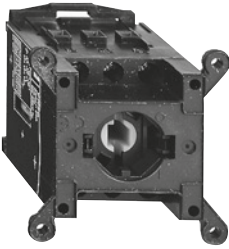

VN 20

590586.tif



VZN 11

590587.tif



VZN 14

590588.tif



VZN 05

812805.tif



VZN 26

812806.tif

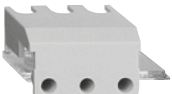

VZN 08

#### Switch bodies

Description	Rating A	Reference
3-pole switch-disconnectors	12	VN12
	20	VN20

#### Add-on modules

Description	Rating A	Reference
Main pole modules	12	VZN12
	20	VZN20
Neutral pole module with early make and late break contacts	12 and 20	VZN11
Earthing module	12 and 20	VZN14
Auxiliary contact block modules	1 N/O late make contact	VZN05
	1 N/C early break contact	VZN06
Input terminal protection shrouds	For add-on pole modules or auxiliary contact block modules (single-pole shroud)	VZN26
	For switch bodies (3-pole shroud)	VZN08

Switch-disconnectors

#### Maximum number of add-on modules that can be fitted on a switch body

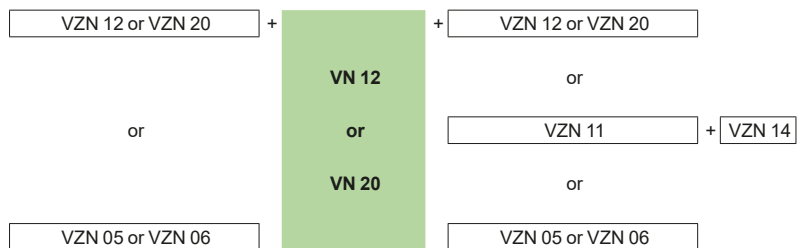

DP580544.eps

Switch-disconnectors

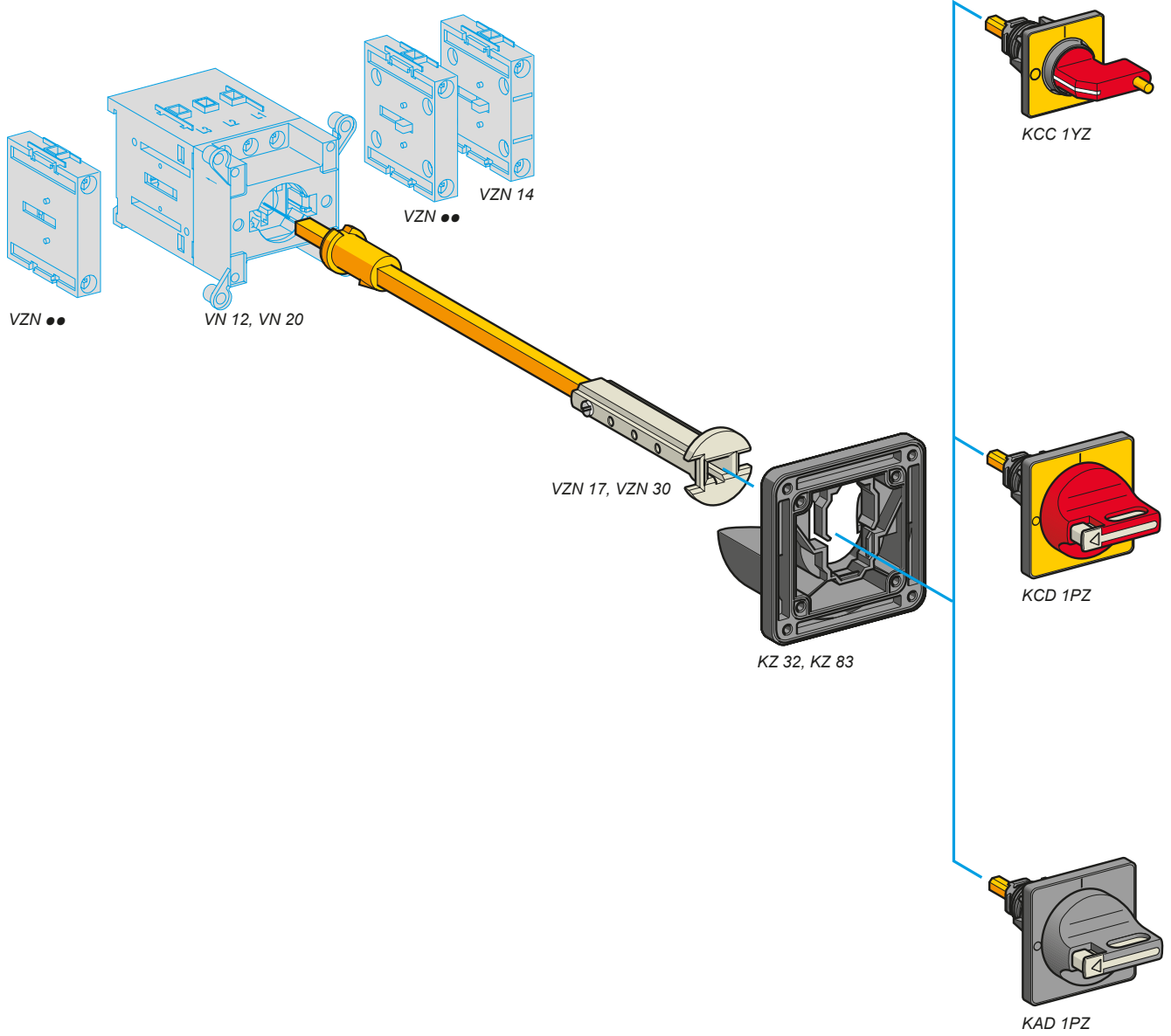

## TeSys protection components

Mini-VARIO switch-disconnectors for standard applications

Operators and accessories

- Degree of protection IP 65.
- Marking on operator .
- Padlockable operating handle (padlocks not supplied).
- Operator fixing by 1 Ø22.5 hole; for other operators see pages B3/11 and B3/13.
- For other accessories and empty enclosures, see pages B3/14, B3/15 and A1/3.

## Operators for main and Emergency stop switch-disconnectors

Handle	Front plate mm	Reference
Red, padlockable with 1 padlock (Ø4 to Ø6)	Yellow 45 x 45	<b>KCC1YZ</b>
Red, padlockable with up to 3 padlocks (Ø4 to Ø8)	Yellow 60 x 60	<b>KCD1PZ</b>

## Operators for main switch-disconnectors

Handle	Front plate mm	Reference
Black, padlockable with up to 3 padlocks (Ø4 to Ø8)	Black 60 x 60	<b>KAD1PZ</b>

## Accessories for door interlocking

For rear fixing switch-disconnectors mounted at the back of an enclosure, in addition to a direct operator

Description	Front plate mm	Distance enclosure back/door mm	Sold in lots of	Unit reference
Shaft extensions	–	300...330	1	<b>VZN17</b>
		400...430	1	<b>VZN30</b>
Door interlock plate	45 x 45 or 60 x 60	–	5	<b>KZ32</b>
Plate for door mounting	45 x 45 or 60 x 60	–	5	<b>KZ83</b>

# TeSys protection components

VARIO switch-disconnectors for high performance applications

Complete units

- 3-pole rotary switch-disconnectors, 12 to 175 A
- Marking on operator .
- Padlockable operating handle (padlocks not supplied).
- Degree of protection IP 65.

Switch-disconnectors

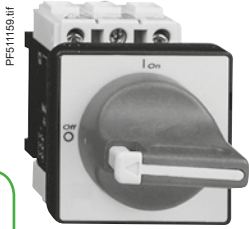

VCF 0



VCF 5



VCCF 0

## Main and Emergency stop switch-disconnectors for door mounting

Handle	Front plate mm	Fixing	Rating A	Reference	Weight kg
Red, padlockable with up to 3 padlocks (Ø4 to Ø8)	Yellow 60 x 60	Ø22.5	12	VCD02	0.215
			20	VCD01	0.215
			25	VCD0	0.215
			32	VCD1	0.215
			40	VCD2	0.215
			40	VCD2	0.215
4 screws	Yellow 60 x 60	Ø22.5	12	VCF02	0.250
			20	VCF01	0.250
			25	VCF0	0.250
			32	VCF1	0.250
			40	VCF2	0.250
			63	VCF3	0.560
			80	VCF4	0.560
			4 screws	Yellow 90 x 90	Ø22.5
175	VCF6	1.200			

## Main and Emergency stop switch-disconnectors for mounting at back of an enclosure <sup>(1)</sup>

Handle	Front plate mm	Fixing	Rating A	Reference	Weight kg
Red, padlockable with up to 3 padlocks (Ø4 to Ø8)	Yellow 60 x 60	Ø22.5	12	VCCD02	0.392
			20	VCCD01	0.392
			25	VCCD0	0.392
			32	VCCD1	0.392
			40	VCCD2	0.392
			40	VCCD2	0.392
4 screws	Yellow 60 x 60	Ø22.5	12	VCCF02	0.527
			20	VCCF01	0.527
			25	VCCF0	0.527
			32	VCCF1	0.527
			40	VCCF2	0.527
			63	VCCF3	0.440
			80	VCCF4	0.680
			4 screws	Yellow 90 x 90	Ø22.5
175	VCCF6	1.320			

<sup>(1)</sup> Unit supplied with a shaft extension VZN 17 or VZ18 and a door interlock plate KZ 32 or KZ 74 (see page B3/14).

# TeSys protection components

VARIO switch-disconnectors for high performance applications

Complete units

- 3-pole rotary switch-disconnectors, 12 to 175 A
- Marking on operator .
- Padlockable operating handle (padlocks not supplied).
- Degree of protection IP 65.

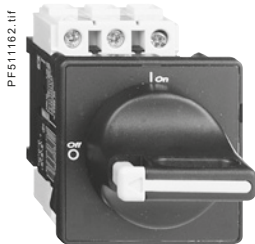

VBD 0

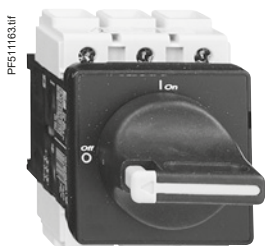

VBF 4

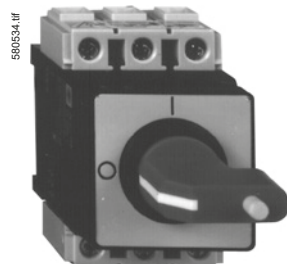

VVE 1

### Main switch-disconnectors for door mounting

Handle	Front plate mm	Fixing	Rating A	Reference	Weight kg
Black, padlockable with up to 3 padlocks (Ø4 to Ø8)	Black 60 x 60	Ø22.5	12	VBD02	0.215
			20	VBD01	0.215
			25	VBD0	0.215
			32	VBD1	0.215
			40	VBD2	0.215
4 screws			12	VBF02	0.250
			20	VBF01	0.250
			25	VBF0	0.250
			32	VBF1	0.250
			40	VBF2	0.250
			63	VBF3	0.560
			80	VBF4	0.560
Black, long, padlockable with up to 3 padlocks (Ø4 to Ø8)	Black 90 x 90	4 screws	125	VBF5	1.200
			175	VBF6	1.200

Switch-disconnectors

### Main and Emergency stop switch-disconnectors

#### For mounting in an enclosure or for modular distribution boards

Handle	Front plate mm	Fixing	Rating A	Reference	Weight kg
Red, padlockable with 1 padlock (Ø4 to Ø6)	Yellow 45 x 45	4 screws	25	VVE0	0.250
			32	VVE1	0.250
			40	VVE2	0.250
			63	VVE3	0.530
			80	VVE4	0.530

### Main switch-disconnectors

#### For mounting in an enclosure or for modular distribution boards

Handle	Front plate mm	Fixing	Rating A	Reference	Weight kg
Black, not padlockable	Black 45 x 45	4 screws	25	VVD0	0.250
			32	VVD1	0.250
			40	VVD2	0.250
			63	VVD3	0.560
			80	VVD4	0.560

# TeSys protection components

VARIO switch-disconnectors for high performance applications

Switch bodies, add-on modules, auxiliary contacts (for customer assembly)

Switch-disconnectors

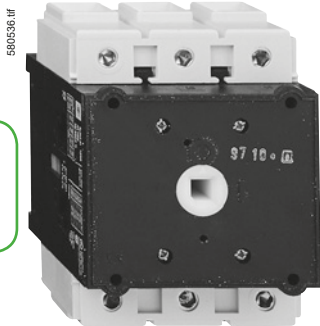

V5



VZ 0



VZ 11



VZ 15



VZ 20

## Switch bodies

Description	Rating A	Reference
3-pole switch-disconnectors <sup>(1)</sup>	12	V02
	20	V01
	25	V0
	32	V1
	40	V2
	63	V3
	80	V4
	125	V5
	175	V6

## Add-on modules

Description	Rating A	Reference
Main pole modules	12	VZ02
	20	VZ01
	25	VZ0
	32	VZ1
	40	VZ2
	63	VZ3
	80	VZ4
	Neutral pole modules with early make and late break contacts <sup>(1)</sup>	12 to 40
63 to 80		VZ12
125 and 175		VZ13
Earthing modules	12 to 40	VZ14
	63 and 80	VZ15
	125 and 175	VZ16

## Auxiliary contact block modules

Description	Type	Reference
Auxiliary contact block modules with 2 auxiliary contacts	N/O + N/C <sup>(2)</sup>	VZ7
	N/O + N/O	VZ20

<sup>(1)</sup> Protection shrouds are available if required: see page B3/14.

<sup>(2)</sup> Late make N/O, early break N/C contacts



# TeSys protection components

VARIO switch-disconnectors for high performance applications

Switch bodies, add-on modules, auxiliary contacts (for customer assembly)

## Maximum number of add-on modules that can be fitted on a switch body

### 1 add-on module on each side of the switch body

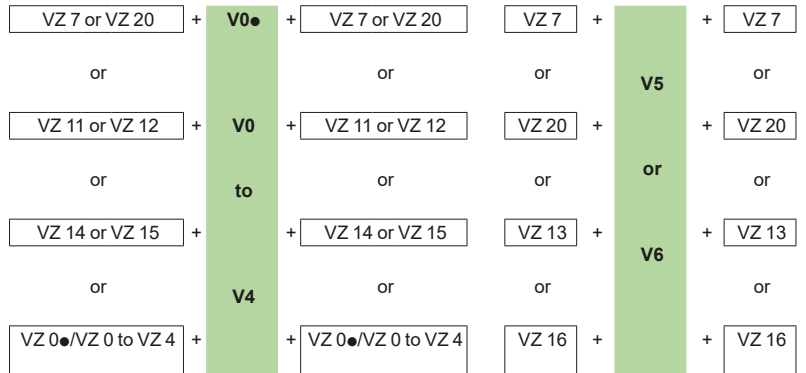

Switch-disconnectors

### 2 add-on modules on each side of the switch body

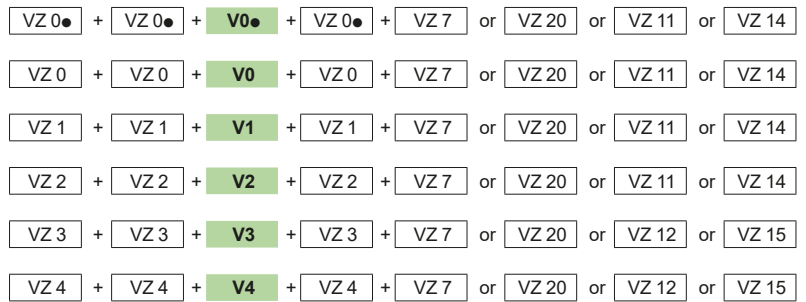

**Note:** The add-on modules mounted next to the switch body are main pole modules. Maximum of 3 main pole modules per switch body.

DF503798.eps

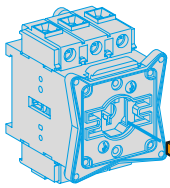

VN 12, VN 20  
V02...V2

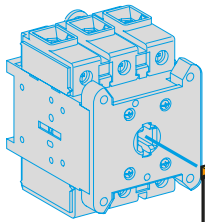

V3, V4

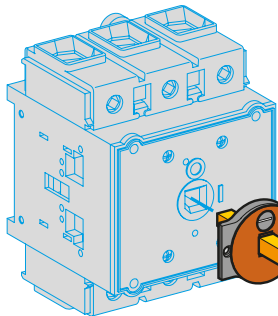

V5, V6

VZN 17,  
VZN 30

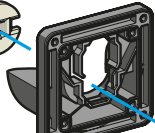

KZ 32, KZ 83

VZ 18, VZ 31

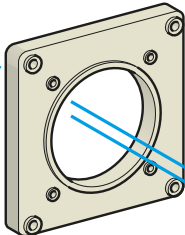

KZ 81

VZ 18, VZ 31

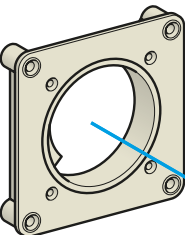

KZ 74

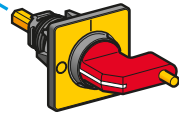

KC 1YZ

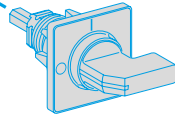

KC 1LZ

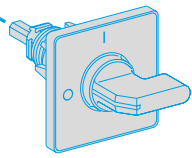

KA 1BZ

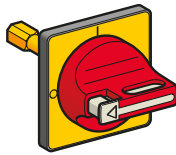

KC 1PZ



KA 1PZ

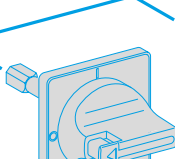

KD 1PZ

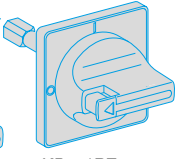

KB 1PZ

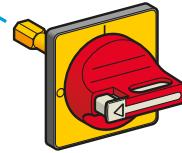

KCF 2PZ

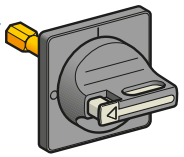

KAF 2PZ

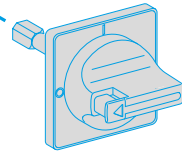

KDF 2PZ

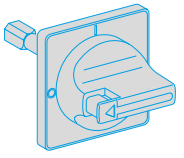

KBF 2PZ

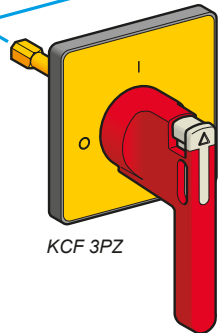

KCF 3PZ

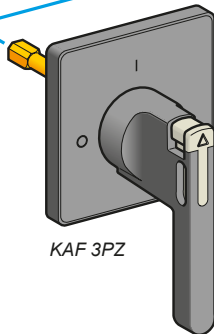

KAF 3PZ

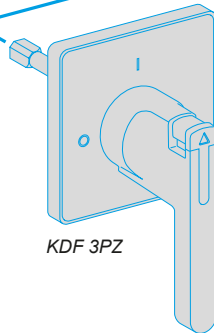

KDF 3PZ

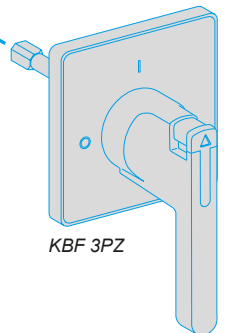

KBF 3PZ

Switch-  
disconnectors

## Protection components

## Mini-VARIO and VARIO switch-disconnectors

Operators, handles and front plates (for customer assembly)

- Marking on operator  $\circ \downarrow$ .
- Padlockable operating handle (padlocks not supplied).
- Degree of protection IP 65.

## Handles and front plates for main and Emergency stop switch-disconnectors

For switch body	Operator Handle	Front plate		Reference
		Dimensions	Fixing	
		mm		
VN 12, VN 20 V02...V2	Red, padlockable with 1 padlock (Ø4 to Ø6)	Yellow	Ø22.5	<b>KCC1YZ</b>
		45 x 45	4 screws	<b>KCE1YZ</b>
	Red, padlockable with up to 3 padlocks (Ø4 to Ø8)	Yellow	Ø22.5	<b>KCD1PZ</b>
		60 x 60	4 screws	<b>KCF1PZ</b>
V3 and V4	Red, padlockable with up to 3 padlocks (Ø4 to Ø8)	Yellow	4 screws	<b>KCF2PZ</b>
V5 and V6	Red, long, padlockable with up to 3 padlocks (Ø4 to Ø8)	Yellow	4 screws	<b>KCF3PZ</b> <sup>(1)</sup>
		90 x 90		

## Handles and front plates for main switch-disconnectors

For switch body	Operator Handle	Front plate		Reference
		Dimensions	Fixing	
		mm		
VN 12, VN 20 V02...V2	Black, padlockable with up to 3 padlocks (Ø4 to Ø8)	Black	Ø22.5	<b>KAD1PZ</b>
		60 x 60	4 screws	<b>KAF1PZ</b>
V3 and V4	Black, padlockable with up to 3 padlocks (Ø4 to Ø8)	Black	4 screws	<b>KAF2PZ</b>
V5 and V6	Black, long, padlockable with up to 3 padlocks (Ø4 to Ø8)	Black	4 screws	<b>KAF3PZ</b> <sup>(1)</sup>
		90 x 90		

<sup>(1)</sup> For door mounting of 63 and 80 A switch-disconnectors, adapter plate **KZ 106** must be ordered separately (see page B3/14).

DF503799.eps

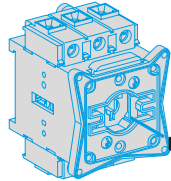

VN 12, VN 20  
V02...V2

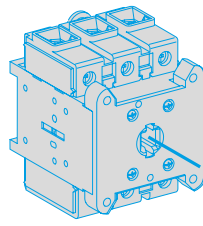

V3, V4

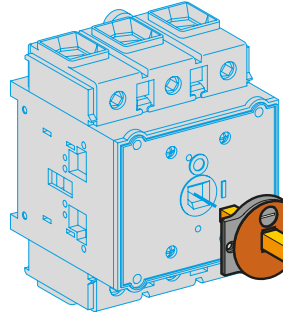

V5, V6

Switch-disconnectors

VZN 17,  
VZN 30

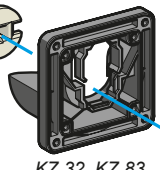

KZ 32, KZ 83

VZ 18, VZ 31

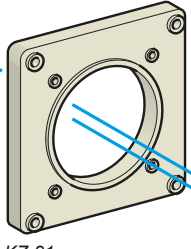

KZ 81

VZ 18, VZ 31

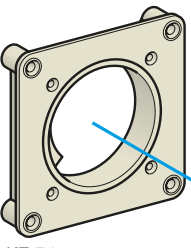

KZ 74

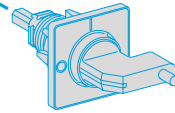

KC 1YZ

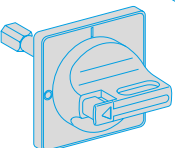

KC 1PZ

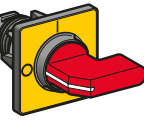

KC 1LZ

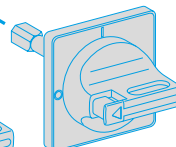

KA 1PZ

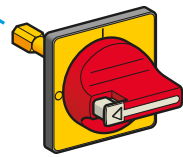

KDF 2PZ

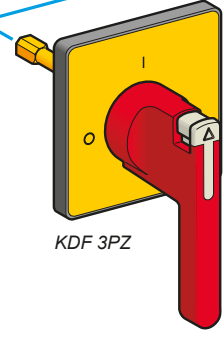

KDF 3PZ

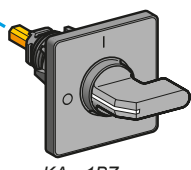

KA 1BZ

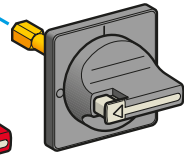

KB 1PZ

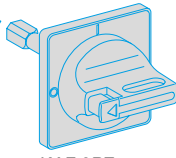

KAF 2PZ



KBF 2PZ

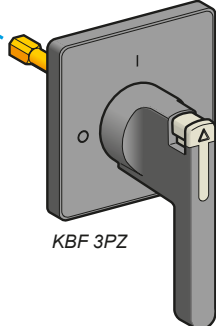

KBF 3PZ

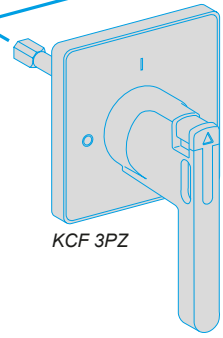

KCF 3PZ

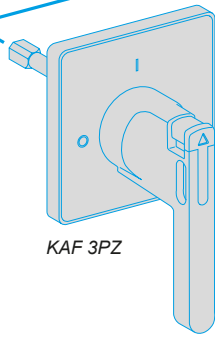

KAF 3PZ

## Protection components

## Mini-VARIO and VARIO switch-disconnectors

Operators, handles and front plates (for customer assembly)

- Marking on operator  $\circ \downarrow$ .
- Degree of protection IP 65.

## Handles and front plates for Emergency stop switch-disconnectors

For switch body	Operator Handle	Front plate		Reference
		Dimensions	Fixing	
		mm		
VN 12, VN 20 V02...V2	Red, not padlockable	Yellow 45 x 45	Ø22.5	<b>KCC1LZ</b>
			4 screws	<b>KCE1LZ</b>
		Yellow 60 x 60	Ø22.5	<b>KDD1PZ</b>
			4 screws	<b>KDF1PZ</b>
V3 and V4	Red, long, not padlockable	Yellow 60 x 60	4 screws	<b>KDF2PZ</b>
V5 and V6	Red, long, not padlockable	Yellow 90 x 90	4 screws	<b>KDF3PZ <sup>(1)</sup></b>

## Handles and front plates for switch-disconnectors

For switch body	Operator Handle	Front plate		Reference
		Dimensions	Fixing	
		mm		
VN 12, VN 20 V02...V2	Black, not padlockable	Black 45 x 45	Ø22.5	<b>KAC1BZ</b>
			4 screws	<b>KAE1BZ</b>
		Black 60 x 60	Ø22.5	<b>KBD1PZ</b>
			4 screws	<b>KBF1PZ</b>
V3 and V4	Black, not padlockable	Black 60 x 60	4 screws	<b>KBF2PZ</b>
V5 and V6	Black, not padlockable	Black 90 x 90	4 screws	<b>KBF3PZ <sup>(1)</sup></b>

<sup>(1)</sup> For door mounting of 63 and 80 A switch-disconnectors, adapter plate **KZ 106** must be ordered separately (see next page).

Protection components

Mini-VARIO and VARIO switch-disconnectors

Accessories

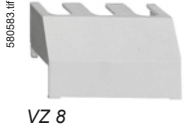

Switch-disconnectors

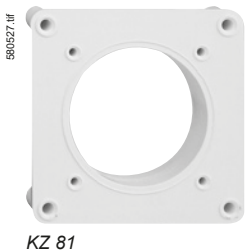
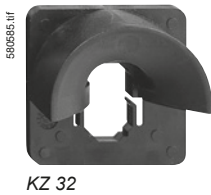
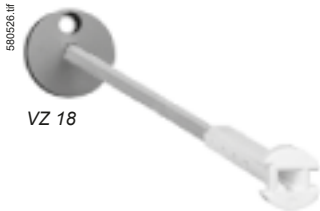

Input terminal protection shrouds

Description	For use on	Reference
For switch bodies (3-pole shroud)	V02...V2	VZ8
	V3 and V4	VZ9
	V5 and V6	VZ10
For add-on pole modules (single-pole shroud)	VZ 02...VZ 2, VZ 11, VZ 14	VZ26
	VZ 3, VZ 4, VZ 12, VZ 15	VZ27
	VZ 13, VZ 16	VZ28
For contact blocks with 2 auxiliary contacts	-	VZ29

Components for door interlocking

For rear fixing switch-disconnectors mounted at the back of an enclosure, in addition to a direct operator

Description	For use on	Distance enc. back/door	Sold in lots of	Unit reference
				mm
Shaft extensions	VN 12, VN 20 V02...V2	300...330	1	VZN17 <sup>(1)</sup>
		400...430	1	VZN30 <sup>(1)</sup>
	V02...V2	300...330	1	VZ17
		400...430	1	VZ30
	V3 and V4	300...320	1	VZ18
		400...420	1	VZ31
V5 and V6	330...350	1	VZ18	
	430...450	1	VZ31	
Door interlock plates	VN 12, VN 20 V02...V2	-	5	KZ32
	V3...V6	-	5	KZ74

Description	For use on	Front plate dimensions	Sold in lots of	Unit reference
				mm
Plates for door mounting of handles with 4 screw fixing	VN 12, VN 20 V02...V2	45 x 45 or 60 x 60	5	KZ83
		V3...V6	60 x 60 or 90 x 90	5
Adapter plate for switch-disconnectors	V3 and V4	90 x 90	5	KZ106

<sup>(1)</sup> Can be used with V02 to V2 switches.

## Protection components

### Mini-VARIO and VARIO switch-disconnectors

#### Accessories

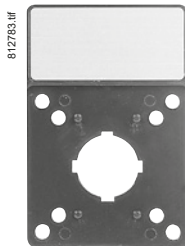

KZ 15

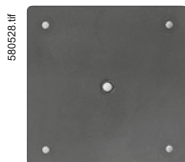

KZ 67



Z01

#### Accessories for operators

Description	For use on	Front plate dimensions mm	Sold in lots of	Unit reference
Legend holder with silver coloured blank legend plate	Front plate	45 x 45	5	KZ13
		60 x 60	5	KZ15
		90 x 90	5	KZ103
Legend holders without legend plate	Front plate	45 x 45	20	KZ14
		60 x 60	10	KZ16
		90 x 90	5	KZ101
Silver coloured blank legend plates for engraving by customer	KZ 14	–	20	KZ76
	KZ 16	–	10	KZ77
	KZ 101	–	5	KZ100
Seals	VN 12, VN 20	45 x 45	5	KZ65
	V02...V2	60 x 60	5	KZ66
	V3 and V4	60 x 60	5	KZ62
	V3...V6	90 x 90	5	KZ67
Tightening tool	For operators with Ø22.5 fixing	–	5	Z01





# Technical Data for Designers

## Contents

Characteristics..... B3/18 to B3/21

### Mini Vario:

- > Dimensions ..... B3/22 to B3/23
- > Schemes ..... B3/23

### Vario:

- > Dimensions ..... B3/24 to B3/25
- > Schemes ..... B3/25

## Characteristics

# Safety control and protection solutions

## Mini-VARIO and VARIO switch-disconnectors

Switch-disconnectors

Characteristics											
Environment											
Switch type (bare type)		VN 12 VZN 12	V02 VZ 02	VN 20 VZN 20	V01 VZ 01	V0 VZ 0	VVD 0 VVE 0	V1 VZ 1	VVD 1 VVE 1		
Conforming to standards		IEC 60947-3									
Product certifications		UL, CSA, GL									
Protective treatment		"TC"									
Degree of protection with protection shroud		IP 20 conforming to IEC 60529									
Ambient air temperature		° C	-20...+50								
Flame resistance		° C	960 conforming to IEC 60695-2-1								
Shock resistance 1/2 sine wave = 11ms conforming to IEC60068-2-27		gn	15	30	15	30					
Vibration resistance 10...150 Hz conforming to IEC 60068-2-6		gn	5	1							
Electrical characteristics, a.c. operation											
Switch type (bare type)		VN 12 VZN 12	V02 VZ 02	VN 20 VZN 20	V01 VZ 01	V0 VZ 0	VVD 0 VVE 0	V1 VZ 1	VVD 1 VVE 1		
Rated operational voltage (Ue)		V	690								
Rated impulse withstand voltage (Uimp)		kV	6	8	6	8					
Conventional thermal currents in free air (Ith) and rated uninterrupted (Iu)		A	12		20		25	32			
Conventional thermal current in enclosure (Ithe)		A	10		16		20	25			
Power dissipation per pole for the above operational currents		W	-				1.25	2			
		W	-				3.2	5			
Rated operational power and current	AC-21A/22A	230...690 V	A	12		20		25	32		
	AC-23A	230 V	A/kW	10.6/3		14/4		19.7/5.5			
		240 V	A/kW	10.6/3		14/4		19.9/5.5		18.9/5.5	
		400 V	A/kW	8.1/4		11/5.5		14.5/7.5		21.8/11	
		415 V	A/kW	8.1/4		11/5.5		14/7.5		21/11	
		500 V	A/kW	8.9/5.5		11.9/7.5		16.7/11			
Rated operational power	AC-3	230/240 V	kW	1.5		3		4			
		400/415 V	kW	3		4		5.5		7.5	
		500 V	kW	4		5.5		7.5			
		690 V	kW	4	5.5		7.5	11			
Intermittent duty class			30								
Characteristics in normal operating conditions	Rated making capacity AC-21A/22A/23A (I rms)		A/400 V	120		200		250	320		
	Rated breaking capacity AC-21A/22A/23A (I rms)		A/400 V	120		200		250		320	
Short-circuit characteristics	Permissible rms short time rating (Icw)		A/400V/1s	140	300	140	300	384			
	Rated making capacity under short-circuit conditions (Icm) I peak		kA/400 V	0.5	1	0.5	1				
	Rated conditional short-circuit current (I rms) with aM/gC fuses		kA/400 V	6	10	6	10				
		A	12		20		25	35			

V2 VZ 2	VVD 2 VVE 2	V3 VZ 3	VVD 3 VVE 3	V4 VZ 4	VVD 4 VVE 4	V5	V6	VZ7 VZ2 0	VZN 05 VZN 06
IEC 60947-3								IEC 60947-5	
UL, CSA, GL									
"TC"									
IP 20 conforming to IEC 60529									
-20...+50									
960 conforming to IEC 60695-2-1									
30								-	
1								-	

V2 VZ 2	VVD 2 VVE 2	V3 VZ 3	VVD 3 VVE 3	V4 VZ 4	VVD 4 VVE 4	V5	V6	VZ7 VZ2 0	VZN 05 VZN 06
690									
8								6	
40		63		80		125	175	12	6
32		50		63		100	140	10	4
2.4		4.2		5.1		7.5	11	-	
5.4		6.4		12.5		15	25	-	
40		63		80		125	160	le/AC-15	
25.8/7.5		50.3/15		61.2/18.5		71.9/22	96.6/30	6 A	
24.8/7.5		48.2/15		58.5/18.5		68/22	92.7/30	6 A	
29/15		41.5/22		57/30		68.5/37	83/45	4 A	
28/15		40/22		55/30		66/37	80/45	4 A	
28.5/18.5		44/30		54/37		64.5/45	79/55	2 A	
17.5/15		25/22		33/30		42/37	49/45	1 A	
5.5		11		15		22	30	-	
11		18.5		22		30	37	-	
15		22		30		37	45	-	
11		18.5				30	37	-	
30								-	
400		630		800		1250	1750	-	
320		500		640		1000	1400	-	
480		756		960		1500	2100	-	
1		2.1				2.8		-	
10								1	
50		63		80		125	200	16	1.6

Switch-disconnectors

# Characteristics

## Safety control and protection solutions

### Mini-VARIO and VARIO switch-disconnectors

#### Characteristics

##### Electrical characteristics, d.c. operation

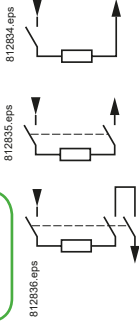
Switch type (bare type)				VN 12 VZN 12	V02 VZ 02	VN 20 VZN 20	V01 VZ 01	V0 VZ 0	VVD 0 VVE 0	V1 VZ 1	VVD 1 VVE 1
 <p>812834 eps 812835 eps 812836 eps</p>	Rated operational current DC-1 (L/R = 1ms)	24 V	1 contact	A	12	20		25		32	
			2 contacts	A	12	20		25		32	
			3 contacts	A	12	20		25		32	
		48 V	1 contact	A	12	20		25		32	
			2 contacts	A	12	20		25		32	
			3 contacts	A	12	20		25		32	
		60 V	1 contact	A	12	20		25		32	
			2 contacts	A	12	20		25		32	
			3 contacts	A	12	20		25		32	
	110 V	1 contact	A	1.5	2		9		10		
		2 contacts	A	8	10		12		16		
		3 contacts	A	12	20		25		32		
	220 V	1 contact	A	1.5	2		2.5		3		
		2 contacts	A	7	8		10		12		
		3 contacts	A	10	14		16		20		
	250 V	1 contact	A	0.6	0.7		0.8		1		
		2 contacts	A	3	4		6		8		
		3 contacts	A	8	10		12		16		
Rated operational current DC-2 to DC-5 (L/R = 1ms)	24 V	1 contact	A	12	20		25		32		
		2 contacts	A	12	20		25		32		
		3 contacts	A	12	20		25		32		
	48 V	1 contact	A	12	20		25		32		
		2 contacts	A	12	20		25		32		
		3 contacts	A	12	20		25		32		
	60 V	1 contact	A	10	14		16		20		
		2 contacts	A	12	20		25		32		
		3 contacts	A	12	20		25		32		
	110 V	1 contact	A	1.5	2		2.5		3		
		2 contacts	A	3	4		5		6		
		3 contacts	A	12	20		25		32		
	220 V	1 contact	A	0.4	0.5		0.5		0.8		
		2 contacts	A	1.4	1.5		1.5		2		
		3 contacts	A	1	2		3		4		
	250 V	1 contact	A	0.3	0.4		0.5		0.8		
		2 contacts	A	0.4	0.6		0.8		1		
		3 contacts	A	1.2	2.4		1.6		2		

##### Other characteristics

Switch type (bare type)				VN 12 VZN 12	V02 VZ 02	VN 20 VZN 20	V01 VZ 01	V0 VZ 0	VVD 0 VVE 0	V1 VZ 1	VVD 1 VVE 1
Mechanical durability (millions of operating cycles)				0.05	0.1	0.05	0.1				
Electrical durability in cat. AC-21 (millions of operating cycles)				0.05	0.1	0.05	0.1				
Electrical durability in cat. DC-1 to 5 (operating cycles)				30000							
Suitable for isolation				Yes							
Cabling	Flexible cable + cable end	mm <sup>2</sup>	4	6	4	6					
	Solid cable	mm <sup>2</sup>	4	10	4	10					
Tightening torque			N.m	0.7	2.1	0.7	2.1				

V2 VZ 2	VVD 2 VVE 2	V3 VZ 3	VVD 3 VVE 3	V4 VZ 4	VVD 4 VVE 4	V5	V6	VZ7 VZ2 0	VZN 05 VZN 06
40		63		80		125	175	8 (le/DC-1)	
40		63		80		125	175	–	
40		63		80		125	175	–	
40		63		80		125	175	8 (le/DC-1)	
40		63		80		125	175	–	
40		63		80		125	175	–	
35		40		50		60	70	4 (le/DC-1)	
40		63		80		125	175	–	
40		63		80		125	175	–	
12		20		25		30	37	2 (le/DC-1)	
20		63		80		125	175	–	
40		63		80		125	175	–	
4		6		8		12	15	1 (le/DC-1)	
14		25		30		40	50	–	
25		30		40		80	100	–	
2		4		5		3	10	0.8 (le/DC-1)	
12		20		25		30	40	–	
20		30		40		50	61	–	
40		63		80		125	175	–	
40		63		80		125	175	–	
40		63		80		125	175	–	
40		63		80		125	175	–	
40		63		80		125	175	–	
40		63		80		125	175	–	
40		63		80		125	175	–	
25		40		50		60	70	–	
40		63		80		125	175	–	
40		63		80		125	175	–	
5		6		8		10	12	–	
8		10		20		22	24	–	
40		50		63		70	80	–	
1		1.5		2		2.2	2.4	–	
3		4		6		7	8	–	
7		10		15		16	13	–	
1		1.2		1.5		1.6	1.8	–	
2		3		6		7	8	–	
6		8		10		12	14	–	
V2 VZ 2	VVD 2 VVE 2	V3 VZ 3	VVD 3 VVE 3	V4 VZ 4	VVD 4 VVE 4	V5	V6	VZ7 VZ2 0	VZN 05 VZN 06
0.1		0.03						0.1	0.05
0.1		0.03						0.1 (AC-15)	0.05
30000								30000 (DC-1)	
Yes								–	
6		16				70		2 x 0.75...1.5	
10		25				95		2 x 1...2.5	
2.1		4				22.6		0.7	

## Dimensions, mounting

### Safety control and protection solutions

Mini-VARIO switch-disconnectors, 12 and 20 A

#### Dimensions

##### Switch-disconnectors

Switch bodies VN 12, VN 20

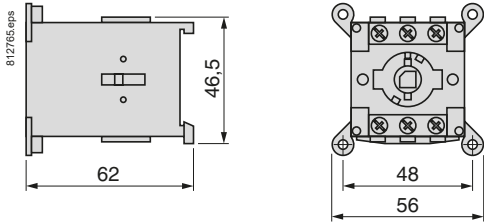

Add-on modules VZN 12, VZN 20

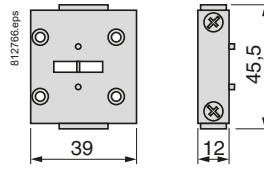

Add-on modules VZN 11, VZN 14 VZN 05 and VZN 06

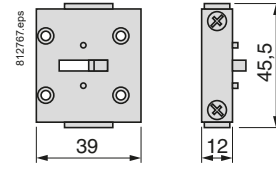

Switch-disconnectors

#### Mounting

##### Switch-disconnector mounted on enclosure door

VN 12, VN 20

Single hole fixing

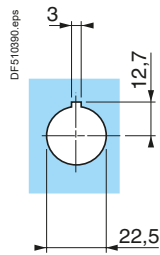
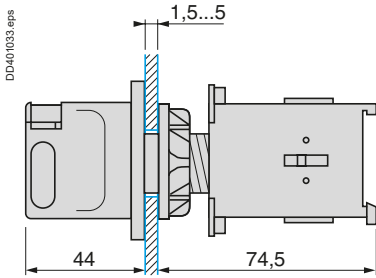

VN 12, VN 20  
4 screw fixing

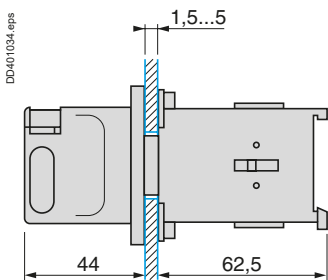

45 x 45 front plate

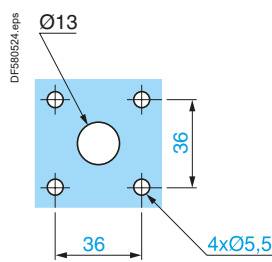

60 x 60 front plate

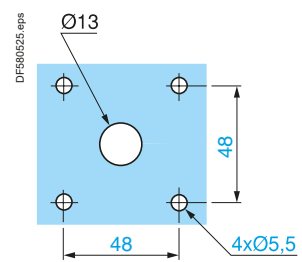

## Mounting (continued), schemes

### Safety control and protection solutions

Mini-VARIO switch-disconnectors, 12 and 20 A

#### Mounting (continued)

Switch-disconnector mounted at back of enclosure with shaft extension VZN 17 or VZN 30 (clip-on mounting on L rail)

VN 12, VN 20

Single hole fixing

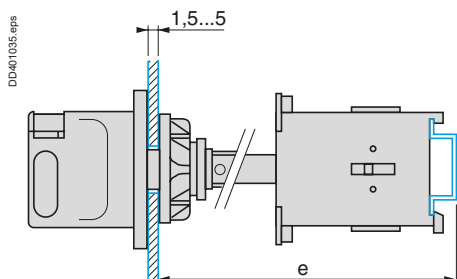

4 screw fixing

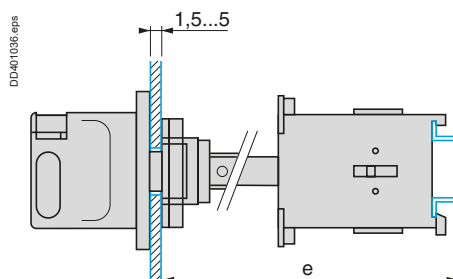

	Shaft extension	Distance (e) enclosure back/door mm
VN 12, VN 20	VZN 17	300...330
	VZN 30	400...430

#### Schemes

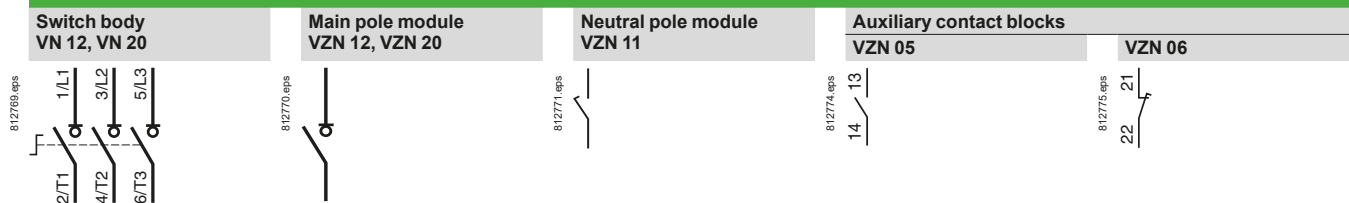

# Dimensions, mounting

## Safety control and protection solutions

### VARIO switch-disconnectors, 12 to 175 A

#### Dimensions

##### Switch-disconnectors

###### Switch bodies V0 $\bullet$ , V0 to V2

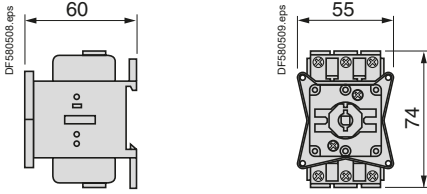

###### Switch bodies V3 to V6

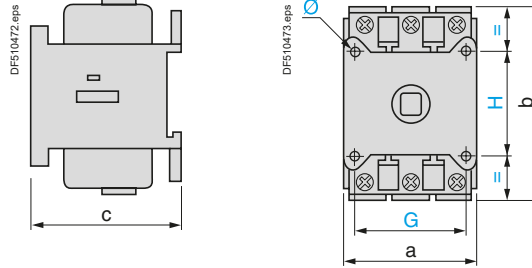

	a	b	c	G	H	Ø
V3, V4	60	83	65	48	48	5.5
V5, V6	90	125	90	68	68	5.5

###### Add-on modules VZ 02 to VZ 4 and VZ 11 to VZ 16

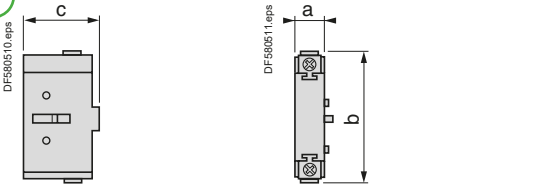

	a	b	c
VZ 02 and VZ 01, VZ 0 to VZ 2, VZ 11, VZ 14	16	74	35
VZ 3, VZ 4, VZ 12, VZ 15	20	83	46
VZ 13, VZ 16	30	125	63

###### Add-on modules VZ 7, VZ 20

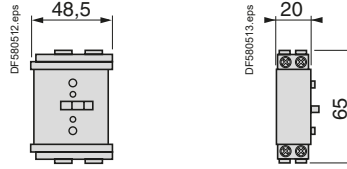

#### Mounting

##### Switch-disconnector mounted on enclosure door

###### Single hole fixing V0 $\bullet$ , V0 to V2

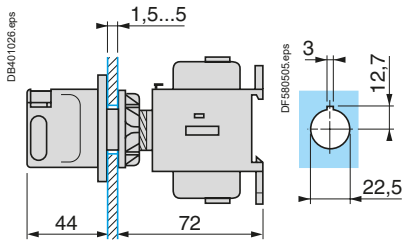

###### 4 screw fixing V0 $\bullet$ , V0 to V4

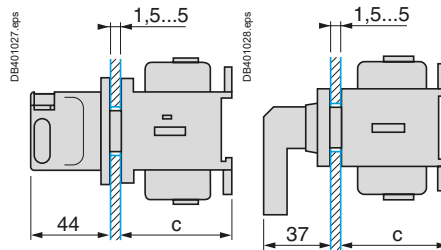

	c
V0 $\bullet$ , V0 to V2	60
V3, V4	65

###### 4 screw fixing 45 x 45 front plate V0 $\bullet$ , V0 to V2

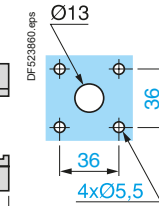

###### 4 screw fixing 60 x 60 front plate V0 $\bullet$ , V0 to V4

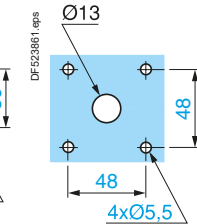

###### V5 and V6. 4 screw fixing

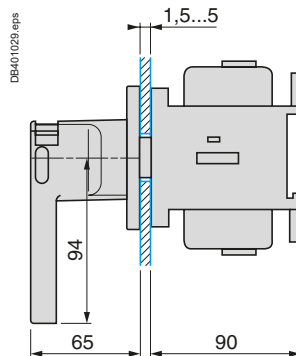

###### 90 x 90 front plate

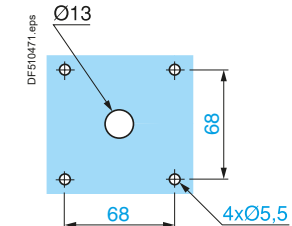



**Mounting (continued)**

**Switch-disconnector mounted at back of enclosure**

4 screw fixing  
V0●, V0 to V2 with shaft extension VZ 17 or VZ 30 (clip-on mounting on  rail possible for V0● to V2)

Single hole fixing  
V3 to V4 with shaft extension VZ 18 or VZ 31

V5 and V6 with shaft extension VZ 18 or VZ 31

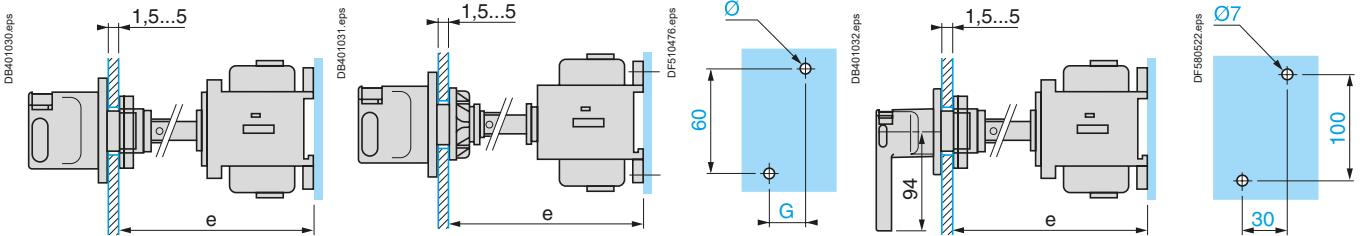

	Shaft extension	Distance (e) enc.back/door mm	Ø	G
V02 and V01 V0 to V2	VZ 17	300...330	2 x 4.2	15
	VZ 30	400...430	2 x 4.2	15
V3 and V4	VZ 18	300...320	2 x 5	20
	VZ 31	400...420	2 x 5	20

	Shaft extension	Distance (e) enc.back/door mm
V5 and V6	VZ 18	300...350
	VZ 31	430...450

**Switch-disconnectors for modular distribution boards**

**VV● 0 to VV● 2**

**VV● 3 to VV● 4**

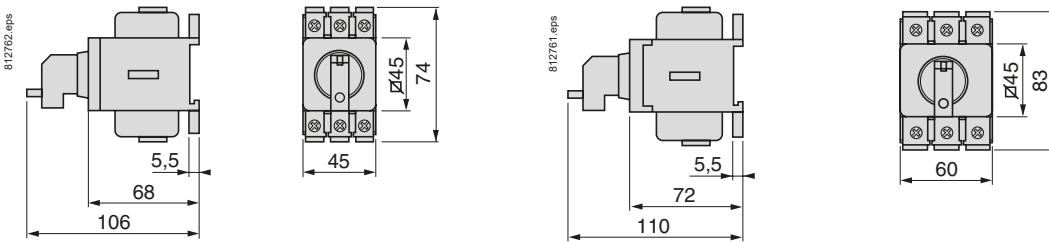

**Schemes**

**Switch body**

V02 and V01  
V0 to V6

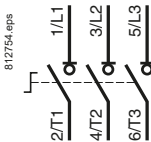

**Main pole module**

VZ 02 and VZ 01  
VZ 0 to VZ 4

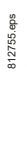

**Neutral pole module**

VZ 11 to VZ 13



**Auxiliary contact blocks**

VZ 7



VZ 20





## X-ON Electronics

Largest Supplier of Electrical and Electronic Components

*Click to view similar products for [Keylock Switches](#) category:*

*Click to view products by [Schneider](#) manufacturer:*

Other Similar products are found below :

[89496-09](#) [89638-00](#) [58J9A90-01C02N](#) [719-0022-020](#) [719-0122-000](#) [719-0201-000](#) [719-0202-000](#) [719-0702-000](#) [84800-04](#) [88521-00](#)  
[GKNC33L](#) [GKNC3L](#) [PVA2OAH5](#) [14-136.025K](#) [14-235.022K](#) [AS6H-2K2A](#) [AS6M-2K1B](#) [1571487-1](#) [HW4K-2BF20](#) [JD7510H](#)  
[K6SLYE1.55NL327SD](#) [KH3C-20C](#) [89638-05](#) [A028301](#) [A165K-J2AL-2](#) [A165K-J2M-2](#) [A165K-J3AMR](#) [A165K-J3M](#) [205389 \(PAYGUARD](#)  
[BUTTON PAD\)](#) [2SWK131AL102](#) [30PA39-AML](#) [LW6MJ-2C64WWB](#) [AS6M-2K1A](#) [51-401.036D](#) [51-401.036K](#) [51-414.036D](#) [HW1K-](#)  
[3HF20](#) [4370039](#) [Y1112-2027CLFT](#) [4B01H322NCFQ](#) [51-155.025D](#) [51-195.025D](#) [51-378.AD](#) [51-404.036D](#) [51-405.036D](#) [51-415.036D](#) [1-](#)  
[1437597-8](#) [86945-05](#) [88169-05](#) [719-0204-000](#)