

# Harmony<sup>®</sup> XAC pendant control stations

Catalog

June 2013



# How to find the “Automation and Control” products

## > Catalogues

Complete product ranges



## > Essential guides

Selection of the top selling products

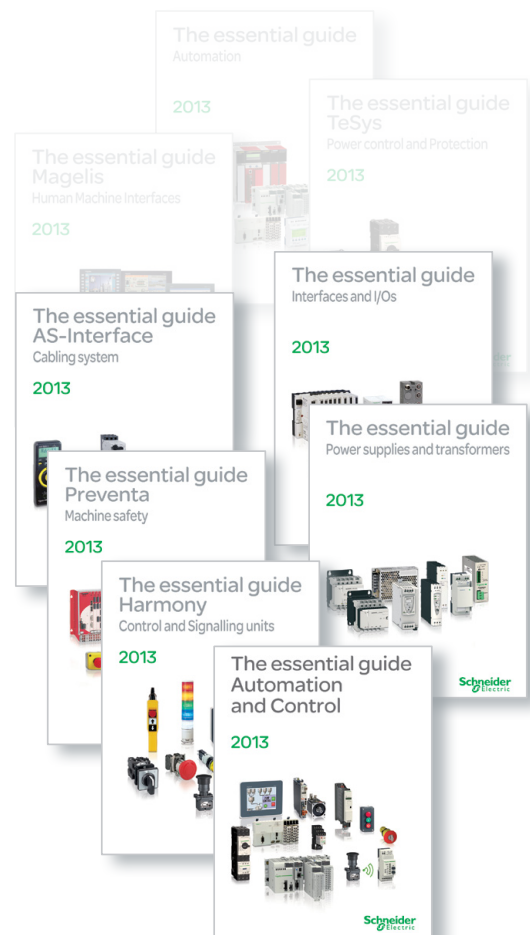

# General contents

Selection guide .....	1
Pendant control stations with intuitive operation .....	2
Pendant control stations .....	3
How to find products, index .....	4



Selection guide for pendant control stations



*Selection guide* ..... 1/2



1

## Applications

Motor control

-  Single-speed
-  2-speed
-  Emergency stop

## Control circuits

Simple hoisting: 1 movement

Handling-hoisting: 2 movements

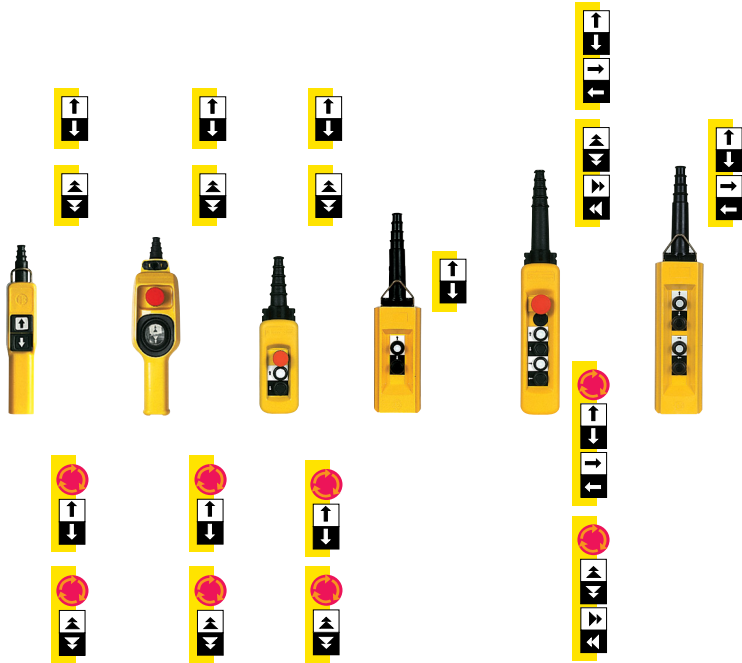

<b>Number of operators</b>	
<b>Enclosure material</b>	
<b>Shock resistance</b>	Conforming to standard IEC 60068-2-27
<b>Conformity to standards</b>	
<b>Protective treatment</b>	
<b>Degree of protection</b>	Conforming to standard IEC 60529 Conforming to standard EN 50102
<b>Cable entries</b>	
<b>Pendant station type reference</b>	

2	1 (2-directional)	2	2	4	4
Polypropylene			Polyester	Polypropylene	Polyester
100 gn	70 gn	100 gn			
EN/IEC 60947-5-1, EN/IEC 60204-32, UL 508, CSA 22-2 N° 14 and EN/IEC 60947-5-5, EN/ISO 13850 (1)			EN/IEC 60947-5-1 CSA 22-2 N° 14	EN/IEC 60947-5-1, EN/IEC 60204-32, UL 508, CSA 22-2 N° 14 and EN/IEC 60947-5-5, EN/ISO 13850 (1)	EN/IEC 60947-5-1 CSA 22-2 N° 14
Standard version, “TH”					
IP 65					
IK 08					
Rubber sleeve with stepped entry diameter for cable Ø 7 to 15 mm	Rubber sleeve with stepped entry diameter for cable Ø 7 to 18 mm	Rubber sleeve with stepped entry diameter for cable Ø 8 to 26 mm	Rubber sleeve with stepped entry diameter for cable Ø 7 to 13 mm, Ø 10 to 22 mm, Ø 22 to 35 mm	Rubber sleeve with stepped entry diameter for cable Ø 8 to 26 mm	Rubber sleeve with stepped entry diameter for cable Ø 7 to 13 mm, Ø 10 to 22 mm, Ø 22 to 35 mm
<b>XACA</b>	<b>XACD</b>	<b>XACA</b>	<b>XACB</b>	<b>XACA</b>	<b>XACB</b>

(1) For versions with trigger action Emergency stop.



More technical information on [www.schneider-electric.com](http://www.schneider-electric.com)

1

Applications	Control circuits		
Number of cut-outs	1 or 2	2, 3, 4, 5, 6, 8 or 12	2, 3, 4, 6, 8 or 12 in 1 row or 2 rows of 6



<b>Enclosure material</b>	Polypropylene		Polyester
<b>Shock resistance</b>	Conforming to standard IEC 60068-2-27		
<b>Conformity to standards</b>	EN/IEC 60947-5-1, EN/IEC 60204-32, UL 508, CSA 22-2 N° 14, EN/IEC 60947-3 and EN/IEC 60947-5-5, EN/ISO 13850 (1)		
<b>Protective treatment</b>	Standard version, "TH"		
<b>Degree of protection</b>	Conforming to standard IEC 60529		IP 65
	Conforming to standard EN 50102		IK 08
<b>Equipment</b>	<ul style="list-style-type: none"> <li>■ Emergency stop (front mounted)</li> <li>■ Contact blocks for 1 or 2 speeds</li> </ul>	<ul style="list-style-type: none"> <li>■ Pushbuttons</li> <li>■ Selector/key switches</li> <li>■ Pilot lights</li> <li>■ Emergency stop (front or base mounted)</li> <li>■ Wobblesticks</li> <li>■ Contact blocks for 1 or 2 speeds</li> </ul>	<ul style="list-style-type: none"> <li>■ Pushbuttons</li> <li>■ Selector/key switches</li> <li>■ Pilot lights</li> <li>■ Emergency stop (front or base mounted)</li> <li>■ Wobblesticks</li> <li>■ Contact blocks for 1 or 2 speeds</li> </ul>
<b>Cable entries</b>	Rubber sleeve with stepped entry diameter for cable Ø 7 to 18 mm	Rubber sleeve with stepped entry diameter for cable Ø 8 to 26 mm	Rubber sleeve with stepped entry diameter for cable Ø 10 to 22 mm
<b>Pendant station type reference</b>	<b>XACD</b>	<b>XACA</b>	<b>XACB</b>

(1) For versions with trigger action Emergency stop.







---

## Pendant control stations with intuitive operations

- **Double insulated, for control circuits**

- Complete stations “ready for use”, “Pistol grip”, type XACA..... 2/2
- Complete stations “ready for use”, type XACD ..... 2/4

- **Double insulated, for power circuits (direct switching)**

- Complete stations “ready for use”, type XACD ..... 2/5

- **Double insulated, for control or power circuits**

- Empty enclosures, type XACD..... 2/6
- Separate components and spare parts ..... 2/6
- Variable composition stations, factory assembled ..... 2/8



# Pendant control stations









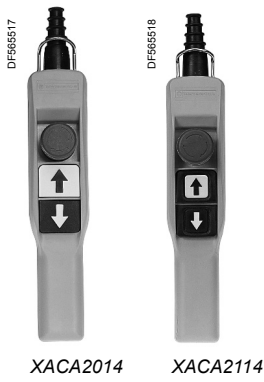



Double insulated with intuitive operation, type XACA “Pistol grip”

For control circuits

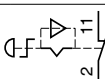
Complete stations “ready for use”

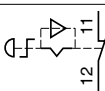
2

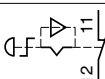

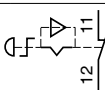
For control of single-speed hoist motors								
Functions	Number of operators	Type of operators	Contact block(s) and scheme		Reference	Weight kg		
			Per direction	For Emergency stop				
 2 mechanically interlocked	2	Standard	1 N/O ZB2BE101		–	<b>XACA201</b>	0.270	
			1 N/C + 1 N/O ZB2BE102 + ZB2BE101		–	<b>XACA205</b>	0.300	
		Booted	1 N/O ZB2BE101		–	<b>XACA211</b>	0.290	
			1 N/C + 1 N/O ZB2BE102 + ZB2BE101		–	<b>XACA215</b>	0.320	
2 mechanically interlocked + 1 trigger action latching Emergency stop Ø 30 mm operator ZB5AS834 (1)	2	Standard	1 N/O ZB2BE101		1 N/C ZB2BE102		<b>XACA2014</b>	0.310
			1 N/C + 1 N/O ZB2BE102 + ZB2BE101		1 N/C ZB2BE102		<b>XACA2054</b>	0.340
		Booted	1 N/O ZB2BE101		1 N/C ZB2BE102		<b>XACA2114</b>	0.310
			1 N/C + 1 N/O ZB2BE102 + ZB2BE101		1 N/C ZB2BE102		<b>XACA2154</b>	0.340

(1) Harmony XB5, trigger action mechanically latching Emergency stop pushbuttons conform to standards EN/IEC 60204-32, EN/ISO 13850, Machinery directive 98/37/EC and standard EN/IEC 60947-5-5.

# Pendant control stations

Double insulated with intuitive operation, type XACA "Pistol grip"

For control circuits

Complete stations "ready for use"

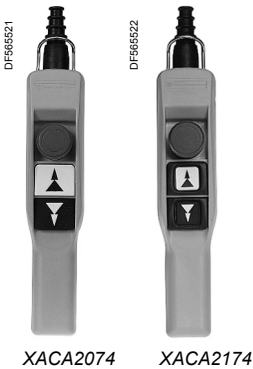
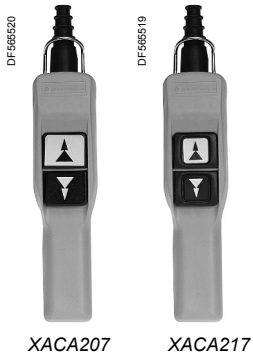

## For control of 2-speed hoist motors

Functions	Number of operators	Type of operators	Contact block(s) and scheme	Reference	Weight kg		
 2 mechanically interlocked	Standard	2 step 1 N/O + 1 N/O staggered ZB2BE101 + ZB2BE201	Per direction	For Emergency stop	-	XACA207	0.320
			Booted	2 step 1 N/O + 1 N/O staggered ZB2BE101 + ZB2BE201	-	XACA217	0.320
2 mechanically interlocked + 1 trigger action latching Emergency stop Ø 30 mm operator ZB5AS834 (1)	Standard	2 step 1 N/O + 1 N/O staggered ZB2BE101 + ZB2BE201	Per direction	1 N/C ZB2BE102	-	XACA2074	0.360
			Booted	2 step 1 N/O + 1 N/O staggered ZB2BE101 + ZB2BE201	1 N/C ZB2BE102	XACA2174	0.360

## Separate components and spare parts

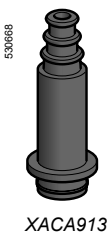
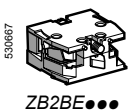
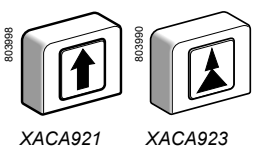

Description	For use with	Marking/Function	Scheme	Reference	Weight kg
<b>Booted pushbutton operators</b> with fixing screws	XACA211● XACA215● (single-speed)	↑	-	XACA921	0.010
		↓	-	XACA922	0.010
	XACA217● (2-speed)	▲	-	XACA923	0.010
		▼	-	XACA924	0.010
<b>Contact blocks</b> spring return, slow break	XACA all models	N/O		ZB2BE101	0.015
		N/C		ZB2BE102	0.015
		N/O staggered		ZB2BE201	0.015
<b>Protective cable sleeve</b> + suspension ring + cable clamp	Cable Ø 7 to Ø 13 mm	-	-	XACA913	0.070

(1) Harmony XB5, trigger action mechanically latching Emergency stop pushbuttons conform to standards EN/IEC 60204-32, EN/ISO 13850, Machinery directive 98/37/EC and standard EN/IEC 60947-5-5.

# Pendant control stations

Double insulated with intuitive operation,  
type XACD

For control circuits

Complete stations “ready for use”

2

DF565503



XACD21A0101

DF565501



XACD24A0105

DF565504









XACD21A1231

DF565502

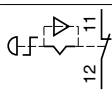

XACD24A1241

## For control of single-speed hoist motors

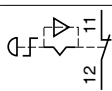
Functions	Number of operators	Contact block(s) and scheme	Reference	Weight kg
 Reversing, mechanically interlocked	1	1 N/O ZB2BE101	-	XACD21A0101 0.340
	2-directional operator		-	
		1 N/C + 1 N/O ZB2BE102 + ZB2BE101	-	XACD21A0105 0.365
			-	
	1	1 N/O ZB2BE101	1 N/C ZB2BE102	XACD24A0101 0.395
	2-directional operator + 1 trigger action Emer. stop Ø 30 mm ZA2BS834 operator (2)			
		1 N/C + 1 N/O ZB2BE102 + ZB2BE101	1 N/C ZB2BE102	XACD24A0105 0.425
				

## For control of 2-speed hoist motors

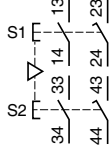
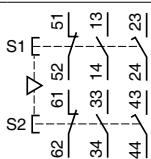
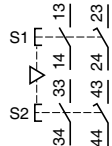
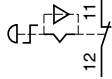
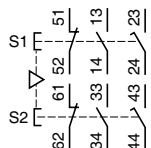
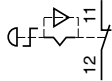
Functions	Number of operators	Contact block(s) and scheme	Reference	Weight kg
 Reversing, mechanically interlocked	1	1 N/O + N/O staggered XEDS1231 (1)	-	XACD21A1231 0.365
	2-directional operator		-	
		1 N/C + N/O + N/O staggered XEDS1241 (1)	-	XACD21A1241 0.405
			-	
	1	1 N/O + N/O staggered XEDS1231 (1)	1 N/C ZB2BE102	XACD24A1231 0.420
	2-directional operator + 1 trigger action latching Emergency stop Ø 30 mm ZA2BS834 operator (2)			
		1 N/C + N/O + N/O staggered XEDS1241 (1)	1 N/C ZB2BE102	XACD24A1241 0.420
				

(1) Reference of double contact block for reversing operation.

(2) Trigger action mechanically latching Emergency stop pushbuttons conform to standards EN/IEC 60204-32, EN/ISO 13850, Machinery directive 98/37/EC and standard EN/IEC 60947-5-5.

# Pendant control stations

Double insulated with intuitive operation, type XACD

For power circuits (direct switching)

Complete stations “ready for use”

## For control of single-speed hoist motors

Functions	Number of operators	Contact blocks		Maximum operational power/400 V	Reference	Weight kg
		Per direction	For Emergency stop			
 Reversing, mechanically interlocked	1 2-directional operator	2-pole XEDS2111 (1)	–	1.1 kW	XACD21P2111	0.355
		2-pole XEDS3111 (1)	–	2.2 kW	XACD21P3111	0.355
		2-pole + 1 N/O (brake) XEDS2121 (1)	–	1.1 kW	XACD21P2121	0.355
		2-pole + 1 N/O (brake) XEDS3121 (1)	–	2.2 kW	XACD21P3121	0.355
	1 2-directional operator + 1 trigger action latching Emergency stop Ø 30 mm operator ZA2BS834 (2)	2-pole XEDS3111 (1)	1 N/C + N/C + N/C XENT1991	2.2 kW	XACD24P3111 (2)	0.410
		2-pole + 1 N/O (brake) XEDS2121 (1)	1 N/C + N/C + N/C XENT1991	1.1 kW	XACD24P2121 (2)	0.410
		2-pole + 1 N/O (brake) XEDS3121 (1)	1 N/C + N/C + N/C XENT1991	2.2 kW	XACD24P3121 (2)	0.410

DF56500



XACD21P2111

DF56501



XACD24P2121

DF56504



XACD21P2231

DF56502



XACD24P3241

## For control of 2-speed hoist motors

Functions	Number of operators	Contact blocks		Maximum operational power/400 V	Reference	Weight kg
		Per direction	For Emergency stop			
 Reversing, mechanically interlocked	1 2-directional operator	2-pole XEDS2231 (1)	–	1.1 kW	XACD21P2231	0.355
		2-pole XEDS3231 (1)	–	2.2 kW	XACD21P3231	0.355
		2-pole + 1 N/O (brake) XEDS2241 (1)	–	1.1 kW	XACD21P2241	0.355
		2-pole + 1 N/O (brake) XEDS3241 (1)	–	2.2 kW	XACD21P3241	0.355
	1 2-directional operator + 1 trigger action latching Emergency stop Ø 30 mm operator ZA2BS834 (2)	2-pole XEDS2231 (1)	1 N/C + N/C + N/C XENT1991	1.1 kW	XACD24P2231 (2)	0.420
		2-pole XEDS3231 (1)	1 N/C + N/C + N/C XENT1991	2.2 kW	XACD24P3231 (2)	0.420
		2-pole + 1 N/O (brake) XEDS3241 (1)	1 N/C + N/C + N/C XENT1991	2.2 kW	XACD24P3241 (2)	0.420

(1) Reference of double contact block for reversing operation.

(2) Trigger action mechanically latching Emergency stop pushbuttons conform to standards EN/IEC 60204-32, EN/ISO 13850, Machinery directive 98/37/EC and standard EN/IEC 60947-5-5.

# Pendant control stations

Double insulated with intuitive operation, type XACD

For control or power circuits

Empty enclosures, separate components and spare parts

2



XACD021



XACD022



ZB2BE10



XEDS1231



XEDS2121

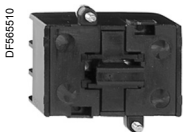

XENT1991

## Empty enclosures

Description	Enclosure cut-outs	Reference	Weight kg
<b>Empty enclosure</b> comprising: - the enclosure, - protective cable sleeve for Ø 7 to 18 mm cable, - internal cable clamp, - cable tie (for tightening sleeve onto cable), - the directional operator, - legends.	For directional operator	XACD021	0.345
	For directional operator + operating head (Ø 22.5 mm cut-out)	XACD022	0.345

## Variable composition stations, factory assembled

Use the order form on page 2/9 to define the required configuration.

**Equipment:** contact blocks and operating heads

See separate components, page 2/7

## Contact blocks

Description	Application	Function (1)	Scheme (1)	Max. power/ 400 V	Reference	Weight kg
<b>For control circuits</b>						
<b>Single block</b> spring return, slow break	Single-speed	N/O		-	ZB2BE101	0.015
		N/C		-	ZB2BE102	0.015
<b>Double block</b> spring return, snap action	2-speed	N/O + N/O staggered		-	XEDS1231	0.015
		N/C + N/O + N/O staggered		-	XEDS1241	0.015
<b>For power circuits</b>						
<b>Double block</b> spring return, snap action	Single-speed	2-pole		1.1 kW	XEDS2111	0.080
				2.2 kW	XEDS3111	0.090
	2-speed	2-pole		1.1 kW	XEDS2231	0.110
				2.2 kW	XEDS3231	0.110
		2-pole + 1 N/O (brake)		1.1 kW	XEDS2241	0.120
				2.2 kW	XEDS3241	0.120

## For Emergency stop operating head (Ø 22.5 mm cut-out)

<b>Single block</b> spring return, slow break	N/C		-	ZB2BE102	0.015
	N/C + N/C + N/C		-	XENT1991	0.040

(1) Function or scheme per direction for double contact blocks.

# Pendant control stations

Double insulated with intuitive operation,  
type XACD

For control or power circuits

Separate components and spare parts

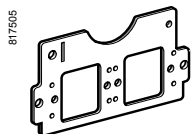

XACD913

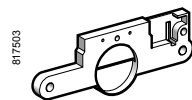

XACD911

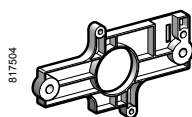

XACD912



ZA2BS834



ZA2BS934



ZA2BD2

ZA2BG2

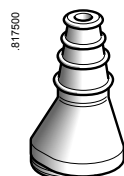

XACD901



XACD902

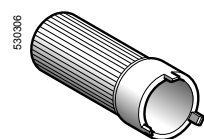

ZA2BZ905

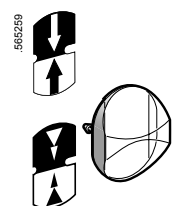

XACD905

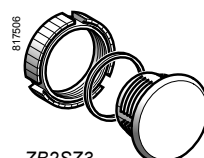

ZB2SZ3

## Contact block support plates

For use with	Reference	Weight kg
<b>2 movement contact blocks ZB2BE10</b> (control circuit stations)	<b>XACD913</b>	0.010
<b>1 contact block ZB2BE102</b> for operating head	<b>XACD911</b>	0.005
<b>1 contact block XENT1991</b> for operating head	<b>XACD912</b>	0.010

## Operating heads for Ø 22.5 mm cut-out

Description	Colour	Reference	Weight kg
<b>1 trigger action latching Emergency stop Ø 30 mm operator (1)</b> Turn to release	Red	<b>ZA2BS834</b>	0.040
<b>1 trigger action latching Emergency stop Ø 30 mm operator</b> Key release, n° 455 (2) Key withdrawal in rest (unactuated) position	Red	<b>ZA2BS934</b>	0.060
<b>Selector switch, standard handle</b> 2 position, stay put	Black	<b>ZA2BD2</b>	0.018
<b>Key switch (key n° 455) (2)</b> 2 position, stay put Key withdrawal in left-hand position	–	<b>ZA2BG2</b>	0.020
<b>Key switch (key n° 455) (2)</b> 2 position, spring return from right to left Key withdrawal in left-hand position	–	<b>ZA2BG6</b>	0.020
<b>Key switch (key n° 455) (2)</b> 2 position, stay put Key withdrawal in left and right-hand position	–	<b>ZA2BG4</b>	0.020
<b>Key switch (key n° 455) (2) (3)</b> 3 position, stay put Key withdrawal in left and right-hand position	–	<b>ZA2BG5</b>	0.020
<b>Key switch (key n° 455) (2) (3)</b> 3 position, stay put Key withdrawal in centre position	–	<b>ZA2BG3</b>	0.020

## Complementary accessories

<b>Protective cable sleeve</b> for cable Ø 7 to 18 mm	–	<b>XACD901</b>	0.030
<b>Diaphragm for directional operator</b> , polychloroprene	Black	<b>XACD902</b>	0.015
<b>Tightening tool</b> for fixing nut	–	<b>ZA2BZ905</b>	0.060
<b>Directional operator</b> with set of legends (single-speed and 2-speed)	–	<b>XACD905</b>	0.005
<b>Blanking plug</b> for Ø 22.5 mm cut-out, with seal and fixing nut	Black	<b>ZB2SZ3</b>	0.010

## Printed labels, pendant station characteristics

Description	Pendant station circuit type	Sold in lots of	Unit reference	Weight kg
<b>Self-adhesive labels</b> product identification	Control	<b>50</b>	<b>XACD950</b>	0.001
	Power, 1.1 kW	<b>50</b>	<b>XACD951</b>	0.001
	Power, 2.2 kW	<b>50</b>	<b>XACD952</b>	0.001

(1) Trigger action mechanically latching Emergency stop pushbuttons conform to standards EN/IEC 60204-32, EN/ISO 13850, Machinery directive 98/37/EC and standard EN/IEC 60947-5-5.

(2) Other key numbers available on request, please consult our Customer Care Centre.

(3) Only suitable for front mounting.

# Pendant control stations

Double insulated with intuitive operation,  
type XACD

For control or power circuits

Variable composition stations, factory assembled

2

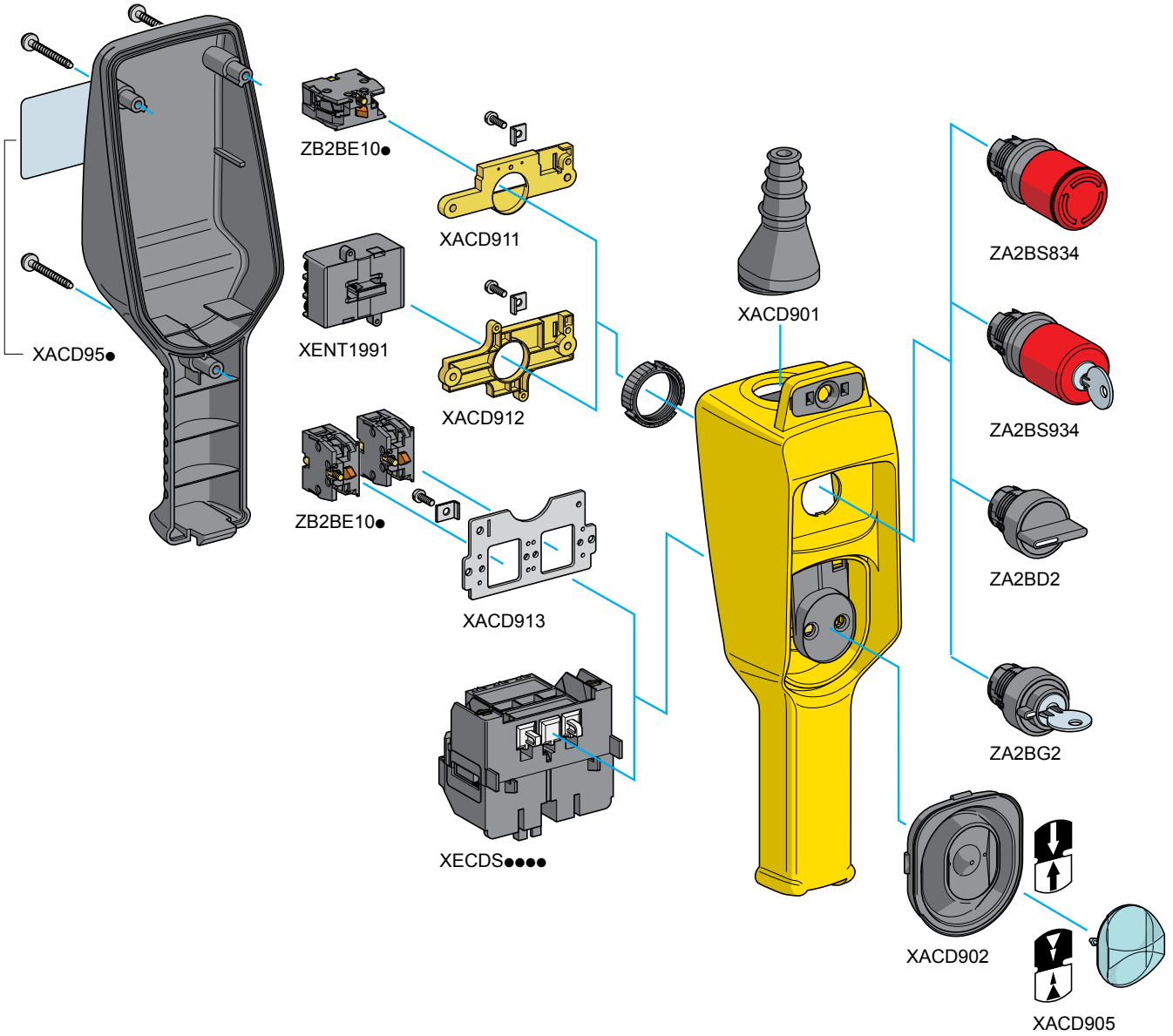



# Pendant control stations

Double insulated with intuitive operation, type XACD  
For control or power circuits  
Variable composition stations, factory assembled

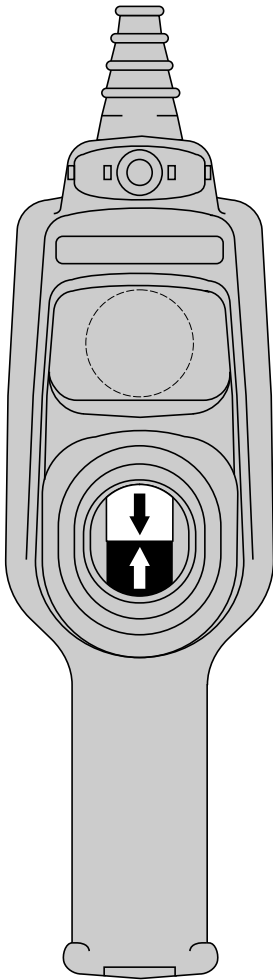

Customer			Schneider Electric Industries	
Company	Order N°	Delivery date	Sales office - Subsidiary Co.	Order N°

**Enter the order with XACD09 reference**

Unit reference of empty enclosure, see page 2/6	Number of identical stations	Enclosure price (1)
XAC <input type="text" value="D"/> <input type="text" value="0"/> <input type="text" value="2"/> <input type="text"/>		

- The reference of the empty enclosure above comprises:
- the enclosure,
  - internal cable clamp,
  - cable tie (for tightening sleeve onto cable),
  - the directional operator with set of legends, **XACD905**,
  - protective cable sleeve for Ø 7 to 18 mm cable, **XACD901**,
  - diaphragm for directional operator, **XACD902**.

Operating head see page 2/7		Contact blocks see page 2/6		Support plate see page 2/7		Total price
Reference	Unit price	Reference	Unit price	Reference	Unit price	

Contact blocks see page 2/6			Support plate (for ZB2BE●●● only) see page 2/7			Total price
Reference	Qty.	Unit price	Reference	Qty.	Unit price	

**Factory assembly:**  
Add an additional cost for assembly **XAC9VA**

**Total price of assembled pendant station**

(1) Obtain the empty enclosure price.



---

Pendant control stations

■ **Double insulated, type XACA, for control circuits**

- Complete stations “ready for use” ..... 3/2
- Empty enclosures ..... 3/5
- Separate components and spare parts ..... 3/6
- Variable composition stations, factory assembled ..... 3/12

■ **Double insulated, type XACB or metal, type XACM**

- Complete stations “ready for use”, type XACB, for control circuits..... 3/14
- Complete stations “ready for use”, type XACB, for power circuits..... 3/15
- Empty enclosures, type XACB, for control or power circuits..... 3/17
- Separate components and spare parts ..... 3/18
- Variable composition stations, factory assembled ..... 3/30

■ **Double insulated, type XACF, for control circuits**

- Empty enclosures ..... 3/13
- Variable composition stations, factory assembled ..... 3/33

















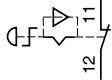

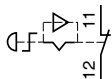

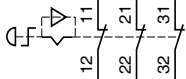

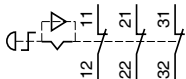
# Pendant control stations

Double insulated, type XACA

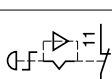
For control circuits

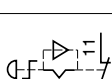
Complete stations "ready for use"

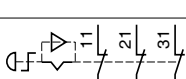
## For control of single-speed motors

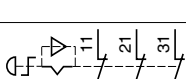
Functions	Number of operators	Contact block(s) and scheme		Reference	Weight kg	
		Per direction	For Emergency stop			
	2 mechanically interlocked	1 N/O ZB2BE101		-	<b>XACA271</b> 0.475	
		1 N/C + 1 N/O ZB2BE102 + ZB2BE101		-	<b>XACA281</b> 0.500	
	2 mechanically interlocked + 1 trigger action latching Emergency stop Ø 30 mm operator ZA2BS834 (1)	1 N/O ZB2BE101		1 N/C ZB2BE102		<b>XACA2714 (1)</b> 0.575
		1 N/C + 1 N/O ZB2BE102 + ZB2BE101		1 N/C ZB2BE102		<b>XACA2814 (1)</b> 0.600
		1 N/O ZB2BE101		1 N/C + N/C + N/C XENT1192		<b>XACA27141 (1)</b> 0.615
		1 N/C + 1 N/O ZB2BE102 + ZB2BE101		1 N/C + N/C + N/C XENT1192		<b>XACA28141 (1)</b> 0.635
	4 mechanically interlocked between pairs	1 N/O ZB2BE101		-	<b>XACA471</b> 0.625	
		1 N/C + 1 N/O ZB2BE102 + ZB2BE101		-	<b>XACA481</b> 0.675	
		1 N/O ZB2BE101		1 N/C ZB2BE102		<b>XACA4714 (1)</b> 0.800
		1 N/C + 1 N/O ZB2BE102 + ZB2BE101		1 N/C ZB2BE102		<b>XACA4814 (1)</b> 0.815
	4 mechanically interlocked between pairs + 1 trigger action latching Emergency stop Ø 40 mm operator ZA2BS844 (1)	1 N/O ZB2BE101		1 N/C + N/C + N/C XENT1192		<b>XACA47141 (1)</b> 0.835
		1 N/C + 1 N/O ZB2BE102 + ZB2BE101		1 N/C + N/C + N/C XENT1192		<b>XACA48141 (1)</b> 0.850

(1) Trigger action mechanically latching Emergency stop pushbuttons conform to standards EN/IEC 60204-32, EN/ISO 13850, Machinery directive 98/37/EC and standard EN/IEC 60947-5-5.

# Pendant control stations

Double insulated, type XACA

For control circuits

Complete stations "ready for use"



XACA671  
XACA681



XACA6714  
XACA6814



XACA67141  
XACA68141



XACA871  
XACA881

## For control of single-speed motors (continued)

Functions	Number of operators	Contact block(s) and scheme		Reference	Weight kg
		Per direction	For Emergency stop		
	6 mechanically interlocked between pairs	1 N/O ZB2BE101	-	XACA671	0.860
		1 N/C + 1 N/O ZB2BE102 + ZB2BE101	-		
	6 mechanically interlocked between pairs + 1 trigger action latching Emergency stop Ø 40 mm operator ZA2BS844 (1)	1 N/O ZB2BE101	1 N/C ZB2BE102	XACA6714 (1)	0.845
		1 N/C + 1 N/O ZB2BE102 + ZB2BE101	1 N/C ZB2BE102		
	6 mechanically interlocked between pairs + 1 trigger action latching Emergency stop Ø 40 mm operator ZA2BS844 (1)	1 N/O ZB2BE101	1 N/C + N/C + N/C XENT1192	XACA67141 (1)	0.880
		1 N/C + 1 N/O ZB2BE102 + ZB2BE101	1 N/C + N/C + N/C XENT1192		
	8 mechanically interlocked between pairs	1 N/O on 7 operators ZB2BE101 and 1 N/C on the 8 <sup>th</sup> operator ZB2BE102	-	XACA871	0.940
		1 N/C + 1 N/O ZB2BE102 + ZB2BE101	-		
	8 mechanically interlocked between pairs	1 N/O on 7 operators ZB2BE101 and 1 N/C on the 8 <sup>th</sup> operator ZB2BE102	-	XACA871	0.940
		1 N/C + 1 N/O ZB2BE102 + ZB2BE101	-		

(1) Trigger action mechanically latching Emergency stop pushbuttons conform to standards EN/IEC 60204-32, EN/ISO 13850, Machinery directive 98/37/EC and standard EN/IEC 60947-5-5.

# Pendant control stations

Double insulated, type XACA

For control circuits

Complete stations "ready for use"

## For control of 2-speed motors

Functions	Number of operators	Contact block(s) and scheme	Reference	Weight kg
		Per direction	For Emergency stop	
	2 mechanically interlocked between pairs	1 N/C + N/O + N/O staggered XENG1191	-	XACA291 0.525
	2 mechanically interlocked between pairs + 1 trigger action latching Emergency stop Ø 30 mm operator ZA2BS834 (1)	1 N/C + N/O + N/O staggered XENG1191	1 N/C ZB2BE102	XACA2914 (1) 0.570
		1 N/C + N/O + N/O staggered ZA2BS834 (1) XENG1191	1 N/C + N/C + N/C XENT1192	XACA29141 (1) 0.605
	4 mechanically interlocked between pairs	1 N/C + N/O + N/O staggered XENG1191	-	XACA491 0.625
	4 mechanically interlocked between pairs + 1 trigger action latching Emergency stop Ø 40 mm operator ZA2BS844 (1)	1 N/C + N/O + N/O staggered XENG1191	1 N/C ZB2BE102	XACA4914 (1) 0.675
		1 N/C + N/O + N/O staggered XENG1191	1 N/C + N/C + N/C XENT1192	XACA49141 (1) 0.700
(a)	4 mechanically interlocked between pairs	1 N/C + N/O + N/O staggered (a) XENG1191	-	XACA492 0.675
(b)		1 N/O (b) ZB2BE101		
	4 mechanically interlocked between pairs + 1 trigger action latching Emergency stop Ø 40 mm operator ZA2BS844 (1)	1 N/C + N/O + N/O staggered (a) XENG1191	1 N/C ZB2BE102	XACA4924 (1) 0.700
		1 N/O (b) ZB2BE101		
		1 N/C + N/O + N/O staggered (a) XENG1191	1 N/C + N/C + N/C XENT1192	XACA49241 (1) 0.735
		1 N/O (b) ZB2BE101		

(1) Trigger action mechanically latching Emergency stop pushbuttons conform to standards EN/IEC 60204-32, EN/ISO 13850, Machinery directive 98/37/EC and standard EN/IEC 60947-5-5.

# Pendant control stations

Double insulated, type XACA

For control circuits

Empty enclosures

530233



XACA02

530234



XACA03

530234



XACA12

## Empty enclosures

Description	Number of cut-outs	Reference	Weight kg
<b>Enclosure</b> comprising: - the enclosure, - internal mounting plate, - protective cable sleeve, - internal cable clamp, - suspension ring, - cable tie (for tightening sleeve onto cable).	2	<b>XACA02</b>	0.440
	3	<b>XACA03 (1)</b>	0.440
	4	<b>XACA04</b>	0.540
	5	<b>XACA05 (1)</b>	0.625
	6	<b>XACA06</b>	0.665
	8	<b>XACA08</b>	0.770
	12	<b>XACA12</b>	1.000

## Variable composition stations, factory assembled

Use the order form on page 3/13 to define the required configuration.

**Equipment:** contact blocks, operating heads (control and signalling), complementary accessories

See separate components, page 3/6

(1) Enclosures with 3 cut-outs XACA03 and 5 cut-outs XACA05 cannot be fitted with a mounting adaptor for base mounted units. The first cut-out can only be used for the Emergency stop function.



# Pendant control stations

Double insulated, type XACA

For control circuits

Separate components and spare parts

530238



ZB2BE101  
ZB2BE102

Contact blocks for front mounting					
Description	Application	Function	Scheme	Reference	Weight kg
Single block, spring return slow break	Single-speed	N/O		ZB2BE101	0.015
	N/C			ZB2BE102	0.015
	N/C + N/O + N/O simultaneous (1)			XENG1491	0.040
	2-speed	N/C + N/O + N/O staggered (1)		XENG1191	0.040
Double block, latching slow break (2)	Single-speed	N/O		XENG3781	0.060
		N/O			
		N/O		XENG3791	0.060
		N/C			

530237



XENG1191  
XENG1491

530236

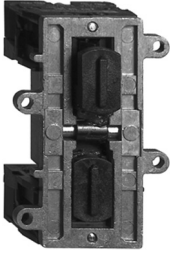

XENG3781  
XENG3791

530239



XENT1192

Isolating switch, slow break, for front mounting					
For mounting in enclosures	Application	Function	Scheme	Reference	Weight kg
XACA03 (frontal cut-out) XACA05, A06, A08 (frontal or base cut-out)	Emergency stop	N/C + N/C + N/C with positive opening operation		XENT1192	0.050

(1) Only for use with XACA9●●● operators.

(2) Not suitable for use with the following operating heads: ZA2BB, ZA2BD, ZA2BG and ZA2BS.



## Pendant control stations

Double insulated, type XACA

For control circuits

Separate components and spare parts

530240

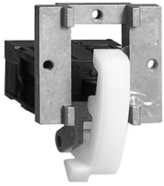

XACS10●

## Contact blocks for base mounting

Description	Function	Scheme	Reference	Weight kg
Spring return slow break (1)	N/O		XACS101	0.030
	N/C		XACS102	0.030
	N/O + N/O		XACS103	0.045
	N/C + N/C		XACS104	0.045
	N/C + N/O		XACS105	0.045

PF110461



ZB2BV006

## Pilot light bodies for front mounting

Description	Supply voltage	Scheme	Reference	Weight kg
Direct supply Bulb not included (2)	$\leq 400$ V		ZB2BV006	0.015
Direct supply, through resistor Incandescent BA 9s base fitting 130 V bulb included	230 V		ZB2BV007	0.020

PF110462



ZB2BV007

(1) Not suitable for use with 3-position operating heads ZA2BD and ZA2BG or for mounting in enclosures XACA039 and XACA03.

(2) Bulb type for use with direct supply units: BA 9s base fitting incandescent bulb  $U \leq 130$  V or neon bulb  $110 \text{ V} \leq U \leq 400$  V. Maximum power: 2.6 W, maximum  $\varnothing$ : 11 mm, maximum length: 28 mm. See page 3/9.

# Pendant control stations

Double insulated, type XACA

For control circuits

Separate components and spare parts

530243



XACA94●●

Operating heads for front mounting				
Description	Colour	Sold in lots of	Unit reference	Weight kg
Booted operators	White	10	XACA9411	0.010
	Black	10	XACA9412	0.010
	Green	10	XACA9413	0.010
	Red	10	XACA9414	0.010
	Yellow	10	XACA9415	0.010
	Blue	10	XACA9416	0.010
	Brown	10	XACA9419	0.010

3

530249



ZA2BS834

DF539493



ZA2BS944

530245



ZA2BD●

530246



ZA2BG●

DF565529



ZA2BB●

Operating heads for front or base mounting				
Description	Colour	Type	Reference	Weight kg
Trigger action latching Emergency stop (1) Turn to release	Red	Ø 30 mm	ZA2BS834	0.040
		Ø 40 mm	ZA2BS844	0.050
Trigger action latching Emergency stop (2) Key release (n° 455) Key withdrawal in rest (unactuated) position	Red	Ø 30 mm	ZA2BS934	0.060
		Ø 40 mm	ZA2BS944	0.065
Selector switches (3), standard handle (Not to be used with XENG●●●● contact blocks)	Black	2 position, stay put	ZA2BD2	0.018
		3 position, stay put (4)	ZA2BD3	0.018
Key switches (2) (key n° 455) Key withdrawal in left and right-hand position	-	2 position, stay put	ZA2BG4	0.042
		3 position, stay put (4)	ZA2BG5	0.042
Key switch (2) (key n° 455) Key withdrawal in left-hand position	-	2 position, stay put	ZA2BG2	0.042
Key switch (2) (key n° 455) Spring return from right to left Key withdrawal in left-hand position	-	2-position	ZA2BG6	0.042
Key switch (4) (2) (key n° 455) Key withdrawal in centre position	-	3 position, stay put	ZA2BG3	0.042
Wobblesticks (5) Operates in all directions for fast stop	Black	-	ZA2BB2	0.060
	Red	-	ZA2BB4	0.060

(1) Trigger action mechanically latching Emergency stop pushbuttons conform to standards EN/IEC 60204-32, EN/ISO 13850, Machinery directive 98/37/EC and standard EN/IEC 60947-5-5.

(2) Other key numbers available on request, please consult our Customer Care Centre.

(3) Selector switches available with other mechanical functions, please consult our Customer Care Centre.

(4) Only suitable for front mounting.

(5) Base mounting recommended.

# Pendant control stations

## Double insulated, type XACA

### For control circuits

### Separate components and spare parts

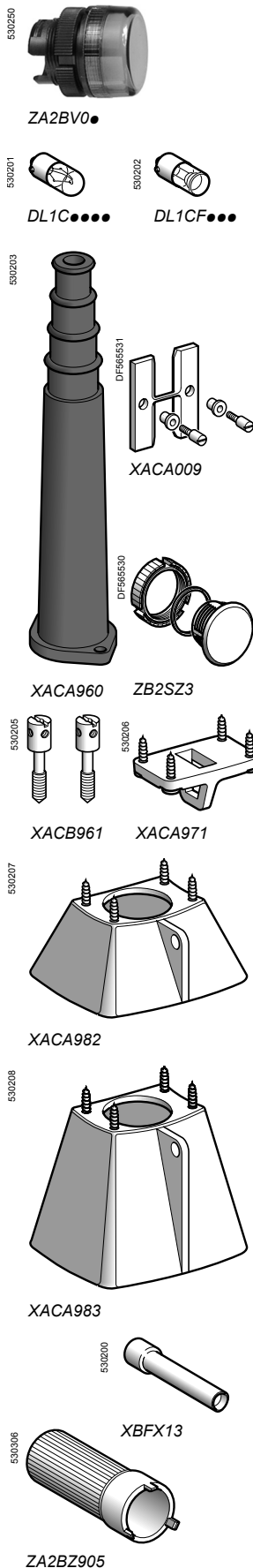

### Pilot light heads

Description	Colour	Reference	Weight kg
<b>For use with incandescent bulbs</b>			
Lens cap with bezel and fixing nut	White	ZA2BV01	0.015
	Green	ZA2BV03	0.015
	Red	ZA2BV04	0.015
	Yellow	ZA2BV05	0.015
	Blue	ZA2BV06	0.015
	Clear	ZA2BV07	0.015
	<b>For use with neon bulbs</b>		
Lens cap with bezel and fixing nut	Green	ZA2BV033	0.015
	Red	ZA2BV043	0.015
	Yellow	ZA2BV053	0.015
	Clear	ZA2BV073	0.015

### Bulbs

Description	Voltage	Sold in lots of	Unit reference	Weight kg
<b>Incandescent</b> BA 9s base fitting Maximum power: 2.6 W Maximum Ø: 11 mm Maximum length: 28 mm	6 V	10	DL1CB006	0.002
	12 V	10	DL1CE012	0.002
	24 V	10	DL1CE024	0.002
	48 V	10	DL1CE048	0.002
	130 V	10	DL1CE130	0.002
<b>Neon</b> BA 9s base fitting Maximum power: 2.6 W Maximum Ø: 11 mm Maximum length: 28 mm	110 V	10	DL1CF110	0.002
	230 V	10	DL1CF220	0.002
	400 V	10	DL1CF380	0.002

### Complementary accessories, tools

Description	Reference	Weight kg
<b>Protective cable sleeve</b>	For cable Ø 8 to 22 mm	XACA950
	For cable Ø 8 to 26 mm	XACA960
<b>Mechanical interlock for 2 operators</b>	With fixing screws	XACA009
<b>Blanking plug</b>	With seal and fixing nut	ZB2SZ3
<b>Tightening tool for fixing nut</b>	–	ZA2BZ905
<b>Adaptor for self-supporting cable type BBAP</b>	Mounted with protective sleeve for cable Ø 8 to 26 mm	XACB961
<b>Lower support ring</b>	–	XACA971
<b>Protective guards for base mounted units</b>	For selector switch (standard handle) or Emergency stop head pushbutton	XACA982
	For key switch or key release latching Emergency stop head pushbutton	XACA983
<b>Bulb extractor</b>	For BA 9s base fitting bulbs	XBFX13

# Pendant control stations

Double insulated, type XACA

For control circuits

Legends 30 x 40 mm with symbols conforming to NF E 52-124

534209

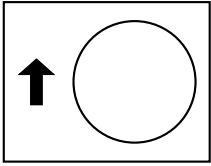

White background, black symbol

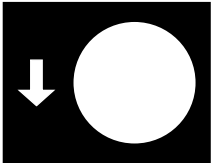

Black background, white symbol

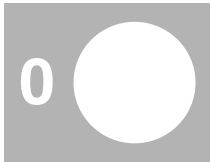

Red background, white symbol

3

Function Symbol	Reference	Weight kg	Function Symbol	Reference	Weight kg
	ZB2BY4901	0.001		ZB2BY2904	0.001
	ZB2BY4902	0.001		ZB2BY2905	0.001
	ZB2BY4903	0.001		ZB2BY2906	0.001
	ZB2BY4907	0.001		ZB2BY2910	0.001
	ZB2BY4908	0.001		ZB2BY2911	0.001
	ZB2BY4909	0.001		ZB2BY2912	0.001
	ZB2BY4913	0.001		ZB2BY2916	0.001
	ZB2BY4914	0.001		ZB2BY2917	0.001
	ZB2BY4915	0.001		ZB2BY2918	0.001
	ZB2BY4919	0.001		ZB2BY2922	0.001
	ZB2BY4920	0.001		ZB2BY2923	0.001
	ZB2BY4921	0.001		ZB2BY2924	0.001
	ZB2BY4933	0.001		ZB2BY4934	0.001
	ZB2BY4932	0.001		ZB2BY4935	0.001
	ZB2BY4930	0.001		ZB2BY2931	0.001

# Pendant control stations

## Double insulated, type XACA

### For control circuits

### Legends 30 x 40 mm

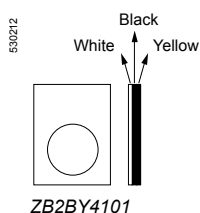
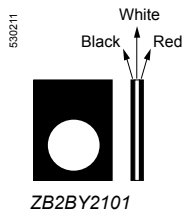

Text	Reference	Weight kg	Text	Reference	Weight kg
<ul style="list-style-type: none"> <li>■ Start functions: white characters on black background</li> <li>■ Stop functions: white characters on red background</li> </ul>					
<b>Blank</b>					
Black or red background	ZB2BY2101	0.001	White or yellow background	ZB2BY4101	0.001
<b>With English text</b>			<b>With French text</b>		
<b>For pushbuttons</b>			<b>For pushbuttons</b>		
Start	ZB2BY2303	0.001	Marche	ZB2BY2103	0.001
Stop	ZB2BY2304	0.001	Arrêt	ZB2BY2104	0.001
Forward	ZB2BY2305	0.001	Avant	ZB2BY2105	0.001
Reverse	ZB2BY2306	0.001	Arrière	ZB2BY2106	0.001
Up	ZB2BY2307	0.001	Montée	ZB2BY2107	0.001
Down	ZB2BY2308	0.001	Descente	ZB2BY2108	0.001
Right	ZB2BY2309	0.001	Droite	ZB2BY2109	0.001
Left	ZB2BY2310	0.001	Gauche	ZB2BY2110	0.001
On	ZB2BY2311	0.001	En service	ZB2BY2111	0.001
Off	ZB2BY2312	0.001	Hors service	ZB2BY2112	0.001
Power on	ZB2BY2326	0.001	Sous tension	ZB2BY2126	0.001
Slow	ZB2BY2327	0.001	Lent	ZB2BY2127	0.001
Fast	ZB2BY2328	0.001	Vite	ZB2BY2128	0.001
Klaxon	ZB2BY2125	0.001	Klaxon	ZB2BY2125	0.001
<b>For selector switches</b>			<b>For selector switches</b>		
-	-	0.001	Arrêt-Marche	ZB2BY2166	-
Off-On	ZB2BY2367	0.001	Hors-en	ZB2BY2167	0.001
<b>With special texts</b>					
<ul style="list-style-type: none"> <li>■ Specify text when ordering,</li> <li>■ 2 lines maximum, 11 characters per line.</li> </ul>					
White characters on black background	ZB2BY2002	0.001	Black characters on white background	ZB2BY4001	0.001
White characters on red background	ZB2BY2004	0.001	Black characters on yellow background	ZB2BY4005	0.001
<b>Other versions</b>	Legends with texts in other languages. Please consult our Customer Care Centre.				

# Pendant control stations

Double insulated, type XACA

For control circuits

Variable composition stations, factory assembled

3

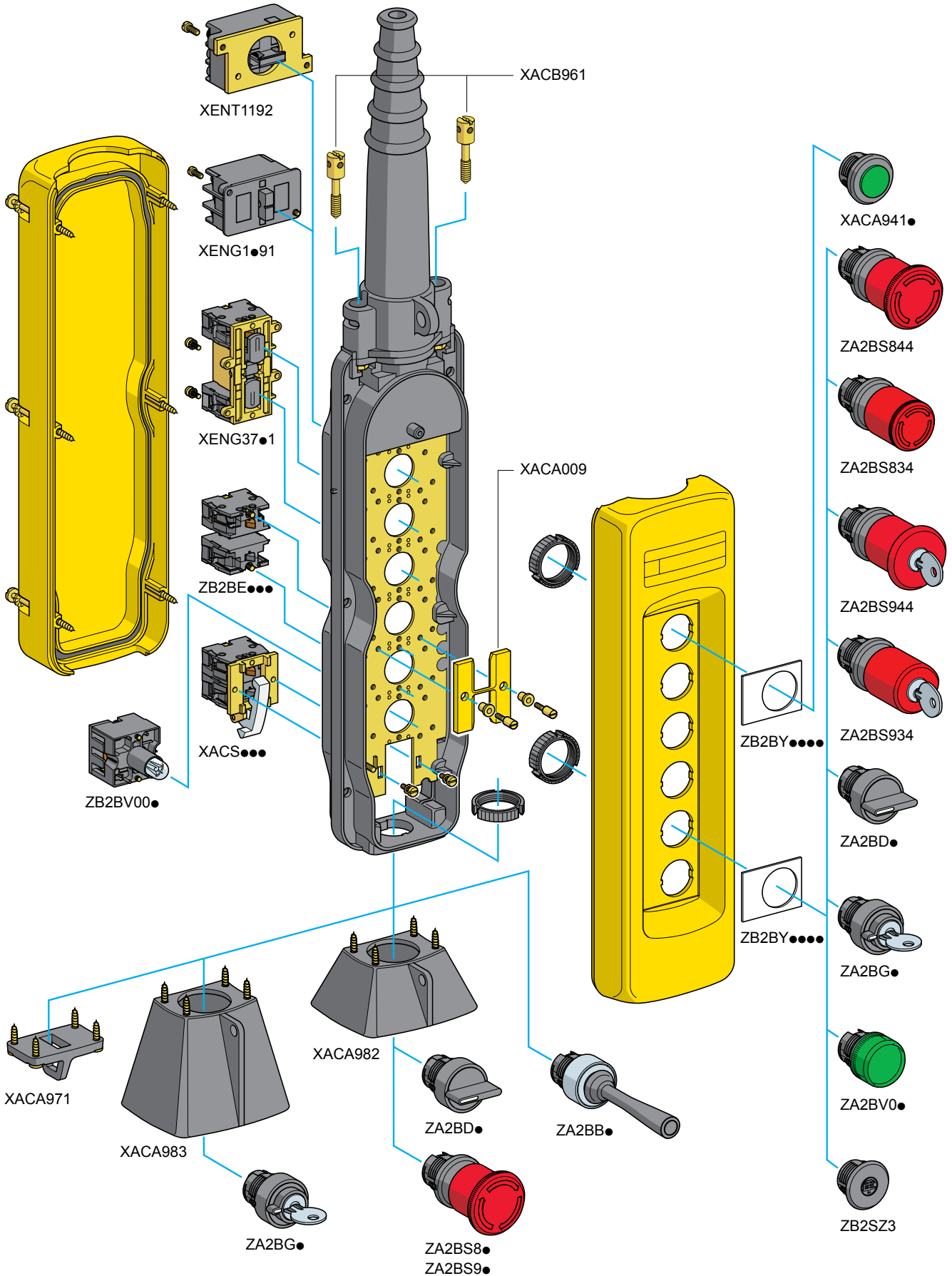

# Pendant control stations

Double insulated, type XACA  
For control circuits  
Variable composition stations, factory assembled

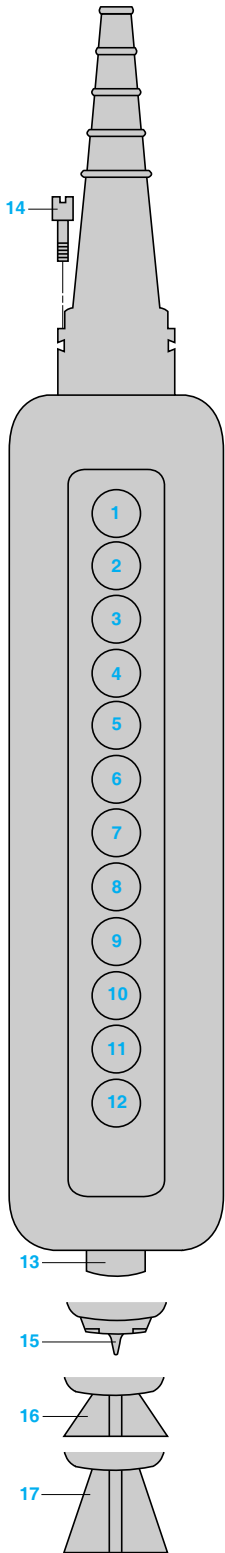

<b>Customer</b>			<b>Schneider Electric Industries</b>	
Company	Order N°	Delivery date	Sales office - Subsidiary Co.	Order N°

Enter the order with XACA09 reference

Unit reference of empty enclosure, see page 3/5	Number of identical stations	Enclosure price (1)
XAC <input type="text" value="A"/> <input type="text" value=""/> <input type="text" value=""/>		

Legends see page 3/10		Contact blocks or pilot light bodies see page 3/6		Operating heads or pilot light heads or blanking plug see page 3/8		Total price
Reference	Unit price	Reference	Unit price	Reference	Unit price	
1						
2						
3						
4						
5						
6						
7						
8						
9						
10						
11						
12						

Unit mounted in base of enclosure (if required) (Except when using XACA03 and XACA05)

13						
----	--	--	--	--	--	--

Complementary accessories, see page 3/9 (cross the appropriate box or boxes)

Description	<input checked="" type="checkbox"/>	Reference	Unit price
14 Adaptor for self-supporting cable type BBAP for use with cable entry sleeve Ø 8 to 26 mm		XACB961	
15 Lower support ring		XACA971	
16 Protective guard for selector switch (std. handle) or Emergency stop head pushbutton, mounted in base		XACA982	
17 Protective guard for key switch or key release Emergency stop head pushbutton, mounted in base		XACA983	

Mechanical interlocking (2)

Reference	Quantity	Unit price
XACA009		
<b>Factory assembly:</b>	Number of heads or blanking plugs to be fitted	Additional cost XAC9VA for fitting of 1 head or 1 blanking plug
	<input type="text" value=""/> X <input type="text" value=""/>	<input type="text" value=""/>

Total price of assembled pendant station

(1) Obtain the empty enclosure price.  
(2) Connect with a line the 2 ways which require mechanical interlocking.

Examples: combinations possible

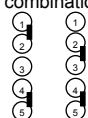

Combinations not possible



# Pendant control stations









Double insulated, type XACB

For control circuits

Complete stations "ready for use"

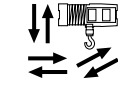
(with snap action contact blocks)

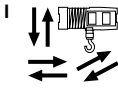
## For control of single-speed motors

Functions	Number of operators	Contact blocks and scheme Per direction	Reference	Weight kg
	<b>2</b> without mechanical interlocking	1 C/O snap action XESB2011 	<b>XACB281</b>	0.850
	<b>4</b> without mechanical interlocking	1 C/O snap action XESB2011 	<b>XACB481</b>	1.100
	<b>6</b> without mechanical interlocking	1 C/O snap action XESB2011 	<b>XACB681</b>	1.300
	<b>8</b> without mechanical interlocking	1 C/O snap action XESB2011 	<b>XACB881</b>	1.550

DF56564



XACB281

DF56565



XACB481

DF56566



XACB681

DF56567



XACB881



# Pendant control stations

Double insulated, type XACB  
For power circuits (direct switching)  
Complete stations "ready for use"



### For control of single-speed motors

Functions	Number of operators	Contact blocks Per direction	For Emergency stop	Maximum operational power/400 V	Reference	Weight kg
	2 mechanically interlocked	2-pole XESD1191(1)	–	2.2 kW	<b>XACB219</b>	0.355
		3-pole XESD2201(1)	–	3 kW	<b>XACB220</b>	0.355
	2 mechanically interlocked + 1 trigger action latching Emergency stop Ø 40 mm operator ZA2BS844	2-pole XESD1191(1)	1 N/C + N/C + N/C XACS499	2.2 kW	<b>XACB3195 ▲</b>	0.940
		3-pole XESD2201(1)	1 N/C + N/C + N/C XACS499	3 kW	<b>XACB3205 ▲</b>	1.000
	4 mechanically interlocked between pairs	2-pole XESD1191(1)	–	2.2 kW	<b>XACB491</b>	1.200
		3-pole XESD2201(1)	–	3 kW	<b>XACB493</b>	1.330
	4 mechanically interlocked between pairs + 1 trigger action latching Emergency stop Ø 40 mm operator ZA2BS844	2-pole XESD1191(1)	1 N/C + N/C + N/C XACS499	2.2 kW	<b>XACB4916 ▲</b>	1.260
		3-pole XESD2201(1)	1 N/C + N/C + N/C XACS499	3 kW	<b>XACB4936 ▲</b>	1.390
	4 mechanically interlocked between pairs + 1 trigger action latching Emergency stop Ø 40 mm operator ZA2BS844 mounted in base	2-pole XESD1191(1)	1 N/C + N/C + N/C XACS3991	2.2 kW	<b>XACB4915 ▲</b>	1.350
		3-pole XESD2201(1)	1 N/C + N/C + N/C XACS3991	3 kW	<b>XACB4935 ▲</b>	1.480

(1) Trigger action mechanically latching Emergency stop pushbuttons conform to standards EN/IEC 60204-32, EN/ISO 13850, Machinery directive 98/37/EC and standard EN/IEC 60947-5-5.

▲ Available 4<sup>th</sup> quarter of 2013

# Pendant control stations

Double insulated, type XACB  
For power circuits (direct switching)  
Complete stations "ready for use"

3



XACB691  
XACB693



XACB6916  
XACB6936



XACB6915  
XACB6935



XACB229



XACB3295

## For control of single-speed motors (continued)

Functions	Number of operators	Contact blocks		Maximum operational power/400 V	Reference	Weight kg
		Per direction	For Emergency stop			
 6 mechanically interlocked between pairs		2-pole XESD1191(1)	–	2.2 kW	<b>XACB691</b>	1.350
		3-pole XESD2201(1)	–	3 kW	<b>XACB693</b>	1.550
6 mechanically interlocked between pairs + 1 trigger action latching Emergency stop Ø 40 mm operator ZA2BS844		2-pole XESD1191(1)	1 N/C + N/C + N/C XACS499	2.2 kW	<b>XACB6916 ▲</b>	1.410
		3-pole XESD2201(1)	1 N/C + N/C + N/C XACS499	3 kW	<b>XACB6936 ▲</b>	1.610
6 mechanically interlocked between pairs + 1 trigger action latching Emergency stop Ø 40 mm operator ZA2BS844 mounted in base		2-pole XESD1191(1)	1 N/C + N/C + N/C XACS3991	2.2 kW	<b>XACB6915 ▲</b>	1.500
		3-pole XESD2201(1)	1 N/C + N/C + N/C XACS3991	3 kW	<b>XACB6935 ▲</b>	1.700

## For control of 2-speed motors

Functions	Number of operators	Contact blocks		Maximum operational power/400 V	Reference	Weight kg
		Per direction	For Emergency stop			
 2 mechanically interlocked		2-pole XESD1291(1)	–	2.2 kW	<b>XACB229</b>	0.405
2 mechanically interlocked + 1 trigger action latching Emergency stop Ø 40 mm operator ZA2BS844		2-pole XESD1291(1)	1 N/C + N/C + N/C XACS499	2.2 kW	<b>XACB3295 ▲</b>	0.990

(1) Trigger action mechanically latching Emergency stop pushbuttons conform to standards EN/IEC 60204-32, EN/ISO 13850, Machinery directive 98/37/EC and standard EN/IEC 60947-5-5.

▲ Available 4<sup>th</sup> quarter of 2013

# Pendant control stations

Double insulated, type XACB

For control or power circuits

Empty enclosures



XACB02●●

XACB04●●



XACB06●●

XACB08●●



XACB12●●

XACB120

## Empty enclosures for control circuits or power circuits (1)

Description	Protective cable sleeve	Number of cut-outs	Cut-out in base of enclosure	Reference	Weight kg
<b>Empty enclosures (1)</b> <b>Double insulated for "Small hoist" applications</b> Operator cut-out centres: 40 mm	For cable Ø 7...13 mm	2	Without	<b>XACB020</b>	0.760
		3	Without	<b>XACB030</b>	0.760
<b>Empty enclosures (1)</b> <b>Double insulated for "General purpose" applications</b> Operator cut-out centres: 40 mm	For cable Ø 10...22 mm	2	Without	<b>XACB02</b>	0.760
			With	<b>XACB021</b>	0.760
		4	Without	<b>XACB04</b>	1.000
			With	<b>XACB041</b>	1.000
		6	Without	<b>XACB06</b>	1.160
			With	<b>XACB061</b>	1.160
		8	Without	<b>XACB08</b>	1.330
			With	<b>XACB081</b>	1.330
12 in 2 rows of 6	Without	<b>XACB12</b>	1.460		
	With	<b>XACB121</b>	1.460		
For cable Ø 22...35 mm	2	Without	<b>XACB025</b>	0.960	
		With	<b>XACB0215</b>	0.960	
	4	Without	<b>XACB045</b>	1.200	
		With	<b>XACB0415</b>	1.200	
	6	Without	<b>XACB065</b>	1.360	
		With	<b>XACB0615</b>	1.360	
	8	Without	<b>XACB085</b>	1.530	
		With	<b>XACB0815</b>	1.530	
	12 in 2 rows of 6	Without	<b>XACB125</b>	1.660	
		With	<b>XACB1215</b>	1.660	

## Empty enclosures for control circuits (1)

Description	Protective cable sleeve	Number of cut-outs	Cut-out in base of enclosure	Reference	Weight kg
<b>Empty enclosures (1)</b> <b>Double insulated for "General purpose" applications</b> Operator cut-out centres: 30 mm	For cable Ø 10...22 mm	12 in 1 row	Without	<b>XACB120</b>	1.330
			With	<b>XACB1201</b>	1.330
Operator cut-out centres: 30 mm	For cable Ø 22...35 mm	12 in 1 row	Without	<b>XACB1205</b>	1.530
			With	<b>XACB12015</b>	1.530

## Variable composition stations, factory assembled

Use the order form on page 3/31 to define the required configuration

**Equipment:** contact blocks, operating heads (control and signalling), complementary accessories

See separate components, pages 3/18 to 3/29

(1) Enclosure comprising:

- the enclosure,
- protective cable sleeve,
- cable tie (for tightening sleeve onto cable): for cable Ø 7...13 mm, Ø 10...22 mm or Ø 22...35 mm,
- internal cable clamp,
- suspension ring,
- bezel tightening key.

# Pendant control stations

Double insulated, type XACB

For control circuits

Separate components and spare parts

## Contact blocks for front mounting, slow break

Description	Application	Function	Scheme	Operator centres	Reference	Weight
				mm		kg

### Spring return

<b>Single block</b> 1 spring return operator	Single-speed	N/O		30 or 40	<b>XENC1111</b>	0.020
-------------------------------------------------	--------------	-----	--	----------	-----------------	-------

	N/C			30 or 40	<b>XENC1121</b>	0.020
--	-----	--	--	----------	-----------------	-------

	N/O + N/O			30 or 40	<b>XENC1131</b>	0.020
--	-----------	--	--	----------	-----------------	-------

	N/C + N/C			30 or 40	<b>XENC1141</b>	0.020
--	-----------	--	--	----------	-----------------	-------

	N/C + N/O			30 or 40	<b>XENC1151</b>	0.020
--	-----------	--	--	----------	-----------------	-------

	C/O + N/O			30 or 40	<b>XENB1491</b>	0.050
--	-----------	--	--	----------	-----------------	-------

2-speed	2 step N/O + N/O staggered			30 or 40	<b>XENB1181</b>	0.050
---------	----------------------------------	--	--	----------	-----------------	-------

	2 step C/O + N/O staggered			30 or 40	<b>XENB1191</b>	0.050
--	----------------------------------	--	--	----------	-----------------	-------

<b>Double block</b> 2 spring return operators mechanically interlocked	Single-speed	N/O + N/O simultaneous		30	<b>XEND1611</b>	0.110
------------------------------------------------------------------------------	--------------	---------------------------	--	----	-----------------	-------

				40 (1)	<b>XEND2611</b>	0.110
--	--	--	--	--------	-----------------	-------

2-speed	2 step N/O + N/O staggered			30	<b>XEND1621</b>	0.110
---------	----------------------------------	--	--	----	-----------------	-------

				40 (1)	<b>XEND2621</b>	0.110
--	--	--	--	--------	-----------------	-------

(1) These contact blocks cannot be mounted in enclosures XACB120 (12 operators in 1 row).

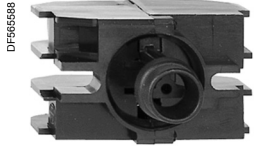

XENC1111

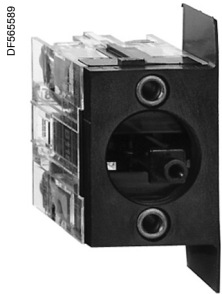

XENB1181

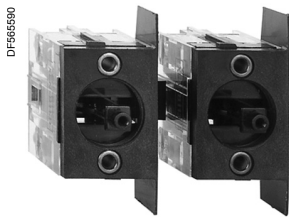

XEND2611

# Pendant control stations

Double insulated, type XACB

For control circuits

Separate components and spare parts

## Contact blocks for front mounting, slow break (continued)

Description	Application Function	Scheme	Operator centres	Reference	Weight
			mm	kg	

### Spring return (continued)

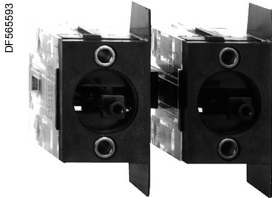

XEND2641

**Double block**  
2 spring return operators  
mechanically interlocked

Single-speed C/O + N/O

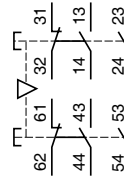

30

**XEND1631**

0.110

40 (1)

**XEND2631**

0.110

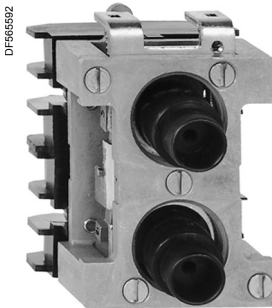

XEND3801

### Latching

**Double block**  
1 latching operator released  
by 1 spring return operator

Single-speed N/C + N/O

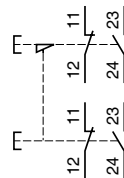

30

**XEND3801**

0.170

40 (1)

**XEND4801**

0.170

**Double block**  
2 latching operators

Single-speed N/C + N/O

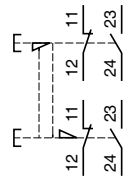

30

**XEND3811**

0.170

40 (1)

**XEND4811**

0.170

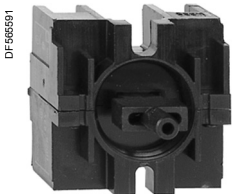

XESB2011

## Contact blocks for front mounting, snap action

Description	Application Function	Scheme	Operator centres	Reference	Weight
			mm	kg	

### Spring return

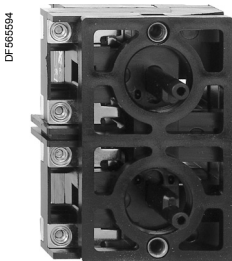

XESD1181

**Single block**  
1 spring return operator (2)

Single-speed C/O



40 (1)

**XESB2011**

0.030

**Double block**  
2 spring return operators  
mechanically interlocked

Single-speed C/O

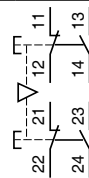

40 (1)

**XESD1181**

0.140

2-speed C/O + N/O  
staggered

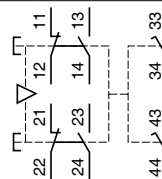

40 (1)

**XESD1281**

0.190

(1) These contact blocks cannot be mounted in enclosures XACB120● (12 operators in 1 row).  
(2) Only for mounting with operators XACB91●●.

# Pendant control stations

Double insulated, type XACB

For control circuits

Separate components and spare parts



XACS41

### Contact blocks for front mounting (1)

Description	Function	Scheme	Reference	Weight kg
<b>Spring return</b> <b>Slow break</b> Operator centres 30 or 40 mm	N/O		<b>XACS411</b>	0.070
	N/C		<b>XACS412</b>	0.070
	N/O + N/O		<b>XACS413</b>	0.070
	N/C + N/C		<b>XACS414</b>	0.070
	N/C + N/O		<b>XACS415</b>	0.070

### Contact blocks for base mounting (1)

Description	Function	Scheme	Reference	Weight kg
<b>Spring return</b> <b>Slow break</b>	N/O		<b>XACS4111</b>	0.100
	N/C		<b>XACS4121</b>	0.100
	N/O + N/O		<b>XACS4131</b>	0.100
	N/C + N/C		<b>XACS4141</b>	0.100
	N/C + N/O		<b>XACS4151</b>	0.100

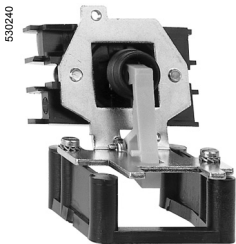

XACS4111

### Pilot light bodies for front mounting

Description	Supply voltage	Scheme	Reference	Weight kg
<b>Direct supply</b> Bulb not included (2)	≤ 400 V		<b>XACV06</b>	0.050
<b>Direct supply, through resistor</b> Incandescent BA 9s base fitting 130 V bulb included	230 V		<b>XACV07</b>	0.055



XACV06

(1) Mounting with operating heads ZA2B●●● (see page 3/23).

(2) Bulb type for use with direct supply units: BA 9s base fitting incandescent bulb  $U \leq 130$  V or neon bulb  $110$  V  $\leq U \leq 400$  V. Maximum power: 2.6 W, maximum  $\varnothing$ : 11 mm, maximum length: 26 mm. See page 3/25.

# Pendant control stations

Double insulated, type XACB

For power circuits (direct switching)

Separate components and spare parts

## Contact blocks, snap action

Description	Application	Function	Max. power/400 V	Scheme	Reference	Weight kg
<b>Double block 2-pole</b> 2 spring return operators mechanically interlocked (operator centres: 40 mm)	Single-speed	N/O + N/O	2.2 kW		<b>XESD1191</b>	0.140
	2-speed	N/O + N/O + 1 C/O staggered auxiliary contact (1)	2.2 kW		<b>XESD1291</b>	0.190
<b>Double block 3-pole</b> 2 spring return operators mechanically interlocked (operator centres: 40 mm)	Single-speed	N/O + N/O + N/O	3 kW		<b>XESD2201</b>	0.200
		N/O + N/O + N/O + 1 N/O simultaneous auxiliary contact (1)	3 kW		<b>XESD2241</b>	0.210
		N/O + N/O + N/O + 1 N/O staggered auxiliary contact (1)	3 kW		<b>XEND2251</b>	0.210

## Isolating block, slow break

In the interests of safety, it is imperative that these isolating blocks only be used with a stay put or latching type operating head to ensure complete isolation when the pendant station is not in use.

Mounting position	Application	Function	Max. power/400 V	Scheme	Reference	Weight kg
On front 40 mm centres (2)	Emergency stop	N/C + N/C + N/C with positive opening operation	3 kW		<b>XACS399</b>	0.100
On front 30 mm centres (2)	Emergency stop	N/C + N/C + N/C with positive opening operation	3 kW		<b>XACS499</b>	0.100
In base (3)	Emergency stop	N/C + N/C + N/C with positive opening operation	3 kW		<b>XACS3991</b>	0.110

(1) Auxiliary contacts are slow break.

(2) Mounting with operating heads ZA2B●●●, except ZA2BD● and ZA2BG● (see page 3/23).

(3) Mounting with operating head ZA2BS944 (see page 3/23).

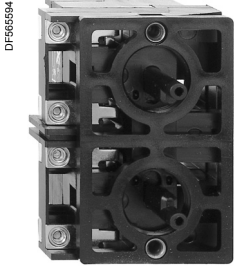

XESD1191

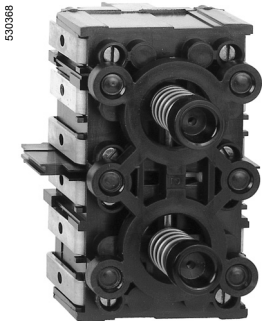

XESD2201



XACS399



XACS499

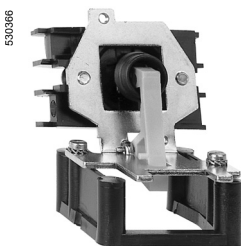

XACS3991

# Pendant control stations

Double insulated, type XACB

For control or power circuits

Separate components and spare parts



XACB911●

Booted operators							
For use with contact block	Travel	Operating temperature	Colour of insert	Sold in lots of	Unit reference	Weight kg	
XENB●●●●	4 mm	- 25...+ 70 °C (1)	White	10	XACB9111	0.005	
XENC●●●●			Black	10	XACB9112	0.005	
XEND●●●●			Green	10	XACB9113	0.005	
XESB2011			Red	10	XACB9114	0.005	
XESD2201			Yellow	10	XACB9115	0.005	
XESD2241			Blue	10	XACB9116	0.005	
XESD2251			Brown	10	XACB9119	0.005	
			- 40...+ 70 °C (2)	White	10	XACB9121	0.005
				Black	10	XACB9122	0.005
				Green	10	XACB9123	0.005
	Red	10		XACB9124	0.005		
	Yellow	10		XACB9125	0.005		
	Blue	10		XACB9126	0.005		
	Brown	10		XACB9129	0.005		
XESD1181	16 mm	- 25...+ 70 °C (1)		White	10	XACB9211	0.005
XESD1191				Black	10	XACB9212	0.005
XESD1281				Green	10	XACB9213	0.005
XESD1291			Red	10	XACB9214	0.005	
			Yellow	10	XACB9215	0.005	
			Blue	10	XACB9216	0.005	
			Brown	10	XACB9219	0.005	
			- 40...+ 70 °C (2)	White	10	XACB9221	0.005
				Black	10	XACB9222	0.005
				Green	10	XACB9223	0.005
	Red	10		XACB9224	0.005		
	Yellow	10		XACB9225	0.005		
	Blue	10		XACB9226	0.005		
			Brown	10	XACB9229	0.005	

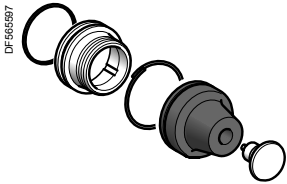

XACB921●



ZA2BP●

Booted operators (silicone boot)				
For use with contact block	Operating temperature	Colour of boot	Reference	Weight kg
XACS41●	- 25...+ 70 °C	Black	ZA2BP2	0.015
		Green	ZA2BP3	0.015
		Red	ZA2BP4	0.015
		Yellow	ZA2BP5	0.015
		Blue	ZA2BP6	0.015

(1) Polychloroprene boots.  
(2) Silicone boots.



# Pendant control stations

Double insulated, type XACB

For control or power circuits

Separate components and spare parts



ZA2BS844



ZA2BS944



ZA2BD●



ZA2BG●



ZA2BB●



ZA2BV0●

## Operating heads for front or base mounting (1)

Description	Colour	Type	Reference	Weight kg
<b>Trigger action latching Emergency stop (2)</b>	Red	Ø 30 mm	<b>ZA2BS834</b>	0.028
Turn to release (Emergency stop function)		Ø 40 mm	<b>ZA2BS844</b>	0.033
<b>Trigger action latching Emergency stop (2) (3)</b>	Red	Ø 30 mm	<b>ZA2BS934</b>	0.060
Key release (n° 455)		Ø 40 mm	<b>ZA2BS944</b>	0.065
Key withdrawal in rest (unactuated) position (Emergency stop function)				
<b>Selector switches, standard handle (4)</b>	Black	2 position, stay put	<b>ZA2BD2</b>	0.018
		3 position, stay put (5)	<b>ZA2BD3</b>	0.018
<b>Key switches</b> (key n° 455) (3)	–	2 position, stay put	<b>ZA2BG4</b>	0.042
Key withdrawal in left and right-hand positions		3 position, stay put (5)	<b>ZA2BG5</b>	0.042
<b>Key switches</b> (key n° 455) (3)	–	2 position, stay put	<b>ZA2BG2</b>	0.042
Key withdrawal in left-hand position				
<b>Key switches</b> (key n° 455) (3)	–	2 position	<b>ZA2BG6</b>	0.042
Spring return from right to left				
Key withdrawal in left-hand position				
<b>Key switches</b> (key n° 455) (4) (3)	–	3 position, stay put (5)	<b>ZA2BG3</b>	0.042
Key withdrawal in centre position				
<b>Wobblesticks (6)</b>	Black	–	<b>ZA2BB2</b>	0.060
Operates in all directions for fast stop	Red	–	<b>ZA2BB4</b>	0.060

## Operating head for isolating block

Description	Colour	Type	Reference	Weight kg
<b>Mushroom head, latching</b>	Red	Ø 40 mm	<b>ZA2BS14</b>	0.065
Key release (n° 455)				
Key withdrawal in rest (unactuated) position (Emergency stop function)				

## Pilot light heads

Description	Colour	Reference	Weight kg
<b>For use with incandescent bulbs</b>			
<b>Lens cap with fixing bezel</b>	White	<b>ZA2BV01</b>	0.015
	Green	<b>ZA2BV03</b>	0.015
	Red	<b>ZA2BV04</b>	0.015
	Yellow	<b>ZA2BV05</b>	0.015
	Blue	<b>ZA2BV06</b>	0.015
	Clear	<b>ZA2BV07</b>	0.015
<b>For use with neon bulbs</b>			
<b>Lens cap with fixing bezel</b>	Green	<b>ZA2BV033</b>	0.015
	Red	<b>ZA2BV043</b>	0.015
	Yellow	<b>ZA2BV053</b>	0.015
	Clear	<b>ZA2BV073</b>	0.015

(1) The technical characteristics of pendant control stations XACB can only be guaranteed by using the operating heads ZA2B●● listed above.

(2) Trigger action mechanically latching Emergency stop pushbuttons conform to standards EN/IEC 60204-32, EN/ISO 13850, Machinery directive 98/37/EC and standard EN/IEC 60947-5-5.

(3) Other key numbers available on request, please consult our Customer Care Centre.

(4) Selector switches or key switches with other mechanical functions: please consult our Customer Care Centre.

(5) Only suitable for front mounting.

(6) Base mounting recommended.

# Pendant control stations

Double insulated, type XACB

For control circuits

Separate components and spare parts



XEAC●5361

### Pushbuttons with analogue output (1)

#### Complete pushbuttons (body + operating head), non booted (2)

Supply voltage	Contact block	Reference	Weight kg
0...- 15 V	N/C + N/O at start of travel N/O at end of travel	XEAC15361	0.065
0...+ 15 V	N/C + N/O at start of travel N/O at end of travel	XEAC25361	0.065

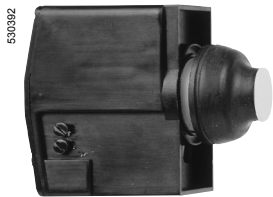

XEAB●5361

#### Complete pushbuttons (body + operating head), booted (2)

Supply voltage	Contact block	Reference	Weight kg
0...- 15 V	N/C + N/O at start of travel N/O at end of travel	XEAB15361	0.065
0...+ 15 V	N/C + N/O at start of travel N/O at end of travel	XEAB25361	0.065

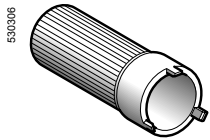

ZA2BZ905

#### Mounting accessories

Description	For use with	Reference	Weight kg
Tightening key for fixing nut	XEAC●5361	ZA2BZ905	0.060
	XEAB●5361	XACX1	0.010



XACX1

#### Separate components and spare parts

Description	Colour of insert	Unit reference	Weight kg
Booted operator (Sold in lots of 10)	White	XACB9111	0.005
	Black	XACB9112	0.005



XACB9112

(1) Pushbuttons providing an analogue output signal proportional to the distance travelled by the pushbutton operator. For more information on the analogue output signal, see our schemes and curves and on our site [www.schneider-electric.com](http://www.schneider-electric.com).  
 (2) Pushbutton supplied with 1 white insert and 1 black insert.

# Pendant control stations

Double insulated, type XACB

For control or power circuits

Separate components and spare parts

530307



DL1C●●●●

## Bulbs

Description	Voltage	Sold in lots of	Unit reference	Weight kg
<b>Incandescent</b> BA 9s base fitting Maximum power: 2.6 W Maximum Ø: 11 mm Maximum length: 28 mm	6 V	10	DL1CB006	0.002
	12 V	10	DL1CE012	0.002
	24 V	10	DL1CE024	0.002
	48 V	10	DL1CE048	0.002
	130 V	10	DL1CE130	0.002
<b>Neon</b> BA 9s base fitting Maximum power: 2.6 W Maximum Ø: 11 mm Maximum length: 28 mm	120 V	10	DL1CF110	0.002
	230 V	10	DL1CF220	0.002
	400 V	10	DL1CF380	0.002

530308



DL1CF●●●

530311



XACB91●

## Accessories for booted operators

Description	Travel	Material/ Colour	Operating temperature	Sold in lots of	Unit reference	Weight kg
<b>Boots with circlip, without coloured insert</b>	4 mm	Polychloroprene	-25...+70° C	10	XACB911	0.002
		Silicone	-40...+70° C	10	XACB912	0.002
	16 mm	Polychloroprene	-25...+70° C	10	XACB921	0.002
		Silicone	-40...+70° C	10	XACB922	0.002
<b>Coloured inserts for booted operators (4 and 16 mm travel)</b>	White	–	–	10	XACB901	0.001
	Black	–	–	10	XACB902	0.001
	Green	–	–	10	XACB903	0.001
	Red	–	–	10	XACB904	0.001
	Yellow	–	–	10	XACB905	0.001
	Blue	–	–	10	XACB906	0.001
	Brown	–	–	10	XACB909	0.001

530310



XACB92●

530309



XACB90●

# Pendant control stations

Double insulated, type XACB

For control or power circuits

Separate components and spare parts

530312

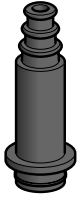

XACB913

530313

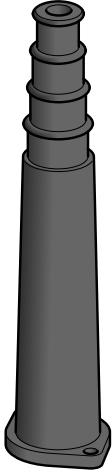

XACB960

3

530314

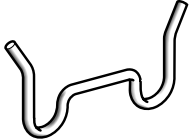

XACB971

DF565602

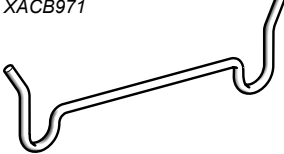

XACB972

DF565604

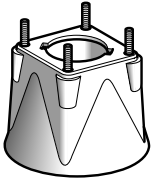

XACB982

530318

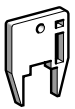

XACX1

530319



XACX905

## Complementary accessories

Description	For use with	Diameter of cable	Reference	Weight kg
<b>Protective cable sleeve</b> with cable tie (for tightening sleeve onto cable)	Enclosures XACB219 and XACB220 (2 operators)	Ø 7...13 mm	<b>XACB913</b>	0.065
	Enclosures XACB●●● with 4 to 12 operators	Ø 10...22 mm	<b>XACB960</b>	0.110
		Ø 22...35 mm	<b>XACB965</b>	0.160

<b>Blanking plug</b> with seal and fixing nut	–		<b>ZB2SZ3</b>	0.005
--------------------------------------------------	---	--	---------------	-------

<b>Adaptor</b> for use with protective cable sleeve for cable Ø 10...22 mm	Self-supporting cable type BBAP		<b>XACB961</b>	0.025
-------------------------------------------------------------------------------	---------------------------------	--	----------------	-------

<b>Lower support ring</b>	Single row enclosures XACB		<b>XACB971</b>	0.015
---------------------------	----------------------------	--	----------------	-------

	2 row enclosures XACB		<b>XACB972</b>	0.020
--	-----------------------	--	----------------	-------

<b>Protective guards</b> for base mounted units	Emergency stop pushbutton		<b>XACB982</b>	0.050
----------------------------------------------------	---------------------------	--	----------------	-------

## Tools

Description	For use with	Reference	Weight kg
<b>Tightening key</b>	Bezels	<b>XACX1</b>	0.010
	Units mounted in base of enclosure	<b>XACX905</b>	0.015

<b>Bulb extractor</b>	BA 9s base fitting bulbs	<b>XBFX13</b>	0.003
-----------------------	--------------------------	---------------	-------

# Pendant control stations

Double insulated, type XACB

For control or power circuits

Legends 30 x 40 mm (with symbols conforming to NF E 52-124)

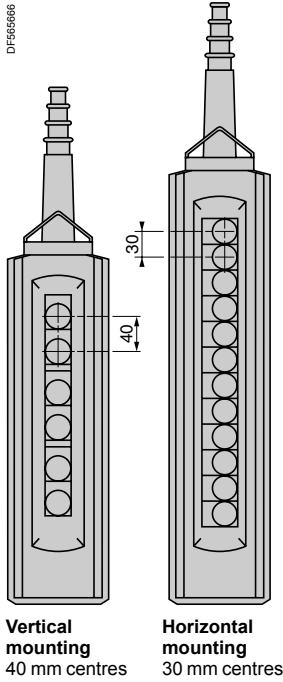

Vertical mounting  
40 mm centres

Horizontal mounting  
30 mm centres

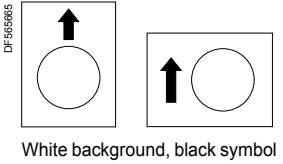

White background, black symbol



Black background, white symbol



Red background, white symbol

Symbol Reference	Symbol	Reference	Weight kg	Symbol Reference	Symbol	Reference	Weight kg
Vertical mounting 40 mm centres	Horizontal mounting 30 mm centres			Vertical mounting 40 mm centres	Horizontal mounting 30 mm centres		
<b>Raise, slow</b>		ZB2BY4951				ZB2BY4901	0.001
<b>Raise, fast</b>		ZB2BY4952				ZB2BY4902	0.001
<b>Raise, slow-fast</b>		ZB2BY4953				ZB2BY4903	0.001
<b>Right, slow</b>		ZB2BY4901				ZB2BY4907	0.001
<b>Right, fast</b>		ZB2BY4902				ZB2BY4908	0.001
<b>Right, slow-fast</b>		ZB2BY4903				ZB2BY4909	0.001
<b>Forward, slow</b>		ZB2BY4963				ZB2BY4913	0.001
<b>Forward, fast</b>		ZB2BY4964				ZB2BY4914	0.001
<b>Forward, slow-fast</b>		ZB2BY4965				ZB2BY4915	0.001
<b>Slew right, slow</b>		ZB2BY4919				ZB2BY4919	0.001
<b>Slew right, fast</b>		ZB2BY4920				ZB2BY4920	0.001
<b>Slew right, slow-fast</b>		ZB2BY4921				ZB2BY4921	0.001
<b>Slow</b>		ZB2BY4933				ZB2BY4933	0.001
<b>Klaxon</b>		ZB2BY4982				ZB2BY4932	0.001
<b>Start</b>		ZB2BY4980				ZB2BY4930	0.001
<b>Lower, slow</b>		ZB2BY2954				ZB2BY2904	0.001
<b>Lower, fast</b>		ZB2BY2955				ZB2BY2905	0.001
<b>Lower, slow-fast</b>		ZB2BY2956				ZB2BY2906	0.001
<b>Left, slow</b>		ZB2BY2904				ZB2BY2910	0.001
<b>Left, fast</b>		ZB2BY2905				ZB2BY2911	0.001
<b>Left, slow-fast</b>		ZB2BY2906				ZB2BY2912	0.001
<b>Reverse, slow</b>		ZB2BY2966				ZB2BY2916	0.001
<b>Reverse, fast</b>		ZB2BY2967				ZB2BY2917	0.001
<b>Reverse, slow-fast</b>		ZB2BY2968				ZB2BY2918	0.001
<b>Slew left, slow</b>		ZB2BY2922				ZB2BY2922	0.001
<b>Slew left, fast</b>		ZB2BY2923				ZB2BY2923	0.001
<b>Slew left, slow-fast</b>		ZB2BY2924				ZB2BY2924	0.001
<b>Fast</b>		ZB2BY4934				ZB2BY4934	0.001
<b>Start-Klaxon</b>		ZB2BY4985				ZB2BY4935	0.001
<b>Stop</b>		ZB2BY2931				ZB2BY2931	0.001

# Pendant control stations

Double insulated, type XACB

For control or power circuits

Legends 30 x 40 mm

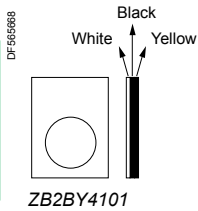
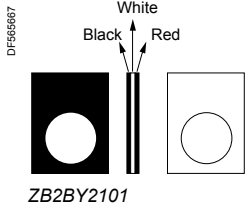

Text	Reference	Weight kg	Text	Reference	Weight kg
------	-----------	-----------	------	-----------	-----------

- Start functions: white characters on black background
- Stop functions: white characters on red background

Blank					
Black or red background	ZB2BY2101	0.001	White or yellow background	ZB2BY4101	0.001

With French text			With English text		
For pushbuttons			For pushbuttons		

Marche	ZB2BY2103	0.001	Start	ZB2BY2303	0.001
Arrêt	ZB2BY2104	0.001	Stop	ZB2BY2304	0.001
Avant	ZB2BY2105	0.001	Forward	ZB2BY2305	0.001
Arrière	ZB2BY2106	0.001	Reverse	ZB2BY2306	0.001
Montée	ZB2BY2107	0.001	Up	ZB2BY2307	0.001
Descente	ZB2BY2108	0.001	Down	ZB2BY2308	0.001
Droite	ZB2BY2109	0.001	Right	ZB2BY2309	0.001
Gauche	ZB2BY2110	0.001	Left	ZB2BY2310	0.001
En service	ZB2BY2111	0.001	On	ZB2BY2311	0.001
Hors service	ZB2BY2112	0.001	Off	ZB2BY2312	0.001
Sous tension	ZB2BY2126	0.001	Power on	ZB2BY2326	0.001
Lent	ZB2BY2127	0.001	Slow	ZB2BY2327	0.001
Vite	ZB2BY2128	0.001	Fast	ZB2BY2328	0.001
Klaxon	ZB2BY2125	0.001	-	-	-
For selector switches			For selector switches		
Arrêt-Marche	ZB2BY2166	0.001	-	-	-
Hors-En	ZB2BY2167	0.001	Off-On	ZB2BY2367	0.001

### With special texts

- Specify text when ordering.
- 2 lines maximum, 11 characters per line.

White characters on black background	ZB2BY2002	0.001	Black characters on white background	ZB2BY4001	0.001
White characters on red background	ZB2BY2004	0.001	Black characters on yellow background	ZB2BY4005	0.001





**Other versions** Legends with texts in other languages.  
Please consult our Customer Care Centre.

# Pendant control stations

Double insulated, type XACB

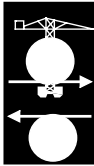
For control or power circuits

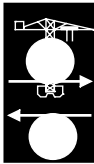
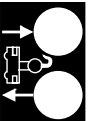
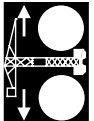
Twin legends for tower cranes

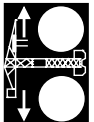
Legends with white symbols on black background							
Function	Symbol	Reference	Weight kg	Function	Symbol	Reference	Weight kg
<b>40 mm operator centres</b> (for enclosures with 2 to 8 operators and 12 operators in 2 rows)							
Hoist Raise Lower		XACY4970	0.002	Long travel Forward Reverse		XACY4972	0.002
Slew Right Left		XACY4971	0.002	Trolley Forward Reverse		XACY4973	0.002
<b>30 mm operator centres</b> (for enclosures with 12 operators in 1 row)							
Hoist Raise Lower		XACY3970	0.002	Long travel Forward Reverse		XACY3972	0.002
Slew Right Left		XACY3971	0.002	Trolley Forward Reverse		XACY3973	0.002

# Pendant control stations

Double insulated, type XACB

For control or power circuits

Variable composition stations, factory assembled

3

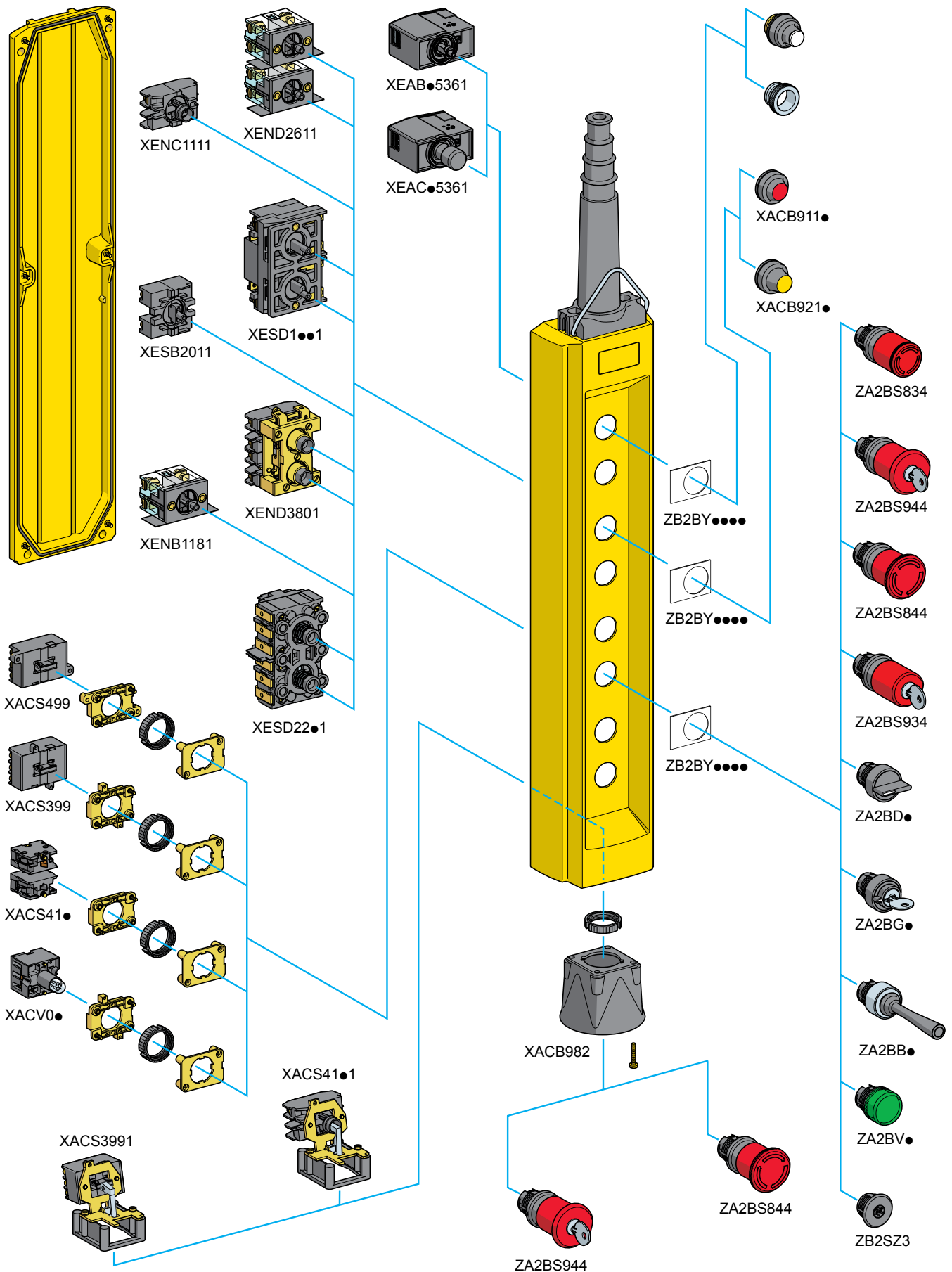



# Pendant control stations

Double insulated, type XACB  
For control or power circuits  
Variable composition stations, factory assembled

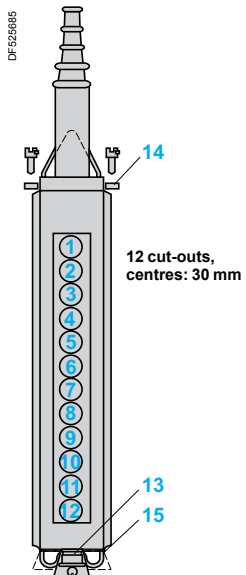
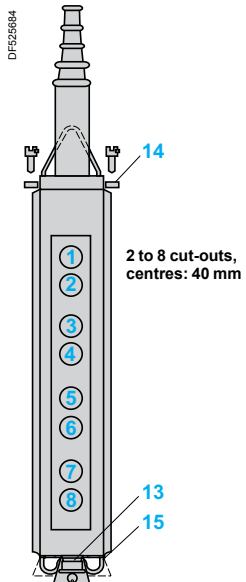
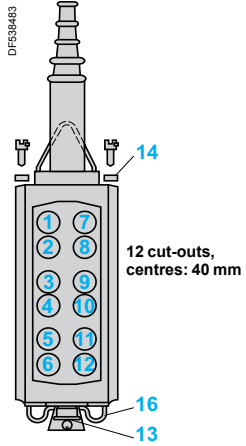

Customer			Schneider Electric Industries	
Company	Order N°	Delivery date	Sales office - Subsidiary Co.	Order N°

Enter the order with XACB09 reference

Unit reference of empty enclosure see page 3/17	Number of identical stations	Enclosure price (1)
XAC B 0 9 <input type="text"/> <input type="text"/> <input type="text"/>		

Legends see page 3/29	Contact blocks or pilot light bodies see page 3/18	Operating heads or pilot light heads or blanking plug see page 3/23	
Reference	Unit price	Reference	Unit price

Reference	Unit price	Reference	Unit price	Reference	Unit price	Total price
1						
2						
3						
4						
5						
6						
7						
8						
9						
10						
11						
12						

Unit mounted in base of enclosure (if required)

13						
----	--	--	--	--	--	--

Factory assembled:

Number of heads or blanking plugs to be fitted

X

Additional cost XAC9VA for fitting of 1 head or 1 blanking plug



Complementary accessories, see page 3/26 (cross the appropriate box or boxes)

Description	<input checked="" type="checkbox"/>	Reference	Unit price
14 Adaptor for self-supporting cable type BBAP for use with cable entry sleeve Ø 10 to 22 mm		XACB961	
15 Lower support ring for single row enclosures		XACB971	
15 Lower support ring for 2 row enclosures		XACB972	
16 Protective guard for key release latching mushroom head pushbutton, mounted in base		XACB982	

Total price of assembled pendant station

(1) Obtain the empty enclosure price.

# Pendant control stations

Double insulated, type XACF

For control circuits

Empty enclosures

DF565680



XACF00●0

DF565681



XACF00●1

## Empty enclosures (1)

Description	Protective cable sleeve	Reference	Weight kg	
Enclosures without cut-outs	Without guard rails	Ø 10...22 mm	<b>XACF0010</b>	2.100
		Ø 22...35 mm	<b>XACF0050</b>	2.300
	With guard rails	Ø 10...22 mm	<b>XACF0011</b>	2.300
		Ø 22...35 mm	<b>XACF0051</b>	2.500

(1) Enclosure comprising:

- the enclosure,
- protective cable sleeve for cable Ø 10...22 mm or Ø 22...35 mm,
- cable tie (for tightening sleeve onto cable),
- internal cable clamp.

# Pendant control stations

Double insulated, type XACF  
For control circuits

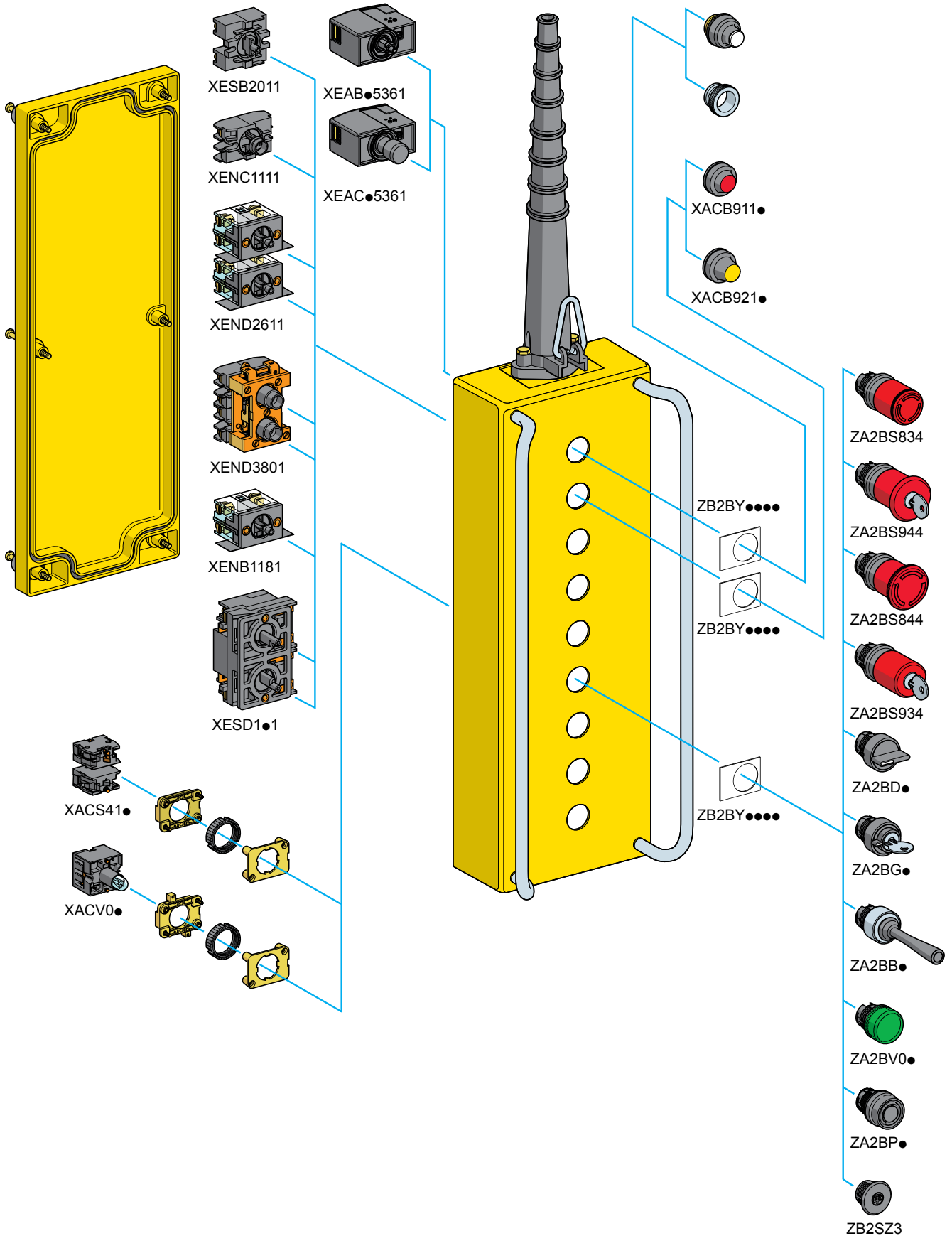

For information on accessories, see page 3/18 to 3/25



How to find “Automation and Control” products, index

- **How to find the “Automation and Control” products**
- Search, visualize and download ..... 4/2
- Access product references with adapted tools ..... 4/4
- Compare, select and compile ..... 4/6
- Check the product status, design your equipment ..... 4/7
- **Product reference index** ..... 4/8

# Search, visualize, and download

Use your tablet or your PC to quickly access detailed and comprehensive information on all our products



## Tablets

Application name: "Automation Library by Schneider Electric"

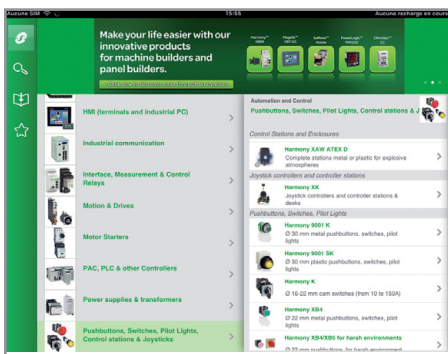

All product ranges displayed by function

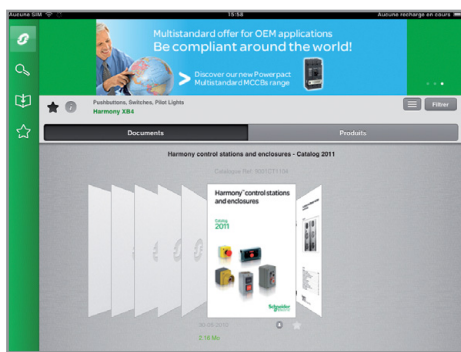

Dynamic catalogues (hyperlinks, video, ...)

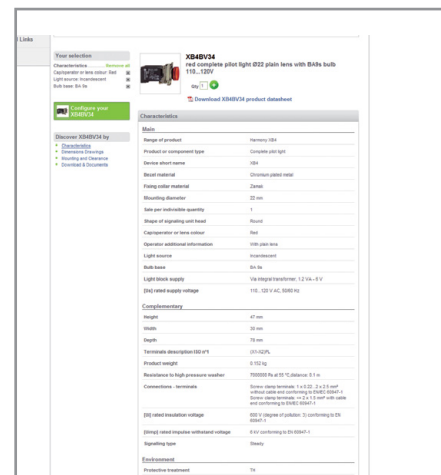
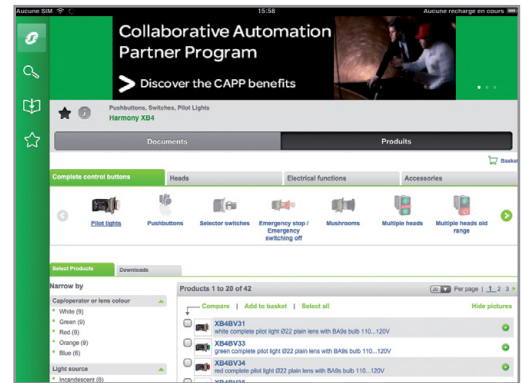

Product selector: dynamic filters to get easily your part number



# Personal computer

Path: [www.schneider-electric.com](http://www.schneider-electric.com) > **Products and Services** > Automation and control > Product offer

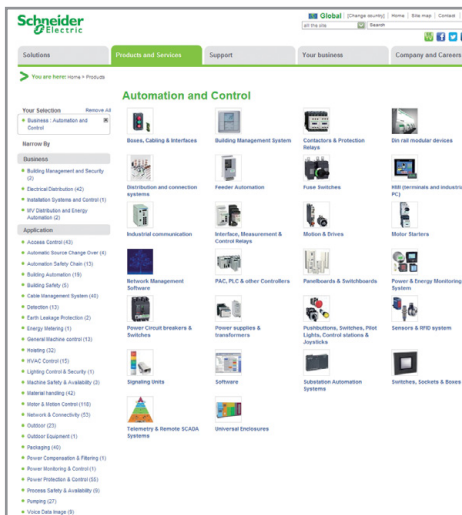

All product ranges displayed by function

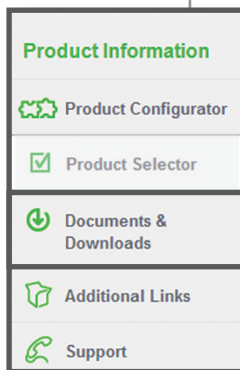
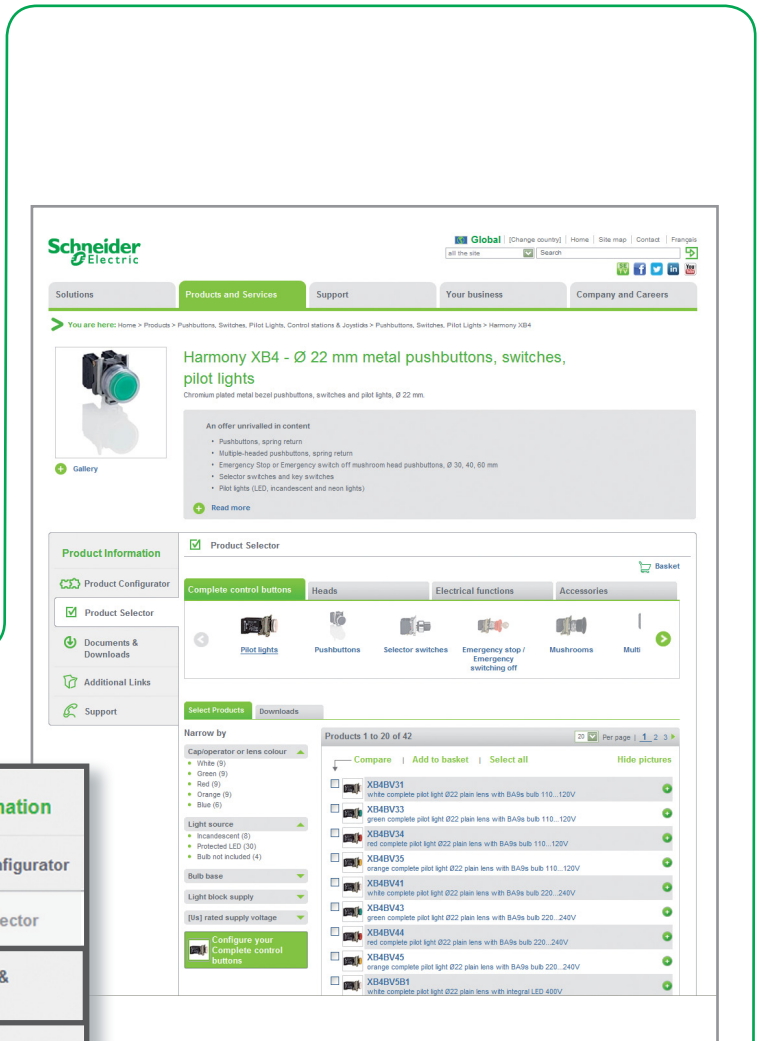

Dynamic catalogues (hyperlinks, video, ...)

Product selector: dynamic filters to get easily your part number

# Access product references with adapted tools



Path: [www.schneider-electric.com](http://www.schneider-electric.com) > **Products and Services** > Automation and control > ... > Product offer

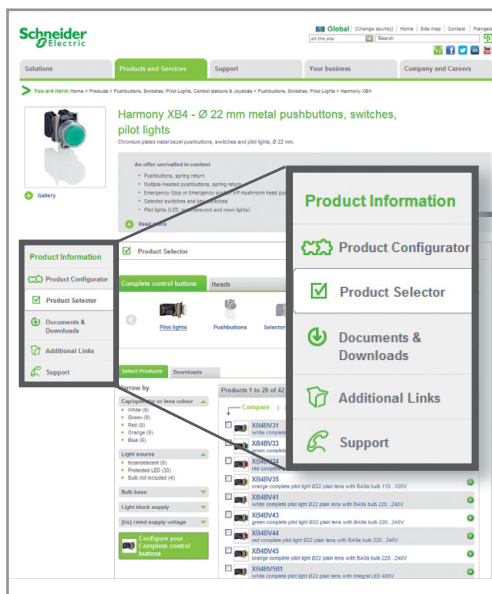

**Graphic product configurator**  
Select the right product with just a few clicks

**Dynamic product selector**  
Visualize product characteristics and dimensions

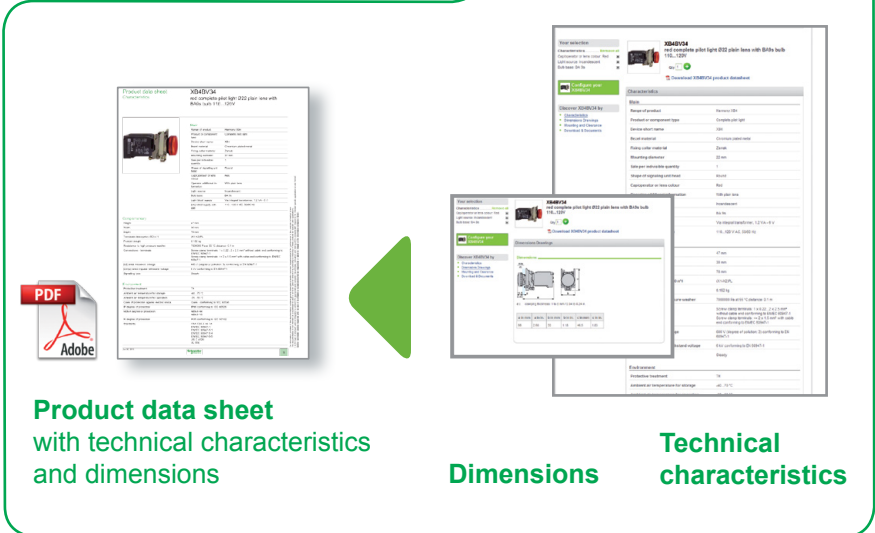
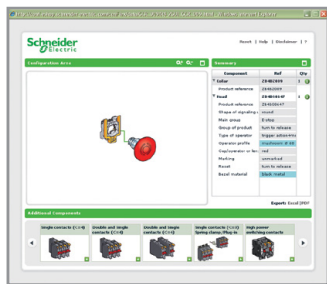
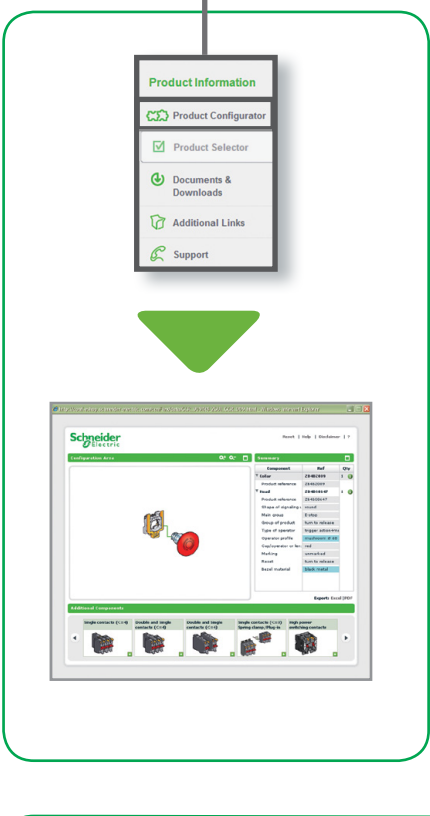

**Product data sheet**  
with technical characteristics  
and dimensions

**Dimensions**

**Technical characteristics**



**Documents and downloads**  
Visualize and download catalogues,  
technical publications, certificates, etc.

- Product Information
- Product Configurator
- Product Selector
- Documents & Downloads
- Additional Links
- Support

Schneider Electric website interface for Harmony XB4 - Ø 22 mm metal pushbuttons, switches, pilot lights. The page includes a product selector, a list of documents and downloads, and a support section.

Title	Reference	Date	Size
Response for Safety Voltage Switching (RVS)	SA02071210102	Jan 26, 2012	43.0 KB
Response for Safety Voltage Switching (RVS)	SA02071210102	Jan 19, 2012	1.7 KB
The essential guide of Control Panel	PA00121010101	Nov 28, 2012	69.0 KB
The essential guide of Energy Control and Safety	PA00121010102	Nov 28, 2012	1.0 KB
The essential guide of Energy Control and Safety	PA00121010103	Nov 28, 2012	1.0 KB
The essential guide of Energy Control and Safety	PA00121010104	Nov 28, 2012	1.0 KB
The essential guide of Energy Control and Safety	PA00121010105	Nov 28, 2012	1.0 KB
The essential guide of Energy Control and Safety	PA00121010106	Nov 28, 2012	1.0 KB
The essential guide of Energy Control and Safety	PA00121010107	Nov 28, 2012	1.0 KB
The essential guide of Energy Control and Safety	PA00121010108	Nov 28, 2012	1.0 KB
The essential guide of Energy Control and Safety	PA00121010109	Nov 28, 2012	1.0 KB
The essential guide of Energy Control and Safety	PA00121010110	Nov 28, 2012	1.0 KB

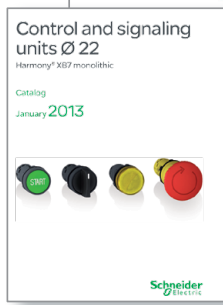

**Essential guides**



**Certificates**

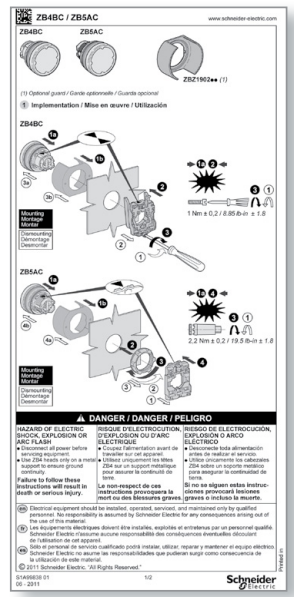

**Technical publications**



**Dynamic catalogues**



# Compare, select, and compile



Path: [www.schneider-electric.com](http://www.schneider-electric.com) > **Products and Services** > Automation and control > ... > Harmony XB4\*

Compare technical characteristics

Select and store your products into the basket

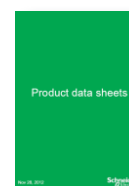

Compile all data sheets in a unique document

\* Example of research on a product

# Check the product status, design your equipment



Path: [www.schneider-electric.com](http://www.schneider-electric.com) > **Support** > Product Substitution Tool  
 Path: [www.schneider-electric.com](http://www.schneider-electric.com) > **Support** > CAD files

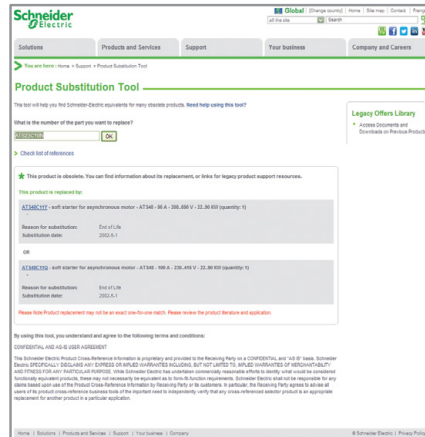
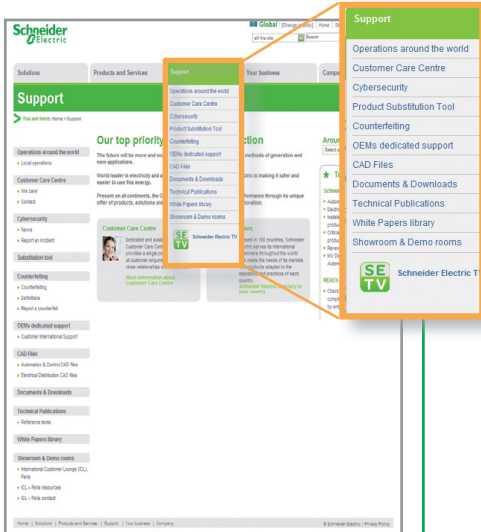

**Product status:**  
 indicate whether the product is still commercialized. Otherwise, the tool suggests a product substitution.

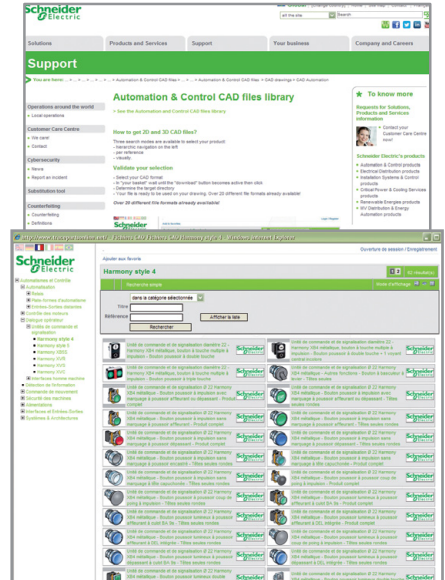

**CAD files:**  
 available in various formats they will be easily integrated into your installation design software.

Please note that all references to products and services are just examples.

<b>D</b>									
		XACA2054	2/2	XACB281	3/14	XACB9121	3/22	XACD950	2/7
DL1CB006	3/9 3/25	XACA2074	2/3	XACB0415	3/17	XACB9122	3/22	XACD951	2/7
DL1CE012	3/9 3/25	XACA2114	2/2	XACB481	3/14	XACB9123	3/22	XACD952	2/7
DL1CE024	3/9 3/25	XACA2154	2/2	XACB491	3/15	XACB9124	3/22	XACF0010	3/32
DL1CE048	3/9 3/25	XACA2174	2/3	XACB493	3/15	XACB9125	3/22	XACF0011	3/32
DL1CE130	3/9 3/25	XACA2714	3/2	XACB0615	3/17	XACB9126	3/22	XACF0050	3/32
DL1CF110	3/9 3/25	XACA2814	3/2	XACB681	3/14	XACB9129	3/22	XACF0051	3/32
DL1CF220	3/9 3/25	XACA2914	3/4	XACB691	3/16	XACB9211	3/22	XACS101	3/7
DL1CF380	3/9 3/25	XACA4714	3/2	XACB693	3/16	XACB9212	3/22	XACS102	3/7
		XACA4814	3/2	XACB0815	3/17	XACB9213	3/22	XACS103	3/7
		XACA4914	3/4	XACB881	3/14	XACB9214	3/22	XACS104	3/7
		XACA4924	3/4	XACB901	3/25	XACB9215	3/22	XACS105	3/7
		XACA6714	3/3	XACB902	3/25	XACB9216	3/22	XACS399	3/21
		XACA6814	3/3	XACB903	3/25	XACB9219	3/22	XACS411	3/20
		XACA9411	3/8	XACB904	3/25	XACB9221	3/22	XACS412	3/20
		XACA9412	3/8	XACB905	3/25	XACB9222	3/22	XACS413	3/20
		XACA9413	3/8	XACB906	3/25	XACB9223	3/22	XACS414	3/20
		XACA9414	3/8	XACB909	3/25	XACB9224	3/22	XACS415	3/20
		XACA9415	3/8	XACB911	3/25	XACB9225	3/22	XACS499	3/21
		XACA9416	3/8	XACB912	3/25	XACB9226	3/22	XACS3991	3/21
		XACA9419	3/8	XACB913	3/26	XACB9229	3/22	XACS4111	3/20
		XACA27141	3/2	XACB921	3/25	XACB12015	3/17	XACS4121	3/20
		XACA28141	3/2	XACB922	3/25	XACD021	2/6	XACS4131	3/20
		XACA29141	3/4	XACB960	3/26	XACD21A0101	2/4	XACS4141	3/20
		XACA47141	3/2	XACB961	3/9 3/26	XACD21A0105	2/4	XACS4151	3/20
		XACA48141	3/2	XACB965	3/26	XACD21A1231	2/4	XACV06	3/20
		XACA49141	3/4	XACB971	3/26	XACD21A1241	2/4	XACV07	3/20
		XACA49241	3/4	XACB972	3/26	XACD21P2111	2/5	XACX1	3/24 3/26
		XACA67141	3/3	XACB972	3/26	XACD21P2121	2/5	XACX905	3/26
		XACA68141	3/3	XACB982	3/26	XACD21P2231	2/5	XACY3970	3/29
		XACB02	3/17	XACB1201	3/17	XACD21P2241	2/5	XACY3971	3/29
		XACB04	3/17	XACB1205	3/17	XACD21P3111	2/5	XACY3972	3/29
		XACB06	3/17	XACB1215	3/17	XACD21P3121	2/5	XACY3973	3/29
		XACB08	3/17	XACB3195	3/15	XACD21P3231	2/5	XACY4970	3/29
		XACB12	3/17	XACB3205	3/15	XACD21P3241	2/5	XACY4971	3/29
		XACB020	3/17	XACB3295	3/16	XACD022	2/6	XACY4972	3/29
		XACB021	3/17	XACB4915	3/15	XACD24A0101	2/4	XACY4973	3/29
		XACB025	3/17	XACB4916	3/15	XACD24A0105	2/4	XBFX13	3/9 3/26
		XACB030	3/17	XACB4935	3/15	XACD24A1231	2/4	XEAB15361	3/24
		XACB041	3/17	XACB4936	3/15	XACD24A1241	2/4	XEAB25361	3/24
		XACB045	3/17	XACB6915	3/16	XACD24P2121	2/5	XEAC15361	3/24
		XACB061	3/17	XACB6916	3/16	XACD24P2231	2/5	XEAC25361	3/24
		XACB065	3/17	XACB6935	3/16	XACD24P3111	2/5	XEDS1231	2/6
		XACB081	3/17	XACB6936	3/16	XACD24P3121	2/5	XEDS1241	2/6
		XACB085	3/17	XACB9111	3/22 3/24	XACD24P3231	2/5	XEDS2111	2/6
		XACB120	3/17	XACB9112	3/22 3/24	XACD24P3241	2/5	XEDS2121	2/6
		XACB121	3/17	XACB9113	3/22	XACD901	2/7	XEDS2231	2/6
		XACB125	3/17	XACB9114	3/22	XACD902	2/7	XEDS2241	2/6
		XACB0215	3/17	XACB9115	3/22	XACD905	2/7	XEDS3111	2/6
		XACB219	3/15	XACB9116	3/22	XACD911	2/7	XEDS3121	2/6
		XACB220	3/15	XACB9119	3/22	XACD912	2/7	XEDS3231	2/6
		XACB229	3/16			XACD913	2/7		

XEDS3241	2/6	ZA2BG6	2/7 3/8	ZB2BY2106	3/11 3/28	ZB2BY2912	3/10 3/27	ZB2BY4951	3/27
XENB1181	3/18		3/23	ZB2BY2107	3/11 3/28	ZB2BY2916	3/10 3/27	ZB2BY4952	3/27
XENB1191	3/18	ZA2BP2	3/22	ZB2BY2108	3/11 3/28	ZB2BY2917	3/10 3/27	ZB2BY4953	3/27
XENB1491	3/18	ZA2BP3	3/22	ZB2BY2109	3/11 3/28	ZB2BY2918	3/10 3/27	ZB2BY4963	3/27
XENC1111	3/18	ZA2BP4	3/22	ZB2BY2110	3/11 3/28	ZB2BY2922	3/10 3/27	ZB2BY4964	3/27
XENC1121	3/18	ZA2BP5	3/22	ZB2BY2111	3/11 3/28	ZB2BY2923	3/10 3/27	ZB2BY4965	3/27
XENC1131	3/18	ZA2BP6	3/22	ZB2BY2112	3/11 3/28	ZB2BY2924	3/10 3/27	ZB2BY4980	3/27
XENC1141	3/18	ZA2BS14	3/23	ZB2BY2125	3/11 3/28	ZB2BY2931	3/10 3/27	ZB2BY4982	3/27
XENC1151	3/18	ZA2BS834	2/7 3/8	ZB2BY2126	3/11 3/28	ZB2BY2954	3/27	ZB2BY4985	3/27
XEND1611	3/18		3/23	ZB2BY2127	3/11 3/28	ZB2BY2955	3/27	ZB2S23	2/7 3/9 3/26
XEND1621	3/18	ZA2BS844	3/8 3/23	ZB2BY2128	3/11 3/28	ZB2BY2956	3/27		
XEND1631	3/19			ZB2BY2166	3/11 3/28	ZB2BY2966	3/27		
XEND1641	3/19	ZA2BS934	2/7 3/8	ZB2BY2167	3/11 3/28	ZB2BY2967	3/27		
XEND2251	3/21		3/23	ZB2BY2167	3/11 3/28	ZB2BY2968	3/27		
XEND2611	3/18	ZA2BS944	3/8 3/23	ZB2BY2303	3/11 3/28	ZB2BY4001	3/11 3/28		
XEND2621	3/18			ZB2BY2304	3/11 3/28	ZB2BY4005	3/11 3/28		
XEND2631	3/19	ZA2BV01	3/9 3/23	ZB2BY2305	3/11 3/28	ZB2BY4101	3/11 3/28		
XEND2641	3/19			ZB2BY2306	3/11 3/28	ZB2BY4901	3/10 3/27		
XEND3801	3/19	ZA2BV03	3/9 3/23	ZB2BY2307	3/11 3/28	ZB2BY4902	3/10 3/27		
XEND3811	3/19			ZB2BY2308	3/11 3/28	ZB2BY4903	3/10 3/27		
XEND4801	3/19	ZA2BV04	3/9 3/23	ZB2BY2309	3/11 3/28	ZB2BY4907	3/10 3/27		
XEND4811	3/19	ZA2BV05	3/9 3/23	ZB2BY2310	3/11 3/28	ZB2BY4908	3/10 3/27		
XENG1191	3/6			ZB2BY2311	3/11 3/28	ZB2BY4909	3/10 3/27		
XENG1491	3/6	ZA2BV06	3/9 3/23	ZB2BY2312	3/11 3/28	ZB2BY4913	3/10 3/27		
XENG3781	3/6			ZB2BY2326	3/11 3/28	ZB2BY4914	3/10 3/27		
XENG3791	3/6	ZA2BV07	3/9 3/23	ZB2BY2327	3/11 3/28	ZB2BY4915	3/10 3/27		
XENT1192	3/6			ZB2BY2328	3/11 3/28	ZB2BY4919	3/10 3/27		
XENT1991	2/6	ZA2BV033	3/9 3/23	ZB2BY2367	3/11 3/28	ZB2BY4920	3/10 3/27		
XESB2011	3/19			ZB2BY2904	3/10 3/27	ZB2BY4921	3/10 3/27		
XESD1181	3/19	ZA2BV043	3/9 3/23	ZB2BY2905	3/10 3/27	ZB2BY4930	3/10 3/27		
XESD1191	3/21			ZB2BY2906	3/10 3/27	ZB2BY4932	3/10 3/27		
XESD1281	3/19	ZA2BV053	3/9 3/23	ZB2BY2910	3/10 3/27	ZB2BY4933	3/10 3/27		
XESD1291	3/21			ZB2BY2911	3/10 3/27	ZB2BY4934	3/10 3/27		
XESD2201	3/21	ZA2BV073	3/9 3/23			ZB2BY4935	3/10 3/27		
XESD2241	3/21								
		ZA2BZ905	2/7 3/9						
			3/24						
		ZB2BE101	2/3 2/6 3/6						
		ZB2BE102	2/3 2/6 3/6						
		ZB2BE201	2/3						
		ZB2BV006	3/7						
		ZB2BV007	3/7						
		ZB2BY2002	3/11 3/28						
		ZB2BY2004	3/11 3/28						
		ZB2BY2101	3/11 3/28						
		ZB2BY2103	3/11 3/28						
		ZB2BY2104	3/11 3/28						
		ZB2BY2105	3/11 3/28						

Z

ZA2BB2	3/8 3/23
ZA2BB4	3/8 3/23
ZA2BD2	2/7 3/8 3/23
ZA2BD3	3/8 3/23
ZA2BG2	2/7 3/8 3/23
ZA2BG3	2/7 3/8 3/23
ZA2BG4	2/7 3/8 3/23
ZA2BG5	2/7 3/8 3/23



**Schneider Electric Industries SAS**

Head Office  
35, rue Joseph Monier  
F-92500 Rueil-Malmaison  
France

[www.schneider-electric.com/control](http://www.schneider-electric.com/control)

The information provided in this documentation contains general descriptions and/or technical characteristics of the performance of the products contained herein. This documentation is not intended as a substitute for and is not to be used for determining suitability or reliability of these products for specific user applications. It is the duty of any such user or integrator to perform the appropriate and complete risk analysis, evaluation and testing of the products with respect to the relevant specific application or use thereof. Neither Schneider Electric nor any of its affiliates or subsidiaries shall be responsible or liable for misuse of the information contained herein.

Design: Schneider Electric  
Photos: Schneider Electric  
Printed by:

DIA5ED2130507EN

## X-ON Electronics

Largest Supplier of Electrical and Electronic Components

*Click to view similar products for [Switch Contact Blocks / Switch Kits](#) category:*

*Click to view products by [Schneider](#) manufacturer:*

Other Similar products are found below :

[61-8770.17](#) [M2SA-7010](#) [704.905.2](#) [704.915.5](#) [704.918.5](#) [84-8512.2320](#) [84-8515.8640](#) [A01RTC8](#) [A02504](#) [A02512](#) [A3KJ-7010](#) [BS001](#) [190-17504-003](#) [190-17505-001](#) [190-17508-001](#) [190-17509-002](#) [190-17509-006](#) [A02506](#) [190-17501-001](#) [190-17506-001](#) [190-17509-003](#) [190-17509-005](#) [GLZ304](#) [31-942](#) [51401](#) [BST-D](#) [HW-S01](#) [XESP2021](#) [61-8480.22](#) [61-8650.17](#) [704.908.1](#) [704.908.5](#) [704.915.3](#) [HA-C2V](#) [S4](#) [704.918.4](#) [84-8511.5320](#) [A3CA-7121](#) [704.902.1](#) [A0310Y](#) [51-971.F22](#) [5.05.510.632/0000](#) [190-17502-003](#) [190-17507-002](#) [190-17500-002](#) [190-17500-006](#) [190-17510-001](#) [1.20.119.002/0000](#) [2MN6-1PA224](#) [Kit05-Keylocks](#)