

Product data sheet

Specifications



inductive sensor XS2 M30, L63mm, brass, Sn15mm, 12..24 VDC, cable 2m

XS2M30KP340

Main

Range of product	Telemecanique Inductive proximity sensors XS
Series name	General purpose
Sensor type	Inductive proximity sensor
Sensor name	XS2
Sensor design	Cylindrical M30
Size	66 mm
Body type	Fixed
Detector flush mounting acceptance	Non flush mountable
Material	Metal
Type of output signal	Discrete
Wiring technique	4-wire
[Sn] nominal sensing distance	15 mm
Discrete output function	1 NO or 1 NC programmable
Output circuit type	DC
Discrete output type	PNP and NPN
Electrical connection	Cable
Cable length	2 m
[Us] rated supply voltage	12...24 V DC with reverse polarity protection
Switching capacity in mA	<= 200 mA with overload and short-circuit protection
IP degree of protection	IP68 double insulation conforming to IEC 60529

Complementary

Thread type	M30 x 1.5
Detection face	Frontal
Front material	PPS
Enclosure material	Nickel plated brass
Operating zone	0...12 mm
Differential travel	1...15% of Sr

Cable composition	4 x 0.22 mm ²
Wire insulation material	PvR
Status LED	Output state: 1 LED (yellow)
Supply voltage limits	10...36 V DC
Switching frequency	<= 1000 Hz
Maximum voltage drop	<2.6 V (closed)
Current consumption	0...10 mA no-load
Maximum delay first up	5 ms
Maximum delay response	0.3 ms
Maximum delay recovery	0.7 ms
Marking	CE
Threaded length	41 mm
Length	66 mm
Net weight	0.205 kg

Environment

Product certifications	UL CSA
Ambient air temperature for operation	-25...70 °C
Ambient air temperature for storage	-40...85 °C
Vibration resistance	25 gn amplitude = +/- 2 mm (f = 10...55 Hz) conforming to IEC 60068-2-6
Shock resistance	50 gn for 11 ms conforming to IEC 60068-2-27

Packing Units

Unit Type of Package 1	Db
Number of Units in Package 1	1
Package 1 Height	4.1 cm
Package 1 Width	9.6 cm
Package 1 Length	13.2 cm
Package 1 Weight	190.0 g
Unit Type of Package 2	S02
Number of Units in Package 2	12
Package 2 Height	15 cm
Package 2 Width	30 cm
Package 2 Length	40 cm
Package 2 Weight	2.619 kg

Offer Sustainability

Sustainable offer status	Green Premium product
REACH Regulation	REACH Declaration
EU RoHS Directive	Pro-active compliance (Product out of EU RoHS legal scope) EU RoHS Declaration
Mercury free	Yes

RoHS exemption information	Yes
Environmental Disclosure	Product Environmental Profile
Circularity Profile	End of Life Information
California proposition 65	WARNING: This product can expose you to chemicals including: Diisononyl phthalate (DINP), which is known to the State of California to cause cancer, and Di-isodecyl phthalate (DIDP), which is known to the State of California to cause birth defects or other reproductive harm. For more information go to www.P65Warnings.ca.gov

Contractual warranty

Warranty	18 months
-----------------	-----------

Dimensions

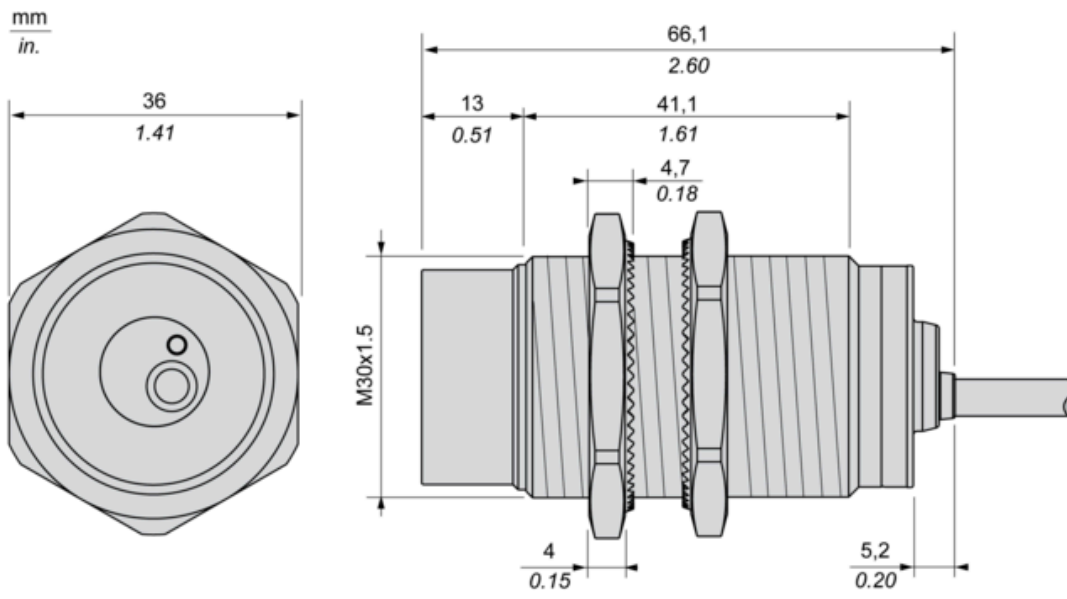

Minimum Mounting Distances

Side by side

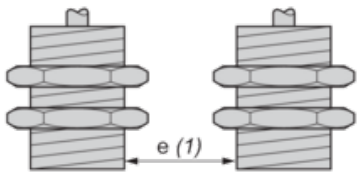

$e (1) \geq 60 \text{ mm}/2.36 \text{ in.}$

Face to face

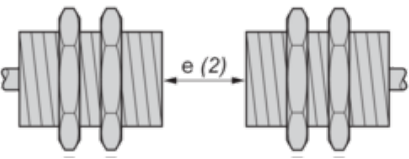

$e (2) \geq 180 \text{ mm}/7.09 \text{ in.}$

Facing a metal object

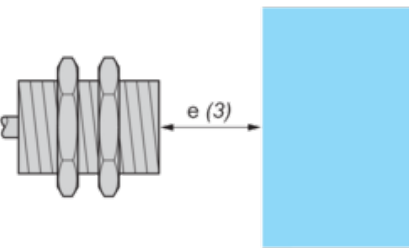

$e (3) \geq 45 \text{ mm}/1.77 \text{ in.}$

Mounted in a metal support

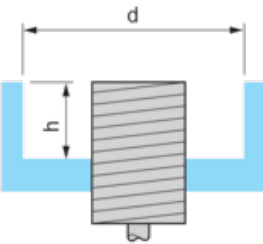

$d \geq 90 \text{ mm}/3.54 \text{ in.}$

$h \geq 30 \text{ mm}/1.18 \text{ in.}$

Wiring Schemes

4-Wire DC, PNP/NPN, NO or NC Output

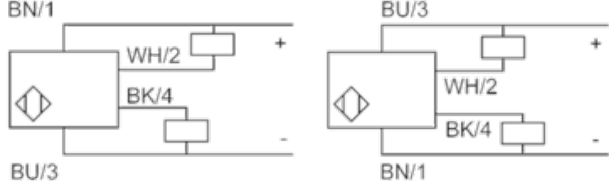

- BU** : Blue
- BN** : Brown
- BK** : Black
- WH** : White

Performance Curves

Standard Steel Target : 45x45x1 mm

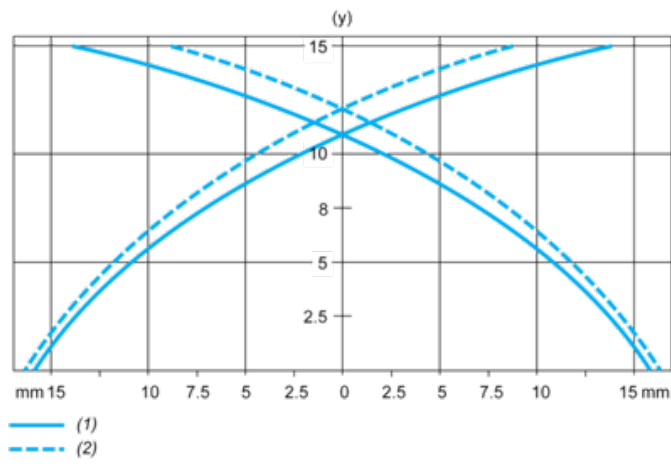

- (1) Pick-up points
- (2) Drop-out points (object approaching from the side)
- (y) Sensing distance in mm

Recommended replacement(s)

X-ON Electronics

Largest Supplier of Electrical and Electronic Components

Click to view similar products for [Proximity Sensors](#) category:

Click to view products by [Schneider](#) manufacturer:

Other Similar products are found below :

[70.340.1028.0](#) [70.360.2428.0](#) [8027AL20NL2CPXX](#) [9221350022](#) [922AA2W-A9P-L](#) [GL-12F-C2.5X10\(LOT3\)](#) [972AB3XM-A3P-L](#) [PS3251](#)
[980659-1](#) [E2E2-X5M41-M4](#) [E2E-X14MD1-G](#) [E2E-X2D1-G](#) [E2E-X4MD1-G](#) [E2E-X5E1-5M-N](#) [E2E-X5Y2-N](#) [EH-302](#) [EI3010TBOP](#)
[MS605AU](#) [EP175-32000](#) [IC08ANC15PO-K](#) [IFRM04P1513/S35L](#) [IFRM06P1703/S35L](#) [IFRM08P1501/S35L](#) [IFRM12N17G3/L](#)
[IFRM12P3502/L](#) [IFRM12P37G1/S14L](#) [ILFK12E9189/I02](#) [ILFK12E9193/I02](#) [OISN-013](#) [25.332.0653.1](#) [25.352.0653.0](#) [25.352.0753.0](#)
[25.523.3253.0](#) [9151710023](#) [922AA1HI-A4P-L](#) [922AA2XM-B9P-L](#) [922FS0.8-H4P-G-020](#) [922FS1.5C-A4P-Z774](#) [SC606ABV0S30](#)
[SM552A100](#) [SM851A1200FP](#) [F3S-A162-U](#) [GL-12F-C2X10\(LOT10\)](#) [GL-8HIBX10](#) [QT-08L](#) [RDS-DIN3-PA-D1](#) [34.110.0010.0](#) [3U02](#) [TL-](#)
[C2MF1-M3-E4](#) [TLX5C1GE](#)