

XS4P18AB110

inductive sensor XS4 M18 - L41mm - PBT - Sn8mm - 24..48VDC - cable 2m



Product availability: Stock - Normally stocked in distribution facility



Main

Range of product	OsiSense XS
Series name	Application
Sensor type	Inductive proximity sensor
Device application	-
Sensor name	XS4
Sensor design	Cylindrical M18
Size	41 mm
Body type	Fixed
Detector flush mounting acceptance	Non flush mountable
Material	Plastic
Type of output signal	Analogue
Wiring technique	3-wire
[Sn] nominal sensing distance	0.31 in (8 mm)
Discrete output function	1 NC
Output circuit type	DC
Analogue output range	0...10 V
Electrical connection	Cable
Cable length	6.56 ft (2 m)
[Us] rated supply voltage	24...48 V DC
IP degree of protection	IP67 conforming to IEC 60529

Complementary

Thread type	M18 x 1
Detection face	Frontal
Front material	PPS
Enclosure material	PBT
Operating zone	0.03...0.31 in (0.8...8 mm)
Repeat accuracy	<= 3% of Sr
Linearity error	+/- 2 mA
Cable composition	3 x 0.34 mm ²
Wire insulation material	PvR
Supply voltage limits	15...58 V DC
Switching frequency	<= 500 Hz
Current consumption	4 mA (no-load)
Output current drift	<= 10 %
Marking	CE
Threaded length	1.02 in (26 mm)
Height	0.71 in (18 mm)
Length	1.61 in (41 mm)
Product weight	0.18 lb(US) (0.08 kg)

The information provided in this documentation contains general descriptions and/or technical characteristics of the performance of the products contained herein. This documentation is not intended as a substitute for and is not to be used for determining suitability or reliability of these products for specific user applications. It is the duty of any such user or integrator to perform the appropriate and complete risk analysis, evaluation and testing of the products with respect to the relevant specific application or use thereof. Neither Schneider Electric Industries SAS nor any of its affiliates or subsidiaries shall be responsible or liable for misuse of the information contained herein.

Environment

Product certifications	UL CCC CSA
Ambient air temperature for operation	-13...158 °F (-25...70 °C)

Ordering and shipping details

Category	22486 - SENSORS, PROXIMITY
Discount Schedule	DS2
GTIN	00785901721833
Nbr. of units in pkg.	1
Package weight(Lbs)	0.20999999999999999
Returnability	Y
Country of origin	FR

Offer Sustainability

Sustainable offer status	Green Premium product
RoHS (date code: YYWW)	Compliant - since 0812 - Schneider Electric declaration of conformity  Schneider Electric declaration of conformity
REACH	Reference not containing SVHC above the threshold
Product environmental profile	Available
Product end of life instructions	Available
California proposition 65	WARNING: This product can expose you to chemicals including:
----- Substance 1	Diisononyl phthalate (DINP), which is known to the State of California to cause cancer, and
----- Substance 2	Di-isodecyl phthalate (DIDP), which is known to the State of California to cause birth defects or other reproductive harm.
----- More information	For more information go to www.p65warnings.ca.gov

Contractual warranty

Warranty period	18 months
-----------------	-----------

Dimensions

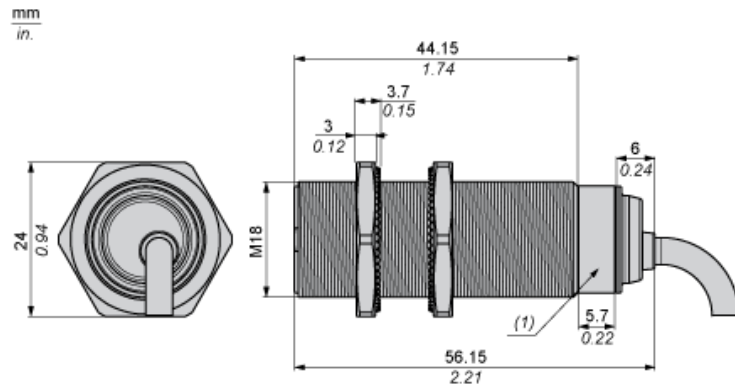

(1) LED

Minimum Mounting Distances

Side by side

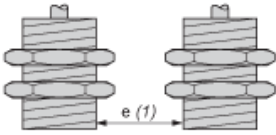

e (1) 32 mm/1.26 in.

≥

Face to face



e (2) 96 mm/3.78 in.

≥

Facing a metal object



e (3) 24 mm/0.94 in.

≥

Mounted in a metal support

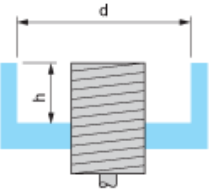

d ≥ 56 mm/2.20 in.

h ≥ 16 mm/0.63 in.

Mounting

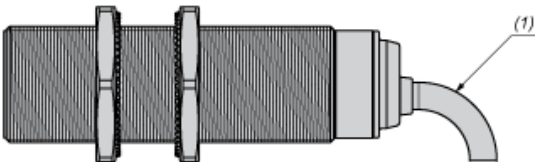

(1) Bending cable: 4 x external cable diameter

Wiring Schemes

3-Wire connection

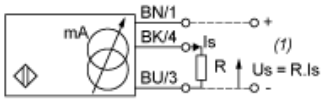

(1) Voltage output

BN : Brown

BK : Black

BU : Blue

	Output current	Load impedance value	Output voltage	Load impedance value
24 V	0...10 mA	$R \leq 1500 \Omega$	0...10 V	$R = 1000 \Omega$
48 V	0...10 mA	$R \leq 3300 \Omega$	0...10 V	$R = 1000 \Omega$

Output Curves

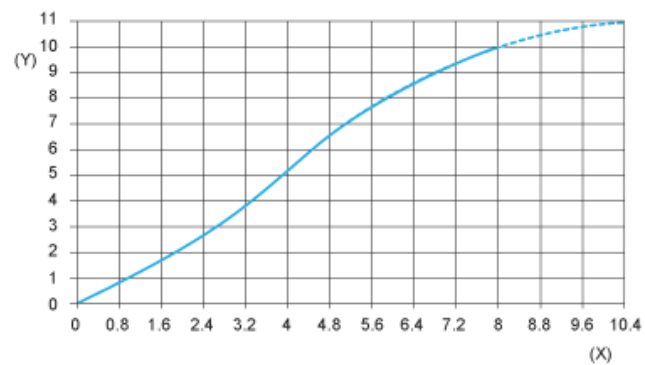

(Y) Is (V)

(X) Sensors - object distance (mm)

X-ON Electronics

Largest Supplier of Electrical and Electronic Components

Click to view similar products for [Proximity Sensors](#) category:

Click to view products by [Schneider](#) manufacturer:

Other Similar products are found below :

[01.001.5653.1](#) [70.340.1028.0](#) [70.360.2428.0](#) [70.364.4828.0](#) [70.810.1053.0](#) [72.360.1628.0](#) [73.363.6428.0](#) [8027AL20NL2CPXX](#) [FYCC8E1-2](#)
[9221350022](#) [922AA2W-A9P-L](#) [PLS2](#) [GL-12F-C2.5X10\(LOT3\)](#) [972AB2XM-A3N-L](#) [972AB3XM-A3P-L](#) [PS3251](#) [980659-1](#) [QT-12](#) [E2E2-](#)
[X5M41-M4](#) [E2E-X14MD1-G](#) [E2E-X2D1-G](#) [E2EX2ME2N](#) [E2EX3D1SM1N](#) [E2E-X4MD1-G](#) [E2E-X5E1-5M-N](#) [E2E-X5Y2-N](#) [E2E-X7D1-](#)
[M1J-T-0.3M-N](#) [E2FMX1R5D12M](#) [E2K-F10MC1](#) [5M](#) [EH-302](#) [EI3010TBOP](#) [EI5515NPAP](#) [MS605AU](#) [EP175-32000](#) [IFRM04N35B1/L](#)
[IFRM04P1513/S35L](#) [IFRM06P1703/S35L](#) [IFRM08P1501/S35L](#) [IFRM12N17G3/L](#) [IFRM12P17G3/L](#) [IFRM12P3502/L](#) [IFRM12P37G1/S14L](#)
[ILFK12E9189/I02](#) [ILFK12E9193/I02](#) [IMM2582C](#) [OISN-013](#) [25.161.3253.0](#) [25.332.0653.1](#) [25.352.0653.0](#) [25.352.0753.0](#)