

Product data sheet

Specifications



Inductive proximity sensors XS, inductive sensor XS4 M18, L60mm, PPS, Sn8mm, 12...24 VDC, cable 5 m

XS4P18KP340L1

Main

Range of product	Telemecanique Inductive proximity sensors XS
Series name	General purpose
Sensor type	Inductive proximity sensor
Sensor name	XS4
Sensor design	Cylindrical M18
Size	60 mm
Body type	Fixed
Detector flush mounting acceptance	Non flush mountable
Material	Plastic
Type of output signal	Discrete
Wiring technique	4-wire
[Sn] nominal sensing distance	8 mm
Discrete output function	1 NO or 1 NC programmable
Output circuit type	DC
Discrete output type	PNP and NPN
Electrical connection	Cable
Cable length	5 m
[Us] rated supply voltage	12...24 V DC with reverse polarity protection
Switching capacity in mA	<= 200 mA with overload and short-circuit protection
IP degree of protection	IP68 double insulation conforming to IEC 60529

Complementary

Thread type	M18 x 1
Detection face	Frontal
Front material	PPS
Enclosure material	PPS
Operating zone	0...6.4 mm
Differential travel	1...15% of Sr

Cable composition	4 x 0.34 mm ²
Wire insulation material	PvR
Status LED	Output state: 1 LED (yellow)
Supply voltage limits	10...36 V DC
Switching frequency	<= 2000 Hz
Maximum voltage drop	<2.6 V (closed)
Current consumption	0...10 mA no-load
Maximum delay first up	5 ms
Maximum delay response	0.15 ms
Maximum delay recovery	0.35 ms
Marking	CE
Threaded length	51 mm
Height	18 mm
Length	60 mm
Net weight	0.22 kg

Environment

Product certifications	UL CSA
Ambient air temperature for operation	-25...70 °C
Ambient air temperature for storage	-40...85 °C
Vibration resistance	25 gn amplitude = +/- 2 mm (f = 10...55 Hz) conforming to IEC 60068-2-6
Shock resistance	50 gn for 11 ms conforming to IEC 60068-2-27

Packing Units

Unit Type of Package 1	Db
Number of Units in Package 1	1
Package 1 Height	4.7 cm
Package 1 Width	20.4 cm
Package 1 Length	14.8 cm
Package 1 Weight	172.0 g
Unit Type of Package 2	S02
Number of Units in Package 2	14
Package 2 Height	15.0 cm
Package 2 Width	30.0 cm
Package 2 Length	40.0 cm
Package 2 Weight	2.716 kg

Offer Sustainability

Sustainable offer status	Green Premium product
REACH Regulation	REACH Declaration
EU RoHS Directive	Pro-active compliance (Product out of EU RoHS legal scope) EU RoHS Declaration

Mercury free	Yes
RoHS exemption information	Yes
Environmental Disclosure	Product Environmental Profile
Circularity Profile	End of Life Information
California proposition 65	WARNING: This product can expose you to chemicals including: Diisononyl phthalate (DINP), which is known to the State of California to cause cancer, and Di-isodecyl phthalate (DIDP), which is known to the State of California to cause birth defects or other reproductive harm. For more information go to www.P65Warnings.ca.gov

Contractual warranty

Warranty	18 months
-----------------	-----------

Dimensions

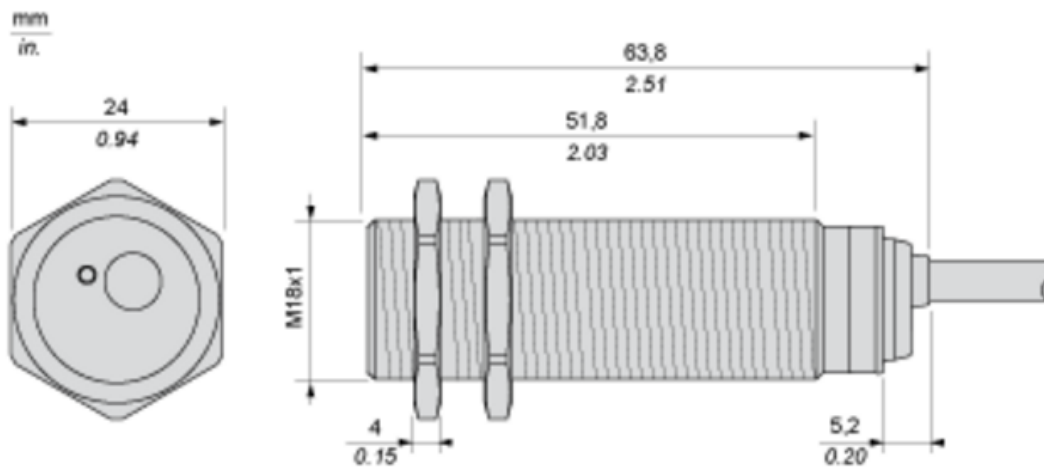

Minimum Mounting Distances

Side by side



$e (1) \geq 32 \text{ mm}/1.26 \text{ in.}$

Face to face

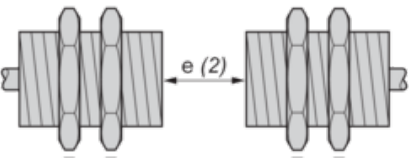

$e (2) \geq 96 \text{ mm}/3.78 \text{ in.}$

Facing a metal object

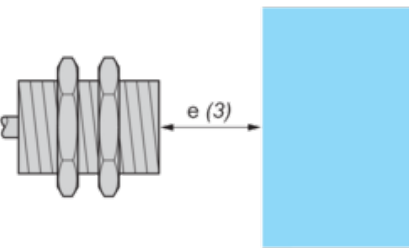

$e (3) \geq 24 \text{ mm}/0.94 \text{ in.}$

Mounted in a metal support

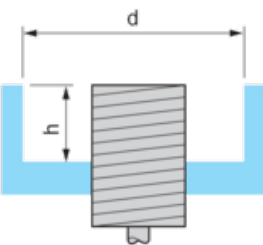

$d \geq 56 \text{ mm}/2.20 \text{ in.}$

$h \geq 16 \text{ mm}/0.63 \text{ in.}$

Mounting

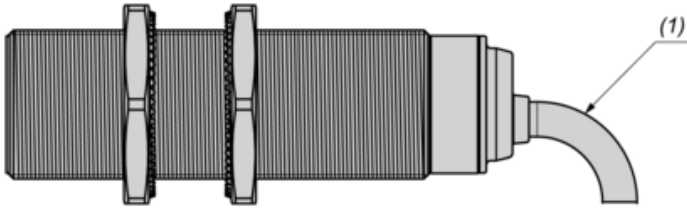

(1) Bending cable: 4 x external cable diameter

Wiring Schemes

4-Wire DC, PNP/NPN, NO or NC Output

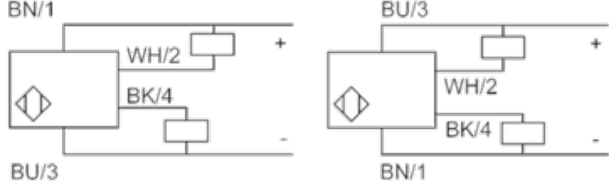

- BU** : Blue
- BN** : Brown
- BK** : Black
- WH** : White

Performance Curves

Standard Steel Target : 24x24x1 mm

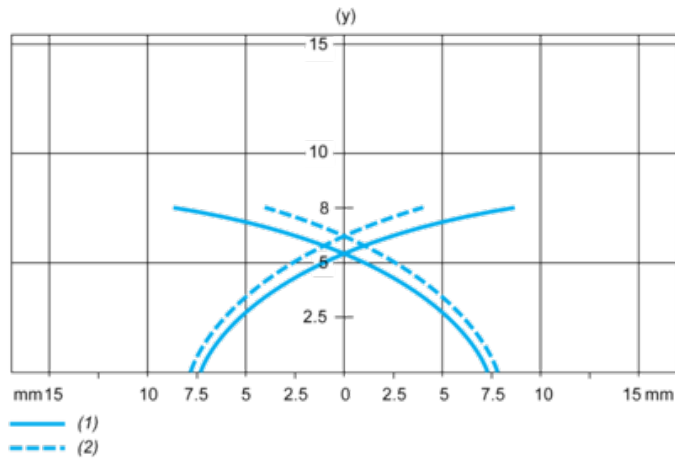

- (1) Pick-up points
- (2) Drop-out points (object approaching from the side)
- (y) Sensing distance in mm

Recommended replacement(s)

X-ON Electronics

Largest Supplier of Electrical and Electronic Components

Click to view similar products for [Proximity Sensors](#) category:

Click to view products by [Schneider](#) manufacturer:

Other Similar products are found below :

[70.340.1028.0](#) [70.360.2428.0](#) [8027AL20NL2CPXX](#) [9221350022](#) [922AA2W-A9P-L](#) [GL-12F-C2.5X10\(LOT3\)](#) [972AB3XM-A3P-L](#) [PS3251](#)
[980659-1](#) [E2E2-X5M41-M4](#) [E2E-X14MD1-G](#) [E2E-X2D1-G](#) [E2E-X4MD1-G](#) [E2E-X5E1-5M-N](#) [E2E-X5Y2-N](#) [EH-302](#) [EI3010TBOP](#)
[MS605AU](#) [EP175-32000](#) [IC08ANC15PO-K](#) [IFRM04P1513/S35L](#) [IFRM06P1703/S35L](#) [IFRM08P1501/S35L](#) [IFRM12N17G3/L](#)
[IFRM12P3502/L](#) [IFRM12P37G1/S14L](#) [ILFK12E9189/I02](#) [ILFK12E9193/I02](#) [OISN-013](#) [25.332.0653.1](#) [25.352.0653.0](#) [25.352.0753.0](#)
[25.523.3253.0](#) [9151710023](#) [922AA1HI-A4P-L](#) [922AA2XM-B9P-L](#) [922FS0.8-H4P-G-020](#) [922FS1.5C-A4P-Z774](#) [SC606ABV0S30](#)
[SM552A100](#) [SM851A1200FP](#) [F3S-A162-U](#) [GL-12F-C2X10\(LOT10\)](#) [GL-8HIBX10](#) [QT-08L](#) [RDS-DIN3-PA-D1](#) [34.110.0010.0](#) [3U02](#) [TL-](#)
[C2MF1-M3-E4](#) [TLX5C1GE](#)