

XT130B1FBL2

capacitive sensor - XT1 - cylindrical M30 -
brass - Sn 10 mm - cable 2 m

Product availability: Stock - Normally stocked in distribution facility



Main

Range of product	OsiSense XT
Sensor type	Capacitive proximity sensor
Product specific application	Detection of insulated or conductive materials
Sensor name	XT1
Sensor design	Cylindrical M30
Size	70 mm
Body type	Fixed
Detector flush mounting acceptance	Flush mountable
Material	Metal
Enclosure material	Nickel plated brass
Type of output signal	Discrete
Wiring technique	2-wire
[Sn] nominal sensing distance	0.39 in (10 mm)
Discrete output function	1 NC
Output circuit type	AC
Electrical connection	Cable
Cable length	6.56 ft (2 m)
[Us] rated supply voltage	24...240 V AC 50...60 Hz
Delay response	<= 20 ms
IP degree of protection	IP67 conforming to IEC 60947-5-2 IP67 conforming to IEC 60529

Complementary

ISO thread	M30 x 1.5
Detection face	Frontal
[Sa] assured operating distance	0...0.28 in (0...7.2 mm)
Adjustment zone	0.08...0.59 in (2...15 mm)
Differential travel	< 0.2 x Sr
Repeat accuracy	< 0.1 x Sr
Wire insulation material	PVC
Status LED	1 LED (yellow) output state indication
Supply voltage limits	20...264 V AC
Residual current	< 5 mA (open state)
Switching frequency	<= 25 Hz
Voltage drop	<= 6 V (closed)
Current consumption	< 3 mA
Delay first up	<= 100 ms
Delay recovery	<= 20 ms
Maximum switching current	330 mA
Marking	CE
Setting-up	Sensitivity by potentiometer
Threaded length	2.17 in (55 mm)
Length	2.76 in (70 mm)
Product weight	0.6 lb(US) (0.27 kg)

Environment

Standards	EN/IEC 60947-5-2
Product certifications	CETLus
Ambient air temperature for operation	-13...158 °F (-25...70 °C)
Vibration resistance	10 gn amplitude = 1 mm (10...55 Hz) conforming to IEC 60068-2-6
Shock resistance	30 gn (duration = 11 ms) conforming to IEC 60068-2-27
Resistance to electrostatic discharge	4 kV (contact) conforming to IEC 61000-4-2 8 kV (air) conforming to IEC 61000-4-2
Resistance to electromagnetic fields	2.74 V/yd (3 V/m) conforming to IEC 61000-4-3
Resistance to fast transients	2 kV conforming to IEC 61000-4-4

Ordering and shipping details

Category	22486 - SENSORS, PROXIMITY
Discount Schedule	DS2
GTIN	00785901631446
Nbr. of units in pkg.	1
Package weight(Lbs)	0.6099999999999999
Returnability	Y
Country of origin	DE

Offer Sustainability

RoHS (date code: YYWW)	Compliant - since 0727 - Schneider Electric declaration of conformity  Schneider Electric declaration of conformity
California proposition 65	WARNING: This product can expose you to chemicals including:
----- Substance 1	Diisononyl phthalate (DINP), which is known to the State of California to cause cancer, and
----- Substance 2	Di-isodecyl phthalate (DIDP), which is known to the State of California to cause birth defects or other reproductive harm.
----- More information	For more information go to www.p65warnings.ca.gov

Contractual warranty

Warranty period	18 months
-----------------	-----------

Dimensions

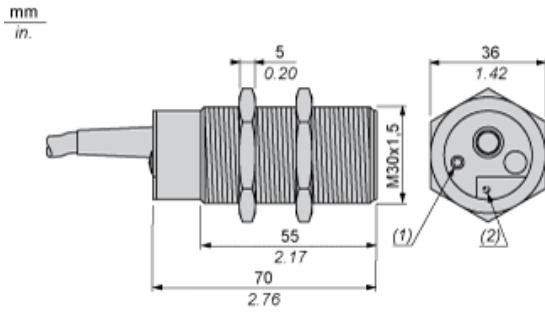

- (1) LED
- (2) Potentiometer beneath protective flap

Setting-up

Minimum Mounting Distances (mm)

Side by side

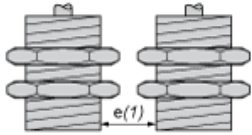

$e(1) \geq 0$

Face to face

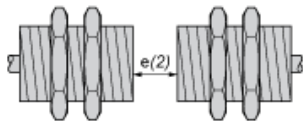

$e(2) \geq 22$

Facing a metal object

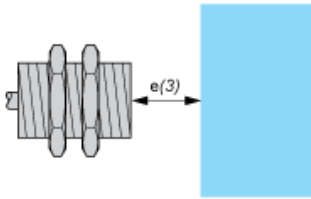

$e(3) \geq 20$

Mounted in support

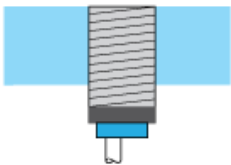

Fixing nut tightening torque: 40 N.m

Adjustment

Sensitivity Adjustment

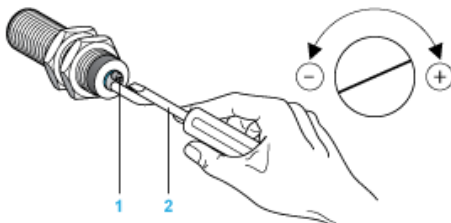

- (1) Adjustment potentiometer
- (2) Screwdriver (included with sensor)

Wiring Diagram

Pre-cabled

2-wire AC NC Output

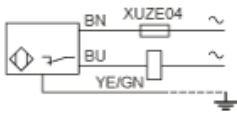

(BU) Blue
(BN) Brown
(YE/ Yellow/Green
GN)

X-ON Electronics

Largest Supplier of Electrical and Electronic Components

Click to view similar products for [Proximity Sensors](#) category:

Click to view products by [Schneider](#) manufacturer:

Other Similar products are found below :

[01.001.5653.1](#) [70.340.1028.0](#) [70.360.2428.0](#) [70.364.4828.0](#) [70.810.1053.0](#) [72.360.1628.0](#) [73.363.6428.0](#) [8027AL20NL2CPXX](#) [FYCC8E1-2](#)
[9221350022](#) [922AA2W-A9P-L](#) [PLS2](#) [GL-12F-C2.5X10\(LOT3\)](#) [972AB2XM-A3N-L](#) [972AB3XM-A3P-L](#) [PS3251](#) [980659-1](#) [QT-12](#) [E2E2-](#)
[X5M41-M4](#) [E2E-X14MD1-G](#) [E2E-X2D1-G](#) [E2EX2ME2N](#) [E2EX3D1SM1N](#) [E2E-X4MD1-G](#) [E2E-X5E1-5M-N](#) [E2E-X5Y2-N](#) [E2E-X7D1-](#)
[M1J-T-0.3M-N](#) [E2FMX1R5D12M](#) [E2K-F10MC1](#) [5M](#) [EH-302](#) [EI3010TBOP](#) [EI5515NPAP](#) [MS605AU](#) [EP175-32000](#) [IFRM04N35B1/L](#)
[IFRM04P1513/S35L](#) [IFRM06P1703/S35L](#) [IFRM08P1501/S35L](#) [IFRM12N17G3/L](#) [IFRM12P17G3/L](#) [IFRM12P3502/L](#) [IFRM12P37G1/S14L](#)
[ILFK12E9189/I02](#) [ILFK12E9193/I02](#) [IMM2582C](#) [OISN-013](#) [25.161.3253.0](#) [25.332.0653.1](#) [25.352.0653.0](#) [25.352.0753.0](#)