

Product data sheet

Specifications



Photoelectric sensors XU, miniature, background suppression, S_{max}=0.30 m, PNP, cable 2 m

XUM8APXBL2

Main

Range of product	Telemecanique Photoelectric sensors XU
Series name	General purpose single mode
Electronic sensor type	Photo-electric sensor
Sensor name	XUM
Sensor design	Miniature
Detection system	Diffuse with background suppression
Material	Plastic
Type of output signal	Discrete
Supply circuit type	DC
Wiring technique	3-wire
Discrete output type	PNP
Discrete output function	1 NO or 1 NC programmable
Electrical connection	Cable
Cable length	2 m
Emission	Red LED diffuse with background suppression
[Sn] nominal sensing distance	0.20 m

Complementary

Enclosure material	PBT
Lens material	PMMA
Maximum sensing distance	0.30 m
Output type	Solid state
Wire insulation material	PVC
Status LED	Stability: 1 LED (green) Output state: 1 LED (orange)
[Us] rated supply voltage	12...24 V DC with reverse polarity protection
Supply voltage limits	10...30 V DC
Switching capacity in mA	<= 100 mA with overload and short-circuit protection
Switching frequency	<= 1000 Hz

Maximum voltage drop	<2 V (closed state)
Current consumption	30 mA no-load
Maximum delay first up	100 ms
Maximum delay response	0.5 ms
Maximum delay recovery	0.5 ms
Setting-up	Sensitivity by potentiometer
Depth	27 mm
Height	33 mm
Width	10 mm
Net weight	0.063 kg

Environment

Product certifications	cULus CE UKCA
Ambient air temperature for operation	-30...55 °C
Ambient air temperature for storage	-40...70 °C
Relative humidity	35...95 %
Immunity to ambient light	40000 lux sunlight 10000 lux incandescent light
Vibration resistance	9 gn, amplitude = +/- 1.5 mm (f = 10...500 Hz) for every axis conforming to IEC 60068-2-6
Shock resistance	100 gn (duration = 11 ms) for every axis conforming to IEC 60068-2-27
IP degree of protection	IP67 conforming to IEC 60529 IP65 conforming to IEC 60529

Packing Units

Unit Type of Package 1	PCE
Number of Units in Package 1	1
Package 1 Weight	50 g
Package 1 Height	13.5 cm
Package 1 width	2 cm
Package 1 Length	21 cm
Unit Type of Package 2	S04
Number of Units in Package 2	160
Package 2 Weight	9.81 kg
Package 2 Height	30 cm
Package 2 width	40 cm
Package 2 Length	60 cm
Package 3 Height	150 cm

Offer Sustainability

REACH Regulation	REACH Declaration
EU RoHS Directive	Pro-active compliance (Product out of EU RoHS legal scope) EU RoHS Declaration
Mercury free	Yes

RoHS exemption information	Yes
China RoHS Regulation	China RoHS declaration
California proposition 65	WARNING: This product can expose you to chemicals including: Diisononyl phthalate (DINP), which is known to the State of California to cause cancer, and Di-isodecyl phthalate (DIDP), which is known to the State of California to cause birth defects or other reproductive harm. For more information go to www.P65Warnings.ca.gov

Contractual warranty

Warranty	18 months
-----------------	-----------

Dimensions

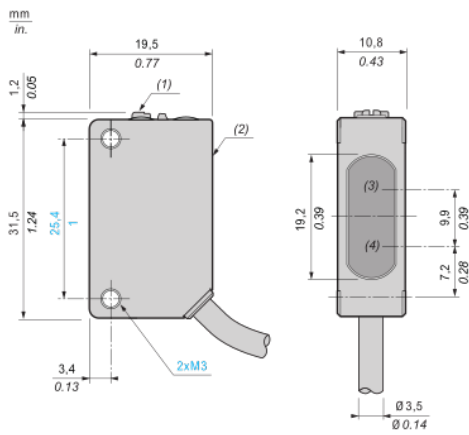

- (1) : Setting potentiometer (sensitivity)
- (2) : Setting potentiometer (output)
- (3) : Reception
- (4) : Transmission

Connection and schema

Wiring diagram

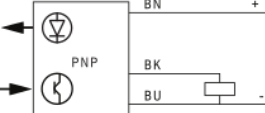

- BN (Brown) : (+)**
- BK (Black) : OUT/Output**
- BU (Blue) : (-)**

Detection curves

Lateral displacement (preset 100 mm)

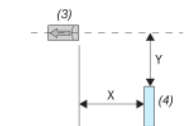
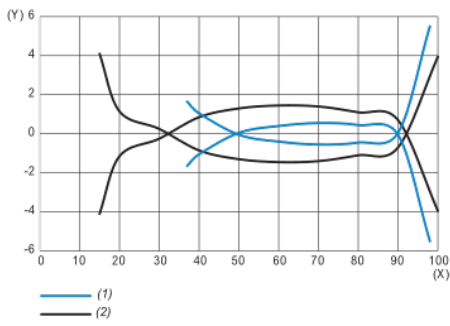

- (1) : Black paper 6 % remission
- (2) : White paper 90 % remission
- (3) : Sensor
- (4) : Object (200 mm square white and black mat paper)
- (X) : Sensing distance (mm)
- (Y) : Lateral displacement (mm)

Lateral displacement (preset 200 mm)

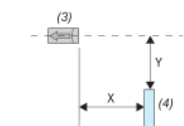
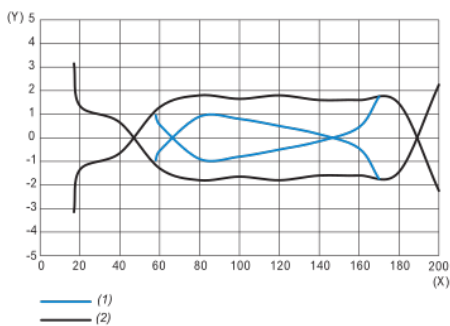

- (1) : Black paper 6 % remission
- (2) : White paper 90 % remission
- (3) : Sensor
- (4) : Object (200 mm square white and black mat paper)
- (X) : Sensing distance (mm)
- (Y) : Lateral displacement (mm)

Light beam diameter

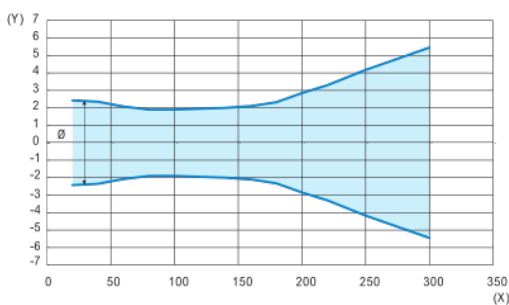

- (X) : Sensing distance (mm)
- (Y) : Light beam diameter (mm)

Minimum distance between the object to detect and white background

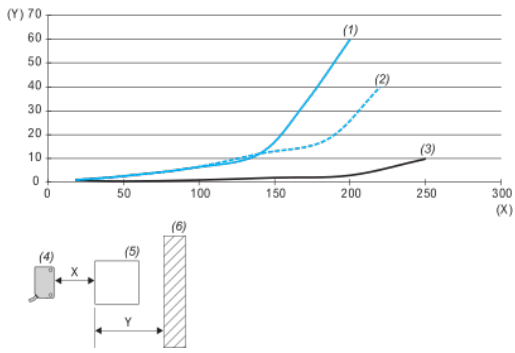

- (1) : Min. distance black object (6%)/white background (90%) (mm)
- (2) : Min. distance grey object (18%)/white background (90%) (mm)
- (3) : Min. distance white object (90%)/white background (90%) (mm)
- (4) : Sensor
- (5) : Object
- (6) : Background
- (X) : Distance sensor/object (mm)
- (Y) : Min. distance object/background (mm)

X-ON Electronics

Largest Supplier of Electrical and Electronic Components

Click to view similar products for [Photoelectric Sensors](#) category:

Click to view products by [Schneider](#) manufacturer:

Other Similar products are found below :

[7442AD2X5FRX](#) [EX-19B-LP](#) [EX-19SB-PN](#) [7443AR0X5FRX](#) [7452AD4D4NNX](#) [F3WD052C5M](#) [7655AR-04-F-1-2-RX](#) [7694ADE04DS2X](#)
[FE7C-FRC6S-M](#) [FX-305](#) [PM-R24-R](#) [Q45VR2FPQ](#) [13104RQD07](#) [E3JUXM4MN](#) [E3L2DC4](#) [E3S3LE21](#) [E3SCT11M1J03M](#) [E3SDS20E21](#)
[E3VDS70C43S](#) [E3XNM16](#) [BR23P](#) [HOA6563-001](#) [OJ-3307-30N8](#) [OS-311A-30](#) [P32013](#) [P34036](#) [P43004](#) [P56001](#) [P60001](#) [PB10CNT15PO](#)
[S14132](#) [935286-000](#) [S52101](#) [S56258](#) [EX-L261-P](#) [FD-SN500](#) [FE7B-FDRB6-M](#) [SU-79](#) [T36342](#) [T40300](#) [T60001](#) [PD60CNX20BP](#) [FX-302-](#)
[HY](#) [FZS](#) [PM-T64W](#) [PX-22](#) [PZ2-51P](#) [CX-491-P-J](#) [CYNUTX10](#) [UZB802](#)