

---

# Ultrasonic sensors

## XX range

## Catalogue



Simply easy!™



# Optimise detection with XX range

Detect objects in challenging applications with our XX ultrasonic sensors range. These ultrasonic sensors offer an efficient solution for reliable and high performance detection at distances of up to 8m, on window mode.

\* The window mode enables suppression of the foreground and the background using the same sensor.

## > A technology suited to your needs

Detect objects regardless lighting conditions or material reflectivity degree

## > 3 operating modes for efficient detection

Ideal for detecting irregular-shaped objects

## > Short or long distance detection

From 50 mm upto 8m

## Contents

Customer benefits .....	pages 2 and 3
Selection guide based on application .....	pages 4 and 5
Product selection guide .....	pages 6 and 7
Product applications .....	pages 10 and 15
<b>Ultrasonic sensors XX range</b>	
<b>General</b> .....	pages 16 to 21
<b>Cylindrical sensors</b>	
M12 sensors (digital sensors - Diffuse, Thru-beam)	
M18 sensors (digital sensors less than 0.5m- all Diffuse) .....	pages 22 to 26
M18 sensors (digital (Diffuse) & analog sensors - 0.5 m) .....	pages 27 to 30
Thru-beam (digital sensors 61 cm & 1m) .....	pages 27 to 30
M18 sensors (digital & analog sensors - 1m) .....	pages 31 to 36
M30 sensors (digital & analog sensors - 1m, 2m, 8m) .....	pages 37 to 40
Application - Sensors for monitoring 2 levels .....	pages 41 to 43
XX range, general purpose Ø 30 mm .....	pages 51 to 69
<b>Flat format sensors</b>	
Diffuse, Reflex, Thru-beam system .....	pages 44 to 50
XX configuration software .....	pages 70 to 72
Accessories .....	pages 73 to 75
<b>Product reference index</b> .....	page 76

## > A technology suited to your needs

Ultrasonic sensors enable non-contact detection of objects in many kinds of industrial environment, irrespective of :

- material (metal, plastic, wood, cardboard, etc.),
- nature (solid, liquid, powder, paste, etc.),
- colour,
- degree of transparency.

The ultrasonic sensors are simple to install; they feature integrated connectors, or cable versions in select models, and offer a wide range of cabling and mounting accessories for a seamless integration.

## > 3 operating modes for efficient detection

### Diffuse mode

An object reflects the ultrasonic wave back to the sensor which, in turn, changes the output state.

This operating mode is well suited for detecting objects with flat surfaces that are positioned perpendicularly to the direction of the ultrasonic beam.

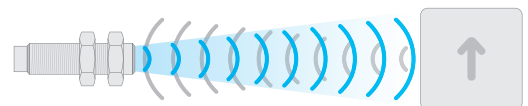

### Reflex mode

The sensor is permanently detecting a fixed background (previously taught) on a machine or application. When another object breaks the ultrasonic beam, the output changes its state.

Well suited for detecting objects that absorb the ultrasonic waves (sponges, etc.) or that do not reflect the wave back to the sensor (non-flat surfaces, pointy or irregular-shaped objects).

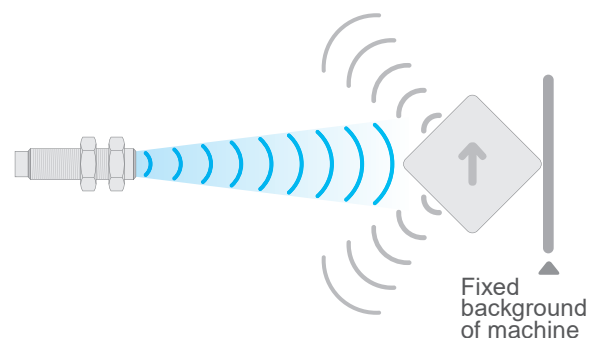

### Thru-beam mode

The transmitter is constantly sending an ultrasonic wave to the receiver. When an object breaks the ultrasonic beam, the output changes its state.

Well suited for small object detection and applications where higher accuracy and faster response time are required.

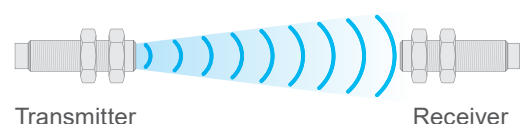

# > Long distance proximity detection

Ultrasonic technology allows now for long distance proximity detection. The XXV Ø18 ultrasonic sensors enable detection from 0 to 50 mm (i.e. 2.5 times farther than standard inductive proximity sensors) with minimal environment constraints or object material and colour restrictions.

Sensors mounted too close to moving-metal parts are exposed to hits or impacts which can cause machine downtime. Being able to install sensors farther away from moving targets reduces the exposure to potential incidents. You increase installation profitability!

**x 2,5**  
detection distance  
than standard  
inductive proximity  
sensors

XXV Ø18

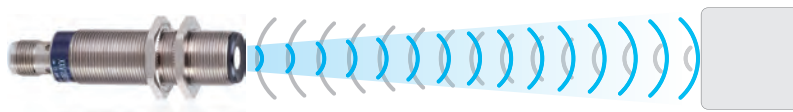

Standard inductive proximity sensor

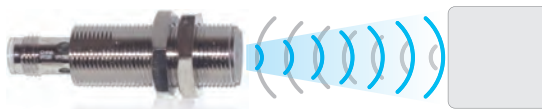

The XXV ultrasonic sensor is a “Plug and Play” solution with no adjustment or teaching required. Its solid-state output changes state when an object is less than 50 mm away from the sensor face.

Its accurate and well-defined transmission angle enables precise detection. Crosstalk with other sensors and object edge effects are mastered.

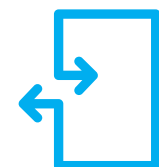

Plug & Play solution



**100%**  
Worldwide availability

# > Selection guide based on application

Type of detection

Detection "Digital"

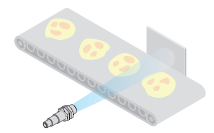
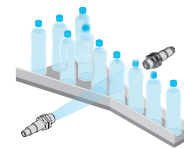
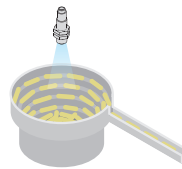

Assembly

Conveying

Pack

Machine part

Vibrating bowl

Presence  
Absence

Transparent  
bottles

Jam

Flow

Tran

Sensor type

Ø18  
(M18x1)



Ø12  
(M12x1)



Ø18  
(M18x1)



Ø30  
(M30x1,5)



7,6x19x33



16x30x74



18x33x60  
Ø18  
(M18x1)



80X80X34



Diffuse mode



Reflex mode

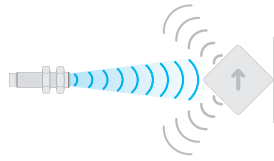

Thru-beam mode



**Regulation "Analogue output"      Level monitoring      Mobile Equipment**

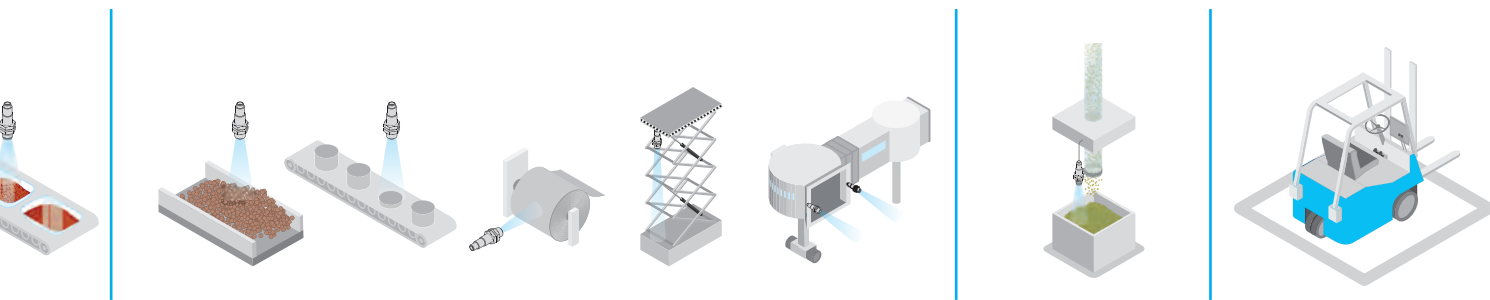

Packaging      Conveying      Packaging      Handling      Handling      Process      Forklift

Transparent film      Material level      Height of part      Radius of strip roll      Height of elevating table      Aircraft boarding bridge      Monitoring 2 thresholds      Filling Emptying      Filling Emptying

<input type="checkbox"/>	<input type="checkbox"/>				<input type="checkbox"/>	<input type="checkbox"/>
<input type="checkbox"/>	<input type="checkbox"/>				<input type="checkbox"/>	<input type="checkbox"/>
<input checked="" type="checkbox"/>	<input checked="" type="checkbox"/>				<input checked="" type="checkbox"/>	<input type="checkbox"/>
<input checked="" type="checkbox"/>	<input checked="" type="checkbox"/>				<input checked="" type="checkbox"/>	<input type="checkbox"/>
<input checked="" type="checkbox"/>	<input type="checkbox"/>				<input type="checkbox"/>	<input type="checkbox"/>
<input checked="" type="checkbox"/>	<input type="checkbox"/>				<input type="checkbox"/>	<input type="checkbox"/>
<input checked="" type="checkbox"/>	<input checked="" type="checkbox"/>				<input type="checkbox"/>	<input type="checkbox"/>
<input type="checkbox"/>	<input checked="" type="checkbox"/>				<input type="checkbox"/>	<input type="checkbox"/>

# Ultrasonic sensors

XX range  
Cylindrical type

**Applications**  
Non-contact detection of sound reflecting objects regardless their shape, material, colour, orientation, etc.

**Dimensions (mm)**

## Sensors with solid-state digital output

### Cylindrical type

Ø 12 (M12 x 1)



Ø 18 (M18 x 1)



Sensing distance Sn	Diffuse
	Reflex
Assured operating distance (mm)	Thru-beam
	6.4...51 fixed
Power supply	12...24 V $\overline{\text{---}}$ with protection against reverse polarity
Type of output	PNP/NPN
Function	NO
Degree of protection	IP 67
Connection	M8
Sensor type	XX512A1●
Page	(2)

5 cm	10 cm	–	5 cm	15 cm	50 cm
–	–	–	–	–	50 cm
–	–	20 cm	–	–	–
6.4...51 fixed	6.4...102 fixed	–	2...50 fixed	25...152 fixed	Adjustable using teach mode
PNP/NPN	NPN or PNP	PNP/NPN	PNP or NPN	PNP/NPN	NPN or PNP
NO	NO	NO/NC	NO NC	NO	NO
IP 67	IP 67	IP 67	IP 67	IP 67	IP 67
M8	M8	M8	M12 or pre-cabled	M12	M12 or pre-cabled (1)
XX512A1●	XX512A2●	XX●12A8●	XXV18B1●	XX518A1●	XX518A3● XXB18A3●
(2)					

**Dimensions (mm)**

## Sensors with analogue output

### Cylindrical type

Ø 18 (M12 x 1)



Sensing distance Sn	50 cm
Assured operating distance (mm)	Adjustable using teach mode
Power supply	12...24 V $\overline{\text{---}}$ with protection against reverse polarity
Type of output	4-20 mA or 0-10 V
Degree of protection	IP 67
Connection	M12
Sensor type	XX918A3●
Page	(2)

1 m
Adjustable using teach mode
12...24 V $\overline{\text{---}}$ or 24 V $\overline{\text{---}}$ , depending on model, with protection against reverse polarity,
4-20 mA or 0-10 V
IP 67
M12
XX●18●1AM12 XX●18●1VM12
31

(1) XXB18A3●: M12 connector only.  
(2) Please refer to our catalogue "Ultrasonic sensors XX range".



Cylindrical type

Application, monitoring 2 levels

Ø 18 (M18 x 1) (continued)

Ø 30 (M30 x 1.5)

Ø 18 (M18 x 1)

Ø 30 (M30 x 1.5)



	1 m	1 m	2 m/4 m depending on model	8 m	50 cm	1 m/2 m depending on model	8 m
	–	1 m	–	–	–	–	–
61 cm/1 m	–	–	–	–	–	–	–
	Adjustable using teach mode	Adjustable using teach mode			Adjustable using teach mode		
12...24 V $\overline{\text{---}}$ with protection against reverse polarity		12...24 V $\overline{\text{---}}$ with protection against reverse polarity			12...24 V $\overline{\text{---}}$ with protection against reverse polarity		
PNP/NPN	PNP	PNP or NPN or PNP/NPN		PNP or NPN	PNP or NPN	PNP/NPN	PNP
NO NC	NO or NC (selectable)	NO or NC or NO+NC or NO+NO		NO + NC	NO	NO + NO	NO + NO
IP 67	IP 67	IP 67	IP 67	IP 67	IP 67	IP 67	IP 67
M12	M12	M12	M12	M12	M12	M12	M12
XX●18A3● XX●18A4●	XX●18●1PM12	XX●30●●1PM12 XX6V3A1● XXBV3A1● XX630A1●	XX●30●●2PM12 XXS30●●4PM12 XX630A2●	XX630A3●	XX218A3●	XX230A1● XX230A2●	XX230A3●
(2)	31	(2)					

Ø 18 (M12 x 1) (continued)

Ø 30 (M30 x 1.5)



1 m	2 m	4 m	8 m
Adjustable using teach mode			
12...24 V $\overline{\text{---}}$ or 24 V $\overline{\text{---}}$ , depending on model, with protection against reverse polarity			
4-20 mA or 0-10 V			
IP 67	IP 67	IP 67	IP 67
M12	M12	M12	M12
XX●30●1●M12 XX9V3A1● XX930A1●	XX●30●2●M12 XX930A2●	XXS30●4●M12	XX930A3●
(2)			

**Applications**  
Non-contact detection of sound reflecting objects regardless their shape, material, colour, orientation, etc.

**Dimensions (mm)**

### Sensors with solid-state digital output

#### Flat format

7.6 x 19 x 33	16 x 30 x 74
---------------	--------------



	<b>Sensing distance Sn</b>	Diffuse
		Reflex
		Thru-beam
	<b>Assured operating distance (mm)</b>	
	<b>Power supply</b>	
	<b>Type of output</b>	
	<b>Function</b>	
	<b>Degree of protection</b>	
	<b>Connection</b>	
	<b>Sensor type</b>	
<b>Page</b>		

10 cm	–	25 cm	–
–	–	–	–
–	20 cm	–	61 cm/1 m
6.4...100 fixed	–	51...250 fixed	–
12...24 V $\overline{\text{DC}}$ with protection against reverse polarity			
NPN or PNP	NPN/PNP	NPN or PNP	NPN/PNP
NO	NO NC	NO	NO + NO NC + NC
IP 67	IP 67	IP 67	IP 67
M12 connector on flying lead	M12 connector on flying lead	M12	M12
<b>XX7F1A2</b>	<b>XX</b> F1A8	<b>XX7K1A2</b>	<b>XX</b> K1A3 <b>XX</b> K1A4

Please refer to our catalogue "Ultrasonic sensors XX range"

**Dimensions (mm)**

### Sensors with analogue output

#### Flat format

18 x 33 x 65 + Ø 18 (M18 x 1)



<b>Sensing distance Sn</b>	50 cm (adjustable)
<b>Assured operating distance (mm)</b>	Adjustable using teach mode
<b>Power supply</b>	12...24 V $\overline{\text{DC}}$ with protection against reverse polarity   24 V $\overline{\text{DC}}$ with protection against reverse polarity
<b>Type of output</b>	4-20 mA   0-10 V
<b>Degree of protection</b>	IP 67
<b>Connection</b>	M12
<b>Sensor type</b>	<b>XX9V1A1C2M12</b>   <b>XX9V1AF1M12</b>
<b>Page</b>	

Please refer to our catalogue "Ultrasonic sensors XX range"

18 x 33 x 60 + Ø 18  
(M18 x 1)



80 x 80 x 34



50 cm (adjustable)

1 m (adjustable)

50 cm (adjustable)

1 m (adjustable)

–

–

Adjustable using teach mode

12...24 V  $\overline{\text{DC}}$  with protection against reverse polarity

NPN or PNP

NPN or PNP

NO

NO

IP 67

IP 67

M12

M12

XX7V1A1●AM12  
XXBV1A1PAM12

–

Please refer to our catalogue "Ultrasonic sensors XX range"

80 x 80 x 34



1 m (adjustable)

Adjustable using teach mode

12...24 V  $\overline{\text{DC}}$  with protection against reverse polarity

24 V  $\overline{\text{DC}}$  with protection against reverse polarity

4-20 mA

0-10 V

IP 67

M12

XX9D1A1C2M12

XX9D1A1F1M12

Please refer to our catalogue "Ultrasonic sensors XX range"

### Feeder bowl supply control

XX7V1A1

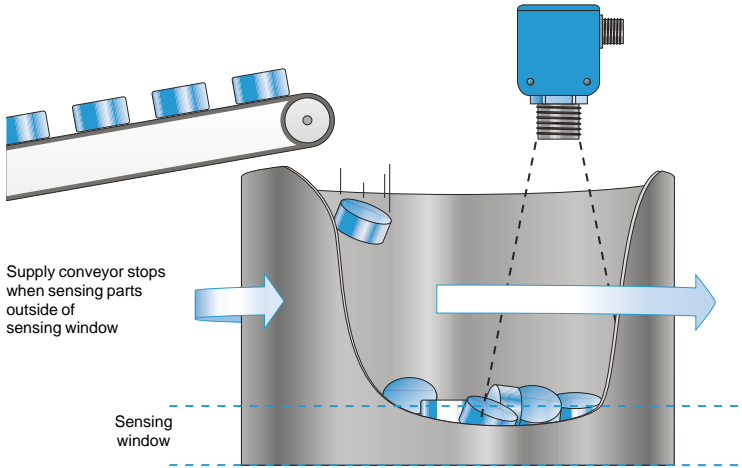

### Conveyor jam & backup detection

XXB18A3

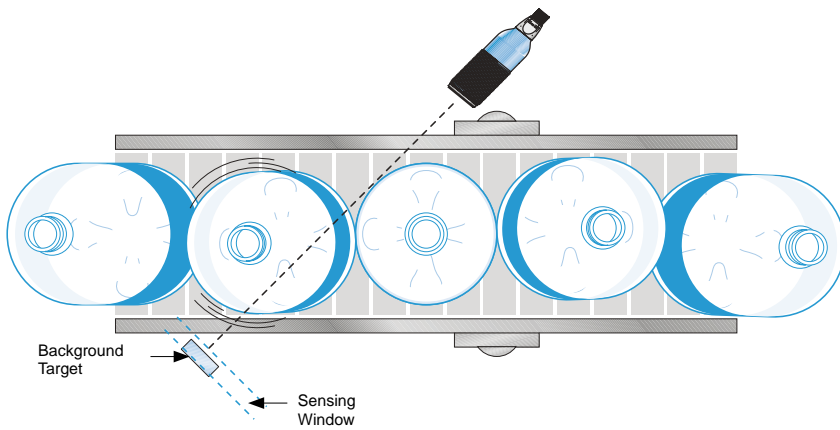

### Web process control sensing functions

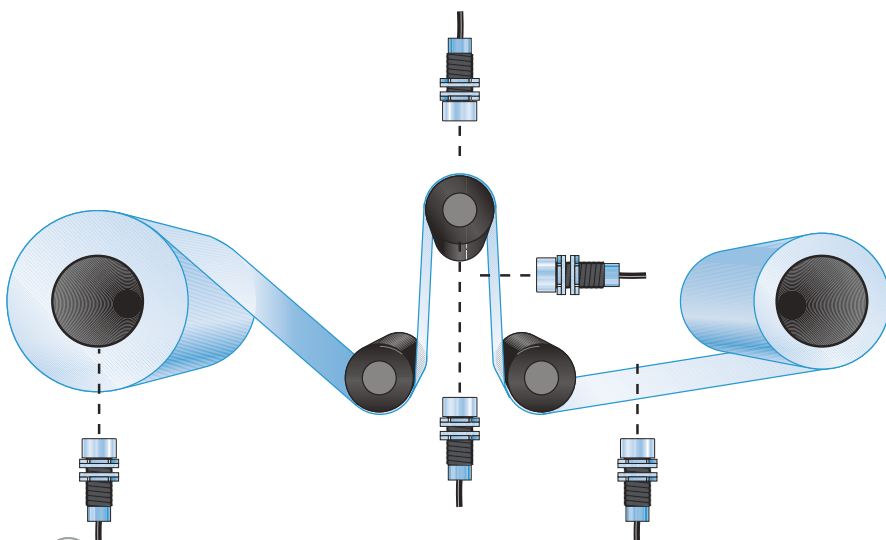

More technical information on [www.schneider-electric.com](http://www.schneider-electric.com)

**Dual level high-low latch control detection of liquids**  
XX230A3

**High level detection**  
XX630A3

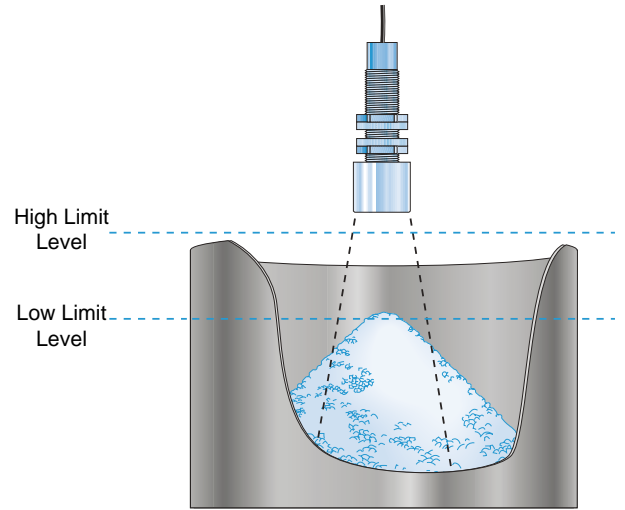
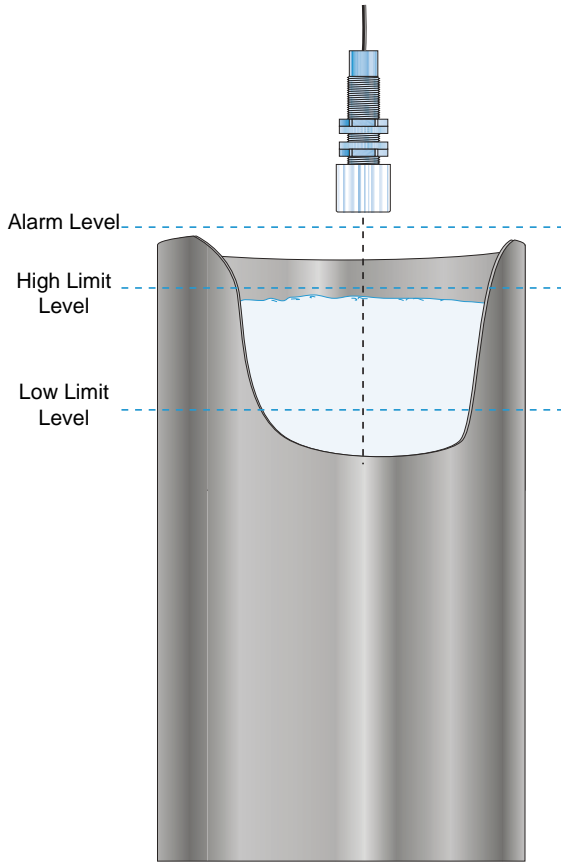

**Accurate high speed counting of cylindrical clear objects**  
XXT18 + XXR18

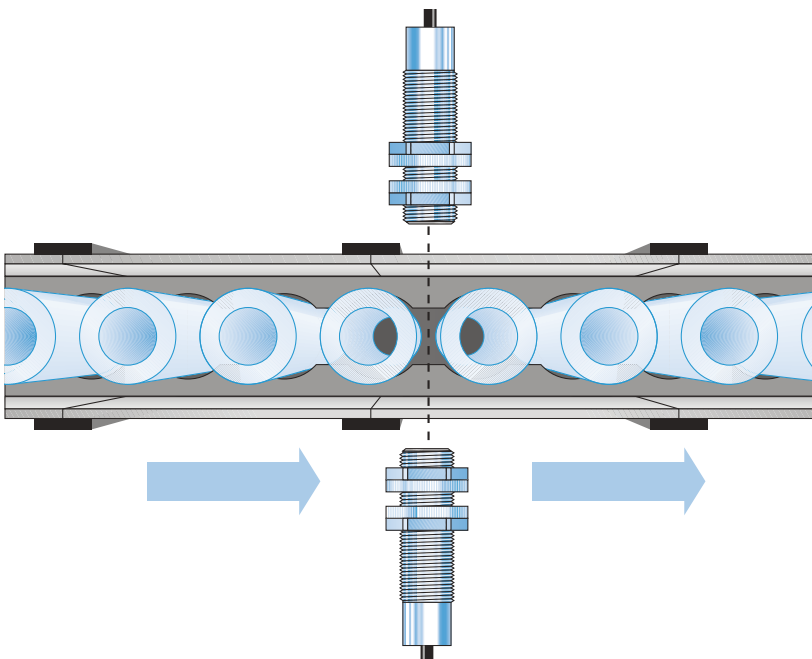

More technical information on [www.schneider-electric.com](http://www.schneider-electric.com)

**Glue bead detection**

XXV18

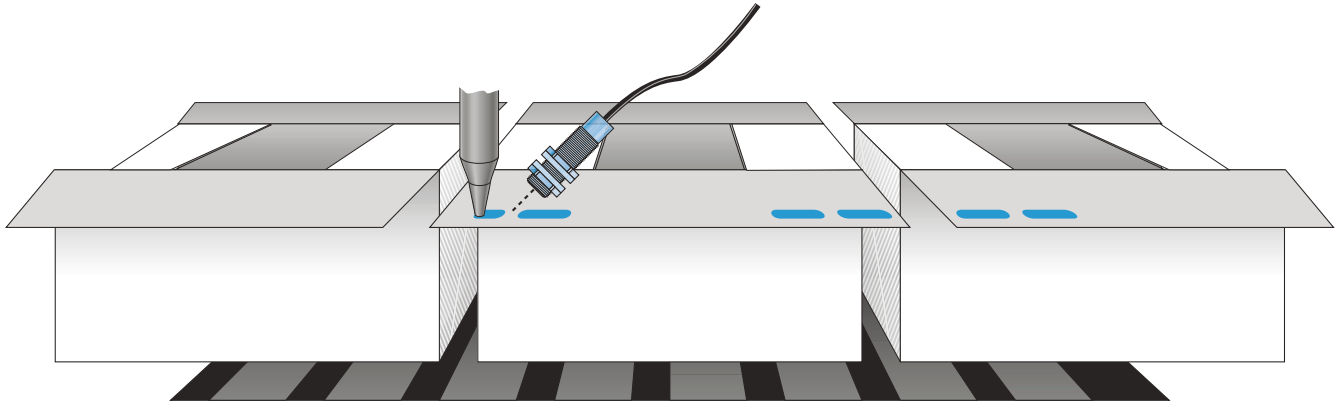

**Label edge detection on carrier web**

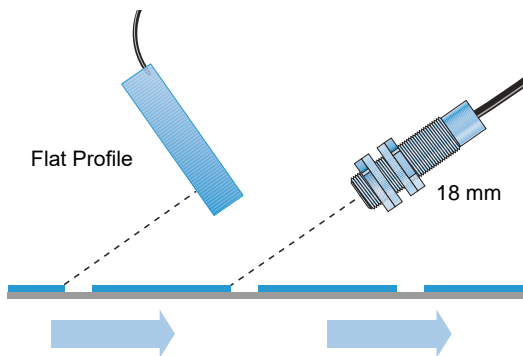

**Clear bottle detection for sustainable environments**

XXB18

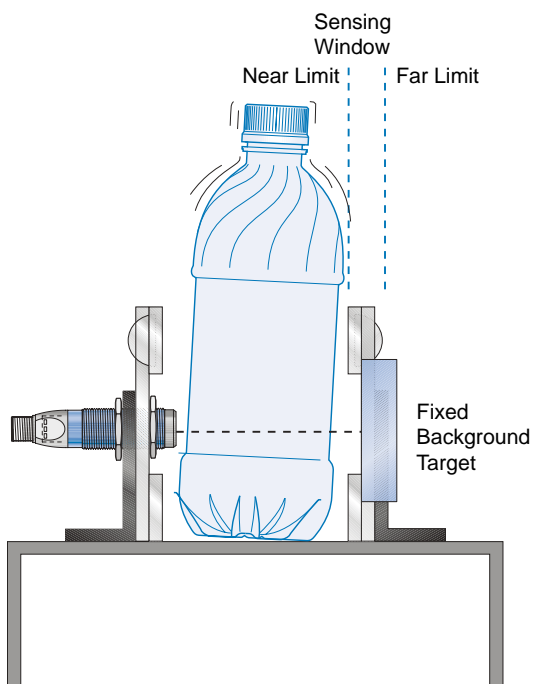

**Broken wire/thread detection**

XXV18

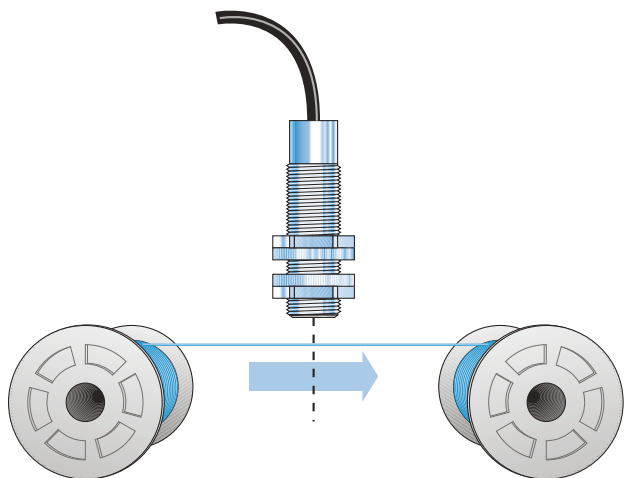

More technical information on [www.schneider-electric.com](http://www.schneider-electric.com)

**Missing cap detection low cap supply**

XX512

Automatically stops filler and capper

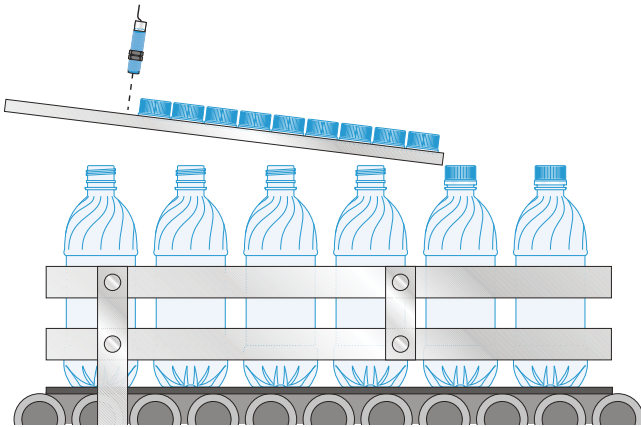

**Continuous level monitoring**

XX918 & XX930

Analog Output Sensor

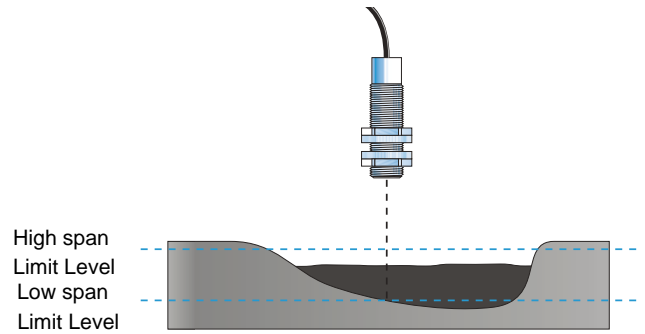

**Dual level high-low latch control detection**

XX230

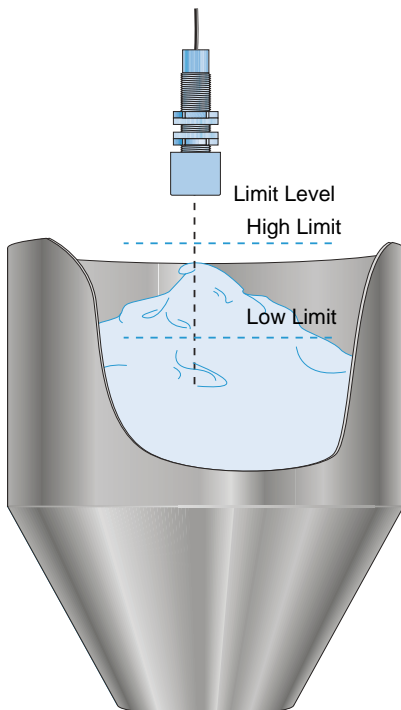

**Lead edge or backup detection**

XXT18 & XXR18

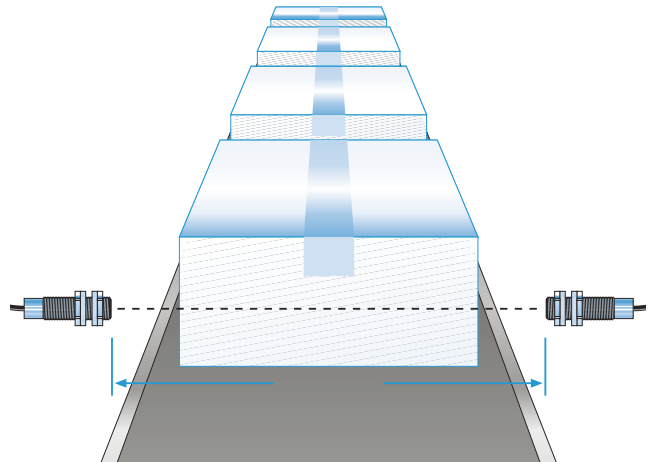

### Clear bottle detection

XXT12 & XXR12

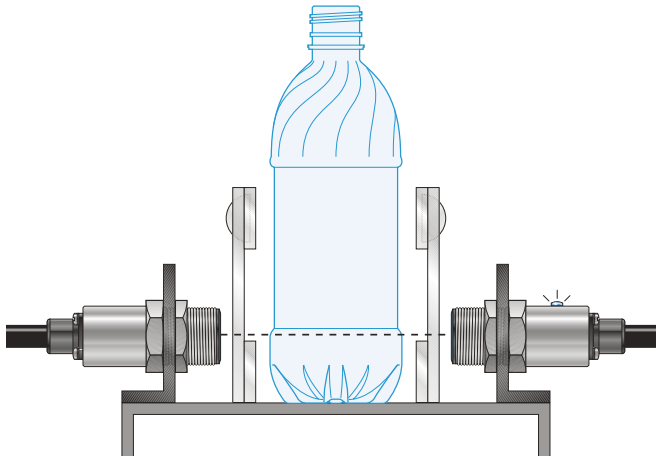

### Container detection

XX7F1

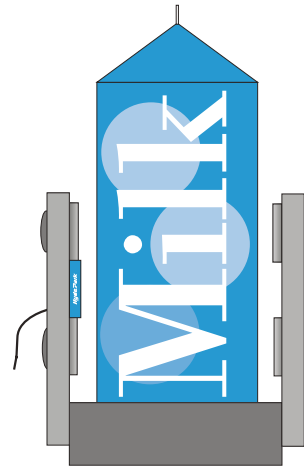

### Metal material detection

XX512

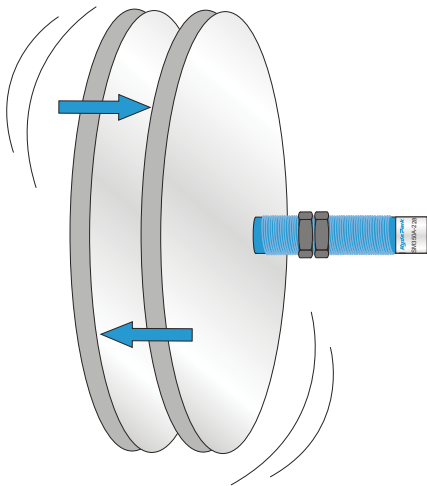

### Missing cap detection

XX518

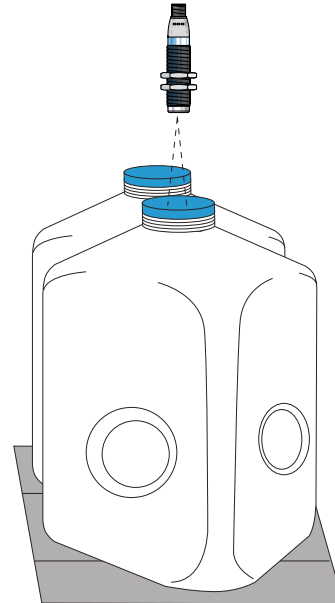

### Clear web detection

XX512

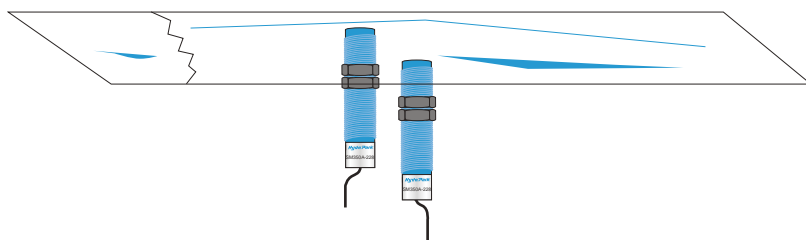



**Container detection**

XX7F1

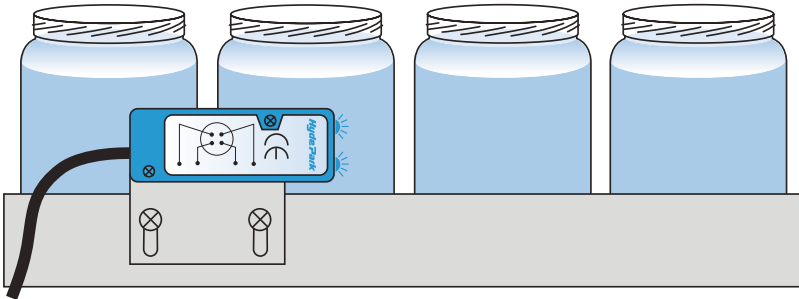

**Clear cellophane panel detection**

XX7F1A2

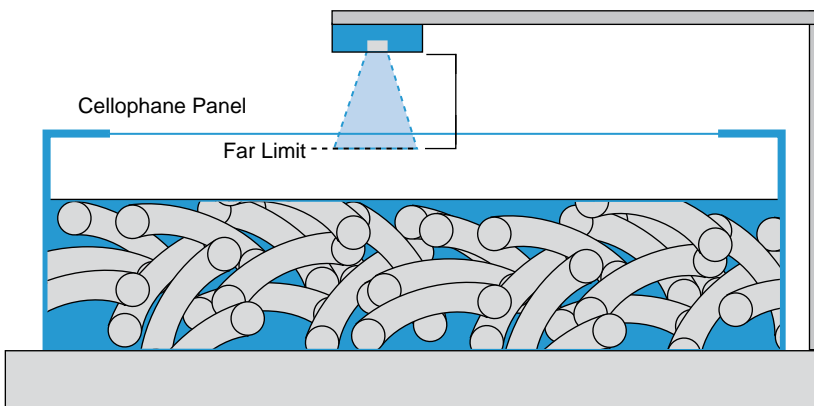

**Single file jam protection**

XX218 & XX230

Dual level latch control sensor

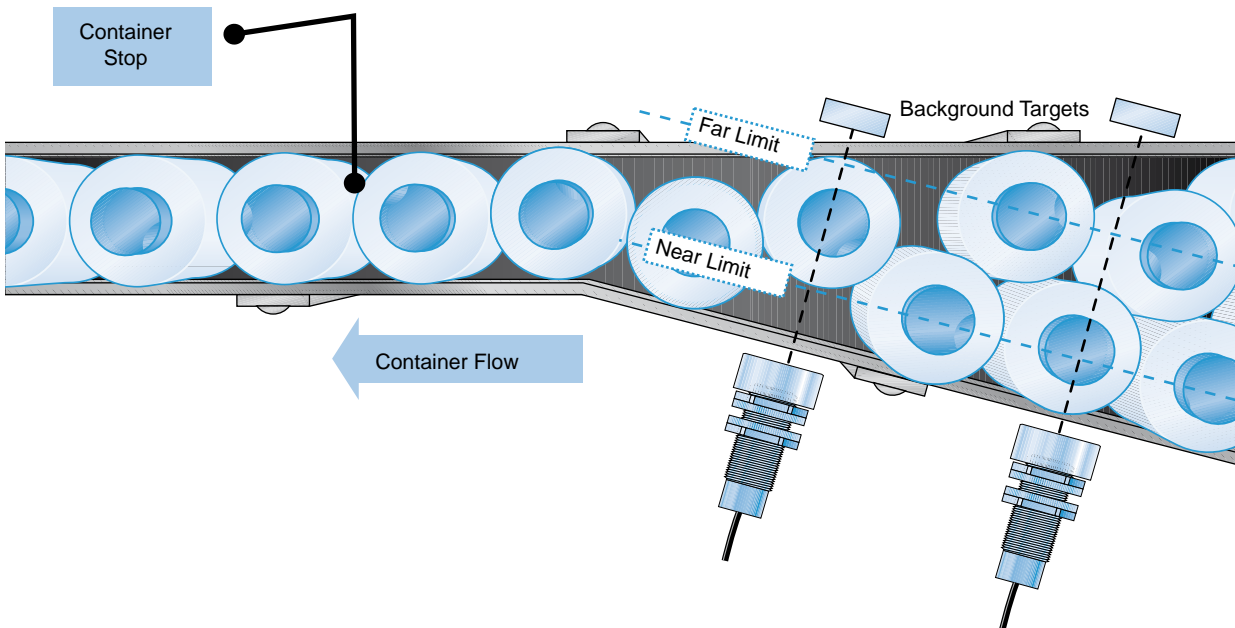

More technical information on [www.schneider-electric.com](http://www.schneider-electric.com)

### Quality, standards and certifications

#### Quality control

The XX ultrasonic sensors models are subjected to special precautions in order to guarantee their reliability in arduous industrial environments.

##### ■ Qualification

A **qualification procedure** on the characteristics of XX range ultrasonic sensors is carried out in our laboratories.

##### ■ Production

The electrical characteristics and the sensing distances at the ambient and operating temperatures are 100% verified.

Sensors are statistically selected during the course of production and subjected to **monitoring tests** on all qualified characteristics.

##### ■ Customer returns

Returned ultrasonic sensors are subjected to systematic analysis and corrective actions are implemented to eliminate recurrence of the fault.

#### Conformity to standards

The XX ultrasonic sensors models conform to the standards IEC 60947-5-2.  
Standards and characteristics: refer to pages 23, 28, 33, 38, 39, 42, 46, 54, 55, 62 and 66.

#### Resistance to chemicals in the environment

To ensure lasting efficient operation, it is essential that any chemicals coming into contact with the ultrasonic sensors will not affect their casing and, in doing so, prevent their reliable operation.

Due to the materials used, the XX ultrasonic sensors models are very resistant to:

##### ■ Chemical agents:

salts, aliphatic and aromatic oils,  
petroleum, diluted bases and acids.

Depending on their nature and concentration, tests should be carried out beforehand for the following chemical agents:

alcohols, ketones and phenols.

##### ■ Food and beverage industry products:

vegetable oils, animal fats,  
fruit juices,  
milk proteins, etc.

#### Resistance to the environment

##### ■ IP 65: protection against water jets.

Tested in accordance with IEC 60529: the device is subjected to water sprayed from a Ø 6.3 mm nozzle, at a flow rate of 12.5 litres/min for 3 min at a distance of 3 m.  
No deterioration in either operating or insulation characteristics is permitted.

##### ■ IP 67: protection against the effects of immersion.

Tested in accordance with IEC 60529: the sensor is immersed for 30 minutes in 1 m of water.  
No deterioration in either operating or insulation characteristics is permitted.

##### ■ IP 69K: protection against the effects of high pressure cleaning. Adherence to standard

DIN 40050 which stipulates that the product must withstand a water jet at a pressure of 90 bar and temperature of +80°C for 3 minutes.

No deterioration in either operating or insulation characteristics is permitted.

### Recommendations

The ultrasonic sensors are designed for use in standard industrial applications involving presence detection. Since these sensors do not incorporate a redundant electrical circuit, they are not suitable for use in safety applications. For safety applications, please refer to our "Safety functions and solutions using Preventa" catalogue.

### Principle of ultrasonic detection



### Presentation

Ultrasonic sensors enable detection, without contact, of objects irrespective of its:

- material (metal, plastic, wood, cardboard, etc.),
- nature (solid, liquid, powder, etc.),
- colour,
- degree of transparency.

They are used in industrial applications for detecting, for example:

- the position of machine parts,
- the presence of the windscreen during automobile assembly,
- the flow of objects on a conveyor system: glass bottles, cardboard packages, cakes, etc.,
- the level
  - of different colour paints in pots,
  - of plastic pellets in injection moulding machine feeders.

The ultrasonic sensors are simple to install due to their integral connector and availability of cabling and fixing accessories.

### Operating principle

The principle of ultrasonic detection is based on measuring the time taken between transmission of an ultrasonic wave (pressure wave) and reception of its echo (return of transmitted wave).

The XX ultrasonic sensors models comprise:

- 1 a high voltage generator
- 2 a piezoelectric transducer (transmitter and receiver)
- 3 a signal processing stage
- 4 an output stage

Excited by the high voltage generator 1, the transducer (transmitter-receiver) 2 generates a pulsed ultrasonic wave (200 to 500 kHz depending on the product) which travels through the ambient air at the speed of sound. When the wave strikes an object, it reflects (echo) and travels back towards the transducer. A micro controller 3 analyses the signal received and measures the time interval between the transmitted signal and the echo. By comparison with the preset or taught times, it determines and controls the output states 4.

The output stage 4 controls a solid-state switch (PNP or NPN transistor) corresponding to a NO or NC contact (detection of object).

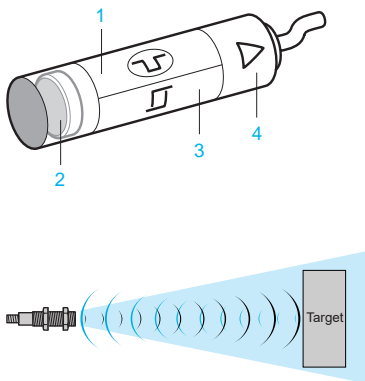

### Advantages of ultrasonic detection

- No physical contact with the object to be detected, therefore, no wear and detection possible of fragile and/or freshly painted objects, etc.
- Detection of materials, irrespective of colour, at the same distance, without adjustment or correction factor.
- Teach mode function, by simply pressing a button, for defining the effective detection zone. Teaching of the minimum and maximum sensing distances (very precise foreground and background suppression,  $\pm 6$  mm).
- Very good resistance to industrial environments (robust products entirely encapsulated in resin).
- Solid-state units: no moving parts in the sensor, therefore, service life independent of the number of operating cycles.
- Various types of outputs to suit requirements:
  - Digital output for level control or detection of any type of object
  - Analogue output for controlling systems that require a signal that is proportional to the distance at which the object is detected.

### Terminology

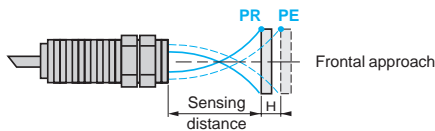
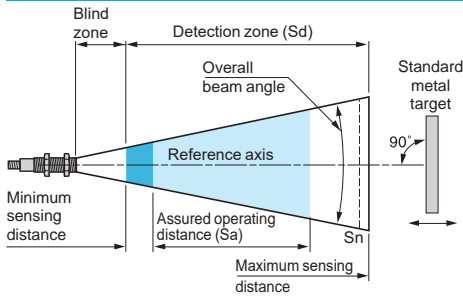

PR = drop-out point  
PE = pick-up point

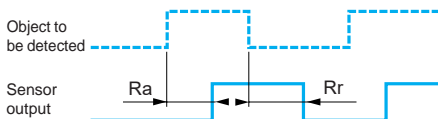
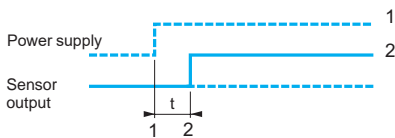
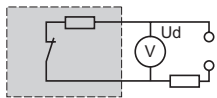

### Definitions

The terms listed below are defined by the standard IEC 60947-5-2:

■ **Nominal sensing distance (Sn)**  
Conventional value for indicating the sensing distance. It does not take into account manufacturing tolerances nor variations caused by external conditions such as voltage and temperature.

■ **Detection zone (Sd)**  
Zone in which the sensor is sensitive to objects.

■ **Minimum sensing distance**  
Lower limit of the specified detection zone.

■ **Maximum sensing distance**  
Upper limit of the specified detection zone.

■ **Assured operating distance (Sa)**  
This corresponds to the operating zone of the sensor (activation of outputs), and is included in the detection zone. It is also known as the "detection window".  
Its limits are fixed:

- at the factory for fixed sensing distance sensors,
- when setting-up within the application for sensors with teach mode.

■ **Blind zone:** Zone located in front of the sensing face of the sensor.  
For diffuse sensors, it is the zone in which the object will not be reliably detected.  
For reflex sensors, it is the zone in which the target (fixed background of machine for example) will not be reliably detected, but the object can be in this zone.  
For thru-beam sensors, there is no blind zone.

■ **Differential travel**  
The differential travel (H) or hysteresis is the distance between the pick-up point as the standard metal target moves towards the sensor and the drop-out point as it moves away from the sensor.

■ **Repeat accuracy**  
The repeat accuracy (R) is the precision of reproduction between two successive measurements of the sensing distance, made in identical conditions.

■ **Overall beam angle**  
Fixed angle around the reference axis of an ultrasonic proximity sensor.

■ **Standard metal target**  
The standard IEC 60947-5-2 defines the standard target as a square metal plate, 1 mm thick with rolled finish, placed perpendicularly to the reference axis.  
Its side dimension depends on the detection zone:

Detection zone (mm)	Size of target (mm)
< 300	10 x 10
300 < d < 800	20 x 20
> 800	100 x 100

■ **Voltage drop (Ud)**  
The voltage drop (Ud) corresponds to the voltage at the terminals of the sensor when in the closed state (value measured at the nominal current of the sensor).

■ **First-up delay**  
Time required to ensure operation of the sensor's output signal following power-up.  
1 Power-up  
2 Output signal state (0 or 1)

■ **Response time**  
Response time (Ra): time taken between the instant the object to be detected enters the active zone and the changing of the output signal state. This time limits the passing speed of the target in relation to its dimensions.  
Recovery time (Rr): time taken between the object being detected leaving the active zone and the changing of the output signal state. This time limits the interval between 2 objects.

### Digital outputs

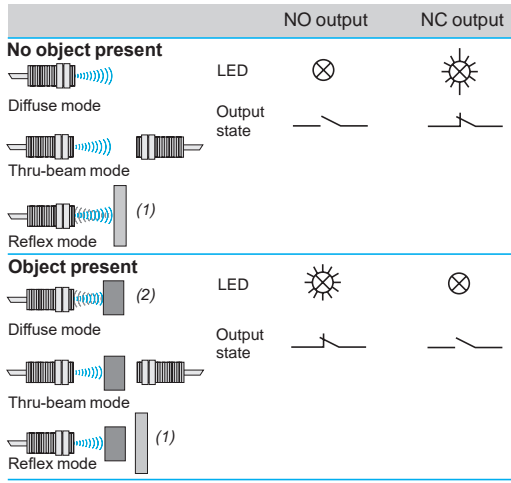

(1) Fixed background of machine  
(2) Object

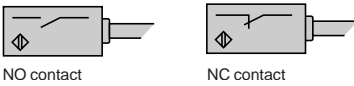

### LED indicators

The majority of XX ultrasonic sensors models incorporate light-emitting diode output state indicators.

- Ø 12 sensor
  - Green LED (power on)
  - Yellow LED (object present)
- Ø 18 sensor, sensitivity 500 mm (except thru-beam versions XXT18 and XXR18)
  - Yellow LED (object present) or green LED (power on) + user assistance when adjusting the detection zone
- Ø 30 sensor
  - Multicolour LED for assisting the user when adjusting the detection distance
  - Yellow LED (object present)
  - Analogue version with LED (object present, with luminosity increasing as output signal increases)
- Parallelepiped format sensor
  - XX●F: Dual colour yellow (object present) or green (power on) LED
  - XX●V: Dual colour yellow (object present) or green (power on) LED + user assistance when adjusting the detection zone
  - XX7K: Yellow LED (object present); green LED (power on)
  - XXTK, XXRK: Yellow LED (object present) only
  - XX●D: Yellow LED (object present); green LED (power on)
  - Analogue version with LED (object present, with luminosity increasing as output signal increases)

### Sensors with digital switching

#### Output contact logic

- NO contact (normally open)  
Corresponds to a sensor whose output changes to the closed state when an object is present in the detection window.
- NC contact (normally closed)  
Corresponds to a sensor whose output changes to the open state when an object is present in the detection window.

#### 4-wire technique

##### NO output/PNP and NPN

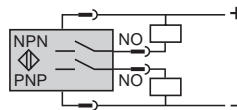

##### NO + NC output/NPN

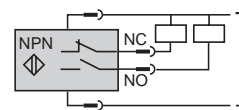

##### NO + NC output/PNP

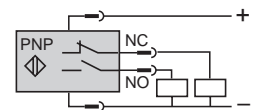

These sensors comprise 2 wires for the supply and 1 wire for each output signal

#### 3-wire technique

##### NO output/NPN

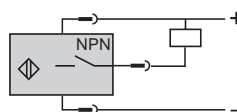

##### NO output/PNP

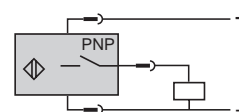

These sensors comprise 2 wires for the supply and 1 wire for the output signal,

- PNP type:** switching the positive side to the load.
- NPN type:** switching the negative side to the load.

### Sensors with analogue output

#### Operation

The characteristic feature of these sensors is the output which delivers a signal (either current or voltage) that is proportional to the distance of the object being detected. Within the detection limits, which are adjustable using teach mode, the value of the output signal increases or decreases in relation to the distance of the object. When an object is detected, an LED indicator (D) illuminates and its luminosity increases in relation to the value of the output signal. The slope of the signal can simply be changed by pressing the teach button

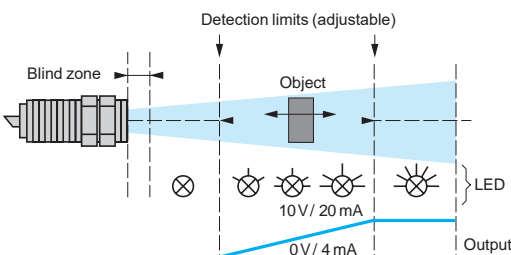

#### Advantages

- Visual information available relating to the sensor/object distance.
- Protection against reverse polarity.
- Protection against overloads and short-circuits.
- No residual current, low voltage drop.

### Power supply

### Sensors for DC circuits

- **DC source:** Check that the voltage limits of the sensor and the acceptable level of ripple, are compatible with the supply used.
- **AC source** (comprising transformer, rectifier, smoothing capacitor): The supply voltage must be within the operating limits specified for the sensor.

Where the voltage is derived from a single phase AC supply, the voltage must be rectified and smoothed to ensure that:

- the peak voltage of the DC supply is lower than the maximum voltage rating of the sensor.
- Peak voltage = nominal voltage  $\times \sqrt{2}$
- the minimum voltage of the supply is greater than the minimum voltage rating of the sensor,

given that:  
 $\Delta V = (I \times t) / C$   
 $\Delta V = \text{max. ripple: } 10\% (V),$   
 $I = \text{anticipated load current (mA),}$   
 $t = \text{period of } 1 \text{ cycle (10 ms full-wave rectified for a 50 Hz supply frequency),}$   
 $C = \text{capacitance } (\mu F).$   
 As a general rule, use a transformer with a lower secondary voltage ( $U_e$ ) than the required DC voltage ( $U$ ).

**Example:**  
 18 V ~ to obtain 24 V  $\square$  ,  
 36 V ~ to obtain 48 V  $\square$  .

### Setting-up precautions

For diffuse sensors:

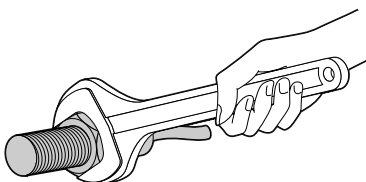
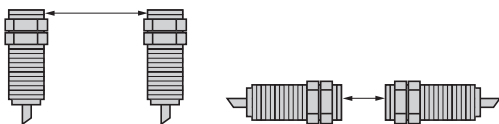

### Mounting

#### Mounting distance between ultrasonic sensors

If 2 standard sensors are mounted too close to each other, the wave transmitted by one sensor is likely to interfere with the other and result in erratic operation. In order to avoid this, it is necessary to adhere to the minimum distances between sensors. See setting-up precautions on page 25.

#### Maximum tightening torque

Cylindrical sensors	Diameter mm	Tightening torque	Flat sensors	Screw	Tightening Torque
XX●12●	Ø 12	0.7 N.m/ 0.52 lb-ft	XX●F●	M3	0.7 N.m/ 0.52 lb-ft
XX●18●	Ø 18	1 N.m/ 0.74 lb-ft	XX●K●	M4	1 N.m/ 0.74 lb-ft
XX●30●	Ø 30	1.35 N.m/ 1 lb-ft	XX●V●	M3	0.7 N.m/ 0.52 lb-ft
XX●V3●	Ø 30	1.35 N.m/ 1 lb-ft		Ø 18	1 N.m/ 0.74 lb-ft
XXS18*	Ø 18 (Plastic)	2 N.m /			
XXA18*	Ø 18 (Metal)	1.47 lb-ft			
		15 N.m /			
		11.06 lb-ft			

#### Interchangeability

Interchangeability is made easy by using **indexed** fixing clamps:  
 XSZB112 (Ø 12 mm),  
 XSZB118 (Ø 18 mm),  
 XSZB130 (Ø 30 mm),  
 XXZB118 (Ø 18 mm),

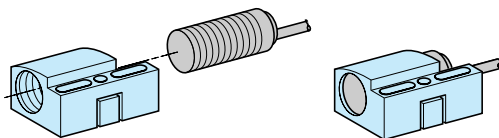

XSZB1●●

### Cabling

#### Electrical connection

- **Connect the sensor before switching on the supply**
- **Length of cable**  
 No limitation up to 200 m or up to a line capacitance of < 0.1  $\mu F$ . It is, however, advisable to take into account the voltage drop on the line.
- **Separation of control and power cables**  
 The sensors are immune to electrical interference encountered in normal industrial conditions. Where extreme conditions of electrical "noise" could occur (large motors, spot welders, etc.), it is advisable to protect against transients in the normal way:
  - suppress interference at source,
  - separate power and control wiring from each other,
  - smooth the supply,
  - limit the length of cable.

## Setting-up precautions (continued)

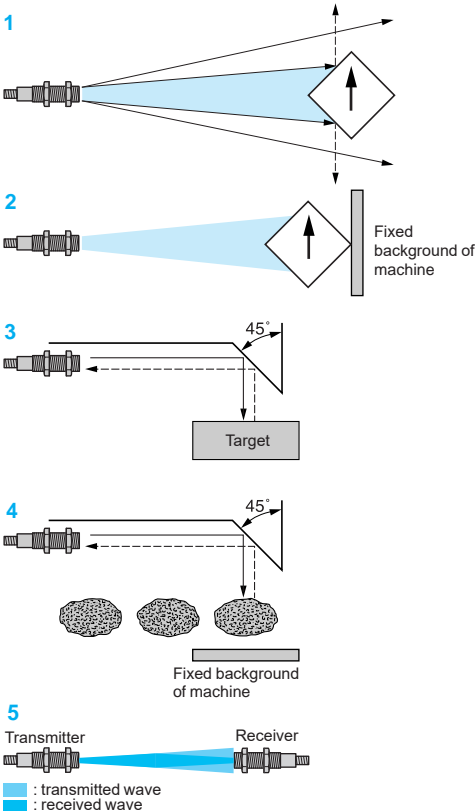
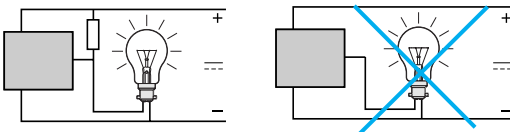
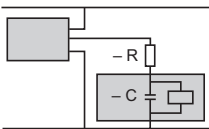
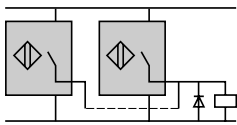
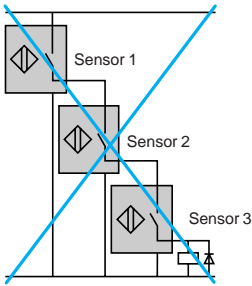

## Connection in series

**This connection method is not recommended.**

- Correct operation of the sensors cannot be assured and, if this method is used, tests should be made before installation.

The following points should be taken into account:

Sensor 1 carries the load current in addition to the no-load current consumption values of the other sensors connected in series. For certain models, this connection method is not possible unless a current limiting resistor is used.

When in the closed state, each sensor will produce a voltage drop and, therefore, the load voltage should be selected accordingly.

As sensor 1 closes, sensor 2 will not operate until a certain time "T" has elapsed (corresponding to the first-up delay) and likewise for the following sensors in the sequence.

"Flywheel" diodes should be used when the load being switched is inductive.

## Sensors and units in series with an external mechanical contact

- The following points should be taken into account:

When the mechanical contact is open, the sensor is not supplied.

When the contact closes, the sensor will not operate until a certain time "T" has elapsed (corresponding to the first-up delay).

## Connection in parallel

- No specific restrictions. The use of "flywheel" diodes is recommended when an inductive load (relay) is being switched.

## Capacitive load (C > 0.1 mF)

- At switch-on, it is necessary to limit (by resistor) the charging current of the capacitive load C. The voltage drop in the sensor can also be taken into account by subtracting it from the supply voltage for calculation of R.

$$R = \frac{U \text{ (supply)}}{I \text{ max. (sensor)}}$$

## Load comprising an incandescent lamp

- If the load comprises an incandescent lamp, the cold state resistance can be 10 times lower than the hot state resistance. This can cause very high current levels on switching. Fit a pre-heat resistance in parallel with the sensor.

$$R = \frac{U^2}{P} \times 10, U = \text{supply voltage and } P = \text{lamp power}$$

## Detection

### Influencing factors

The ultrasonic sensors are particularly suited for the detection of objects that are capable of reflecting an acoustic wave and, in general, having a flat surface perpendicular to the detection axis. However, the correct operation of the ultrasonic sensor can be disrupted by:

- air currents, which can accelerate or divert the acoustic wave transmitted by the sensor (ejection of part by air jet),
- high temperature gradients within the detection zone: an object emitting considerable heat can create zones of varying temperature that will modify the propagation time of the wave and thus prevent reliable operation,
- sound insulators: sound absorbing materials (cotton, fabrics, rubber, etc.),
- the angle between the face of the object to be detected and the reference axis of the sensor: when the angle is offset from 90°, the wave is no longer reflected back along the sensor axis and the operating distance is reduced. The greater the distance between the sensor and the target, the greater the effect. Detection is not possible when the angle exceeds ± 10°.
- the shape of the object to be detected: similar to the example above, an excessively angular object can be difficult to detect 1. In this case, use reflex mode detection.

### Detection systems

#### Diffuse mode

In this mode, it is the object itself that reflects the ultrasonic wave back to the sensor which, in turn, switches its output. It is the most widely used and the most simple mode. In this mode, the object will not be detected in the blind zone.

#### Reflex or beam break mode

The sensor is in a permanently detecting state on a fixed background of the machine and when the object to be detected breaks the acoustic beam the output switches state 2. This mode is particularly recommended in cases where the shape of the object changes (irregular, angular, non perpendicular) and also for objects that absorb sound (see above). This mode can be achieved by using a diffuse mode sensor (with background teaching) or, more simply, by using a ready to use reflex mode sensor.

In cases where space is restricted, a reflector 3 and 4, angled at 45°, can be used. This system can be used for both the diffuse and reflex modes. This reflector can be a flat part of the machine or a separate element. In this mode, the background of the machine must not be within the blind zone. But if the object is within this zone, it will be reliably detected.

#### Thru-beam mode

Detection is achieved using both a transmitter and receiver, with the transmitter permanently transmitting an acoustic wave to the receiver. The breaking of the beam by the presence of an object switches the output of the receiver. This mode provides long detection distances 5. In this mode there is no blind zone.

# Ultrasonic sensors

XX range, General purpose  
Cylindrical, plastic or metal  
DC supply, solid-state output



XX512A1KAM8



XX518A1KAM12



XXV18B1PAM12



XX7F1A2NAL01M12

### Diffuse system

#### M12 sensors (digital sensors – Diffuse, Thru-beam) and M18 sensors (digital sensors which are less than 0.5m – all Diffuse)

Sensors	Sensing distance (Sn) m	Function/output	Connection	Reference	Weight kg
Ø 12 Plastic	0.05	NO/PNP + NO/NPN	M8 connector	<b>XX512A1KAM8</b>	0.011
	0.1	NO/NPN	M8 connector	<b>XX512A2NAM8</b>	0.011
		NO/PNP	M8 connector	<b>XX512A2PAM8</b>	0.011

### Thru-beam system

#### M12 sensors (digital sensors – Diffuse, Thru-beam) and M18 sensors (digital sensors which are less than 0.5m – all Diffuse)

Transmitter	0.2		M8 connector	<b>XXT12A8M8</b>	0.020
Receiver	0.2	NO/PNP + NO/NPN NC/PNP + NC/NPN	M8 connector	<b>XXR12A8KAM8</b>	0.020
			M8 connector	<b>XXR12A8KBM8</b>	0.020

#### M18 sensors (digital sensors which are less than 0.5m – all Diffuse)

Ø 18 Plastic	0.15	NO/PNP + NO/NPN	M12 connector	<b>XX518A1KAM12</b>	0.033		
Ø 18 Metal	0.05	NO/NPN	Pre-cabled (L = 2 m)	<b>XXV18B1NAL2</b>	0.110		
			Pre-cabled (L = 5 m)	<b>XXV18B1NAL5</b>	0.200		
			Pre-cabled (L = 10 m)	<b>XXV18B1NAL10</b>	0.340		
			M12 connector	<b>XXV18B1NAM12</b>	0.050		
			NO/PNP	Pre-cabled (L = 2 m)	<b>XXV18B1PAL2</b>	0.110	
				Pre-cabled (L = 5 m)	<b>XXV18B1PAL5</b>	0.200	
				Pre-cabled (L = 10 m)	<b>XXV18B1PAL10</b>	0.340	
			M12 connector		<b>XXV18B1PAM12</b>	0.050	
				NC/NPN	Pre-cabled (L = 2 m)	<b>XXV18B1NBL2</b>	0.110
					Pre-cabled (L = 5 m)	<b>XXV18B1NBL5</b>	0.200
			Pre-cabled (L = 10 m)		<b>XXV18B1NBL10</b>	0.340	
			M12 connector		<b>XXV18B1NBM12</b>	0.050	
NC/PNP	Pre-cabled (L = 2 m)	<b>XXV18B1PBL2</b>		0.110			
	Pre-cabled (L = 5 m)	<b>XXV18B1PBL5</b>		0.200			
	Pre-cabled (L = 10 m)	<b>XXV18B1PBL10</b>	0.340				
M12 connector		<b>XXV18B1PBM12</b>	0.050				

### Fixed sensing distance sensors

7.6 x 19 x 33	0.10	NO/NPN	152 mm flying lead + M12 connector	<b>XX7F1A2NAL01M12</b>	0.040
		NO/PNP	152 mm flying lead + M12 connector	<b>XX7F1A2PAL01M12</b>	0.040
16 x 30 x 74	0.25	NO/NPN	M12 connector	<b>XX7K1A2NAM12</b>	0.050
		NO/PNP	M12 connector	<b>XX7K1A2PAM12</b>	0.050



Sensor type	XX512A1●	XX512A2●	XX●12A8●	XXV18B1●	XXTF● XXRF●	XX518A1●	
<b>General characteristics</b>							
Conformity to standards	CE, IEC 60947-5-2						
Product certifications	UL	UL	UL	cULus	UL	cULus	
Nominal sensing distance (Sn)	m	0.05	0.1	0.2	0.05	0.2	0.15
Blind zone (in diffuse mode the object is not detected in this zone, in reflex mode the background is not detected in this zone)	mm	0...6.4	0...6.4	–	0...2	–	0... 19
Detection window	mm	Fixed			Fixed		
Detection system	Diffuse	●	●	–	●	–	●
	Reflex	–	–	–	–	–	–
	Thru-beam	–	–	●	–	●	–
Transmission frequency (transmitter resonance)	kHz	500			360	500	200
Differential travel	mm	< 0.7	< 0.7	–	< 3	–	–
Repeat accuracy	mm	± 0.7		± 0.79	± 1.5	± 0.79	
Overall beam angle (see detection lobe)		11°	10°	10°	10°	10°	20
Minimum size of object to be detected	Cylinder Ø (in mm), at distance (in mm)	Ø 2.5 at 38	Ø 2.5 at 50	Ø 12 at 200	Ø 2.5 at 20	Ø 12.2 at 200	Ø 1.6 at 63
	Deviation angle from 90° of the object to be detected	± 10°	± 10°	–	± 8°	–	± 10°
Materials	Case	ULTEM®			Nickel plated brass	ULTEM®	
	Sensing face (5)	Epoxy			Epoxy	Epoxy	Silicone
Connection	Connector	M8, 4-pin	M8, 3-pin	M8, 4-pin	M12, 4-pin	M12, 4-pin, on 152 mm flying lead	M12, 4-pin
	Pre-cabled (wire c.s.a.)	–	–	–	3 x 0.34 mm2/ AWG 22	–	–
Sensor type	XX512A1●	XX512A2●	XX●12A8●	XXV18B1●	XX518A1●		

<b>Supply characteristics</b>							
Rated supply voltage	V	12...24 V $\overline{\text{---}}$ with protection against reverse polarity					
Voltage limits (including ripple)	V	10...28 V $\overline{\text{---}}$			10...36 V $\overline{\text{---}}$	10...28 V $\overline{\text{---}}$	
Current consumption, no-load	mA	25		50	15	60	
<b>Output characteristics</b>							
LED indicators	Output state	Yellow LED				–	
	Power on	Green LED				–	
	Setting-up assistance	–	–	–	–	–	
Switching capacity (with overload and short-circuit protection)	mA	< 100			< 200	< 100	
Voltage drop	V	< 1 (NPN); < 1.5 (PNP); 1.1 for XX●12A8, < 2 for XXV18B1●; 0.5 for XX630A2●					
Maximum switching frequency	Hz	125	125	125	80	80	
Delays	First-up	ms	20	20	20	5	350
	Response	ms	2	3	0.4	4	3
	Recovery	ms	2	3	0.4	4	3

<b>Environment characteristics</b>						
Degree of protection	Conforming to IEC 60529 and IEC 60947-5-2	IP 67			IP 65, IP 67 or (6)	IP 67
Storage temperature	°C	- 40...+ 80				
Operating temperature	°C	- 20...+ 65			0...+ 60	0...+ 50
Vibration resistance	Conforming to IEC 60068-2-6	Amplitude ± 1 mm (f = 10...55 Hz); ± 2 mm for XXV18B1●				
Mechanical shock resistance	Conforming to IEC 60068-2-27	30 gn, duration 11 ms, in all 3 axes 50 gn, duration 11 ms, in all 3 axes for XXV18B1●				
Resistance to electromagnetic interference		Conforming to IEC 60947-5-2				

(1) Only XX518A3● sensors are cCSAus certified.  
(2) Only XX6V3A1●, XX630A1●, XX630A2●, XX630S1● and XX630A3● sensors are cCSAus certified.  
(3) The first value is given for XX●18A3●, the second value for XX●18A4●.  
(4) The first value is given for XX630A1● and XX630S1●, the second value for XX630A2●.  
(5) Silicone face for optimum chemical resistance.  
(6) Double insulation for pre-cabled sensors. IP 69K for sensors with M12 connector.

## Ultrasonic sensors

XX range, General purpose

Cylindrical, plastic or metal

DC supply, solid-state output

### Dimensions

XX●12A●●●M8

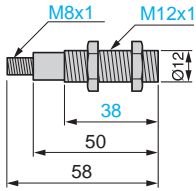

XX518A1KAM12

XXT18A●M12

XXR18A●●●●●

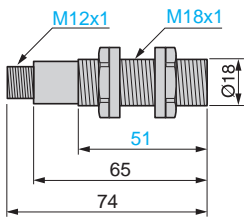

XXV18B1●●●M12

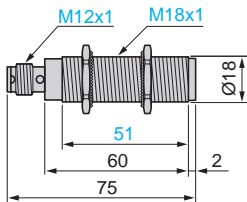

XXV18B1●●●L●

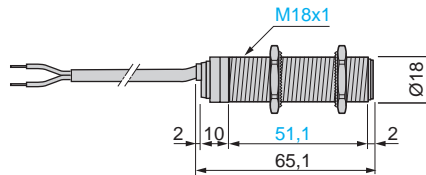

XX7F1A2●AL01M12

XXTF1A8●/XXR F1A8●

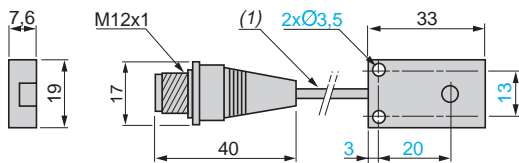

XX7K1A2●AM12

XXTK1A3●/A4●, XXRK1A3●/A4●

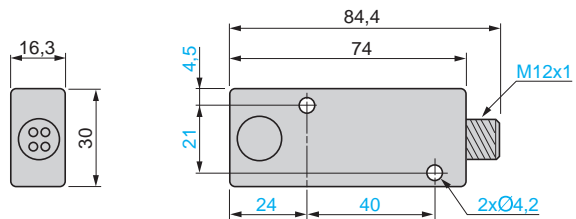

(1) Cable, length: 152 mm.

### Setting-up precautions

#### Minimum mounting distances

##### Diffuse sensors, cylindrical type

###### Side by side

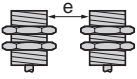

###### Face to face

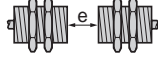

e: respect the distances indicated on the detection curves

$$e \geq 4 \times S_n$$

##### Diffuse sensors, flat format

###### Side by side

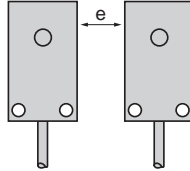

e: respect the distances indicated on the detection curves

##### XXV18●

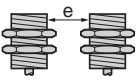

e > 25 mm

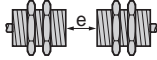

e > 700 mm

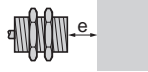

e > 60 mm

##### Thru-beam sensors

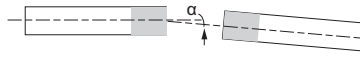

Sensors	$\alpha$
XX●12●●/XX●F1●●	$\pm 5^\circ$
XX●18A3●●/XX●K1A3●●●	$\pm 8^\circ$
XX●18A4●●/XX●K1A4	$\pm 10^\circ$
XX●18A2●●/XX●K1A2	

### Curves

#### XX512A1KAM8

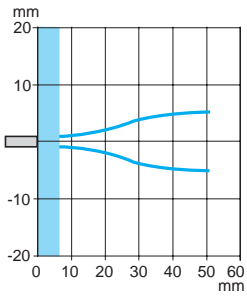

#### XX512A2●NAM8

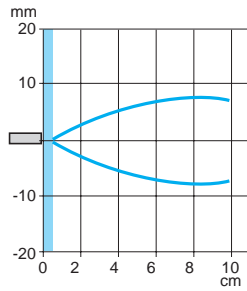

#### XX518A1KAM12

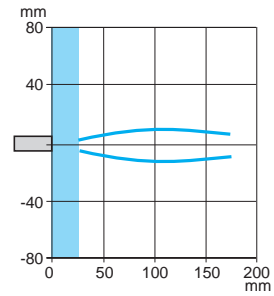

### Schemes

#### Digital output, Ø 12 sensor, M8 connector

XX512A1KAM8

XX512A2●

4-wire type

NO outputs, PNP and NPN

3-wire type

NO outputs, NPN

NO outputs, PNP

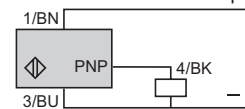
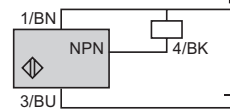
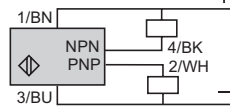
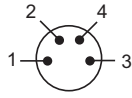

1 (+) 2 PNP output  
3 (-) 4 NPN output

(-) BU (Blue) (+) BN (Brown)  
WH (White) BK (Black)

1 (+) 3 (-)  
4 NPN or PNP output

(-) BU (Blue) (+) BN (Brown)  
BK (Black)

#### Digital output, Ø 18 sensor, M12 connector, Ø 30 (XX6V3●, XXBV3●)

XXV18B1●●M12

3-wire type

NO outputs, NPN

NO outputs, PNP

NC outputs, NPN

NC outputs, PNP

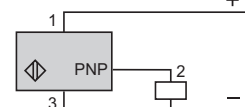
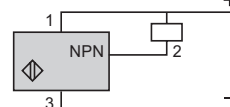
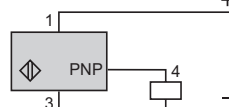
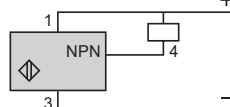
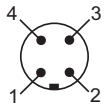

1 (+)  
3 (-)

#### Digital output, Ø 18 sensor, pre-cabled

XXV18B1●●L●

XX518A3●●L2

3-wire type

PNP/NO, NC NPN/NO, NC

PNP output

NPN output

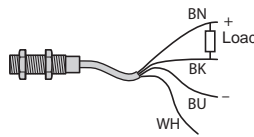
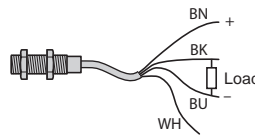
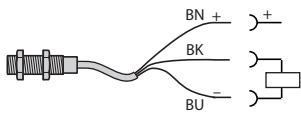

(-) BU (Blue) (+) BN (Brown) BK (Black)

#### Thru-beam sensors: XXT12●/XXR12●, XXT18●/XXR18●, XXTF1●/XXRF1●, XXTK1●/XXRK1●

Transmitter

XXT12A8M8, XXT18A3M12, XXTF1A8M12L, XXTK1A●M12

M8

M12

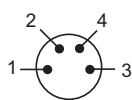
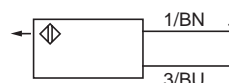

1 (+)  
3 (-)

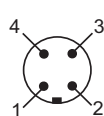

1 (+)  
3 (-)

Receiver

XXR12A8K●M8, XXRF1A8●K●M12L, XXRK1A●K●M12

M8

M12

NPN, PNP, NO

NPN, PNP, NC

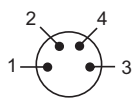

1 (+)  
2 (PNP)  
3 (-)  
4 (NPN)

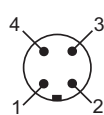

1 (+)  
2 (PNP)  
3 (-)  
4 (NPN)

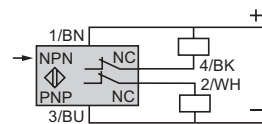
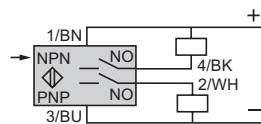

# Ultrasonic sensors

XX range, General purpose  
Cylindrical, plastic or metal  
DC supply, solid-state output



XX518A3NAL2



XX8D1A1NAM12



XX918A3C2M12



XXT18A3M12



XX7V1A1NAM12



XXZPB100

## Diffuse system

M18 sensors (digital (Diffuse) and analog sensors – 0.5 m) and Thru-beam (digital sensors 61 cm and 1 m)

Sensors	Sensing distance (Sn) m	Function/output	Connection	Reference	Weight kg
Ø 18 Plastic	0.50 (adjustable)	NO/NPN	Pre-cabled (L = 2 m)	<b>XX518A3NAL2</b>	0.08
		NO/PNP	Pre-cabled (L = 2 m)	<b>XX518A3PAL2</b>	0.08
	NO/NPN	M12 connector	<b>XX518A3NAM12</b>	0.033	
	NO/PNP	M12 connector	<b>XX518A3PAM12</b>	0.033	

## Standard analogue output

Ø 18	0.5	4-20 mA		<b>XX918A3C2M12</b>	0.033
		0-10 V		<b>XX918A3F1M12</b>	0.033

## Adjustable sensing distance sensors

18 x 33 x 60 + Ø 18	0.5 (adjustable)	NO/NPN	M12 connector	<b>XX7V1A1NAM12</b>	0.06
		NO/PNP	M12 connector	<b>XX7V1A1PAM12</b>	0.06
80 x 80 x 34	1 (adjustable)	NO/NPN	M12 connector	<b>XX8D1A1NAM12</b>	0.3
		NO/PNP	M12 connector	<b>XX8D1A1PAM12</b>	0.3

## Thru-beam (digital sensors 61 cm & 1 m)

### Ø 18

Transmitter	0.61		M12 connector	<b>XXT18A3M12</b>	0.04
Receiver	0.61	NO/PNP + NO/NPN	M12 connector	<b>XXR18A3KAM12</b>	0.04
		NC/PNP + NC/NPN	M12 connector	<b>XXR18A3KBM12</b>	0.04
Transmitter	1		M12 connector	<b>XXT18A4M12</b>	0.04
Receiver	1	NO/PNP + NO/NPN	M12 connector	<b>XXR18A4KAM12</b>	0.04
		NC/PNP + NC/NPN	M12 connector	<b>XXR18A4KBM12</b>	0.04

### 16 x 30 x 74

Transmitter	0.61		M12 connector	<b>XXTK1A3M12</b>	0.06
Receiver	0.61	NO/PNP + NO/NPN	M12 connector	<b>XXRK1A3KAM12</b>	0.06
		NC/PNP + NC/NPN	M12 connector	<b>XXRK1A3KBM12</b>	0.06
Transmitter	1		M12 connector	<b>XXTK1A4M12</b>	0.06
Receiver	1	NO/PNP + NO/NPN	M12 connector	<b>XXRK1A4KAM12</b>	0.06
		NC/PNP + NC/NPN	M12 connector	<b>XXRK1A4KBM12</b>	0.06

## Accessories

### Teach pushbutton

Teach pushbutton	For use with sensors	Reference	Weight kg
Selection of detection window Length of cable: 152 mm Input: M12 female connector Output: M12 male connector	XX918A● XX9V3A● XX9D1A●	<b>XXZPB100</b>	0.035

# Ultrasonic sensors

XX range, General purpose  
Cylindrical, plastic or metal  
DC supply, solid-state output

Sensor type		XX●18A3● XX18A4●	XX518A3● XXB18A3●	XXTK● XXRK●	XX7V● XXBV1●	XX8D● XXBD●	
<b>General characteristics</b>							
Conformity to standards		CE, IEC 60947-5-2					
Product certifications		UL	UL, cCSAus (1)	UL	UL, cCSAus (1)	UL, cCSAus (1)	
Nominal sensing distance (Sn)		m	0.60 or 1 (3)	0.50	0.6 (XX●K1A3) 1 (XX●K1A4)	0.5	1
Blind zone (in diffuse mode the object is not detected in this zone, in reflex mode the background is not detected in this zone)		mm	–	0 ... 51 (XX518A3●) 0 ... 165 (XXB18A3●)	–	0 ... 51 (XX7V1●) 0 ... 165 (XXBV1●)	0 ... 100 (XX8D●) 0 ... 315 (XXBD●)
Detection window		mm	Fixed	Remotely adjustable or by using external teach button	Fixed	Remotely adjustable or by using teach button	
Detection system	Diffuse		–	●	–	●	●
	Reflex		–	●	–	●	●
	Thru-beam		●	–	●	–	–
Transmission frequency (transmitter resonance)		kHz	300	300	200	300	180
Differential travel		mm	< 2.5	< 2.5	–	< 2.5	< 2.5
Repeat accuracy		mm	± 1.27	± 1.27	± 0.79	± 1.27	± 1.6
Overall beam angle (see detection lobe)			6°	6°	20°	12°	7°
Minimum size of object to be detected			–		XX●K1A3: Cylinder Ø 38 mm at a sensing distance of 600 mm XX●K1A4: Cylinder Ø 114 mm at a distance of 1 m	Cylinder Ø 2.5 mm or flat bar 1 mm wide for a sensing distance of 150 mm	Cylinder Ø 50 mm up to 1 m
	Cylinder Ø (in mm), at distance (in mm)		Ø 38 at 600 Ø 114 at 1000	Ø 2.5 at 150	–		
Deviation angle from 90° of the object to be detected			–	± 7°	–		
Materials	Case		ULTEM®	Valox®	ULTEM®	Valox®	Valox®
			Stainless steel 303 for XX630AS1●●●● –				
	Sensing face (5)		Silicone	Epoxy	Silicone	Epoxy	Epoxy
Connection	Connector		M12, 4-pin	M12, 4-pin	M12, 4-pin	M12, 4-pin	M12, 4-pin
	Pre-cabled (wire c.s.a.)		–	4 x 0.08 mm 2/AWG 28			

(1) Only XX518A3● sensors are cCSAus certified.

(2) Only XX6V3A1●, XX630A1●, XX630A2●, XX630S1● and XX630A3● sensors are cCSAus certified.

(3) The first value is given for XX●18A3●, the second value for XX●18A4●.

(4) The first value is given for XX630A1● and XX630S1●, the second value for XX630A2●.

(5) Silicone face for optimum chemical resistance.

**Dimensions**

XX7K1A2●AM12  
XXTK1A3●/A4●, XXRK1A3●/A4●

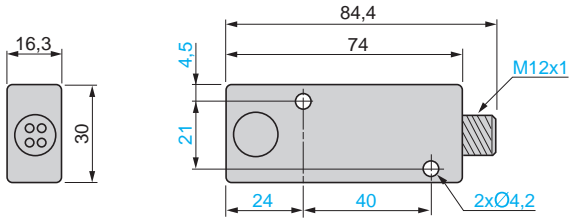

XX7V1A1●AM12  
XXBV1A1●AM12

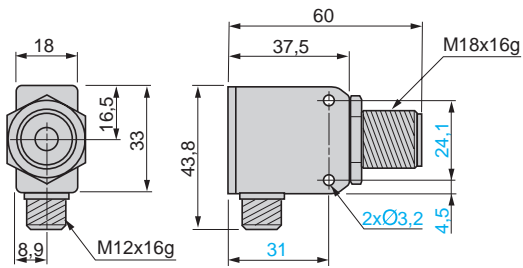

XX9V1A1●●M12

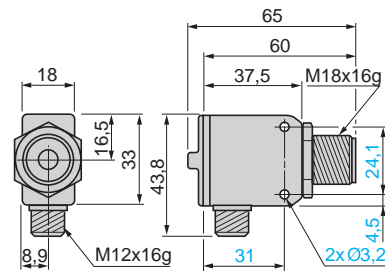

XX8D1A1●AM12  
XXBD1A1●AM12  
XX9D1A1●●AM12

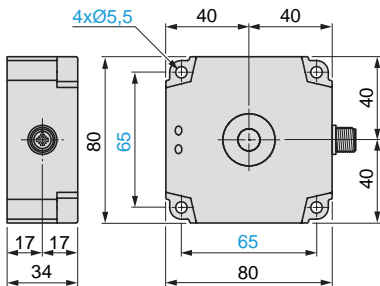

XXZPB100

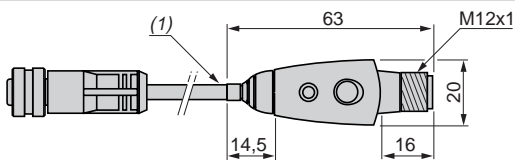

(1) Cable, length: 152 mm.

## Setting-up precautions

### Minimum mounting distances

#### Diffuse sensors, cylindrical type

##### Side by side

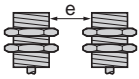

##### Face to face

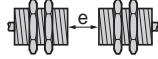

e: respect the distances indicated on the detection curves

$$e \geq 4 \times S_n$$

#### XXV18●

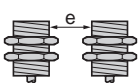

e > 25 mm

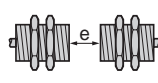

e > 700 mm

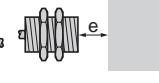

e > 60 mm

#### Diffuse sensors, flat format

##### Side by side

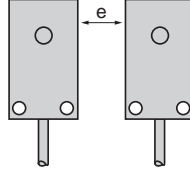

e: respect the distances indicated on the detection curves

#### Thru-beam sensors

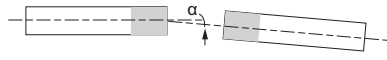

Sensors	$\alpha$
XX●12●●/XX●F1●●	$\pm 5^\circ$
XX●18A3●●/XX●K1A3●●●	$\pm 8^\circ$
XX●18A4●●/XX●K1A4	$\pm 10^\circ$
XX●18A2●●/XX●K1A2	

## Curves

XX218A3●●M12, XX518A3●●L2, XXB18A3●AM12, XX518A3●AM12  
XX7V1A1●AM12, XXBV1A1●AM12  
XX918A3●●M12, XX9V1A1●●M12

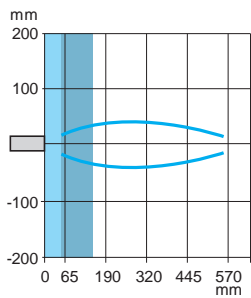

Blind zone for diffuse sensors.

Blind zone for reflex sensors.

## Schemes

### Digital output, $\varnothing 18$ sensor, M12 connector, $\varnothing 30$ (XX6V3●, XXBV3●)

XX518A3●, XXB18A3●, XX6V3●, XXBV3●, XX218A3●, XX7V1●, XXBV1●, XX8D1●, XXBD1●

#### 3-wire type

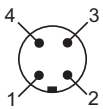

1 (+) 2 Teach input (WH)  
3 (-) 4 NPN or PNP output

#### NO outputs, NPN

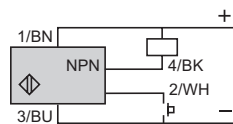

(-) BU (Blue) (+) BN (Brown)  
BK (Black)

#### NO outputs, PNP

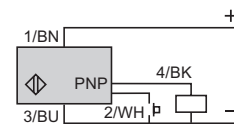



# Ultrasonic sensors

XX range, General purpose

Cylindrical, plastic or metal, Ø 18 mm

Diffuse system, solid-state digital or analog output

Configurable by software



XXA18P1-M12



XXS18P1-M12



XXA18B1-M12  
XXA18S1-M12



XXS18B1-M12  
XXS18S1-M12



XXZPB100

## Ultrasonic sensors

### Sensors with solid-state digital output, M12 connector

Sensors	Sensing distance (Sn) Adjustable	Function/output	Sensing axis	Reference	Weight
					kg
Ø 18 Plastic	1	NO or NC (1) /PNP	Straight	XXS18P1PM12	0.033
			90° angled	XXA18P1PM12	0.040
Ø 18 Nickel-plated brass	1	NO or NC (1) /PNP	Straight	XXS18B1PM12	0.050
			90° angled	XXA18B1PM12	0.055
Ø 18 Stainless steel 316L	1	NO or NC (1) /PNP	Straight	XXS18S1PM12	0.050
			90° angled	XXA18S1PM12	0.055

### Sensors with analog output, M12 connector

Sensors	Sensing distance (Sn) Adjustable	Analog output (2)	Sensing axis	Reference	Weight
					kg
Ø 18 Plastic	1	4-20 mA	Straight	XXS18P1AM12	0.033
			90° angled	XXA18P1AM12	0.040
		0-10 V	Straight	XXS18P1VM12	0.033
			90° angled	XXA18P1VM12	0.040
Ø 18 Nickel-plated brass	1	4-20 mA	Straight	XXS18B1AM12	0.050
			90° angled	XXA18B1AM12	0.055
		0-10 V	Straight	XXS18B1VM12	0.050
			90° angled	XXA18B1VM12	0.055
Ø 18 Stainless steel 316L	1	4-20 mA	Straight	XXS18S1AM12	0.050
			90° angled	XXA18S1AM12	0.055
		0-10 V	Straight	XXS18S1VM12	0.050
			90° angled	XXA18S1VM12	0.055

## Accessories

Description	For use with sensor	Reference	Weight kg
Teach pushbutton Input: M12 female connector Output: M12 male connector	XXS18●● XXA18●●	XXZPB100	0.035

### Configuration interface and configuration kit for the synchronization function

See page 34.

(1) Output function (NO or NC) and mode (window, reflex, proximity, pump) are selectable using the XXZPB100 remote teach pushbutton.

(2) Selectable using the XXZPB100 remote teach pushbutton.

# Ultrasonic sensors

XX range, General purpose

Cylindrical, plastic or metal, Ø 18 mm

Diffuse system, solid-state digital or analog output

Configurable by software



## Accessories

Description	Type	Length m	Reference	Weight kg
-------------	------	----------	-----------	-----------

### Connection accessories for synchronization function

Pre-wired connector 5-pin, 5-wire female M12 connector/ bare wires PVC cable	Straight	2	<b>XZCPV11V12L2</b>	0.090
		5	<b>XZCPV11V12L5</b>	0.201
		10	<b>XZCPV11V12L10</b>	0.360
	Elbowed	2	<b>XZCPV12V12L2</b>	0.090
		5	<b>XZCPV12V12L5</b>	0.201
		10	<b>XZCPV12V12L10</b>	0.360

### Connection accessories without synchronization function

Pre-wired connector 5-pin, 4-wire female M12 connector/ bare wires PVC cable	Straight	2	<b>XZCP1141L2</b>	0.090
		5	<b>XZCP1141L5</b>	0.190
		10	<b>XZCP1141L10</b>	0.370
	Elbowed	2	<b>XZCP1241L2</b>	0.090
		5	<b>XZCP1241L5</b>	0.190
		10	<b>XZCP1241L10</b>	0.370
Female M12 connector 5-pin, Pg 7 cable gland	Straight	–	<b>XZCC12FDM50B</b>	0.020
	Elbowed	–	<b>XZCC12FCM50B</b>	0.020

### Mounting accessory

Description	For use with sensor	Reference	Weight kg
Fixing clamp (1)	XXS18●● XXA18●●	<b>XXZB118</b>	0.010

(1) Recommended to use in applications below 0°C.

## Ultrasonic sensors

XX range, General purpose

Cylindrical, plastic or metal, Ø 18 mm

Diffuse system, solid-state digital or analog output

Configurable by software

Sensor type		XX●18●1PM12	XX●18●1AM12	XX●18●1VM12
<b>General characteristics</b>				
Conformity to standards		EN/IEC 60947-5-2, UL 508, and CSA C22.2 n°14		
Compliance with regulations		CE (based on EMC directive 2014/30/EU), NEC (ANSI/NFPA 70), CEC (CSA C22), UNECE R10		
Product certifications		cULus with class 2 power supply, E2, EAC, and RCM		
Nominal sensing distance (Sn)		m	1 (adjustable)	
Blind zone (in diffuse mode the object is not detected in this zone)		m	0.105	
Detection window		Remotely adjustable or by using external teachbutton <b>XXZPB100</b>		
Transmission frequency (transmitter resonance)		kHz	200	
Differential travel		mm	< 5	–
Repeat accuracy (repeatability)		0.1 %		
Minimum size of object to be detected		Cylinder Ø 1 mm up to sensing distance of 0.6 m		
Tilt angle with 100 x 100 mm target		± 7° at 1 m, ± 35° at 0.5 m, ± 10° at 0.9 m		
Materials	Case	XX●18P●●: PBT XX●18B●●: Nickel-plated brass XX●18S●●: Stainless steel 316L		
	Sensing face	Epoxy, polyurethane, and butyl		
Connection		M12 connector - 5-pin		
<b>Supply characteristics</b>				
Rated supply voltage (Ue) with protection against reverse polarity		V	12...24 V $\overline{\text{---}}$	24 V $\overline{\text{---}}$
Voltage limits (including ripple)		V	10...30 V $\overline{\text{---}}$	10...30 V $\overline{\text{---}}$
Current consumption, no-load		mA	< 30	< 30
<b>Output characteristics</b>				
LED indicators	Output state		Yellow LED	Yellow LED
	Echo state		Green LED	Green LED
Switching capacity (with overload and short-circuit protection)			< 100 mA	–
Resistive load impedance		Ω	–	12 V $\overline{\text{---}}$ : load ≤ 250 Ω 24 V $\overline{\text{---}}$ : load ≤ 850 Ω
Voltage drop		V	< 2	–
Internal temperature compensation			Yes	Yes
Maximum switching frequency		Hz	11	–
Delays	First-up	ms	120	180
	Response	ms	45	–
	Recovery	ms	45	100
<b>Environment characteristics</b>				
Degree of protection Conforming to IEC 60529 and EN/IEC 60947-5-2			IP 65, IP 67	
Storage temperature		°C	- 40...+ 80	
Operating temperature		°C	- 25...+ 70 (1)	
Relative humidity			< 95%, without condensation	
Vibration resistance Conforming to IEC 60068-2-6			Amplitude ± 1 mm (f = 10...55 Hz)	
Mechanical shock resistance Conforming to IEC 60068-2-27			30 gn, duration 11 ms, in all 3 axes	
Resistance to electromagnetic interference			Conforming to EN/IEC 60947-5-2 and UNECE R10-05	

(1) For applications below 0°C, it is recommended to use the **XXZB118** fixing clamp (see page 36).

# Ultrasonic sensors

XX range, General purpose

Cylindrical, plastic or metal, Ø 18 mm

Diffuse system, solid-state digital or analog output

Configurable by software

## Operating diagrams for digital output sensors

### Settings with teach procedure

#### Window mode

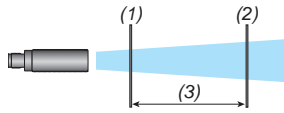

(1): Near limit  
(2): Far limit  
(3): Sensing window

#### Reflex mode

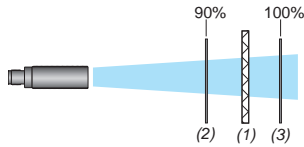

(1): Reflector  
(2): Near limit  
(3): Far limit

#### Proximity mode

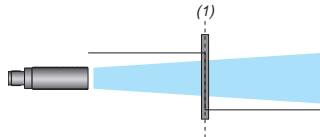

(1) Switch point

#### Pump/Hysteresis mode

##### Emptying (stored in high threshold memory)

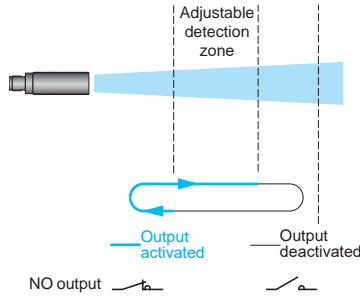

##### Filling (stored in low threshold memory)

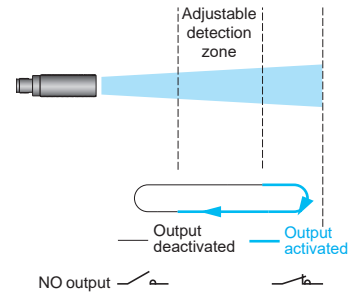

## Operating diagram for analog output sensors

### Near and far limits setting with teach procedure

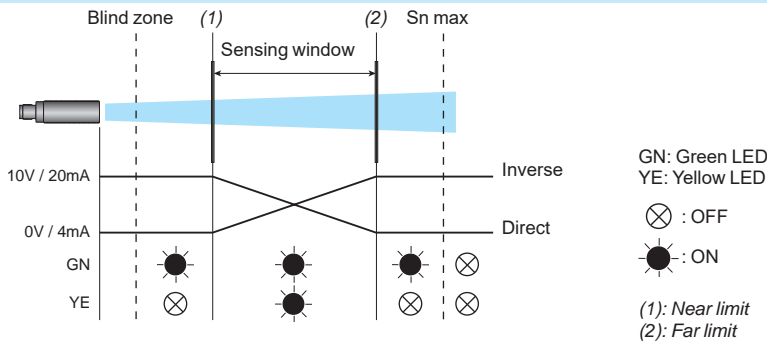

## Diagram for the synchronization function (side by side application)

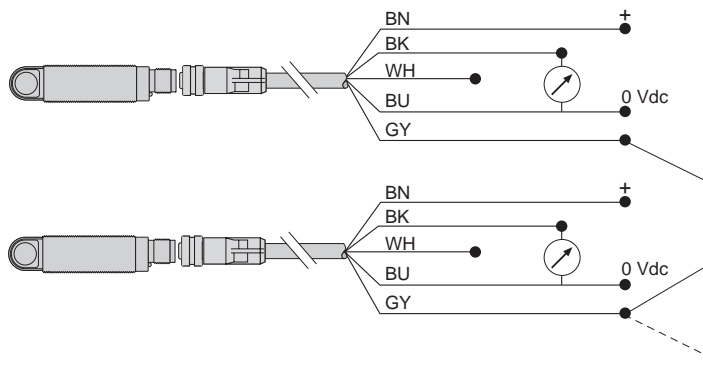

**NB:** To enable synchronization between several sensors, all of the wires of pin no.5 (gray) must be electrically connected together. A maximum of 8 sensors can be synchronized. To enable "Multiplexer" function for the sensors, use the XX Configuration Software. Without synchronization or multiplexing, the sensors must be at least 50 cm away from each other in order to avoid mutual interference.

# Ultrasonic sensors

XX range, General purpose

Cylindrical, plastic or metal, Ø 18 mm

Diffuse system, solid-state digital or analog output

Configurable by software

## Curves

Detection curve with 100 x 100 mm square target

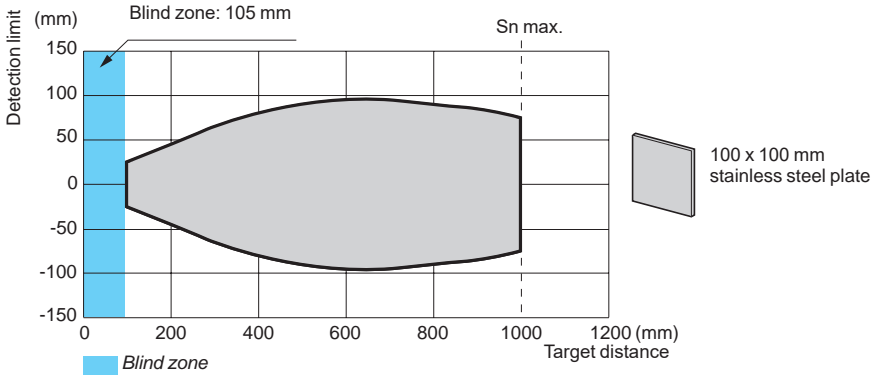

Detection curve with round bar

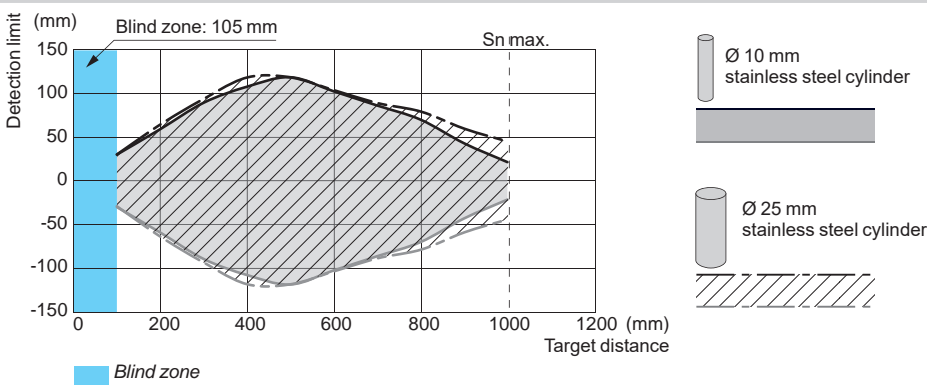

## Dimensions

### Plastic sensors, straight

XXS18P1•M12

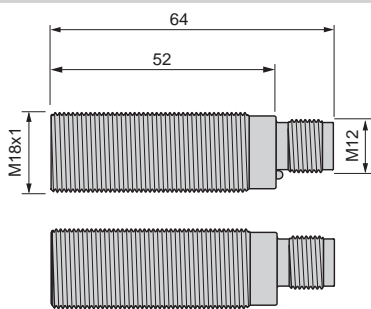

### Plastic sensors, 90° angled

XXA18P1•M12

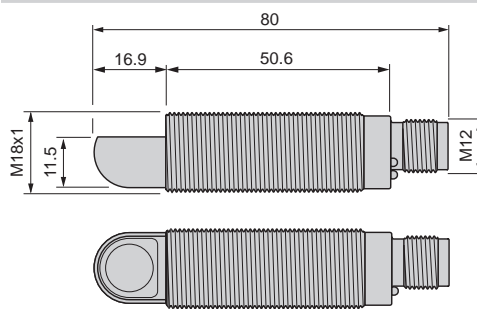

### Nickel-plated brass and stainless steel sensors, straight

XXS18B1•M12 and XXS18S1•M12

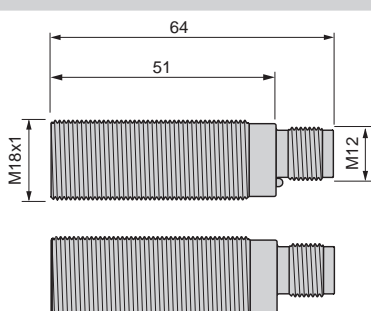

### Nickel-plated brass and stainless steel sensors, 90° angled

XXA18B1•M12 and XXA18S1•M12

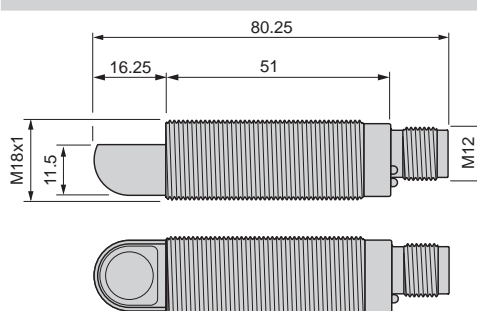

# Ultrasonic sensors

XX range, General purpose  
Cylindrical, plastic or metal, Ø 18 mm  
Diffuse system, solid-state digital or analog output  
Configurable by software

## Dimensions (continued)

### Fixing clamp XXZB118

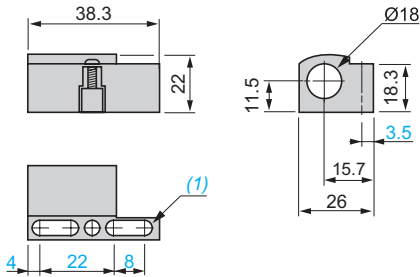

(1) 2 elongated holes Ø 4 X 8 mm

### Teach pushbutton XXZPB100

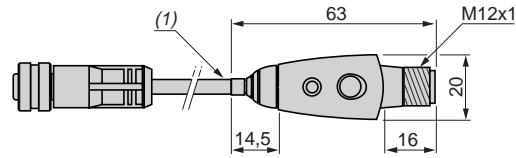

(1) Cable length: 152 mm

## Connections

### Connector wiring

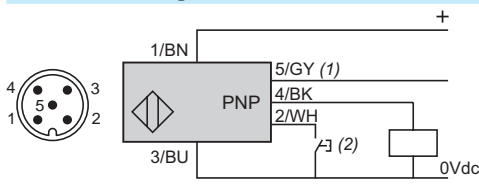

Pin number	Wire color	Digital output description	Analog output description	
			4-20 mA	0-10 V
1	BN: Brown	+12...24 V $\overline{\text{---}}$	+12...24 V $\overline{\text{---}}$	+14...24 V $\overline{\text{---}}$
2	WH: White	Input teach		
3	BU: Blue	0 V $\overline{\text{---}}$		
4	BK: Black	Output		
5	GY: Gray	Synchronization		

(1) Synchronization.

(2) External setting pushbutton or XXZPB100 remote teach pushbutton (see page 36).

### Wiring scheme (digital output NO or NC)

#### XXS18•1PM12 and XXA18•1PM12

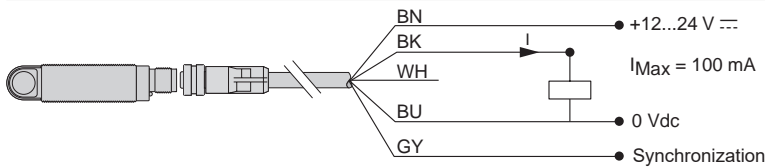

### Wiring scheme (analog output 4-20 mA)

#### XXS18•1AM12 and XXA18•1AM12

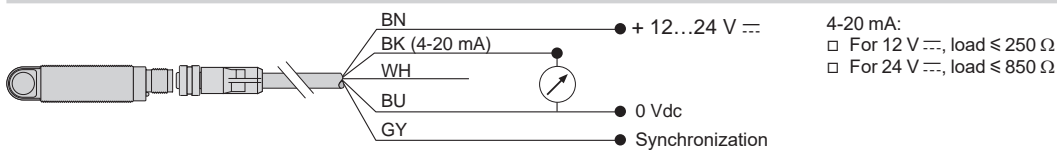

### Wiring scheme (analog output 0-10 V)

#### XXS18•1VM12 and XXA18•1VM12

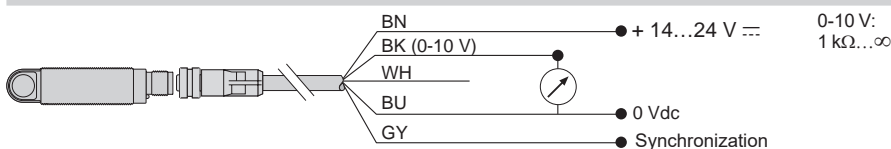

# Ultrasonic sensors

XX range, General purpose  
Cylindrical, plastic or metal  
DC supply, solid-state output



### Diffuse system

#### M30 sensors (digital & analog sensors – 1m, 2m, 8m) – Diffuse, Reflex

Sensors	Sensing distance (Sn) m	Function/output	Connection	Reference	Weight kg
Ø 30 Plastic	1 (adjustable)	NO/PNP + NO/NPN	M12 connector	XX630A1KAM12	0.09
		NO/NPN	M12 connector	XX6V3A1NAM12	0.09
		NO/PNP	M12 connector	XX6V3A1PAM12	0.09
		NO/NPN + NC/NPN	M12 connector	XX630A1NCM12	0.09
			M12 connector	XX630S1NCM12 (1)	0.09
		NO/PNP + NC/PNP	M12 connector	XX630A1PCM12	0.09
		M12 connector	XX630S1PCM12 (1)	0.09	
	2 (adjustable)	NO/NPN + NC/NPN	M12 connector	XX630A2NCM12	0.09
		NO/PNP + NC/PNP	M12 connector	XX630A2PCM12	0.09
	8 (adjustable)	NO/NPN + NC/NPN	M12 connector	XX630A3NCM12	0.11
		NO/PNP + NC/PNP	M12 connector	XX630A3PCM12	0.11

### Reflex system

Ø 30 Plastic	1 (adjustable)	NO/PNP	M12 connector	XXBV3A1PAM12	0.09
--------------	----------------	--------	---------------	--------------	------

### Standard analogue output

Sensors	Sensing distance (Sn) m	Analogue output (Slope selection using teach button)	Reference	Weight kg
Ø 30	1	4-20 mA	XX930A1A2M12	0.095
			XX930S1A2M12 (1)	0.095
		0-10 V	XX930A1A1M12	0.095
			XX930S1A1M12 (1)	0.095
		4-20 mA	XX9V3A1C2M12	0.090
			0-10 V	XX9V3A1F1M12
	2	4-20 mA	XX930A2A2M12	0.095
		0-10 V	XX930A2A1M12	0.095
	8	4-20 mA	XX930A3A2M12	0.115
		0-10 V	XX930A3A1M12	0.115

### 250 ms delayed analogue output (for unstable object)

Ø 30	1	4-20 mA	XX930A1A2230M12	0.095
		0-10 V	XX930A1A1230M12	0.095
	2	4-20 mA	XX930A2A2230M12	0.095
		0-10 V	XX930A2A1230M12	0.095

# Ultrasonic sensors

XX range, General purpose  
Cylindrical, plastic or metal  
DC supply, solid-state output

Sensor type	XX6V3A1● XXBV3A1●	XX630A1● XX630A2● XX630S1●	XX630A3●	XX930A1● XX930A2● XX930S1●	XX930A3●	XX9V3A1●	
<b>General characteristics</b>							
Conformity to standards	CE, IEC 60947-5-2			CE, IEC 60947-5-2			
Product certifications	UL, cCSAus (2)			UL, cCSAus			
Nominal sensing distance (Sn)	m	1	1 or 2 (4)	8	1 or 2 (6)	8	1
Blind zone (in diffuse mode the object is not detected in this zone, in reflex mode the background is not detected in this zone)	mm	0 ... 100 (XX6V3A1●) 0 ... 315 (XXBV3A1●)	0...51 (XX630●1) 0...120 (XX630A2●)	0...300	0...51 or 0...120 (6)	0...300	0...100
Detection window	mm	Remotely adjustable or by using external teach button	Adjustable using teach button on sensor	Adjustable using teach button on sensor	Adjustable using teach button on sensor	Remotely adjustable or by using external teach button	
Detection system	Diffuse	●	●	●	–	–	–
	Reflex	●	–	–	–	–	–
	Thru-beam	–	–	–	–	–	–
Transmission frequency (transmitter resonance)	kHz	180	200	75	200	75	180
Differential travel	mm	< 2.5	< 2.5	< 12.7			
Repeat accuracy	mm	± 1.6	± 0.87	± 2.54	± 0.9	± 2.54	± 0.9 1.6mm
Overall beam angle (see detection lobe)		7°	10°	16°	10°	16°	7°
Minimum size of object to be detected		Cylinder Ø 50 at distance 1000mm	Cylinder Ø 1.6 at distance 635mm	Cylinder Ø 51 at distance 4732mm	Cylinder Ø 1.6 mm up to a sensing distance of 635 mm	Cylinder Ø 50.68 mm up to a sensing distance of 4732 mm	Cylinder Ø 50 mm up to a sensing distance of 1 m
Deviation angle from 90° of the object to be detected		± 5°	± 7° or ± 10° (4)	± 5°	± 8°	± 5°	± 5°
Materials	Case	Valox®	ULTEM®	ULTEM®	ULTEM®: XX930A1● and XX930A2●	ULTEM®	Valox®
		Stainless steel 303 for XX630AS1●●●●			Stainless steel 303: XX930S1●	–	
	Sensing face (5)	Epoxy	Silicone	Epoxy	Silicone	Epoxy	
Connection	Connector	M12, 4-pin					
	Pre-cabled (wire c.s.a.)	–					

(1) Only XX518A3● sensors are cCSAus certified.

(2) Only XX6V3A1●, XX630A1●, XX630A2●, XX630S1● and XX630A3● sensors are cCSAus certified.

(3) The first value is given for XX●18A3●, the second value for XX●18A4●.

(4) The first value is given for XX630A1● and XX630S1●, the second value for XX630A2●.

(5) Silicone face for optimum chemical resistance.

(6) The first value is given for XX930A1● and XX930S1●, the second value for XX930A2●.



# Ultrasonic sensors

XX range, General purpose  
Cylindrical, plastic or metal  
DC supply, solid-state output

Sensor type		XX6V3A1● XXBV3A1●	XX630A1● XX630A2● XX630S1●	XX630A3●	XX930A1● XX930A2● XX930S1●	XX930A3●	XX9V3A1●	
<b>Supply characteristics</b>								
Rated supply voltage	V	12...24 V $\overline{\text{---}}$ with protection against reverse polarity			15...24 V $\overline{\text{---}}$	15...24 V $\overline{\text{---}}$	15...24 V $\overline{\text{---}}$	
Voltage limits (including ripple)	V	10...28 V $\overline{\text{---}}$			10...28 V $\overline{\text{---}}$	–		
Current consumption, no-load	mA	60	50 or 100 (1)	50	60 or 80 (3)	60	60	
<b>Output characteristics</b>								
LED indicators	Output state	Yellow LED			Yellow LED	–		
	Power on	Green LED			Green LED	–		
	Setting-up assistance	Multicolour LED			Dual colour LED	–		
Slope type		–			Direct or inverse by using teach button, see page 36.			
Switching capacity (with overload and short-circuit protection)	mA	< 100			–	–		
Voltage drop	V	< 100			–	–		
Maximum switching frequency	Hz	70	10 or 16 (1)	2	–	–		
Delays	First-up	ms	75	720	800	720	1200	75
	Response	ms	15	20 or 25 (1)	200			
	Recovery	ms	75	20	200	250 (delayed) 50 (standard)	250	180
Resistive load impedance	4-20 mA	$\Omega$	–			10...500		10...350
	0-10 V	$\Omega$	–			1 k... $\infty$		2 k... $\infty$
<b>Environment characteristics</b>								
Degree of protection	Conforming to IEC 60529 and IEC 60947-5-2	IP 67	IP 65 or IP 67 (1) IP67 for plastic versions... IP65 for stainless steel versions	IP 67	IP 67	IP 67	IP 67	
Storage temperature	°C	-40...+80						
Operating temperature	°C	0...+70	0...+60 or 0...+50 (1)	-20...+60	0...+50	-20...+60	0...+70	
Vibration resistance	Conforming to IEC 60068-2-6	Amplitude $\pm$ 1 mm (f = 10...55 Hz); $\pm$ 2 mm for XXV18B1●			Amplitude $\pm$ 1 mm (f = 10...55 Hz)			
Mechanical shock resistance	Conforming to IEC 60068-2-27	30 gn, duration 11 ms, in all 3 axes 50 gn, duration 11 ms, in all 3 axes for XXV18B1●			30 gn, duration 11 ms, in all 3 axes			
Resistance to electromagnetic interference		Conforming to IEC 60947-5-2						

(1) The first value is given for XX630A1● and XX630S1●, the second value for XX630A2●.

(2) Double insulation for pre-cabled sensors. IP 69K for sensors with M12 connector.

(3) The first value is given for XX930A1● and XX930S1●, the second value for XX930A2●.

## Dimensions

XX630A1●●M12  
XX630S1●●M12  
XX630A2●●M12  
XX930A1A●M12  
XX230A1●●A00M12  
XX230A2●●A00M12

XX6V3A1●AM12  
XXBV3A1●AM12  
XX9V3A1●●M12

XX630A3●●M12  
XX930A3A●M12

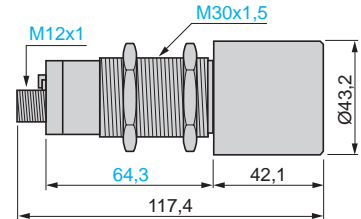
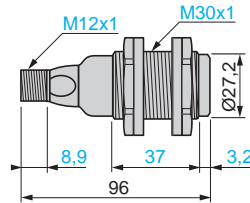
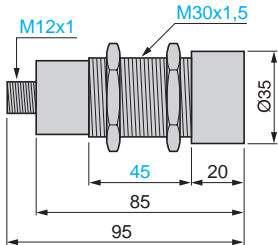

## Curves

XXV18B1●

Square object

Cylindrical object

XX630A2●CM12

XX630A3●CM12  
XX930A3●●M12

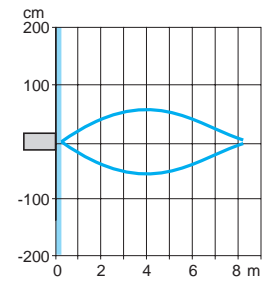
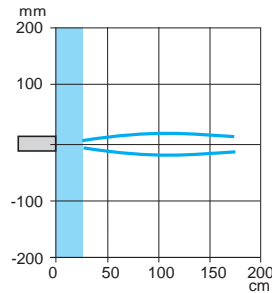
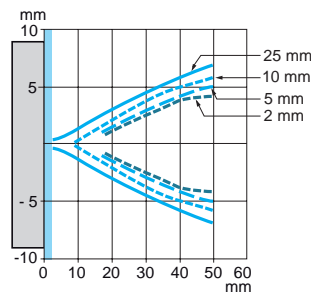
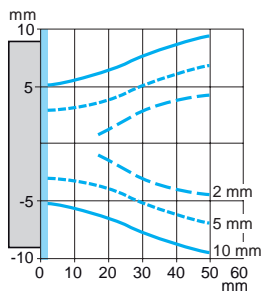

XX230A1●, XX630A1●CM12,  
XX6V3A1●AM12, XXBV3A1●AM12,  
XX930A1●●M12, XX9V3A1●●M12,  
XX8D1A1●AM12, XXBD1A1●AM12

XX7F1A2●AL01M12

XX7K1A2●AM12

XX230A2●

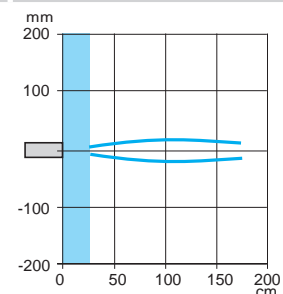
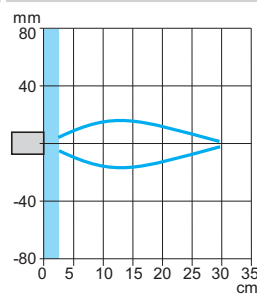
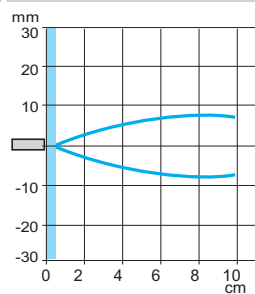
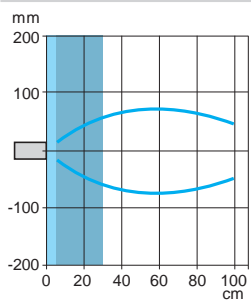

Blind zone for diffuse sensors.  
 Blind zone for reflex sensors.

# Ultrasonic sensors

XX range, Application

Sensors for monitoring 2 levels

Cylindrical plastic case, M18 x 1 and M30 x 1.5

DC supply, solid-state output



XX218A3NHM12



XX230A12NA00M12

## Application - Sensors for monitoring 2 levels

Sensors	Sensing distance (Sn) m	Function/output	Reference	Weight kg
<b>Ø 18, threaded M18 x 1</b>				
2 emptying levels	0.5 (adjustable)	NO/NPN	<b>XX218A3NHM12</b>	0.035
		NO/PNP	<b>XX218A3PHM12</b>	0.035
2 filling levels	0.5 (adjustable)	NO/NPN	<b>XX218A3NFM12</b>	0.035
		NO/PNP	<b>XX218A3PFM12</b>	0.035
<b>Ø 30, threaded M30 x 1.5</b>				
2 levels 2 independent outputs	1 (adjustable)	NO/NPN + NO/NPN	<b>XX230A12NA00M12</b>	0.090
		NO/PNP + NO/PNP	<b>XX230A12PA00M12</b>	0.090
	2 (adjustable)	NO/NPN + NO/NPN	<b>XX230A22NA00M12</b>	0.090
		NO/PNP + NO/PNP	<b>XX230A22PA00M12</b>	0.090
2 emptying levels	1 (adjustable)	NO/PNP + NO/PNP	<b>XX230A10PA00M12</b>	0.090
		NO/PNP + NO/PNP	<b>XX230A20PA00M12</b>	0.090
2 filling levels	1 (adjustable)	NO/PNP + NO/PNP	<b>XX230A11PA00M12</b>	0.090
		NO/PNP + NO/PNP	<b>XX230A21PA00M12</b>	0.090

## Accessories

### Teach pushbutton

Teach pushbutton	For use with sensors	Reference	Weight kg
Selection of detection window Length of cable: 152 mm Input: M12 female connector Output: M12 male connector	XX218A3●	<b>XXZPB100</b>	0.035

### Other connection and fixing accessories

See page 48.

Sensor type		XX218A3●●●●	XX230A1●●●●	XX230A2●●●●
<b>General characteristics</b>				
Conformity to standards		CE, IEC 60947-5-2		
Product certifications		UL, cCSAus	UL, cCSAus	UL, cCSAus
Nominal sensing distance (Sn)		<b>m</b> 0.50 (adjustable)	1 (adjustable)	2 (adjustable)
Blind zone (no object must pass through this zone whilst the sensor is operating)		<b>mm</b> 0...51	0...51	0...120
Detection window		Remotely adjustable or by using external teach button	Adjustable using teach button on sensor	
Transmission frequency		<b>kHz</b> 300	200	
Differential travel		<b>mm</b> < 2.5	< 2.5	< 2.5
Repeat accuracy		<b>mm</b> ± 1.27	± 0.9	
Overall beam angle (see detection lobe)		6°	10°	10°
Minimum size of object to be detected		Cylinder Ø 2.5 mm up to a sensing distance of 150 mm	Cylinder Ø 1.6 mm up to a sensing distance of 305 mm	
Deviation angle from 90° of the object to be detected		± 7°	± 10° on 305 x 305 mm	
Materials		Case	Valox®	ULTEM®
		Sensing face (1)	Epoxy	Silicone
Connection		Connector	M12, 4-pin	
<b>Supply characteristics</b>				
Rated supply voltage		<b>V</b> 12...24 V $\overline{\text{---}}$ with protection against reverse polarity		
Voltage limits (including ripple)		<b>V</b> 10...28 V $\overline{\text{---}}$		
Current consumption, no-load		<b>mA</b> 40	100	
<b>Output characteristics</b>				
LED indicators		Output state	Yellow LED	Multicolour LED
		Power on	Green LED	–
		Setting-up assistance	Dual colour LED	Multicolour LED
		Distance indication	–	Yellow LED
Switching capacity		<b>mA</b> < 100 (PNP and NPN) with overload and short-circuit protection		
Voltage drop		<b>V</b> < 1 (PNP and NPN)		
Delays		First-up	<b>ms</b> 100	1000
		Response	<b>ms</b> 15	150
		Recovery	<b>ms</b> 1000	1000
<b>Environment characteristics</b>				
Degree of protection		Conforming to IEC 60529 and IEC 60947-5-2	IP 67	IP 65
Storage temperature		<b>°C</b> - 40...+ 80	- 10...+ 80	
Operating temperature		<b>°C</b> - 20...+ 65	0...+ 50	
Vibration resistance		Conforming to IEC 60068-2-6	Amplitude ± 1 mm (f = 10...55 Hz)	
Mechanical shock resistance		Conforming to IEC 60068-2-27	30 gn, duration 11 ms, in all 3 axes	
Resistance to electromagnetic interference			Conforming to IEC 60947-5-2	

(1) Silicone face for optimum chemical resistance.

### Dimensions

XX518A3●AM12  
XXB18A3●AM12  
XX918A3●AM12  
XX218A3●M12

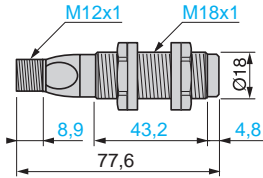

XX630A1●M12  
XX630S1●M12  
XX630A2●M12  
XX930A1A●M12  
XX230A1●A00M12  
XX230A2●A00M12

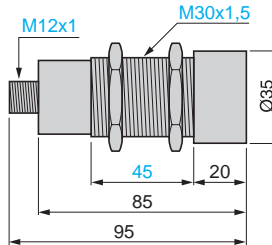

### Setting-up precautions

#### Minimum mounting distances

##### Diffuse sensors, cylindrical type

###### Side by side

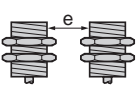

###### Face to face

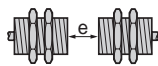

e: respect the distances indicated on the detection curves

$e \geq 4 \times S_n$

##### Diffuse sensors, flat format

###### Side by side

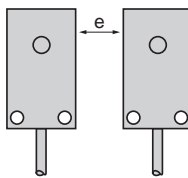

e: respect the distances indicated on the detection curves

##### XXV18●

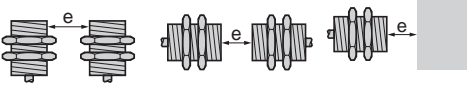

$e > 25 \text{ mm}$

$e > 700 \text{ mm}$

$e > 60 \text{ mm}$

##### Thru-beam sensors

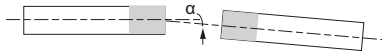

Sensors	$\alpha$
XX●12●/XX●F1●	$\pm 5^\circ$
XX●18A3●/XX●K1A3●●●	$\pm 8^\circ$
XX●18A4●/XX●K1A4	$\pm 10^\circ$
XX●18A2●/XX●K1A2	

### Curves

XX218A3●M12, XX518A3●L2, XXB18A3●AM12, XX518A3●AM12  
XX7V1A1●AM12, XXBV1A1●AM12  
XX918A3●M12, XX9V1A1●M12

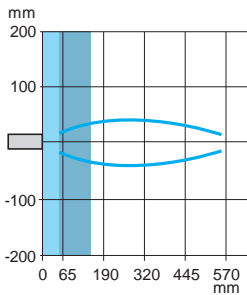

XX230A1●, XX630A1●CM12,  
XX6V3A1●AM12, XXBV3A1●AM12, XX930A1●M12, XX9V3A1●M12,  
XX8D1A1●AM12, XXBD1A1●AM12

##### XX230A2●

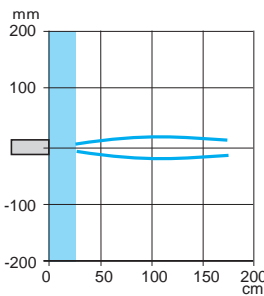
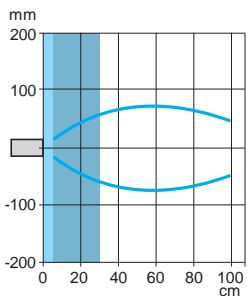

Blind zone for diffuse sensors.

Blind zone for reflex sensors.

# Ultrasonic sensors

XX range, General purpose  
Flat format, plastic  
DC supply, solid-state output



XX7V1A1NAM12



XX7F1A2NAL01M12



XX7K1A2NAM12



XXZPB100

## Diffuse system

### Fixed sensing distance sensors

Sensors	Sensing distance (Sn)	Function/output	Connection	Reference	Weight
mm	m				kg
7.6 x 19 x 33	0.10	NO/NPN	152 mm flying lead + M12 connector	<b>XX7F1A2NAL01M12</b>	0.040
		NO/PNP	152 mm flying lead + M12 connector	<b>XX7F1A2PAL01M12</b>	0.040
16 x 30 x 74	0.25	NO/NPN	M12 connector	<b>XX7K1A2NAM12</b>	0.050
		NO/PNP	M12 connector	<b>XX7K1A2PAM12</b>	0.050

### Adjustable sensing distance sensors

18 x 33 x 60 + Ø 18	0.50 (adjustable)	NO/NPN	M12 connector	<b>XX7V1A1NAM12</b>	0.060
		NO/PNP	M12 connector	<b>XX7V1A1PAM12</b>	0.060
80 x 80 x 34	1 (adjustable)	NO/NPN	M12 connector	<b>XX8D1A1NAM12</b>	0.300
		NO/PNP	M12 connector	<b>XX8D1A1PAM12</b>	0.300

## Reflex system

### Adjustable sensing distance sensors

Sensors	Sensing distance (Sn)	Function/output	Connection	Reference	Weight
mm	m				kg
18 x 33 x 60 + Ø 18	0.50 (adjustable)	NO/PNP	M12 connector	<b>XXBV1A1PAM12</b>	0.060
80 x 80 x 34	1 (adjustable)	NO/PNP	M12 connector	<b>XXBD1A1PAM12</b>	0.300

## Thru-beam system

Sensors	Sensing distance (Sn)	Function/output	Connection	Reference	Weight
mm	m				kg
<b>7.6 x 19 x 33</b>					
Transmitter	0.20	–	152 mm flying lead + M12 connector	<b>XXTF1A8M12L</b>	0.030
Receiver	0.20	NO/PNP + NO/NPN	152 mm flying lead + M12 connector	<b>XXRF1A8KAM12L</b>	0.030
		NC/PNP + NC/NPN	152 mm flying lead + M12 connector	<b>XXRF1A8KBM12L</b>	0.030
<b>16 x 30 x 74</b>					
Transmitter	0.61	–	M12 connector	<b>XXTK1A3M12</b>	0.060
Receiver	0.61	NO/PNP + NO/NPN	M12 connector	<b>XXRK1A3KAM12</b>	0.060
		NC/PNP + NC/NPN	M12 connector	<b>XXRK1A3KBM12</b>	0.060
Transmitter	1	–	M12 connector	<b>XXTK1A4M12</b>	0.060
Receiver	1	NO/PNP + NO/NPN	M12 connector	<b>XXRK1A4KAM12</b>	0.060
		NC/PNP + NC/NPN	M12 connector	<b>XXRK1A4KBM12</b>	0.060

## Accessories

Description	For use with sensor	Reference	Weight
			kg
Teach pushbutton Selection of detection window Length of cable: 152 mm Input: M12 female connector Output: M12 male connector	XX7V1A1●AM12, XX8D1A1●AM12, XXBV1A1●AM12 and XXBD1A1●AM12	<b>XXZPB100</b>	0.035

### Other connection and fixing accessories

See page 48.

# Ultrasonic sensors

XX range, Application

Plastic case, cylindrical type and flat format

Sensors with analogue output signal 0...10 V or 4-20 mA



DF53726

XX9V1A1C2M12



121389

XXZPB100

## Flat format sensors

Sensors	Sensing distance (Sn) (adjustable)	Analogue output (Slope selection using teach button)	Reference	Weight
mm	m			kg
18 x 33 x 65 + Ø 18	0.5	4-20 mA	XX9V1A1C2M12	0.090
		0-10 V	XX9V1A1F1M12	0.060
80 x 80 x 34	1	4-20 mA	XX9D1A1C2M12	0.300
		0-10 V	XX9D1A1F1M12	0.300

## Accessories

### Teach pushbutton

Teach pushbutton	For use with sensors	Reference	Weight kg
Selection of detection window	XX918A●	XXZPB100	0.035
Length of cable: 152 mm	XX9V3A●		
Input: M12 female connector	XX9D1A●		
Output: M12 male connector			

### Other connection and fixing accessories

See page 48.

# Ultrasonic sensors

XX range, General purpose  
Flat format, plastic  
DC supply, solid-state output

Sensor type	XX7F●	XXTF● XXRF●	XX7K●	XXTK● XXRK●	XX7V● XXBV1●	XX8D● XXBD●	XX9V1A1●	XX9D1A1●	
<b>General characteristics</b>									
Conformity to standards	CE, IEC 60947-5-2								
Product certifications	UL, cCSAus	UL	cCSAus	UL	UL, cCSAus (1)	UL, cCSAus (1)	UL, cCSAus		
Nominal sensing distance (Sn)	m	0.1	0.2	0.25	0.6 (XX●K1A3) 1 (XX●K1A4)	0.5	1	0.5	1
Blind zone (in diffuse mode the object is not detected in this zone, in reflex mode the background is not detected in this zone)	mm	0...6.4	–	0...51	–	0 ... 51 (XX7V1●) 0 ... 165 (XXBV1●)	0 ... 100 (XX8D●) 0 ... 315 (XXBD●)	0...51	0...100
Detection window	Fixed				Remotely adjustable or by using teach button				
Detection system	Diffuse	●	–	●	–	●	●	–	–
	Reflex	–	–	–	–	●	●	–	–
	Thru-beam	–	●	–	●	–	–	–	–
Transmission frequency	kHz	500	500	500	200	300	180	300	180
Differential travel	mm	< 0.7	–	< 0.35	–	< 2.5	< 2.5	–	–
Repeat accuracy	mm	± 0.7	± 0.79	± 0.7	± 0.79	± 1.27	± 1.6	1.27	± 1.6
Overall beam angle (see detection lobe)		14°	10°	14°	20°	12°	7°	6°	7°
Minimum size of object to be detected		Cylinder Ø 2.5 mm or flat bar 1 mm wide up to 50 mm	Cylinder Ø 12.2 mm at a distance of 200 mm	Cylinder Ø 1.6 mm up to 76 mm	XX●K1A3: Cylinder Ø 38 mm at a sensing distance of 600 mm XX●K1A4: Cylinder Ø 114 mm at a distance of 1 m	Cylinder Ø 2.5 mm or flat bar 1 mm wide for a sensing distance of 150 mm	Cylinder Ø 50 mm up to 1 m	Cylinder Ø 2.5 mm or flat bar 1 mm wide for a sensing distance of 150 mm	Cylinder Ø 50 mm up to a sensing distance of 1 m
Deviation angle from 90° of the object to be detected		–						± 7°	± 5°
Materials	Case	ULTEM®				Valox®			
	Sensing face (2)	Epoxy		Silicone		Epoxy			
Connection	Connector	M12, 4-pin, on 152 mm flying lead		M12, 4-pin					
<b>Supply characteristics</b>									
Rated supply voltage	V	12...24 V $\overline{\text{=}}$							15...24 V $\overline{\text{=}}$
Voltage limits (including ripple)	V	10...28 V $\overline{\text{=}}$							
Current consumption, no-load	mA	25	50	60	XX●K1A3: 60 XX●K1A4: 100	40	70	40	70

(1) Only XX7V● and XX8D● sensors are cCSAus certified.  
(2) Silicone face for optimum chemical resistance.



# Ultrasonic sensors

XX range, General purpose  
Flat format, plastic  
DC supply, solid-state output

Sensor type		XX7F●	XXTF● XXRF●	XX7K●	XXTK● XXRK●	XX7V● XXBV1●	XX8D● XXBD●	XX9V1A1●	XX9D1A1●	
<b>Output characteristics</b>										
<b>Slope type</b>		Direct or inverse by using teach button, See page 48.								
<b>LED indicators</b>	Output state	Yellow LED								
	Power on	Green LED			–	Green LED				
	Setting-up assistance	–				Multicolour LED		Dual colour LED		
<b>Delays</b>	First-up	ms	–					100	75	
<b>Recovery time</b>		ms	–					150	180	
<b>Resistive load impedance</b>	4-20 mA	Ω	–					10...500	10...350	
	0-10 V	Ω	–					1 k...∞	2 k fixed	
<b>Switching capacity</b>	(PNP and NPN)	mA	< 100, NO or NC function						100	
<b>Voltage drop</b>	(PNP and NPN)	V	< 1	< 1.1	< 1	< 1	< 1	< 1		
<b>Maximum switching frequency</b>		Hz	100	125	80	125	40	72		
<b>Delays</b>	First-up	ms	20	20	350	200	100	75		
	Response	ms	4	4	5	5	10	15		
	Recovery	ms	4	4	5	5	10	75		
<b>Environment characteristics</b>										
<b>Degree of protection</b>	Conforming to IEC 60529 and IEC 60947-5-2	IP 67								
<b>Storage temperature</b>		°C	- 40...+ 80							
<b>Operating temperature</b>		°C	- 20...+ 65	0...+ 50	- 20...+ 65	- 20...+ 65	0...+ 70	- 20...+ 65	0...+ 70	
<b>Vibration resistance</b>	Conforming to IEC 60068-2-6	Amplitude ± 1 mm (f = 10...55 Hz)								
<b>Mechanical shock resistance</b>	Conforming to IEC 60068-2-27	30 gn, duration 11 ms, in all 3 axes								
<b>Resistance to electromagnetic interference</b>		Conforming to IEC 60947-5-2								

#### Dimensions

XX7F1A2●AL01M12  
XXTF1A8●/XXR F1A8●

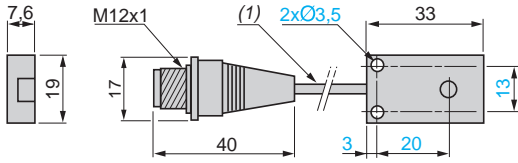

XX7K1A2●AM12  
XXTK1A3●/A4●, XXRK1A3●/A4●

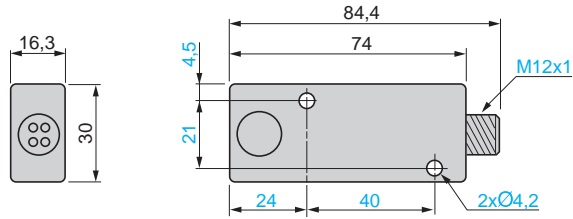

(1) Cable, length: 152 mm.

XX7V1A1●AM12  
XXBV1A1●AM12

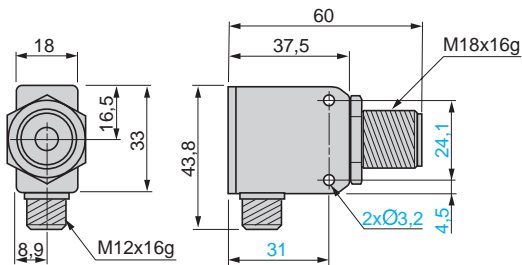

XX9V1A1●M12

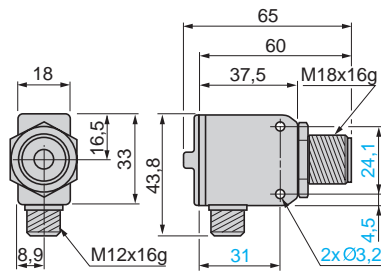

XX8D1A1●AM12  
XXBD1A1●AM12  
XX9D1A1●●AM12

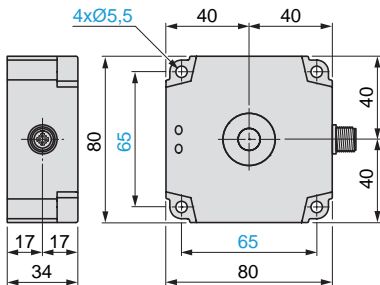

XXZPB100

Teach pushbutton

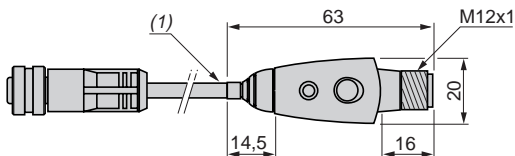

(1) Cable, length: 152 mm.

### Setting-up precautions

#### Minimum mounting distances

##### Diffuse sensors, cylindrical type

###### Side by side

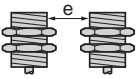

###### Face to face

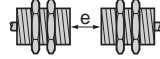

e: respect the distances indicated on the detection curves

$$e \geq 4 \times S_n$$

##### XXV18●

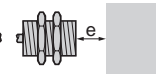
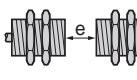
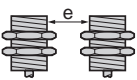

e > 25 mm

e > 700 mm

e > 60 mm

##### Diffuse sensors, flat format

###### Side by side

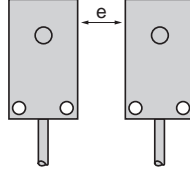

e: respect the distances indicated on the detection curves

##### Thru-beam sensors

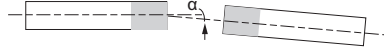

Sensors	$\alpha$
XX●12●●/XX●F1●●	$\pm 5^\circ$
XX●18A3●●/XX●K1A3●●●●	$\pm 8^\circ$
XX●18A4●●/XX●K1A4	$\pm 10^\circ$
XX●18A2●●/XX●K1A2	

### Curves

#### XX7F1A2● A L01M12

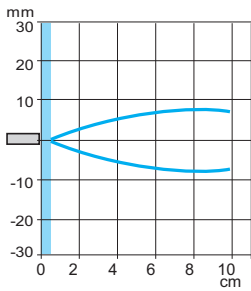

#### XX7K1A2● AM12

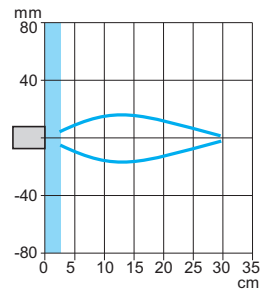

XX218A3●●M12, XX518A3●●L2,  
XXB18A3●AM12, XX518A3●AM12  
XX7V1A1●AM12, XXBV1A1●AM12  
XX918A3●●M12, XX9V1A1●●M12

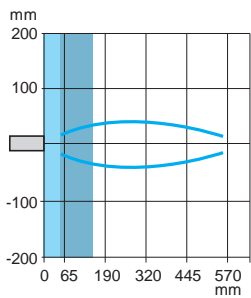

Blind zone for diffuse sensors.

Blind zone for reflex sensors.

### Schemes

#### M12 connector, digital output (XXF●, XXK●)

3-wire type

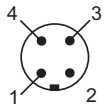

- 1 (+)
- 3 (-)
- 4 NPN or PNP output

**XX7F1A2NAL01M12 (1),  
XX7K1A2NAM12**

NO outputs, NPN

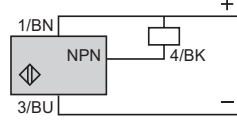

**XX7F1A2PAL01M12 (1), XX7K1A2PAM12,**

NO outputs, PNP

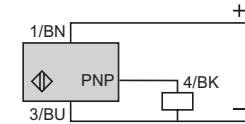

- (-) BU (Blue)
- (+) BN (Brown)
- BK (Black)

(1) Remote connector on flying lead approximately 15 cm long.

#### M12 connector, analogue output

**XX930A●/XX930S●**

**XX918A●/XX9V1A●/XX9V3A●/XX9D1●**

4-wire type

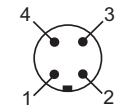

- 1 (+)
- 2 Return signal or teach
- 3 (-)
- 4 Output signal

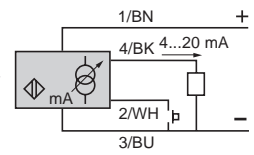
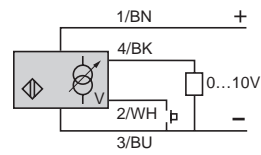
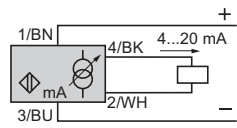
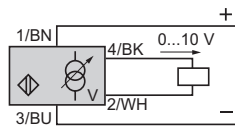

For impedance of resistive load refer to values on page 47.

# Ultrasonic sensors

XX range, General purpose

Cylindrical, plastic or metal, Ø 30 mm

Diffuse system, solid-state digital or analog output

Configurable by software



XXA30P1PM12  
XXS30P1PM12



XXS30B2PM12  
XXA30S2PM12



XXS30S4PM12



XXS30P1AM12

XXS30P2AM12

## Ultrasonic sensors

### Sensors with solid-state digital output, M12 connector

Sensors	Sensing distance (Sn) m	Function/output	Axis	Reference	Weight kg
Ø 30 Plastic	1	NO or NC (1)/PNP	Straight	XXS30P1PM12	0.047
			90° angled	XXA30P1PM12	0.100
	2		Straight	XXS30P2PM12	0.095
			90° angled	XXA30P2PM12	0.100
Ø 30 Nickel-plated brass	1	NO or NC (1)/PNP	Straight	XXS30B1PM12	0.165
			90° angled	XXA30B1PM12	0.175
	2		Straight	XXS30B2PM12	0.165
			90° angled	XXA30B2PM12	0.175
Ø 30 Stainless steel 316L	1	NO or NC (1)/PNP	Straight	XXS30S1PM12	0.160
			90° angled	XXA30S1PM12	0.170
	2		Straight	XXS30S2PM12	0.160
			90° angled	XXA30S2PM12	0.170
4		Straight	XXS30S4PM12	0.190	

### Adjustable sensing distance sensors

Sensors	Sensing distance (Sn) m	Function/output	Connection	Reference	Weight kg
Ø 30 Plastic	1	4-20 mA	Straight	XXS30P1AM12	0.047
			Straight	XXS30P1VM12	0.047
	2	4-20 mA	90° angled	XXA30P1AM12	0.100
			90° angled	XXA30P1VM12	0.100
	4	4-20 mA	Straight	XXS30P2AM12	0.095
			Straight	XXS30P2VM12	0.095
4	4-20 mA	90° angled	XXA30P2AM12	0.100	
		90° angled	XXA30P2VM12	0.100	
4	4-20 mA	Straight	Straight	XXS30P4AM12	0.115
			Straight	XXS30P4VM12	0.115

# Ultrasonic sensors

XX range, General purpose  
 Cylindrical, plastic or metal, Ø 30 mm  
 Diffuse system, solid-state digital or analog output  
 Configurable by software



XXS30B1AM12  
 XXA30B1AM12



XXS30S2AM12  
 XXA30B2AM12



XXS30B4AM12      XXS30S1AM12



XXZPB100

## Ultrasonic sensors (continued)

### Adjustable sensing distance sensors

Sensors	Sensing distance (Sn) m	Function/ output	Connection	Reference	Weight kg
Ø 30 Nickel-plated brass	1	4-20 mA	Straight	XXS30B1AM12	0.165
		0-10 V	Straight	XXS30B1VM12	0.165
		4-20 mA	90° angled	XXA30B1AM12	0.175
		0-10 V	90° angled	XXA30B1VM12	0.175
	2	4-20 mA	Straight	XXS30B2AM12	0.165
		0-10 V	Straight	XXS30B2VM12	0.165
		4-20 mA	90° angled	XXA30B2AM12	0.175
		0-10 V	90° angled	XXA30B2VM12	0.175
4	4-20 mA	Straight	XXS30B4AM12	0.195	
	0-10 V	Straight	XXS30B4VM12	0.195	
	4-20 mA	Straight	XXS30S1AM12	0.160	
	0-10 V	Straight	XXS30S1VM12	0.160	
Ø 30 Stainless steel 316L	1	4-20 mA	Straight	XXS30S1AM12	0.160
		0-10 V	Straight	XXS30S1VM12	0.160
		4-20 mA	90° angled	XXA30S1AM12	0.170
		0-10 V	90° angled	XXA30S1VM12	0.170
	2	4-20 mA	Straight	XXS30S2AM12	0.160
		0-10 V	Straight	XXS30S2VM12	0.160
		4-20 mA	90° angled	XXA30S2AM12	0.170
		0-10 V	90° angled	XXA30S2VM12	0.170
4	4-20 mA	Straight	XXS30S4AM12	0.190	
	0-10 V	Straight	XXS30S4VM12	0.190	

## Accessories

Description	For use with sensor	Reference	Weight kg
Teach pushbutton	XXS30●●	XXZPB100	0.035
Input: M12 female connector Output: M12 male connector	XXA30●●		

## Configuration interface and kit for the synchronization function

See page 57

# Ultrasonic sensors

XX range, General purpose

Cylindrical, plastic or metal, Ø 30 mm

Diffuse system, solid-state digital or analog output

Configurable by software



PF121334

XZCPV11V12L2



PF111910

XZCPV12V12L2

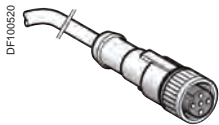

DF100520

XZCP1141L10



PF152522A

XZCC12FDM50B



PF152522A

XXZB130

### Accessories (continued)

Description	Type	Length	Reference	Weight kg
Pre-wired connector 5-pin, 5-wire female M12 connector/bare wires PVC cable	Straight	2	XZCPV11V12L2	0.090
		5	XZCPV11V12L5	0.201
		10	XZCPV11V12L10	0.360
	Elbowed	2	XZCPV12V12L2	0.090
		5	XZCPV12V12L5	0.201
		10	XZCPV12V12L10	0.360

### Connection accessories without synchronization function

Pre-wired connector 5-pin, 5-wire female M12 connector/bare wires PVC cable	Straight	2	XZCP1141L2	0.090
		5	XZCP1141L5	0.190
		10	XZCP1141L10	0.370
	Elbowed	2	XZCP1241L2	0.090
		5	XZCP1241L5	0.201
		10	XZCP1241L10	0.360
Female M12 connector 5-pin, Pg 7 cable gland	Straight	–	XZCC12FDM50B	0.020
			XZCC12FDM50B	0.020

### Mounting accessory

Description	For use with sensor	Reference	Weight kg
Fixing clamp (1)	XXS30●●	XXZB130	0.010
	XXA30●●		

### Configuration interface and kit for the synchronization function

See page 57

(1) Output function (NO or NC) and mode (window, reflex, proximity, pump) are selectable using the **XXZPB100** remote

(2) Selectable using the **XXZPB100** remote teach pushbutton.

## Ultrasonic sensors

XX range, General purpose

Cylindrical, plastic or metal, Ø 30 mm

Diffuse system, solid-state digital or analog output

Configurable by software

Sensor type		XXS30P1PM12	XXS30P1AM12	XXS30P1VM12
<b>General characteristics</b>				
<b>Conformity to standards</b>		EN/IEC 60947-5-2, UL 508, and CSA C22.2 n°14		
<b>Compliance with regulations</b>		CE (based on EMC directive 2014/30/EU), NEC (ANSI/NFPA 70), CEC (CSA C22), UNECE R10		
<b>Product certifications</b>		cULus with class 2 power supply, E2, EAC, RCM, and ECOLAB		
<b>Nominal sensing distance (Sn)</b>		<b>m</b>	1 (adjustable)	
<b>Blind zone</b> (in diffuse mode the object is not detected in this zone)		<b>m</b>	0.105	
<b>Detection window</b>		Remotely adjustable or by using external teachbutton XXZPB100		
<b>Transmission frequency</b> (transmitter resonance)		<b>kHz</b>	200	
<b>Differential travel</b>		<b>mm</b>	< 5	–
<b>Repeat accuracy</b> (repeatability)		0.1 %		
<b>Minimum size of object to be detected</b>		Cylinder Ø 1 mm up to sensing distance of 0.6m		
<b>Tilt angle with 100 x 100 mm target</b>		± 7° at 1 m, ± 10° at 0.9 m ± 35° at 0.5 m		
<b>Materials</b>		XX●30P●: PBT		
Case		Epoxy, resin, and rubber		
Sensing face				
<b>Connection</b>		M12 connector - 5-pin		
<b>Supply characteristics</b>				
<b>Rated supply voltage</b> (Ue) with protection against reverse polarity		<b>V</b>	12...24 V $\overline{\text{---}}$	12...24 V $\overline{\text{---}}$
<b>Voltage limits</b> (including ripple)		<b>V</b>	10...30 V $\overline{\text{---}}$	10...30 V $\overline{\text{---}}$
<b>Current consumption, no-load</b>		<b>mA</b>	< 30	< 30
<b>Output characteristics</b>				
<b>LED indicators</b>				
Output state		Yellow LED	Yellow LED	Yellow LED
Echo state		Green LED	Green LED	Green LED
<b>Switching capacity</b> (with overload and short-circuit protection)		< 100 mA	–	–
<b>Resistive load impedance</b>		<b>Ω</b>	–	12 V $\overline{\text{---}}$ load $\leq$ 250 Ω 24 V $\overline{\text{---}}$ load $\leq$ 850 Ω
<b>Voltage drop</b>		<b>V</b>	< 2	–
<b>Internal temperature compensation</b>			Yes	Yes
<b>Maximum switching frequency</b>		<b>Hz</b>	11	–
<b>Delays</b>				
First-up		<b>ms</b>	120	180
Response		<b>ms</b>	45	–
Recovery		<b>ms</b>	45	100
<b>Environment characteristics</b>				
<b>Degree of protection</b>		Conforming to IEC 60529 and EN/IEC 60947-5-2	IP 65, IP 67	
<b>Storage temperature</b>		<b>°C</b>	- 40...+ 80	
<b>Operating temperature</b>		<b>°C</b>	- 25...+ 70	
<b>Relative humidity</b>		< 95%, without condensation		
<b>Vibration resistance</b>		Conforming to IEC 60068-2-6	Amplitude $\pm$ 1 mm (f = 10...55 Hz)	
<b>Mechanical shock resistance</b>		Conforming to IEC 60068-2-27	30 gn, duration 11 ms, in all 3 axes	
<b>Resistance to electromagnetic interference</b>		Conforming to EN/IEC 60947-5-2 and UNECE R10-05		



## Ultrasonic sensors

XX range, General purpose

Cylindrical, plastic or metal, Ø 30 mm

Diffuse system, solid-state digital or analog output

Configurable by software

Sensor type	XXA30P1PM12 XX●30B1PM12 XX●30S1PM12	XXA30P1AM12 XX●30B1AM12 XX●30S1AM12	XXA30P1VM12 XX●30B1VM12 XX●30S1VM12
<b>General characteristics</b>			
Conformity to standards	EN/IEC 60947-5-2, UL 508, and CSA C22.2 n°14		
Compliance with regulations	CE (based on EMC directive 2014/30/EU), NEC (ANSI/NFPA 70), CEC (CSA C22), UNECE R10		
Product certifications	cULus with class 2 power supply, E2, EAC, RCM, and ECOLAB		
Nominal sensing distance (Sn)	m	1 (adjustable)	
Blind zone (in diffuse mode the object is not detected in this zone)	m	0.155	
Detection window	Remotely adjustable or by using external teachbutton XXZPB100		
Transmission frequency (transmitter resonance)	kHz	120	
Differential travel	mm	< 5	-
Repeat accuracy (repeatability)	0.1 %		
Minimum size of object to be detected	Cylinder Ø 1 mm up to sensing distance of 1m		
Tilt angle with 100 x 100 mm target	± 12° at 1 m, ± 15° at 0.9 m ± 45° at 0.5 m		
Materials	Case	XX●30P●: PBT XX●30B●: Nickel-plated brass XX●30S●: Stainless steel 316L	
	Sensing face	Epoxy, resin, and rubber	
Connection	M12 connector - 5-pin		
<b>Supply characteristics</b>			
Rated supply voltage (Ue) with protection against reverse polarity	V	12...24 V $\overline{\text{---}}$	12...24 V $\overline{\text{---}}$
Voltage limits (including ripple)	V	10...30 V $\overline{\text{---}}$	10...30 V $\overline{\text{---}}$
Current consumption, no-load	mA	< 65	< 65
<b>Output characteristics</b>			
LED indicators	Output state	Yellow LED	Yellow LED
	Echo state	Green LED	Green LED
Switching capacity (with overload and short-circuit protection)	< 100 mA		
Resistive load impedance	Ω	-	12 V $\overline{\text{---}}$ load ≤ 250 Ω 24 V $\overline{\text{---}}$ load ≤ 850 Ω
Voltage drop	V	< 2	-
Internal temperature compensation	Yes		
Maximum switching frequency	Hz	11	
Delays	First-up	ms	120
	Response	ms	45
	Recovery	ms	45
<b>Environment characteristics</b>			
Degree of protection Conforming to IEC 60529 and EN/IEC 60947-5-2	IP 65, IP 67		
Storage temperature	°C	- 40...+ 80	
Operating temperature	°C	- 25...+ 70	
Relative humidity	< 95%, without condensation		
Vibration resistance Conforming to IEC 60068-2-6	Amplitude ± 1 mm (f = 10...55 Hz)		
Mechanical shock resistance Conforming to IEC 60068-2-27	30 gn, duration 11 ms, in all 3 axes		
Resistance to electromagnetic interference	Conforming to EN/IEC 60947-5-2 and UNECE R10-05		

# Ultrasonic sensors

XX range, General purpose

Cylindrical, plastic or metal, Ø 30 mm

Diffuse system, solid-state digital or analog output

Configurable by software

## Operating diagrams for digital output sensors

### Settings with teach procedure

#### Window mode

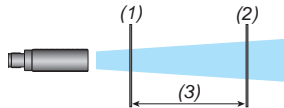

- (1): Near limit
- (2): Far limit
- (3): Sensing window

#### Reflex mode

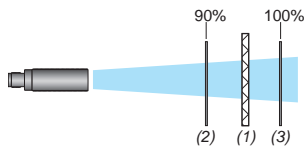

- (1): Reflector
- (2): Near limit
- (3): Far limit

#### Proximity mode

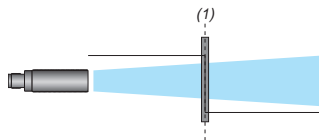

- (1) Switch point

#### Pump/Hysteresis mode

##### Emptying (stored in high threshold memory)

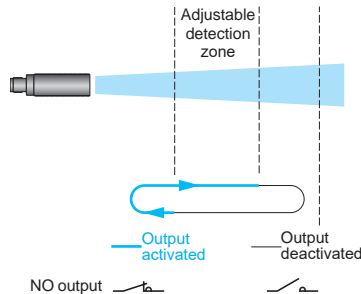

##### Filling (stored in low threshold memory)

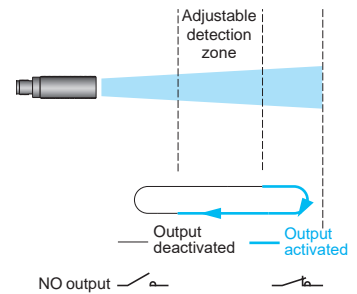

# Ultrasonic sensors

XX range, General purpose

Cylindrical, plastic or metal, Ø 30 mm

Diffuse system, solid-state digital or analog output

Configurable by software

## Operating diagram for analog output sensors

Near and far limits setting with teach procedure

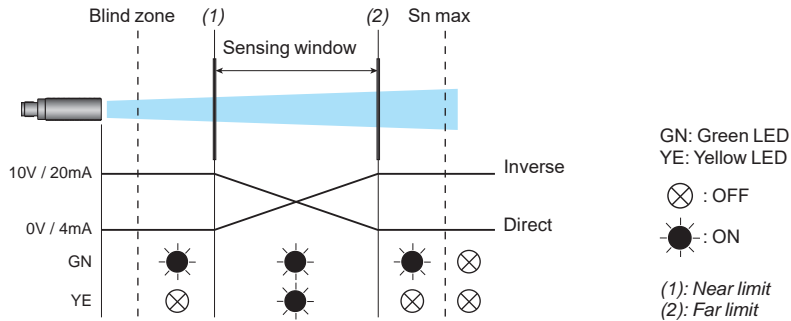

## Diagram for the synchronization function (side by side application)

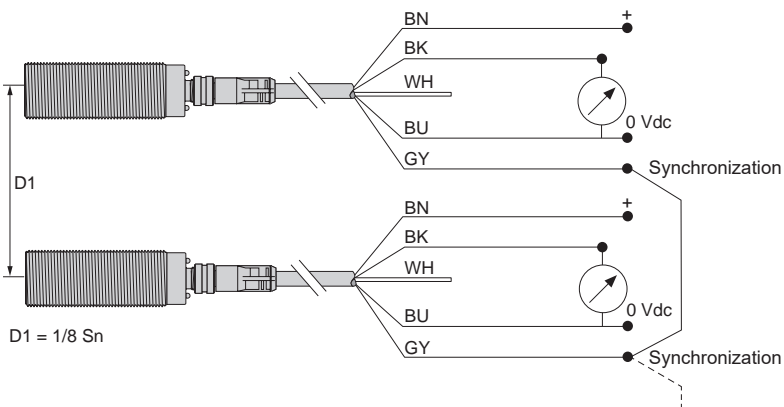

**NB:** To enable synchronization between several sensors, all of the wires of pin no.5 (gray) must be electrically connected together. A maximum of 8 sensors can be synchronized. To enable "Multiplexer" function for the sensors, use the XX Configuration Software. Without synchronization or multiplexing, the sensors must be at least 50 cm away from each other in order to avoid mutual interference.

# Ultrasonic sensors

XX range, General purpose  
Cylindrical, plastic or metal, Ø 30 mm  
Diffuse system, solid-state digital or analog output  
Configurable by software

## Dimensions

XXA30B1●M12  
XXA30S1●M12  
XXA30P1●M12

XXS30B1●M12  
XXS30S1●M12

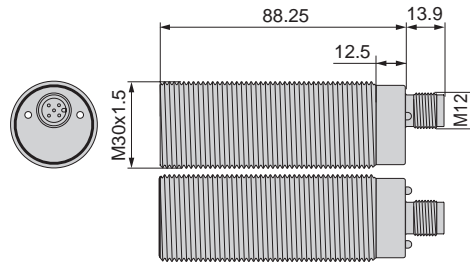
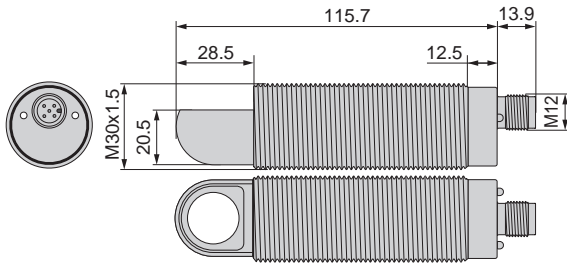

## Connections

### Connector wiring

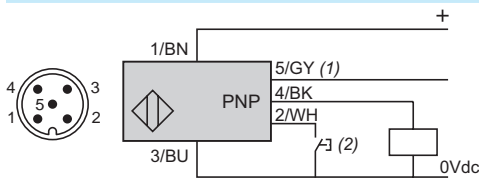

Pin number	Wire color	Digital output description	Analog output description	
			4-20 mA	0-10 V
1	BN: Brown	+12...24 V $\overline{\text{---}}$	+12...24 V $\overline{\text{---}}$	+14...24 V $\overline{\text{---}}$
2	WH: White	Input teach		
3	BU: Blue	0 V $\overline{\text{---}}$		
4	BK: Black	Output		
5	GY: Gray	Synchronization		

(1) Synchronization.

(2) External setting pushbutton or **XXZPB100** remote teach pushbutton (see page 59).

### Wiring scheme (digital output NO or NC)

XXA30●PM12/XXS30●PM12

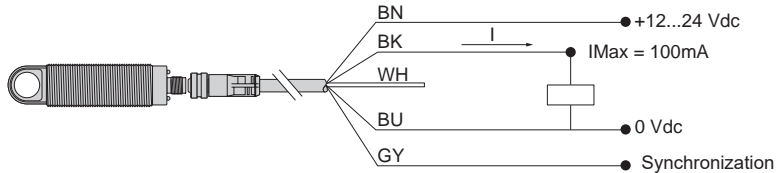

### Wiring scheme (analog output 0-10V)

XX●30●VM12

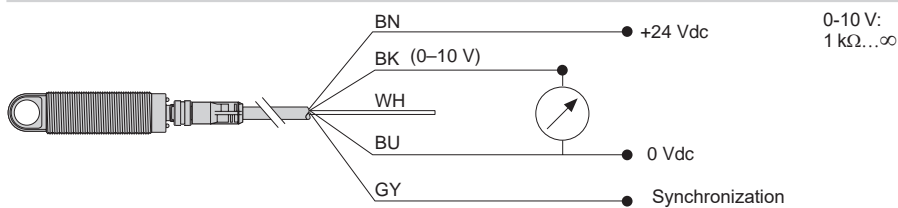

### Wiring scheme (analog output 4-20 mA)

XX●30●AM12

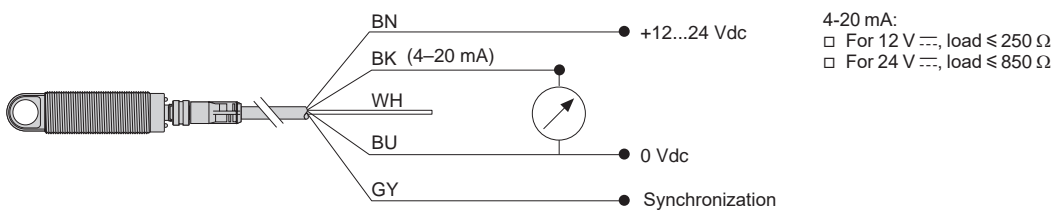

4-20 mA:  
□ For 12 V  $\overline{\text{---}}$ , load  $\leq 250 \Omega$   
□ For 24 V  $\overline{\text{---}}$ , load  $\leq 850 \Omega$

# Ultrasonic sensors

XX range, General purpose

Cylindrical, plastic or metal, Ø 30 mm

Diffuse system, solid-state digital or analog output

Configurable by software

## Dimensions (continued)

### Fixing clamp XXZB130

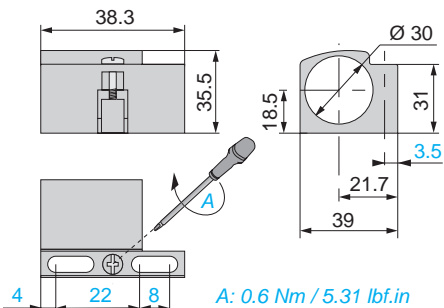

### Teach pushbutton XXZPB100

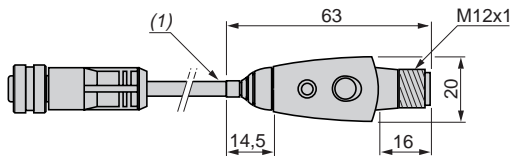

(1) Cable length: 152 mm

## Curves

### Detection curve with 100 x 100 mm square target

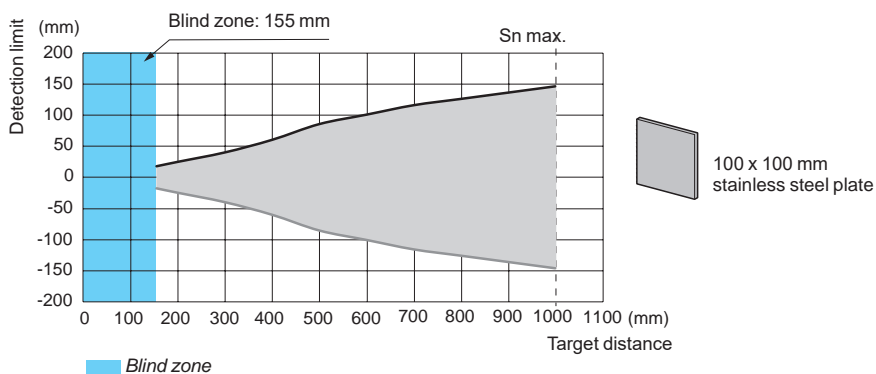

### Detection curve with round bar

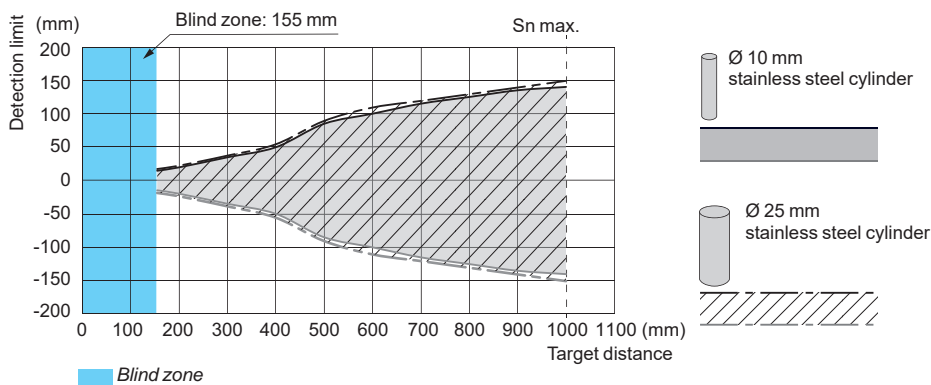

# Ultrasonic sensors

XX range, General purpose  
Cylindrical, plastic or metal, Ø 30 mm  
Diffuse system, solid-state digital or analog output  
Configurable by software

## Dimensions

XXS30P1PM12  
XXS30P1AM12  
XXS30P1VM12

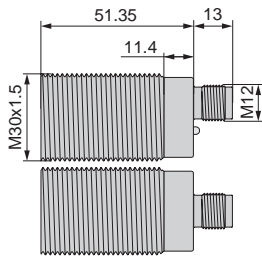

## Connections

### Connector wiring

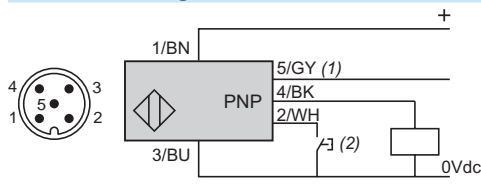

Pin number	Wire color	Digital output description	Analog output description	
			4-20 mA	0-10 V
1	BN: Brown	+12...24 V $\square$	+12...24 V $\square$	+14...24 V $\square$
2	WH: White	Input teach		
3	BU: Blue	0 V $\square$		
4	BK: Black	Output		
5	GY: Gray	Synchronization		

(1) Synchronization.

(2) External setting pushbutton or XXZPB100 remote teach pushbutton (see page 61).

### Wiring scheme (digital output NO or NC)

XXS30●●PM12

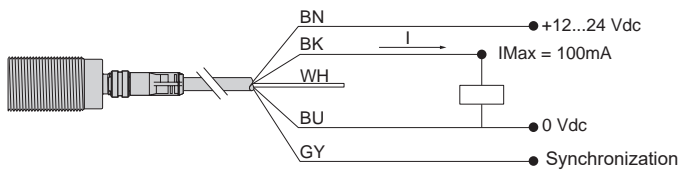

### Wiring scheme (analog output 0-10V)

XX●30●●VM12

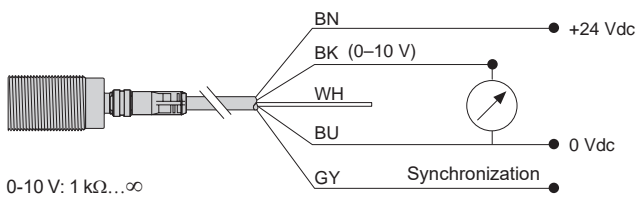

### Wiring scheme (analog output 4-20 mA)

XX●30●●AM12

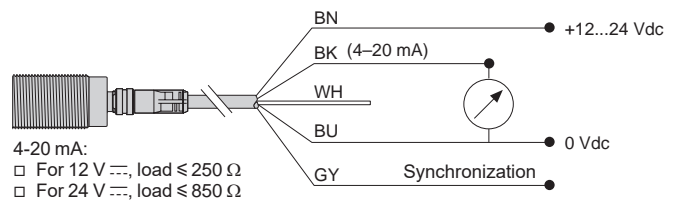

## Diagram for the synchronization function (Side by side application)

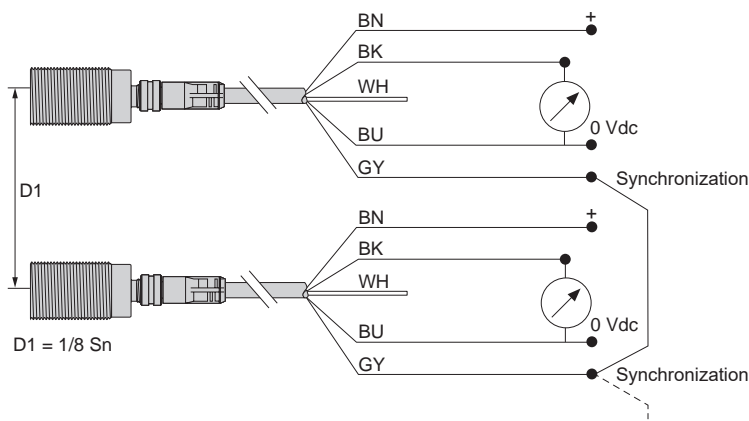

**NB:** To enable synchronization between several sensors, all of the wires of pin no.5 (gray) must be electrically connected together. A maximum of 8 sensors can be synchronized. To enable "Multiplexer" function for the sensors, use the XX Configuration Software. Without synchronization or multiplexing, the sensors must be at least 50 cm away from each other in order to avoid mutual interference.

# Ultrasonic sensors

XX range, General purpose

Cylindrical, plastic or metal, Ø 30 mm

Diffuse system, solid-state digital or analog output

Configurable by software

## Dimensions (continued)

### Fixing clamp XXZB130

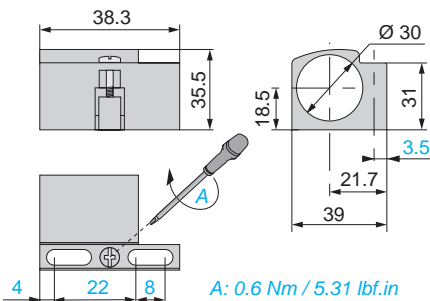

### Teach pushbutton XXZPB100

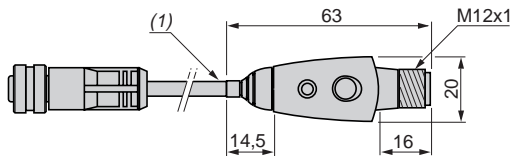

(1) Cable length: 152 mm

## Curves

### Detection curve with 100 x 100 mm square target

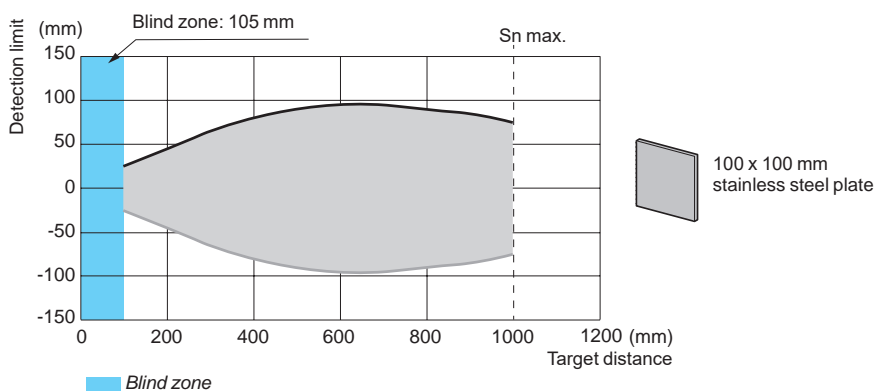

### Detection curve with round bar

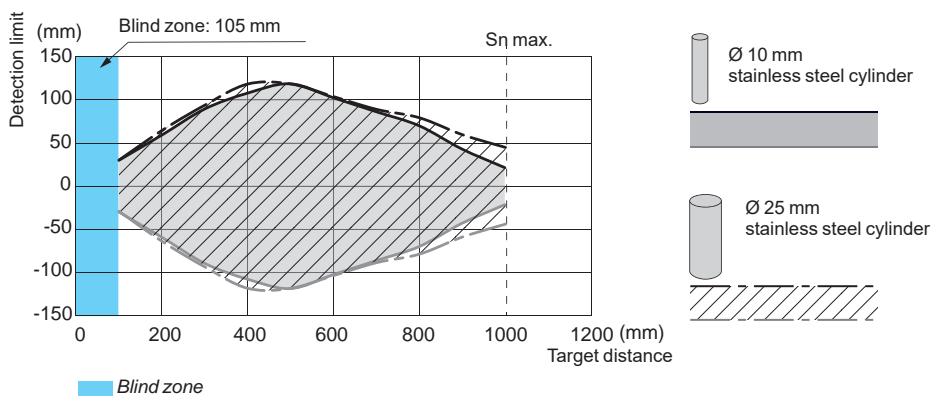

## Ultrasonic sensors

XX range, General purpose

Cylindrical, plastic or metal, Ø 30 mm

Diffuse system, solid-state digital or analog output

Configurable by software

Sensor type		XX●30P2PM12 XX●30B2PM12 XX●30S2PM12	XX●30P2AM12 XX●30B2AM12 XX●30S2AM12	XX●30P2VM12 XX●30B2VM12 XX●30S2VM12
<b>General characteristics</b>				
<b>Conformity to standards</b>		EN/IEC 60947-5-2, UL 508, and CSA C22.2 n°14		
<b>Compliance with regulations</b>		CE (based on EMC directive 2014/30/EU), NEC (ANSI/NFPA 70), CEC (CSA C22), UNECE R10		
<b>Product certifications</b>		cULus with class 2 power supply, E2, EAC, RCM, and ECOLAB		
<b>Nominal sensing distance (Sn)</b>		<b>m</b>	2 (adjustable)	
<b>Blind zone</b> (in diffuse mode the object is not detected in this zone)		<b>m</b>	0.155	
<b>Detection window</b>		Remotely adjustable or by using external teachbutton XXZPB100		
<b>Transmission frequency (transmitter resonance)</b>		<b>kHz</b>	120	
<b>Differential travel</b>		<b>mm</b>	< 10	–
<b>Repeat accuracy (repeatability)</b>		0.1 %		
<b>Minimum size of object to be detected</b>		Cylinder Ø 1 mm up to sensing distance of 1.4m		
<b>Tilt angle with 100 x 100 mm target</b>		± 10° at 2 m, ± 12° at 1.8 m ± 45° at 1m		
<b>Materials</b>	Case	XX●30P●: PBT XX●30B●: Nickel-plated brass XX●30S●: Stainless steel 316L		
	Sensing face	Epoxy, resin, and rubber		
<b>Connection</b>		M12 connector - 5-pin		
<b>Supply characteristics</b>				
<b>Rated supply voltage (Ue)</b> with protection against reverse polarity		<b>V</b>	12...24 V $\overline{\text{DC}}$	12...24 V $\overline{\text{DC}}$
<b>Voltage limits (including ripple)</b>		<b>V</b>	10...30 V $\overline{\text{DC}}$	10...30 V $\overline{\text{DC}}$
<b>Current consumption, no-load</b>		<b>mA</b>	< 65	< 65
<b>Output characteristics</b>				
<b>LED indicators</b>	Output state		Yellow LED	Yellow LED
	Echo state		Green LED	Green LED
<b>Switching capacity (with overload and short-circuit protection)</b>			< 100 mA	–
<b>Resistive load impedance</b>		<b>Ω</b>	–	12 V $\overline{\text{DC}}$ load ≤ 250 Ω 24 V $\overline{\text{DC}}$ load ≤ 850 Ω
<b>Voltage drop</b>		<b>V</b>	< 2	–
<b>Internal temperature compensation</b>			Yes	Yes
<b>Maximum switching frequency</b>		<b>Hz</b>	5.5	
<b>Delays</b>	First-up	<b>ms</b>	150	250
	Response	<b>ms</b>	90	–
	Recovery	<b>ms</b>	90	200
<b>Environment characteristics</b>				
<b>Degree of protection</b>		Conforming to IEC 60529 and EN/IEC 60947-5-2	IP 65, IP 67	
<b>Storage temperature</b>		<b>°C</b>	- 40...+ 80	
<b>Operating temperature</b>		<b>°C</b>	- 25...+ 70 (1)	
<b>Relative humidity</b>		< 95%, without condensation		
<b>Vibration resistance</b>		Conforming to IEC 60068-2-6	Amplitude ± 1 mm (f = 10...55 Hz)	
<b>Mechanical shock resistance</b>		Conforming to IEC 60068-2-27	30 gn, duration 11 ms, in all 3 axes	
<b>Resistance to electromagnetic interference</b>		Conforming to EN/IEC 60947-5-2 and UNECE R10-05		



# Ultrasonic sensors

XX range, General purpose

Cylindrical, plastic or metal, Ø 30 mm

Diffuse system, solid-state digital or analog output

Configurable by software

## Operating diagrams for digital output sensors

### Settings with teach procedure

#### Window mode

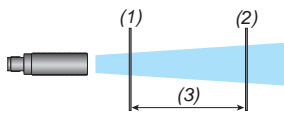

- (1): Near limit
- (2): Far limit
- (3): Sensing window

#### Reflex mode

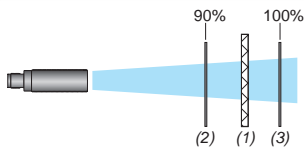

- (1): Reflector
- (2): Near limit
- (3): Far limit

#### Proximity mode

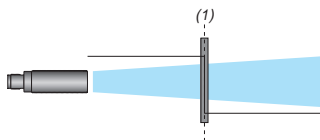

- (1) Switch point

#### Pump/Hysteresis mode

##### Emptying (stored in high threshold memory)

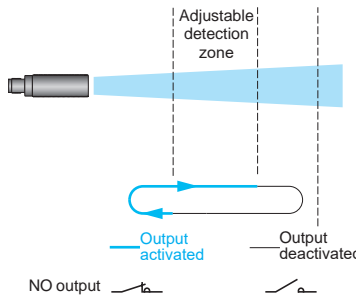

##### Filling (stored in low threshold memory)

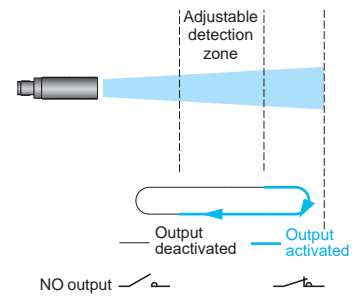

## Operating diagram for analog output sensors

### Near and far limits setting with teach procedure

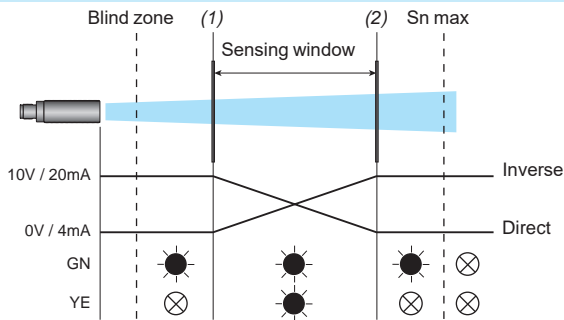

GN: Green LED  
YE: Yellow LED

⊗ : OFF

● : ON

(1): Near limit

(2): Far limit

# Ultrasonic sensors

XX range, General purpose

Cylindrical, plastic or metal, Ø 30 mm

Diffuse system, solid-state digital or analog output

Configurable by software

## Dimensions

XX●30P2PM12  
XX●30B2PM12  
XX●30S2PM12

XX●30P2AM12  
XX●30B2AM12  
XX●30S2AM12

XX●30P2VM12  
XX●30B2VM12  
XX●30S2VM12

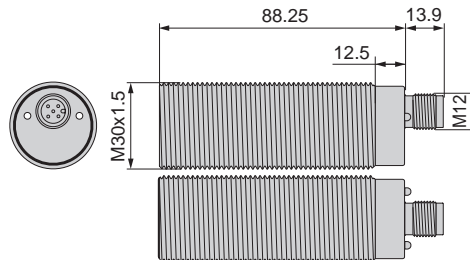
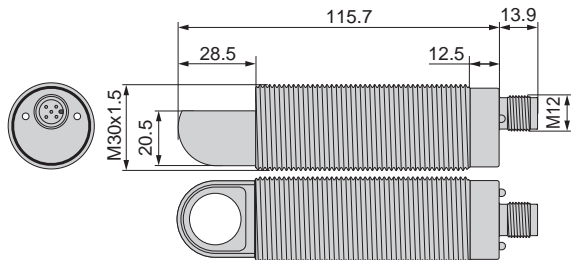

## Connections

### Connector wiring

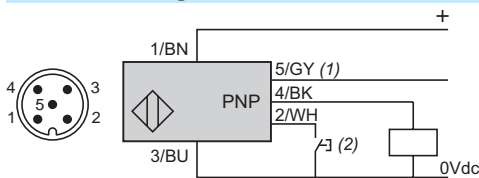

Pin number	Wire color	Digital output description	Analog output description	
			4-20 mA	0-10 V
1	BN: Brown	+12...24 V $\overline{\text{---}}$	+12...24 V $\overline{\text{---}}$	+14...24 V $\overline{\text{---}}$
2	WH: White	Input teach		
3	BU: Blue	0 V $\overline{\text{---}}$		
4	BK: Black	Output		
5	GY: Gray	Synchronization		

(1) Synchronization.

(2) External setting pushbutton or XXZPB100 remote teach pushbutton (see page 65).

### Wiring scheme (digital output NO or NC)

XXS30●●PM12 and XXA30●●PM12

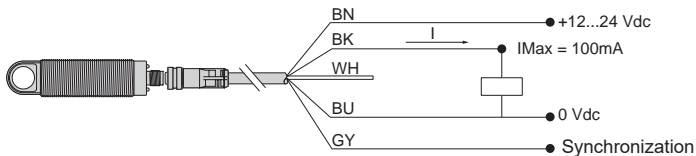

### Wiring scheme (analog output 0-10V)

XX●30●●VM12

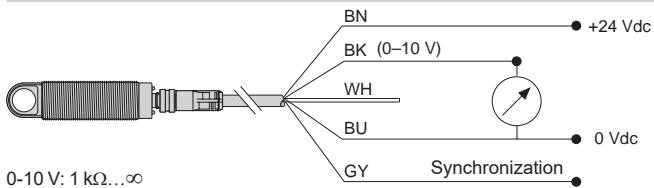

### Wiring scheme (analog output 4-20 mA)

XX●30●●AM12

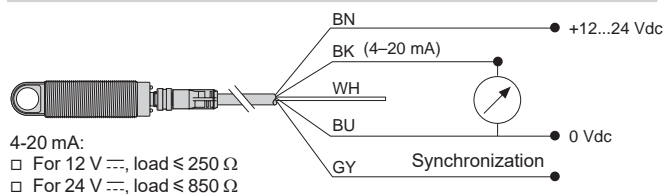

### Diagram for the synchronization function (Side by side application)

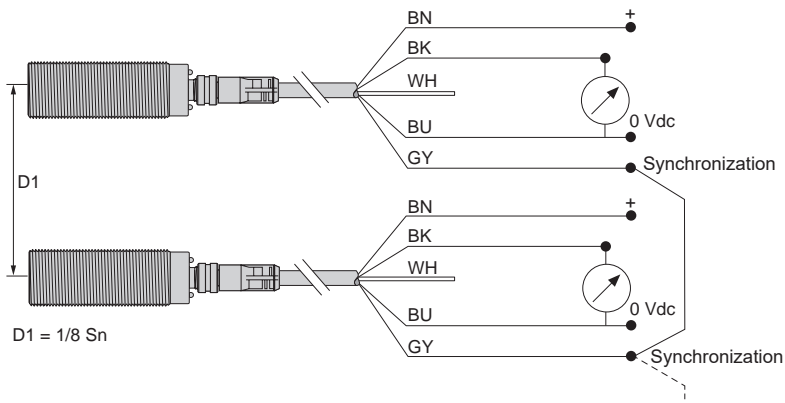

**NB:** To enable synchronization between several sensors, all of the wires of pin no.5 (gray) must be electrically connected together. A maximum of 8 sensors can be synchronized. To enable "Multiplexer" function for the sensors, use the XX Configuration Software. Without synchronization or multiplexing, the sensors must be at least 50 cm away from each other in order to avoid mutual interference.

# Ultrasonic sensors

XX range, General purpose

Cylindrical, plastic or metal, Ø 30 mm

Diffuse system, solid-state digital or analog output

Configurable by software

## Dimensions (continued)

### Fixing clamp XXZB130

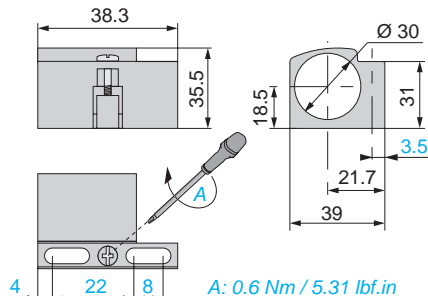

### Teach pushbutton XXZPB100

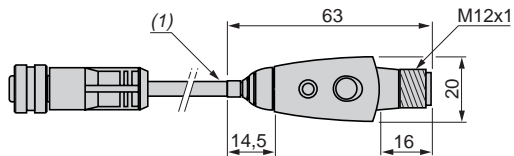

(1) Cable length: 152 mm

## Curves

### Detection curve with 100 x 100 mm square target

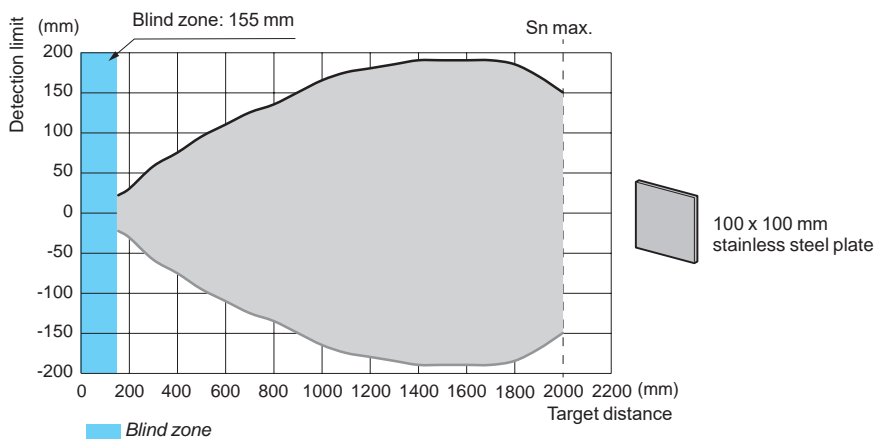

### Detection curve with round bar

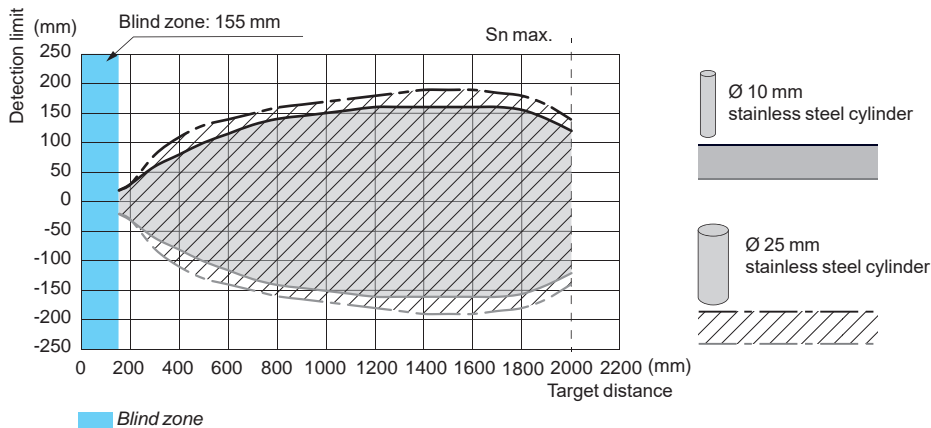

## Ultrasonic sensors

XX range, General purpose

Cylindrical, plastic or metal, Ø 30 mm

Diffuse system, solid-state digital or analog output

Configurable by software

Sensor type		XXS30●4PM12	XXS30●4AM12	XXS30●4VM12	
<b>General characteristics</b>					
Conformity to standards		EN/IEC 60947-5-2, UL 508, and CSA C22.2 n°14			
Compliance with regulations		CE (based on EMC directive 2014/30/EU), NEC (ANSI/NFPA 70), CEC (CSA C22), UNECE R10			
Product certifications		cULus with class 2 power supply, E2, EAC, RCM, and ECOLAB			
Nominal sensing distance (Sn)		m	4 (adjustable)		
Blind zone (in diffuse mode the object is not detected in this zone)		m	0.420		
Detection window		Remotely adjustable or by using external teachbutton XXZPB100			
Transmission frequency (transmitter resonance)		kHz	80		
Differential travel		mm	< 20	–	
Repeat accuracy (repeatability)		0.1 %			
Minimum size of object to be detected		Cylinder Ø 1 mm up to sensing distance of 1.8m			
Tilt angle with 500 x 500 mm target		± 7° at 4 m, ± 10° at 3.6 m ± 40° at 2 m			
Materials		Case	XXS30P●: PBT XXS30B●: Nickel-plated brass XXS30S●: Stainless steel 316L		
		Sensing face	Epoxy, resin, and rubber		
Connection		M12 connector - 5-pin			
<b>Supply characteristics</b>					
Rated supply voltage (Ue) with protection against reverse polarity		V	12...24 V $\overline{\text{---}}$	12...24 V $\overline{\text{---}}$	24 V $\overline{\text{---}}$
Voltage limits (including ripple)		V	10...30 V $\overline{\text{---}}$	10...30 V $\overline{\text{---}}$	14...30 V $\overline{\text{---}}$
Current consumption, no-load		mA	< 65	< 65	< 65
<b>Output characteristics</b>					
LED indicators		Output state	Yellow LED	Yellow LED	Yellow LED
		Echo state	Green LED	Green LED	Green LED
Switching capacity (with overload and short-circuit protection)		< 100 mA			–
Resistive load impedance		Ω	–	12 V $\overline{\text{---}}$ load ≤ 250 Ω 24 V $\overline{\text{---}}$ load ≤ 850 Ω	≥ 1 kΩ
Voltage drop		V	< 2	–	–
Internal temperature compensation		Yes			Yes
Maximum switching frequency		Hz	2.7	–	–
Delays		First-up	ms	250	500
		Response	ms	180	–
		Recovery	ms	180	400
<b>Environment characteristics</b>					
Degree of protection		Conforming to IEC 60529 and EN/IEC 60947-5-2	IP 65, IP 67		
Storage temperature		°C	- 40...+ 80		
Operating temperature		°C	- 25...+ 70 (1)		
Relative humidity		< 95%, without condensation			
Vibration resistance		Conforming to IEC 60068-2-6	Amplitude ± 1 mm (f = 10...55 Hz)		
Mechanical shock resistance		Conforming to IEC 60068-2-27	30 gn, duration 11 ms, in all 3 axes		
Resistance to electromagnetic interference		Conforming to EN/IEC 60947-5-2 and UNECE R10-05			

# Ultrasonic sensors

XX range, General purpose

Cylindrical, plastic or metal, Ø 30 mm

Diffuse system, solid-state digital or analog output

Configurable by software

## Operating diagrams for digital output sensors

### Settings with teach procedure

#### Window mode

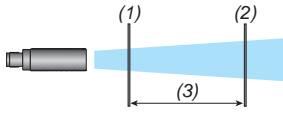

- (1): Near limit
- (2): Far limit
- (3): Sensing window

#### Reflex mode

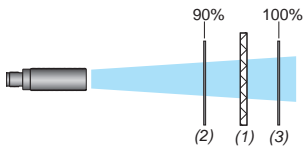

- (1): Reflector
- (2): Near limit
- (3): Far limit

#### Proximity mode

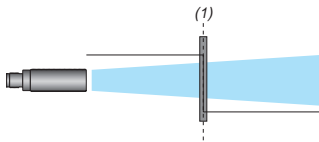

- (1): Switch point

#### Pump/Hysteresis mode

##### Emptying (stored in high threshold memory)

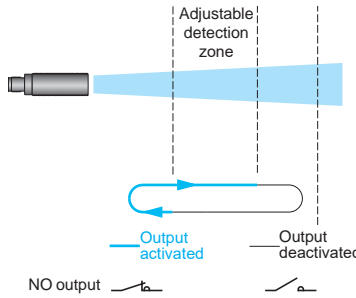

##### Filling (stored in low threshold memory)

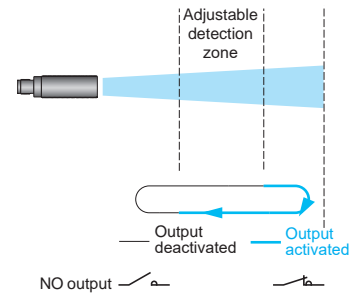

## Operating diagram for analog output sensors

### Near and far limits setting with teach procedure

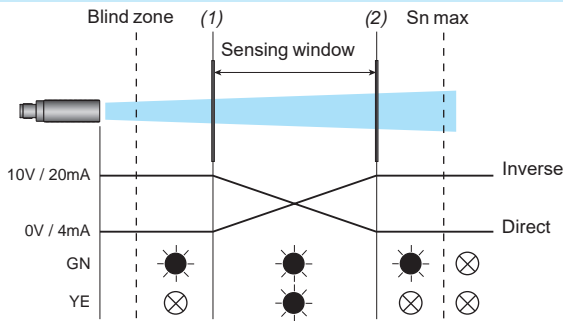

GN: Green LED  
YE: Yellow LED

⊗ : OFF

● : ON

- (1): Near limit
- (2): Far limit

# Ultrasonic sensors

XX range, General purpose  
Cylindrical, plastic or metal, Ø 30 mm  
Diffuse system, solid-state digital or analog output  
Configurable by software

## Dimensions

XXS30P4PM12  
XXS30B4PM12  
XXS30S4PM12

XXS30P4AM12  
XXS30B4AM12  
XXS30S4AM12

XXS30P4VM12  
XXS30B4VM12  
XXS30S4VM12

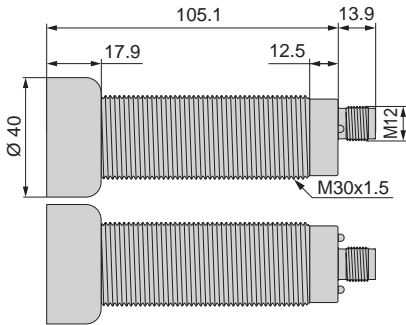

## Connections

### Connector wiring

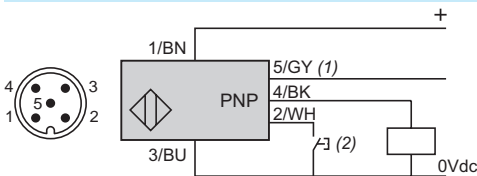

Pin number	Wire color	Digital output description	Analog output description	
			4-20 mA	0-10 V
1	BN: Brown	+12...24 V $\overline{\text{---}}$	+12...24 V $\overline{\text{---}}$	+14...24 V $\overline{\text{---}}$
2	WH: White	Input teach		
3	BU: Blue	0 V $\overline{\text{---}}$		
4	BK: Black	Output		
5	GY: Gray	Synchronization		

(1) Synchronization.

(2) External setting pushbutton or **XXZPB100** remote teach pushbutton (see page 69).

### Wiring scheme (digital output NO or NC)

XXS30●●PM12

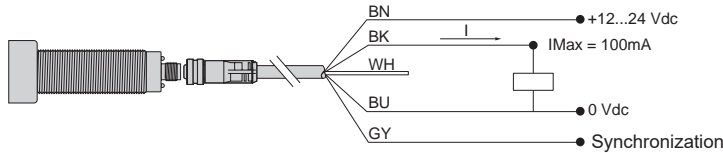

### Wiring scheme (analog output 0-10V)

XX●30●●VM12

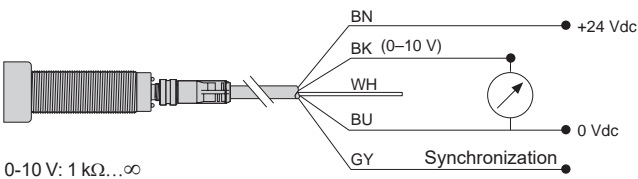

0-10 V: 1 k $\Omega$ ... $\infty$

### Wiring scheme (analog output 4-20 mA)

XX●30●●AM12

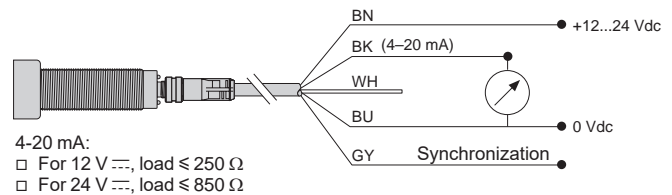

4-20 mA:  
 For 12 V  $\overline{\text{---}}$ , load  $\leq$  250  $\Omega$   
 For 24 V  $\overline{\text{---}}$ , load  $\leq$  850  $\Omega$

### Diagram for the synchronization function (Side by side application)

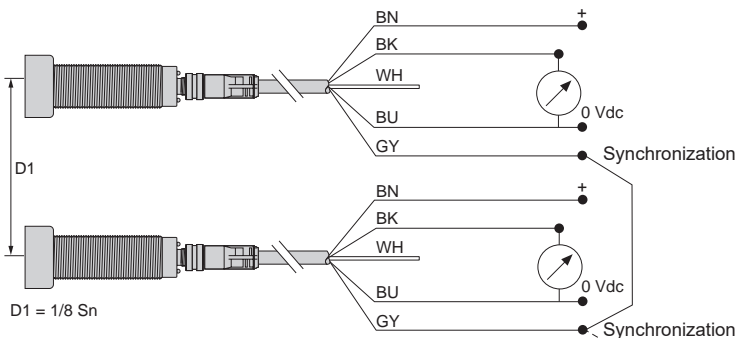

**NB:** To enable synchronization between several sensors, all of the wires of pin no.5 (gray) must be electrically connected together. A maximum of 8 sensors can be synchronized. To enable "Multiplexer" function for the sensors, use the XX Configuration Software. Without synchronization or multiplexing, the sensors must be at least 50 cm away from each other in order to avoid mutual interference.

# Ultrasonic sensors

XX range, General purpose

Cylindrical, plastic or metal, Ø 30 mm

Diffuse system, solid-state digital or analog output

Configurable by software

## Dimensions (continued)

### Fixing clamp XXZB130

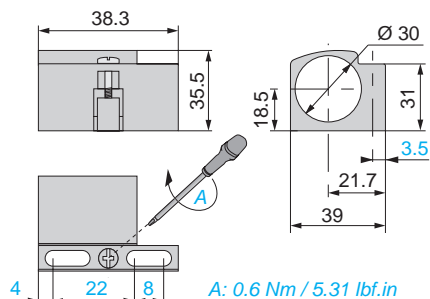

### Teach pushbutton XXZPB100

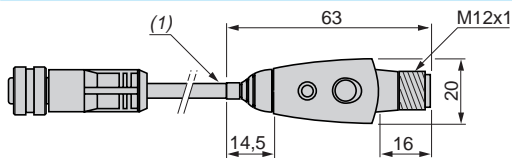

(1) Cable length: 152 mm

## Curves

### Detection curve with 100 x 100 mm square target

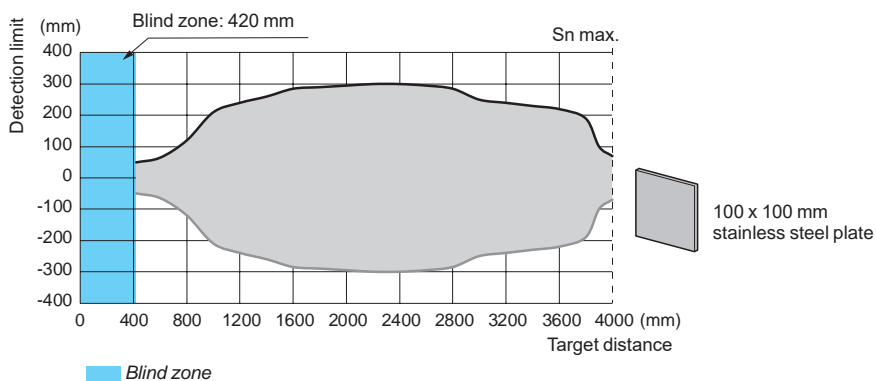

### Detection curve with round bar

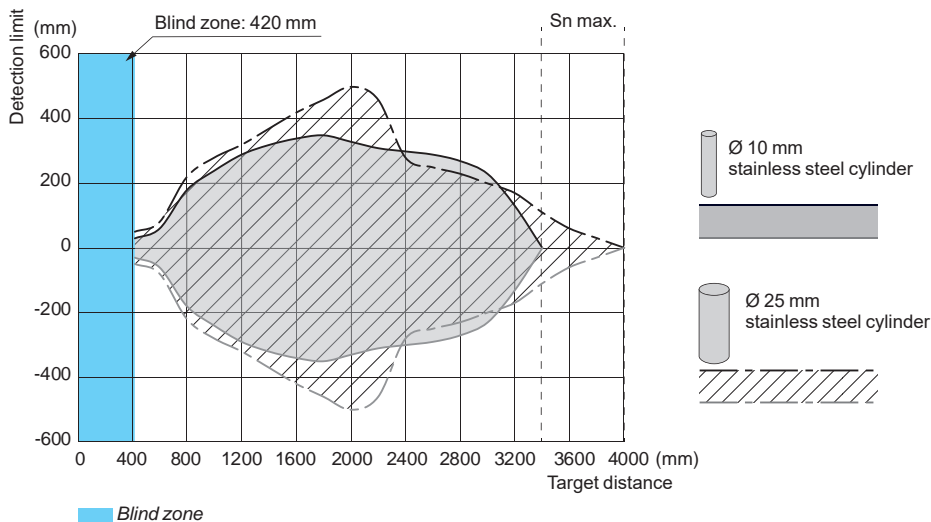

## XX Configuration Software

Telemecanique Sensors is now offering a new solution for configuring ultrasonic XX range sensors. This software enables users to quickly find the optimal sensing solution for their applications. An interface unit connects the sensor to the PC via a USB connection.

### > Easy configuration to unique applications

The configuration software has more than 20 parameters that can be modified to suit the machine application. The parameters can be saved in PDF format for quick, easy reference.

### > Real-time sensor performance display

One of the best functions of the new software is the ability to troubleshoot and visualize the effects of the parameters on the configured sensor. The "echo display" function shows the exact position of any false echoes. The recording function can record the values of the echoes in an .xlsx or .xml file for extended periods of time.

### > Quick duplication of programmed settings

Optimal parameters set on one sensor can be saved and loaded on other units of the same reference. This function reduces time and effort.

### > The interface can be used to configure specific configurable models of XX ultrasonic sensors models (XXS●● & XXA●●).

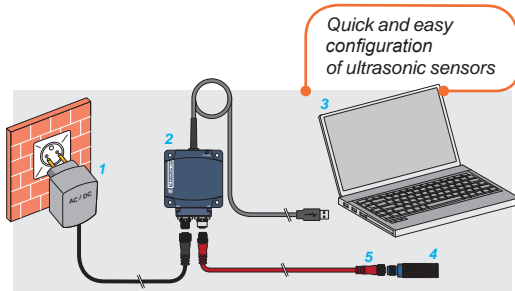

- 1: Power supply, provided with 4 adapters
- 2: Configuration interface **XXZBOX01**
- 3: XX Configuration Software, installed on a PC
- 4: Ultrasonic sensor **XXS●●** or **XXA●●**
- 5: M12-M12 cable

## XX Configuration Software for ultrasonic sensors

> XX Configuration Software is available in English, French, German, Spanish, Italian, and Chinese. It can be installed using the setup file in the USB key provided with the configuration kit or downloaded directly from the website [www.tesensors.com](http://www.tesensors.com).

### > Recommended PC performance:

- > Windows OS: 7 SP1 embedded standard(x86 & x64), 8.1 (x86 & x64), or 10 (x86 & x64)
- > Internet Explorer: 9.0 or higher
- > Disk space: 1 GB or higher
- > RAM memory: 2 GB or higher
- > Processor speed: 1 GHz or higher
- > Display resolution: 1360 x 768 or higher



Ultrasonic sensors configuration interface  
XXZBOX01



Ultrasonic sensors configuration kit  
XXZKIT01

## Part number

Description	Reference	Weight kg
<b>Ultrasonic sensors configuration interface</b>		
<b>Configuration interface</b>	<b>XXZBOX01</b>	0.400
<b>provided with:</b>		
1 power supply (1)		
1 UK adapter		
1 SAA adapter		
1 US adapter		
1 EU adapter		
<b>Ultrasonic sensors configuration kit</b>		
<b>Plastic case including:</b>	<b>XXZKIT01</b>	1.200
1 configuration interface XXZBOX01		
1 power supply (1)		
1 UK adapter		
1 SAA adapter		
1 US adapter		
1 EU adapter		
1 cable of 1 m, with M12 connectors (5-pin male/female)		
1 USB Flash Drive/USB key, including: the setup file for XX Configuration Software, ReadMe file, instruction sheet, tutorial, and the XX range catalog.		

(1) Power supply: 24 V $\overline{-}$ , 0.5A min., with M12 connector.



## Configuration software presentation

### Principle



- 1: Power supply, provided with 4 adapters
- 2: Configuration interface **XXZBOX01**
- 3: XX Configuration Software, installed on a PC
- 4: Ultrasonic sensor **XXS●●** or **XXA●●**

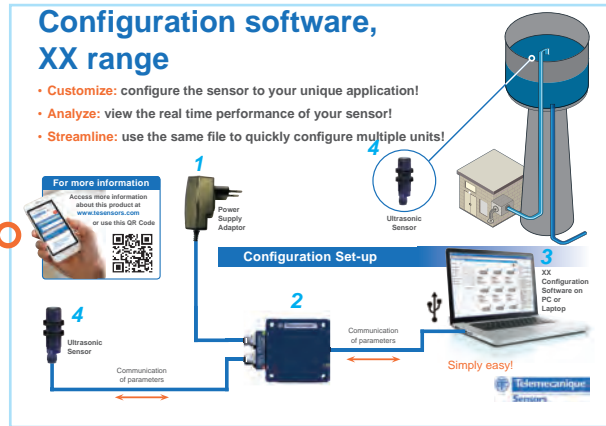

### Setting examples

#### Sensor selection

- > This page is used to manually select or auto-download the XX reference sensor to be configured. Once a reference has been selected, the user can start the configuration process.
- > There are 4 methods of selection. The **Reset search** button can reinitialize the search, regardless of the method used.
  - 1: Direct selection from the full reference list
  - 2: Selection through reference
  - 3: Manual search using criteria
  - 4: Automatic sensor detection

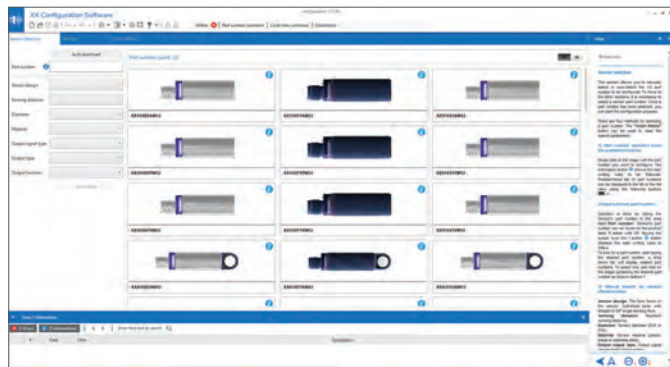

#### Detection settings

- > This tab is used to configure the sensor detection settings.

Hysteresis			Unexpected echoes		
Limit	Value	Unit	Limit	Value	Unit
Near	- 4 +	mm	Foreground	- 100 +	mm
Far	- 4 +	mm	Background	- 1020 +	mm

Change ON / OFF			Multiplexer	
Change	Value	Unit	Number of sensors	Address
ON	- 3 +	cycles	- 1 +	- 1 +
OFF	- 3 +	cycles		

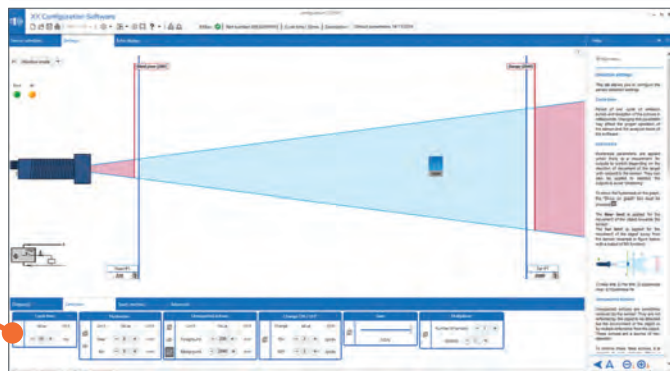

#### Output settings

- > This page enables the configuration of sensor outputs. If the sensor has several outputs, they may be configured separately, unless specified otherwise.

Output			Pulse length	
#	Type	Function	Value	Unit
1	PNP	NO	- 0 +	ms

Loss of echo		Delays		
Number of cycles	Output #1 state	Delay	Value	Unit
- 3 +	Non-detection	ON	- 0 +	ms
		OFF	- 0 +	ms

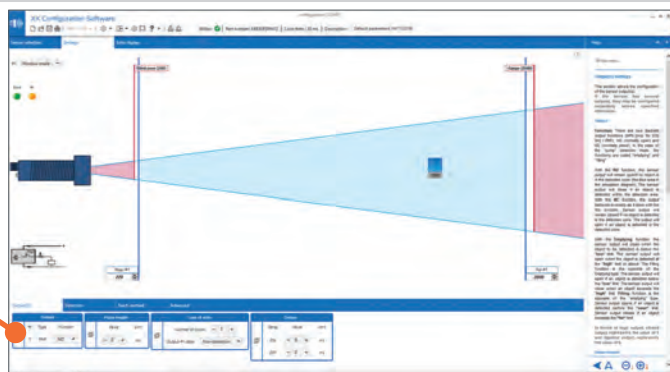

## Configuration software presentation (continued)

### Setting examples (continued)

#### Teach method settings

- > This tab allows the configuration of the pushbutton for manual teaching. Depending on the sensor reference, the teach button is either integrated in the sensor or available through the teach pushbutton **XXZPB100** (see page 69).

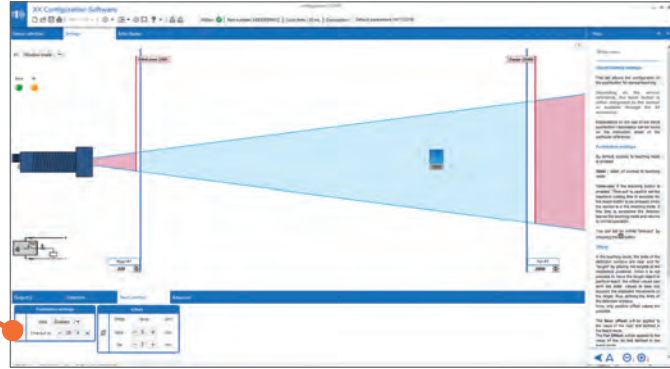

#### Echo display mode

- > With the “echo display” mode, the user can visualize several echoes received by the sensor in the same cycle.
- > The first valid echo is shown in blue and the others in gray. The blue echo is what the sensor considers as the detected object.
- > It is also possible to record the data over extended periods of time using the “record” function.

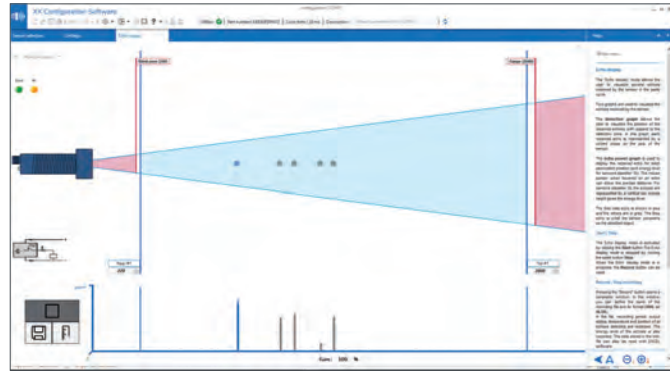

#### Measure mode

- > The “measure” button opens a pop-up window giving a real-time numerical display of the position of the object in mm or inches.

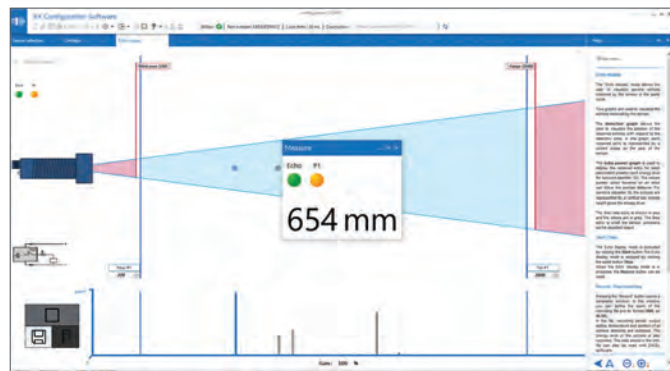

## Characteristics

### Supply characteristics

Rated supply voltage (Ue) with protection against reverse polarity	V	24 V $\overline{\text{---}}$
Voltage limits	V	14...30 V $\overline{\text{---}}$ (ripple: 10% max)
Consumption	W	4 (consumption excluding sensor)

### LED indicators

LED indicators	Power supply	Green LED
	PC communication	Orange LED
	Error	Red LED

### Communication

Data communication baud rate	bps	19,200
------------------------------	-----	--------

### Connection

Maximum cabling distance between sensor and interface	m	3
Electrical connection to sensor		M12 female connector
Connection to PC or laptop		0.5 m USB cable , A type connector

### Environment characteristics

Compliance to regulations		CE
Degree of protection	Conforming to IEC 60529	IP 40
Storage temperature	°C	-20...+45
Operating temperature	°C	0...+45
Relative humidity		< 95%, without condensation

## Dimensions

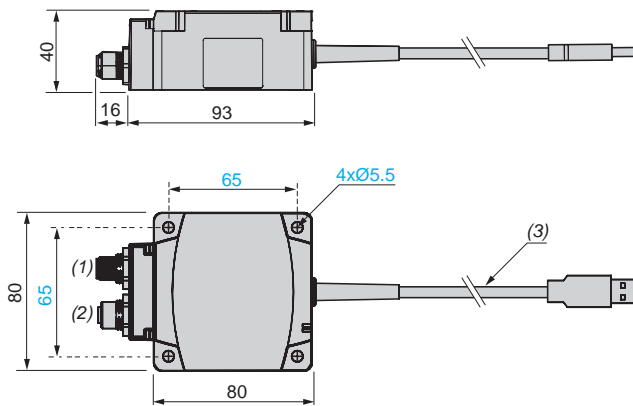

- (1) Male M12 connector, 5-pin: power supply  
 (2) Female M12 connector, 5-pin: sensor  
 (3) Cable length: 0.5 m (USB cable A type connector): PC

## Connections

### Interface connector for power supply adapter (M12 male)



Pin number	Wire color	Description
1	BN: Brown	+14...30 V $\overline{\text{---}}$
2	WH: White	Output 2 (4) (5)
3	BU: Blue	0 V $\overline{\text{---}}$
4	BK: Black	Output 1 (4)
5	–	Not used (6)

### Interface connector for sensor (M12 female)

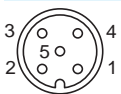

Pin number	Description
1	Power out to sensor
2	Software communication
3	0 V $\overline{\text{---}}$
4	Software communication
5	Not used (6)

(4) Output is only active during the “echo display” mode and “measure” mode.

(5) Output 2 is not available on all sensors.

(6) The 5<sup>th</sup> pins of the M12 male and M12 female connectors are electrically connected to one another.

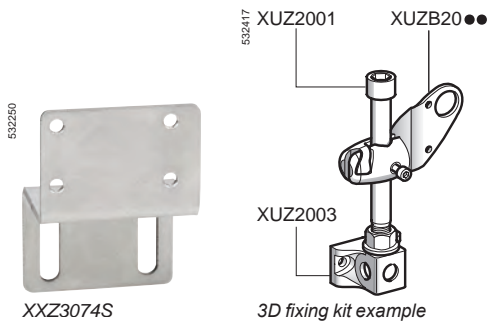
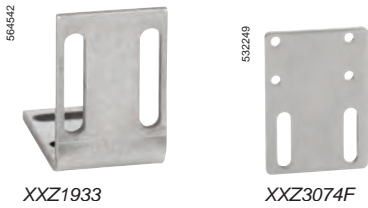

### References of accessories

#### Cabling accessories

Connectors	For use with sensor	Type of connection		Reference	Weight kg
M8 3-pin	Ø 12	IDC (Insulation Displacement Connector)	Straight	<b>XZCC8FDM30V</b>	0.010
	XX512A2		Elbowed	<b>XZCC8FCM30V</b>	0.010
M8 4-pin	XX512A1		Straight	<b>XZCC8FDM40V</b>	0.010
	XX12A8		Elbowed	<b>XZCC8FCM40V</b>	0.010
M12	Ø 18, Ø 30	Screw terminals, metal clamping ring	Straight	<b>XZCC12FDM40B</b>	0.020
			Elbowed	<b>XZCC12FCM40B</b>	0.020
		Screw terminals, plastic clamping ring	Straight	<b>XZCC12FDP40B</b>	0.020
			Elbowed	<b>XZCC12FCP40B</b>	0.020

Pre-wired connectors	For use with sensor	Type	Cable length m	Reference	Weight kg
M8 3-pin	Ø 12 XX512A2	Straight	2	<b>XZCP0166L2 (1)</b>	0.080
		Elbowed	2	<b>XZCP0266L2 (1)</b>	0.080
M12	Ø 18, Ø 30	Straight	2	<b>XZCP1141L2 (1)</b>	0.090
		Elbowed	2	<b>XZCP1241L2 (1)</b>	0.090

#### Fixing accessories

Description	For use with sensor	Reference	Weight kg	
Fixing clamps	Ø 12	<b>XSZB112</b>	0.006	
	Ø 18	<b>XSZB118</b>	0.010	
	Ø 30	<b>XSZB130</b>	0.020	
Fixing clamps (mounting on 35 mm rail)	XXD	<b>XSZBD10</b>	0.065	
90° fixing bracket	Ø 12	<b>XXZ12</b>	0.025	
	Ø 18	<b>XUZA118</b>	0.038	
	Ø 30	<b>XXZ30</b>	0.115	
	XX7F	<b>XXZ1933</b>	0.025	
Flat mounting plate	XX7K	<b>XXZ3074F</b>	0.025	
Cranked mounting plate	XX7K	<b>XXZ3074S</b>	0.075	
3D fixing kit (2)	M12 rod	Ø 12, Ø 18 and Ø 30	<b>XUZ2001</b>	0.050
	Support for M12 rod	Ø 12, Ø 18 and Ø 30	<b>XUZ2003</b>	0.160
	Ball-joint mounted fixing bracket	Ø 12	<b>XUZB2012</b>	0.175
		Ø 18	<b>XUZB2003</b>	0.175
	Ø 30	<b>XUZB2030</b>	0.160	

(1) For a 5 m long cable replace L2 by L5, for a 10 m long cable replace L2 by L10.

(2) To obtain a 3D fixing kit, order:

rod support **XUZ2003**, M12 rod **XUZ2001** and ball-joint mounted fixing bracket **XUZB20**.

### Dimensions

#### Fixing accessories

##### XUZA118

90° fixing bracket (Ø 18)

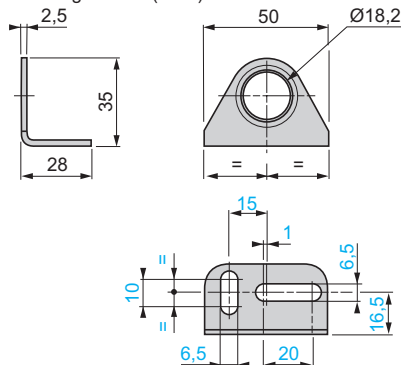

##### XXZ12, XXZ30

90° fixing bracket (Ø 12 and Ø 30)

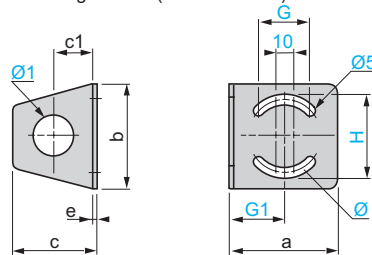

XXZ	a	b	c	c1	e	H	G	G1	Ø	Ø1
12	35	40	33	18	2	31	18	18	25	13
30	67	65	52	25	3	51	35	33	50	31

#### Dimensions (continued)

##### Fixing accessories (continued)

###### XSZB112, XSZB118

Fixing clamps (Ø 12, Ø 18 and Ø 30)

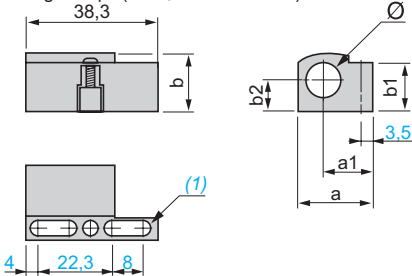

XSZ	a	a1	b	b1	b2	Ø
B112	21.9	14.5	16	15.5	8.5	12
B118	26	15.7	22.3	20.1	11.5	18
B130	39	21.7	35.5	31	18.5	30

(1) 2 elongated holes Ø 4 x 8.

###### XXZ3074F

Flat mounting plate (XX•K•)

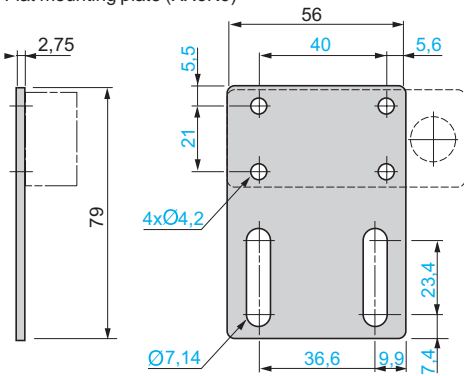

###### XXZ1933

90° fixing bracket (XX•F•)

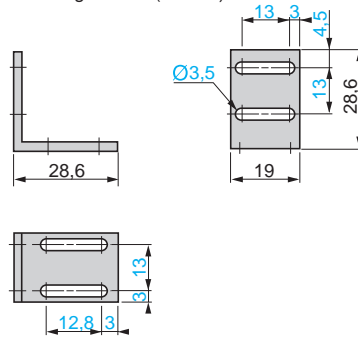

###### XXZ3074S

Cranked mounting plate (XX•K•)

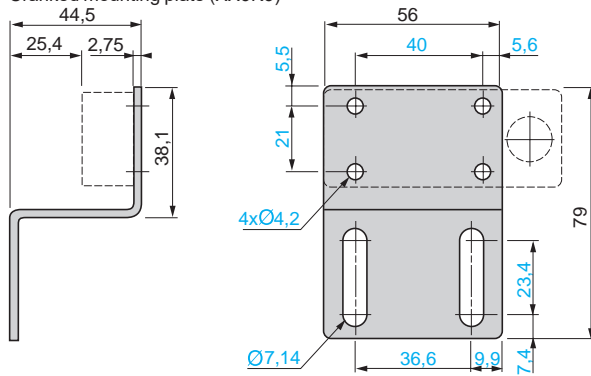

###### XUZ2001

M12 rod

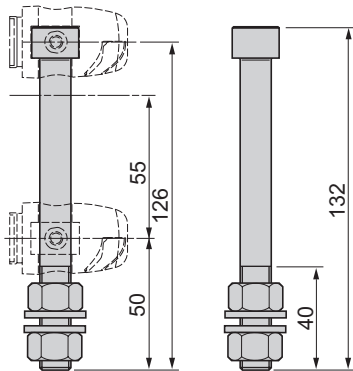

###### XUZ2003

Support for M12 rod

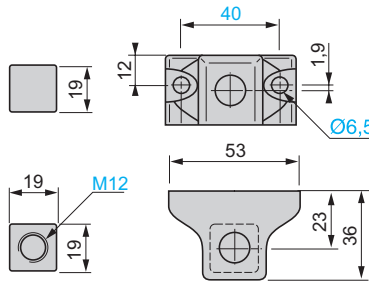

###### XSZBD10

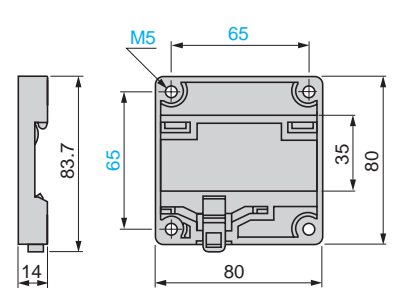

###### XUZB2012

Ball-joint mounted fixing bracket (Ø 12)

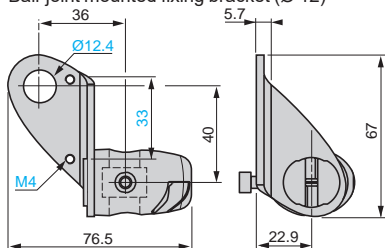

###### XUZB2003

Ball-joint mounted fixing bracket (Ø 18)

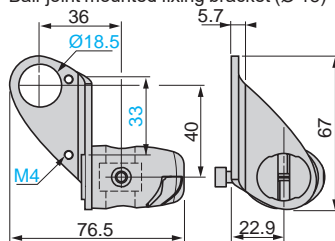

###### XUZB2030

Ball-joint mounted fixing bracket (Ø 30)

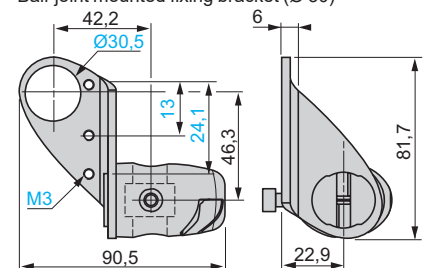

X	
XSZB112	74
XSZB118	74
XSZB130	74
XSZBD10	74
XUZ2001	74
XUZ2003	74
XUZA118	74
XUZB2003	74
XUZB2012	74
XUZB2030	74
XX218A3NFM12	41
XX218A3NHM12	41
XX218A3PFM12	41
XX218A3PHM12	41
XX230A10PA00M12	41
XX230A11PA00M12	41
XX230A12NA00M12	41
XX230A12PA00M12	41
XX230A20PA00M12	41
XX230A21PA00M12	41
XX230A22NA00M12	41
XX230A22PA00M12	41
XX512A1KAM8	22
XX512A2NAM8	22
XX512A2PAM8	22
XX518A1KAM12	22
XX518A3NAL2	27
XX518A3NAM12	27
XX518A3PAL2	27
XX518A3PAM12	27
XX630A1KAM12	37
XX630A1NCM12	37
XX630A1PCM12	37
XX630A2NCM12	37
XX630A2PCM12	37
XX630A3NCM12	37
XX630A3PCM12	37
XX630S1NCM12	37
XX630S1PCM12	37
XX6V3A1NAM12	37
XX6V3A1PAM12	37
XX7F1A2NAL01M12	22 44
XX7F1A2PAL01M12	22 44
XX7K1A2NAM12	22 44
XX7K1A2PAM12	22 44
XX7V1A1NAM12	27 44
XX7V1A1PAM12	27 44
XX8D1A1NAM12	27 44
XX8D1A1PAM12	27 44
XX918A3C2M12	27
XX918A3F1M12	27
XX930A1A1230M12	37
XX930A1A1M12	37
XX930A1A2230M12	37
XX930A1A2M12	37
XX930A2A1230M12	37
XX930A2A1M12	37
XX930A2A2230M12	37
XX930A2A2M12	37
XX930A2A2230M12	37
XX930A2A2M12	37
XX930A2A1M12	37
XXS18S1AM12	31
XXS18S1PM12	31
XXS18S1VM12	31
XXS30B1AM12	52
XXS30B1PM12	51
XXS30B1VM12	52
XXS30B2AM12	52
XXS30B2PM12	51
XXS30B2VM12	52
XXS30B4AM12	52
XXS30B4PM12	51
XXS30B4VM12	52
XXS30P1AM12	51
XXS30P1PM12	51
XXS30P1VM12	51
XXS30P2AM12	51
XXS30P2PM12	51
XXS30P2VM12	51
XXS30P4AM12	51
XXS30P4PM12	51
XXS30P4VM12	51
XXS30S1AM12	52
XXS30S1PM12	51
XXS30S1VM12	52
XXS30S2AM12	52
XXS30S2PM12	51
XXS30S2VM12	52
XXS30S4AM12	52
XXS30S4PM12	51
XXS30S4VM12	52
XXT12A8M8	22
XXT18A3M12	27
XXT18A4M12	27
XXTF1A8M12L	44
XXTK1A3M12	27 44
XXTK1A4M12	27 44
XXV18B1NAL10	22
XXV18B1NAL2	22
XXV18B1NAL5	22
XXV18B1NAM12	22
XXV18B1NBL10	22
XXV18B1NBL2	22
XXV18B1NBL5	22
XXV18B1NBM12	22
XXV18B1PAL10	22
XXV18B1PAL2	22
XXV18B1PAL5	22
XXV18B1PAM12	22
XXV18B1PBL10	22
XXV18B1PBL2	22
XXV18B1PBL5	22
XXV18B1PBM12	22
XXZ12	74
XXZ1933	74
XXZ30	74
XXZ3074F	74
XXZ3074S	74
XXZB118	32
XXZB130	53
XXZBOX01	56
XXZKIT01	56
XXZPB100	27 31 41 44 45 52
XZCC12FCM40B	74
XZCC12FCM50B	32
XZCC12FCP40B	74
XZCC12FDM40B	74
XZCC12FDM50B	32 53
XZCC12FDP40B	74
XZCC8FCM30V	74
XZCC8FCM40V	74
XZCC8FDM30V	74
XZCC8FDM40V	74
XZCP0166L2	74
XZCP0266L2	74
XZCP1141L10	32 53
XZCP1141L2	32 53 74
XZCP1141L5	32 53
XZCP1241L10	32 53
XZCP1241L2	32 53 74
XZCP1241L5	32 53
XZCPV11V12L10	32 53
XZCPV11V12L2	32 53
XZCPV11V12L5	32 53
XZCPV12V12L10	32
XZCPV12V12L2	32 53
XZCPV12V12L5	32



**Schneider Electric Industries SAS**

Head Office  
35, rue Joseph Monier  
F-92500 Rueil-Malmaison  
France

[www.tesensors.com](http://www.tesensors.com)

The information provided in this documentation contains general descriptions and/or technical characteristics of the performance of the products contained herein. This documentation is not intended as a substitute for and is not to be used for determining suitability or reliability of these products for specific user applications. It is the duty of any such user or integrator to perform the appropriate and complete risk analysis, evaluation and testing of the products with respect to the relevant specific application or use thereof. Neither Schneider Electric nor any of its affiliates or subsidiaries shall be responsible or liable for misuse of the information contained herein.

Design: Schneider Electric  
Photos: Schneider Electric

October 2019 - V1.0

DIA4ED2191101EN



## X-ON Electronics

Largest Supplier of Electrical and Electronic Components

*Click to view similar products for [Proximity Sensors](#) category:*

*Click to view products by [Schneider](#) manufacturer:*

Other Similar products are found below :

[01.001.5653.1](#) [70.340.1028.0](#) [70.360.2428.0](#) [70.364.4828.0](#) [70.810.1053.0](#) [72.360.1628.0](#) [73.363.6428.0](#) [8027AL20NL2CPXX](#) [FYCC8E1-2](#)  
[9221350022](#) [922AA2W-A9P-L](#) [PLS2](#) [GL-12F-C2.5X10\(LOT3\)](#) [972AB2XM-A3N-L](#) [972AB3XM-A3P-L](#) [PS3251](#) [980659-1](#) [QT-12](#) [E2E2-](#)  
[X5M41-M4](#) [E2E-X14MD1-G](#) [E2E-X2D1-G](#) [E2EX2ME2N](#) [E2EX3D1SM1N](#) [E2E-X4MD1-G](#) [E2E-X5E1-5M-N](#) [E2E-X5Y2-N](#) [E2E-X7D1-](#)  
[M1J-T-0.3M-N](#) [E2K-F10MC1](#) [5M](#) [EH-302](#) [EI3010TBOP](#) [EI5515NPAP](#) [MS605AU](#) [EP175-32000](#) [IFRM04N35B1/L](#) [IFRM04P1513/S35L](#)  
[IFRM06P1703/S35L](#) [IFRM08P1501/S35L](#) [IFRM12N17G3/L](#) [IFRM12P17G3/L](#) [IFRM12P3502/L](#) [IFRM12P37G1/S14L](#) [ILFK12E9189/I02](#)  
[ILFK12E9193/I02](#) [IMM2582C](#) [OISN-013](#) [25.161.3253.0](#) [25.332.0653.1](#) [25.352.0653.0](#) [25.352.0753.0](#) [25.523.3253.0](#)