

Product availability: Stock - Normally stocked in distribution facility



Main

Range of product	Harmony XB5
Product or component type	Head for non-illuminated push-button
Device short name	ZB5
Bezel material	Dark grey plastic
Mounting diameter	0.87 in (22 mm)
Head type	Standard
Sale per indivisible quantity	1
Shape of signaling unit head	Round
Type of operator	Latching
Reset	Turn to release
Operator profile	Yellow mushroom Ø 40 mm unmarked

Complementary

CAD overall width	1.57 in (40 mm)
CAD overall height	1.57 in (40 mm)
CAD overall depth	2.24 in (57 mm)
Product weight	0.1 lb(US) (0.044 kg)
Mechanical durability	500000 cycles
Station name	XALD 1 cut-out XALK 1 cut-out
Electrical composition code	C15 1 contacts using single blocks in front mounting C11 3 contacts using single blocks in front mounting SF1 3 contacts using single blocks in front mounting C7 4 contacts using single blocks in front mounting C8 4 contacts using single and double blocks in front mounting C10 4 contacts using single and double blocks in front mounting SR1 3 contacts using single blocks in rear mounting

Environment

Protective treatment	TH
Ambient air temperature for storage	-40...158 °F (-40...70 °C)
Ambient air temperature for operation	-40...158 °F (-40...70 °C)
Overvoltage category	Class II conforming to IEC 60536
IP degree of protection	IP69 IP67 IP66 conforming to IEC 60529 IP69K
NEMA degree of protection	NEMA 13 NEMA 4X
Resistance to high pressure washer	1015.26 psi (7000000 Pa) at 131 °F (55 °C), distance: 0.1 m
IK degree of protection	IK03 conforming to IEC 50102
Standards	EN/IEC 60947-1 EN/IEC 60947-5-1 EN/IEC 60947-5-4 JIS C 4520 UL 508 CSA C22.2 No 14

Product certifications	BV CSA DNV GL LROS (Lloyds register of shipping) RINA UL listed
Shock resistance	30 gn (duration = 18 ms) half sine wave acceleration conforming to IEC 60068-2-27 50 gn (duration = 11 ms) half sine wave acceleration conforming to IEC 60068-2-27
Vibration resistance	5 gn (f = 2...500 Hz) conforming to IEC 60068-2-6

Ordering and shipping details

Category	22467 - PUSHBUTTONS,22MM(PLASTIC) NEW
Discount Schedule	CS2
GTIN	00785901387602
Nbr. of units in pkg.	1
Package weight(Lbs)	8.999999999999997E-2
Returnability	Y
Country of origin	CZ

Offer Sustainability

Sustainable offer status	Green Premium product
RoHS (date code: YYWW)	Compliant - since 0810 - Schneider Electric declaration of conformity Schneider Electric declaration of conformity
REACH	Reference not containing SVHC above the threshold
Product environmental profile	Available
Product end of life instructions	Need no specific recycling operations
California proposition 65	WARNING: This product can expose you to chemicals including:
----- Substance 1	Nickel compounds, which is known to the State of California to cause cancer, and
----- Substance 2	Di-isodecyl phthalate (DIDP), which is known to the State of California to cause birth defects or other reproductive harm.
----- More information	For more information go to www.p65warnings.ca.gov

Contractual warranty

Warranty period	18 months
-----------------	-----------

Dimensions

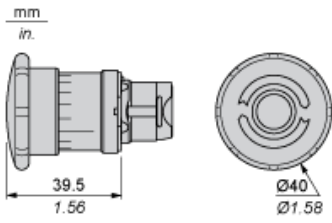

Panel Cut-out for Pushbuttons, Switches and Pilot Lights (Finished Holes, Ready for Installation)

Connection by Screw Clamp Terminals or Plug-in Connectors or on Printed Circuit Board

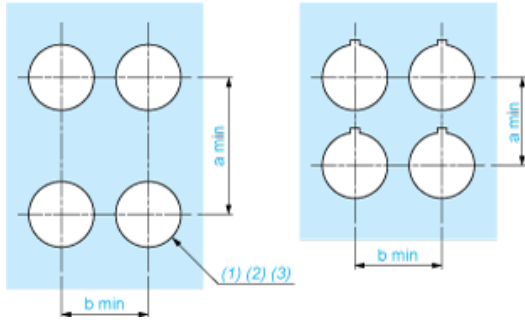

- (1) Diameter on finished panel or support
- (2) For selector switches and Emergency stop buttons, use of an anti-rotation plate type ZB5AZ902 is recommended.
- (3) $\varnothing 22.5$ mm recommended ($\varnothing 22.3 \text{ }_0^{+0.4}$) / $\varnothing 0.89$ in. recommended ($\varnothing 0.88 \text{ in. }_0^{+0.016}$)

Connections	a in mm	a in in.	b in mm	b in in.
By screw clamp terminals or plug-in connector	40	1.57	30	1.18
By Faston connectors	45	1.77	32	1.26
On printed circuit board	30	1.18	30	1.18

Detail of Lug Recess

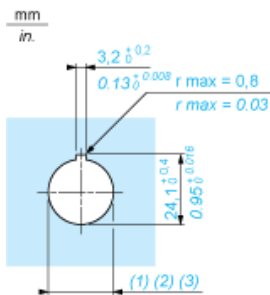

- (1) Diameter on finished panel or support
- (2) For selector switches and Emergency stop buttons, use of an anti-rotation plate type ZB5AZ902 is recommended.
- (3) $\varnothing 22.5$ mm recommended ($\varnothing 22.3 \text{ }_0^{+0.4}$) / $\varnothing 0.89$ in. recommended ($\varnothing 0.88 \text{ in. }_0^{+0.016}$)

Pushbuttons, Switches and Pilot Lights for Printed Circuit Board Connection

Panel Cut-outs (Viewed from Installer's Side)

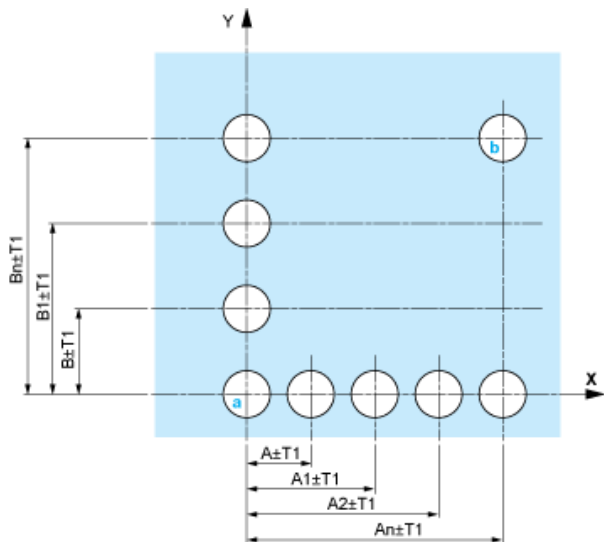

- A: 30 mm min. / 1.18 in. min.
- B: 40 mm min. / 1.57 in. min.

Printed Circuit Board Cut-outs (Viewed from Electrical Block Side)

Dimensions in mm

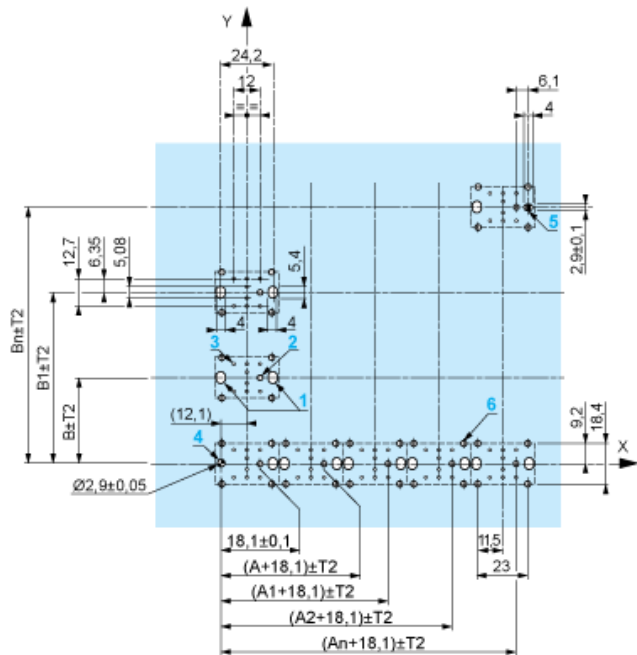

- A: 30 mm min.
- B: 40 mm min.

Mounting of Adapter (Socket) ZBZ01•

- 1 2 elongated holes for ZBZ006 screw access
- 2 1 hole \varnothing 2.4 mm \pm 0.05 / 0.09 in. \pm 0.002 for centring adapter ZBZ01•
- 3 8 \times \varnothing 1.2 mm / 0.05 in. holes
- 4 1 hole \varnothing 2.9 mm \pm 0.05 / 0.11 in. \pm 0.002, for aligning the printed circuit board (with cut-out marked a)
- 5 1 elongated hole for aligning the printed circuit board (with cut-out marked b)
- 6 4 holes \varnothing 2.4 mm / 0.09 in. for clipping in adapter ZBZ01•

Dimensions An + 18.1 relate to the \varnothing 2.4 mm \pm 0.05 / 0.09 in. \pm 0.002 holes for centring adapter ZBZ01•.

Electrical Composition Corresponding to Code C7



Electrical Compositions Corresponding to Code C8

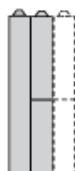

Electrical Compositions Corresponding to Code C10



Electrical Composition Corresponding to Codes C9, C11, SF1 and SR1



Electrical Composition Corresponding to Code C15

1 N/O

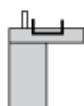

1 N/C

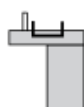

1 N/O + N/C or 1 N/O + N/O or 1 N/C + N/C

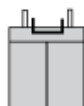

Legend

Single contact



Double contact



Light block



Possible location



X-ON Electronics

Largest Supplier of Electrical and Electronic Components

Click to view similar products for [Pushbutton Switches](#) category:

Click to view products by [Schneider](#) manufacturer:

Other Similar products are found below :

[LW1L-M1C10V-A](#) [LW2L-A1C20M-GD](#) [LW2L-M1C20M-A](#) [60324L](#) [M7E-HRN2](#) [67021K512](#) [67081K512X](#) [701PB580](#) [719-5504-000](#)
[MDPSSGLFS](#) [810KSV30B](#) [MML21KA3ABK](#) [MML23KA3AC05K-001](#) [MML23KW3AA01W](#) [8418K2](#) [8646AB6X718UL](#) [8646ABUL](#)
[FSDWH](#) [9001KXRK](#) [9001T8BK](#) [9533CD4+U574+U4922](#) [1203MRA](#) [A22EM01S](#) [A595](#) [1202A6](#) [12037A2ULCSA](#) [1203A2UL](#) [ABD122N-](#)
[B](#) [1211390004](#) [ABN111-Y](#) [ABN400-R](#) [1211500044](#) [1211580012](#) [1212MRA](#) [1232A6NF](#) [RA3CSH6A](#) [1241.1183.7047](#) [1241.2511](#)
[1241.3428](#) [1223A2ULCSA](#) [1223MRA](#) [1232AX2119](#) [1241.1183.8000](#) [1241.1183.8029](#) [1241.2506](#) [1241.2606](#) [12MA6](#) [1301940184](#)
[RELBARF6X10\(PLASTIC\)](#) [13435AG](#)