



SCHROFF

Project - 0 item(s)

MY PROJECT LIST

- PRODUCTS
- APPLICATIONS
- INDUSTRIES
- NEW PRODUCTS
- CONFIGURATORS
- Products ▾
- Search

Home > Mounting bracket for printed boards

Mounting bracket for printed boards

SCHROFF

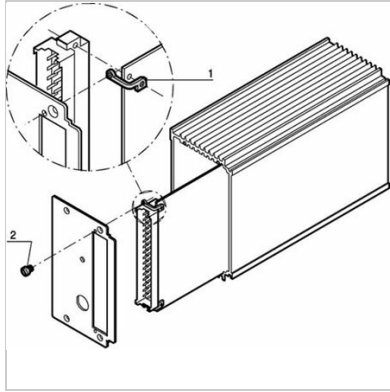

Catalog Number: 30809-700

[Back To Product](#)

- Please order mounting angle top and retention screws separately
- Mounting angle bottom for mounting 10 PCBs in HF plug-in unit

Description:

Individual components

Product family:

Frame Type Plug-In Units

Delivery Includes:

Kit

Other Views

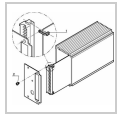

Select product specifications before modifying or adding to project list or requesting a quote.

[Clear Selection](#)

Quantity

Add Item to Project List +

Documents

User Manual for rear panel

Links

Native CAD files

Technical Data

Qty	1 piece (SPQ 10)
Delivery is exclusively made in Standard Pack Quantity (SPQ)	10
Item	1
Description	Mounting bracket, bottom
Description	Bracket (stainless steel), 1.5 mm; please order retention screws separately

Delivery Comprises:

Item	Quantity	Description
1	1	Bracket, stainless steel, 1.5 mm

Accessories

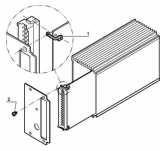

Mounting bracket for printed boards, top, St, 1.5 mm, 1 piece (SPQ 10) 30809-701

[Add Item to Project List +](#)

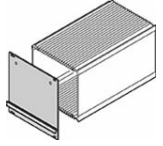

Mounting bracket for printed boards, top, St, 1.5 mm, 1 piece (SPQ 10) 20838-002

[Add Item to Project List +](#)



Mounting bracket for printed boards, top, St, 1.5 mm, 1 piece (SPQ 10) 20838-003

[Add Item to Project List +](#)

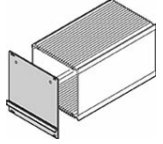

Mounting bracket for printed boards, top, St, 1.5 mm, 1 piece (SPQ 10) 20838-001

[Add Item to Project List +](#)



Mounting bracket for printed boards, top, St, 1.5 mm, 1 piece (SPQ 10) 20838-004

[Add Item to Project List +](#)



Mounting bracket for printed boards, top, St, 1.5 mm, 1 piece (SPQ 10) 20838-005

[Add Item to Project List +](#)

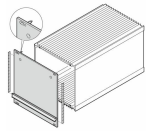

Mounting bracket for printed boards, top, St, 1.5 mm, 1 piece (SPQ 10) 20838-093

[Add Item to Project List +](#)



Mounting bracket for printed boards, top, St, 1.5 mm, 1 piece (SPQ 10) 20838-006

[Add Item to Project List +](#)

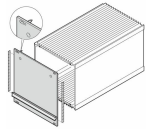

Mounting bracket for printed boards, top, St, 1.5 mm, 1 piece (SPQ 10) 20838-095

[Add Item to Project List +](#)

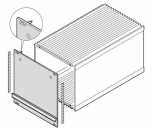

Mounting bracket for printed boards, top, St, 1.5 mm, 1 piece (SPQ 10) 20838-094

[Add Item to Project List +](#)

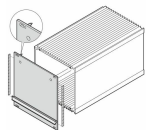

Mounting bracket for printed boards, top, St, 1.5 mm, 1 piece (SPQ 10) 20838-097

[Add Item to Project List +](#)

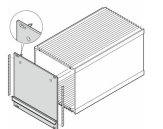

Mounting bracket for printed boards, top, St, 1.5 mm, 1 piece (SPQ 10) 20838-096

[Add Item to Project List +](#)

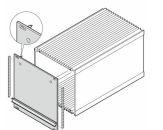

Mounting bracket for printed boards, top, St, 1.5 mm, 1 piece (SPQ 10) 20838-098

[Add Item to Project List +](#)

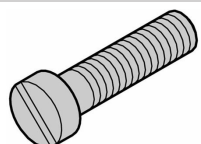

Cheesehead screw, M2.5 x 4, St, nickel-plated, PU 100 pieces 21100-431

[Add Item to Project List +](#)

EXPLORE

- [About Us](#)
- [Services & Capabilities](#)
- [News & Events](#)
- [Newsletter Subscriptions](#)
- [Strategic Partnerships](#)
- [Investor Relations](#)

CONTACT

- [Customer Service](#)
- [Find a Sales Office or Distributor](#)
- [Global Locations](#)
- [Product Compliance & Certifications](#)
- [Partner Login](#)

DOWNLOAD

- [Download Center](#)
- [Reference Projects](#)
- [Videos](#)
- [Product Configurators](#)
- [Warranties and Terms of Sale & Procurement](#)

© 2018 nVent. All rights reserved | [Privacy Policy](#) | [Terms of Use](#) | [Cookie Policy](#) | [Imprint](#) | [Site Map](#)

Connect With Us



X-ON Electronics

Largest Supplier of Electrical and Electronic Components

Click to view similar products for [Mounting Fixings](#) category:

Click to view products by [Schroff](#) manufacturer:

Other Similar products are found below :

[007310](#) [007541](#) [6-141-P](#) [620HA038NF09](#) [620HA038NF11](#) [71-074914-006](#) [71-146610-6H](#) [712HA170B23128-N](#) [75-69116-8S](#) [75-69211-3P](#)
[75-69224-28P](#) [75-69224-5S](#) [770-006A109](#) [770-006A109R](#) [770-006A207](#) [770-006A208W1](#) [770-006A209](#) [770-006A306](#) [770-006A703W1](#)
[770-006A704](#) [770-006A704W1](#) [770-006A705](#) [770-006A706](#) [770-006A706W1](#) [770-006A707](#) [770-006A709](#) [770-007A203](#) [770-007A203W1](#)
[770-007A204W1](#) [770-007A207W1](#) [770-007A703](#) [770-007A704W1](#) [770-007A706](#) [770-007A707W1](#) [770-010Y208](#) [770-010Y308](#) [770-](#)
[010Y705](#) [770-010Y706](#) [770-010Y707W1](#) [770-011T201](#) [770-011T203](#) [770-011T701W1](#) [770-011T702](#) [770-011T702W1](#) [770-011T703](#) [770-](#)
[013311](#) [770-013312](#) [770-013709](#) [770-013711](#) [770-013711W1](#)