



SCHROFF

Project - 0 item(s)

MY PROJECT LIST

- [PRODUCTS](#)
- [APPLICATIONS](#)
- [INDUSTRIES](#)
- [NEW PRODUCTS](#)
- [CONFIGURATORS](#)
- Products ▾
- Search
- 🔍

Home > Mounting bracket for printed boards



Mounting bracket for printed boards

SCHROFF

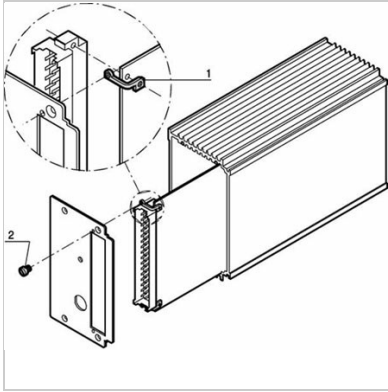

Catalog Number: 30809-701

[Back To Product](#)

- Please order mounting angle bottom and retention screws separately
- Mounting angle top for mounting 10 PCBs in HF plug-in unit

Description:

Fixing for PCBs

Product family:

Frame Type Plug-In Units

Delivery Includes:

Kit



Select product specifications before modifying or adding to project list or requesting a quote.

[Clear Selection](#)

Quantity

Add Item to Project List +

Documents

[User Manual for rear panel](#)

Links

[Native CAD files](#)

Technical Data

Qty	1 piece (SPQ 10)
Delivery is exclusively made in Standard Pack Quantity (SPQ)	10
Item	1
Description	bracket (stainless steel), 1.5 mm; please order retention screws separately

Delivery Comprises:







Item	Quantity	Description
1	1	Bracket, stainless steel, 1.5 mm

Accessories

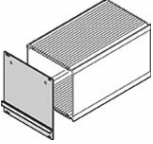
Mounting bracket for printed boards, bottom, St, 1.5 mm, 1 piece (SPQ 10)

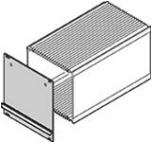
30809-700

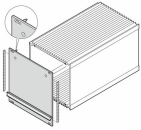
Add Item to Project List +

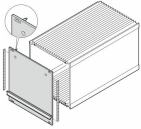
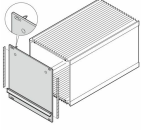
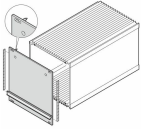
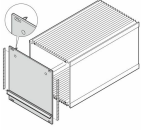
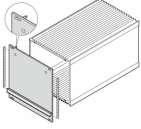
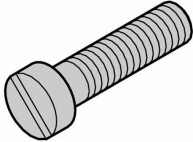
	Mounting bracket for printed boards, bottom, St, 1.5 mm, 1 piece (SPQ 10)	20838-002	Add Item to Project List +
	Mounting bracket for printed boards, bottom, St, 1.5 mm, 1 piece (SPQ 10)	20838-003	Add Item to Project List +
	Mounting bracket for printed boards, bottom, St, 1.5 mm, 1 piece (SPQ 10)	20838-001	Add Item to Project List +
	Mounting bracket for printed boards, bottom, St, 1.5 mm, 1 piece (SPQ 10)	20838-004	Add Item to Project List +
	Mounting bracket for printed boards, bottom, St, 1.5 mm, 1 piece (SPQ 10)	20838-005	Add Item to Project List +
	Mounting bracket for printed boards, bottom, St, 1.5 mm, 1 piece (SPQ 10)	20838-093	Add Item to Project List +
	Mounting bracket for printed boards, bottom, St, 1.5 mm, 1 piece (SPQ 10)	20838-006	Add Item to Project List +
	Mounting bracket for printed boards, bottom, St, 1.5 mm, 1 piece (SPQ 10)	20838-095	Add Item to Project List +
	Mounting bracket for printed boards, bottom, St, 1.5 mm, 1 piece (SPQ 10)	20838-094	Add Item to Project List +
	Mounting bracket for printed boards, bottom, St, 1.5 mm, 1 piece (SPQ 10)	20838-097	Add Item to Project List +
	Mounting bracket for printed boards, bottom, St, 1.5 mm, 1 piece (SPQ 10)	20838-096	Add Item to Project List +
	Mounting bracket for printed boards, bottom, St, 1.5 mm, 1 piece (SPQ 10)	20838-098	Add Item to Project List +
	Cheesehead screw, M2.5 x 4, St, nickel-plated, PU 100 pieces	21100-431	Add Item to Project List +

EXPLORE

[About Us](#)
[Services & Capabilities](#)
[News & Events](#)
[Newsletter Subscriptions](#)

CONTACT

[Customer Service](#)
[Find a Sales Office or Distributor](#)
[Global Locations](#)
[Product Compliance & Certifications](#)

DOWNLOAD

[Download Center](#)
[Reference Projects](#)
[Videos](#)
[Product Configurators](#)

Connect With Us



X-ON Electronics

Largest Supplier of Electrical and Electronic Components

Click to view similar products for [Mounting Fixings](#) category:

Click to view products by [Schroff](#) manufacturer:

Other Similar products are found below :

[007310](#) [007541](#) [6-141-P](#) [620HA038NF09](#) [620HA038NF11](#) [71-074914-006](#) [71-146610-6H](#) [712HA170B23128-N](#) [75-69116-8S](#) [75-69211-3P](#)
[75-69224-28P](#) [75-69224-5S](#) [770-006A109](#) [770-006A109R](#) [770-006A207](#) [770-006A208W1](#) [770-006A209](#) [770-006A306](#) [770-006A703W1](#)
[770-006A704](#) [770-006A704W1](#) [770-006A705](#) [770-006A706](#) [770-006A706W1](#) [770-006A707](#) [770-006A709](#) [770-007A203](#) [770-007A203W1](#)
[770-007A204W1](#) [770-007A207W1](#) [770-007A703](#) [770-007A704W1](#) [770-007A706](#) [770-007A707W1](#) [770-010Y208](#) [770-010Y308](#) [770-](#)
[010Y705](#) [770-010Y706](#) [770-010Y707W1](#) [770-011T201](#) [770-011T203](#) [770-011T701W1](#) [770-011T702](#) [770-011T702W1](#) [770-011T703](#) [770-](#)
[013311](#) [770-013312](#) [770-013709](#) [770-013711](#) [770-013711W1](#)